

PEL-3000AH



## Assembly Guide

This assembly manual contains proprietary information, which is protected by copyrights. All rights are reserved. No part of this manual may be photocopied, reproduced or translated to another language without prior written consent of Good Will company.

The information in this manual was correct at the time of printing. However, Good Will continues to improve products and reserves the rights to change specification, equipment, and maintenance procedures at any time without notice.

Good Will Instrument Co., Ltd.  
No. 7-1, Jhongsing Rd., Tucheng Dist., New Taipei City 236, Taiwan.



ISO-9001 CERTIFIED MANUFACTURER

**GW INSTEK**



# INTRODUCTION

**Description** PEL-3000AH Parallel to 9KW contains the parts below  
(i.e., PEL-3955AH with outline Rack)

<b>Contents</b>	<b>Model Name</b>	<b>Part Number</b>	<b>Quantity</b>	<b>Description</b>
	PEL-3111AH	01EL311AH0GT	1	1KW LOAD Master
	PEL-3211AH	01EL321AH0GT	4	2KW LOAD Booster

**Description** Connection & Structure Accessory

<b>Contents</b>	<b>Model Name</b>	<b>Part Number</b>	<b>Quantity</b>	<b>Description</b>
	PEL-005	11EL-00500101	1	Bus Bar Connector
	PEL-006	11EL-00600101	1	Bus Bar Connector (Included PEL-005)
	PEL-007	11EL-00700101	1	Bus Bar Connector (Included PEL-005)
	PEL-008	11EL-00800101	1	Bus Bar Connector (Included PEL-005)
	PEL-009	11EL-00900101	1	Bus Bar Connector (Included PEL-005)
	GRA-413-E	01RA413E000T	4	PEL-3111 3U Frame (Optional)
	GRA-414-E	01RA414E000T	1	PEL-3111 3U Frame (Optional)

 **Note** Refer to the PEL-3000AH Series Rack Parts details\_EN.doc for the other models.

**Final Assemble Result**

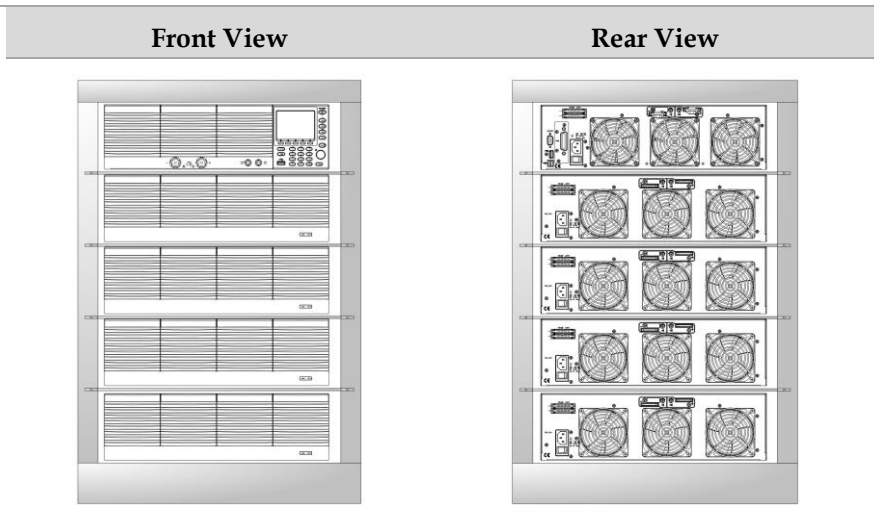



**Note**

It is highly recommended to install the isolated of vent door on the back.

Isolated ventilation door

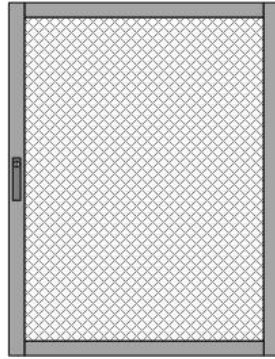

Rear View with Isolated ventilation door

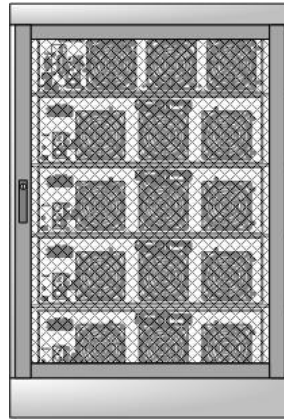

# ASSEMBLE PROCEDURE

Step 1

Put the 1st PEL-3211AH on the bottom of the rack followed by fastening the 4 screws for side bracket in the front but not tightening them completely.

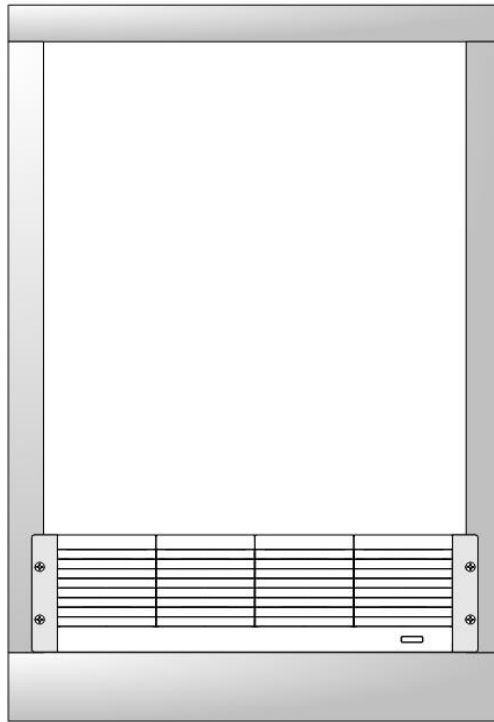

Step 2

Screw the L-shape brackets in the interior side of rack. An approx. 1mm distance between the bottom of brackets and the top of PEL-3211AH is required.

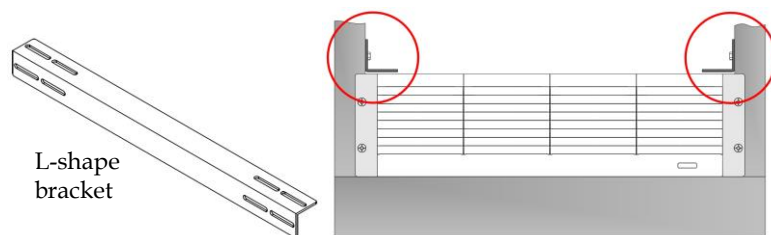

L-shape bracket

The L-shape brackets screwed on the interior side of rack

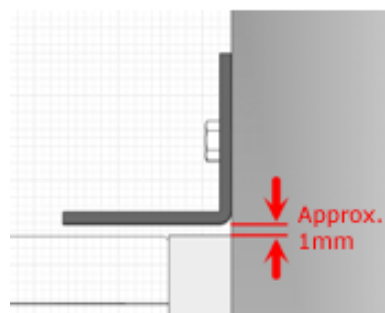

Approx. 1mm between bracket and the top of unit

**Step 3**

Put the 2nd PEL-3211AH onto the L-shape brackets within the rack and, again, fasten the 4 screws for side bracket in the front but not tighten them fully followed by screwing another group of L-shape brackets within the interior of rack.

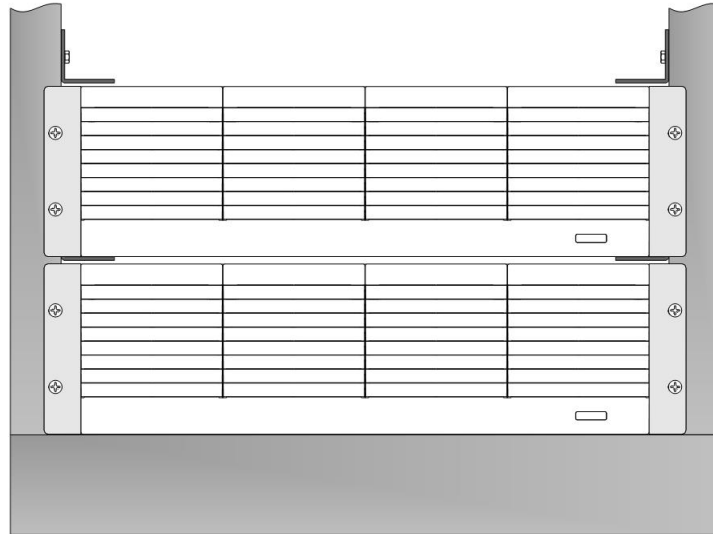

2nd unit installation completion

**Step 4**

Repeat the previous steps in order to install the rest of PEL-3211AHs and further install the bracket (GRA-414-3) of PEL-3111AH on the upper side followed by installing the PEL-3111AH onto the top of the bracket.

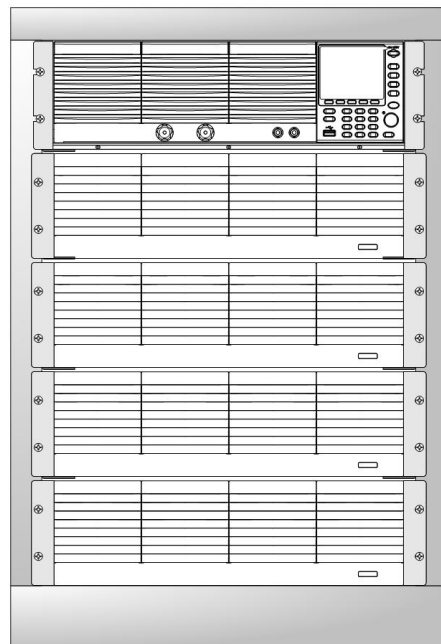

Assembly completion for 5 units

# COPPER STICK ASSEMBLY

**Step 1**

Assemble the L-type copper stick (PEL-005) onto the output terminal in the rear side of each unit as the figure below shown.

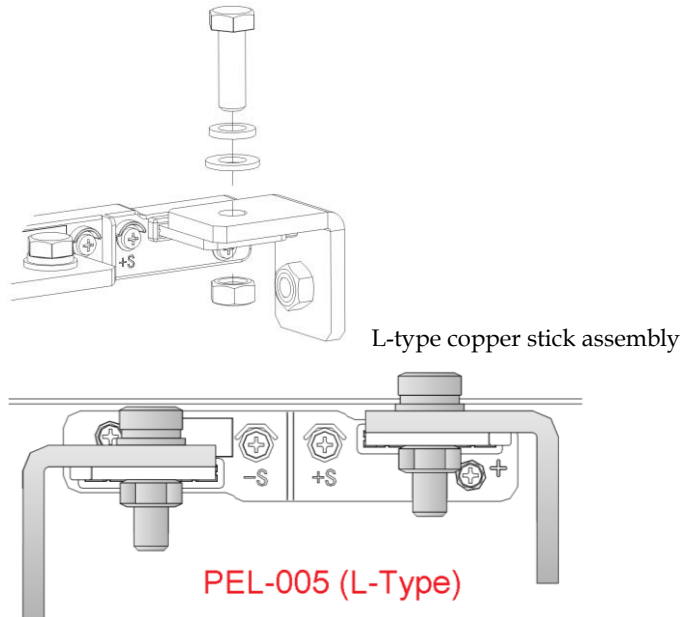

L-type copper sticks assembly completion

**Step 2**

In accordance with the figure below, assemble the copper sticks for unit conjunction followed by fastening the screws in the front of rack tightly.

Copper sticks assembly diagram

Diagram of rear side for copper sticks assembly

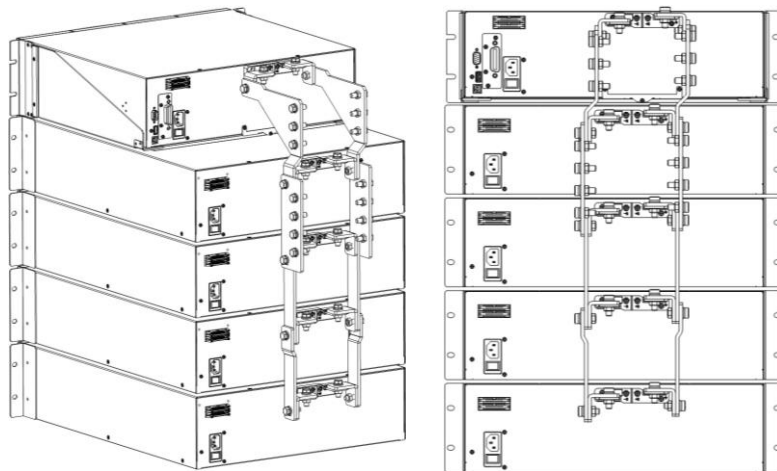

# P PARALLEL CABLES INSTALLATION

Step 1

Install the parallel cables in accord with the following figure.

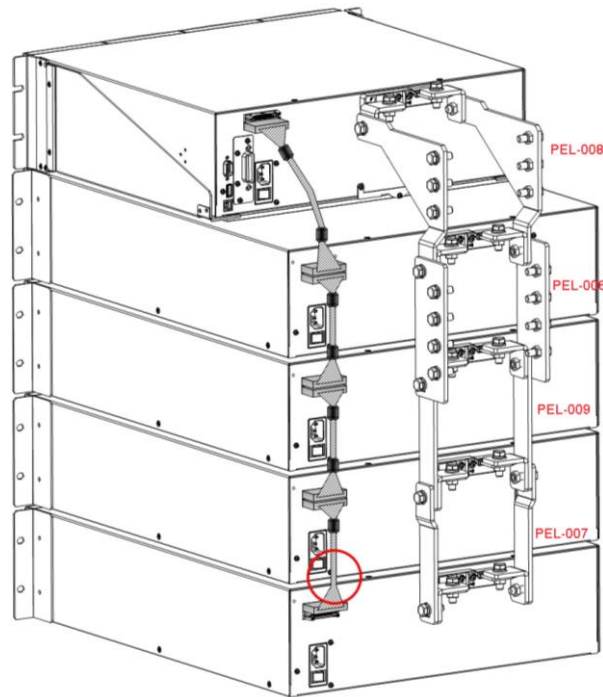

 Note

The last cable connecting to the last unit cannot be clipped with core. When only one PEL-3111AH connects to a PEL-3211AH (Booster) in parallel, the cable in the Booster end cannot be clipped with core.



# C ONNECT TO AC POWER CORD

## Step 1

Refer to the figure below; connect the AC power cords for all units to the power sockets in the rear side individually followed by powering on the power switch that is underneath the power socket (– indicates power ON).

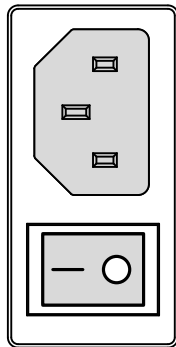

## Step 2

Attentively check if the indicator in the front panel of all units lights up with red color:

- I. Master indicator lights up as the figure below:



- II. Booster indicator lights up as the figure below (STBY indicator lights up):



# S SYSTEM IN SERIAL SETTING

**Step 1** Power on the power switch in the Master front panel and the indicator lights up in green as figure below shown:



**Step 2** The master will automatically detect the number of Boosters connected in parallel. Please restart the system by turning off and on the power switch of the electronic load.

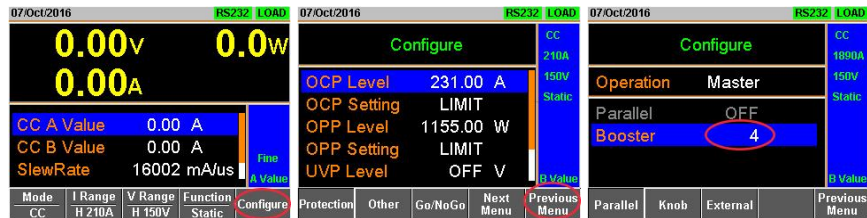

**Note** Select Booster number corresponding to the actual Booster number in parallel.

**Step 3** Properly confirm if the indicator in the front panel of all PEL-3211AH (Booster) lights up with LINK in green, which means the software setting connects to Booster appropriately. Refer to the figure below.



# CURRENT SINK CURRENT

## DIVISION CHECKUP

Description	<p>The current sink power of PEL-3111AH and PEL-3211AH is 1KW:2KW; therefore, the ratio of current sink will always be the exactly 1:2.</p> <p>E.g., PEL-3322AH (3KW); when current sink is set 30A, Master (PEL-3111AH) will sink current by 10A, whilst Booster (PEL-3211AH) will sink current by 20A.</p> <p>E.g., PEL-3955AH (9KW); when current sink is set 90A, Master (PEL-3111AH) will sink current by 10A, whilst the rest of the 4 Booster (PEL-3211AH) will sink current by 20A individually.</p>
Step 1	First dismantle all of the positive parallel copper sticks and parallel cables in the rear output terminal of unit.
Step 2	<p>Check the 1st Booster current:</p> <ol style="list-style-type: none"> <li>I. Connect the parallel cable to the J2 connector in the rear of PEL-3111AH in one end and the J1 connector in the rear of PEL-3211AH in the other end.</li> <li>II. Power on both PEL-3111AH and the 1st PEL-3211AH, while keep the rest units power-off. Set the unit PEL-3111AH as the parallel mode via the following procedure:</li> <li>III. Based on the connection method in the figure below, connect current sink cable to the unit followed by setting current sink value for unit. Measure the currents from both the current sink cable of Master positive pole and the current sink cable of Booster positive pole, via current probe, to validate the accuracy of currents. The measured current value of Master is supposed to be 1/3 of the set value, whereas the measured current value of Booster should be 2/3 of the set value.</li> </ol>

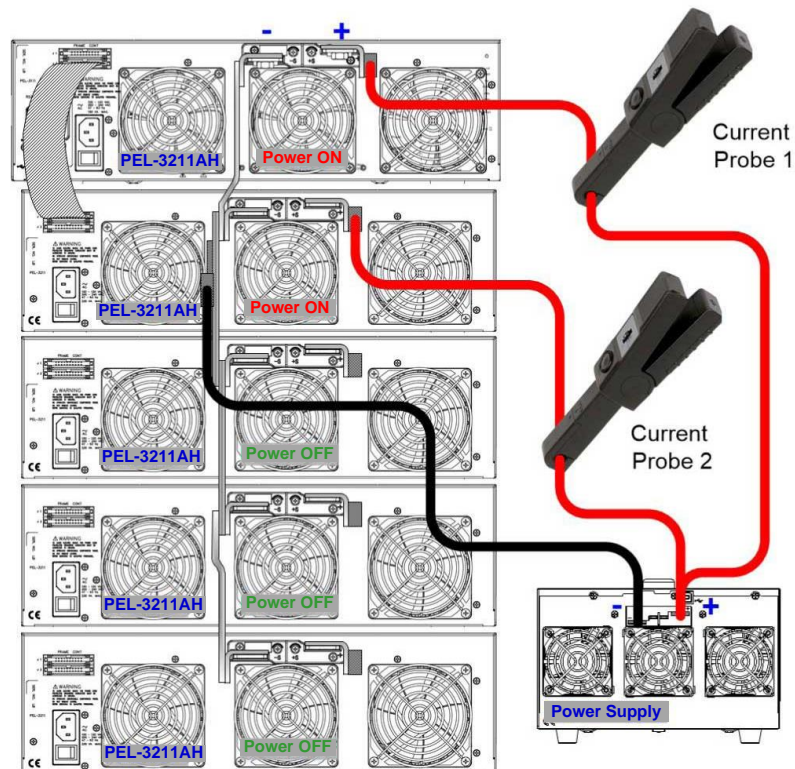

### Step 3

The 2nd Booster current checkup:

- I. Connect the parallel cable to the J2 connector in the rear of PEL-3111H in one end and the J1 connector in the rear of PEL-3211H in the other end.
- II. Power on both PEL-3111AH and the 2nd PEL-3211AH, while keep the rest units power-off. Set the unit PEL-3111AH as the parallel mode. The setting procedure is identical to the setting of the 1st PEL-3211AH validation.
- III. Based on the connection method in the figure below, connect current sink cable to the unit followed by setting current sink value for unit. Measure the currents from both the current sink cable of Master positive pole and the current sink cable of Booster positive pole, via current probe, to validate the accuracy of currents. The measured current value of Master is supposed to be  $1/3$  of the set value, whereas the measured current value of Booster should be  $2/3$  of the set value.

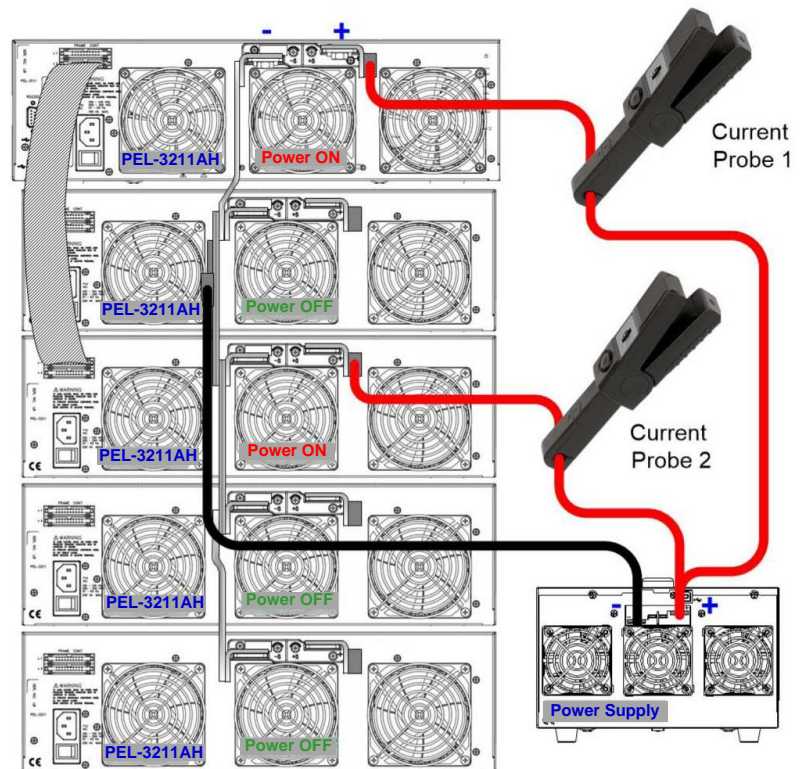

- Step 4 Follow the previous steps to validate the 3rd and the 4th Booster respectively.
- Step 5 The assembly procedure and system setting are completely finished. Press **Main** to return back to the main screen and the current sink test is properly ready to initiate.
-