

DC Electronic Load Booster

PEL-3211A(H)

QUICK START GUIDE

GW INSTEK PART NO. 82EL-3211AM01



ISO-9001 CERTIFIED MANUFACTURER

GW INSTEK

This manual contains proprietary information, which is protected by copyright. All rights are reserved. No part of this manual may be photocopied, reproduced or translated to another language without prior written consent of Good Will Corporation.

The information in this manual was correct at the time of printing. However, Good Will continues to improve its products and therefore reserves the right to change the specifications, equipment, and maintenance procedures at any time without notice.

Good Will Instrument Co., Ltd. No. 7-1, Jhongsing Rd., Tucheng Dist., New Taipei City 236, Taiwan.

S SAFETY INSTRUCTIONS

This section contains the basic safety symbols that may appear on the accompanying User Manual CD or on the instrument. For detailed safety instructions and precautions, please see the Safety Instructions chapter in the user manual CD.

Safety Symbols

These safety symbols may appear in the user manual or on the instrument.



Warning

Warning: Identifies conditions or practices that could result in injury or loss of life.



Caution

Caution: Identifies conditions or practices that could result in damage to the instrument or to other properties.



DANGER High Voltage



Attention Refer to the Manual



Protective Conductor Terminal



Earth (ground) Terminal



Do not dispose electronic equipment as unsorted municipal waste. Please use a separate collection facility or contact the supplier from which this instrument was purchased.

Power Cord for the United Kingdom

When using the instrument in the United Kingdom, make sure the power cord meets the following safety instructions.

NOTE: This lead/appliance must only be wired by competent persons.



WARNING: THIS APPLIANCE MUST BE EARTHED
IMPORTANT: The wires in this lead are coloured in accordance with the following code:

Green/ Yellow: Earth
Blue: Neutral
Brown: Live (Phase)



As the colours of the wires in main leads may not correspond with the coloured marking identified in your plug/appliance, proceed as follows:

The wire which is coloured Green & Yellow must be connected to the Earth terminal marked with either the letter E, the earth symbol  or coloured Green/Green & Yellow.

The wire which is coloured Blue must be connected to the terminal which is marked with the letter N or coloured Blue or Black.

The wire which is coloured Brown must be connected to the terminal marked with the letter L or P or coloured Brown or Red.

If in doubt, consult the instructions provided with the equipment or contact the supplier.

This cable/appliance should be protected by a suitably rated and approved HBC mains fuse: refer to the rating information on the equipment and/or user instructions for details. As a guide, a cable of 0.75mm² should be protected by a 3A or 5A fuse. Larger conductors would normally require 13A types, depending on the connection method used.

Any exposed wiring from a cable, plug or connection that is engaged in a live socket is extremely hazardous. If a cable or plug is deemed hazardous, turn off the mains power and remove the cable, any fuses and fuse assemblies. All hazardous wiring must be immediately destroyed and replaced in accordance to the above standard.

GETTING STARTED

The Getting started chapter introduces the instrument's main features, appearance, and set up procedure.

Overview

The PEL-3211A(H) Booster is designed to be used with the PEL-3111(H) Electronic Load for parallel load applications to increase the current sinking capacity. Up to 4 booster packs can be connected as slave units to a PEL-3111(H), which acts as the master unit.

Booster Capacity, PEL-3211A

The table below shows the total current and power by the number of boosters connected to master unit.

# of Boosters	Total Current: Boosters + Master (PEL-3211A+PEL-3111A)	Total Power: Boosters + Master (PEL-3211A+PEL-3111A)
1	630A(420A+210A)	3150W (2100W+1050W)
2	1050A(840A+210A)	5250W (4200W+1050W)
3	1470A(1260A+210A)	7350W (6300W+1050W)
4	1890A(1680A+210A)	9450W (8400W+1050W)

- Features
- Up to 4 booster packs can be used in parallel with a PEL-3111A master unit.
 - All booster packs are controlled via a master unit.

Booster Capacity, PEL-3211AH

The table below shows the total current and power by the number of boosters connected to master unit.

# of Boosters	Total Current: Boosters + Master (PEL-3211AH+PEL-3111AH)	Total Power: Boosters + Master (PEL-3211AH+PEL-3111AH)
1	157.5A(105A+52.5A)	3150W(2100W+1050W)
2	262.5A(210A+52.5A)	5250W(4200W+1050W)
3	367.5A(315A+52.5A)	7350W(6300W+1050W)
4	472.5A(420A+52.5A)	9450W(8400W+1050W)

- Features
- Up to 4 booster packs can be used in parallel with a PEL-3111AH master unit.
 - All booster packs are controlled via a master unit.

Package Contents and Accessories

Standard Accessories

Item	Part Number
Quick Start Guide (this document)	
Load input terminal Cover, M3 screw x1	PEL-011
Terminal fittings: 2 sets of bolts/nuts/springs/washers (type: M8), terminal cover x1 (for PEL-3000AH series only), monitor out cover x 1(for PEL-3021AH, PEL-3041AH, PEL-3111AH only)	PEL-012
Flexible terminal cover: 2x rubber sheeting, 4x Velcro fasteners.(for PEL-3211A(H) only)	PEL-013
J1/J2 Protection plug x2 (It is installed on the device)	PEL-014
300mm frame link cable (for vertically stacked units)	GTL-255
Power Cord x1	Region Dependent

Optional Accessories

Item	Part Number
Rack mount bracket for booster PEL-3211A(H) (EIA+JIS)	GRA-413
Dust filter	PEL-010

Front Panel

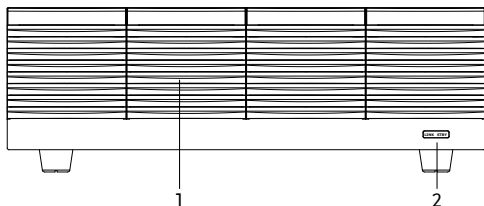

Description

1. Air inlet
2. LINK/STBY indicators

Rear Panel

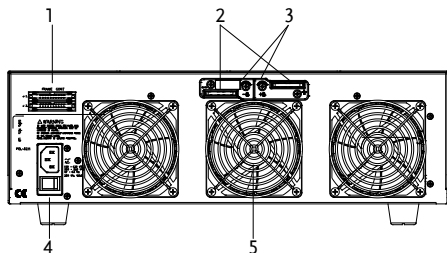

Description

1. Frame control ports, J1, J2
2. Rear panel input terminals
3. Remote sense terminals
4. Power socket and switch
5. Exhaust fan

Setting up the Booster Pack

This section describes how to set up the booster pack properly including turning the unit on, choosing the correct wire gauge, and connection details.

Power Up

The PEL-3211A(H) has a STBY indicator on the front panel to indicate when the power is on.

1. Insert the AC power cord into the power socket.
2. Turn the power switch on from the rear panel.
(O → —)

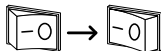

3. The STBY indicator will turn red when the power is on.

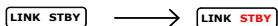

Load Wiring

Before connecting the booster packs to a DUT, the wire gauge must be taken into account. Load wires must be large enough to resist overheating when a short-circuit condition occurs as well as to maintain a good regulation. The size, polarity and length of a wire are all factors in determining if a wire will withstand short circuiting.

Wires that are selected must be large enough to withstand a short circuit and limit voltage drops to no more than 2V per wire. Use the following table to help make a suitable selection.

AWG Gauge	Conduct or Diameter mm	Ohms per km	Max amps for chassis wiring
0000	11.684	0.16072	380
000	10.4038	0.2027	328
00	9.26592	0.25551	283
0	8.25246	0.32242	245
1	7.34822	0.40639	211
2	6.54304	0.51266	181
3	5.82676	0.64616	158
4	5.18922	0.81508	135
5	4.62026	1.02762	118
6	4.1148	1.29593	101
7	3.66522	1.6341	89
8	3.2639	2.0605	73
9	2.90576	2.59809	64
10	2.58826	3.27639	55
11	2.30378	4.1328	47
12	2.05232	5.20864	41
13	1.8288	6.56984	35
14	1.62814	8.282	32

Load Line Inductance Considerations

When using the booster packs, voltage drop and voltage generated due to load line inductance and current change must be taken into account. Extreme changes in voltage may exceed the minimum or maximum voltage limits. Exceeding the maximum voltage limit may damage the booster(s).

Load line inductance can be reduced in two ways.

1. Ensure load wires are as short as possible and twist the positive and negative load wires together.
2. Current change can be limited by limiting the slew rate or response speed when switching in CR and CC mode.

Using the Rear Panel Terminals

The rear panel input terminals accept up to M8-sized crimped terminals. The rear terminals come with a load input terminal cover for safety.

1. Turn the power off from the rear panel.
2. Turn the power off from the DUT.
3. Connect the load wires to the input terminals:
 - Connect the positive (+) input terminal on the load generator to the high potential output of the DUT.
 - Connect the negative (-) input terminal to the low potential output of the DUT.

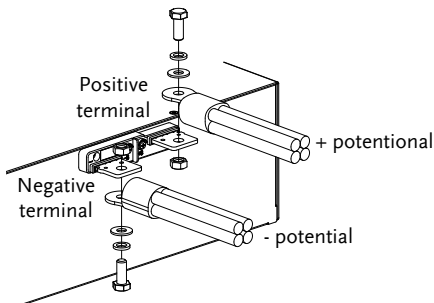

Using the Terminal Cover (PEL-011)

The rear panel terminal cover should be used to prevent electric shock. The rear panel terminal covers should always be used when connecting a load to the rear panel terminals.



Warning Ensure the power is off before making any connections to the booster pack.

1. Remove the screw holding the top cover to the bottom cover.

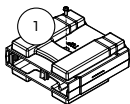

2. Line-up the bottom cover with the notches in the output terminals.
3. Place the top terminal cover over the bottom cover.

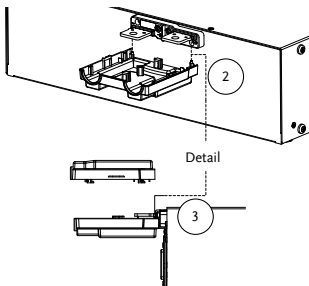

4. Use your thumb to slide the terminal covers shut.
5. When the top and bottom covers are flush, reinsert the screw that was removed in step 1.

Using the Terminal Cover (PEL-013)

The rear panel terminal cover should be used to prevent electric shock. The rear panel terminal covers should always be used when connecting a load to the rear panel terminals. The flexible rear panel terminal cover should be used when the load wiring becomes too thick to be used with the PEL-012 terminal cover. This is especially true when using the load generators in parallel.



Warning

Ensure the power is off before making any connections to the booster pack.

1. Wrap the insulation sheets around the terminals and load cables, as shown below. Make sure the terminals and any exposed wires are covered by the sheets.

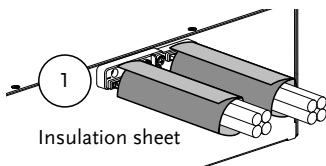

2. Secure the insulation sheets using the supplied velcro fasteners. 2 fasteners should be used for each sheet.

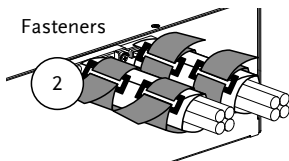

Connection

The PEL-3111A(H) can control up to 4 PEL-3211A(H) booster units in parallel. Excluding the master unit, other PEL-3000A(H) units cannot be used in parallel with the booster packs.

Master unit settings for response rate, response speed and so on will be adopted by any connected booster packs.



Note

Follow the procedures below for all connections. Please adhere to the following precautions to ensure your safety and to protect the unit from damage.



Caution

If the polarity to the input terminals is reversed, the reverse voltage protection function is tripped. The reverse voltage protection function is tripped when reverse voltages greater than -0.3V are detected.

Ensure that the maximum input voltage is not exceeded. The maximum input voltage is 150 volts.



Warning

Do not touch any of the input terminals when the unit is on.

Connecting the input terminals to the wrong polarity can damage the DUT or the booster packs/master unit.

Frame Link Connections

The J1 and J2 connectors on the rear panel are used to control the booster packs for parallel operation. The GTL-255 frame link cable is used to connect the J1 and J2 connectors. The GTL-255 frame link cable is used for units that are stacked vertically.



Note

Ensure that the frame link cables are separated from the load cables as much as possible for stable operation.

1. Make sure the master unit and booster packs are turned off.
2. Make sure the DUT is turned off.
3. Connect the Master unit to the booster packs via the J1/J2 connectors.
 - Use the GTL-255 frame link cable.
 - Connect from:
Master J2 to Slave1 J1
Slave1 J2 to Slave2 J1 and so on.
 - Remove the ferrite core that is attached to the J1 connector-side of the last frame link cable. See the connection diagram for details.

Load Wire Connections

Only the rear terminals on the master can be used for parallel connections.

Make sure all connections are correct before turning on the load. Incorrect connections could damage the units.

The booster packs should not be used in combination with other PEL-3000A(H) units as slaves other than the PEL-3111A(H) acting as the master.

1. Make sure the master unit and booster packs are turned off.
2. Make sure the DUT is turned off.
3. Connect the load units to the DUT.
 - Ensure the wire gauge is sufficient to handle the increase in current.
 - Connect the rear negative terminals on the booster(s) and master unit to the negative potential of the DUT.
 - Connect the rear positive terminals on the booster(s) and master unit to the positive potential on the DUT.
 - If possible use the shortest cable length possible.
 - If possible, twist the load cable together to reduce load line inductance.
 - Try to use cables of equal length.
 - Do not coil or loop the load cables.

Remote Sense Connections

Remote sense can be used to help compensate for long cable length. The longer the cable, the higher the potential resistance and inductance, therefore a short cable is best. Twisting the cable can help reduce induced inductance and using the Vsense terminals compensates the voltage drop seen across the load leads, especially leads with higher resistance. This is useful when used in CV, CR or CP mode.

1. Make sure the master unit and booster packs are turned off.
2. Make sure the DUT is turned off.

3. Connect the sense cables from the DUT to the master unit.
- Connect a sense cable from the positive sense terminal to the positive potential of the DUT.
 - Connect a sense cable from the negative sense terminal to negative potential on the DUT.
 - Do not connect the sense cables to the booster packs.

Connection Diagram

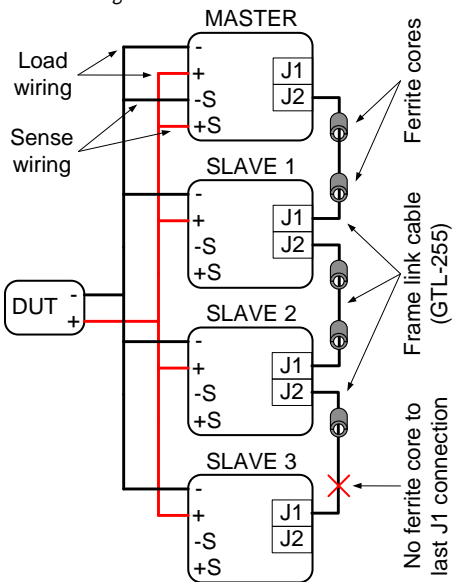

OPERATION

Configuration

When using the booster packs all the basic settings are adopted from the master unit.

1. Ensure the master unit, booster packs and DUT are connected in parallel.
2. Turn the booster packs and master unit on.
3. On the master unit, press **Main** > *Configure*[F5] > *Next Menu* [F4] > *Parallel* [F1].
4. Set the unit to *Master* with the *Operation* setting.
5. Assign the number of attached booster units with the *Booster* settings.
 - A maximum of 4 booster units can be used in parallel.

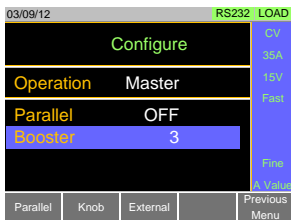

6. The electronic loads are now ready for operation.

Turning the Load On

1. Turn the slave and master units on.
2. Set the operation mode and settings on the master units.
 - The master's settings will be used by the booster packs.
3. Turn the load on from the Master unit.
 - All measurements will be displayed on the Master unit.
4. The LINK indicator on the front panel will turn green when the load is on and the booster units are connected.

SPECIFICATIONS

Operating Area

PEL-3211A Booster Pack

PEL-3211 High Range Chart

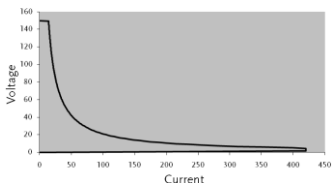

PEL-3211AH Booster Pack

High Range Chart

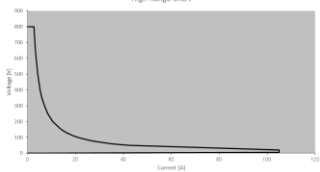

Middle Range Chart

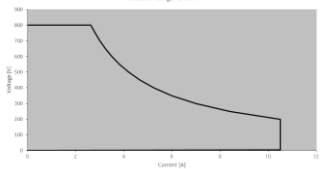

Low Range Chart

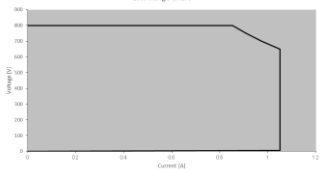

PEL-3211A(H) Specifications

Rating

Voltage	0V-150V (0V-800V)
Current	420A(105A)
Min. Operating Voltage	1.5V at 420A(5V at 105A)
Power	2100W
Current Setting Accuracy	$\pm(1.2\%$ of set + 1.1% of f.s.)

M range applies to the full scale of H range



Note

PEL-3211A only has H or M current ranges.

General

Inrush Current	45A Max
Insulation Resistance	Primary to input terminal or Primary to chassis: 500(1000) VDC, 20M Ω or more.
Withstand Voltage	Primary to input terminal or Primary to chassis: No abnormalities at 1500 VAC for 1 minute.
Dimensions(mm)	427.7(W)x127.8(H)x553.5(D)
Weight	Approx. 23kg(28kg)

Certificate Of Compliance

We

GOOD WILL INSTRUMENT CO., LTD.

declare that the CE marking mentioned product satisfies all the technical relations application to the product within the scope of council:

Directive: EMC; LVD; WEEE; RoHS

The product is in conformity with the following standards or other normative documents:

◎ EMC

EN 61326-1	Electrical equipment for measurement, control and laboratory use -- EMC requirements
Conducted & Radiated Emission EN 55011 / EN 55032	Electrical Fast Transients EN 61000-4-4
Current Harmonics EN 61000-3-2 / EN 61000-3-12	Surge Immunity EN 61000-4-5
Voltage Fluctuations EN 61000-3-3 / EN 61000-3-11	Conducted Susceptibility EN 61000-4-6
Electrostatic Discharge EN 61000-4-2	Power Frequency Magnetic Field EN 61000-4-8
Radiated Immunity EN 61000-4-3	Voltage Dip/ Interruption EN 61000-4-11 / EN 61000-4-34

◎ Safety

EN 61010-1 :	Safety requirements for electrical equipment for measurement, control, and laboratory use - Part 1: General requirements
--------------	--

GOOD WILL INSTRUMENT CO., LTD.

No. 7-1, Jhongsing Road, Tucheng Dist., New Taipei City 236,
Taiwan

Tel: +886-2-2268-0389

Fax: +866-2-2268-0639

Web: www.gwinstek.com

Email: marketing@goodwill.com.tw

GOOD WILL INSTRUMENT (SUZHOU) CO., LTD.

No. 521, Zhujiang Road, Snd, Suzhou Jiangsu 215011, China

Tel: +86-512-6661-7177

Fax: +86-512-6661-7277

Web: www.instek.com.cn

Email: marketing@instek.com.cn

GOOD WILL INSTRUMENT EURO B.V.

De Run 5427A, 5504DG Veldhoven, The Netherlands

Tel: +31(0)40-2557790

Fax: +31(0)40-2541194

Email: sales@gw-instek.eu