

Programmable High Precision Dual Output DC Power Supply

PPH-1503D/PPH-1506D/ PPH-1510D

User Manual

GW INSTEK PART NO. 82PH-1503DED1



ISO-9001 CERTIFIED MANUFACTURER

GW INSTEK

Copyright Statement

This manual contains proprietary information, which is protected by copyright. All rights are reserved. No part of this manual may be photocopied, reproduced or translated to another language without prior written consent of Good Will company.

The information in this manual was correct at the time of printing. However, Good Will continues to improve products and reserves the rights to change specification, equipment, and maintenance procedures at any time without notice.

Table of Contents

SAFETY INSTRUCTIONS	5
OVERVIEW	10
Introduction	10
Key Features	12
Operating Principals	14
Front Panel.....	16
Rear Panel.....	22
Constant Voltage/Constant Current Crossover Characteristics	24
GETTING STARTED	25
Start Up.....	25
Load and DVM Connection.....	26
Turning the Output On/Off	28
MAIN MENU OVERVIEW	29
Function Description	30
BASIC OPERATION	32
Source Function	32
DVM.....	43
Pulse Current Measurement	45
Long integration.....	51
Battery simulation function	56
Current Sink Function.....	57
External Relay Control	59
Sequence Function	62
SAVE/RECALL	64
Restore Factory Default Settings.....	67
The Factory Default Settings	67

SYSTEM SETTINGS	69
System Information	69
Utility Settings	70
Firmware Upgrading	72
System Real Time Clock Setting	73
Description of Using Flash Drive	74
REMOTE CONTROL	79
Remote Control	79
Command Syntax	86
Command List	90
Command Details	95
SCPI Status Registers SCPI	130
Errors	138
APPENDIX	142
Replacing the Fuse	142
Battery Replacement	143
Specifications	144
Optional Accessories	146
Declaration of Conformity	147

S SAFETY INSTRUCTIONS

This chapter contains important safety instructions that you must follow during operation and storage. Read the following before any operation to insure your safety and to keep the instrument in the best possible condition.

Safety Symbols

These symbols may appear in the manual or on the instrument.



WARNING

Warning: Identifies conditions or practices that could result in injury or loss of life.



CAUTION

Caution: Identifies conditions or practices that could result in damage to the PPH or to other properties.



DANGER High Voltage



Attention Refer to the Manual



Protective Conductor Terminal



Earth (ground) Terminal



Do not dispose electronic equipment as unsorted municipal waste. Please use a separate collection facility or contact the supplier from which this instrument was purchased.

Safety Guidelines

General Guideline



CAUTION

- Do not place any heavy object on the unit.
- Avoid severe impact or rough handling that leads to damaging the unit.
- Do not discharge static electricity to the unit.
- Do not block the cooling fan opening.
- Do not perform measurements on circuits that are directly connected to mains power.
- Do not disassemble the PPH unless you are qualified.

(Measurement categories) EN 61010-1:2010 specifies the measurement categories and their requirements as follows. The PPH-1503D/1506D /1510D falls under category I.

- Measurement category IV is for measurement performed at the source of low-voltage installation.
- Measurement category III is for measurement performed in the building installation.
- Measurement category II is for measurement performed on the circuits directly connected to the low voltage installation.
- Measurement category I is for measurements performed on circuits not directly connected to Mains.

Power Supply



WARNING

- AC Input voltage range: 90VAC~264VAC
 - Frequency: 50Hz/60Hz
 - To avoid electrical shock connect the protective grounding conductor of the AC power cord to an earth ground.
-

Fuse



WARNING

- Fuse type: T2.0A/250V (PPH-1503D)
T2.5A/250V (PPH-1506D/1510D)
- To prevent fire, replace the fuse only with the specified type and rating.
- Disconnect the power cord before replacing the fuse.
- Make sure the cause of fuse blowout is fixed before replacing the fuse.

Cleaning the power supply

- Disconnect the power cord before cleaning the oscilloscope.
- Use a soft cloth dampened in a solution of mild detergent and water. Do not spray any liquid into the oscilloscope.
- Do not use chemicals containing harsh products such as benzene, toluene, xylene, and acetone.

Operation Environment

- Location: Indoor, no direct sunlight, dust free, almost non-conductive pollution (Note below)
- Relative Humidity: < 80%
- Altitude: < 2000m
- Temperature: 0°C to 40°C

(Pollution Degree) EN 61010-1:2010 specifies pollution degrees and their requirements as follows. The PPH-1503D/1506D/1510D falls under degree 2.

Pollution refers to “addition of foreign matter, solid, liquid, or gaseous (ionized gases), that may produce a reduction of dielectric strength or surface resistivity”.

- Pollution degree 1: No pollution or only dry, non-conductive pollution occurs. The pollution has no influence.
 - Pollution degree 2: Normally only non-conductive pollution occurs. Occasionally, however, a temporary conductivity caused by condensation must be expected.
 - Pollution degree 3: Conductive pollution occurs, or dry, non-conductive pollution occurs which becomes conductive due to condensation which is expected. In such conditions, equipment is normally protected against exposure to direct sunlight, precipitation, and full wind pressure, but neither temperature nor humidity is controlled.
-

Storage
environment

- Location: Indoor
- Relative Humidity: < 70%
- Temperature: -10°C to 70°C

Power cord for the United Kingdom

When using the power supply in the United Kingdom, make sure the power cord meets the following safety instructions.

NOTE: This lead/appliance must only be wired by competent persons



WARNING: THIS APPLIANCE MUST BE EARTHED

IMPORTANT: The wires in this lead are coloured in accordance with the following code:

Green/ Yellow:	Earth
Blue:	Neutral
Brown:	Live (Phase)



As the colours of the wires in main leads may not correspond with the coloured marking identified in your plug/appliance, proceed as follows:

The wire which is coloured Green & Yellow must be connected to the Earth terminal marked with either the letter E, the earth symbol \oplus or coloured Green/Green & Yellow.

The wire which is coloured Blue must be connected to the terminal which is marked with the letter N or coloured Blue or Black.

The wire which is coloured Brown must be connected to the terminal marked with the letter L or P or coloured Brown or Red.

If in doubt, consult the instructions provided with the equipment or contact the supplier.

This cable/appliance should be protected by a suitably rated and approved HBC mains fuse: refer to the rating information on the equipment and/or user instructions for details. As a guide, a cable of 0.75mm² should be protected by a 3A or 5A fuse. Larger conductors would normally require 13A types, depending on the connection method used.

Any exposed wiring from a cable, plug or connection that is engaged in a live socket is extremely hazardous. If a cable or plug is deemed hazardous, turn off the mains power and remove the cable, any fuses and fuse assemblies. All hazardous wiring must be immediately destroyed and replaced in accordance to the above standard.

OVERVIEW

This chapter contains a brief introduction to PPH-1503D/1506D/1510D, the main features, as well as an overview of the front and rear panel. Use the Getting Started chapter on page 25 to start up instructions and how to setup the appropriate operation environment.

Introduction

Overview

The PPH-1503D/1506D /1510Dis a high-precision, compact, dual output, multifunction, programmable DC power supply with flexible operating configurations. In addition to the basic power supply functionality, it is also able to measure pulse current, the average current over long periods of time and other functions such as battery simulation.

The PPH-1503D/1506D/1510D is designed for testing the power consumption of battery powered wireless communication devices (e.g. cell phones). Such devices often have large load variations within a short time span. The high precision power supply has excellent voltage stability during pulsed loads and is capable of simultaneously measuring the pulse current, even for very short pulses. In addition, the power supply is able to sink current, allowing it to simulate the characteristics of a discharged rechargeable battery for testing chargers and charge control circuits.

Basic Power Supply Function	The PPH-1503D/1506D/1510D works as a conventional power supply with automatic CC/CV crossover. Parameters such as the output voltage, current, read back refresh rate, data sampling period, power-on status, OVP and current range can be configured using the control panel. The voltage and current settings and the actual voltage/current are displayed on the LCD. For details, see page 32.
Pulse Current Measurement Function	The PPH-1503D/1506D /1510D can measure the change in instantaneous current and the current of extremely short pulses. The readback refresh rate, data sampling period, trigger delay and trigger level can be set by the front panel keys and is displayed on the LCD. For details see page 45.
Current Measurement over Long Periods	This function can measure the average current of one or more pulses. The readback refresh rate, trigger mode, and trigger timeout and trigger level settings are controlled by the front panel keys and are displayed on the LCD display. For details, see page 51.
Battery Simulation Function	The function can simulate a battery by setting the internal resistance of the power source and also display the real-time voltage and current on the LCD. For details, see page 56.
Current Sink Features	When the voltage of an external power source is greater than the high-speed power supply output, the system will automatically work as an electronic load to sink current. For details, see page 57.
Digital Volt Meter	The PPH-1503D/1506D/1510D has a DVM function that can measure DC voltages in the range of 0~20VDC. For details, see page 43.

Remote Control To meet the various needs of customers, the PPH-1503D/1506D/1510D is designed for USB, GPIB and LAN remote control. For details, see page 79.

Additional Features The PPH-1503D/1506D /1510D has external relay control signals for customers. The relay control signals are synced to the pulse current measurement feature. For details, see page 59.

Key Features

Features

- Low noise: Thermostatically controlled fan.
- Compact, lightweight.
- 3.5 inch TFT display.

Operation

- Constant voltage and constant current operation (CV/CC).
- Output on/off control (ON/OFF).
- CH1 Front and Rear output control key (FRONT/REAR).
- Digital panel control.
- 5 groups of save/recall settings and 10 automatically generated power-on settings.
- Digital voltage and current settings.
- Alarm buzzer (BEEP).
- Key lock function (LOCK).

Protection Features

- Overvoltage and overcurrent protection (OVP/Trip).
- Overtemperature protection (OTP).

Interface

- USB remote control.
- GPIB remote control.
- LAN remote control.

Operating Principals

Overview The PPH-1503D/1506D/1510D mainly consists of the follow components:

- AC to DC Switching power supply
- DC to DC Buck converter circuit
- Precision output control circuit

The block diagram below shows a function description of each of the circuits. The following page will show detailed descriptions of each component.

Block Diagram

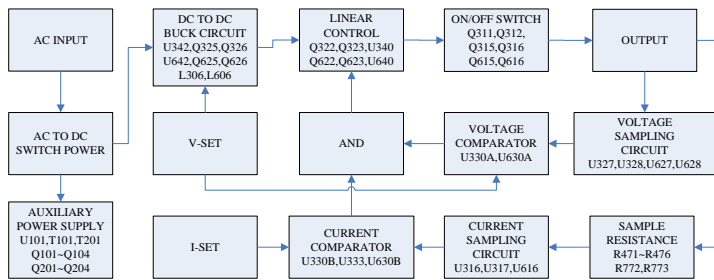

Switching Power Supply AC power is converted to 24VDC by the switch mode power supply module.

DC Down Conversion The U342, U642 Buck IC is used in conjunction with two power MOSFETS (Q325/Q326, Q625/Q626) and inductors (L306, L606) to convert two sets of 24VDC to voltage value which is slightly higher than the setting voltage value.

Linear Output
Circuit (Linear
Regulator)

The 322/Q323, Q622/Q623 dividers reduce the heat on a single component. The U330, U327, U328, U316, U317, U333, U630, U627, U628, U616 and U630 components form a control circuit to achieve accurate output.

Auxiliary Power
Supply

The independent auxiliary DC power supply is achieved with the U101, T101, T201, Q101~Q104 and Q201~Q204 components.

Front Panel

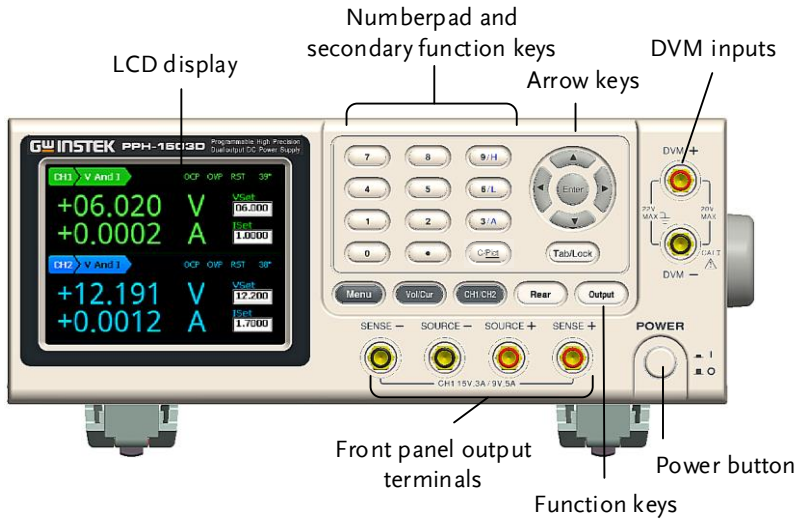

Display

Display Interface









Voltmeter Indicators

Displays the output voltage with up to 5 digits of resolution. The default units are Volts (V).

CH1: **+00.001 V**

CH2: **+00.000 V**

Ammeter Indicator Displays the output current with up to 5 digits of resolution, depending on the current range (CH1:5A or 10A /500mA/5mA/AUTO; PPH-1503D:CH2:1.5A/5mA/AUTO; PPH-1506D/1510D:CH2:3.0A/5mA/AUTO). The current range is selectable between A and mA.

CH1: 5A /10A	
500mA	
5mA	
CH2: 1.5A/3.0A	
5mA	
Auto	

Setting Display Displays the voltage and current settings.

CH1:	
CH2:	

Parameter Settings Display Displays the relevant parameter settings. For details on setting parameters, see page 29. The following figure shows the basic power source for both channels (V AND I)

CH1

List Setting			
IntRate:	1.00PLC	AverRead:	1
CurrRange:	5mA	LimitMode:	Limit
RelayControl:	Zero	O.V.P.:	10.00V,Off
Resistance:	0.000ohm		

CH2

List Setting			
IntRate:	1.00PLC	AverRead:	1
CurrRange:	Auto	LimitMode:	Limit
RelayControl:	Zero	O.V.P.:	10.00V,Off

Status
Display

Display the current status of the instrument.

CH1: 

CH2: 

Function
Display

Displays the unit functions. There four functions:

Basic power supply function (V AND I),
Pulse current meter function (PULSE),
Long integration current measurement function
(LONG INT), Digital Voltmeter function (DVM)(The
function only for CH2).

The basic power supply function is shown below.

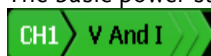



Function
Keys

Menu key



Menu key to enter or exit from
system settings.

Voltage and
Current
Setting key



Voltage and Current setting toggle switch. See page 36 for operation details.

CH1/CH2
Toggle Switch



CH1 and CH2 setting toggle switch. See page 37 for operation details.

CH1 Front
and Rear
output toggle
key



Front and rear output toggle switch. The key will be lit when the output is set to the rear outputs.

Rear panel output:

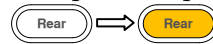

Output key



The Output key turns the output on or off. The Output key will light up when the output is on. It has no affect when DVM is activated.



Tab /LOCK
key



The Tab key is used to toggle between various parameters. The Lock key is used to disable all the panel keys except for the Output key. Pressing the Lock key for at least 2 seconds will turn the panel lock on or off. The Lock key can also be used to exit from remote control mode. When the panel lock is active the Lock key will light up.



Number pad



a. The number pad is used to enter various parameters and values. The Clear key can be used to clear set parameters. Pressing the C/Pict key for at least 2 seconds will take a screenshot.

b. H/ L/ A Pulse current measurement shortcut keys. These short cut keys only work in the Pulse current measurement main menu.

H: High measurement mode

L: Low measurement mode

A: Average measurement mode

Directional keys and Enter key

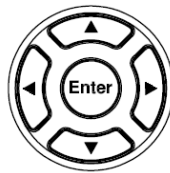

The directional keys are used for parameter and menu selection as well for fine adjustment of the current/voltage settings.

The Enter key is used to confirm the selection of any settings or parameters and to exit after a setting is complete.

Power Button

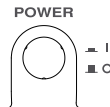

Turns the power on or off.

On: ■

Off: ■

Terminals

Output Terminals (SOURCE)



Source terminals for the front panel CH1 output.

Voltage
Feedback
Terminals
(SENSE)

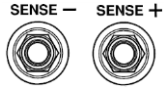

Sense terminals for the front panel
CH1 output.

Voltmeter
Terminals
(DVM)

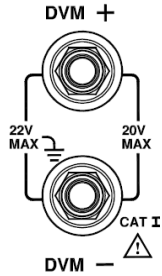

Digital voltmeter input terminals.

Rear Panel

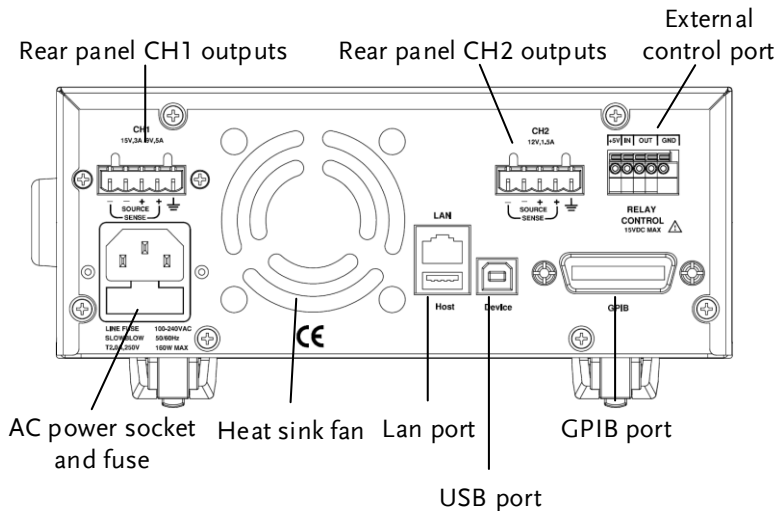

Terminals

AC input socket and line fuse

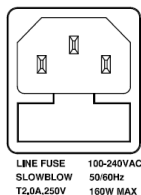

The AC input accepts 100 to 240 ± 10% VAC. The frequency is 50Hz/60Hz. Fuse: 2.0A (PPH-1503D) / 2.5A (PPH-1506D/1510D) slow-blow type See page 142 for details.

USB port



USB device port for remote control. See page 79 for details.

GPIB port

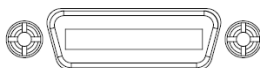

GPIB slave port for remote control. Abides to IEEE488.2 (SCPI) protocol. See page 80 for details.

LAN & Host port



LAN and USB Host port for remote control. See page 82 for LAN setting and operation details. See page 74 for details of USB Host setting and operation.

CH1 rear panel output interface

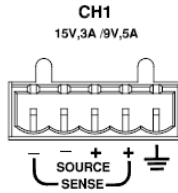

A total of 5 ports: 1 positive output terminal, 1 negative output terminal, a Sense+ terminal, a Sense- terminal and a ground terminal. Refer to the printed label under the terminals for the specific order of the terminals.

CH2 output interface

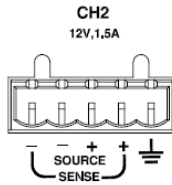

A total of 5 ports: 1 positive output terminal, 1 negative output terminal, a Sense+ terminal, a Sense- terminal and a ground terminal. Refer to the printed label under the terminals for the specific order of the terminals.

Relay control interface

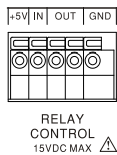

A total of 5 ports: A +5V input terminal, a ground terminal, a logic level input terminal and 2 CH1/CH2 terminals for relay control. See page 59 for relay control details.

Constant Voltage/Constant Current Crossover Characteristics

Background The unit will switch automatically between constant voltage and constant current according to changes in the load.

CV mode When the load current is less than the current setting, the unit operates in constant voltage mode, changing the current level according to the load but maintaining the set voltage level until the current reaches the set current level. The status indicator will show CV on the LCD when in CV mode.

Constant Current Mode When the output current reaches the set current level, the unit switches operation to constant current mode. The status indicator will show CC on the LCD display. In CC mode, the current level is maintained and the voltage level is limited to less than the set voltage level to limit the output power from an overload. When the current drops below the set current level, the unit will revert back to CV mode.

Diagram

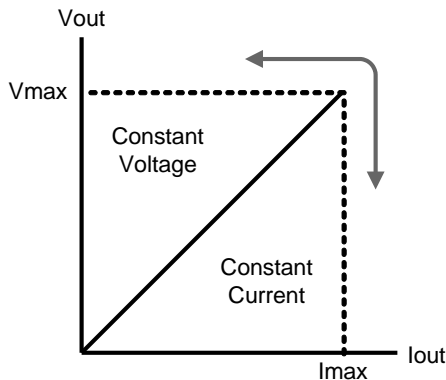

GETTING STARTED

This chapter describes the start up procedures and the preparation that is necessary before operating the power supply.

Start Up

Checking the AC Voltage

Before the power is turned on, confirm that the input power supply meets the following conditions:
100-240VAC $\pm 10\%$, 50Hz/60Hz

LINE FUSE	100-240VAC
SLOWBLOW	50/60Hz
T2.0A,250V	160W MAX

Connecting the AC power cord

The fuse is a 2.0A (PPH-1503D) /2.5A (PPH-1506D/1510D) slow-blow fuse. Confirm that the fuse is of the correct type and rating before connecting the power cord.

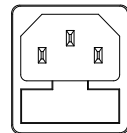

Turning the power on

Press the power button. The LCD will display the line frequency of the AC power supply.

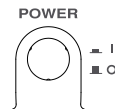

Turning the power off

To turn the power off, press the power button again.

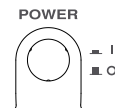

Load and DVM Connection

Recommended Cables	Model	Specification	Usage
	GTL-207A	1kV	Front panel DVM input
	GTL-204A	10A	Front panel Source terminal
	GTL-203A	3A	Front panel Sense terminal

Front panel wiring

Use the GTL-204A cables for the front panel source connections.

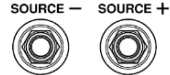

Use the GTL-203A cables for the sense connections.

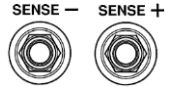

Use the GTL-207A cables for the DVM connections.

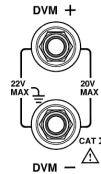

Rear panel connections

Insert the wires into the appropriate terminal according to the labels printed under the terminals.

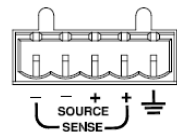

 Note

For safety considerations, please keep in mind that the wiring must be equivalent to the wiring on the front terminals.

Wire Gauge

Load wires must have enough current capacity to minimize cable loss and load line impedance. Voltage drop across a wire should not exceed 0.5V. The following list is the wire current rating at 450A/cm².

Wire Size(AWG)	Maximum Current (A)
20	2.5
18	4
16	6
14	10
12	16

Turning the Output On/Off

Panel Operation Press the *Output* key to turn the output on. The *Output* key will light-up when the output is on.

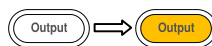

When the output is turned on, pressing the *Output* key again will turn the output off.

Automatic
Output Shut
Down

Any of the following actions will cause the output to be automatically shut down:





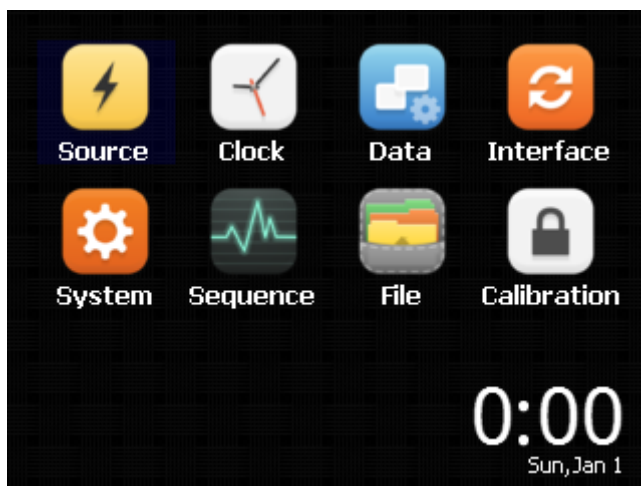

- Recall the saved setting
- OVP/OTP protection is tripped.
- OCP protection is tripped.

M MAIN MENU OVERVIEW

This chapter describes each main function and system setting for this device. The following interface will appear when the Menu key is pressed.



Function Description

Function	Function Description	
Source	CH1 / CH2 have basic power functionality. They can display different current values simultaneously. For details, please refer to page 32, in the section, "BASIC OPERATION".	
Clock	System Real Time Clock Setting For details, please refer to page 73, in the chapter, "System Real Time Clock Setting".	
Data	For details about the specific parameters displayed in Save / Recall, please refer to page 64, in the chapter, "SAVE/RECALL".	
Interface	Remote control setting. For details, please refer to page 79, in the chapter, "REMOTE CONTROL".	
System	System parameter settings. For details, please refer to page 69, in the chapter, "SYSTEM SETTINGS".	
Sequence	Output waveform settings. For details, please refer to page 62, in the section, "SEQUENCE Function".	
File	The System folder is used to import and export data. For details, please refer to page 74, in the section, "Description of using flash driver".	

Calibration

Currently this function is not available.



Date/time

The real-time clock of the device. The date/ time are displayed in this area.



BASIC OPERATION

This chapter describes how to set various functions.

Source Function

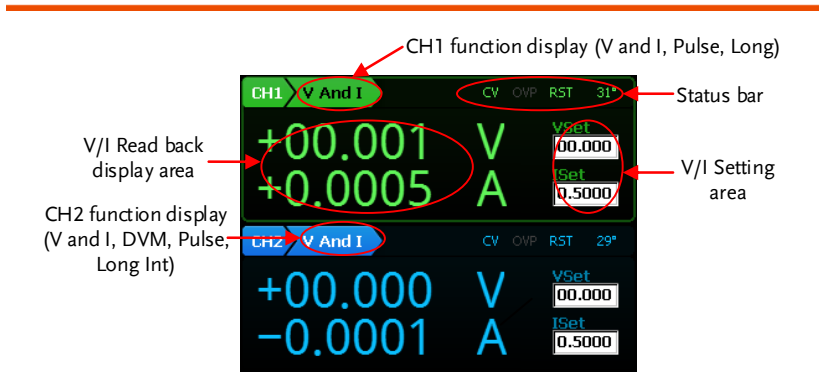

 Note

1. Under the Source interface:
 Press the Tab key to toggle between "Function Setting", "VSet" and "ISet". CH1 has three functions: V and I / Pulse / Long Int. CH2 has 4 functions: V and I / DVM / Pulse / Long Int. Press the Enter key to enter the corresponding channel's parameter settings. The arrow keys can be used to switch to the secondary parameters. Press the Menu key to exit the parameter settings.
2. When "Function Setting" is selected (displayed font is black), press the arrow keys to switch between the different "Function Setting".

Description	<p>CH1 and CH2 operate as a basic power supply with the ability to simultaneously display V/I settings and readback values. The output from CH1 can be toggled between the front and rear outputs using the <i>Rear</i> key. When the <i>Rear</i> key is lit, it indicates that the rear panel output is activated and that the front panel output is off. Both outputs can't be activated at the same time.</p>	
Parameter Description	IntRate	<p>The data sampling period derived from the number of power line cycles. The setting range is 0.1PLC to 10.00PLC (power line cycles). 1PLC = 16.7ms (60Hz)/20ms (50Hz). *PLC stands for power line cycles.</p>
	AverRead	<p>Readback refresh rate. This will display the average number count.</p>
	CurrRange	<p>The current range selection. Ch1 has four settings: 5A(1503D/1506D) or 10A(1510D), 500mA, 5mA and Auto. CH2 has three settings: 1.5A (1503D) or 3.0A (1506D/1510D), 5mA and Auto.</p> <p>The 5mA range only accepts a current setting 1A or less. If the 5mA range is selected and if the current setting is greater than 1A, the setting value is automatically reduced to 1A. Auto only used for automatic selection of current reading range.</p>

LimMode Current limiting mode. There are 4 settings for the current limiting mode: Limit, Trip, LimitRelay and Trip Relay.

The Limit settings will limit the current. When the current reaches the setting value, the current remains constant, as in CC mode.

The Trip setting will turn the output off when the current limit has been reached.

The Limit Relay setting will assert the relay output control interface low when the output current reaches the limit setting.

Otherwise, the relay output interface will be asserted high.

The Trip Relay setting will assert the relay output control interface low when the output current limit is tripped. Otherwise, the relay output interface will be asserted high.

See page 59 for details on the Limit Relay and Trip Relay settings.

RelayControl The relay control settings have 2 configurations: Zero/One.

The Zero setting means that the output from the Relay control interface OUT port is low and the external relays will energize.

The One setting is just the opposite of the Zero setting.

The user sets the initial state. When the state of the relay control signal changes, the actual state of the relay is displayed.

See page 59 for further details.

Resistance The Setting range for battery resistance simulation is $0.000\Omega \sim 1.000\Omega$ and the setting resolution is 0.001Ω .



Note:

This feature is only for CH1.

O.V.P The overvoltage settings have a setting range of 1.00 ~ 16.00V CH1)/ 1.00 ~ 13.00V (CH2), OFF or AUTO.

RecallSetup There are 6 sets of save/recall memories.
Rst/ SAV0 to SAV4

Output Range	Voltage	CH1:0.000V~15.000V CH2:0.000V~12.000V
--------------	---------	--

Current	CH1:0.0000A~3.0000A (0V~15V) 0.0000A~5.0000A (0V~9V) 0.0000A~10.0000A (0V~4.5V) (1510D REAR) CH2: 0.0000A~1.5000A (1503D) 0.0000A~3.0000A (1506D/1510D)
---------	---

Parameter Settings (For example CH1)	Voltage	Press the Vol/Cur key and the voltage setting on the LCD is activated. The corresponding number will turn black on white background.	
---	---------	--	---

- (a) Use the number pad (keys: 0~9, ., , Clear) to set the voltage value. Press the *Enter* key to confirm.

To enter 6.543V:



(b) Step Setting:

Press the left and right arrow keys () to fine tune the voltage setting at the digit level (The corresponding number will turn black on white background). Press the up and down arrow keys



() to adjust the selected digit. Press the

Enter key () to complete the setting.

Current

Press the Vol/Cur key and the current setting on the LCD is activated. The corresponding number will turn black on white background.



(a) Use the number pad (keys: 0~9, ., Clear) to set the voltage value. Press the *Enter* key to confirm.

To enter 1.2345A:

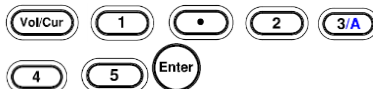



(b) Step Setting:

Press the left and right arrow keys () to fine tune the voltage setting at the digit level (The corresponding number will turn black on white background). Press the up and down



arrow keys () to adjust the selected digit. Press the *Enter*

key () to confirm the setting.

 Note: “*Vol / Cur*” key is used for only switching voltage and current settings.

IntRate Press the *Enter* key to bring up the CH1 parameter setting bar. The default setting is IntRate. Use the *Enter* key to set the parameters. Use the numeric keypad to enter parameters. Press the *Enter* key again to confirm the setting. The parameter range is from 0.01 to 10.00PCL. Press the *Arrow* keys to set the other parameters for the setting.

AverRead	Press the <i>Arrow</i> keys to toggle to AverRead item. Press the <i>Enter</i> key. Use the numeric keypad to enter desired parameters. Press the <i>Enter</i> key to confirm the setting. The parameter range is from 1 to 10 samples. Press the <i>Arrow</i> keys to select the other parameters for the setting.
CurrRange	Press the <i>Arrow</i> keys to toggle to CurrRange item. Press the <i>Enter</i> key. Use the up and down arrow keys to select the desired current range. Press the <i>Enter</i> key again to confirm the setting. Press the <i>Arrow</i> keys to select the other parameters for the setting.
LimMode	Press the <i>Arrow</i> keys to toggle to LimitMode. Press the <i>Enter</i> key. Press the up and down arrow keys to select the Current Lim mode. Press the <i>Enter</i> key to confirm the setting. Press the <i>Arrow</i> keys to select the other parameters for the setting.
RelayControl	Press the <i>Arrow</i> keys to toggle to RelayControl. Press the <i>Enter</i> key. Press the up and down arrow keys to set the desired initial state of relay control. Press the <i>Enter</i> key again to confirm the setting. Press the <i>Arrow</i> keys to select the other parameters for the setting.

Resistance Press the *Arrow* keys to toggle to Resistance. Press the *Enter* key. Use the numeric keys to enter parameters (Range: 0.000 to 1.000 Ω). Press the *Enter* key again. Press the *Arrow* keys to select the other parameters for the setting.

This feature is only for CH1.

O.V.P Press the *Arrow* keys to select O.V.P. Press the *Enter* key. Press the down arrow key to select the desired OVP State. There are three states: Off / On / Auto. If the On state is selected, you will need to enter the OVP value. Use numeric keypad to set the parameters. The input parameter range is from 01.00 to 16.00V (CH1)/1.00 to 13.00V (CH2). There is no need to set the OVP value for both the Off and Auto states.

When Auto is selected, the OVP function will activate if the output value is higher than the setting value by 0.8V.

When connecting with four wires, if any of the source wires disconnects from the load, the OVP function will be activated automatically (i.e., output open circuit protection is activated)



Note

1. After the parameter settings are complete, press the *Menu* key to return to the display interface.
2. The *Clear* key can't be used to clear numbers that have already been entered. It is necessary to set the number again.
3. All numerical parameters can be set by entering the parameter values with the number pad or by using stepped input values.

Operation

REAR /
FRONT

After setting all the parameters, press the *Rear* key to toggle the output between the front and rear terminals for CH1. When the *Rear* key is lit, it indicates that the rear panel output is activated for CH1. When the *Rear* key is not lit, it indicates that the front panel output for CH1 is activated.

Output

Press the *Output* key to turn the output on. When the output is on, the *Output* key will light up. When the output is off, the *Output* key will not be lit.

Status
Description

CV/CC

CV appears in green (CH1) or in blue (CH2)

CH1 CH2

CC appears in red





O.V.P

OVP will appear in green (CH1) or in blue (CH2) when the OVP has not been tripped.

CH1 CH2

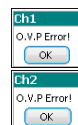
When the OVP has tripped, the output will be turned off and a small prompt window appears.



	When the OVP protection has not been activated, it will be greyed-out. 
RST	Displays the power-on state setting. There are 11 states that can be selected: RST and SAVE0 ~ SAVE9. The state can be set with the PowerOnSetup option in System settings. Refer to page 67. 

DVM

Description The PPH-1503D/1506D /1510D has a separate digital voltmeter with a measurement range of 0~+20VDC on CH2.



Note: DVM and CH2 have a common ground design. So when using the DVM- terminal, it can't be shorted with the negative output of CH2. In addition, when using the voltage meter, the power supply must be properly grounded.

Parameter Description	Intrate	Sets the reading rate of DVM measurements based on the number of PLCs. The setting range is: 0.1PLC to 10. 1PLC=16.7ms (60Hz)/20ms(50Hz).
------------------------------	----------------	---

This parameter is shared with "V and I" of CH2.



*PLC stands for Power Line Cycle

AverRead	Normally the unit will display measurement results onto the screen as soon as they are captured.
-----------------	--

However when more stable results are needed, averaging can be used. The AverRead function collects several samples of data and then performs an averaging operation on the data before displaying the averaged result on the screen.

This parameter is shared with "V and

 I" of CH2.

Parameter Settings	IntRate	<p>Press <i>Enter</i> key to bring up the CH2 parameter setting column. The default setting is IntRate. Press the <i>Enter</i> key. Use numeric keypad to set the parameters (Range: 0.01 to 10.00). Press the <i>Enter</i> key again. Press the <i>Arrow</i> keys to select the other parameter for settings</p>
	AverRead	<p>Press the <i>Arrow</i> keys to select AverRead item. Press the <i>Enter</i> key. Use numeric keypad to set the parameters (Range: 1 to 10). Press the <i>Enter</i> key again. Press the <i>Tab</i> key to select the other parameter for settings.</p>
Operation		<p>Press CH1 / CH2 key to switch to the CH2 setting. Press the <i>Tab</i> key to switch to the function selection mode (V and I is changed from  to ). Press the right arrow key to go to DVM mode ().</p> <p>After switching to the DVM mode, the device is synchronized to start measuring. When voltage is measured, it doesn't affect the operation of the power supply. The output can be turned on or off by pressing the <i>Output</i> button.</p>
Connection		<p>For the connection details for the front and rear terminals, please page 26.</p>

Pulse Current Measurement

Description Changes in the load current allow us to measure the pulse current.

There are three ways that pulse current can be measured:

1. Measuring the peak current over a single cycle (High Measurement).
2. Measuring the trough current over a single cycle (Low Measurement).
3. Measuring the average current over a single cycle (Average Measurement).

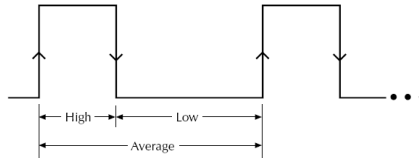

The high and average measurements are triggered by the rising edge of the pulse current are performed for the time specified for the measurement.

Low measurement is triggered by the falling edge of the pulse current.

 **Note:** Pulse current measurement is only valid up to 5A or 10A (CH1) and 1.5A or 3.0A (CH2).

Parameter Description

- IntTime**
- Integration Time.
 - The integration measurement time can be set to automatic or to one of the manual settings (High Time, Low Time and Aver Time).
 - When the integration measurement time is set to

automatic mode, the system will measure the peaks and troughs of the pulse current and will automatically set an appropriate integration time. The average integration time is the time of all the accumulated peaks and troughs. After the setting the integration time to automatic, the setting will apply to all subsequent pulse measurements, unless the automatic integration mode is applied again or the integration time is manually set. The automatic Integration time can automatically detect pulses in the 80us to 833ms range.

- The manual time range setting is 33us to 833333us. The default units are in microseconds (us).



Note

IntTime setting automatically becomes 33.3 microseconds (us) in mode (Pulse current digitization)

For details, please refer to page 109

TrigDelay

- Trigger Delay
- When a pulse is detected, there will be a 25us code execution delay time. The trigger delay settings are used to filter out the current overshoot. Measurement will begin from after the trigger delay time. The trigger delay setting range is: 0~0.10000s, with a resolution of 0.00001s. The setting units are in seconds.



Note

The setting range for TrigDelay is 0~5 sec.(s) in mode (Pulse current digitization) For details, please refer to page 112

AverRead

- Average Reading Count: Reads back the average number of displayed values.
- This parameter is only applicable for pulse current measurement. The average number range can set from 1 ~ 100 with a resolution of 1.



Note

The setting range for AverRead is 1 ~ 5000 with a resolution of 1 (Pulse current digitization). For details, please refer to page 108

Trig Level

- Trigger Level.
- To avoid false pulse measurements, the trigger level can be set close to the current amplitude. All noise and transient currents that are below the trigger level will be ignored. The trigger level has a setting range of 0~5A (CH1), 0~1.5A or 0~3.0A (CH2) with a resolution of 5mA. The setting unit for the trigger level is in amps (A). This setting is only valid for pulse measurements.

 Parameter
Settings

IntTime

Press the *Enter* key to enter the Pulse current measurement menu. The IntTime setting is the default setting when you first enter the IntTime menu. Press *Enter* key to select the desired setting. Press the down arrow key to set the type of

Integration Time. High Time, Low Time and AverTime options are available for selection. Press the up arrow key to decide to set the integration time automatically or manually set. When manually setting is select, use the numeric keypad to directly select a time setting. Press *Enter* key to complete the setting.

Example:

Low Time 66us: Enter the pulse current measurement menu.

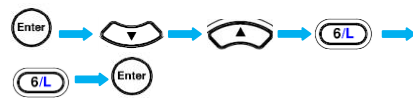

The time range can be set between 33us and 833333us. The setting units are in microseconds (us).

TrigDelay

Press the *Arrow* keys to select TrigDelay. Press the *Enter* key. Use numeric keypad to set the parameters. Press the *Enter* key again.

The TrigDelay has a settable range of 0~0.10000. The setting units are in seconds (s).

TrigLevel Use the *Arrow* keys to select TrigLevel. Press the *Enter* key. Use numeric keypad to set the parameters. Press the *Enter* key again.

The TrigLevel parameter has a settable range of 0~5.000A (CH1), 0~1.500A or 0~3.000A (CH2). The setting units are in amperes (A).

AverRead Use the *Arrow* keys to select AverRead. Press the *Enter* key. Use numeric keypad to set the parameters. Press the *Enter* key again.

The AverRead setting has a settable range of 1~00.

Panel Operation **Output**

Press the *Output* key. When the Output key is lit, pulse current measurement is active.



When no pulse current is detected, NO PULSE will be displayed in green on the LCD screen. The unit will wait until the next pulse is detected (CH1 is used as an example here).



The measurement settings can be edited during measurement. The H, L, A keys on the keypad can be used to perform fast-switching between measurement modes.

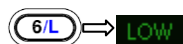

Long integration

Description The long current integration measurement function measures the mean (average) current over a single or multiple current pulses. The long integration time period must be a full period or integer multiples of a complete period of the measured pulse current. The Long integration measurement calculates the whole integration time as an integer number of integration cycles. An integration cycle is the line cycle period plus the data processing time.

For example, if the line frequency is 60Hz, then a single integration cycle is 16.7mS, if the frequency is 50Hz, then a single integration cycle is must be 20mS. Long integration is one of the methods to extend A/D circuits to exceed beyond their maximum integration time. The A /D conversion circuits can measure a pulse of up to 833 ms. Long integration measurement extends the A/D integration time to achieve a longer pulse measurement. This can extend the measurement time for long integration to a maximum of 60S.



Note: When this feature is used, the current range is set to 5A (CH1 with PPH-1503D/1506D), 10.0A (CH1 with PPH-1510D).1.5A (CH2 with PPH-1503D) , 3.0A (CH2 with PPH-1506D/1510D).

Parameter Description	IntTime	<ul style="list-style-type: none">• Integration time• The integration time can be set manually or automatically by the operator. For manual settings, the integration time can be set to a maximum of 60 seconds. For a line frequency of 60Hz the minimum integration time is 850ms with a step resolution of 16.7mS. For a line frequency of 50Hz, the minimum integration time is 840ms with a step resolution of 20ms.• When the integration time is set to Auto Time, the system will automatically measure the time between two adjacent rising edges and an appropriate integration time is set for the peak and trough. If there are more than two pulses, the integration time must be set manually.
	TrigEdge	<ul style="list-style-type: none">• Trigger edge• Pulse edges are used to trigger long integration measurement. Regardless of whether a rising or falling edge is used as a trigger, a pulse must first be detected before measurement can start. Measurement can also start without an edge trigger. When TrigOnNeither is selected, measurement starts as soon as the output is turned on.

Trig Level	<ul style="list-style-type: none"> • Trigger level. • When the rising or falling edge trigger is selected for long integration current measurement, a pulse must first be detected. The trigger level refers to minimum pulse level required for a pulse to be detected. For example if the trigger level is set to 2A, pulses that are $\leq 2A$ will be detected. Pulses $< 2A$ will be ignored. The trigger level range is 0~5A (CH1), 0~1.5A or 0~3.0A (CH2). This setting only applies to long current integration measurements.
Timeout	<ul style="list-style-type: none"> • Pulse timeout • When long integration measurement is selected and the unit doesn't detect a pulse after a certain amount of time (pulse timeout time), the "No Pulse" message will be displayed on the LCD. This function is only applicable if rising or falling edge is selected as the edge trigger; the Trig OnNeither trigger setting has no pulse timeout. The pulse timeout has a range of 1~63 seconds.
Parameter Settings	<p>IntTime</p> <p>Press the <i>Enter</i> key to enter the Long integration measurement menu. The IntTime setting is the default setting when you first enter the IntTime menu. Press <i>Enter</i> key to select the desired setting. Press the up arrow key to decide to set the integration time automatically or manually set. When manually setting is select, use the</p>

numeric keypad to directly select a time setting. Press *Enter* key to complete the setting.

For manually set integration times, if the set time is not an integer multiple of the integration cycle time, the system will automatically round down to closest maximum integer multiple that can be set. The time range is 850ms to 60s (50Hz) and 840ms to 60s (60Hz). The default unit is seconds (s).

TrigEdge Use the *Arrow* keys to select TrigEdge. Press the *Enter* key. Use the up and down arrow keys to select the type of trigger. Press the *Enter* key again. The interface will display the selected trigger type.

TrigLevel Press the *Arrow* key to select TrigLevel. Press the *Enter* key. Use numeric keypad to directly set the parameters. Press the *Enter* key again. The trigger level setting range is 0~5A (CH1), 0~1.5A or 0~3.0A (CH2). The default unit is amps (A.)

Timeout Press the *Arrow* key to select Timeout. Press the *Enter* key. Use numeric keypad to directly set the parameters. Press the *Enter* key again. The time range is 1~63s. The default unit is seconds (s).

Operation

Output

Press the *Output* key. When the Output key is lit, pulse current measurement is active.



When no pulse current is detected, NO PULSE will be displayed in green (CH1) or in blue (CH2) on the LCD screen. The unit will wait until the next pulse is detected.

NO PULSENO PULSE

Battery simulation function

Function Description The function can be seen as being equivalent to power source U in series with resistor R . The equivalent circuit model diagram is shown below:

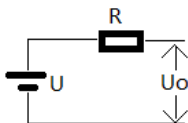

The unit has an internal series resistor that can set the resistance of the circuit to simulate the output voltage of a battery.

Output voltage When CH1 is outputting current, the output voltage will decrease when the output current increases.

When CH1 is used as a sink, the output voltage will increase with an increase in output current.

Setting the internal resistance The internal resistance setting range is 0.000 to 1.000 ohms. For detailed operation, please refer to page 40.

Current Sink Function

Function Description When the test circuit is an active circuit, and the manifested voltage in the test circuit is greater than the output voltage of the power supply, the power supply will automatically disipate current from the external power supply. When this function is in the normal operating state, the power supply outputs the setting voltage, which is equivalent to a constant voltage load rather than constant current load.

The current disipation from the power supply output flows from the positive terminal out to the negative terminal. The amount of current sunk is not controlled from the power supply.

Connection Connect the positive terminal of the external power supply to the positive terminal on the high-speed power supply. Connect the negative terminal of the external power supply to the negative terminal on the high-speed power supply.

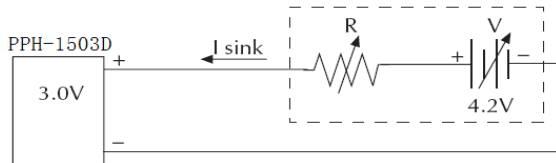

- Conditions To protect the high-speed power supply when operating as a current sink, the following two conditions must be met:
1. Ensure that the voltage of the external power supply is greater than the output of the high-speed power supply voltage by 0.3V~2.5V. The voltage difference depends on the high-speed power supply voltage output and the load conditions.
 2. To ensure that the power supply output voltage is within certain range, the current draw must be less than the limit value. See the formula in the Table below for the details.

CH1: To ensure that the high-speed power supply output voltage is within the range of 0~4V, the current draw cannot exceed 3.5A. For output voltages between 4V~15V, the current draw must be reduced by 0.25A for each 1V increase. See the formula in the table below for the details.

High-speed Power Supply Output Voltage	Maximum Dissipation Current
0~4V	3.5A
4V~15V	$3.5A - (0.25A/V) * (V_{set} - 4V)$

CH2: To ensure that the high-speed power supply output voltage is within the range of 0~5V, the current draw cannot exceed 2A(or 3A). For output voltages between 5V~15V, the current draw must be reduced by 0.1A(or 0.25A) for each 1V increase. See the formula in the table below for the details.

High-speed Power Supply Output Voltage		Maximum Dissipation Current
0~5V	1503D	2.0A
	1506D/1510D	3.0A
5V~12V	PPH-1503D	$2.0A - (0.1A/V) * (V_{set} - 5V)$
	1506D/1510D	$3.0A - (0.25A/V) * (V_{set} - 5V)$

External Relay Control

Function When the Relay control feature is turned on, it is synced to the current limit of the power supply.

Description The external relay control is divided into two different types, a limit relay and a trip relay.

The limit relay is used in conjunction with CC mode. When the constant current setting value is reached, the relay control signal will go high and will return back to the low level when the current level goes back below the constant current setting.

The trigger relay is used in conjunction with CC mode. When the constant current setting value is reached, the relay control signal will go high and the output is disabled. When the output goes back on and the current is less than the current setting value, the relay control signal will back to the low level.

Rear Panel Control Interface The rear panel control interface has five terminals, +5V, IN (The state of the Trip or Trip Relay output is used as the signal input), OUT (CH1 & CH2 controls signal output) and GND (connected to the chassis ground or earth ground), respectively.

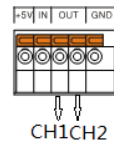

Wiring Method A thin screwdriver or similar tool will need to be inserted into the release mechanism (highlighted in orange in the figure above) to open the terminals. Insert an exposed wire into the terminal and release the mechanism to lock the wire into place.

Schematic
Diagram for
Relay Control

Limit Relay:

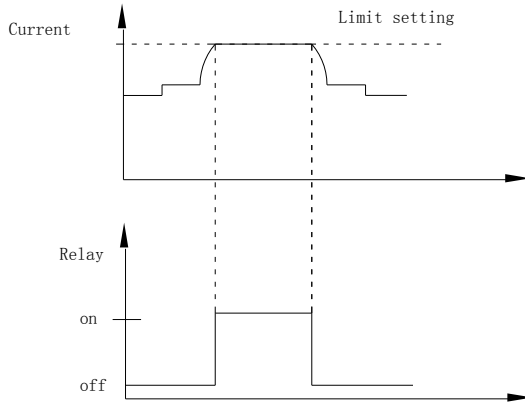

Trip Relay:

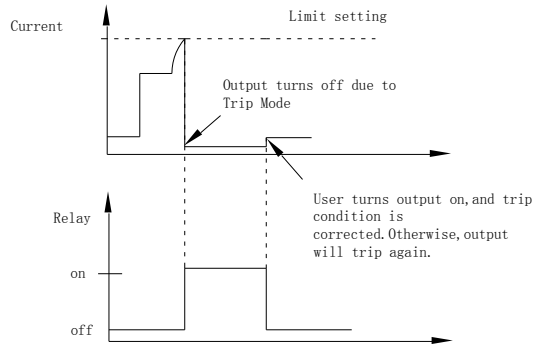

External Relay Connection

There are two ways to connect an external relay to the unit:

1. Using the +5VDC relay output to drive an external relay. Ensure the current doesn't exceed 150mA.

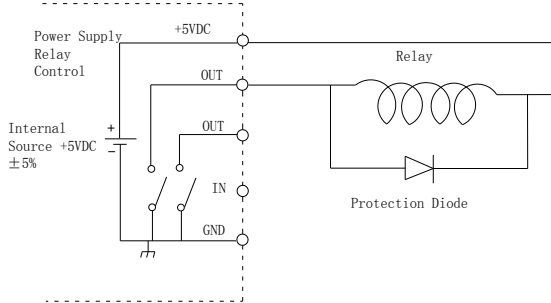

Warning: Do not short the 5VDC terminal to the chassis, earth or to the control port GND, otherwise it may damage the unit.

2. Using an external power source to drive the external relay. The voltage of the source cannot exceed 15V and the current cannot exceed 150mA.

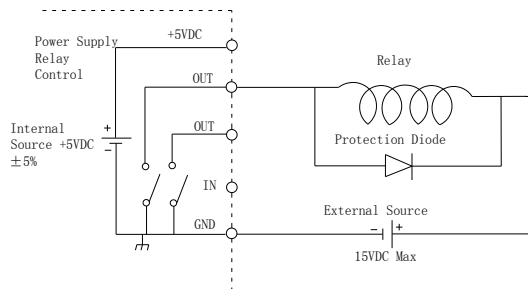

Sequence Function

Description This function can be used for practical applications when different voltage waveforms are required to be output. Users can edit the output waveform according to their needs. The amplitude range of the output waveform is the output voltage range of power supply. The setting range for output waveform duration is 0.001s ~ 3600s and the resolution is 0.001s.



Note: This feature is applicable to CH1.

Parameter Overview	NCycle	Cycle number, N represents an infinite loop (Enter digit "0"). 1 represents a 2 cycle period. 2 represents a cycle with 2 periods, and so on. The range is from 0 to 9999.
---------------------------	---------------	--

Steps	Sets the number of parameter which can set. The range is 1 to 1,000.
--------------	--

Parameter Setting	NCycle	After entering the Sequence interface, this parameter is selected by default. Use the numeric keys to set parameters directly and then press the <i>Enter</i> key.
--------------------------	---------------	--

Steps	Press the <i>Tab</i> key to select Steps. Press Use numeric keys to set the parameters directly and then press the <i>Enter</i> key.
--------------	--

V/I/T
Setting

Press the *Tab* key to select the Voltage / Current / Time setting area.

No	V	A	S
1	1.000	2.0000	2.000
2	1.000	0.5000	0.100
3	1.000	0.5000	0.100

Press the up and down arrow keys to select the desired Step setting. Press the *Enter* key to input voltage value. Press the right arrow key to input the current value. Press the right arrow key to enter the duration and press the *Enter* key to complete the Step settings. Press the arrow keys to continue to set other specific parameters for the Steps setting.

Operation

Enter the
Sequence
interface



SAVE/RECALL

Description Five groups of system settings are available. SAV0, SAV1, SAV2, SAV3 & SAV4, respectively.

There are a total of 6 different memory settings that can be recalled: Rst, SAV0, SAV1, SAV2, SAV3 and SAV4.

Parameter data Listed below are the settings that are available for each group (SAV0 in CH1 is shown as an example).

Item	Status
Voltage:	0.000 V
Current:	0.5000 A
OutputState:	Off
DispType:	Actual V and I
CurrRange:	5 A
IntRate:	1.00 PLC
AverRead:	1
O.V.P.:	10.00 V (Off)
LimMode:	Limit
RelayControl:	Zero
HighTime:	33 uS
LowTime:	33 uS
AverTime:	33 uS
AverRead(P):	1
TrigDelay:	0.00000 S
TrigLevel(P):	0.000 A
IntTime:	1.000 S
TimeOut:	16.000 S
TrigEdge:	RISING
TrigLevel(L):	0.000 A

The parameters with parentheses are the ones with a specified function. For example, TrigLevel (P) is the power level setting for pulse measurement.

Operation Press the *Menu* key to enter the main menu interface.



Use the right arrow keys to select the Data option.



Press the *Enter* key to go to the Data menu.



Use the down arrow keys to expand the six sets of options for the selected channel, RST, SAV0, SAV1, SAV2, SAV3 and SAV4, respectively. Press the down arrow key to select the desired save memory. There are five selections: SAV0, SAV1, SAV2, SAV3 and SAV4.



Press the *Enter* key and the Save/Recall window appears. Press the *Tab* key to select save or recall. Press the *Enter* key to complete this step. The Save/Recall selection window is shown as below.

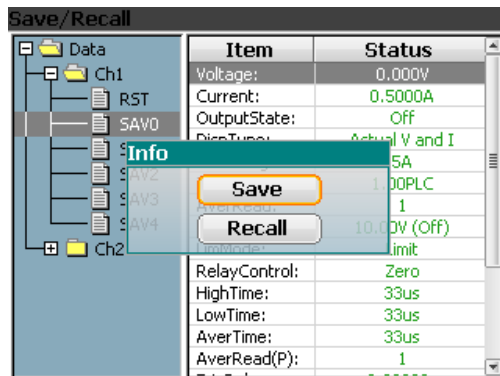

Power-on Settings

In the System Setting menu, the interface parameter settings area shows PowOnSetup settings. There are 11 settings to choose from, Rst, SAV0~SAV4 and SAV5~SAV9.

The main difference between SAV0~SAV4 and SAV5~SAV9 is that SAV0~SAV4 are user saved settings and don't contain the Power On/Off state (It is always off) while the SAV5~SAV9 contain the Power On/Off state (it can be on or off).

The relationship between SAV0~SAV4 and SAV5~SAV9 is as follows:

SAV0 \Rightarrow SAV5

SAV1 \Rightarrow SAV6

SAV2 \Rightarrow SAV7

SAV3 \Rightarrow SAV8

SAV4 \Rightarrow SAV9

Restore Factory Default Settings

Description The system can restore six sets of settings. The Rst setting is the factory default settings. This setting cannot be modified by the user.

Operation There are two methods to retrieve the factory default settings. Please see the Recall Settings sections for instructions (page 64).

The Factory Default Settings

Description	Setting value	Setting item	Setting value
Voltage setting	00.000V	Current range	Auto
Current setting	0.5000A	Integration time ratio	1.00PLC
Output state	Off	Readback display 1 for V and I mode (average value)	
Displayed type	Actual V and I	O.V.P Overvoltage Protection	10.00 (Off)
GPIB address	5	Limited current mode	Limit
GPIB format	Exponential	Relay control	Zero
Pulse measurement time	33us	Readback display 1 for Pulse mode (average value)	
Low level measurement time	33us	Trigger delay	0.00000s
The average measurement time	33us	Pulse trigger level	0.000A

Long integration time setting	1.000s	Trigger mode	Rising
Overflow time setting	16.000s	Long integration trigger level	0.000A
Pulse measurement time	High	Digital quantized output mode	Off
Pulse time setting	Manual	Long integration time setting	Manual
Audible alarm	On	Backlight brightness	High
Power-on setting	Rst	Output Mode	REAR
MAC physical address	Factory setting	IP address	172.16.131.170
Subnet mask address	255.255.255.0	Gateway Address	172.16.131.1
DNS server	172.16.131.1	IP acquisition mode	Manual
Monitoring	On	Host Name	MYHOST

S SYSTEM SETTINGS





System Information

Description The System Information menu can be used to view the system information or to perform system operations such as set the buzzer function, backlight display brightness or set to the factory conditions.

System Information Items	System Version	View the system software version.
	Serial Number	View the machine serial number.
	MAC	The physical address of the device.
	Firmware	Software version
	OS	Operating System
	FatFS	File system version

Operation Press the *Menu* key and press the arrow keys to select  icon. Press the *Enter* key to enter the System Information menu. Press the *Tab* key to select *About* item and then press the *Enter* key to view the system information.

Utility Settings

Description	There are four utility settings: Remote command data output format, power-on state setting, buzzer settings and backlight brightness settings.	
Setting Information	OutputFormat	Remote command data output format
	PowOnSetup	Power-on state setting
	Beep	Sets when the buzzer is turn on.
	BackLight	Adjust the LCD brightness.
Output Data Format for remote operation	In the System menu, OutputFormat is the default option. Use the up and down arrow keys to directly set the data format. There are four types of data formats available for selection. Exponential, 2DPS, 3DPS and 4DPS.	
Power-on settings operation	In the System menu, press the <i>Tab</i> key to select PowOnSetup. Use the up and down arrow keys to select the initial state when the instrument is powered-on.	
Buzzer Operation	In the System menu, press the <i>Tab</i> key to select to select Beep. Use the up and down arrows to directly set the buzzer.	
Backlight Brightness Adjustment	In the System menu, press the <i>Tab</i> key to select Backlight. Then use the up and down arrow keys to directly select Backlight brightness. There are three brightness levels: High, Middle, and Low.	

Restore to Factory Settings In the System menu, press the *Tab* key to select Reset, and then press the *Enter* key. A pop-up window will appear as shown on the right. Press the *Enter* key to complete this step.

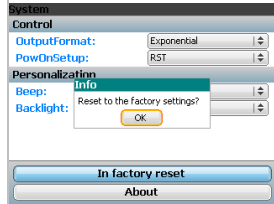







Firmware Upgrading

When to Upgrade Firmware	When system is failure, request by customer GW Instek. When the system fails, firmware can requested by GW Instek customers.
--------------------------	--

Upgrade Requirement	Firmware file	Supplied by GW Instek
	Flash drive	USB2.0/USB3.0 · FAT file system

- | | |
|-----------|---|
| Operation | <ul style="list-style-type: none">● Turn off the PPH-1503D/1506D/1510D● Press and hold the <i>Enter</i> key and then turn on the device at the same time.● Insert the flash drive within 10 seconds. The system will then be upgraded automatically. The Tab/ Lock, Rear and Output indicators will light up in sequence. Once the LCD screen turns black, the system reboots and completes the system upgrade procedure. |
|-----------|---|

System Real Time Clock Setting

Description	This setting is used to set the display of the real time clock.
Operation	<p>Press the <i>Menu</i> key and press the arrow keys  to select  icon. Press the <i>Enter</i> key to enter the setting menu.</p>
Setting	<p>When you enter the Clock menu,  press the <i>Enter</i> key to enter the parameter setting menu.</p> <p>Press the <i>Tab</i> key to select the year, month, date, day, hour and minute. </p> <p>Press the arrow keys to set the parameters. </p> <p>After setting all the time parameters,  press the <i>Enter</i> key to exit the setting.</p> <p>Press the <i>Menu</i> key to return to the Menu interface. </p>

Description of Using Flash Drive

Description It can be use when upgrading the software upgrades and importing or exporting files.

Please refer to page 72 for upgrading the firmware. Importing and exporting files is mainly used in screenshots and setting the parameter SEQUENCE. Operation step is described as follows:

Operation Insert flash driver into the USB Host port. Then the system identifies the flash driver and pops up a confirmation window. Please press *Enter* key to confirm.

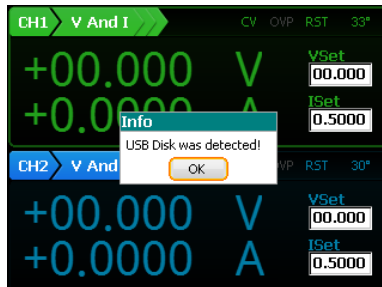

Screenshot operation

After the system identifies the flash driver, move the device interface to desired interface. Press and hold the *C/Pict* key and a window showing the screenshots successful will pop up. Press the *Enter* key to confirm. The screenshot image will be saved to the PPH-1503D(PPH-1506D/1510D) / Snapshot folder by default in the flash driver.

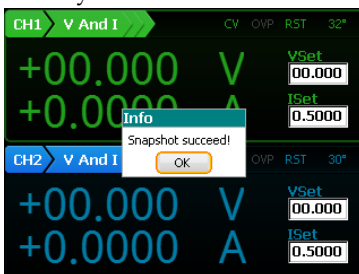

Exporting the Sequence data

1. Saving the Sequence parameter: Enter the Sequence interface and set up the parameters (see 62 for detailed operation,). When pressing the *Menu* key to exit, a window will pop up to ask whether to save the settings. You need to press *Enter* to confirm, otherwise the save operation will be canceled.

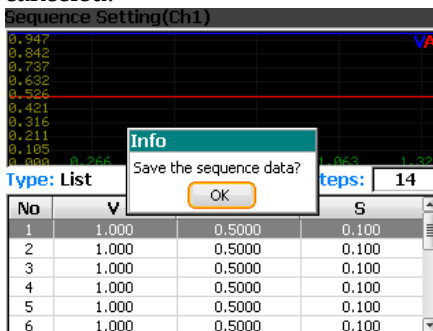

2. A. Select  in the Menu interface and then press the *Enter* key to enter the File menu. Press the *Enter* key to enter the local C: drive (default disk).



- B. Press the up and arrow keys to select the User folder in the C: drive, press the *Enter* key to enter the folder to browse. Use the arrow keys to select Sequence file. The system will show the Sequence data export confirmation window. Press Enter to confirm.

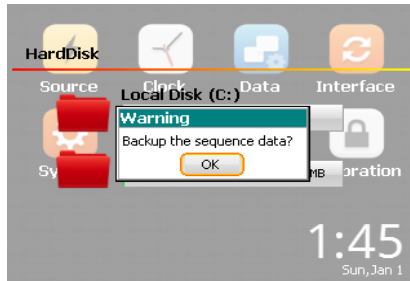

Note: In the flash drive, the default location is in the PPH-1503D(PPH-1506D/1510D) / User folder.

Importing the Sequence data

Use EXCEL to set the Sequence parameters to the following format and save to the flash drive in the computer (*.csv format).

	A	B	C	D
1	Voltage(V)	Current(A)	Time(S)	
2	1	0.5	0.1	
3	1	0.5	0.1	
4	1	0.5	0.1	
5	1	0.5	0.1	
6	1	0.5	0.1	
7	1	0.5	0.1	
8	1	0.5	0.1	
9	1	0.5	0.1	
10	1	0.5	0.1	
11	1	0.5	0.1	
12	1	0.5	0.1	
13				
14				

A. Insert the flash drive to the USB Host port on the device.

B. Enter the  interface. Press the up and down arrow keys or *Tab/Lock* key to select Removable Disk (D :). Press the *Enter* key to confirm and enter the folder to browse.



- C. Press the up and down arrow keys to select Sequence data. Press the Enter and a message asking to replace the Sequence data appears. Press the *Enter* key to confirm.

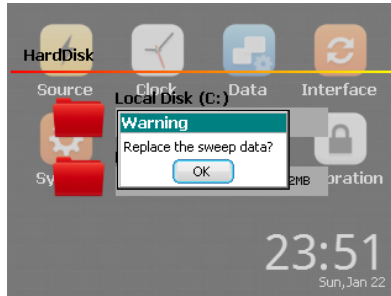

RREMOTE CONTROL

Remote Control

USB

Description	The PPH-1503D/1506D can be connected via USB using the USB Test & Measurement (TMC) class(Full Speed).
-------------	--

Interface	Rear panel USB slave port.
-----------	----------------------------

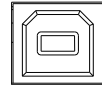

Installing the Driver	<p>Before connecting the unit to the USB port of the PC, Please use "NI Visa" (National Instruments Corporation). Connect a USB cable to send a command. If the connection is successful, the USB will be shown as the interface type on the lower left corner of the LCD display.</p>
-----------------------	--

The front panel keys are automatically locked when the unit is in remote mode.

Function Check Perform the following query:

*IDN?

The unit will return the manufacturer, model, serial number and software version.

GW INSTEK, PPH-1503D, SN: xxxxxxxx, Vx.xx

Disabling Remote Control Mode

- Send a remote command from the PC
- Long-press the unlock key on the front panel.
- Unplug the USB cable from the rear panel.



USB devices are hot-plug devices. You can directly remove the cable and exit.

GPIB

Description

The communication data format, compatibility settings and GPIB address must all be configured before using GPIB remote control.

Interface

Rear panel GPIB port.



Connection

Connect a GPIB cable to send a command. If the connection is successful, the GPIB will be shown as the interface type on the lower left corner of the LCD display.

The front panel keys are automatically locked when the unit is in remote mode.

Communication Data Format

There are four data formats to select from: Exponential, 2DPS, 3DPS and 4DPS.

Set the communication address Set the communication address for the PC to communicate with.

Steps

A. Press the *Menu* key to enter the main menu.



B. Use the left and right arrow keys to select  icon.



C. Press *Enter* to enter the Interface menu.











D. Primary Address is the default Option for GPIB interface. Use the up and down arrow keys to set the port address.



Exiting from Remote Control Mode

- Send a remote command from the PC
- Long-press the unlock key on the front panel.
- Unplug the USB cable from the rear panel.

LAN

Description	When using the LAN interface a number of settings must be turned on.	
IP Mode	The IP address can be configured using either DHCP or Manual IP. Using	
Manu IP	A. Press <i>Menu</i> to enter the main menu.	
	B. Use the left and right arrow keys to select  icon.	
	C. Press <i>Enter</i> to enter the Interface menu.	
	D. Press the <i>Tab</i> key to select the Ethernet function.	
	E. Use the up and down arrow key to select DHCP or select Manual.	
	F. If the Manual option is selected, press the <i>Tab</i> key to select specific IP parameters.	
	G. Use the number pad and C key to set the specific parameters and values.	

Parameter Settings:

IP Address: IP address range: 1.0.0.0 to 223.255.255.255 (excluding 127.nnn.nnn.nnn).

Subnet Mask: Subnet Mask Range: 1.0.0.0 to 255.255.255.255.

Gateway: Gateway range: 1.0.0.0 to 223.255.255.255 (excluding 127.nnn.nnn.nnn).

DNS Servers: DNS Server range: 1.0.0.0 to 223.255.255.255 (excluding 127.nnn.nnn.nnn).

VISA Resource name:

TCPIPO::172.16.131.170::1026::SOCKET

DHCP

Follow steps A~F in the previous section

G. Press *Enter* to select DHCP. The unit will be assigned an IP address, subnet mask, the default gateway and other network parameters from the DHCP server. The corresponding parameters will be shown in the parameter area. Use the arrow keys to view the settings (When an IP address is being assigned, a circular scanning icon will appear).

PC Operation

1. Enter the IP address into Microsoft Internet Explorer (IE). After entering the IP address you will be shown the Welcome screen which displays the instrument information. The page also provides three links: Welcome Page, Browser Web Control and View & Modify Configuration (network settings).

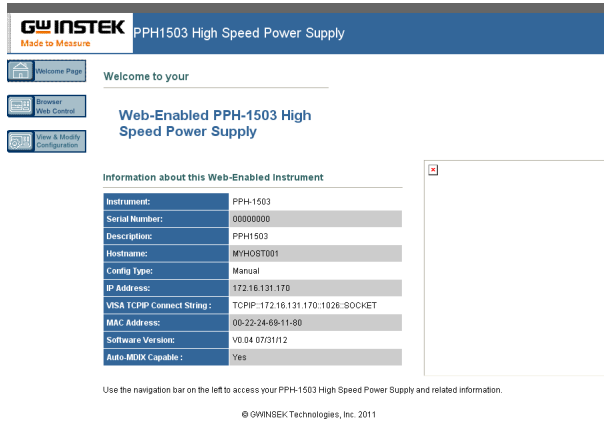

2. Click on “Browser Web Control” to execute commands through the browser, as shown below.

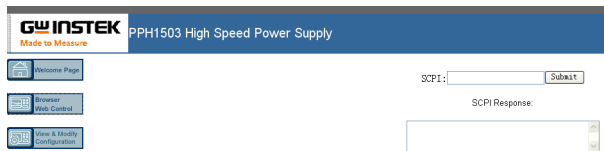

3. Press the “View & Modify Configuration” icon to enter the Modify Config menu, as shown below.

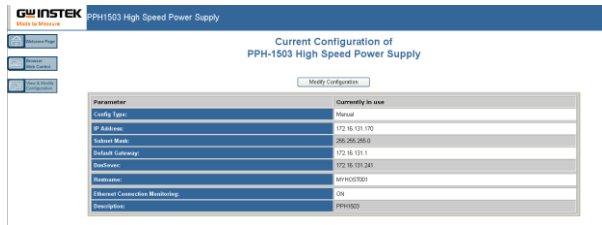

4. Click “Modify Config” to enter the network configuration setting menu, as shown below. Use the mouse to click on “Save and Restart” to change the remote settings for the PPH-1503D/1506D/1510D.

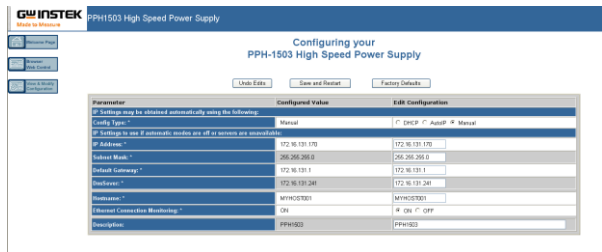

Note

Click “Undo Edits” to cancel all the edited settings. Click “Factory Defaults” to restore to the factory default settings.

Exiting from Remote Control Mode

- Send a remote command from the PC
- Long-press the unlock key on the front panel.
- Unplug the USB cable from the rear panel.



Note

Hot-swappable LAN devices can be directly disconnected to exit.

Command Syntax

The commands that are used with the PPH-1503D/1506D/1510D meet IEEE488.2 and SCPI standards.

SCPI Commands Overview SCPI

Command Format

SCPI is an ASCII based command language designed for test and measurement instruments. SCPI commands uses a hierarchical structure (tree system), and is divided into different subsystems. Each subsystem is defined by a different root keyword. Each command consists of a root keyword and one or more hierarchical key words separated by a colon ":" and followed by a parameter. There is always a space between the keywords and the parameters. Any commands followed by a question mark (?) are queries.

For Example:

```
:SYSTem:BEEPer:STATe {0|1|OFF|ON}  
:SYSTem:BEEPer:STATe?
```

SYSTem is the root level keyword and BEEPer and STATe are the secondary and tertiary level keywords. All levels have a ":" separating each keyword. Parameters are enclosed in "{ }". The commands SYSTem:BEEPer:STATe has {0 | 1 | OFF | ON } as parameters. The parameters are separated with a space. SYSTem:BEEPer:STATe? indicates that the command is a query. In addition some commands have multiple parameters that are usually separated by a comma ",". For example: :STATus:QUEue:ENABLE (-110:-222, -220).

Symbol Description

SCPI commands have the following conventional symbols. These symbols are not commands but are used to describe the command parameters.

1. Curly Brackets { }

Curly Bracket enclose command string parameters, for example:
{OFF | ON}

2. Vertical Bars |

Vertical bars are used to separate one or more optional parameters. Only one command can be selected. With the following two parameters, {ON | OFF} only ON or OFF can be selected.

3. Square Brackets []

The contents inside square brackets represent keywords or parameters that can be omitted when executing a command. For example: For the commands :OUTPut[:STATe] {ON | OFF}, [STATe] can be omitted.

4. Angle Brackets < >

The parameters in angle brackets must be substituted with a valid parameter. For example: For the command :DISPlay:CONTRast <brightness>, <brightness> must be use a numerical value instead such as, :DISPlay:CONTRast 1

Parameter Types

The commands have a number of different parameter categories. How the parameters are set depend on the parameter categories.

1. Boolean

Commands parameter that have to states "OFF" and "ON", for example, DISPLAY:FOCUS {ON | OFF}. "ON" will turn on the focus display function, while "OFF" will turn it off.

2. Consecutive Integers

Parameters that use consecutive integers, for example: For the command :DISPLAY:CONTRast <brightness>, <brightness> is an integer value with a range of 1~3.

3. Continuous Real Number

Parameter that must be a continuous real number can have any value within the effective range and accuracy. For example: The command CURRent {<current> | MINimum | MAXimum}, is used to set the current value for the current operating channel. <current> can be any value within the setting range of the current channel.

4. Discrete

For discrete parameters, only those values that are listed can be used. For example: The *RCL {0 | 1 | 2 | 3 | 4 | 5} command can only use 0, 1, 2, 3, 4, 5.

5. ASCII Strings

ASCII string parameters must use a combination of ASCII characters in a string. For example: For the command: MODE <name>, <name> must be an ASCII string.

Command Abbreviations

The syntax for SCPI commands contains a combination of upper and lower case letters. The upper case letters in a command represent the short form of that command.

Commands are not case sensitive and can be used in both upper and lower case. Note, however, to use the short form of the command, only the capital letter part of the command can be used (no other abbreviation can be used). For example:

:MEASure:CURRent?

Can be abbreviated to:

:MEAS:CURR

Command Terminators

When sending a command to the function generator, the command must be terminated with a <new line> character. The IEEE-4888 EOI can also be used as a <new line> character. A command can also be terminated using a carriage return + <new line> character. The command path will always be reset back to the root level after a command has been terminated.

Return values are terminated with 0x0A.

Command List

Measurement Instructions

:FETCh[1 2]?	Page 95
:FETCh[1 2]:ARRay?	Page 95
:READ[1 2]?	Page 96
:READ[1 2]:ARRay?	Page 96
:MEASure[1 2][:<function>]?	Page 96
:MEASure[1 2]:ARRay[:<function>]?	Page 97

Display Functions

:DISPlay:ENABle 	Page 98
:DISPlay:ENABle?	Page 98
DISPlay:BRIGhtness <NRf>	Page 98
DISPlay:BRIGhtness?	Page 98

Data Format Commands

:FORMat[:DATA] <type>	Page 99
:FORMat[:DATA]?	Page 99
:FORMat:BORDer <name>	Page 99
:FORMat:BORDer?	Page 99

Output Commands

:OUTPut[1 2][:STATe] 	Page 100
:OUTPut[1 2] [:STATe]?	Page 100
:BOTHOUTON	Page 100
:BOTHOUTOFF	Page 100
:ROUTE:TERMinals {FRONT REAR}	Page 100

:ROUte:TERMI:nals?	Page 101
:OUTPut[1 2]:RELAy <name>	Page 101
:OUTPut[1 2]:RELAy?	Page 101
:OUTPut[1 2]:OVP:STATe 	Page 101
:OUTPut[1 2]:OVP:STATe?	Page 102
:OUTPut[1 2]:OVP <value>	Page 102
:OUTPut[1 2]:OVP?	Page 102

Source Commands

:[SOURce[1 2]]:CURRent[:LIMit][:VALue] <NRf>	Page 102
:[SOURce[1 2]]:CURRent[:LIMit][:VALue]?	Page 102
:[SOURce[1 2]]:CURRent[:LIMit]:TYPE <name>	Page 103
:[SOURce[1 2]]:CURRent[:LIMit]:TYPE?	Page 103
:[SOURce[1 2]]:CURRent[:LIMit]:STATe?	Page 103
:[SOURce[1 2]]:VOLTage[:LEVel][:IMMediate][:AMPLitude] <NRf>	Page 103
:[SOURce[1 2]]:VOLTage[:LEVel][:IMMediate][:AMPLitude]?	Page 104
:[SOURce]:RESistance[:LEVel][:IMMediate][:AMPLitude] <NRf>	Page 104
:[SOURce]:RESistance[:LEVel][:IMMediate][:AMPLitude]?	Page 104

Readback Commands

:SENSe[1 2]:FUNCTio:n <name>	Page 104
:SENSe[1 2]:FUNCTio:n?	Page 105
:SENSe[1 2]:NPLCycles <n>	Page 105
:SENSe[1 2]:NPLCycles?	Page 105
:SENSe[1 2]:AVERAge <NRf>	Page 106
:SENSe[1 2]:AVERAge?	Page 107
:SENSe[1]:CURRent[:DC]:RANGe[:UPPer] <n>	Page 107
:SENSe2:CURRent[:DC]:RANGe[:UPPer] <n>	Page 107

:SENSe[1 2]:CURRent[:DC]:RANGe[:UPPer]?	Page 107
:SENSe[1 2]:CURRent[:DC]:RANGe:AUTO 	Page 108
:SENSe[1 2]:CURRent[:DC]:RANGe:AUTO?	Page 108
:SENSe[1 2]:PCURrent:AVERAge <NRF>	Page 108
:SENSe[1 2]:PCURrent:AVERAge?	Page 108
:SENSe[1 2]:PCURrent:MODE <name>	Page 108
:SENSe[1 2]:PCURrent:MODE?	Page 109
:SENSe[1 2]:PCURrent:TIME:AUTO	Page 109
:SENSe[1 2]:PCURrent:TIME:HIGH <NRF>	Page 109
:SENSe[1 2]:PCURrent:TIME:HIGH?	Page 110
:SENSe[1 2]:PCURrent:TIME:LOW <NRF>	Page 110
:SENSe[1 2]:PCURrent:TIME:LOW?	Page 110
:SENSe[1 2]:PCURrent:TIME:AVERAge <NRF>	Page 111
:SENSe[1 2]:PCURrent:TIME:AVERAge?	Page 111
:SENSe[1 2]:PCURrent:SYNChronize[:STATe] 	Page 111
:SENSe[1 2]:PCURrent:SYNChronize[:STATe]?	Page 112
:SENSe[1 2]:PCURrent:SYNChronize:DELay <NRF>	Page 112
:SENSe[1 2]:PCURrent:SYNChronize:DELay?	Page 112
:SENSe[1 2]:PCURrent:SYNChronize:TLEVel<NRF>	Page 112
:SENSe[1 2]:PCURrent:SYNChronize:TLEVel?	Page 112
:SENSe[1 2]:LINTegration:TIME <NRF>	Page 113
:SENSe[1 2]:LINTegration:TIME?	Page 113
:SENSe[1 2]:LINTegration:TIME:AUTO	Page 113
:SENSe[1 2]:LINTegration:TLEVel <NRF>	Page 113
:SENSe[1 2]:LINTegration:TLEVel?	Page 114
:SENSe[1 2]:LINTegration:TEDGe <name>	Page 114
:SENSe[1 2]:LINTegration:TEDGe?	Page 114
:SENSe[1 2]:LINTegration:TimeOUT <NRF>	Page 114
:SENSe[1 2]:LINTegration:TimeOUT?	Page 114

:SENSe[1 2]:LINTegration:SEARCh 	Page 115
:SENSe[1 2]:LINTegration:SEARCh?	Page 115
:SENSe[1 2]:LINTegration:FAST 	Page 115
:SENSe[1 2]:LINTegration:FAST?	Page 115

Status Commands

:STATus:PRESet	Page 116
:STATus:OPERation[:EVENT]?	Page 116
:STATus:OPERation:CONDition?	Page 116
:STATus:OPERation:ENABLE <NRf>	Page 116
:STATus:OPERation:ENABLE?	Page 117
:STATus:MEASurement[:EVENT]?	Page 117
:STATus:MEASurement:ENABLE <NRf>	Page 117
:STATus:MEASurement:ENABLE?	Page 118
:STATus:MEASurement:CONDition?	Page 118
:STATus:QUEStionable[:EVENT]?	Page 118
:STATus:QUEStionable:CONDition?	Page 118
:STATus:QUEStionable:ENABLE <NRf>	Page 118
:STATus:QUEStionable:ENABLE?	Page 119
:STATus:QUEue[:NEXT]?	Page 119
:STATus:QUEue:ENABLE <list>	Page 119
:STATus:QUEue:ENABLE?	Page 120
:STATus:QUEue:DISable <list>	Page 120
:STATus:QUEue:DISable?	Page 120
:STATus:QUEue:CLEar	Page 120

System Commands

:SYSTem:VERSion?	Page 121
:SYSTem:ERRor?	Page 121

:SYSTem:CLEar	Page 121
:SYSTem:LFRequency?	Page 121
:SYSTem:POSetup <name>	Page 121
:SYSTem:POSetup?	Page 122
:SYSTem:COMMunicate:LAN:DHCP[:STATe] 	Page 122
:SYSTem:COMMunicate:LAN:DHCP[:STATe]?	Page 123
:SYSTem:COMMunicate:LAN:IPADdress <IP address>	Page 123
:SYSTem:COMMunicate:LAN:IPADdress?	Page 123
:SYSTem:COMMunicate:LAN:SMASk <Mask>	Page 124
:SYSTem:COMMunicate:LAN:SMASk?	Page 124
:SYSTem:COMMunicate:LAN:GATEway <IP address>	Page 124
:SYSTem:COMMunicate:LAN:GATEway?	Page 124
:SYSTem:COMMunicate:LAN:DNS <Address>	Page 125
:SYSTem:COMMunicate:LAN:DNS?	Page 125
:SYSTem:COMMunicate:LAN:MANualip[:STATe] 	Page 125
:SYSTem:COMMunicate:LAN:MANualip[:STATe]?	Page 125
:SYSTem:COMMunicate:LAN:APPLy	Page 126
:SYSTem:REMOte	Page 126
:SYSTem:BEEPer:STATe {0 1 OFF ON}	Page 126
:SYSTem:BEEPer:STATe?	Page 126
:SYSTem:LOCal	Page 126

System Related Commands

*IDN?	Page 127
*RST	Page 127
*TST?	Page 127
*WAI	Page 128
*TRG	Page 128
*SAV <NRf>	Page 128

*RCL <Nrf> Page 128

IEEE488.2 Common Commands

*SRE <Enable Values> Page 135

*SRE? Page 135

*STB? Page 135

*ESE<Enable Value> Page 136

*ESE? Page 136

*ESR? Page 136

*CLS Page 137

*OPC Page 137

*OPC? Page 137

Command Details

When using commands to select a specific channel, [1] stands for CH1, [2] stands for CH2. "1" can be omitted when you want to select CH1 as it is selected by default. However if you wish to select CH2, "2" must be selected.

Measurement Commands

Command :FETCh[1 | 2]?

Function Returns the last readback value.

Response Time Maximum: 16ms.

Example :FETCh2?

Returns the last readback value on CH2.

Command :FETCh:ARRay[1 | 2]?

Function Returns the last array readback values.

Response Time Maxium: 16ms

Example	:FETCh:ARRay2? Returns the last array readback values on CH2.
Command	:READ[1 2]?
Function	Triggers a read operation and returns the read values.
Response time	Maximum: 32ms
Example	:READ2? Triggers a read operation and returns the read values on CH2.
Command	:READ:ARRay[1 2]?
Function	Triggers a new array. Returns the read array values.
Response time	Max: 32ms
Example	:READ:ARRay2? Triggers a new array and returns the read array values on CH2.
Command	:MEASure[1 2] [;<function>]?
Function	Performs a "READ?" query on the specified measurement function.
Description	<function> CURRent[:DC]:Measures the current. VOLTage[:DC]:Measures the voltage. PCURrent:Measures the pulse current. DVMeter:Measures the DVM input. LINTegration:Long integration current measurement.

	For pulse current and long integration current measurement, if there is no pulse, test for the timeout time.
Response time	Maximum: 32ms
Example	:MEASure2: CURRent? Sets pulse current as the measurement type to CH2 and reads back the pulse current value.
Command	:MEASure[1 2]:ARRay[:<function>]?
Function	Performs a "READ:ARRay?" query on the specified measurement function.
Description	<function> CURRent[:DC]: Measures the current. VOLTage[:DC]: Measures the voltage. PCURrent: Measures the pulse current. DVMeter: Measures the DMV input. LINTegration: Long integration current measurement For pulse current and long integration current measurement, if there is no pulse, test for the timeout time.
Response time	Maximum: 32ms
Example	:MEASure2:ARRay:PCURrent? Sets the measurement type to pulse current array measurement on CH2 and returns the read array value.

Display Commands

Command	:DISPlay:ENABle
Function	Turn the LCD display on or off.
Description	b 0/OFF: Turns the display off. 1/ON: Turns the display on.
Example	:DISPlay:ENABle ON Turns the LCD display on.
Command	:DISPlay:ENABle?
Function	Queries the state of the display.
Example	:DISPlay:ENABle? Returns the state of the display.
Command	DISPlay:BRIGhtness < NRf >
Function	Sets backlight display brightness.
Description	<NRf> 0.33~0.00:Weak 0.66~0.34:Medium 1.00~0.67:Strong
Example	DISPlay: BRIGhtness 0.33 Sets the backlight to weak.
Command	DISPlay: BRIGhtness?
Function	Queries the brightness of the display.
Example	DISPlay: BRIGhtness? Returns the brightness of the display.

Data Format Commands

Command	:FORMat[:DATA] <type>
Function	Sets the data format.
Description	<type> ASCii:ASCII format. SREal:IEEE754 single precision format. DREal:IEEE754 double precision format.

Example :FORMat:DATA SREal
 Sets the format to IEEE754 double precision format.

Command	:FORMat[:DATA]?
Function	Queries the data format.

Example :FORMat:DATA?
 Returns the data format.

Command	:FORMat:BORDER <name>
Function	Sets the byte order.
Description	name NORMal: normal binary byte order. SWAPped: reverse binary byte order.

Example :FORMat:BORDER NORMal
 Set the data format to the "Normal" binary byte order.

Command	:FORMat:BORDER?
Function	Queries the binary byte order.

Example :FORMat:BORDER?
 Returns the binary byte order.

Output Commands

Command	:OUTPut[1 2][:STATe]
Function	Turns the output on or off.
Description	 0/OFF: Turn off the output 1/ON: Turn on the output

Example	:OUTPut:STATe ON Turns on the output. of CH1
---------	---

Command	:OUTPut[1 2][:STATe]?
Function	Queries the output state.

Example	:OUTPut:STATe? Returns the output state of CH1.
---------	--

Command	BOTHOUTON
Function	Turns the channels output on

Example	BOTHOUTON Turns the channels output on
---------	---

Command	BOTHOUTOFF
Function	Turns the channels output off.

Example	BOTHOUTOFF Turns the channels output off.
---------	--

Command	:ROUte:TERMinals {FRONt REAR}
Function	Toggle the output from the front or rear panel.

Description	FRONT: Set the output to the front panel REAR: Set the output to the rear panel
Example	:ROUTe:TERMinals FRONT Sets the output to the front panel
Command	:ROUTe:TERMinals?
Function	Queries the output status of the panel.
Example	:ROUTe:TERMinals? Queries the output status of the panel.
Command	:OUTPut[1 2]:RELAy <name>
Function	Turns the external relay control signal on or off.
Description	<name> ZERO:Off ONE:On
Example	:OUTPut2:RELAy ONE Turn on the external relay signal of CH2.
Command	:OUTPut[1 2]:RELAy?
Function	Queries the state of the output relay.
Example	:OUTPut2:RELAy? Returns the state of the output relay on CH2.
Command	:OUTPut[1 2]:OVP:STATe
Function	Turns OVP protection on/off
Description	 0/OFF:Turns OVP off. 1/ON:Turns OVP on.
Example	:OUTPut2:OVP:STATe ON Turn on OVP on CH2.

Command	:OUTPut[1 2]:OVP:STATe?
Function	Queries the status of the OVP function.
Example	:OUTPut2:OVP:STATe? Returns the status of the OVP function on CH2.

Command	:OUTPut[1 2]:OVP <value>
Function	Sets the OVP level.
Description	<value> 1.00-15.00
Example	:OUTPut2:OVP 10.05 Sets the OVP voltage to 10.05V for CH2.

Command	:OUTPut[1 2]:OVP?
Function	Queries the OVP voltage level.
Example	:OUTPut2:OVP? Queries the OVP voltage level on CH2.

Source Commands

Command	:[:SOURce[1 2]]:CURRent[:LIMit][:VALue] <NRf>
Function	Sets the current level.
Description	<NRf> 0.0000-5.0000
Example	:SOURce2:CURRent 1.0005 Sets the current level to 1.0005A for CH2.

Command	:[:SOURce[1 2]]:CURRent[:LIMit][:VALue]?
Description	Queries the current limit level.
Example	:SOURce2:CURRent? Queries the current limit level on CH2.

Command	: [SOURce[1 2]]:CURRent[:LIMit]:TYPE <name>
Function	Sets the current limit mode.
Description	<name> LIMit: General limiting mode TRIP: Output shutdown mode LIMRELAY LIMITRELAY: General limiting mode and external relay output control mode. TRIPRELAY: Output shutdown mode and external relay output control mode.
Example	: SOURce2:CURRent:TYPE LIMITRELAY Sets the current limit mode to LIMITRELAY and the external relay control for CH2.
Command	: [SOURce[1 2]]:CURRent[:LIMit]:TYPE?
Function	Queries the current limiting mode.
Example	: SOURce2:CURRent:TYPE? Queries the current limiting mode of CH2.
Command	: [SOURce[1 2]]:CURRent[:LIMit]:STATe?
Function	Queries the current limit state. Returns 0 if the current limit has not been reached, returns 1 if the current limit has been reached.
Example	: SOURce2:CURRent:STATe? Queries the current limit state of CH2.
Command	: [SOURce[1 2]]:VOLTage[:LEVel][:IMMEDIATE][:AMPLitude] < NRf >
Function	Sets the output voltage amplitude.
Description	<NRf> 0.000-15.000

Example	:SOURce2:VOLTage 5.321 Sets the output voltage to 5.321V for CH2.
Command	:[SOURce[1 2]]:VOLTage[:LEVel][:IMMediate] [:AMPLitude]?
Function	Queries the output voltage setting.
Example	:SOURce2:VOLTage? Queries the output voltage setting on CH2.
Command	:[SOURce]:RESistance[:LEVel][:IMMediate][:AMP Litude] < NRf >
Function	Set the resistance value
Description	NRf 000-1.000
Example	:SOURce: RESistance 1.000 Set the resistance value
Command	:[SOURce]:RESistance[:LEVel][:IMMediate][:AMP Litude]?
Function	Queries the setting resistance value.
Example	:SOURce: RESistance? Queries the setting resistance value and returns the readback value.

Readback Commands

Command	:SENSE[1 2]:FUNCTION <name>
Function	Selects the type of measurement function: voltage, current, pulse, long integration and DVM measurement.





Description	name	<p>“VOLTage”: Voltage measurement.</p> <p>“CURRent”: Current measurement.</p> <p>“PCURrent”: Pulse current measurement.</p> <p>“LINTegration”: Long integration measurement.</p> <p>“DVMeter”: DVM input measurement.</p>
Example	:SENSe2:FUNcTION	“VOLTage”
		Selects “Voltage” as the measurement type for CH2.
Command	:SENSe[1 2]:FUNcTION?	
Function		Queries the type of measurement function.
Response time		Maximum: 16ms
Example	:SENSe2:FUNcTION?	
		Returns the type of measurement function on CH2.
Command	:SENSe[1 2]:NPLCycles <n>	
Function		Sets the number of PLCs for the integration rate for voltage, current and DVM measurements.
Description	<n>	0.01-10.00
Example	:SENSe2:NPLCycles 0.10	
		Sets the number of PLCs to 0.1 for CH2.
Command	:SENSe[1 2]:NPLCycles?	
Function		Returns the number of power line cycles used for the integration rate.
Example	:SENSe2:NPLCycles?	
		Queries the integration rate on CH2.

Command	:SENSe[1 2]:AVERAge <NRf>
Function	Sets the averaging number for the voltage, current and DVM measurements.
Description	<NRf> 1-10
Example	:SENSe2:AVERAge 3 Sets the averaging number to 3 for CH2.

Command	:SENSe[1 2]:AVERAge?
Function	Queries the averaging number for the voltage, current and DVM measurements.
Example	:SENSe2:AVERAge? Queries the averaging number for the voltage, current and DVM measurements on CH2.
Command	:SENSe[1]:CURRent[:DC]:RANGe[:UPPer] <n>
Function	Sets the current measurement range.
Description	<n> MIN(<=0.005): 5mA range MID(0.005<=?<=0.5): 500mA range MAX(>0.5) : 5A range
Example	:SENSe:CURRent:RANGe0.5 Sets the current range to middle range for CH1.
Command	:SENSe2:CURRent[:DC]:RANGe[:UPPer] <n>
Function	Sets the current measurement range.
Description	n MIN(<=0.005): 5mA range MAX(>0.005) : 1.5A or 3.0A range
Example	:SENSe2:CURRent:RANGe MIN Sets the current range to small range for CH2.
Command	:SENSe[1 2]:CURRent[:DC]:RANGe[:UPPer]?
Function	Queries the current measurement range
Description	When device is in "AUTO" setting, the returned value is the actual range (MAX or MIN), rather than "AUTO".
Example	:SENSe2:CURRent:RANGe? Queries the current measurement range on CH2.

Command	:SENSe[1 2]:CURRent[:DC]:RANGe:AUTO
Function	Turns the automatic range function on or off.
Description	 0/OFF: Turn off. 1/ON: Turn on.
Example	:SENSe2:CURRent:RANGe:AUTO ON Turns on the automatic range function on CH2.
Command	:SENSe[1 2]:CURRent[:DC]:RANGe:AUTO?
Function	Queries the state of the automatic range function.
Example	:SENSe2:CURRent:RANGe:AUTO? Queries the status of the automatic range function on CH2.
Command	:SENSe[1 2]:PCURRent:AVERAge <NRf>
Function	Sets the averaging number for pulse current measurements.
Description	NRf 1-100 or 1-5000(pulse current digitization)
Example	:SENSe2:PCURRent:AVERAge 5 Sets the average number to 5 for CH2.
Command	:SENSe[1 2]:PCURRent:AVERAge?
Function	Queries the average number for pulse current measurement.
Example	:SENSe2:PCURRent:AVERAge? Queries the setting average number on CH2.
Command	:SENSe[1 2]:PCURRent:MODE <name>
Function	Sets the pulse current measurement mode.

Description	Name	HIGH: High pulse mode (trigger on the rising edge). LOW: Low pulse mode (trigger on the falling edge) AVERAge: Average pulse measurement.
Example	:SENSe2:PCURrent:MODE HIGH	Sets the pulse current measurement mode to HIGH mode for CH2.
Command	:SENSe[1 2]:PCURrent:MODE?	
Function	Queries the pulse current measurement mode.	
Example	:SENSe2:PCURrent:MODE?	Queries the pulse current measurement mode on CH2.
Command	:SENSe[1 2]:PCURrent:TIME:AUTO	
Function	Sets the pulse current integration time to automatic.	
Example	:SENSe2:PCURrent:TIME:AUTO	Sets the pulse current integration time to automatic for CH2.
Command	:SENSe[1 2]:PCURrent:TIME:HIGH <NRf>	
Function	Sets the integration time for high pulse measurement.	
Description	<NRf>	33.3~ 833333, Step resolution of 33.3.
Example	:SENSe2:PCURrent:TIME:HIGH 0.000233	Sets the integration time for high pulse measurement to 233uS on CH2.

 Note	IntTime setting is automatically changed to 33.3 us in Pulse current digitization mode.
Command	:SENSe[1 2]:PCURrent:TIME:HIGH?
Function	Queries integration time for high pulse measurement.
Example	:SENSe2:PCURrent:TIME:HIGH? Queries the integration time for high pulses on CH2.
 Note	IntTime setting is automatically changed to 33.3 us in Pulse current digitization mode.
Command	:SENSe[1 2]:PCURrent:TIME:LOW <NRf>
Function	Sets the integration time for low pulse measurement.
Description	<NRf> 33.3-833333, Step resolution of 33.3
Example	:SENSe2:PCURrent:TIME:LOW 0.000233 Sets the integration time for low pulse measurement to 233us for CH2.
 Note	IntTime setting is automatically changed to 33.3 us in Pulse current digitization mode.
Command	:SENSe[1 2]:PCURrent:TIME:LOW?
Function	Queries the integration time for low pulse measurement.
Example	:SENSe2:PCURrent:TIME:LOW? Queries the integration time for low pulse measurement on CH2.
 Note	IntTime setting is automatically changed to 33.3 us in Pulse current digitization mode.

Command :SENSe[1 | 2]:PCURrent:TIME:AVERAge <NRf>

Function Sets the integration time for the average pulse measurement.

Description NRf 33-833333, step resolution of 33.3

Example :SENSe2:PCURrent:TIME:AVERAge 0.000233

Sets the integration time for average pulse measurement to 233 microseconds for CH2.



Note

IntTime setting is automatically changed to 33.3 us in Pulse current digitization mode.

Command :SENSe[1 | 2]:PCURrent:TIME:AVERAge?

Function Queries the integration time for the average measurement.

Example :SENSe2:PCURrent:TIME:AVERAge?

Queries the integration time for the average measurement on CH2.



Note

IntTime setting is automatically changed to 33.3 us in Pulse current digitization mode

Command :SENSe[1 | 2]:PCURrent:SYNChronize[:STATe]

Function Sets the triggering option for pulse current measurement.

Description 0 /OFF: Digital trigger mode.
1/ON: Pulse level trigger mode.

Example :SENSe2:PCURrent:SYNChronize ON

The trigger mode is set to the pulse level trigger on CH2.



Note

Pulse current digitization: under remote control, the number of data batches that will be read can be set between 1 and 5000. Please refer to command :SENSe[1|2]:PCURrent:AVERAge <NRf>

Command	:SENSe[1 2]:PCURrent:SYNChronize[:STATe]?
Function	Queries the pulse current measurement triggering option.
Example	:SENSe2:PCURrent:SYNChronize? Queries the pulse current trigger option on CH2.
Command	:SENSe[1 2]:PCURrent:SYNChronize:DELAy <NRf>
Function	Sets the trigger delay time.
Description	<NRf> 0~0.1 or 0~5 (Pulse current digitization)
Example	:SENSe2:PCURrent:SYNChronize:DELAy 0.05 Sets the trigger delay time to 0.05 seconds for CH2.
Command	:SENSe[1 2]:PCURrent:SYNChronize:DELAy?
Function	Queries the trigger delay time.
Example	:SENSe2:PCURrent:SYNChronize:DELAy? Queries the trigger delay time on CH2.
Command	:SENSe[1 2]:PCURrent:SYNChronize:TLEVel<NRf>
Function	Sets the trigger level.
Description	<NRf> 0.000-5.000
Example	:SENSe2:PCURrent:SYNChronize:TLEVel 1 Sets the trigger level to 1.000A for CH2.
Command	:SENSe[1 2]:PCURrent:SYNChronize:TLEVel?
Function	Queries the trigger level.

Example :SENSe2:PCURrent:SYNChronize:TLEVel?
 Queries the trigger level on CH2.

Command :SENSe[1 | 2]:LINTegration:TIME <NRf>

Function Sets the long integration time.

Description <NRf> (power line frequency: X=0.84~60.0000 for 50Hz. Resolution is 20mS; X=0.850~60.000 for 60Hz. Resolution is 16.7mS)

Example :SENSe2:LINTegration:TIME 1.2
 Sets the long integration time to 1.2S for CH2.

Command :SENSe[1 | 2]:LINTegration:TIME?

Function Queries the long integration time.

Example :SENSe2:LINTegration:TIME?
 Queries the long integration time on CH2.

Command :SENSe[1 | 2]:LINTegration:TIME:AUTO

Function Sets the long integration time to the auto setting.

Example :SENSe2:LINTegration:TIME:AUTO
 Sets the long integration time to the auto setting for CH2.

Command :SENSe[1 | 2]:LINTegration:TLEVel <NRf>

Function Sets the long integration trigger level.

Description <NRf> 0.000-5.000

Example :SENSe2:LINTegration:TLEVel 1.2
 Sets the long integration trigger level to 1.2A for CH2.

Command	:SENSe[1 2]:LINTegration:TLEVel?
Function	Queries the long integration trigger level setting.
Example	:SENSe2:LINTegration:TLEVel? Queries the long integration trigger level on CH2.
Command	:SENSe[1 2]:LINTegration:TEDGE <name>
Function	Sets the long integration triggering edge.
Description	<name> RISING: Rising triggering edge. FALLING: Falling triggering edge. NEITHER: No triggering edge.
Example	:SENSe2:LINTegration:TEDGE RISING Sets long integration triggering edge to rising edge for CH2.
Command	:SENSe[1 2]:LINTegration:TEDGE?
Function	Queries the long integration triggering edge.
Example	:SENSe2:LINTegration:TEDGE? Queries the long integration triggering edge on CH2.
Command	:SENSe[1 2]:LINTegration:TimeOUT <NRf>
Function	Sets the timeout time for the long integration measurement.
Description	<NRf> 1-63
Example	:SENSe2:LINTegration:TimeOUT 2 Sets the timeout time to 2 seconds for CH2.
Command	:SENSe[1 2]:LINTegration:TimeOUT?
Function	Queries the timeout time.

Example	:SENSe2:LINTEgration:TimeOUT? Queries the timeout time on CH2.
Command	:SENSe[1 2]:LINTegration:SEARCh
Function	Turns the long integration pulse measurement search function on or off.
Description	 0/OFF: Disable 1/ON: Enable

Example	:SENSe2:LINTegration:SEARCh ON Turns on the search function of CH2.
Command	:SENSe[1 2]:LINTegration:SEARCh?
Function	Queries the long integration search function state.

Example	:SENSe2:LINTegration:SEARCh? Queries the long integration search function state on CH2.
Command	:SENSe[1 2]:LINTegration:FAST
Function	Enable or disable the long integration fast measurement mode.
Description	 0/OFF: Disable 1/ON: Enable

Example	:SENSe2:LINTegration:FAST ON Enables the long integration fast measurement mode on CH2.
Command	:SENSe[1 2]:LINTegration:FAST?
Function	Query the state of the long integration fast measurement mode.

Example :SENSe2:LINtegration:FAST?
 Query the state of the long integration fast measurement mode on CH2.

Status Commands

Command :STATus:PRESet
 Function Clears the operation event enable registers, the measurement event enable registers and the questionable event register, The unit will then return to the default settings status.

Example :STATus:PRESet

Command :STATus:OPERation[:EVENT]?
 Function Read the operation event register.

Example :STATus:OPERation?
 Reads the operation event register.

Command :STATus:OPERation:CONDition?
 Function Read the operation condition status register.

Example :STATus:OPERation:CONDition?
 Read the contents of the operation condition status register.

Command :STATus:OPERation:ENABLE <NRf>
 Function Programs the operation enable status register.
 Description <NRf> 8: CL (Current enable bit).
 16: CLT (Current limit tripped enable bit).
 64: PSS (Power supply shutdown enable bit).

Example	:STATus:OPERation:ENABLE 64 Enable the power supply shutdown bit.
Command	:STATus:OPERation:ENABLE?
Function	Read the operation enable status register.

Example	:STATus:OPERation:ENABLE? Read the contents of the operation enable status register.
Command	:STATus:MEASurement[:EVENT]?
Function	Reads the measurement event status register.

Example	:STATus:MEASurement? Reads the contents of the measurement event status register.
Command	:STATus:MEASurement:ENABLE <NRf>
Function	Program the measurement enable status register.
Description	<NRf> 8: ROF (reading overflow enable bit). 16: PTT (pulse trigger timeout enable bit). 32: RAV (Reading available enable bit). 512: Buffer full enable bit. The register is 16 bits. If <value> is between 512 and 1,023, it is certainly valid. If <value> is between 1,024 and 65,535, ensure Cal (bit8) is a valid value for it to work.

Example	:STATus:MEASurement:ENABLE 8 Enables the ROF bit.
---------	--

Command	:STATus:MEASurement:ENABLE?
Function	Read the measurement enable status register.
Example	:STATus:MEASurement:ENABLE? Read the contents of the measurement enable status register.
Command	:STATus:MEASurement:CONDition?
Function	Read the measurement condition status register.
Example	:STATus:MEASurement:CONDition? Read the contents of the measurement condition status register.
Command	:STATus:QUEStionable[:EVENT]?
Function	Read the questionable event status register.
Example	:STATus:QUEStionable? Read the questionable event status register.
Command	:STATus:QUEStionable:CONDition?
Function	Read the questionable condition status register.
Example	:STATus:QUEStionable:CONDition? Read the questionable condition status register.
Command	:STATus:QUEStionable:ENABle <NRf>
Function	Programs the questionable enable status register.
Description	<NRf> 256: CAL (Calibration summary enable bit). Register is 16 bits. If <value> is between 256 and 511, it is certainly valid. If <value> is between 512 and 65,535, ensure Cal (bit8) is a valid value.

Example	:STATus:QUESTionable:ENABle 256 Sets the CAL bit.
Command	:STATus:QUESTionable:ENABle?
Function	Read the questionable enable status register.
Example	:STATus:QUESTionable:ENABle? Read the contents of the questionable enable status register.
Command	:STATus:QUEue[:NEXT]?
Function	Read the next message in the error queue.
Example	:STATus:QUEue? Read the next error message.
Command	:STATus:QUEue:ENABle <list>
Function	Specifies which error and status messages get enabled for the error queue.
Description	<list> (-440:+900): Full range error messages. (-110): Single error message. (-110:-222): A specific range of error messages. (-110:-222, -220): A specific range of error messages and a single error message (separated by a comma).
Example	:STATus:QUEue:ENABle (-110:-222) Enables error messages that are between error message -100 and -222.

Command	:STATus:QUEue:ENABLE?
Function	Read the error and status messages that have been enabled.
Example	:STATus:QUEue:ENABLE? Returns the contents of the enabled error and status messages.
Command	:STATus:QUEue:DISable <list>
Function	Specifies which messages will not be placed in the error queue.
Description	<list> (-440:+900): Full range error messages. (-110): Single error message. (-110:-222): A specific range of error messages. (-110:-222, -220): A specific range of error messages and a single error message (separated by a comma.).
Example	:STATus:QUEue:DISable (-110:-222) The error messages in the range of -110 to -222 will not appear in the error queue.
Command	:STATus:QUEue:DISable?
Function	Reads the disabled messages.
Example	:STATus:QUEue:DISable? Returns the disabled messages.
Command	:STATus:QUEue:CLEar
Function	Empty all the messages from the error queue.
Example	:STATus:QUEue:CLEar Empty all the messages from the error queue.

System Commands

Command	:SYSTem:VERSion?
Function	Query the SCPI version.
Example	:SYSTem:VERSion? Query the SCPI version.
Command	:SYSTem:ERRor?
Function	Read and clear the last error and from the error queue.
Example	:SYSTem:ERRor? Read and clear the last error and from the error queue.
Command	:SYSTem:CLEar
Function	Clear the error messages.
Example	:SYSTem:CLEar Clears the error queue.
Command	:SYSTem:LFRequency?
Function	Queries the power line frequency.
Example	:SYSTem:LFRequency? Queries the power line frequency.
Command	:SYSTem:POSetup <name>
Function	Set the power on configuration.
Description	<name> RST: Machine default settings. SAV0: User settings stored in memory location 0 (output off). SAV1: User settings stored in memory location 1 (output off).

SAV2: User settings stored in memory location 2 (output off).

SAV3: User settings stored in memory location 3 (output off).

SAV4: User settings stored in memory location 4 (output off).

SAV5: User settings stored in memory location 5.

SAV6: User settings stored in memory location 6.

SAV7: User settings stored in memory location 7.

SAV8: User settings stored in memory location 8.

SAV9: User settings stored in memory location 9.

Example	:SYSTem:POSetup SAV0 Set the power on configuration to SAV0.
Command	:SYSTem:POSetup?
Function	Query the power on configuration.
Example	:SYSTem:POSetup? Query the power on configuration.
Command	:SYSTem:COMMunicate:LAN:DHCP[:STATe]
Function	Sets the DHCP state on or off.
Description	 0/OFF: DHCP off 1/ON:DHCP on

Note: The :SYSTem:COMMunicate:LAN:APPLY command must be executed before the DHCP settings can take effect.

Example	:SYSTem:COMMunicate:LAN:DHCP ON Enable DHCP.
Command	:SYSTem:COMMunicate:LAN:DHCP[:STATe]?
Function	Query the DHCP status.

Example	:SYSTem:COMMunicate:LAN:DHCP? Query the DHCP state.
Command	:SYSTem:COMMunicate:LAN:IPADdress <IPaddress>
Function	Sets the IP address.
Description	<IP address> ASCII string, within the range of 1.0.0.0 to 223.255.255.255 (excluding 127.nnn.nnn.nnn). Note: This command is only applicable if for the manual IP mode. The SYSTem:COMMunicate:LAN:APPLY command needs to executed before the IP address settings can take effect.

Example	:SYSTem:COMMunicate:LAN:IPADdress 172.131.161.152 Sets the IP address to 172.131.161.152.
Command	:SYSTem:COMMunicate:LAN:IPADdress?
Function	Queries the IP address.

Example	:SYSTem:COMMunicate:LAN:IPADdress? Queries the IP address.
---------	---

Command :SYSTem:COMMunicate:LAN:SMASK <mask>
 Function Sets the subnet mask.
 Description <mask> ASCII string, within the range of 1.0.0.0 to 255.255.255.255.
 The SYSTem:COMMunicate:LAN:APPLY command needs to be executed before the subnet mask setting can take effect.

Example :SYSTem:COMM:LAN:SMAS 255.255.255.0
 Sets the subnet mask to 255.255.255.0.

Command :SYSTem:COMMunicate:LAN:SMASK?
 Function Query the subnet mask.

Example :SYSTem:COMMunicate:LAN:SMASK?
 Query the subnet mask.

Command :SYSTem:COMMunicate:LAN:GATEway <IPaddress>
 Function Sets the gateway IP address.
 Description <IP address> ASCII string, within the range of 1.0.0.0 to 223.255.255.255 (excluding 127.nnn.nnn.nnn).
 The SYSTem:COMMunicate:LAN:APPLY command needs to be executed before the gateway IP address setting can take effect.

Example :SYSTem:COMMunicate:LAN:GATEway 172.16.3.1
 Sets the gateway IP to 172.16.3.1.

Command :SYSTem:COMMunicate:LAN:GATEway?
 Function Queries the gateway IP.

Example	:SYSTem:COMMunicate:LAN:GATEway? Queries the gateway IP.
Command	:SYSTem:COMMunicate:LAN:DNS <IPaddress>
Function	Sets the DNS IP address.
Description	<IP address> ASCII string, within the range of 1.0.0.0 to 223.255.255.255 (excluding 127.nnn.nnn.nnn). The SYSTem:COMMunicate:LAN:APPLY command needs to be executed before the DNS IP address setting can take effect.

Example	:SYSTem:COMMunicate:LAN:DNS 172.16.2.3 Sets the DNS address to 172.16.2.3.
Command	:SYSTem:COMMunicate:LAN:DNS?
Function	Queries the DNS address.

Example	:SYSTem:COMMunicate:LAN:DNS? Queries the DNS address.
Command	:SYSTem:COMMunicate:LAN:MANualip[:STATe]
Function	Allow the IP address to be set manually. 0/OFF: disable the manual IP address. 1/ON: enable the manual IP address.

Example	:SYSTem:COMMunicate:LAN:MANualip ON Enables a manual IP address to be set.
Command	:SYSTem:COMMunicate:LAN:MANualip[:STATe]?
Function	Queries whether manual IP addressing has been enabled or disabled.

Example :SYSTem:COMMunicate:LAN:MANualip?
Queries the status of the manual IP addressing.

Command :SYSTem:COMMunicate:LAN:APPLy
Function When this command is executed, all the LAN settings are applied.

Example :SYSTem:COMMunicate:LAN:APPLy
Applies all the LAN settings.

Command :SYSTem:REMote
Function Sets the unit to remote control.

Example :SYSTem:REMote
Sets to remote control mode

Command :SYSTem:BEEPer:STATe
Function Turn the buzzer on or off.
 0/OFF: Turn the buzzer off.
1/ON: Turn the buzzer on.

Example :SYSTem:BEEPer:STATe OFF
Turns the buzzer off.

Command :SYSTem:BEEPer:STATe?
Function Queries the buzzer status.

Example :SYSTem:BEEPer:STATe?
Queries the buzzer status.

Command :SYSTem:LOCAl
Function Disable remote control mode.

Example :SYSTem:LOCal
 Disables remote control mode.

System Related Commands

Command *IDN?

Function Read the instrument identification <string>.

Description <string> The return string contains four fields, each separated by a comma. The first field is the manufacturer, followed by the model name, serial number and the version number.

Example *IDN?

 Returns: GW,PPH-1503D,XXXXXXXX,V0.62
 GW: Manufacturer,
 PPH-1503D: Model name,
 XXXXXXXX: Serial number,
 V0.62: version number.
 Returns the PPH identification.

Command *RST

Function Resets the unit to RST default conditions.

Example *RST

 Resets the unit.

Command *TST?

Function Performs checksum test on the RAM.

Return 0: No errors
 value 2: Indicates that there is a RAM error.

Example	*TST?
	Return 0 if there are no errors, returns 2 if there is an error.
Command	*WAI
Function	Waits for all pending operations to be completed before allowing other operations to be executed.

Example	*WAI
---------	------

Command	*TRG
Function	Sends a bus trigger.

Example	*TRG
	Sends a bus trigger.

Command	*SAV <NRf>
Function	Save the current setup to the selected save location.
Description	<NRf> 0: Save to memory location SAV0 1: Save to memory location SAV1 2: Save to memory location SAV2 3: Save to memory location SAV3 4: Save to memory location SAV4

Example	*SAV 3
	Save the current setup to SAV3.

Command	*RCL <NRf>
Function	Recall the selected save setting from memory.

Description	<NRf>	0: Recall SAV0 from memory. 1: Recall SAV1 from memory. 2: Recall SAV2 from memory. 3: Recall SAV3 from memory. 4: Recall SAV4 from memory.
-------------	-------	---

Example	*RCL 2	Recalls the user save settings from SAV2
---------	--------	--

SCPI Status Registers SCPI

The SCPI instrument configuration is controlled by the status registers. The Status system records various instrument conditions into three main register groups: The status byte register, the standard event register group and the questionable data register group. The status byte register records a high-level summary of the other register groups. The following diagram is the SCPI Status System diagram.

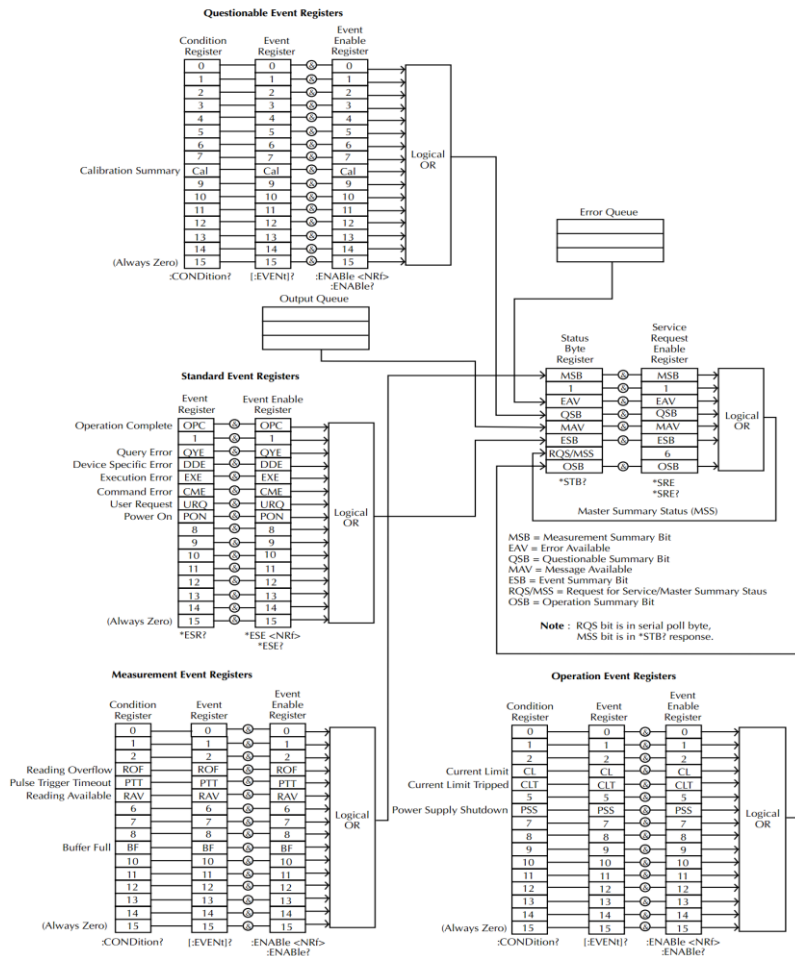

*Note: URQ indicates that the "Lock" key on the panel has been used. (Entering lock from unlock or Entering unlock from lock).

Event Registers

The operation, measurement and questionable status register groups all have event registers. The event registers are read only registers that reflect the status of the unit. Individual bits in the event registers are latched (set) when a corresponding event occurs and will remain latched even if the corresponding event changes, as long as the event bit is still set. The register query (*ESR) or the command (*CLS) will automatically clear any set bits in the event registers. The reset command (*RST) will not clear the bits in the event register. Queries for the event registers will return a binary-weighted decimal value that represents the state of all the bits in an event register.

Enable Registers

The enable registers define which bits in the corresponding event register can be latched (set). The enable register can be read and written to. Any queries for the enable register will not clear the value in the register. The *CLS command will not clear the enable register, but will clear the events in the event register. To allow the individual bits in the event registers to be set, the corresponding bits in the enable registers must be set, where each bit is represented by a binary number.

Status Byte Register

The status byte register reports the status of the other status registers. The message available bit (bit 4), will indicate when there is a message in the output buffer. Clearing an event register will clear the corresponding bit in the status byte condition register. Reading all the data in the output buffer will clear the message available bit. To set the enable register mask for the status byte register and to generate an SRQ (service request) you must use the *SRE command to write the appropriate decimal value to the register.

Bit Definition for the Status Byte Register

Bit number	Decimal value	Definition
0 Not used	1	Not used, returns "0"
1 Not used	2	Not used, returns "0"
2 Error Queue	4	Indicates that one or more errors are stored in the error queue.
3 Questionable Summary bit	8	One or more bits are set in the questionable data register (for enabled events).
4 Message Available bit	16	Indicates that a message is available in the output queue.
5 Standard Event Summary bit.	32	Indicates that one or more bits are set in the standard event register. (For enabled events).
6 Master Summary bit	64	Indicates that a summary bit is set in the status byte register. (for enabled summary bits)
7 Unused	128	Not used, returns "0"

The status byte condition register is cleared when one of the following occurs:

- *CLS command is used to clear the status byte register.
- You read the event register from another register group (only clear the corresponding bit in the condition register)

The status byte enable register is cleared when the following occurs:

- When the *SRE 0 is command is executed.

Use the *STB? query to read the status byte register.

The *STB? query will return the contents of the status byte register as long as the bit 6 (MSS) has been cleared.

Using the *OPC? query to place a signal in the output buffer.

In general it is best to use the Operation Complete Bit (bit 0) in the standard event register to check to see if an operation/command has

completed. After executing the *OPC command, the OPC bit will be set to 1. If a command or query is placed in the output buffer immediately before the *OPC command is sent, the Operation Complete Bit can be used to determine when the information can be used. However if too many commands/queries are executed prior to the execution of the *OPC command, the output buffer could become saturated and the unit will stop taking readings.

Standard Event Register

The Standard Event Register reports the following types or events: Power on has been detected, command syntax errors, command execution errors, self test and execution errors, query errors or if the *OPC command is executed. Any one or more of these events will set the standard event summary bit in the status byte register. To set a mask for the enable register, a binary-weighted decimal number must be written using the *ESE command.

Bit Definition for the Standard Event Register

Bit number	Decimal value	Definition
0 Operation Complete Bit	1	The *OPC command will set this bit when all overlapping operations have completed (including the *OPC command itself).
1 Not used	2	Not used, returns 0.
2 Query Error	4	The instrument tried to read the error queue when the queue was empty or the queue was read before a new command was given or the input/output buffers are full.
3 Device Error	8	A self-test, calibration or other device-specific error.
4 Execution Error	16	An execution error.
5 Command Error	32	A command syntax error.

6 Not used	64	Not used, return 0.
7 Power On	128	This bit is set if the power supply has been reset from the last time you read the event register.

The following will clear the standard event register:

- The *CLS command is executed.
- The *ESR? command is used to query the event register.

The following will clear the standard event enable register.

- The *ESE command is executed.

Status Byte Register Commands

Command *SRE <Allowed values>

Function Service request enable register (SRER) command that writes a binary weighed value which determines which events in the status byte register are enabled.

Function Allowed Decimal vales: 0~255
values

Example *SRE 7
Returns the SRER setting (0000 0111)

Command *SRE?

Function Queries the status byte enable register. This command returns a binary-weighted decimal number that indicates which bits are set in the status byte register. The range is from 0~255.

Example *SRE?
Returns "7", which are the contents of the service request enable register.

Function *STB?

Function	Query the status byte register. This is the same as performing a serial poll, however the master summary bit (MSS, bit 6) will not be cleared by the *STB command. The return value range is from 0 to 255.
----------	---

Example	*STB? Returns 81 if the status byte register is set to 0101 0001.
---------	--

Standard Event Register Commands

Command	*ESE<Allowed Values>
---------	----------------------

Function	Sets the standard event enable register. The allowable value range is 0~255.
----------	--

Example	*ESE 65 Sets the ESER as 0100 0001.
---------	--

Command	*ESE?
---------	-------

Function	Queries the standard event enable register. It returns a binary-weighted decimal value representing all the enabled bits in the standard event register.
----------	--

Example	*ESE? Returns 65, as the ESER is set as 0100 0001.
---------	---

Command	*ESR?
---------	-------

Function	Queries the standard event register. It returns a binary-weighted decimal value in the range of 0~255.
----------	--

Example	*ESR? It returns 198, as the ESER is set as 0100 0001.
---------	---

Other Status Register Commands

Command	*CLS
Function	Clears the status byte summary registers and the all event registers.
Example	*CLS Clears all the event registers. 涵盖 Standard event registers, Operation event registers, Measurement event registers, Questionable event registers.
Command	*OPC
Function	After all the pending operations are complete, sets the operation complete bit in the standard event status register.
Example	*OPC
Command	*OPC?
Function	Will return "1" to the output queue when all pending operations have been completed.
Example	*OPC? After the last command is executed, will return a "1" to the output queue.

Errors

Error Message

- Errors are stored in a first in-first out (FIFO) order. The first error message that is returned is the first error message that was stored. When an error is read it is also cleared from the queue.
- If there are more than 10 errors produced the last error in the queue is replaced with “Que overflow”. Unless the error queue is cleared, no more errors can be written to the error queue. If there are no errors in the error queue, the instrument will return “No error”.
- To clear the error queue, you can use the :SYSTEM:CLEAR command or cycle the power. When you read a message from the error queue that message will be cleared from the error queue. Using the *RST command to reset the instrument does not clear the error queue.
- Remote control instructions can be used to clear the error queue. See the instructions listed in the previous chapter for details.

Command Errors

- 440 Query unterminated after indefinite
- 430 Response
- 420 Query deadlocked
- 410 Query unterminated
- 363 Query interrupted
- 350 Input buffer overrun
- 330 Queue overflow
- 314 Self-test failed
- 315 Save/recall memory lost
- 260 Configuration memory lost
- 241 Expression error
- 230 Hardware missing

- 225 Data corrupt or stale
- 224 Out of memory
- 223 Illegal parameter value
- 222 Too much data
- 221 Parameter data out of range
- 220 Settings conflict
- 200 Parameter error
- 178 Execution error
- 171 Expression data not allowed
- 170 Invalid expression
- 161 Expression error
- 160 Invalid block data
- 158 Block data error
- 154 String data not allowed
- 151 String too long
- 150 Invalid string data String data error
- 148 Character data not allowed
- 144 Character data too long
- 141 Invalid character data
- 140 Character data error
- 124 Too many digits
- 123 Exponent too large
- 121 Invalid character in number
- 120 Numeric data error
- 114 Header suffix out of range
- 113 Undefined header
- 112 Program mnemonic too long
- 111 Header separator error

- 110 Command header error
- 109 Missing parameter
- 108 Parameter not allowed
- 105 GET not allowed
- 104 Data type error
- 103 Invalid separator
- 102 Syntax error
- 101 Invalid character
- 100 Command error
- +000 No error
- +101 Operation complete
- +301 Reading overflow
- +302 Pulse trigger detection timeout
- +306 Reading available
- +310 Buffer full
- +320 Current limit event
- +321 Current limit tripped event
- +409 OTP Error
- +410 OVP Error
- +438 Date of calibration not set
- +440 Gain-aperture correction error
- +500 Calibration data invalid
- +510 Reading buffer data lost
- +511 GPIB address lost
- +512 Power-on state lost
- +514 DC Calibration data lost
- +515 Calibration dates lost
- +522 GPIB communication data lost

+610 Questionable calibration

+900 Internal system error

APPENDIX

Replacing the Fuse

Steps

Remove the power cord and then take out the box using a small screw driver.

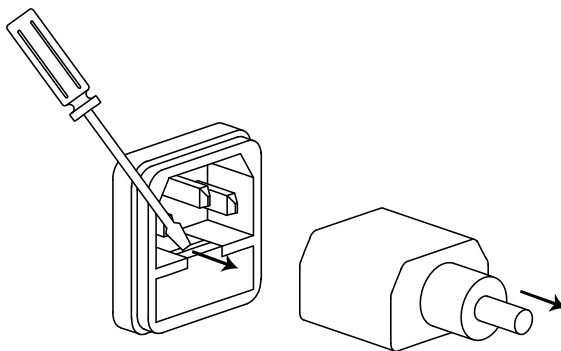

The fuse is stored in the housing.

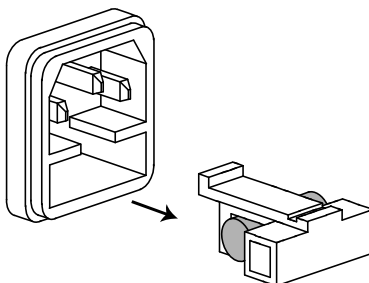

Rating

- T2.0A/250V (PPH-1503D)
- T2.5A/250V (PPH-1506D/1510D)

Battery Replacement

Step

1. Remove the handle.

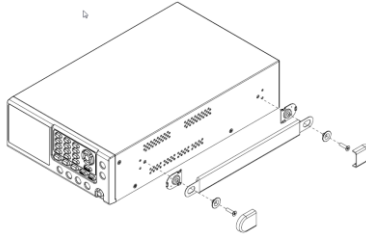

2. Remove the six screws on both sides and the four screws on the rear.

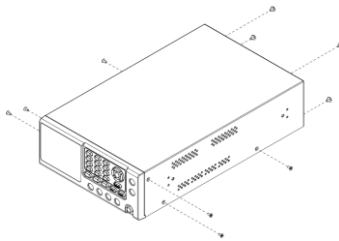

3. Open the cover. Find the location indicated by the arrow in the figure shown below and then replace the battery with a new one.

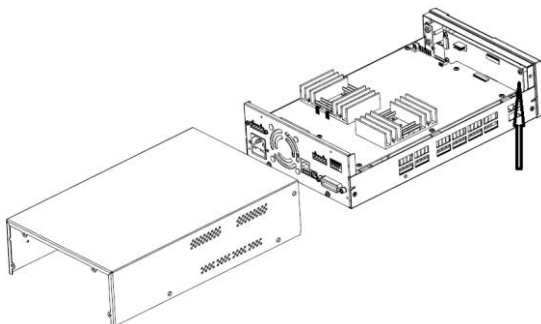

Specifications

The specifications apply under the following conditions: The PPH-1503D/1506D/1510D is powered on for at least 30 minutes, within +18°C~+28°C.

DC GENERAL	MEASUREMENT TIME CHOICES	0.01 ~ 10PLC ¹ , 0.01PLC/step		
	AVERAGE READINGS	1~10		
	TYPICAL READING TIME ^{2,3}	31ms		
	DC VOLTAGE OUTPUT (23°C±5°C)	OUTPUT VOLTAGE	CH1:0~15V CH2:0~12V	
DC VOLTAGE OUTPUT (23°C±5°C)	OUTPUT ACCURACY	± (0.05%+10mV)		
	PROGRAMMING RESOLUTION	2.5mV		
	READBACK ACCURACY ³	± (0.05%+3mV)		
	READBACK RESOLUTION	1mV		
	OUTPUT VOLTAGE RISING TIME	0.20ms (10% ~ 90% On)		
	OUTPUT VOLTAGE FALLING TIME	0.30ms (90% ~ 10% Off)		
	LOAD REGULATION	0.01%+2mV		
	LINE REGULATION	0.5mV		
	STABILITY ⁴	0.01%+3mV		
	RECOVERY TIME(1000%LOAD CHANGE)	<40us (<100mV, Rear) <50us (<100mV, Front) <80us (<20mV)		
	RIPPLE AND NOISE ⁵		3mV rms(0~1MHz) 8mVpp(20Hz~ 20MHz) (≤5A) 12mVpp(20Hz~ 20MHz) (>5A)	
		DC CURRENT (23°C±5°C)	OUTPUT CURRENT	CH1:0~5A (0~9V), 0~3A(9~15V) 0~10A(Rear 0~4.5V) (1510D) CH2:0~1.5A(PPH-1503D) 0~3.0A(PPH-1506D/1510D)
		SOURCE COMPLIANCE ACCURACY	1.5A/3.0A&5A range: ±(0.16%+5mA) 500mA range: ±(0.16%+0.5mA) 5mA range: ±(0.16%+5uA)	
	DC CURRENT (23°C±5°C)	PROGRAMMED SOURCE RESOLUTION	CH1:5A range:1.25mA 500mA range:0.125mA 5mA range:1.25uA CH2:1.5A/3.0A range:1.25mA	
READBACK ACCURACY ³		CH1:5A range: ±(0.2%+400uA) 500mA range: ±(0.2%+100uA) 5mA range: ±(0.2%+1uA) CH2: 1.5A /3.0A range:±(0.2%+400uA) 5mA range: ±(0.2%+1uA)		

	READBACK RESOLUTION	1.5A/3.0A &5A range: 100uA 500mA range: 10uA 5mA range: 0.1uA
	CURRENT SINK CAPACITY	CH1:0-4V: 3.5A 4-15V: 3.5A-(0.25A/V)*(Vset-4V) CH2: 0-5V: 2A(PPH-1503D) 3A(PPH-1506D/1510D) 5-12V: 2.0A-(0.1A/V)*(Vset-5V) (PPH-1503D) 3.0A-(0.25A/V)*(Vset-5V) (PPH-1506D/1510D)
	LOAD REGULATION	0.01%+1mA
	LINE REGULATION	0.5mA
DVM	INPUT VOLTAGE RANGE	0 ~ 20VDC
	INPUT IMPEDANCE	20MΩ
	MAXIMUM INPUT VOLTAGE	-3V, +22V
	READING ACCURACY ³	± (0.05%+3mV)
	READING RESOLUTION	1mV
PULSE CURRENT MEASUREME NT	TRIGGER LEVEL	CH1:5mA-5A,5mA/step CH2:5mA-1.5A/3.0A,5mA/step
	HIGH TIME/LOW TIME/AVERAGE TIME	33.3us to 833ms, 33.3us/step
	TRIGGER DELAY	0 ~ 100ms,10us/steps
	AVERAGE READINGS	1 ~ 100
	LONG INTEGRATION PULSE TIMEOUT	1S ~ 63S
	LONG INTEGRATION MEASUREMENT TIME	850ms(60Hz)/840ms(50Hz) ~ 60s,or AUTO time 16.7ms/steps(60Hz), 20ms/steps(50Hz)
	LONG INTEGRATION TRIGGER MODE	Rising, Falling, Neither
	Resistance	RANGE
	PROGRAMMED RESOLUTION	0.001Ω
	PROGRAMMED ACCURACY	±(0.5%+0.01Ω)
OVP	OVP RANGE	Auto, OFF, ON (CH1:1.00~15.2V; CH2:1.00~12.2V)
	RESOLUTION	10mV
	ACCURACY	CH:1 0.8V CH2: 50mV
Others	PROGRAMMING	IEEE-488.2(SCPI)
	USER_DEFINABLE POWER_UP STATES	5 sets
	REAR PANEL CONNECTOR	5Pin*2:output*2,sense*2,Ground*1
	TEMPERATURE COEFFICIENT	0.1* specification/ °C
	POWER CONSUMPTION	160W(PPH-1503D),180W(PPH-1506D), 210W(PPH-1510D)
	REMOTE/LOCATION CONNECTOR	USB/GPIB/LAN

	RELAY CONTROL CONNECTOR	150mA/15V 5Voutput, 100mA
Insulation	Chassis and Terminal Chassis and AC cord	20M Ω or above (DC 500V) 30M Ω or above (DC 500V)
Operation Environment	Indoor use, Altitude: \leq 2000m Ambient temperature: 0 ~ 40°C Relative humidity: \leq 80% Installation category: II, Pollution degree: 2	
Storage Environment	TEMPERATURE: -20°C ~ 70°C HUMIDITY: < 80%	
INPUT POWER	90-264VAC, 50/60Hz ⁶	
Accessories	CD User manual x1, Quick Start manual x1 Test lead GTL-207A x 1 GTL-203A x 1, GTL-204A x 1	
Dimensions	222 (W) x 86 (H) x 363 (D) mm	
Weight	Approx. 4.5kg	
Remarks	¹ PLC=PowerLineCycle, 1PLC = 16.7ms for 60Hz operation, 20ms for 50Hz operation; ² Display OFF, Speed includes measurement and binary data transfer out of GPIB; ³ PLC=1; ⁴ STABILITY: Following 15 minute warm-up, the change in output over 8 hours under ambient temperature, constant load, and line operating conditions; ⁵ The ground ring of the probe is pressed directly against the output ground of the power supply and the tip is in contact with the output voltage pin. ⁶ Auto detected at power-up;	

Optional Accessories

USB Cable	GTL-246	USB 2.0, A-B type
-----------	---------	-------------------

Declaration of Conformity

We

GOOD WILL INSTRUMENT CO., LTD.

declare, that the below mentioned product

Type of Product: **Programmable High Precision DC Power Supply**

Model Number: **PPH-1503D/1506D/1510D**

satisfies all the technical relations application to the product within the scope of council:

Directive: 2014/30/EU; 2014/35/EU; 2011/65/EU; 2012/19/EU

The above product is in conformity with the following standards or other normative documents:

© **EMC**

EN 61326-1:	Electrical equipment for measurement, control and laboratory use -- EMC requirements (2013)
Conducted & Radiated Emission EN 55011: 2009 +A1: 2010 Class A	Electrical Fast Transients EN 61000-4-4: 2012
Current Harmonics EN 61000-3-2: 2014	Surge Immunity EN 61000-4-5: 2014
Voltage Fluctuations EN 61000-3-3: 2013	Conducted Susceptibility EN 61000-4-6: 2014
Electrostatic Discharge EN 61000-4-2: 2009	Power Frequency Magnetic Field EN 61000-4-8: 2010
Radiated Immunity EN 61000-4-3:2006+A1:2008+A2:2010	Voltage Dip/ Interruption EN 61000-4-11: 2004

© **Safety**

Low Voltage Equipment Directive 2014/35/EU	
Safety Requirements	EN 61010-1: 2010

GOOD WILL INSTRUMENT CO., LTD.

No. 7-1, Jhongsing Road, Tucheng Dist., New Taipei City 236, Taiwan

Tel: +886-2-2268-0389

Fax: +866-2-2268-0639

Web: www.gwinstek.com

Email: marketing@goodwill.com.tw

GOOD WILL INSTRUMENT (SUZHOU) CO., LTD.

No. 521, Zhujiang Road, Snd, Suzhou Jiangsu 215011, China

Tel: +86-512-6661-7177

Fax: +86-512-6661-7277

Web: www.instek.com.cn

Email: marketing@instek.com.cn

GOOD WILL INSTRUMENT EURO B.V.

De Run 5427A, 5504DG Veldhoven, The Netherlands

Tel: +31(0)40-2557790

Fax: +31(0)40-2541194

Email: sales@gw-instek.eu