

# DC Electronic Load

PEL-3000E

---

## PROGRAMMING MANUAL

VERSION: 1.11



ISO-9001 CERTIFIED MANUFACTURER

**GW INSTEK**

This manual contains proprietary information, which is protected by copyright. All rights are reserved. No part of this manual may be photocopied, reproduced or translated to another language without prior written consent of Good Will company.

The information in this manual was correct at the time of printing. However, Good Will continues to improve products and reserves the rights to change specification, equipment, and maintenance procedures at any time without notice.

**Good Will Instrument Co., Ltd.**  
**No. 7-1, Jhongsing Rd., Tucheng Dist., New Taipei City 236, Taiwan.**

# Table of Contents

<b>I</b> INTERFACE OVERVIEW .....	<b>2</b>
Front Panel Overview .....	3
Rear Panel Overview .....	4
Interface Configuration .....	5
<b>C</b> COMMAND OVERVIEW .....	<b>15</b>
Command Syntax .....	15
Command List .....	20
Status Registers .....	151
Error Messages .....	160

# **I** NTERFACE OVERVIEW

This chapter describes basic configuration of IEEE488.2 based remote control.

---

Front Panel Overview .....	3
Rear Panel Overview .....	4

# Front Panel Overview

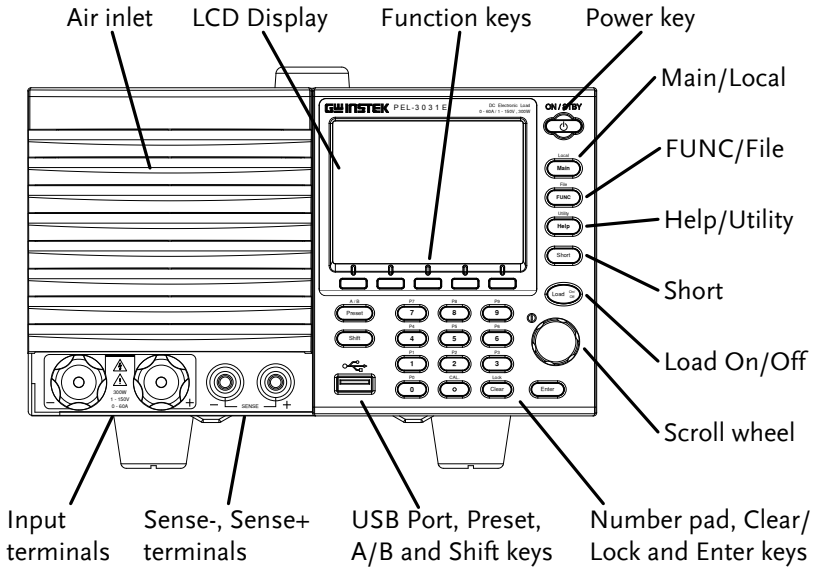

## Rear Panel Overview

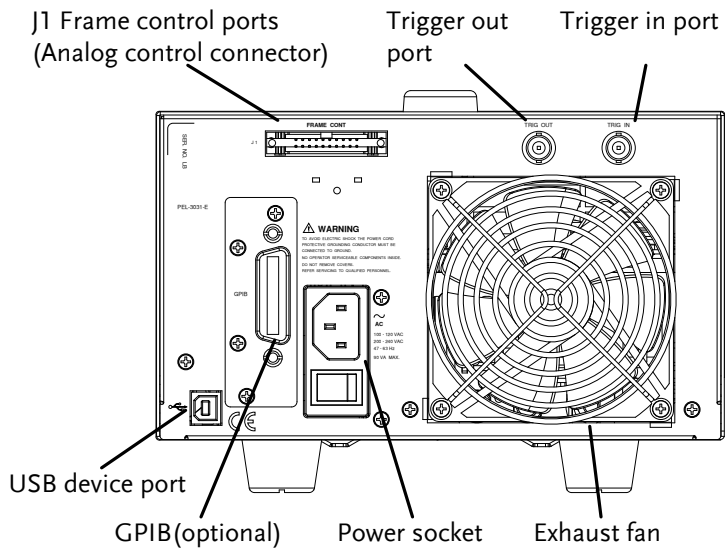

## Interface Configuration

### Configure to USB Remote Interface

---

USB configuration	PC side connector	Type A, host
	PEL-3000E side connector	Rear panel Type B, slave
	Speed	2.0 (full speed)
	USB Class	USB CDC ACM

---



Note



Before USB can be used for remote control, it is necessary to install the PEL-3000E USB device driver, located on the accompanying User Manual CD.

Supported OS:

32 bit(x86): Windows 2000/XP/Vista/7/8

64 bit(x64): Windows XP/Vista/7/8

---

- Operation
1. Connect the USB cable to the rear panel USB B port.
  2. Press  +  > *Interface*[F3] and set the *Interface* setting to *USB*.

### Configure GPIB Interface

To use GPIB, the optional GPIB port must be installed. See the user manual for installation details.

---

- Operation
1. Ensure the PEL-3000E is off before proceeding.
  2. Connect a GPIB cable from a GPIB controller to

the GPIB port on the PEL-3000E.

3. Turn the PEL-3000E on.
4. Press **Shift** + **Utility Help** > *Interface[F3]* and set the *Interface* setting to *GPIB*.
5. Set the GPIB address.  
 GPIB address     0~30

- GPIB constraints
- *Maximum 15 devices altogether, 20m cable length, 2m between each device*
  - *Unique address assigned to each device*
  - *At least 2/3 of the devices turned On*
  - *No loop or parallel connection*

Pin Assignment

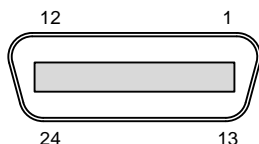

Pin	Signal	Pin	Signal
1~4	Data I/O 1~4	13~16	Data I/O 5~8
5	EOI	17	REN
6	DAV	18	Ground (DAV)
7	NRFD	19	Ground (NRFD)
8	NDAC	20	Ground (NDAC)
9	IFC	21	Ground (IFC)
10	SRQ	22	Ground (SRQ)
11	ATN	23	Ground (ATN)
12	SHIELD Ground	24	Single GND



## USB Remote Control Function Check

---

Functionality  
check

Invoke a terminal application such as Realterm.

The USB connection emulates a COM port on the PC. To check the COM port settings in Windows, see the Device Manager. For example, for Win 7 go to the Control panel → Hardware and Sound → Device Manager.

---



Note

If you are not familiar with using a terminal application to send/receive remote commands from a serial port or via a USB connection, please see page 8 (Using Realterm to Establish a Remote Connection) for more information.

---

Run this query command via the terminal after the instrument has been configured for USB remote control (page 5).

```
*idn?
```

This should return the Manufacturer, Model number, Serial number, and Firmware version in the following format.

- GW,PEL-303XE, XXXXXXXXXXXXX, V.X.X.X.X  
Manufacturer: GW  
Model number : PEL-303XE  
Serial number : XXXXXXXXXXXXX  
Firmware version : V.X.X.X
- 



Note

For further details, please see the programming manual, available on the GW Instek web site @ [www.gwinstek.com](http://www.gwinstek.com).

---

## Using Realterm to Establish a Remote Connection

---

**Background** Realterm is a terminal program that can be used to communicate with a device attached to the serial port of a PC or via an emulated serial port via USB.

The following instructions apply to version 2.0.0.70. Even though Realterm is used as an example to establish a remote connection, any terminal program can be used that has similar functionality.

---



Note

Realterm can be downloaded on Sourceforge.net free of charge.

For more information please see <http://realterm.sourceforge.net/>

---

- Operation**
1. Download Realterm and install according to the instructions on the Realterm website.
  2. Connect the PEL-3000E via USB (page 5).
  3. Go to the Windows device manager and find the COM port number for the connection. For example, go to the Start menu > Control Panel > Hardware and Sound > Device Manager.

Double click the *Ports* icon to reveal the connected serial port devices and the COM port for the each connected device.

If using USB, the baud rate, stop bit and parity settings can be viewed by right-clicking connected device and selecting the *Properties*

option.

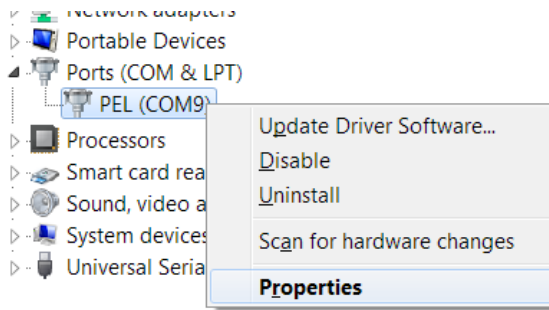

4. Start Realterm on the PC as an administrator.  
Click:  
Start menu>All Programs>RealTerm>realterm

Tip: to run as an administrator, you can right click the Realterm icon in the Windows Start menu and select the *Run as Administrator* option.

5. After Realterm has started, click on the *Port* tab.

Enter the *Baud*, *Parity*, *Data bits*, *Stop bits* and *Port* number configuration for the connection.

The *Hardware Flow Control*, *Software Flow Control* options can be left at the default settings.

Press *Open* to connect to the PEL-3000E.

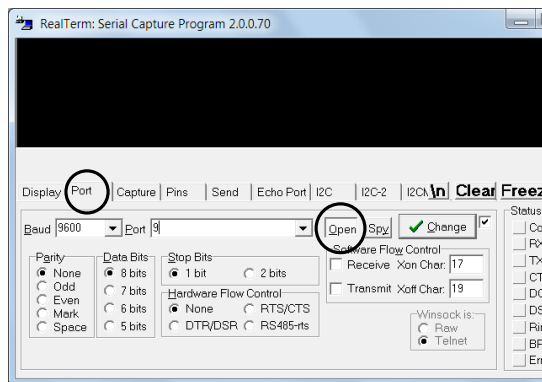

- Click on the *Send* tab.

In the *EOL* configuration, check on the *+CR* and *+LF* check boxes.

Enter the query:  
*\*idn?*

Click on *Send ASCII*.

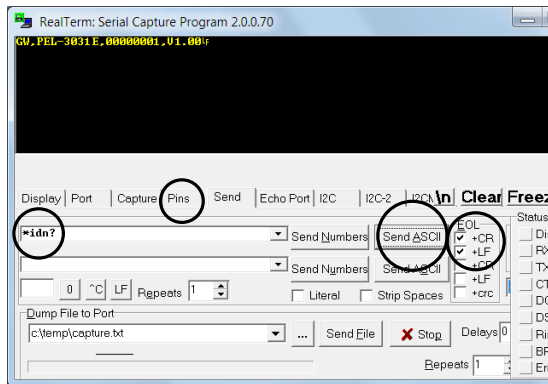

- The terminal display will return the following:

*GW,PEL-303XE,XXXXXXXXXXXX, V.X.X.X.X*  
 (manufacturer, model, serial number, version)

- If Realterm fails to connect to the PEL-3000E, please check all the cables and settings and try again.

## GPIB Function Check

Functionality check      Please use the National Instruments Measurement & Automation Controller software to confirm GPIB/LAN functionality.

See the National Instrument website, <http://www.ni.com> for details.



Note

For further details, please see the programming manual, available on the GW Instek web site @ [www.gwinstek.com](http://www.gwinstek.com).

Operation

1. Start the NI Measurement and Automation Explorer (MAX) program. Using Windows, press:



*Start>All Programs>National Instruments>Measurement & Automation*



2. From the Configuration panel access;  
My System>Devices and Interfaces>GPIB0

3. Press the *Scan for Instruments* button.
4. In the *Connected Instruments* panel the PEL-3000E should be detected as *Instrument 0* with the address the same as that configured on the PEL-3000E.
5. Double click the *Instrument 0* icon.

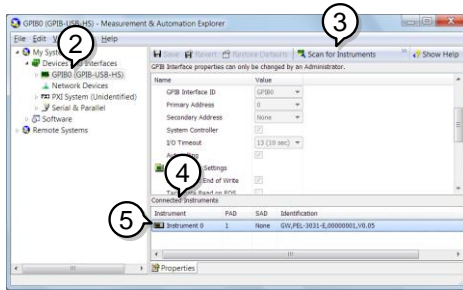

6. Click on the *Attributes* tab at the bottom of the screen.
7. Click on *Communicate with Instrument*.
8. In the *NI-488.2 Communicator* window, ensure *\*IND?* is written in the *Send String:* text box.

Click on the *Query* button to send the *\*IDN?* query to the instrument.

9. The *String Received* text box will display the query return:

GW,PEL-303XE, XXXXXXXXXXXXX, V.X.X.X.X  
(manufacturer, model, serial number, version)

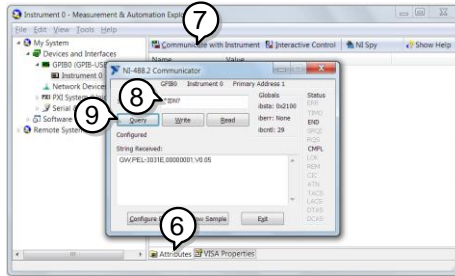

10. The function check is complete.



# C COMMAND OVERVIEW

The Command overview chapter lists all PEL-3000E commands in functional order as well as alphabetical order. The command syntax section shows you the basic syntax rules you have to apply when using commands.

## Command Syntax

---

Compatible Standard	IEEE488.2 SCPI, 1999	Partial compatibility Partial compatibility
---------------------	-------------------------	--

**Command Structure**

SCPI (Standard Commands for Programmable Instruments) commands follow a tree-like structure, organized into nodes. Each level of the command tree is a node. Each keyword in a SCPI command represents each node in the command tree. Each keyword (node) of a SCPI command is separated by a colon (:).

For example, the diagram below shows an SCPI sub-structure and a command example.

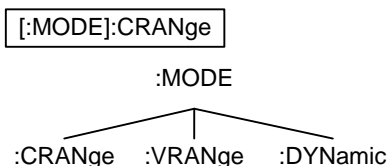

Command types      There are a number of different instrument commands and queries. A command sends instructions or data to the unit and a query receives data or status information from the unit.

Command types

Simple                      A single command with/without a parameter

Example                    :CONFigure:SHORT HOLD

Query                      A query is a simple or compound command followed by a question mark (?). A parameter (data) is returned.

Example                    :CONFigure:SHORT?

Compound                Two or more commands on the same command line. Compound commands are separated with either a semi-colon (;) or a semi-colon and a colon (;:).

A semi-colon is used to join two related commands, with the caveat that the last command must begin at the last node of the first command.

A semi-colon and colon are used to combine two commands from different

nodes.

Example	CONFigure:VON MAX::CONFigure:VDElay MIN
---------	---

**Command Forms**

Commands and queries have two different forms, long and short. The command syntax is written with the short form of the command in capitals and the remainder (long form) in lower case.

The commands can be written in capitals or lower-case, just so long as the short or long forms are complete. An incomplete command will not be recognized.

Below are examples of correctly written commands.

Long form	:CURRent:LEVel? :CURRENT:LEVEL? :current:level?
Short form	:CURR:LEV? :curr:lev?

**Square Brackets**

Commands that contain square brackets indicate that the contents are optional. The function of the command is the same with or without the square bracketed items, as shown below

For example for the query:  
“[:CONFigure]:GNG [:PASS]?”

Both “:CONFigure:GNG:PASS?” and “:GNG?” are both valid forms.

Command  
Format

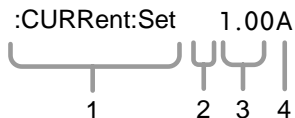

1. Command header
2. Space
3. Parameter 1
4. Unit or suffix.

Common  
Unit Parameters

Type	Description	Example
<Boolean>	boolean logic	0, 1
<NR1>	integers	0, 1, 2, 3
<NR2>	decimal numbers	0.1, 3.14, 8.5
<NR3>	floating point	4.5e-1, 8.25e+1
<NRf>	any of NR1, 2, 3	1, 1.5, 4.5e-1
[MIN] (Optional parameter)	For commands, this will set the setting to the lowest value. This parameter can be used in place of any numerical parameter where indicated.  For queries, it will return the lowest possible value allowed for the particular setting.	
[MAX] (Optional parameter)	For commands, this will set the setting to the highest value. This parameter can be used in place of any numerical parameter where indicated.  For queries, it will return the highest possible value allowed for the particular setting.	
Unit Suffixes (Optional parameters)	Unit suffixes can be optionally used with most NRf type input parameters.	

---

[A]	Amps	1.00A
[%]	Percentage	10%
[V]	Volts	5.00V
[W]	Watts	3.00W
[ms]	milliseconds	20ms
[mV]	Millivolts	150mV
[s]	Seconds	5s
[mS]	Reciprocal of 1000 ohms	20mS
[OHM]	Ohm	50OHM
[mA/us]	Millamps/ microsecond	100mA/us
[Hz]	Hertz	1000Hz
Note:	For [OHM] return values, an infinite resistance (open) will be returned as 9.9e <sup>37</sup> .	

---

Message Terminator	LF	Line feed code (0x0A)
--------------------	----	-----------------------

---

# Command List

Common	*CLS .....	26
Commands	*ESE .....	26
	*ESR? .....	27
	*IDN? .....	27
	*OPC .....	28
	*RCL .....	28
	*RST .....	29
	*SAV .....	29
	*SRE .....	29
	*STB? .....	30
	*TRG .....	31
	*TST? .....	31
	*WAI .....	31
Trigger	Trigger States .....	32
Commands	:ABORt .....	32
	:INPut[:STATe]:TRIGgered .....	33
	:INITiate[:IMMediate] .....	33
	:INITiate:CONTInuous .....	33
	:CONDuctance[:VA]:TRIGgered .....	34
	:CURRent[:VA]:TRIGgered .....	34
	:RESistance[:VA]:TRIGgered .....	35
	:TRIGger[:Delay]:Time .....	35
	:TRIGger[:PULSe]:WIDTh .....	35
Input State	:INPut .....	37
Commands	:INPut:SHORt .....	37
	:INPut:MODE .....	38
Measurement	:MEASure:CURRent? .....	39
Commands	:MEASure:VOLTagE? .....	39
	:MEASure:POWer? .....	39
	:MEASure:ETIME? .....	40

Fetch Subsystem	:FETCh:VOLTagE?	41
Commands	:FETCh:CURREnt?	41
	:FETCh:POWEr?	41
Configure	[:CONFigure]:OCP	43
Subsystem	[:CONFigure]:OPP	44
Commands	[:CONFigure]:UVP	45
	[:CONFigure]:OVP	45
	[:CONFigure]:SStArt	46
	[:CONFigure]:VON	47
	[:CONFigure]:VDElay	47
	[:CONFigure]:CNTime	48
	[:CONFigure]:COTime	48
	[:CONFigure]:CRUNit	49
	:CONFigure:DYNamic	49
	:CONFigure:MEMory	50
	:CONFigure:SHORt	51
	:CONFigure:SHORt:SAFety	51
	[:CONFigure]:GNG:SPECTest	52
	[:CONFigure]:GNG:DTIME	52
	[:CONFigure]:GNG:MODE	53
	[:CONFigure]:GNG[:PASS]	53
	[:CONFigure]:GNG:H	54
	[:CONFigure]:GNG:L	54
	[:CONFigure]:GNG:C	55
Step Commands	[:CONFigure]:STEP:CCH	56
	[:CONFigure]:STEP:CCL	57
	[:CONFigure]:STEP:CC	57
	[:CONFigure]:STEP:CRH	58
	[:CONFigure]:STEP:CRL	58
	[:CONFigure]:STEP:CR	59
	[:CONFigure]:STEP:CVH	59
	[:CONFigure]:STEP:CVL	60
	[:CONFigure]:STEP:CV	60
	[:CONFigure]:STEP:CPH	61
	[:CONFigure]:STEP:CPL	61
	[:CONFigure]:STEP:CP	62

External	[:CONFigure]:EXTernal[:CONTRol].....	63
Commands	[:CONFigure]:EXTernal:LOADonin .....	63
Mode Subsystem	:MODE .....	65
Commands	[:MODE]:CRANge .....	65
	[:MODE]:VRANge.....	66
	[:MODE]:DYNamic.....	66
Current	:CURRent:RECall.....	68
Subsystem	:CURRent[:VA].....	69
Commands	:CURRent:VB .....	69
	:CURRent:SRATe .....	70
	:CURRent:L1 .....	70
	:CURRent:L2.....	71
	:CURRent:SET .....	72
	:CURRent:LEVel.....	72
	:CURRent:RISE.....	73
	:CURRent:FALL .....	73
	:CURRent:T1 .....	74
	:CURRent:T2 .....	75
	:CURRent:FREQuency .....	75
	:CURRent:DUTY.....	76
	:CURRent:CV:RESPonse .....	77
Resistance	:RESistance:RECall.....	78
Subsystem	:CONDuctanceRECall.....	79
Commands	:CONDuctance[:VA] .....	79
	:CONDuctance:VB.....	80
	:RESistance[:VA] .....	81
	:RESistance:VB.....	81
	:RESistance:SRATe.....	82
	:CONDuctance:L1 .....	83
	:CONDuctance:L2 .....	84
	:CONDuctance:SET.....	84
	:RESistance:L1 .....	85
	:RESistance:L2 .....	86
	:RESistance:SET.....	87
	:RESistance:LEVel.....	87
	:RESistance:RISE.....	88
	:RESistance:FALL.....	89



	:RESistance:T1.....	89
	:RESistance:T2.....	90
	:RESistance:FREQuency.....	91
	:RESistance:DUTY.....	91
	:RESistance:CV:RESPonse.....	92
Voltage	:VOLTage:RECall.....	93
Subsystem	:VOLTage[:VA].....	93
Commands	:VOLTage:VB.....	94
	:VOLTage:RESPonse.....	94
Power Subsystem	:POWER:RECall.....	96
Commands	:POWER[:VA].....	96
	:POWER:VB.....	97
	:POWER:RESPonse.....	97
	:POWER:CV:RESPonse.....	98
Function	:PROGram:STATe.....	100
Commands	:PROGram.....	101
	:PROGram[:RECall]:DEFault.....	102
	:PROGram:STARt.....	102
	:PROGram:STEP.....	103
	:PROGram:MEMory.....	103
	:PROGram:RUN.....	103
	:PROGram:ONTime.....	104
	:PROGram:OFFTime.....	104
	:PROGram:PFTime.....	105
	:PROGram:STIME.....	105
	[:PROGram]:CHAIIn:STARt.....	106
	[:PROGram]:CHAIIn.....	106
	[:PROGram]:CHAIIn:P2P.....	108
	[:PROGram]:CHAIIn[:RECall]:DEFault.....	108
	:PROGram:SAVE.....	109
	:NSEQuence:STATe.....	109
	:NSEQuence.....	110
	:NSEQuence:STARt.....	111
	:NSEQuence:NUMBer.....	112
	:NSEQuence:MEMO.....	112
	:NSEQuence:MODE.....	113
	:NSEQuence:RANGe.....	113
	:NSEQuence:LOOP.....	114

	:NSEquence:LLOad .....	114
	:NSEquence:LAST .....	115
	:NSEquence:CHAin .....	115
	:NSEquence:EDIT .....	116
	:NSEquence:EDIT:POINT .....	117
	:NSEquence:EDIT:END? .....	118
	:NSEquence[:DELet]:ALL.....	118
	:NSEquence:SAVE.....	118
	:FSEquence:STATe .....	118
	:FSEquence .....	119
	:FSEquence:MEMO .....	120
	:FSEquence:MODE .....	121
	:FSEquence:RANGe .....	121
	:FSEquence:LOOP .....	122
	:FSEquence:TBASe .....	122
	:FSEquence:LLOad .....	123
	:FSEquence:LAST .....	123
	:FSEquence:RPTStep.....	124
	:FSEquence:EDIT .....	124
	:FSEquence:EDIT:POINT .....	125
	:FSEquence:EDIT:END? .....	126
	:FSEquence[:DELet]:ALL.....	126
	:FSEquence[:EDIT]:FILL .....	126
	:FSEquence:SAVE.....	127
Utility	:UTILity:SYSTem? .....	128
Commands	:UTILity:LOAD .....	128
	:UTILity:LOAD:MODE .....	129
	:UTILity:LOAD:RANGe .....	130
	:UTILity:INTerface.....	131
	:UTILity:TIME .....	131
	:UTILity:KNOB .....	132
	:UTILity:SPEaker.....	132
	:UTILity:ALARm.....	133
	:UTILity:UNReg.....	133
	:UTILity:GNG .....	134
	:UTILity:CONTrast.....	134
	:UTILity:BRIGHtness .....	134
	:UTILity:LANGuage .....	135
	:UTILity:REMote.....	135
	:UTILity:REMote:MODE.....	136

File Commands	:MEMory:SAVE.....	137
	:MEMory:RECall .....	137
	:PRESet:SAVE .....	138
	:PRESet:RECall .....	138
	:SETup:SAVE.....	138
	:SETup:RECall .....	138
	:FACTory[:RECall] .....	139
	:USER[:DEFault]:SAVE.....	139
	:USER[:DEFault]:RECall .....	139
	SCPI Register Commands	:SYSTem:ERRor?.....
:STATus:PRESet.....		141
:STATus:QUEStionable:CONDition? .....		141
:STATus:QUEStionable:ENABle .....		142
:STATus:QUEStionable[:EVENT]? .....		142
:STATus:QUEStionable:NTRansition .....		143
:STATus:QUEStionable:PTRansition .....		144
:STATus:OPERation:CONDition? .....		144
:STATus:OPERation:ENABle .....		145
:STATus:OPERation[:EVENT]? .....		145
:STATus:OPERation:NTRansition .....		146
:STATus:OPERation:PTRansition .....		146
:STATus:CSUMmary:CONDition? .....		147
:STATus:CSUMmary:ENABle .....		147
:STATus:CSUMmary[:EVENT]? .....		148
:STATus:CSUMmary:NTRansition .....		148
:STATus:CSUMmary:PTRansition .....	149	

## Common Commands

*CLS .....	26
*ESE .....	26
*ESR? .....	27
*IDN? .....	27
*OPC .....	28
*RCL .....	28
*RST .....	29
*SAV .....	29
*SRE .....	29
*STB? .....	30
*TRG .....	31
*TST? .....	31
*WAI .....	31

### \*CLS



**Description** Clears the error queue.

**Syntax** \*CLS

### \*ESE

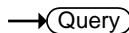
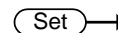

**Description** Queries or sets the Standard Event Status Enable register. The Standard Event Status Enable register determines which events can set the Event Summary bit (ESB) in the Status Byte Register. Any bits that are set to 1 enable the corresponding event. Each event is represented by a bit in the Standard Event Status Enable register.

**Syntax** \*ESE <NR1>

**Query Syntax** \*ESE?

Parameter/ Return parameter	<NR1> (bit weight)	Bit number / Description
	1	0/ OPC
	4	2/ QYE
	8	3/ DDE

	16	4/ EXE
	32	5/ CME
Example	*ESE 8 Sets bit 3 of the ESE register.	
Query example	*ESE? >12 Bits 2 and 3 are set in the Standard Event Status Enable register.	

**\*ESR?**

→ Query

Description	Reads the Standard Event Status register. This command will also clear the Standard Event Status register.	
Query Syntax	*ESR?	
Return parameter	<NR1> (bit weight)	Bit number / Description
	4	3/ QYE
	8	4/ DDE
	16	5/ EXE
	32	6/ CME
Query example	*ESR? >48 Bits 4 and 5 are set in the Standard Event register.	

**\*IDN?**

→ Query

Description	Queries the manufacturer, model number, serial number, and firmware version of the instrument.	
Query Syntax	*IDN?	

Return parameter <string> Returns the instrument identification as a string in the following format:  
 GW-INSTEK, PEL-303XE, XXXXXXXXXXXXX,  
 V.X.X.X  
 Manufacturer: GW-INSTEK  
 Model number : PEL-303XE  
 Serial number : XXXXXXXX  
 Firmware version : V.X.X.X

Set →

**\*OPC**

→ Query

**Description** This command sets the OPC (Operation Command Bit) bit (bit 0) of the Standard Event Status Register after the instrument has completed all pending operations. The query will return the status of the OPC bit.

**Syntax** \*OPC

**Query Syntax** \*OPC?

**Return parameter** <NR1>  
 1 Operation complete

**Query Example** \*OPC?  
 >1  
 Indicates that all pending operations are complete.

**\*RCL**

Set →

**Description** The Recall Instrument State command restores the instrument settings from a previously saved memory setting.

**Syntax** \*RCL <NR1>

**Parameter** <NR1>  
 1~256 Memory number 1 to 256

**Example** \*RCL 20  
 Recall setting memory 20.

**\*RST** (Set) →

Description Resets the unit. This is command forces the ABORT, and \*CLS

Syntax \*RST

**\*SAV** (Set) →

Description The Save Instrument State command saves the instrument settings to one of the memory setting slots.

Syntax \*SAV <NR1>

Parameter	<NR1> 1~256	Memory number 1 to 256
-----------	----------------	------------------------

Example \*SAV 20  
Saves the current setting to memory 20.

**\*SRE** (Set) →  
→ (Query)

Description Queries or sets the Service Request Enable register. The Service Request Enable register determines which events in the Status Byte register can set the Master Summary bit (MSB) in the Status Byte Register. Any bits that are set to 1 will cause the MSS bit to be set.

Syntax \*SRE <NR1>

Query Syntax \*SRE?

Parameter/ Return parameter	<NR1> (bit weight)	Bit number / Description
1		0/Not used
2		1/ERR
4		2/ CSUM
8		3/ QUES
16		4/ MAV
32		5/ ESB
64		6/ RQS_MSS

128 7/ OPER

Note: Bit 1 and 2 cannot be set, however bit 1 (ERR) can be returned.

Example \*SRE 8  
Sets bit 3 of the Service Request Enable register.

Query example \*SRE?  
>12  
Bits 2 and 3 are set in the Service Request Enable register.

**\*STB?** → Query

Description Reads the Status Byte register. This command will not clear the Status Byte register.  
If the Master Summary Status bit (MSS) is set, it indicates that there is a reason for a service request.

Query Syntax \*STB?

Return parameter	<NR1> (bit weight)	Bit number / Description
	1	0/Not used
	2	1/ERR
	4	2/ CSUM
	8	3/ QUES
	16	4/ MAV
	32	5/ ESB
	64	6/ RQS_MSS
	128	7/ OPER

Note: Bit 1 and 2 cannot be set, however bit 2 (ERR) can be returned.

Query example \*STB?  
>36  
Bits 2 and 5 are set in the Status Byte register.



**\*TRG**

Set →

---

Description This command triggers the unit.

---

Syntax \*TRG

**\*TST?**

→ Query

---

Description This command is a standard SCPI self-test command. The PEL-3000E does not perform any self-tests so will always return 0 (pass) for this command.

---

Query Syntax \*TST?

---

Return parameter <NR1>  
0 Pass

---

Query example \*TST?  
>0

---

**\*WAI**

Set →

---

Description Wait command. Prevents new operations from executing until all pending operations have finished.

---

Syntax \*WAI

## Trigger Commands

Trigger States .....	32
:ABORt .....	32
:INPut[:STATe]:TRIGgered .....	33
:INITiate[:IMMediate] .....	33
:INITiate:CONtInuous .....	33
:CONDuctance[:VA]:TRIGgered .....	34
:CURRent[:VA]:TRIGgered .....	34
:RESistance[:VA]:TRIGgered .....	35
:TRIGger[:Delay]:Time .....	35
:TRIGger[:PULSe]:WIDTh .....	35

## Trigger States

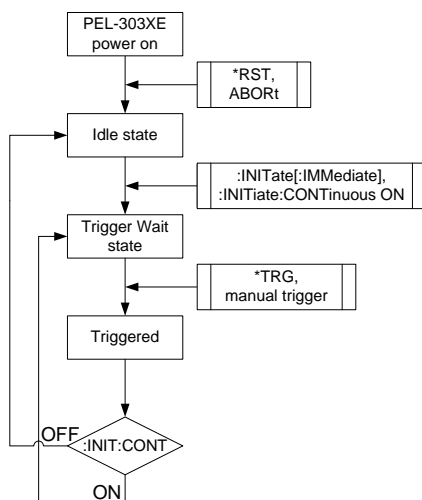

### :ABORt

Set →

**Description** Clears the trigger wait status and returns to the idle state.

**Query Syntax** :ABORt

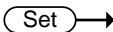
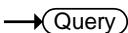
**:INPut[:STATe]:TRIGgered** 



Description	Turn ON/OFF the trigger input.	
Syntax	:INPut[:STATe]:TRIGgered {<Boolean> OFF   ON }	
Query Syntax	:INPut[:STATe]:TRIGgered?	
Parameter	OFF or 0	Trigger input = OFF
	ON or 1	Trigger input = ON
Return parameter	0	Trigger input = OFF
	1	Trigger input = ON
Example	:INPut:TRIGgered ON Turns on the trigger input.	
Query example	:INPut:TRIGgered? >0 Indicates that the trigger input is turned off.	

**:INITiate[:IMMEDIATE]** 

**Description** Sets the trigger to the wait state. If the trigger is activated, the trigger will automatically go to the idle state.

**Query Syntax** :INITiate[:IMMEDIATE]

**:INITiate:CONTInuous** 



**Description** Sets or queries whether the trigger will go back to the wait state or go to the idle state after a trigger. When the :INITiate:CONTInuous function is set to OFF, the trigger state can only be returned to idle if the \*RST or ABORT command is used

**Syntax** :INITiate:CONTInuous {<Boolean>|OFF | ON }

**Query Syntax** :INITiate:CONTInuous?

Parameter	OFF or 0	Continuous = OFF
	ON or 1	Continuous = ON

Return parameter	0	Continuous = OFF
	1	Continuous = ON

**Example** :INITiate:CONTInuous ON  
 Configures the trigger to go to the wait state after a trigger.

**Query example** :INITiate:CONTInuous?  
 >1  
 Indicates that the trigger will to go to the wait state after a trigger.

**:CONDuctance[:VA]:TRIGgered** (Set) →

**Description** Sets the conductance value for when the trigger is activated.

**Syntax** :CONDuctance[:VA]:TRIGgered {<NR2>[ mS ] |MINimum | MAXimum }

Parameter	<NR2>[ mS ]	Conductance in millisiemens(mS).
	MINIMUM or MIN	MINIMUM value.
	MAXIMUM or MAX	MAXIMUM value.

**Example** :CONDuctance:TRIGgered MAX  
 Sets the conductance to the maximum value.

**:CURRent[:VA]:TRIGgered** (Set) →

**Description** Sets the current generated when the trigger is activated.

**Syntax** :CURRent[:VA]:TRIGgered {<NR2>[ A ] |MINimum | MAXimum }

Parameter	<NR2>[ A ]	Current in amps.
	MINIMUM or MIN	MINIMUM value.
	MAXIMUM or MAX	MAXIMUM value.

**Example** :CURRent:TRIGgered MAX  
 Sets the current generated to the maximum value.

**:RESistance[:VA]:TRIGgered** (Set) →

Description	Sets the resistance for when the trigger is activated.	
Syntax	:RESistance[:VA]:TRIGgered {<NR2>[OHM]  MINimum   MAXimum }	
Parameter	<NR2>[OHM] MINIMUM or MIN MAXIMUM or MAX	Resistance in ohms. MINIMUM value. MAXIMUM value.
Example	:RESistance:TRIGgered MAX Sets the resistance to the maximum value.	

**:TRIGger[:Delay]:Time** (Set) →  
→ (Query)

Description	The command determines how long to delay any action after a trigger is received. Equivalent to using the “Trig In Delay” setting on the front panel.	
Syntax	:TRIGger[:Delay]:Time <NR2> MINimum MAXimum	
Query Syntax	:TRIGger[:Delay]:Time? [MINimum MAXimum]	
Parameter/ Return Parameter	<NR2> MINimum MAXimum	0 ~ 0.005s (0 ~ 5000µs) Minimum delay time Maximum delay time
Example	:TRIG:T MAX Sets the trigger in delay to 5ms.	
Query example	:TRIG:T? >0.0050000 Returns the delay time in seconds.	

**:TRIGger[:PULSE]:WIDTH** (Set) →  
→ (Query)

Description	Sets the trigger output signal’s pulse width.	
Syntax	:TRIGger[:PULSE]:WIDTH <NR2> MINimum MAXimum	

Query Syntax	:TRIGger[:PULSE]:WIDTh? [MINimum MAXimum]	
Parameter/	<NR2>	0.0000025~0.005s (2.5μs ~ 5000μs)
Return Parameter	MINimum	Minimum pulse width
	MAXimum	Maximum pulse width
Example	:TRIG:WIDT MAX Sets the trigger pulse width to 5ms.	
Query example	:TRIG:WIDT? >0.0050000 Returns the pulse width of the trigger output.	

## Input State Commands

:INPut .....	37
:INPut:SHORT.....	37
:INPut:MODE .....	38

### :INPut

Set →

→ Query

Description	Sets or queries the status of the load.	
Syntax	:INPut {<Boolean> OFF   ON }	
Query Syntax	:INPut?	
Parameter	OFF or 0 ON or 1	Load = OFF Load = ON
Return parameter	0 1	Load = OFF Load = ON
Example	:INPut ON Turns the load on.	
Query example	:INPut? >0 Indicates that the load is off.	

### :INPut:SHORT

Set →

→ Query

Description	Shorts or opens the input terminals or queries their status.	
Syntax	:INPut:SHORT {<Boolean> OFF   ON }	
Query Syntax	:INPutSHORT?	
Parameter	OFF or 0 ON or 1	Short = OFF Short = ON
Return parameter	0 1	Short = OFF Short = ON
Example	:INPut:SHORT ON Shorts the input terminals.	

Query example :INPut:SHORT?  
 >0  
 Indicates that the short function is off.

:INPut:MODE

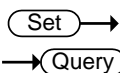

Description Selects the load function mode.

Syntax :INPut:MODE{ LOAD|PROG|NSEQ|FSEQ }

Query Syntax :INPut:MODE?

Parameter/ Return parameter	LOAD	Sets the load to generator as a CC/CV/CP/CR load.
	PROG	Sets the function mode to program.
	NSEQ	Sets the function mode to Normal Sequence mode.
	FSEQ	Sets the function mode to Fast Sequence mode.

Example :INPut:MODE PROG  
 Puts the load generator into Program mode.

Query example :INPut:MODE?  
 >PROG  
 Indicates that the current function mode is Program.



## Measurement Commands

:MEASure:CURRent?	39
:MEASure:VOLTagE?	39
:MEASure:POWer?	39
:MEASure:ETIMe?	40

### :MEASure:CURRent? → Query

Description	This command returns the load current.	
Query Syntax	:MEASure:CURRent?	
Return parameter	<NR2>	Load current in amps
Query example	:MEASure:CURRent? >0.79860	
	Returns the load current in amps.	

### :MEASure:VOLTagE? → Query

Description	This command returns the load voltage.	
Query Syntax	:MEASure:VOLTagE?	
Return parameter	<NR2>	Load voltage in volts
Query example	:MEASure:VOLTagE? >1.49900	
	Returns the load voltage in volts.	

### :MEASure:POWer? → Query

Description	This command returns the power.	
Query Syntax	:MEASure:POWer?	
Return parameter	<NR2>	Power in watts
Query example	:MEASure:POWer? >1.19695	
	Returns the power in watts.	

:MEASure:ETIMe?

→ Query

Description	Returns the amount of time the load has been on for in seconds (elapsed time).
-------------	--

Query Syntax	:MEASure:ETIMe?
--------------	-----------------

Return parameter	<code>&lt;NR2&gt;</code>	Elapsed time in seconds
------------------	--------------------------	-------------------------

Query example	:MEASure:ETIMe? >316.0
---------------	---------------------------

Returns the elapsed time in seconds.

## Fetch Subsystem

:FETCh:VOLTAge? .....	41
:FETCh:CURREnt? .....	41
:FETCh:POWEr? .....	41

### :FETCh:VOLTAge? → Query

Description	This query returns the real-time voltage of the load input.	
Query syntax	:MODE?	
Return parameter	<NR2>	Voltage in volts
Query example	:FETC:VOLT? >11.2 The load has a voltage of 11.2 volts at the input.	

### :FETCh:CURREnt? → Query

Description	This query returns the real-time current of the load input.	
Query syntax	:FETCh:CURREnt? <NR2>	
Return parameter	<NR2>	Current in amps
Query example	:FETC:CURREnt? >1.2 The load has a current of 1.2 amps at the input.	

### :FETCh:POWEr? → Query

Description	This query returns the real-time power of the load input.	
Query syntax	:FETCh:POWEr? <NR2>	

Return parameter	<NR2>	Power in watts
------------------	-------	----------------

---

Query example :FETC:POW?  
>1.2

The load is at 1.2 watts.

## Configure Subsystem Commands

[:CONFigure]:OCP.....	43
[:CONFigure]:OPP.....	44
[:CONFigure]:UVP.....	45
[:CONFigure]:OVP .....	45
[:CONFigure]:SStart.....	46
[:CONFigure]:VON .....	47
[:CONFigure]:VDElay.....	47
[:CONFigure]:CNTime.....	48
[:CONFigure]:COTime.....	48
[:CONFigure]:CRUNit.....	49
:CONFigure:DYNamic.....	49
:CONFigure:MEMory.....	50
:CONFigure:SHORt.....	51
:CONFigure:SHORt:SAFety.....	51
[:CONFigure]:GNG:SPEctest.....	52
[:CONFigure]:GNG:DTIME .....	52
[:CONFigure]:GNG:MODE.....	53
[:CONFigure]:GNG:[PASS] .....	53
[:CONFigure]:GNG:H.....	54
[:CONFigure]:GNG:L .....	54
[:CONFigure]:GNG:C .....	55

[:CONFigure]:OCP 

Description	Sets or queries the OCP trip settings. The OCP limit can be set to a specific value or the trip setting can be set to either limit the current or to turn the load off.
Syntax	[:CONFigure]:OCP {<NRf>[ A ]   MINimum   MAXimum   LIMit   LOFF   OFF }
Query Syntax	[:CONFigure]:OCP?

Parameter	<NRf>[A] MINIMUM or MIN MAXIMUM or MAX LIMIT or LIM LOFF OFF	Current limit value. Minimum current limit value. MAXimum current limit value. Limit the load Turn the load off Turn the unit off
Return parameter	Returns a string with OCP setting followed by the OCP value.	
Example1	:OCP LIM Sets the OCP setting to limit.	
Example2	:OCP 63.000 Sets the OCP value to 63A.	
Query example	:OCP? >LIMIT, 63.000 The OCP setting is LIMIT and the OCP value is 64.000A.	

**[[:CONFigure]:OPP**

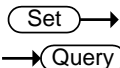

Description	Sets or queries the OPP trip settings. The OPP limit can be set to a specific value or the trip setting can be set to either limit the power or to turn the load off.	
Syntax	[:CONFigure]:OPP {<NRf> [W]   MINimum   MAXimum   LIMit   LOFF   OFF }	
Query Syntax	[:CONFigure]:OPP?	
Parameter	<NRf>[W] MINIMUM or MIN MAXIMUM or MAX LIMIT or LIM LOFF OFF	Power limit value. MINIMUM power limit value. MAXIMUM power limit value. Limit the load Turn the load off Turn the unit off

Return parameter Returns a string with OPP setting followed by the OPP value.

Example1 :OPP LIMIT  
Sets the OCP setting to limit.

Example2 :OPP 10.000  
Sets the OPP value to 10W.

Query example :OPP?  
>LIMIT, 10.000  
The OPP setting is LIMIT and the OPP value is 10.000W.

Set →

→ Query

**[[:CONFigure]:UVP**

Description Sets or queries the UVP trip settings. The UVP can also be cleared with this command.

Syntax [[:CONFigure]:UVP {<NRf>[ V ] |MINimum | MAXimum }

Query Syntax [[:CONFigure]:UVP?

Parameter	<NRf>[V] MINIMUM or MIN	voltage limit value. MINIMUM value.
	MAXIMUM or MAX	MAXIMUM value.

Return parameter Returns the UVP level (<NR2>)

Example1 :UVP 10.00  
Sets the UVP setting to 10V.

Query example :UVP?  
> 10.0000  
The UVP setting is 10.0000V.

Set →

→ Query

**[[:CONFigure]:OVP**

Description Sets or queries the OVP trip settings. The OVP can also be cleared with this command.

Syntax	[:CONFigure]:OVP {<NRf>[ V ]   MINimum  MAXimum}	
Query Syntax	[:CONFigure]:OVP?	
Parameter	<NRf>[V] MINIMUM or MIN MAXIMUM or MAX	voltage limit value. MINIMUM value. MAXIMUM value.
Return parameter	Returns the OVP level (<NR2>).	
Example1	:OVP 10.00 Sets the OVP setting to 10V.	
Query example	:OVP? > 10.0000 The OVP setting is 10.0000V.	

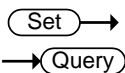

**[:CONFigure]:SStart**

Description	Sets or queries the Soft Start time setting.	
Syntax	[:CONFigure]:SStart {<NRf>[s]   MINimum  MAXimum   OFF }	
Query Syntax	[:CONFigure]:SStart?	
Parameter	<NRf>[s] MINIMUM or MIN MAXIMUM or MAX OFF	The soft start time in seconds. Minimum time = 0 second Maximum time OFF = 0 second
Return parameter	<NR2> OFF	Returns the soft start time in seconds. Off
Example	:SStart OFF Turns the soft start function off.	
Query example	:SStart? >OFF The soft start function is off.	



**[[:CONFigure]:VON** 



Description	Sets or queries the Von voltage settings.	
Syntax	[:CONFigure]:VON {<NRf>[ V ]   MINimum   MAXimum   LON   LOFF }	
Query Syntax	[:CONFigure]:VON?	
Parameter	{<NRf>[ V ] MINIMUM or MIN MAXIMUM or MAX LON LOFF	The Von voltage level (default unit is V) Minimum Von voltage level Maximum Von voltage level Latch on Latch off
Return parameter	<ASCII string>	Returns the Von latch settings.
Example	:VON 10.0V Sets the Von voltage to 10.0 volts.	
Query example	:VON? >Latch OFF, 10.000 The Von voltage level is 10V.	

**[[:CONFigure]:VDElay** 



Description	Sets or queries the Von Delay settings in seconds.	
Syntax	[:CONFigure]:VDElay {<NRf>[s]   MINimum   MAXimum   OFF }	
Query Syntax	[:CONFigure]:VDElay?	
Parameter	<NRf>[s] OFF MINIMUM or MIN MAXIMUM or MAX	The delay time in seconds Disable the delay time Minimum delay time Maximum delay time
Return parameter	<NR2>	Returns the delay time in seconds

Example :VDElay 1.5 ms  
 Sets the delay time to 1.5ms.  
 :VDElay 0.0015 s  
 Sets the delay time to 1.5ms.

Query example :VDElay?  
 >0.0015  
 The delay time is 1.5ms.

**[[:CONFIgure]:CNTime**

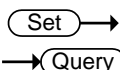

Description Turns the Count Time timer function on or off.

Syntax [[:CONFIgure]:CNTime {<Boolean> |OFF | ON }

Query Syntax [[:CONFIgure]:CNTime?

Parameter/ Return parameter	OFF or 0	Turns the Count Time timer off.
	ON or 1	Turns the Count Time timer on

Example [[:CONFIgure]:CNTime ON  
 Turns the Count Time timer on.

Query example [[:CONFIgure]:CNTime?  
 >ON  
 Count Time is turned on.

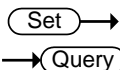

**[[:CONFIgure]:COTime**

Description Sets or queries the load cutoff time. A cutoff time of 0 seconds is the equivalent of disabling the cutoff time.

Syntax [[:CONFIgure]:COTime {<NRF>[s] | MINimum | MAXimum | OFF }

Query Syntax [[:CONFIgure]:COTime?

Parameter	<NRF>[s]	Cut off time in seconds (1~3599999)
	OFF	Turns the cutoff time off.

	MINIMUM or MIN	Sets the cutoff time to the maximum
	MAXIMUM or MAX	Sets the cutoff time to the minimum
Return parameter	<NR1>	Returns the cutoff time

Example :COTime MAX  
Sets the cutoff time to the maximum.

Query example :COTime?  
>3599999  
The cutoff time is set to 3599999 seconds.

**[[:CONFigure]:CRUNit** (Set) →  
→ (Query)

Description Sets or queries the CR mode setting units.

Syntax [[:CONFigure]:CRUNit {OHM|MHO}

Query Syntax [[:CONFigure]:CRUNit?

Parameter/	OHM	Set the units to ohms.
Return parameter	MHO	Set the units to mho (conductance)

Example :CRUNit OHM  
Sets the CR mode units to ohms.

Query example :CRUNit?  
>OHM  
The CR mode units are ohms.

**:CONFigure:DYNamic** (Set) →  
→ (Query)

Description Sets the display units for when dynamic mode switching is used. Units can be selected from Percent and Value. See the user manual for further details. This command will also configure whether to switch between each level using timers or a set duty cycle.

Syntax :CONFigure:DYNamic { VALue | PERCent | TIME | FDUTy }

Query Syntax	:CONFigure:DYNamic?	
Parameter	VALUE or VAL	Set the units to Value.
	PERCENT or PERC	Set the units to Percent.
	TIME	Use timers for timing.
	FDUTY or FUdT	Use duty cycle for timing.
Return parameter	<ASCII string>	Return a string containing the unit mode and the timing mode.

Example :CONFigure:DYNamic VALue  
Sets the dynamic mode units to value.

Query example :CONFigure:DYNamic?  
> Value,T1,T2  
The dynamic mode becomes a value setup and timer setup.

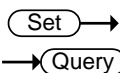

**:CONFigure:MEMory**

Description This command configures the how the files are recalled *in local mode* (using the front panel interface). By default when you try to recall a file or setting from memory, a message will appear asking you to press the Enter key to confirm each time you wish to recall. This command enables (SAFety) or disables this feature (DIRect).

Syntax :CONFigure:MEMory {SAFety | DIRect }

Query Syntax :CONFigure:MEMory?

Parameter	SAFETY or SAF	Safety setting.
	DIRECT or DIR	Directly recall the chosen file.

Return parameter	Safety	Safety setting.
	Direct	Directly setting.

Example :CONFigure:MEMory SAFety  
Enables the safety setting.

Query example :CONFigure:MEMory?  
 >Safety  
 The safety setting is enabled.

Set →

→ Query

**:CONFigure:SHORT**

Description	Configures the short key.	
Syntax	:CONFigure:SHORT { TOGGLE   HOLD }	
Query Syntax	:CONFigure:SHORT?	
Parameter	HOLD	Sets the button configuration to hold
	TOGGLE or TOGG	Sets the button configuration to toggle
Return parameter	Toggle	Toggle
	Hold	Hold
Example	:CONFigure:SHORT TOGGLE Sets the Short key configuration to toggle.	

Query example :CONFigure:SHORT?  
 >Toggle  
 The Short key is configured to toggle.

Set →

→ Query

**:CONFigure:SHORT:SAFety**

Description	Turns the Short Safety function on/off. The short safety function requires the load to already be turned on before the load can be shorted using the Short key or :INPut:SHORT command.	
Syntax	:CONFigure:SHORT:SAFety {<bool> OFF ON}	
Query Syntax	:CONFigure:SHORT:SAFety?	
Parameter	OFF   0	Turns Short Safety off.
	ON   1	Turns Short Safety on.
Return parameter	OFF	Short Safety is off.
	ON	Short Safety is on.

Example :CONF:SHOR:SAF OFF  
Turns Short Safety off.

Query example :CONF:SHOR:SAF?  
>OFF  
Short Safety is turned off.

Set →  
 → Query

Description Enables/Disables Go-NoGo testing (SPEC test = ON/SPEC test = OFF).

Syntax [:CONFigure]:GNG:SPECtest {<Boolean>|OFF | ON }

Query Syntax [:CONFigure]:GNG:SPECtest?

Parameter/	OFF or 0	SPEC test = OFF
Return parameter	ON or 1	SPEC test = ON

Example :GNG:SPECtest ON  
Turns Go-NoGo testing on.

Query example :GNG:SPECtest?  
>OFF  
Indicates that Go-NoGo testing is off.

Set →  
 → Query

Description Sets or queries the Go-NoGo delay time.

Syntax [:CONFigure]:GNG:DTIME {<NRf>[s] | MINimum | MAXimum }

Query Syntax [:CONFigure]:GNG:DTIME?

Parameter	<b>&lt;NRf&gt;[s]</b>	Sets the Go-NoGo delay time in seconds (0.0~1.0) with 0.1 second resolution.
	MINIMUM or MIN	Minimum delay time
	MAXimum or MAX	Maximum delay time

Return parameter	<b>&lt;NR2&gt;</b>	Returns the delay time in seconds.
------------------	--------------------	------------------------------------

Example	:GNG:DTIME 0.5 Sets the delay time to 0.5 seconds.
Query example	:GNG:DTIME? >0.5 The delay time is 0.5 seconds.

**[[:CONFigure]:GNG:MODE** (Set) →  
→ (Query)

Description	Sets or queries the entry mode for the Go-NoGo settings. The entry mode determines whether the Go-NoGo limits are set as values or as a percentage value from a center reference value.	
Syntax	[:CONFigure]:GNG:MODE {PERCent   VALue }	
Query Syntax	[:CONFigure]:GNG:MODE?	
Parameter	PERCENT or PERC VALUE or VAL	Sets the entry mode to %. Sets the entry mode to value
Return parameter	Percent Value	% entry mode Value entry mode
Example	:GNG:MODE PERCent Sets the entry mode to %.	
Query example	:GNG:MODE? >Percent The entry mode is %.	

**[[:CONFigure]:GNG[:PASS]** → (Query)

Description	Queries the Go-NoGo test result(s). This command can be used for all test modes (CC, CV, CR, CP).	
Query Syntax	[:CONFigure]:GNG[:PASS]?	
Return parameter	NG GO	No Go (fail) Go (Pass)
Query example	:GNG? >GO Returns the Go-NoGo test result.	

Set →

→ Query

**[:CONFigure]:GNG:H**

**Description** Sets or queries the high voltage/current limit value. If the entry mode is set to value, the high voltage/current limit value units are in volts/amps. If the entry mode is set to percent, the high voltage/current limit value units are in percent.

**Syntax** [:CONFigure]:GNG:H <NRf>

**Query Syntax** [:CONFigure]:GNG:H?

**Parameter** <NRf> Sets the high voltage/current limit value in volts/amps or in percent.

**Return parameter** <NR2> Returns the high voltage/current limit value in volts/amps or as %.

**Example** :GNG:H 100.0  
Sets the high voltage limit value to 100%.

**Query example** :GNG:H?  
>100.0  
Returns the high voltage limit value as 100.0%.

Set →

→ Query

**[:CONFigure]:GNG:L**

**Description** Sets or queries the low voltage/current limit value. If the entry mode is set to value, the low voltage/current limit value units are in volts/amps. If the entry mode is set to percent, the low voltage/current limit value units are in percent.

**Syntax** [:CONFigure]:GNG:L <NRf>

**Query Syntax** [:CONFigure]:GNG:L?



Parameter	<NRf>	Sets the low voltage/current limit value in volts/amps or in percent.
Return parameter	<NR2>	Returns the low voltage/current limit value in volts/amps or as %.
Example	:GNG:L 10.0 Sets the low voltage limit value to 10%.	
Query example	:GNG:L? >10.0 Returns the low voltage limit value as 10.0%.	
[:CONFigure]:GNG:C		
Description	Sets or queries the center voltage/current limit value. The center voltage limit value is used as the center reference value when the entry mode is set to percent ([:CONFigure]:GNG:Mode=PERCent).	
Syntax	[:CONFigure]:GNG:C <NRf>	
Query Syntax	[:CONFigure]:GNG:C?	
Parameter	<NRf>	Sets the center voltage/current limit value in volts/amps.
Return parameter	<NR2>	Returns the center voltage/current limit value in volts/amps.
Example	:GNG:C 10.0 Sets the center voltage/current limit value to 10V or A.	

## Step Resolution Commands

[:CONFigure]:STEP:CCH.....	56
[:CONFigure]:STEP:CCL.....	57
[:CONFigure]:STEP:CC.....	57
[:CONFigure]:STEP:CRH.....	58
[:CONFigure]:STEP:CRL.....	58
[:CONFigure]:STEP:CR.....	59
[:CONFigure]:STEP:CVH.....	59
[:CONFigure]:STEP:CVL.....	60
[:CONFigure]:STEP:CV.....	60
[:CONFigure]:STEP:CPH.....	61
[:CONFigure]:STEP:CPL.....	61
[:CONFigure]:STEP:CP.....	62

Set →

→ Query

### [:CONFigure]:STEP:CCH

**Description** Configures the step resolution for CC High Range.  
 Note: The step resolution setting will be automatically rounded to the closest multiple of the base resolution.

**Syntax** [:CONFigure]:STEP:CCH {<NRf>[ A ] | MINimum | MAXimum }

**Query Syntax** [:CONFigure]:STEP:CCH?

<b>Parameter</b>	<NRf>[ A ]	Step resolution.
	MINIMUM or MIN	Minimum step resolution
	MAXIMUM or MAX	Maximum step resolution

<b>Return parameter</b>	<ASCII string>	Returns the range and the step resolution.
-------------------------	----------------	--

**Example** :STEP:CCH 0.002A  
 Sets the step resolution to 0.002A.

**Query example** :STEP:CCH?  
 > CCH:0.002  
 Returns the step resolution (0.002A).

Set →

→ Query

**[[:CONFigure]:STEP:CCL**

Description	Configures the step resolution for CC low Range. Note: The step resolution setting will be automatically rounded to the closest multiple of the base resolution.	
Syntax	[:CONFigure]:STEP:CCL {<NRf>[ A ]   MINimum   MAXimum }	
Query Syntax	[:CONFigure]:STEP:CCL?	
Parameter	<NRf>[ A ] MINIMUM or MIN MAXIMUM or MAX	Step resolution. Minimum step resolution Maximum step resolution
Return parameter	<ASCII string>	Returns the range and the step resolution.
Example	:STEP:CCL 0.02mA Sets the step resolution to 0.02mA.	
Query example	:STEP:CCL? > CCL:0.00002 Returns the step resolution (0.00002A).	

**[[:CONFigure]:STEP:CC**

→ Query

Description	Returns the step resolution for each CC Mode range as a string.	
Query Syntax	[:CONFigure]:STEP:CC?	
Return parameter	<ASCII string>	Returns the CCH and CCL step resolution settings.
Query example	:STEP:CC? >CCH:0.002, CCL:0.0002 Returns the CC mode step resolution for each range.	

Set →

→ Query

**[:CONFigure]:STEP:CRH**

**Description** Configures the step resolution for CR High Range. Note: The step resolution setting will be automatically rounded to the closest multiple of the base resolution.

**Syntax** [:CONFigure]:STEP:CRH {<NRf>[mS] | MINimum | MAXimum }

**Query Syntax** [:CONFigure]:STEP:CRH?

<b>Parameter</b>	<NRf>[mS] MINIMUM or MIN MAXIMUM or MAX	Step resolution (Unit: mS) Minimum step resolution Maximum step resolution
------------------	---	--

<b>Return parameter</b>	<ASCII string>	Returns the range and the step resolution.
-------------------------	----------------	--

**Example** :STEP:CRH 2  
Sets the step resolution to 2 mS.

**Query example** :STEP:CRH?  
>CRH:2.00000  
Returns the step resolution (2 mS).

Set →

→ Query

**[:CONFigure]:STEP:CRL**

**Description** Configures the step resolution for CR Low Range. Note: The step resolution setting will be automatically rounded to the closest multiple of the base resolution.

**Syntax** [:CONFigure]:STEP:CRL {<NRf>[mS] | MINimum | MAXimum }

**Query Syntax** [:CONFigure]:STEP:CRL?

<b>Parameter</b>	<NRf>[mS] MINIMUM or MIN MAXIMUM or MAX	Step resolution (Unit: mS) Minimum step resolution Maximum step resolution
------------------	---	--

<b>Return parameter</b>	<ASCII string>	Returns the range and the step resolution.
-------------------------	----------------	--

Example	:STEP:CRL 20 Sets the step resolution to 20mS.
Query example	:STEP:CRL? >CRL:20.0 Returns the step resolution (20 mS).

**[[:CONFigure]:STEP:CR → Query**

Description	Returns the step resolution for each CR Mode range as a string.	
Query Syntax	[:CONFigure]:STEP:CR?	
Return parameter	<ASCII string>	Returns the CRH and CRL step resolution settings (in mS).
Query example	:STEP:CR? > CRH:2.00000, CRL:20.0 Returns the CR mode step resolution for each range (mS).	

Set →

**[[:CONFigure]:STEP:CVH → Query**

Description	Configures the step resolution for CV High Range. Note: The step resolution setting will be automatically rounded to the closest multiple of the base resolution.	
Syntax	[:CONFigure]:STEP:CVH{<NRf>[ V ]   MINimum   MAXimum}	
Query Syntax	[:CONFigure]:STEP:CVH?	
Parameter	<NRf>[ V ] MINIMUM or MIN MAXIMUM or MAX	Step resolution. Minimum step resolution Maximum step resolution
Return parameter	<ASCII string>	Returns the range and the step resolution.
Example	:STEP:CVH 0.5V Sets the step resolution to 0.5V.	

Query example :STEP:CVH?  
 > CVH:0.500  
 Returns the step resolution (0.5V).

Set →

**[[:CONFIgure]:STEP:CVL**

→ Query

**Description** Configures the step resolution for CV Low Range.  
 Note: The step resolution setting will be automatically rounded to the closest multiple of the base resolution.

**Syntax** [[:CONFIgure]:STEP:CVL{<NRf>[ V ] | MINimum | MAXimum}

**Query Syntax** [[:CONFIgure]:STEP:CVL?

<b>Parameter</b>	<NRf>[ V ]	Step resolution.
	MINIMUM or MIN	Minimum step resolution
	MAXIMUM or MAX	Maximum step resolution

<b>Return parameter</b>	<ASCII string>	Returns the range and the step resolution.
-------------------------	----------------	--

**Example** :STEP:CVL 0.05V  
 Sets the step resolution to 0.001V.

**Query example** :STEP:CVL?  
 > CVL:0.0500  
 Returns the step resolution (0.05V).

**[[:CONFIgure]:STEP:CV**

→ Query

**Description** Returns the step resolution for each CV Mode range as a string.

**Query Syntax** [[:CONFIgure]:STEP:CV?

<b>Return parameter</b>	<ASCII string>	Returns the CVH and CVL step resolution settings.
-------------------------	----------------	---

**Query example** :STEP:CV?  
 >CVH:0.500, CVL:0.0500  
 Returns the CV mode step resolution for each range.

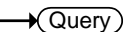
**[[:CONFigure]:STEP:CPH**

---

Description	Configures the step resolution for CP High Range. Note: The step resolution setting will be automatically rounded to the closest multiple of the base resolution.	
Syntax	[:CONFigure]:STEP:CPH {<NRf>[ W ]   MINimum   MAXimum }	
Query Syntax	[:CONFigure]:STEP:CPH?	
Parameter	<NRf>[ W ] MINIMUM or MIN MAXIMUM or MAX	Step resolution. Minimum step resolution Maximum step resolution
Return parameter	<ASCII string>	Returns the range and the step resolution.
Example	:STEP:CPH 1 Sets the step resolution to 0.01W.	
Query example	:STEP:CPH? >CPH:1.00 Returns the step resolution (1W).	

**[[:CONFigure]:STEP:CPL**

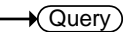
---

Description	Configures the step resolution for CP Low Range. Note: The step resolution setting will be automatically rounded to the closest multiple of the base resolution.	
Syntax	[:CONFigure]:STEP:CPL {<NRf>[ W ]   MINimum   MAXimum }	
Query Syntax	[:CONFigure]:STEP:CPL?	
Parameter	<NRf>[ W ] MINIMUM or MIN MAXIMUM or MAX	Step resolution. Minimum step resolution Maximum step resolution
Return parameter	<ASCII string>	Returns the range and the step resolution.

Example :STEP:CPL 0.1  
Sets the step resolution to 0.0001W.

Query example :STEP:CPL?  
>CPL:0.100  
Returns the step resolution (0. 1W).

**[[:CONFigure]:STEP:CP → Query**

Description Returns the step resolution for each CP Mode range as a string.

Query Syntax [[:CONFigure]:STEP:CP?

Return parameter <ASCII string>	Returns the CPH and CPL step resolution settings.
---------------------------------	---

Query example :STEP:CP?  
> CPH:1.00, CPL:0.100  
Returns the CP mode step resolution for each range.



## External Control Commands

<code>[:CONFigure]:EXTErnal[:CONTRol]</code> .....	63
<code>[:CONFigure]:EXTErnal:LOADonin</code> .....	63

`[:CONFigure]:EXTErnal[:CONTRol]` 

**Description**      Configures the unit for external control or disables external control.

**Syntax**            `[:CONFigure]:EXTErnal[:CONTRol] {OFF | VOLTage | RESistance | RINV }`

**Related Commands**      `[:CONFigure]:EXTErnal[:CONTRol]?`

<b>Parameter</b>	OFF	Disables external control
	VOLTAGE or VOLT	Sets the unit to external voltage control
	RESISTANCE or RES	Sets the unit to external resistance control
	RINV	Sets the unit to external resistance (inverted) control
<b>Return Parameter</b>	<ASCII string>	Returns the external control configuration

**Example**            `:EXTErnal VOLT`  
 Turns external control voltage control on.

**Query example**    `:EXTErnal?`  
`>voltage`  
 The unit uses external voltage control.

`[:CONFigure]:EXTErnal:LOADonin` 

**Description**      The LOADonin settings determine whether the load is turned on when an external switch is closed (LOW) or open (HIGH).

Syntax	[:CONFigure]:EXTErnal:LOADonin {OFF   HIGH  LOW }	
Related Commands	[:CONFigure]:EXTErnal:LOADonin?	
Parameter	OFF HIGH LOW	LoadOnIN = OFF LoadOnIN = OPEN LoadOnIN = CLOSE
Return Parameter	<ASCII string>	Returns the Loadonin configuration as a string.
Example	:EXTErnal:LOADonin OFF Turns external control off.	
Query example	:EXTErnal:LOADonin? > OFF External control is off	

## Mode Subsystem Commands

:MODE.....	65
[:MODE]:CRANge.....	65
[:MODE]:VRANge.....	66
[:MODE]:DYNamic.....	66

### :MODE

Set →

→ Query

Description	Sets the operating mode.	
Syntax	:MODE {CC   CR   CV   CP   CCCV   CRCV   CPCV }	
Query Syntax	:MODE?	
Parameter/Return parameter	CC	CC mode
	CR	CR mode
	CV	CV mode
	CP	CP mode
	CCCV	CC + CV mode
	CRCV	CR + CV mode
	CPCV	CP + CV mode
Example	:MODE CC Sets the mode to CC mode.	
Query example	:MODE? >CC Returns the operating mode (CC mode).	

Set →

→ Query

### [:MODE]:CRANge

Description	Configures the current range for all the applicable operating modes.	
Syntax	[:MODE]:CRANge {HIGH   LOW }	
Query Syntax	[:MODE]:CRANge?	
Parameter	HIGH	High range
	LOW	Low range
Return parameter	High	High range

	Low	Low range
Example	:CRANge LOW Sets the current range to Low.	
Query example	:CRANge? >Low The current range is set to Low.	

Set →  
 → Query

---

**[[:MODE]:VRANge**

Description	Configures the voltage range for all the applicable operating modes.	
Syntax	[:MODE]:VRANge {HIGH   LOW }	
Query Syntax	[:MODE]:VRANge?	
Parameter	HIGH LOW	High range Low range
Return parameter	High Low	High range Low range
Example	:VRANge LOW Sets the voltage range to Low.	
Query example	:VRANge? >LOW The voltage range is set to Low.	

Set →  
 → Query

---

**[[:MODE]:DYNamic**

Description	Sets or queries the switching mode. Dynamic is the default mode.	
Syntax	:MODE:DYNamic{ DYNamic   STATic }	
Query Syntax	:MODE:DYNamic?	
Parameter	DYNAMIC or DYN STATIC or STAT	Set to Dynamic mode Set to Static mode
Return parameter	<ASCII string>	Returns the switching mode.

Example	:MODE:DYNamic STAT Set the switching mode to dynamic
Query example	:MODE:DYNamic? > STATIC The switching mode is set to static mode.

## Current Subsystem Commands

:CURRent:RECall.....	68
:CURRent[:VA].....	69
:CURRent:VB .....	69
:CURRent:SRATe .....	70
:CURRent:L1.....	70
:CURRent:L2.....	71
:CURRent:SET .....	72
:CURRent:LEVel.....	72
:CURRent:RISE.....	73
:CURRent:FALL .....	73
:CURRent:T1 .....	74
:CURRent:T2 .....	75
:CURRent:FREQuency .....	75
:CURRent:DUTY.....	76
:CURRent:CV:RESPonse .....	77

### :CURRent:RECall

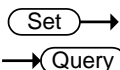

Description	Sets or queries whether A Value or B Value is the currently active value in CC static mode.	
Syntax	:CURRent:RECall {<bool>   A   B }	
Query Syntax	:CURRent:RECall?	
Parameter	A, 0	A Value
	B, 1	B Value
Return parameter	A	A Value
	B	B Value
Example	:CURRent:RECall 0 Sets the current setting to A Value.	

Set →

→ Query

**:CURRent[:VA]**

**Description** Sets or queries the CC mode “A Value” (static mode) current. This command is applicable to static modes.

Note: A different current value can be set for each current range (High/Low).

Note: The [:VA] node can only be omitted when in static mode.

**Syntax** :CURRent[:VA] {<NRf>[ A ] | MINimum | MAXimum }

**Query Syntax** :CURRent[:VA]?

<b>Parameter</b>	<NRf>[A] MINIMUM or MIN MAXIMUM or MAX	“A Value” current value Minimum current level Maximum current level
------------------	--	---

<b>Return parameter</b>	<NR2>	Returns the “A Value” current value.
-------------------------	-------	--------------------------------------

**Example** :CURRent:VA MIN  
Sets the current value to the minimum.

**Query example** :CURRent:VA?  
>1.0A  
Returns the “A Value” current setting.

Set →

→ Query

**:CURRent:VB**

**Description** Sets or queries the CC mode “B Value” (static mode) current. This command is applicable to static modes.

Note: A different current value can be set for each current range (High/Low).

**Syntax** :CURRent:VB {<NRf>[ A ] | MINimum | MAXimum }

**Query Syntax** :CURRent:VB?

<b>Parameter</b>	<NRf>[A] MINIMUM or MIN MAXIMUM or MAX	“B Value” current value Minimum current level Maximum current level
------------------	--	---

Return parameter	<NR2>	Returns the “B Value” current value.
------------------	-------	--------------------------------------

Example	:CURRent:VB MIN Sets the current value to the minimum.
---------	---

Query example	:CURRent:VB? >1.0A Returns the “B Value” current setting.
---------------	---

Set →

← Query

**:CURRent:SRATe**

Description	Sets or queries the current slew rate for CC static mode.
-------------	---

Syntax	:CURRent:SRATe {<NRf>   MINimum   MAXimum }
--------	---

Query Syntax	:CURRent:SRATe?
--------------	-----------------

Parameter	<NRf> MINIMUM or MIN MAXIMUM or MAX	Sets the slew rate in mA/us Set to the highest slew rate Set to the lowest slew rate
-----------	---	--

Return parameter	<NR2>	Returns the slew rate in mA/us.
------------------	-------	---------------------------------

Example	:CURRent:SRATe MIN Sets the slew rate to the minimum.
---------	--

Query example	:CURRent:SRATe? >10 Returns the slew rate as 10mA/us.
---------------	---

Set →

← Query

**:CURRent:L1**

Description	Sets or queries the CC mode “Level 1” current. This command is only applicable to dynamic modes.  Note: A different current value can be set for each range (High/Low).
-------------	---

Syntax	:CURRent:L1 {<NRf>[ A ]   MINimum   MAXimum }
--------	---



Query Syntax	:CURRent:L1?	
Parameter	<NRf>[A] MINIMUM or MIN MAXIMUM or MAX	“Level1” current value Minimum current level Maximum current level
Return parameter	<NR2>	Returns the “Level1” current value.
Example	:CURRent:L1 MIN Sets the current value to the minimum.	
Query example	:CURRent:L1? >1.000A Returns the “Level1” current setting.	

**:CURRent:L2**

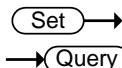

Description	Sets or queries the CC mode “Level2” current. This command is only applicable to dynamic modes. Note: A different current value can be set for each range (High/Low).	
Syntax	:CURRent:L2 {<NRf>[ A ]   MINimum   MAXimum }	
Query Syntax	:CURRent:L2?	
Parameter	<NRf>[A] MINIMUM or MIN MAXIMUM or MAX	“Level2” current value Minimum current level Maximum current level
Return parameter	<NR2>	Returns the “Level2” current value.
Example	:CURRent:L2 MIN Sets the current value to the minimum.	
Query example	:CURRent:L2? >1.000A Returns the “Level2” current setting.	

Set →

→ Query

**:CURRent:SET**

**Description** Sets or queries the CC dynamic mode “Set” value when the dynamic units are set to Percent.

This command is only applicable in dynamic mode.

**Syntax** :CURRent:SET{<NRf>[ A ] | MINimum | MAXimum }

**Query Syntax** :CURRent:SET?

**Related Commands** :CURRent:LEVel

<b>Parameter</b>	<NRf>[A] MINIMUM or MIN MAXIMUM or MAX	“Set” current value Minimum current level Maximum current level
------------------	--	---

<b>Return parameter</b>	<NR2>	Returns the “Set” current value.
-------------------------	-------	----------------------------------

**Example** :CURRent:SET MIN  
Sets the current value to the minimum.

**Query example** :CURRent:SET?  
>1.000A  
Returns the “Set” current setting.

Set →

→ Query

**:CURRent:LEVel**

**Description** Sets or queries the CC mode % level (percentage of the Set current value) when the dynamic mode units are set to Percent.

**Syntax** :CURRent:LEVel {<NRf>| MINimum | MAXimum }

**Query Syntax** :CURRent:LEVel?

**Related Commands** :CURRent:SET

<b>Parameter</b>	<NRf> MINIMUM or MIN MAXIMUM or MAX	“% level” current value Minimum % current level Maximum % current level
------------------	---	---

Return parameter	<NR2>	Returns the “% level” current value.
------------------	-------	--------------------------------------

Example	:CURRent:LEVel MIN Sets the % level current value to the minimum.
---------	--

Query example	:CURRent:LEVel? >50.00 Returns the “% Level” as 50 percent.
---------------	---

:CURRent:RISE 

Description	Sets the rising current slew rate for CC dynamic mode.
-------------	--

Syntax	:CURRent:RISE {<NRf>   MINimum   MAXimum }
--------	--

Query Syntax	:CURRent:RISE?
--------------	----------------

Related Commands	:CURRent:FALL
------------------	---------------

Parameter	<NRf> MINIMUM or MIN MAXIMUM or MAX	Rising current slew rate Minimum slew rate Maximum slew rate
-----------	---	--

Return parameter	<NR2>	Returns the rising current slew rate in mA/us.
------------------	-------	--

Example	:CURRent:RISE MIN Sets the rising slew rate to the minimum.
---------	--

Query example	:CURRent:RISE? >2500 Returns the rising slew rate as 2500mA/us.
---------------	---

:CURRent:FALL 

Description	Sets the falling current slew rate for CC dynamic mode.
-------------	---

Syntax	:CURRent:FALL {<NRf>   MINimum   MAXimum }
--------	--

Query Syntax	:CURRent:FALL?
--------------	----------------

Related Commands :CURRent:FALL

Parameter	<NRf> MINIMUM or MIN MAXIMUM or MAX	Falling current slew rate Minimum slew rate Maximum slew rate
Return parameter	<NR2>	Returns the falling current slew rate in mA/us.

Example :CURRent:FALL MIN  
Sets the falling slew rate to the minimum.

Query example :CURRent:FALL?  
>2500  
Returns the falling slew rate as 5000mA/us.

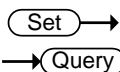

**:CURRent:T1**

Description Sets the T1 timer settings for the CC dynamic mode.

Syntax :CURRent:T1 {<NRf>[s] | MINimum | MAXimum}

Query Syntax :CURRent:T1?

Related Commands :CURRent:T2

Parameter	<NRf>[s] MINIMUM or MIN MAXIMUM or MAX	T1 timer setting in seconds Minimum time Maximum time
Return parameter	<NR2>	Returns the T1 timer time in seconds.

Example :CURRent:T1 0.200  
Sets the T1 timer time to 200ms.

Query example :CURRent:T1?  
>0.200000  
Returns the T1 timer time as 200ms.

**:CURRent:T2** 



Description	Sets the T2 timer settings for the CC dynamic mode.	
Syntax	:CURRent:T2 {<NRf>[s]   MINimum   MAXimum}	
Query Syntax	:CURRent:T2?	
Related Commands	:CURRent:T1	
Parameter	<NRf>[s] MINIMUM or MIN MAXIMUM or MAX	T2 timer setting in seconds Minimum time Maximum time
Return parameter	<NR2>	Returns the T2 timer time in seconds.
Example	:CURRent:T2 0.200 Sets the T2 timer time to 200ms.	
Query example	:CURRent:T2? >0.200000 Returns the T2 timer time as 200ms.	

**:CURRent:FREQuency** 



Description	Sets the CC dynamic mode switching frequency. This command along with the “:CURRent:DUTY” command is used when the dynamic time setting is set to “Freq./Duty”.  This command is only applicable for dynamic mode.	
Syntax	:CURRent:FREQuency {<NRf>   MINimum   MAXimum}	
Query Syntax	:CURRent:FREQuency?	
Related Commands	:CURRent:DUTY	

Parameter	<NRf> MINIMUM or MIN MAXIMUM or MAX	Sets the switching frequency in hertz. Minimum frequency Maximum frequency
Return parameter	<NR2>	Returns the frequency in hertz

Example :CURRent:FREQuency 10000  
Sets frequency to 10kHz.

Query example :CURRent:FREQuency?  
>10000.0  
Returns the switching frequency (10kHz).

Set →

→ Query

**:CURRent:DUTY**

Description Sets the positive duty cycle for the CC dynamic mode switching frequency. This command along with the “:CURRent:FREQuency” command is used when the dynamic time setting is set to “Freq./Duty”.  
  
This command is only applicable for dynamic mode.

Syntax :CURRent:DUTY {<NRf> | MINimum | MAXimum}

Query Syntax :CURRent:DUTY?

Related Commands :CURRent:FREQuency

Parameter	<NRf> MINIMUM or MIN MAXIMUM or MAX	Sets the duty as a percentage. Minimum duty Maximum duty
Return parameter	<NR2>	Returns the duty as a percentage

Example :CURRent:DUTY 50  
Sets the duty to 50%.

Query example :CURRent:DUTY?  
>50.0  
Returns the duty (50%).

Set →

→ Query

**:CURRent:CV:RESPonse**

Description Sets or returns the +CV response speed for CC Mode. Slow is the default response speed.

Syntax :CURRent:CV:RESPonse { FAST | SLOW }

Query Syntax :CURRent:CV:RESPonse?

Parameter	FAST	Fast response
	SLOW	Slow response

Return parameter	<ASCII string>	Returns +CV response speed as a string.
------------------	----------------	---

Example :CURRent:CV:RESPonse FAST  
Sets the response to fast.

Query example :CURRent:CV:RESPonse?  
> FAST  
The +CV response is FAST.

## Resistance Subsystem Commands

:RESistance:RECall.....	78
:CONDuctanceRECall.....	79
:CONDuctance[:VA].....	79
:CONDuctance:VB.....	80
:RESistance[:VA].....	81
:RESistance:VB.....	81
:RESistance:SRATe.....	82
:CONDuctance:L1.....	83
:CONDuctance:L2.....	84
:CONDuctance:SET.....	84
:RESistance:L1.....	85
:RESistance:L2.....	86
:RESistance:SET.....	87
:RESistance:LEVel.....	87
:RESistance:RISE.....	88
:RESistance:FALL.....	89
:RESistance:T1.....	89
:RESistance:T2.....	90
:RESistance:FREQuency.....	91
:RESistance:DUTY.....	91
:RESistance:CV:RESPonse.....	92

### :RESistance:RECall

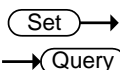

Description	Sets or queries whether A Value or B Value is the currently active value in CC static mode.	
Note	This command is only applicable when the CR unit is set to ohms.	
Syntax	:RESistance:RECall {<bool>   A   B }	
Query Syntax	:RESistance:RECall?	
Parameter	A, 0	A Value
	B, 1	B Value
Return parameter	A	A Value
	B	B Value



Example :RESistance:RECall 0  
Sets the resistance setting to A Value.

:CONDuctanceRECall  

Description Sets or queries whether A Value or B Value is the currently active value in CC static mode when the units are set to Siemens.

Note This command is only applicable when the CR unit is set to Siemens.

Syntax :CONDuctance:RECall {<bool> | A | B }

Query Syntax :CONDuctance:RECall?

Parameter	A, 0	A Value
	B, 1	B Value

Return parameter	A	A Value
	B	B Value

Example :CONDuctance:RECall 0  
Sets the conductance setting to A Value.

:CONDuctance[:VA]  

Description Sets or queries the CR mode “A Value” conductance. This command is only applicable to static mode.  
Note: A different value can be set for each current range (High/Low).  
Note: The optional command node [:VA] can only be omitted when in static mode.

Note This command is only applicable when the CR unit is set to Siemens.

Syntax :CONDuctance[:VA] {<NRf>[mS] | MINimum | MAXimum }

Query Syntax :CONDuctance[:VA]?

Parameter	<NRf>[ mS ] MINIMUM or MIN MAXIMUM or MAX	“A Value” conductance value (Unit: millisiemens) Minimum conductance level Maximum conductance level
Return parameter	<NR2>	Returns the “A Value” conductance value

Example :CONDuctance:VA MIN  
Sets the conductance value to the minimum.

Query example :CONDuctance:VA?  
> 60000  
Returns the “A Value” conductance setting(mS).

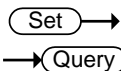

**:CONDuctance:VB**

Description Sets or queries the CR mode “B Value” conductance. This command is applicable to static mode only.  
Note: A different value can be set for each current range (High/Low).

Note This command is only applicable when the CR unit is set to Siemens.

Syntax :CONDuctance:VB {<NRf>[mS] | MINimum | MAXimum }

Query Syntax :CONDuctance:VB?

Parameter	<NRf>[mS] MINIMUM or MIN MAXIMUM or MAX	“B Value” conductance value Minimum conductance level Maximum conductance level
-----------	---	---

Return parameter <NR2>  
Returns the “B Value” conductance value

Example :CONDuctance:VB MIN  
Sets the conductance value to the minimum.

Query example :CONDuctance:VB?  
> 60000  
Returns the “B Value” conductance setting(mS).

Set →

**:RESistance[:VA]**

→ Query

Description Sets or queries the CR mode “A Value” resistance. This command is only applicable to static mode.  
Note: A different value can be set for each current range (High/Low).

Note: The optional command node [:VA] can only be omitted when in static mode.

Note This command is only applicable when the CR unit is set to ohms.

Syntax :RESistance[:VA] {<NRF>[OHM] | MINimum | MAXimum }

Query Syntax :RESistance[:VA]?

Parameter	<NRF>[OHM] MINIMUM or MIN MAXIMUM or MAX	“A Value” resistance value Minimum resistance level Maximum resistance level
-----------	--	--

Return parameter	<NR2>	Returns the “A Value” resistance value
------------------	-------	--

Example :RESistance:VA 500  
Sets the resistance value to the minimum.

Query example :RESistance:VA?  
> 500.00  
Returns the “A Value” resistance setting(OHM).

Set →

**:RESistance:VB**

→ Query

Description Sets or queries the CR mode “B Value” resistance. This command is applicable to static mode only.  
Note: A different value can be set for each current range (High/Low).

Note	This command is only applicable when the CR unit is set to ohms.	
Syntax	:RESistance:VB {<NRf>[OHM]   MINimum   MAXimum }	
Query Syntax	:RESistance:VB?	
Parameter	<NRf>[OHM] MINIMUM or MIN MAXIMUM or MAX	“B Value” resistance value Minimum resistance level Maximum resistance level
Return parameter	<NR2>	Returns the “B Value” resistance value
Example	:RESistance:VB 500 Sets the resistance value to the minimum.	
Query example	:RESistance:VB? > 500.00 Returns the “B Value” resistance setting(OHM).	

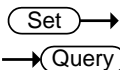

**:RESistance:SRATe**

Description	Sets or queries the current slew rate for CR static mode.	
Note	This command is only applicable when the CR unit is set to ohms.	
Syntax	:RESistance:SRATe {<NRf>   MINimum   MAXimum}	
Query Syntax	:RESistance:SRATe?	
Parameter	<NRf> MINIMUM or MIN MAXIMUM or MAX	Sets the slew rate in mA/us Set to the lowest slew rate Set to the highest slew rate
Return parameter	<NR2>	Returns the slew rate in mA/us
Example	:RESistance:SRATe MIN Sets the slew rate to the minimum.	

Query example :RESistance:SRATe?  
>10  
Returns the slew rate as 10mA/us.

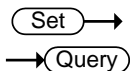

**:CONDuctance:L1**

Description Sets or queries the CR mode “Level1” conductance. This command is only applicable to dynamic mode.  
Note: A different value can be set for each current range (High/Low).

Note This command is only applicable when the CR unit is set to Siemens.

Syntax :CONDuctance:L1 {<NRf>[mS] | MINimum | MAXimum }

Query Syntax :CONDuctance:L1?

Parameter	<NRf>[mS]	“level1” conductance value (Unit: millisiemens)
	MINIMUM or MIN	Minimum conductance level
	MAXIMUM or MAX	Maximum conductance level

Return parameter <NR2> Returns the “level1” conductance value

Example :CONDuctance:L1 MIN  
Sets the conductance value to the minimum.

Query example :CONDuctance:L1?  
> 2  
Returns the “level1” conductance setting(2mS).

**:CONDuctance:L2**

Set →

→ Query

Description	Sets or queries the CR mode “level2” conductance. This command is applicable to dynamic mode only.  Note: A different value can be set for each current range (High/Low).	
Note	This command is only applicable when the CR unit is set to Siemens.	
Syntax	:CONDuctance:L2 {<NRf>[mS]   MINimum   MAXimum }	
Query Syntax	:CONDuctance:L2?	
Parameter	<NRf>  MINIMUM or MIN  MAXIMUM or MAX	“level2” conductance value (Unit: millisiemens) Minimum conductance level Maximum conductance level
Return parameter	<NR2>	Returns the “Level2” conductance value
Example	:CONDuctance:L2 MIN  Sets the conductance value to the minimum.	
Query example	:CONDuctance:L2? > 2  Returns the “Level2” conductance setting (mS).	

Set →

→ Query

**:CONDuctance:SET**

Description	Sets or queries the CR dynamic mode Set value when the dynamic units are set to Percent.  This command is only applicable in dynamic mode.	
Note	This command is only applicable when the CR unit is set to Siemens.	

Syntax	:CONDuctance:SET {<NRf>[mS]   MINimum   MAXimum }	
Query Syntax	:CONDuctance:SET?	
Related Commands	:CONDuctance:LEVel	
Parameter	<NRf>  MINIMUM or MIN  MAXIMUM or MAX	“Set” conductance value (Unit: mS) Minimum conductance level Maximum conductance level
Return parameter	<NR2>	Returns the “Set” conductance value (Unit: mS)

**Example** :CONDuctance:SET MIN  
Sets the conductance to the minimum.

**Query example** :CONDuctance:SET?  
> 0  
Returns the “Set” conductance setting in mS.

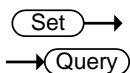

**:RESistance:L1**

**Description** Sets or queries the CR mode “Level1” resistance. This command is only applicable to dynamic mode.  
  
Note: A different value can be set for each current range (High/Low).

**Note** This command is only applicable when the CR unit is set to ohms.

**Syntax** :RESistance:L1 {<NRf>[OHM] | MINimum | MAXimum }

**Query Syntax** :RESistance:L1?

**Parameter** <NRf>[OHM] “level1” resistance value (Unit: OHM)

	MINIMUM or MIN	Minimum resistance level
	MAXIMUM or MAX	Maximum resistance level
Return parameter	<NR2>	Returns the “level1” resistance value

Example :RESistance:L1 MIN  
Sets the resistance value to the minimum.

Query example :RESistance:L1?  
> 0  
Returns the “level1” resistance setting(OHM).

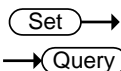

**:RESistance:L2**

Description Sets or queries the CR mode “level2” resistance. This command is applicable to dynamic mode only.  
Note: A different value can be set for each current range (High/Low).

Note This command is only applicable when the CR unit is set to ohms.

Syntax :RESistance:L2 {<NRf>[OHM] | MINimum | MAXimum }

Query Syntax :RESistance:L2?

Parameter	<NRf>	“level2” resistance value
	MINIMUM or MIN	Minimum resistance level
	MAXIMUM or MAX	Maximum resistance level

Return parameter <NR2>  
Returns the “level2” resistance value

Example :RESistance:L2 MIN  
Sets the resistance value to the minimum.

Query example :RESistance:L2?  
> 0  
Returns the “level2” resistance setting.(OHM)



Set →

→ Query

**:RESistance:SET**

Description	Sets or queries the CR dynamic mode Set value when the dynamic units are set to Percent.  This command is only applicable in dynamic mode.	
Note	This command is only applicable when the CR unit is set to ohms.	
Syntax	:RESistance:SET {<NRF>[OHM]   MINimum   MAXimum }	
Query Syntax	:RESistance:SET?	
Related Commands	:RESistance:LEVel	
Parameter	<NRF>  MINIMUM or MIN MAXIMUM or MAX	“Set” resistance value (Unit: OHM) Minimum resistance level Maximum resistance level
Return parameter	<NR2>	Returns the “Set” resistance value.

**Example** :RESistance:SET MIN  
Sets the resistance to the minimum.

**Query example** :RESistance:SET?  
> 0  
Returns the “Set” resistance setting in OHM.

Set →

→ Query

**:RESistance:LEVel**

Description	Sets or queries the CR mode % level (percentage of the Set conductance value) when the dynamic mode units are set to Percent.	
Syntax	:RESistance:LEVel {<NRF>   MINimum   MAXimum }	
Query Syntax	:RESistance:LEVel?	

Related Commands	:RESistance:SET	
Parameter	<NRf> MINIMUM or MIN MAXIMUM or MAX	“% level” conductance value Minimum % conductance level Maximum % conductance level
Return parameter	<NR2>	Returns the “% level” conductance value.
Example	:RESistance:LEVel MIN Sets the % level conductance value to the minimum.	
Query example	:RESistance:LEVel? >50.00 Returns the “% Level” as 50 percent.	

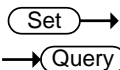

**:RESistance:RISE**

Description	Sets the rising current slew rate for CR dynamic mode.	
Syntax	:RESistance:RISE {<NRf>   MINimum   MAXimum }	
Query Syntax	:RESistance:RISE?	
Related Commands	:RESistance:FALL	
Parameter	<NRf> MINIMUM or MIN MAXIMUM or MAX	Rising current slew rate [mA/us] Minimum slew rate Maximum slew rate
Return parameter	<NR2>	Returns the rising current slew rate in mA/us.
Example	:RESistance:RISE MIN Sets the rising slew rate to the minimum.	
Query example	:RESistance:RISE? >2500 Returns the rising slew rate as 50mA/us.	

**:RESistance:FALL** 



Description	Sets the falling current slew rate for CR dynamic mode.	
Syntax	:RESistance:FALL {<NRf>   MINimum   MAXimum }	
Query Syntax	:RESistance:FALL?	
Related Commands	:RESistance:RISE	
Parameter	<NRf> MINIMUM or MIN MAXIMUM or MAX	Falling current slew rate [ mA/us] Minimum slew rate Maximum slew rate
Return parameter	<NR2>	Returns the falling current slew rate in mA/us.
Example	:RESistance:FALL MIN Sets the falling slew rate to the minimum.	
Query example	:RESistance:FALL? >2500 Returns the falling slew rate as 50mA/us.	

**:RESistance:T1** 



Description	Sets the T1 timer settings for the CR dynamic mode.	
Syntax	:RESistance:T1 {<NRf>[s]   MINimum   MAXimum}	
Query Syntax	:RESistance:T1?	
Related Commands	:RESistance:T2	
Parameter	<NRf>[s] MINIMUM or MIN MAXIMUM or MAX	T1 timer setting in seconds Minimum time Maximum time
Return parameter	<NR2>	Returns the T1 timer time in seconds.

Example :CURRent:T1 0.200  
 :CURRent:T1 0.200s  
 :CURRent:T1 200 ms  
 Sets the T1 timer time to 200ms.

Query example :CURRent:T1?  
 >0.200000  
 Returns the T1 timer time as 200ms.

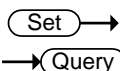

**:RESistance:T2**

Description Sets the T2 timer settings for the CR dynamic mode.

Syntax :RESistance:T2 {<NRf>[s] | MINimum | MAXimum}

Query Syntax :RESistance:T2?

Related Commands :RESistance:T1

Parameter	<NRf>[s] MINIMUM or MIN MAXIMUM or MAX	T2 timer setting in seconds Minimum time Maximum time
Return parameter	<NR2>	Returns the T2 timer time in seconds.

Example :RESistance:T2 0.200  
 Sets the T2 timer time to 200ms.

Query example :RESistance:T2?  
 >0.200000  
 Returns the T2 timer time as 200ms.

**:RESistance:FREQuency** 



Description	Sets the CR dynamic mode switching frequency. This command along with the “:RESistance:DUTY” command is used when the dynamic time setting is set to “Freq./Duty”. This command is only applicable for dynamic mode.	
Syntax	:RESistance:FREQuency {<NRF>   MINimum   MAXimum}	
Query Syntax	:RESistance:FREQuency?	
Related Commands	:RESistance:DUTY	
Parameter	<NRF> MINIMUM or MIN MAXIMUM or MAX	Sets the switching frequency in hertz. Minimum frequency Maximum frequency
Return parameter	<NR2>	Returns the frequency in hertz.
Example	:RESistance:FREQuency 10000 Sets frequency to 10kHz.	
Query example	:RESistance:FREQuency? >10000.0 Returns the switching frequency (10kHz).	

**:RESistance:DUTY** 



Description	Sets the positive duty cycle for the CR dynamic mode switching frequency. This command along with the “:RESistance:FREQuency” command is used when the dynamic time setting is set to “Freq./Duty”. This command is only applicable for dynamic mode.	
-------------	---	--

Syntax	:RESistance:DUTY {<NRf>   MINimum   MAXimum}	
Query Syntax	:RESistance:DUTY?	
Related Commands	:RESistance:FREQuency	
Parameter	<NRf> MINIMUM or MIN MAXIMUM or MAX	Sets the duty as a percentage. Minimum duty Maximum duty
Return parameter	<NR2>	Returns the duty as a percentage.
Example	:RESistance:DUTY 50 Sets the duty to 50%.	
Query example	:RESistance:DUTY? >50.0 Returns the duty (50%).	

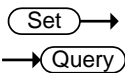
**:RESistance:CV:RESPonse**



Description	Sets or returns the +CV response speed for CR Mode. Slow is the default response speed.	
Syntax	:RESistance:CV:RESPonse { FAST   SLOW }	
Query Syntax	:RESistance:CV:RESPonse?	
Parameter	FAST SLOW	Fast response Slow response
Return parameter	<ASCII string>	Returns +CV response speed as a string.
Example	:RESistance:CV:RESPonse FAST Sets the response to fast.	
Query example	:RESistance:CV:RESPonse? > FAST The +CV response is FAST.	

## Voltage Subsystem Commands

:VOLTage:RECall.....	93
:VOLTage[:VA].....	93
:VOLTage:VB.....	94
:VOLTage:RESPOse.....	94

### :VOLTage:RECall

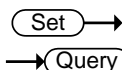

Description	Sets or queries whether A Value or B Value is the currently active value in CV mode.	
Syntax	:VOLTage:RECall {<bool>   A   B }	
Query Syntax	:VOLTage:RECall?	
Parameter	A, 0 B, 1	A Value B Value
Return parameter	A B	A Value B Value
Example	:VOLTage:RECall 0 Sets the voltage setting to A Value.	

### :VOLTage[:VA]

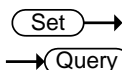

Description	Sets or queries the CV mode “A Value” voltage . Note: The same value applies for each current range (High/Low).  Note: The optional command node [:VA] can only be omitted when in static mode.	
Syntax	:VOLTage[:VA] {<NRf>[ V ]   MINimum   MAXimum }	
Query Syntax	:VOLTage[:VA]?	
Parameter	<NRf>[ V ] MINIMUM or MIN MAXIMUM or MAX	“A Value” voltage value Minimum voltage level Maximum voltage level
Return parameter	<NR2>	Returns the “A Value” voltage value.

Example :VOLTage:VA MIN  
Sets the voltage value to the minimum.

Query example :VOLTage:VA?  
>15.0000  
Returns the “A Value” voltage setting (15).

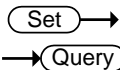

**:VOLTage:VB**

Description Sets or queries the CV mode “B Value”. Note: The same value applies for each current range (High/Low).

Syntax :VOLTage:VB {<NRf>[ V ] | MINimum | MAXimum }

Query Syntax :VOLTage:VB?

Parameter	<NRf>[ V ] MINIMUM or MIN MAXIMUM or MAX	“B Value” voltage value Minimum voltage level Maximum voltage level
Return parameter	<NR2>	Returns the “B Value” voltage value.

Example :VOLTage:VB MIN  
Sets the voltage value to the minimum.

Query example :VOLTage:VB?  
>15.0000  
Returns the “B Value” voltage setting.

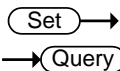

**:VOLTage:RESPonse**

Description Sets or returns the response speed for CV Mode. Slow is the default response speed.

Syntax :VOLTage:RESPonse { FAST | NORMal | SLOW }

Query Syntax :VOLTage:RESPonse?

Parameter	FAST NORMal SLOW	Fast response Normal response Slow response
-----------	------------------------	---



---

Return parameter	<ASCII string>	Returns response speed as a string.
Example	:VOLTage:RESPonse FAST Sets the response to fast.	
Query example	:VOLTage:RESPonse? > FAST The response is FAST.	

---

## Power Subsystem Commands

:POWer:RECall .....	96
:POWer[:VA] .....	96
:POWer:VB .....	97
:POWer:RESPOuse .....	97
:POWer:CV:RESPOuse .....	98

### :POWer:RECall

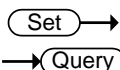

Description	Sets or queries which power level is active (CP A Value or CP B Value).	
Syntax	:POWer:RECall {<bool>   A   B }	
Query Syntax	:POWer:RECall?	
Parameter	A, 0 B, 1	A Value B Value
Return parameter	A B	A Value B Value
Example	:POWer:RECall 0 Sets the power setting to A Value.	

### :POWer[:VA]

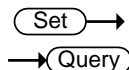

Description	Sets or queries the CP mode “A Value” power. Note: A different “A Value” can be set for different current ranges.	
Syntax	:POWer[:VA] {<NRf>[ W ]   MINimum   MAXimum }	
Query Syntax	:POWer[:VA]?	
Parameter	<NRf>[ W ] MINIMUM or MIN MAXIMUM or MAX	“A Value” power value Minimum power level Maximum power level
Return parameter	<NR2>	Returns the “A Value” power value.

Example :POWer:VA MAX  
Sets the power value to the minimum.

Query example :POWer:VA?  
>306.00  
Returns the “A Value” power setting (306W).

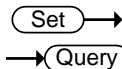

**:POWer:VB**

Description Sets or queries the CP mode “B Value” power. This command is only applicable to static mode.  
Note: A different “B Value” can be set to different current ranges.

Syntax :POWer:VB {<NRf>[ W ] | MINimum | MAXimum }

Query Syntax :POWer:VB?

Parameter	<NRf>[W] MINIMUM or MIN MAXIMUM or MAX	“B Value” power value Minimum power level Maximum power level
-----------	--	---

Return parameter	<NR2>	Returns the “B Value” power value.
------------------	-------	------------------------------------

Example :POWer:VB 10  
Sets the power value to 10W.

Query example :POWer:VB?  
>10.00  
Returns the “B Value” power setting.

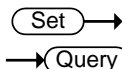

**:POWer:RESPonse**

Description Sets or returns the response speed for CP Mode. Slow is the default response speed.

Syntax :POWer:RESPonse { FAST | NORMAl | SLOW }

Query Syntax :POWer:RESPonse?

Parameter	FAST NORMAl SLOW	Fast response Normal response Slow response
-----------	------------------------	---

Return parameter	<code>&lt;ASCII string&gt;</code>	Returns response speed as a string.
------------------	-----------------------------------	-------------------------------------

Example :POWer:RESPonse FAST  
Sets the response to fast.

Query example :POWer:RESPonse?  
> FAST  
The response is FAST.

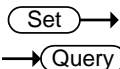

**:POWer:CV:RESPonse**

Description	Sets or returns the +CV response speed for CP Mode. Slow is the default response speed.	
-------------	---	--

Syntax	:POWer:CV:RESPonse { FAST   SLOW }	
--------	------------------------------------	--

Query Syntax	:POWer:CV:RESPonse?	
--------------	---------------------	--

Parameter	FAST	Fast response
	SLOW	Slow response

Return parameter	<code>&lt;ASCII string&gt;</code>	Returns +CV response speed as a string.
------------------	-----------------------------------	---

Example :POWer:CV:RESPonse FAST  
Sets the response to fast.

Query example :POWer:CV:RESPonse?  
> FAST  
The +CV response is FAST.

## Function Commands

---

:PROGram:STATe .....	100
:PROGram .....	101
:PROGram[:RECall]:DEFault .....	102
:PROGram:START .....	102
:PROGram:STEP .....	103
:PROGram:MEMory .....	103
:PROGram:RUN .....	103
:PROGram:ONTime .....	104
:PROGram:OFFTime .....	104
:PROGram:PFTime .....	105
:PROGram:STIME .....	105
[:PROGram]:CHAIin:START .....	106
[:PROGram]:CHAIin .....	106
[:PROGram]:CHAIin:P2P .....	108
[:PROGram]:CHAIin[:RECall]:DEFault .....	108
:PROGram:SAVE .....	109
:NSEquence:STATe .....	109
:NSEquence .....	110
:NSEquence:START .....	111
:NSEquence:NUMBer .....	112
:NSEquence:MEMO .....	112
:NSEquence:MODE .....	113
:NSEquence:RANGe .....	113
:NSEquence:LOOP .....	114
:NSEquence:LLOad .....	114
:NSEquence:LAST .....	115
:NSEquence:CHAIin .....	115
:NSEquence:EDIT .....	116
:NSEquence:EDIT:POINt .....	117
:NSEquence:EDIT:END? .....	118
:NSEquence[:DELet]:ALL .....	118
:NSEquence:SAVE .....	118
:FSEquence:STATe .....	118
:FSEquence .....	119
:FSEquence:MEMO .....	120
:FSEquence:MODE .....	121
:FSEquence:RANGe .....	121
:FSEquence:LOOP .....	122
:FSEquence:TBASE .....	122
:FSEquence:LLOad .....	123

:FSEquence:LAST ..... 123  
 :FSEquence:RPTStep ..... 124  
 :FSEquence:EDIT ..... 124  
 :FSEquence:EDIT:POINT ..... 125  
 :FSEquence:EDIT:END? ..... 126  
 :FSEquence[:DELet]:ALL ..... 126  
 :FSEquence[:EDIT]:FILL ..... 126  
 :FSEquence:SAVE ..... 127

**:PROGram:STATe** 
  

Description	Sets or queries the state of the program function.	
Syntax	:PROGram:STATe {ON OFF PAUSe CONTInue NEXT}	
Query Syntax	:PROGram:STATe? [{ON,STOP RUN PAUSe}] OFF}	
Parameter	ON OFF PAUSe RUN NEXT CONTInue	Turn program on Program off Program pause Program running Next step in the program Program continue
Return Parameter	ON,STOP ON,PAUSE ON,RUN OFF	Program is on, stopped Program is paused Program is running Program is off
Example	:PROGram:STATe ON  Turns “Program” on.	
Query example	:PROGram:STATe? >OFF  “Program” is off.	

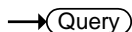
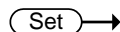

**:PROGram**

Description	Configures the parameters for the Program sequence. This remote command is equivalent to all the settings in the “Timing Edit for Program” menu when entering the FUNC>PROGRAM menu.	
Syntax	:PROGram {<NR1>,<NR1>,<NR1>,SKIP AUTO MANual,<NR2>,<NR2> OFF,<NR2> OFF,<NR2> OFF}	
Query Syntax	:PROGram?	
Related Commands	:PROGram:STATe	
Parameter	Parameters (In order) <NR1> <NR1> <NR1> SKIP AUTO MANual <NR2> <NR2> OFF <NR2> OFF <NR2> OFF	Description Program number (1~16) Step number (1~16) Memory number (1~256) Run parameter: On-Time (0.1~60)s Off-Time (0.1~60)s P/F Time (0.0~119.9)s Short-Time (0.1 ~ On-Time)s
Return parameter	<string>	Returns the program settings in the following order: Program: <NR1>; Start: <NR1>, Step:XX, Memory: <NR1>, Run: Skip Automatic Manual, On-Time:<NR2>, Off-Time: <NR2> OFF, P/F-Time: <NR2> OFF, Short-Time: <NR2> OFF

**Example** :PROGAm: 1,1,1,AUTO,2.0,OFF,1.0,OFF  
 Sets the program settings as follows: Program no. = 1, Step no. = 1, memory number = M001, Run = AUTO, On-Time = 2.0 secs, Off-Time = OFF, P/F Time = 1.0 secs, Short-Time = OFF.

**Query example** :PROGAm?  
 >Start:1, Step:1, Memory:1, Run:Manual, On-Time:2.0, Off-Time:0.0, P/F-Time:0.0, Short-Time:0.0  
 Returns the program settings for program number 1, at step 1.

**:PROGAm[:RECall]:DEFault** (Set) →

**Description** The default settings for the program sequence function.

**Syntax** :PROGAm[:RECall]:DEFault

**Example** :PROGAm:DEFault

**:PROGAm:STARt** (Set) →  
→ (Query)

**Description** Sets or queries the program number for the program sequence.

**Syntax** :PROGAm:STARt {<NR1>}

**Query Syntax** :PROGAm:STARt?

**Parameter** <NR1> (1~16) program number

**Return Parameter** <string> Start:<NR1>

**Example** :PROGAm:STARt 1  
 Sets the program number to 1.

**Query example** :PROGAm:STARt?  
 >Start:1  
 Returns the program number (1).



		Set →
		→ Query
<b>:PROGram:STEP</b>		
Description	Sets or queries the step number for the program sequence.	
Syntax	:PROGram:STEP {<NR1>}	
Query Syntax	:PROGram:STEP?	
Parameter	<NR1>	(1~16) step number
Return Parameter	<string>	Step:<NR1>
Example	:PROGram:STEP 1 Sets the step number to 1.	
Query example	:PROGram:STEP? >Step:1 Returns the step number (1).	

		Set →
		→ Query
<b>:PROGram:MEMory</b>		
Description	Sets or queries the memory number for the program sequence.	
Syntax	:PROGram:MEMory{<NR1>}	
Query Syntax	:PROGram:MEMory?	
Parameter	<NR1>	(1~256) memory number
Return Parameter	<string>	Memory:M <NR1>
Example	:PROGram:MEMory 1 Sets the memory number to 1.	
Query example	:PROGram:MEMory? >Memory:M 1 Returns the memory number (1).	

		Set →
		→ Query
<b>:PROGram:RUN</b>		
Description	Sets or queries the “Run” state for the selected program step in the program sequence.	

Syntax	:PROGram:RUN {SKIP AUTO MANual}	
Query Syntax	:PROGram:RUN? { Run:Skip Automatic Manual}	
Parameter	SKIP	Sets the run state to skip
	AUTO	Sets the run state to automatic
	MANual	Sets the run state to manual
Return Parameter	Run:Skip	Run state = Skip
	Run:Automatic	Run state = Automatic
	Run:Manual	Run state = Manual
Example	:PROGram:RUN SKIP Skips the selected step.	
Query example	:PROGram:RUN? >Run:Skip Returns the "Run" state (skip).	

**:PROGram:ONTime**

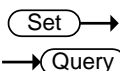

Description	Sets or queries the On-Time for the selected step number. Resolution 0.1 seconds.	
Syntax	:PROGram:ONTime {<NR2>[s]}	
Query Syntax	:PROGram:ONTime?	
Parameter	<NR2>[s]	(0.1~60) On-Time in seconds
		Turns the On-Time off.
Return Parameter	<string>	On-Time: <NR2>
Example	:PROGram:ONTime 1 Sets the On-Time to 1 second.	
Query example	:PROGram:ONTime? >On-Time:1.0 Returns the On-Time (1 second).	

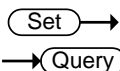

**:PROGram:OFFTime**

Description	Sets or queries the Off-Time for the selected step number.	
-------------	--	--

Syntax	:PROGram:OFFTime {<NR2>[s] OFF}	
Query Syntax	:PROGram:OFFTime?	
Parameter	<NR2>[s]	(0~60) Off-Time in seconds
	OFF	Turns the Off-Time off.
Return Parameter	<string>	Off-Time:<NR2> (a time of 0.0 is equivalent to "OFF")
Example	:PROGram:OFFTime 1 Sets the Off-Time to 1 second.	
Query example	:PROGram:OFFTime? >Off-Time:1.0 Returns the Off-Time (1 second).	

**:PROGram:PFTime**

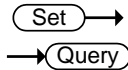

Description	Sets or queries the Pass/Fail-Time for the selected step number.	
Syntax	:PROGram:PFTime {<NR2>[s] OFF}	
Query Syntax	:PROGram:PFTime?	
Parameter	<NR2>[s]	(0 ~ (On-time + Off time - 0.1)) (in seconds)
	OFF	Turns the P/F-Time off.
Return Parameter	<string>	P/F-Time:<NR2>
Example	:PROGram:PFTime 1 Sets the P/F-Time to 1 second.	
Query example	:PROGram:PFTime? > P/F-Time:0.0 Returns the P/F-Time (1 second).	

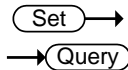

**:PROGram:STIME**

Description	Sets or queries the Short-Time for the selected step number.	
-------------	--	--

Syntax	:PROGram:STIME {<NR2>[s] OFF}	
Query Syntax	:PROGram:STIME?	
Parameter	<NR2>[s] OFF	(0~On-Time) (in seconds) Turns the Short-Time off.
Return Parameter	<string>	Short-Time:<NR2>
Example	:PROGram:STIME 1 Sets the Short-Time to 1 second.	
Query example	:PROGram:STIME? >Short-Time:1.0 Returns the Short-Time (1 second).	

Set →  
 ← Query

<b>[[:PROGram]:CHAIIn:START</b>		
Description	Sets or queries the first program number for the chain.	
Syntax	[:PROGram]:CHAIIn:START {<NR1>}	
Query Syntax	[:PROGram]:CHAIIn:START?	
Parameter	<NR1>	(1~16) Program number
Return Parameter	<string>	P1 ~ P16
Example	:CHAIIn:START 1 Sets program 1 as the start of the program chain.	
Query example	:CHAIIn:START? >P1 Returns the program number that starts the chain.	

Set →  
 ← Query

<b>[[:PROGram]:CHAIIn</b>		
Description	Sets or queries which programs are added to program chain and the order of those programs in the program chain.	

Syntax                   [:PROGram]:CHAIIn  
 {<NR1>|OFF, <NR1>|OFF, <NR1>|OFF, <NR1>|OFF,  
 <NR1>|OFF, <NR1>|OFF, <NR1>|OFF, <NR1>|OFF,  
 <NR1>|OFF, <NR1>|OFF, <NR1>|OFF, <NR1>|OFF,  
 <NR1>|OFF, <NR1>|OFF, <NR1>|OFF, <NR1>|OFF}

Query Syntax           [:PROGram]:CHAIIn?

Parameter	Parameters in order:	Description
	<NR1> OFF	(1~16) Program no. that follows P01.
	<NR1> OFF	(1~16) Program no. that follows P02.
	<NR1> OFF	(1~16) Program no. that follows P03.
	<NR1> OFF	(1~16) Program no. that follows P04.
	<NR1> OFF	(1~16) Program no. that follows P05.
	<NR1> OFF	(1~16) Program no. that follows P06.
	<NR1> OFF	(1~16) Program no. that follows P07.
	<NR1> OFF	(1~16) Program no. that follows P08.
	<NR1> OFF	(1~16) Program no. that follows P09.
	<NR1> OFF	(1~16) Program no. that follows P10.
	<NR1> OFF	(1~16) Program no. that follows P11.
	<NR1> OFF	(1~16) Program no. that follows P12.
	<NR1> OFF	(1~16) Program no. that follows P13.
	<NR1> OFF	(1~16) Program no. that follows P14.
	<NR1> OFF	(1~16) Program no. that follows P15.
	<NR1> OFF	(1~16) Program no. that follows P16.

Return Parameter <string>   P1->XX;P2->XX;P3->XX;P4->XX;  
 P5->XX;P6->XX;P7->XX;P8->XX;  
 P9->XX;P10->XX;P11->XX;P12->XX;  
 P13->XX;P14->XX;P15->XX;P16->XX

Where XX = P1 ~ P16 or OFF

Example                   :CHAIIn 4,OFF,OFF,5,6,OFF,OFF,OFF,OFF,OFF,OFF,  
 OFF,OFF, OFF,OFF,OFF

Configures the program chain as follows:

P01→P04→P05→P06→OFF

Query example :CHAIIn?  
 >P1->P4;P2->Off;P3->Off;P4->P5;P5->P6;P6->Off;  
 P7->Off;P8->Off;P9->Off;P10->Off;P11->Off;  
 P12->Off;P13->Off;P14->Off;P15->Off;P16->Off

Returns the program chain configuration.

[[:PROGram]:CHAIIn:P2P (Set) →  
→ (Query)

Description	Sets or queries a single link in the program chain.	
Syntax	[:PROGram]:CHAIIn:P2P {<NR1>,<NR1> OFF}	
Query Syntax	[:PROGram]:CHAIIn:P2P? {P1 P2 P3 P4 P5 P6 P7 P8 P9 P10 P11 P12 P13 P14 P15 P16}	
Parameter	Parameters in order: <NR1> <NR1> OFF	Description (1~16) Program number of single link. (1~16) Program number that follows.
Query Parameter	P1 ~ P16	The program number of the first link of the chain that you are inquiring about.
Return Parameter	PX->PX Off	Returns the program number that follows or Off.

Example :CHAIIn:P2P 4,6  
 Configures the program number 6 to follow after program number 4:  
 P04→P06

Query example :CHAIIn:P2P? P4  
 >P4->6  
 Indicates that program 6 follows from program 4 in the chain.

[[:PROGram]:CHAIIn[:RECall]:DEFault (Set) →

Description	Recalls the default settings for the program chain.
Syntax	[:PROGram]:CHAIIn[:RECall]:DEFault
Example	:CHAIIn:DEFault

**:PROGram:SAVE**

Set →

Description	Saves the program chain.
Syntax	:PROGram:SAVE
Example	:PROG:SAVE

**:NSEquence:STATe**

Set →

→ Query

Description	Sets or queries the state of the Normal Sequence function.	
Syntax	:NSEquence:STATe {OFF ON PAUSE CONTINUE NEXT}	
Query Syntax	:NSEquence:STATe? {ON,STOP RUN PAUSE} OFF	
Parameter	OFF	Normal sequence Off
	ON	Normal sequence On
	PAUSE	Pause sequence
	CONTINUE	Continue sequence
	NEXT	Go to next sequence
Return Parameter	ON,STOP	Sequence has stopped
	ON, RUN	Sequence is running
	ON, PAUSE	Sequence is paused
	OFF	Sequence is off
Example	:NSEquence:STATe ON Turns “Normal Sequence” on.	
Query example	:NSEquence:STATe? >OFF “Normal Sequence” is off.	

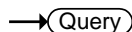
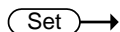

**:NSEquence**

Description	Configures the parameters for the Normal Sequence. This remote command is equivalent to the all the settings in the “Timing Edit for Normal Sequence” menu when entering the FUNC>Sequence>Normal Sequence menu.	
Note	CR mode unit = mS	
Syntax	:NSEquence { <NR1>,<NR1>,<string>,CC CR CV CP,ILVL IHVL ILVH IHVH,<NR1> INFinity,<bool> OFF ON,<NR2>,<NR1> OFF}	
Query Syntax	:NSEquence?	
Related Commands	:NSEquence:STATe	
Parameter	Parameter in order: <NR1> <NR1> <string>  CC CR CV CP ILVL IHVL ILVH  IHVH <NR1> INFinity <bool> ON OFF  <NR2>  <NR1> OFF	Description Starting sequence number Current sequence number Memo message. (need to enclose in quotes) Mode Range Sets the loop number Last Load 0=Off, 1=On. Sets the load condition after the end of the sequence. Last value: Sets the value of the load condition if Last Load = On Chain: Sets the next sequence in the chain.



Return parameter	<string>	Returns the normal sequence settings in the following order: Start:<NR1>, Seq No:<NR1>, Memo:<string>, Mode:CC CR CV CP, Range:ILVL IHVL ILVH IHSVH, Loop:<NR1>, Last Load:OFF ON, Last:<NR2>, Chain:<NR1>
------------------	----------	---

**Example** :NSEquence: 1,1,"hi",CC,ILVL,1,ON,0.000,2  
Sets the normal sequence configuration to that shown below.

**Query example** :NSEquence:?  
> Start:1, Seq No:1, Memo: HI, Mode:CC, Range:IHVL, Loop:1, Last Load:ON, Last:0.000, Chain:2  
Returns the normal sequence settings.



**Description** Sets or queries the starting sequence number.

**Syntax** :NSEquence:START {<NR1>}

**Query Syntax** :NSEquence:START?

**Parameter** <NR1> (1~10) sequence number

**Return Parameter** <string> Start:<NR1>

**Example** :NSEquence:START 1  
Sets the starting sequence number to 1.

**Query example** :NSEquence:START?  
>Start:1  
Returns the starting sequence number (1).

Set →

→ Query

**:NSEquence:NUMBER**

Description	Sets or queries the current sequence number for the normal sequence.	
Syntax	:NSEquence:NUMBER {<NR1>}	
Query Syntax	:NSEquence:NUMBER?	
Parameter/	<NR1>	(1~10) sequence number
Return Parameter	<string>	Seq No:<NR1>
Example	:NSEquence:NUMBER 1 Sets the sequence number to 1.	
Query example	:NSEquence:NUMBER? >Seq No:1 Returns the sequence number (1).	

Set →

→ Query

**:NSEquence:MEMO**

Description	Sets or queries the memo string for the normal sequence.	
Syntax	:NSEquence:MEMO {<string>}	
Query Syntax	:NSEquence:MEMO?	
Parameter	<string>	ASCII character string max of 12 characters. First character must be an alpha character. String must be enclosed in quotes.
Return Parameter	<string>	Memo: <string>
Example	:NSEquence:MEMO "HI" Sets the memo string to "HI".	
Query example	:NSEquence:MEMO? >Memo: HI Returns the memo string.	

Set →

→ Query

**:NSEquence:MODE**

Description	Sets or queries the mode used for the normal sequence.	
Syntax	:NSEquence:MODE {CC CR CV CP}	
Query Syntax	:NSEquence:MODE?	
Parameter	CC	Constant current mode
	CR	Constant resistance mode
	CV	Constant voltage mode
	CP	Constant power mode
Return Parameter	<string>	Mode: CC CR CV CP
Example	:NSEquence:MODE CC Sets the mode to CC.	
Query example	:NSEquence:MODE? >Mode: CC Returns the mode.	

Set →

→ Query

**:NSEquence:RANGe**

Description	Sets or queries the range used for the normal sequence.	
Syntax	:NSEquence:RANGe { ILVL IHVL ILVH IHVH }	
Query Syntax	:NSEquence:RANGe?	
Parameter	ILVL	Low I range, low V range
	IHVL	High I range, low V range
	ILVH	Low I range, high V range
	IHVH	High I range, high V range
Return Parameter	<string>	Returns the range in the following format: Range: ILVL
Example	:NSEquence:RANGe IHVL Sets the range to IHVL.	

Query example :NSEquence:RANGe?  
 >Range: IHVL  
 Returns the range.

Set →

**:NSEquence:LOOP**

→ Query

Description	Sets or queries the number of loops for the sequence.	
Syntax	:NSEquence:LOOP {<NR1> INFinity}	
Query Syntax	:NSEquence:LOOP?	
Parameter	<NR1> INFinity	(1~9999) Sets the number of loops Sets the number of loops to infinite.
Return Parameter	<string>	Returns the number of loops in the following format: Loop: <NR1> Infinity
Example	:NSEquence:LOOP 1 Sets the number of loops to 1.	

Query example :NSEquence:LOOP?  
 >Loop: 1  
 Returns the number of loops(1).

Set →

**:NSEquence:LLOad**

→ Query

Description	Sets or queries the Last Load state.	
Syntax	:NSEquence:LLOad {<bool> ON OFF}	
Query Syntax	:NSEquence:LLOad?	
Parameter	ON, 1 OFF, 0	Turns Last Load on. Turns Last Load off.
Return Parameter	<string>	Returns the Last Load state in the following format: Last Load:ON OFF
Example	:NSEquence:LLOad ON Turns Last Load on.	

Query example :NSEquence:LLOad?  
 >Last Load: ON  
 Returns the last load state.

Set →

→ Query

**:NSEquence:LAST**

Description Sets or queries the value of Last Load when Last Load = ON. The unit depends on the Mode.

Note CR mode unit = mS

Syntax :NSEquence:LAST{<NR2>}

Query Syntax :NSEquence:LAST?

Parameter <NR2> current value(CC), resistance value(CR), voltage value(CV), power value(CP).

Return Parameter <string> Returns the value for the Last Load in the following format:  
 Last:<NR2>

Example :NSEquence:LAST 1.000  
 Sets the value of Last Load to 1.000.

Query example :NSEquence:LAST?  
 >Last: 1.000  
 Returns the value of Last Load.

Set →

→ Query

**:NSEquence:CHAIIn**

Description Sets or queries the next sequence in the chain.

Syntax :NSEquence:CHAIIn {<NR1>|OFF}

Query Syntax :NSEquence:CHAIIn?

Parameter <NR1> The sequence number of the next sequence in the chain.

OFF End the chain at the current sequence.

Return Parameter <string> Returns the next sequence in the chain in the following format:  
 Chain:<NR1>|OFF

Example :NSEquence:CHAI n 2  
Sets the next sequence in the chain as S02.

Query example :NSEquence:CHAI?  
>Chain: 2  
Returns the next sequence in the chain (S02).

:NSEquence:EDIT

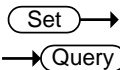

Description Configures the parameters for the Data Edit for Normal Sequence menu, equivalent to entering the FUNC>Sequence>Normal Sequence>Data Edit menu.

Note CR mode unit = mS

Syntax :NSEquence:EDIT  
{<NR1>,<NR1>,<NR2>,<NR1>,<NR1>,<NR1>,<NR1>  
,<bool>|OFF|ON,<bool>|OFF|ON,<bool>|OFF|ON,  
<bool>|OFF|ON}

Query Syntax :NSEquence:EDIT?

Related Commands :NSEquence:

Parameter	Parameters in order:	Description
	<NR1>	Current step number
	<NR1>	Total number of steps
	<NR2>	Value
	<NR1>	Time: hours
	<NR1>	Time: minutes
	<NR1>	Time: seconds
	<NR1>	Time: milliseconds
	<bool> OFF ON	LOAD setting
	<bool> OFF ON	TRIG OUT setting
	<bool> OFF ON	RAMP setting
	<bool> OFF ON	PAUSE setting

Return parameter	<string>	Returns the settings for the Data Edit for Normal Sequence menu: Step: <NR1>/<NR1>, Value: <NR1>, Time: <NR1>H: <NR1>M: <NR1>S: <NR1>ms, LOAD:ON OFF, TRIG OUT:ON OFF, RAMP: ON OFF, PAUSE: ON OFF
------------------	----------	---

**Example** :NSEquence:EDIT 3,12,0.1,0,1,0,0,ON,OFF,OFF,ON  
Configures the Data Edit for Normal Sequence menu to the settings shown below.

**Query example** :NSEquence:EDIT?  
> Step:3/12, Value:0.10000, Time:0H:0M:1S:0ms,  
LOAD:ON, TRIG OUT:OFF, RAMP:OFF, PAUSE:ON

**:NSEquence:EDIT:POINT** 

**Description** Sets or queries the current point in the sequence.

**Syntax** :NSEquence:EDIT:POINTt {<NR1>}

**Query Syntax** :NSEquence:EDIT:POINTt?

**Related Commands** :NSEquence:EDIT:END?

Parameter/ Return parameter	<NR1>	1~1000*. The current point in the sequence. *Depends on the number of steps in the sequence.
--------------------------------	-------	--

**Example** :NSEquence:EDIT:POINTt 10  
Sets the current point to 10.

**Query example** :NSEquence:EDIT:POINTt?  
>10  
Returns the current point in the sequence.

**:NSEquence:EDIT:END?** → Query

Description	Returns the number of points in the sequence.	
Query Syntax	:NSEquence:EDIT:END?	
Return parameter	<NR1>	1~1000
Query example	:NSEquence:EDIT:END? > 20	
	Indicates that there are 20 steps in the sequence.	

**:NSEquence[:DELEt]:ALL** Set →

Description	Deletes all the data points for the normal sequence.	
Syntax	:NSEquence[:DELEt]:ALL	
Example	:NSEquence:ALL	

**:NSEquence:SAVE** Set →

Description	Saves the data points for the normal sequence.	
Syntax	:NSEquence:SAVE	
Example	:NSEquence:SAVE	

**:FSEquence:STATe** Set →  
→ Query

Description	Sets or queries the state of the Fast Sequence function.	
Syntax	:FSEquence:STATe {ON   OFF}	
Query Syntax	:FSEquence:STATe?	
Parameter	ON	Turn fast sequence on
	OFF	Turn fast sequence off
Return Parameter	ON,STOP	Fast sequence is on
	RUN,STOP	Fast sequence is running
	OFF	Fast sequence is off



Example :FSEquence:STATe ON  
Turns “Fast Sequence” on.

Query example :FSEquence:STATe?  
>OFF  
“Fast Sequence” is off.

**:FSEquence**

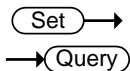

Description Configures the parameters for the Fast Sequence. This remote command is equivalent to all the settings in the “Timing Edit for Fast Sequence” menu when entering the FUNC>Sequence>Fast Sequence menu.

Note CR mode unit = mS

Syntax :FSEquence {<string>,CC|CR, ILVL|IHVL|ILVH|IHVH, <NR1>|INFinity,<NR2>,<bool>|OFF|ON,<NR2>,<NR1>}

Query Syntax :FSEquence?

Related Commands :FSEquence:STATe

Parameter	Parameter in order:	Description
	<string>	Memo message. (Need to enclose in quotes)
	CC CR	Mode
	ILVL IHVL ILVH IHVH	Range
	<NR1> INFinity	Number of loops
	<NR2>	Time base in seconds
	<bool> ON OFF	Last Load 0=Off, 1=On. Sets the load condition after the end of the sequence.
	<NR2>	Last value: Sets the value of the load condition for Last Load = On
	<NR1>	Repeat Step from (0001~1000) per loop

Return parameter	<string>	Returns the fast sequence settings in the following order: FSeq:ON OFF; Memo:<string>, Mode:CC CR, Range:ILVL IHVL ILVH IHVH, Loop: <NR1> Infinity, Time Base:<NR2>, Last Load:ON OFF, Last:<NR2>, RPTSTEP:<NR1>
------------------	----------	--

**Example** :FSEquence HI,CC,ILVL,5,0.3,1,0.7,11  
Sets the fast sequence configuration to that shown below.

**Query example** :FSEquence?  
>Memo: HI, Mode:CC, Range:ILVL, Loop:5, Time Base:300.00, Last Load:OFF, Last:0.70000, RPTSTEP:11  
Returns the fast sequence settings.

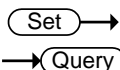

**:FSEquence:MEMO**

Description	Sets or queries the memo string for the fast sequence.	
Syntax	:FSEquence:MEMO {<string>}	
Query Syntax	:FSEquence:MEMO?	
Parameter	<string>	ASCII character string max of 12 characters. First character must be an alpha character. The string must be enclosed in quotes.
Return Parameter	<string>	Memo:<string>
Example	:FSEquence:MEMO "HI" Sets the memo string to "HI".	

Query example :FSEquence:MEMO?  
 >Memo: HI  
 Returns the memo string.

Set →

→ Query

**:FSEquence:MODE**

Description Sets or queries the mode used for the fast sequence.

Syntax :FSEquence:MODE {CC|CR}

Query Syntax :FSEquence:MODE?

Parameter	CC	Constant current mode
	CR	Constant resistance mode

Return Parameter <string> Mode: CC|CR

Example :FSEquence:MODE CC  
 Sets the mode to CC.

Query example :FSEquence:MODE?  
 >Mode: CC  
 Returns the mode.

Set →

→ Query

**:FSEquence:RANGe**

Description Sets or queries the range used for the fast sequence.

Syntax :FSEquence:RANGe { ILVL|IHVL|ILVH|IHVH }

Query Syntax :FSEquence:RANGe?

Parameter	ILVL	Low I range, low V range
	IHVL	High I range, low V range
	ILVH	Low I range, high V range
	IHVH	High I range, high V range

Return Parameter <string> Returns the range in the following format:  
 Range: ILVL

Example :FSEquence:RANGe IHVL  
 Sets the range to IHVL.

Query example :FSEquence:RANGe?  
 >Range: IHVL  
 Returns the range.

Set →

**:FSEquence:LOOP**

→ Query

Description Sets or queries the number of loops for the sequence.

Syntax :FSEquence:LOOP {<NR1>|INFINITY}

Query Syntax :FSEquence:LOOP?

Parameter <NR1> (1~9999) Sets the number of loops  
 INFINITY Sets the number of loops to infinite.

Return Parameter <string> Loop:<NR1>

Example :FSEquence:LOOP 1  
 Sets the number of loops to 1.

Query example :FSEquence:LOOP?  
 >Loop:1  
 Returns the number of loops(1).

Set →

**:FSEquence:TBASe**

→ Query

Description Sets or queries the Time Base.

Syntax :FSEquence:TBASe {<NR2>[s]}

Query Syntax :FSEquence:TBASe?

Parameter <NR2>[s] 0.000025 ~ 0.6s

Return Parameter <string> Returns the Time Base in the following format:  
 Time Base:<NR2>

Example :FSEquence:TBASe 0.3  
 Sets the time base to 300ms.

Query example :FSEquence:TBASe?  
 >Time Base:0.30000  
 Returns the time base.

**:FSEquence:LLOad** 



Description	Sets or queries the Last Load state.	
Syntax	:FSEquence:LLOad {<bool>ON OFF}	
Query Syntax	:FSEquence:LLOad?	
Parameter	ON, 1	Turns Last Load on.
	OFF, 0	Turns Last Load off.
Return Parameter	<string>	Last Load:ON OFF
Example	:FSEquence:LLOad ON Turns Last Load on.	
Query example	:FSEquence:LLOad? >Last Load: ON Returns the last load state.	

**:FSEquence:LAST** 



Description	Sets or queries the value of Last Load when Last Load = ON.	
Note	CR mode unit = mS	
Syntax	:FSEquence:LAST{<NR2>}	
Query Syntax	:FSEquence:LAST?	
Parameter	<NR2>	Current value(CC), resistance value(CR)
Return Parameter	<string>	Last:<NR2>
Example	:FSEquence:LAST 1.000 Sets the value of Last Load to 1.000.	
Query example	:FSEquence:LAST? >Last: 1.000 Returns the value of Last Load.	

Set →  
 → Query

**:FSEquence:RPTStep**

---

Description	Sets or queries the last step number per loop.	
Syntax	:FSEquence:RPTStep {<NR1>}	
Query Syntax	:FSEquence:RPTStep?	
Parameter	<NR1>	1~1000
Return Parameter	<string>	RPTSTEP:<NR1>
Example	:FSEquence:RPTStep 11 Sets the RPTSTEP to 11.	
Query example	:FSEquence:RPTStep? > RPTSTEP: 11 Returns the RPTSTEP number.	

Set →  
 → Query

**:FSEquence:EDIT**

---

Description	Configures the parameters for the Data Edit for Fast Sequence menu, equivalent to entering the FUNC>Sequence>Fast Sequence>Edit Sequence menu.	
Note	CR mode unit = mS	
Syntax	:FSEquence:EDIT {<NR1>,<NR1>,<NR2>,<bool> OFF ON}	
Query Syntax	:FSEquence:EDIT?	
Related Commands	:FSEquence:	

Parameter	Parameters in order:	Description
	<NR1>	Current step number
	<NR1>	Total number of steps
	<NR2>	Value
	<bool> OFF ON	TRIG OUT setting
Return parameter	<string>	Returns the settings for the Data Edit for Fast Sequence menu: Step:<NR1>/<NR1>, Value:<NR2>, TRIG OUT:ON OFF

**Example** :FSEquence:EDIT 4,11,0.1,OFF  
Configures the Data Edit for Normal Sequence menu to the settings shown below.

**Query example** :FSEquence:EDIT?  
> Step:0004/0011; Value:0.10000, TRIG OUT:OFF

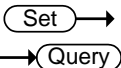
:FSEquence:EDIT:POINTt 

**Description** Sets or queries the current point in the sequence.

**Syntax** :FSEquence:EDIT:POINTt {<NR1>}

**Query Syntax** :FSEquence:EDIT:POINTt?

**Related Commands** :FSEquence:EDIT:END?

Parameter/ Return parameter	<NR1>	1~1000*. The current point in the sequence. *Depends on the number of steps in the sequence.
--------------------------------	-------	--

**Example** :FSEquence:EDIT:POINTt 10  
Sets the current point to 10.

**Query example** :FSEquence:EDIT:POINTt?  
>10  
Returns the current point in the sequence.

**:FSEquence:EDIT:END?** → Query

Description	Returns the number of points in the sequence.	
Query Syntax	:FSEquence:EDIT:END?	
Return parameter	<NR1>	1~1000
Query example	:FSEquence:EDIT:END? > 20  Indicates that there are 20 steps in the sequence.	

**:FSEquence[:DELet]:ALL** Set →

Description	Deletes all the data points for the fast sequence.	
Syntax	:FSEquence[:DELet]:ALL	
Example	:FSEquence:ALL	

**:FSEquence[:EDIT]:FILL** Set →  
→ Query

Description	The FILL function is used to evenly fill up the current or resistance value settings from a starting step to a finishing step. This function is equivalent to entering the FUNC>Sequence>Fast Sequence>Edit Sequence>Fill menu.	
Note	CR mode unit = mS	
Syntax	:FSEquence[:EDIT]:FILL {<NR2>,<NR2>,<NR1>,<NR1>}	
Query Syntax	:FSEquence[:EDIT]:FILL?	
Related Commands	:FSEquence:EDIT	



Parameter	Parameters in order:	Description
	<NR2> <NR2> <NR1> <NR1>	Start_Value End_Value Start_Step End_Step
Return parameter	<string>	Returns the settings for the Fill Edit for Fast Sequence menu: Start Value:<NR2>, End Value:<NR2>, Start Step:<NR1>, End Step:<NR1>

**Example**           :FSQuence:FILL 0.1,0.5,1,159  
 Fills the values of step 1 to step 159 gradually from 0.1A to 0.5A.

**Query example**   :FSQuence:FILL?  
 >Start Value:0.10000, End Value:0.50000, Start Step:1, End Step:159

**:FSQuence:SAVE** (Set) →

<b>Description</b>	Saves the data points for the fast sequence.
<b>Syntax</b>	:FSQuence:SAVE
<b>Example</b>	:FSQuence:SAVE

## Utility Commands

:UTILITY:SYSTEM?	128
:UTILITY:LOAD	128
:UTILITY:LOAD:MODE	129
:UTILITY:LOAD:RANGE	130
:UTILITY:INTERFACE	131
:UTILITY:TIME	131
:UTILITY:KNOB	132
:UTILITY:SPEAKER	132
:UTILITY:ALARM	133
:UTILITY:UNREG	133
:UTILITY:GNG	134
:UTILITY:CONTRAST	134
:UTILITY:BRIGHTNESS	134
:UTILITY:LANGUAGE	135
:UTILITY:REMOTE	135
:UTILITY:REMOTE:MODE	136

### :UTILITY:SYSTEM?

→ Query

Description	Returns the manufacturer, model, serial number and firmware version number.	
Query Syntax	:UTILITY:SYSTEM?	
Return parameter	<string>	model name, serial number, firmware version
Query example	:UTILITY:SYSTEM? >GW,PEL-303XE,00000001,V1.00 Returns the system information.	

Set →

### :UTILITY:LOAD

→ Query

Description	Sets or queries the Auto Load and Auto Load On settings. This is equivalent to the settings in the Shift+UTILITY>Load menu.	
Syntax	:UTILITY:LOAD {OFF ON LOAD PROG NSEQ FSEQ}	

Query Syntax	:UTILity:LOAD?	
Parameter	OFF	Turns Auto Load off.
	ON	Turns Auto Load on. This will turn the load on automatically at start up. The type of load function that is automatically turned on is configured below.
	LOAD	Configure the load to automatically turn on in CC, CR, CV or CP mode.
	PROG	Configure the load to automatically turn on a program sequences.
	NSEQ	Configure the load to automatically turn on a normal sequence.
	FSEQ	Configure the load to automatically turn on a fast sequence.
Return Parameter	<string>	Load:On Off, Load On:Load Prog NSeq FSeq

**Example**                   :UTILity:LOAD ON FSEQ  
 Configures the unit to automatically turn fast sequences on at start up (with the load on).

**Query example**        :UTILity:LOAD?  
 > Load:On, Load On:Prog  
 The unit is configured to automatically turn Programs on at start up (with the load on).



**Description**           Sets or queries the Load Off (Mode) setting. This is equivalent to the settings in the Shift+UTILITY>Load menu.

**Syntax**                :UTILity:LOAD:MODE {<bool>|OFF|ON}

Query Syntax	:UTILity:LOAD:MODE?	
Parameter	OFF, 0	Sets Load Off (Mode) to OFF.
	ON, 1	Sets Load Off (Mode) to ON.
Return Parameter	OFF	Load Off (Mode) is OFF.
	ON	Load Off (Mode) is ON.
Example	:UTILity:LOAD:MODE ON Turns Load Off (Mode) to on.	
Query example	:UTILity:LOAD:MODE? > Off Load Off (Mode) is off.	

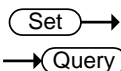

**:UTILity:LOAD:RANGe**

Description	Sets or queries the Load Off (Range) setting. This is equivalent to the settings in the Shift+UTILITY>Load menu.	
Syntax	:UTILity:LOAD:RANGe {<bool> OFF ON}	
Query Syntax	:UTILity:LOAD:RANGe?	
Parameter	OFF, 0	Sets Load Off (Range) to OFF.
	ON, 1	Sets Load Off (Range) to ON.
Return Parameter	OFF	Load Off (Range) is OFF.
	ON	Load Off (Range) is ON.
Example	:UTILity:LOAD:RANGe ON Turns Load Off (Range) to on.	
Query example	:UTILity:LOAD:RANGe? > Off Load Off (Range) is off.	

**:UTILity:INTerface** 

Description	Sets or queries the remote interface. Settings only take effect after a restart.	
Syntax	:UTILity:INTerface {USB   GPIB}	
Query Syntax	:UTILity:INTerface?	
Parameter/ Return Parameter	USB GPIB	USB remote interface GPIB remote interface
Example	:UTILity:INTerface USB Sets the interface to USB.	
Query example	:UTILity:INTerface? >USB The current remote interface is USB.	

**:UTILity:TIME** 

Description	Sets or queries the date and time for the unit.	
Syntax	:UTILity:TIME <NR1>,<NR1>,<NR1>,<NR1>,<NR1>	
Query Syntax	:UTILity:TIME?	
Parameter	Parameters in order <NR1> <NR1> <NR1> <NR1> <NR1>	Description Month Day Year Hour Minute
Return Parameter	<string>	Month:<NR1>, Day: <NR1>, Year: <NR1>, Hour: <NR1>, Minute: <NR1>
Example	:UTILity:TIME 10,2,2013,8,26 Sets the date to October 2, 2013. Sets the time to 8:26.	
Query example	:UTILity:TIME? > Month:10, Day:2, Year:2013, Hour:8, Minute:26	

Set →

→ Query

**:UTILity:KNOB**

**Description**      The Knob Type setting determines if values are updated immediately as they are edited or if they are only updated after the Enter key is pressed.

The Updated setting is applicable for when the load is already on and the user wishes to change the set values (current, voltage, etc.) in real-time.

The Old setting will only update the values after the Enter key is pressed.

**Syntax**            :UTILity:KNOB {OLD|UPDated}

**Query Syntax**    :UTILity:KNOB?

<b>Parameter/</b>	OLD	Old setting
<b>Return Parameter</b>	UPDated	Updated setting

**Example**            :UTILity:KNOB OLD

Sets the knob type to OLD.

**Query Example**    :UTILity:KNOB?

>Old

Set →

→ Query

**:UTILity:SPEaker**

**Description**      Turns the speaker on or off.

Note: This will not turn the Go/NoGo alarm tone settings.

**Syntax**            :UTILity:SPEaker {<bool>|ON|OFF}

**Query Syntax**    :UTILity:SPEaker?

<b>Parameter</b>	ON, 1	Speaker on
	OFF, 0	Speaker off
<b>Return Parameter</b>	On	Speaker on
	Off	Speaker off

**Example**            :UTILity:SPEaker ON

Turns the speaker on.

Query Example :UTILity:SPEaker?  
>On

:UTILity:ALARm

Set →

→ Query

Description Enables/disables the alarm tone for the unit.

Syntax :UTILity:ALARm {<bool>|ON|OFF}

Query Syntax :UTILity:ALARm?

Parameter	ON, 1	Alarm on
	OFF, 0	Alarm off

Return Parameter	On	Alarm on
	Off	Alarm off

Example :UTILity:ALARm ON  
Enables the alarm tone.

Query Example :UTILity:ALARm?  
>On

:UTILity:UNReg

Set →

→ Query

Description Enables/disables the UnReg alarm tone for the unit.

Syntax :UTILity:UNReg {<bool>|ON|OFF}

Query Syntax :UTILity:UNReg?

Parameter	ON, 1	Alarm on
	OFF, 0	Alarm off

Return Parameter	On	Alarm on
	Off	Alarm off

Example :UTILity:UNReg ON  
Enables the alarm tone.

Query Example :UTILity:UNReg?  
>On

Set →  
→ Query

---

**:UTILity:GNG**

Description	Enables/disables the Go/NoGo alarm tone for the unit.	
Syntax	:UTILity:GNG {<bool> ON OFF}	
Query Syntax	:UTILity:GNG?	
Parameter	ON, 1 OFF, 0	Go/NoGo alarm tone on Go/NoGo alarm tone off
Return Parameter	On Off	Go/NoGo alarm tone on Go/NoGo alarm tone off
Example	:UTILity:GNG ON Enables the Go/NoGo alarm tone.	
Query Example	:UTILity:GNG? >On	

Set →  
→ Query

---

**:UTILity:CONTRast**

Description	Sets or queries the display contrast level.	
Syntax	:UTILity:CONTRast {NR1}	
Query Syntax	:UTILity:CONTRast?	
Parameter/ Return Parameter	<NR1>	3~13 (low ~ high)
Example	:UTILity:CONTRast 8 Sets the contrast to 8.	
Query Example	:UTILity:CONTRast? >8	

Set →  
→ Query

---

**:UTILity:BRIGHtness**

Description	Sets or queries the display contrast level.	
Syntax	:UTILity:BRIGHtness {NR1}	



Query Syntax	:UTILity:BRIGhtness?	
Parameter/ Return Parameter	<NR1>	50~90 (low ~ high)
Example	:UTILity:BRIGhtness 70 Sets the contrast to 70.	
Query Example	:UTILity:BRIGhtness? >70	

Set →  
 → Query

---

**:UTILity:LANGUage**

Description	Sets or queries the language. Note: English is the only available language.	
Syntax	:UTILity:LANGUage {ENGLish}	
Query Syntax	:UTILity:LANGUage?	
Parameter/ Return Parameter	ENGLish	English language settings
Example	:UTILity:LANGUage? ENGLish Sets the language to English.	
Query Example	:UTILity:LANGUage? >English	

Set →

---

**:UTILity:REMote**

Description	Turns the remote control on or off.	
Syntax	:UTILity:REMote {OFF 0 ON 1}	
Parameter	OFF/0	Turns Remote control off
	ON/1	Turns remote control on
Example	:UTIL:REM 1 Turns remote control on.	

**:UTILity:REMOte:MODE**



**Description**      Sets the remote mode to fast or normal. When in fast mode, the panel interface is deactivated with an interface time of no more than 10ms. Normal mode has an interface time of 30~130ms. In normal mode the display interface continues to update the screen in real-time.

**Syntax**            :UTILity:REMOte:MODE {NORMAL|0|FAST|1}

<b>Parameter</b>	NORMAL/0	NORMAL
	FAST/1	FAST

**Example**            :UTIL:REM:MODE 1  
 Turns remote mode to fast.

## File Commands

:MEMory:SAVE.....	137
:MEMory:RECall .....	137
:PRESet:SAVE .....	138
:PRESet:RECall .....	138
:SETup:SAVE.....	138
:SETup:RECall .....	138
:FACTory[:RECall] .....	139
:USER[:DEFault]:SAVE.....	139
:USER[:DEFault]:RECall .....	139

### :MEMory:SAVE



Description	Saves Memory Data to internal memory to one of 256 slots.	
Syntax	:MEMory:SAVE {<NR1>}	
Parameter	<NR1>	M001 ~ M256
Example	:MEMory:SAVE 1 Save Memory Data to M001.	

### :MEMory:RECall



Description	Recalls Memory Data from internal memory to one of 256 slots.	
Syntax	:MEMory:RECall {<NR1>}	
Parameter	<NR1>	M001 ~ M256
Example	:MEMory:RECall 1 Recall Memory Data from M001.	

**:PRESet:SAVE**

Description	Saves Preset Data to internal memory to one of 9 slots.
-------------	---

Syntax	:PRESet:SAVE {<NR1>}
--------	----------------------

Parameter	<NR1>	P1 ~ P9
-----------	-------	---------

Example	:PRESet:SAVE 1 Save Preset Data to P1.
---------	---

**:PRESet:RECall**

Description	Recalls Preset Data from internal memory to one of 9 slots.
-------------	---

Syntax	:PRESet:RECall {<NR1>}
--------	------------------------

Parameter	<NR1>	P1 ~ P9
-----------	-------	---------

Example	:PRESet:RECall 1 Recall Preset Data from P1.
---------	---

**:SETup:SAVE**

Description	Saves Setup Data to internal memory to one of 100 slots.
-------------	--

Syntax	:SETup:SAVE {<NR1>}
--------	---------------------

Parameter	<NR1>	S001 ~ S100
-----------	-------	-------------

Example	:SETup:SAVE 1 Save Setup Data to S001.
---------	---

**:SETup:RECall**

Description	Recalls Setup Data from internal memory to one of 100 slots.
-------------	--

Syntax	:SETup:RECall {<NR1>}
--------	-----------------------

Parameter	<NR1>	S001 ~ S100
-----------	-------	-------------

---

Example	:SETup:RECall 1 Recall Setup Data from S001.
---------	---

---

**:FACTory[:RECall]** 

---

Description	Recalls the default settings. See the user manual for the default settings.
-------------	---

---

Syntax	:FACTory[:RECall]
--------	-------------------

---

Example	:FACTory
---------	----------

---

**:USER[:DEFault]:SAVE** 

---

Description	Saves the current settings as the user default.
-------------	---

---

Syntax	:USER[:DEFault]:SAVE
--------	----------------------

---

Example	:USER:SAVE Saves the current settings as the user default.
---------	---

---

**:USER[:DEFault]:RECall** 

---

Description	Recalls the user default settings.
-------------	------------------------------------

---

Syntax	:USER[:DEFault]:RECall
--------	------------------------

---

Example	:USER:RECall Recalls the user default settings.
---------	--

---

## SCPI Register Commands

:SYSTem:ERRor?	140
:STATus:PRESet	141
:STATus:QUEStionable:CONDition?	141
:STATus:QUEStionable:ENABle	142
:STATus:QUEStionable[:EVENT]?	142
:STATus:QUEStionable:NTRansiion	143
:STATus:QUEStionable:PTRansiion	144
:STATus:OPERation:CONDition?	144
:STATus:OPERation:ENABle	145
:STATus:OPERation[:EVENT]?	145
:STATus:OPERation:NTRansiion	146
:STATus:OPERation:PTRansiion	146
:STATus:CSUMmary:CONDition?	147
:STATus:CSUMmary:ENABle	147
:STATus:CSUMmary[:EVENT]?	148
:STATus:CSUMmary:NTRansiion	148
:STATus:CSUMmary:PTRansiion	149

### :SYSTem:ERRor?

→ **Query**

Description	Return the error message in the error queue. If there is no error, "+0, "No error." Will be returned.	
Query Syntax	:SYSTem:ERRor?	
Return parameter	<string>	Error code, followed by error description.
Query example	:SYSTem:ERRor? > +0, "No error." Returns the system information.	

**:STATus:PRESet**

**Set** →

**Description** The :STATus:PRESet command resets the enable registers NTR/PTR registers from Operation Status, Questionable Status and CSummary Status registers.

Preset Value	Register	Preset
	Operation Status Enable	All bits set to 1
	Operation Status PTR	All bits set to 1
	Operation Status NTR	All bits set to 0
	Questionable Status Enable	All bits set to 0
	Questionable Status PTR	All bits set to 1
	Questionable Status NTR	All bits set to 0
	CSummary Status Enable	All bits set to 0
	CSummary Status PTR	All bits set to 1
	CSummary Status NTR	All bits set to 0

**Syntax** :STATus:PRESet

**:STATus:QUEStionable:CONDition?**

→ **Query**

**Description** Returns the status of the Questionable Status Condition register. See page 154 for details.

**Query Syntax** :STATus:QUEStionable:CONDition?

Return parameter	<NR1>	Condition	<NR1>	Condition
	1	OV	512	UV
	2	OC	1024	EXT
	8	OP	2048	REV
	16	OT	All other bits	Not used

**Query example** :STATus:QUEStionable:CONDition?  
>1

Indicates an over voltage (OV) error has occurred.

**:STATus:QUEStionable:ENABLE**

Set →

→ Query

**Description** Sets which events are enabled in the Questionable Status Enable register. The mask values are the bit weights of the events. See page 154 for details.

**Syntax** :STATus:QUEStionable:ENABLE <NR1>

**Query Syntax** :STATus:QUEStionable:ENABLE?

Parameter/ Return Parameter	<NR1>	Condition	<NR1>	Condition
	1	OV	512	UV
	2	OC	1024	EXT
	8	OP	2048	REV
	16	OT	All other bits	Not used

**Example** :STATus:QUEStionable:ENABLE 11  
Events OV, OC and OP (Bits 1, 2, 3) are enabled in the Questionable Status Enable register.

**Query example** :STATus:QUEStionable:ENABLE?  
>11  
Indicates that OV, OC and OP bits are enabled in the Questionable Status Enable register.

**:STATus:QUEStionable[:EVENT]?**

→ Query

**Description** Returns the status of the Questionable Status Event register. The register is cleared upon reading. See page 154 for details.

**Query Syntax** :STATus:QUEStionable[:EVENT]?

Return parameter	<NR1>	Condition	<NR1>	Condition
	1	OV	512	UV
	2	OC	1024	EXT
	8	OP	2048	REV
	16	OT	All other bits	Not used



Query example :STATus:QUESTionable:EVENT?  
> 1

Indicates an over voltage (OV) event has occurred.

:STATus:QUESTionable:NTRansition  

**Description** Determines whether a negative transition (NTR 1→0) in the Questionable Status Condition register will set the corresponding event in the Questionable Status Event register.

The mask values are the bit weights of the Questionable Status NTR filters. See page 154 for details.

**Syntax** :STATus:QUESTionable:NTRansition <NR1>

**Query Syntax** :STATus:QUESTionable:NTRansition?

Parameter/ Return Parameter	<NR1>	Condition	<NR1>	Condition
	1	OV	512	UV
	2	OC	1024	EXT
	8	OP	2048	REV
	16	OT	All other bits	Not used

**Example** :STATus:QUESTionable:NTRansition 11

Configures the OV, OC and OP bits (Bits 1, 2, 3) in the Questionable Status Condition register to set the corresponding bits in the Questionable Status Enable register on a negative transition

**Query example** :STATus:QUESTionable:NTRansition?  
>11

OV, OC and OP bits are configured to NTR in the Questionable Status NTR filter.

**:STATus:QUEStionable:PTRansition** 

**Description** Determines whether a positive transition (PTR 0→1) in the Questionable Status Condition register will set the corresponding event in the Questionable Status Event register.

The mask values are the bit weights of the Questionable Status PTR filters. See page 154 for details.

**Syntax** :STATus:QUEStionable:PTRansition <NR1>

**Query Syntax** :STATus:QUEStionable:PTRansition?

Parameter/ Return Parameter	<NR1>	Condition	<NR1>	Condition
	1	OV	512	UV
	2	OC	1024	EXT
	8	OP	2048	REV
	16	OT	All other bits	Not used

**Example** :STATus:QUEStionable:PTRansition 11

Configures the OV, OC and OP bits (Bits 1, 2, 3) in the Questionable Status Condition register to set the corresponding bits in the Questionable Status Enable register on a positive transition.

**Query example** :STATus:QUEStionable:PTRansition?  
>11

OV, OC and OP bits are configured to PTR in the Questionable Status PTR filter.

**:STATus:OPERation:CONDition?** 

**Description** Returns the status of the Operation Status Condition register. See page 155 for details.

**Query Syntax** :STATus:OPERation:CONDition?

Return parameter	<NR1>	Condition	<NR1>	Condition
	1	CAL	All other bits	
	32	WTG		

Query example :STATus:OPERation:CONDition?  
>32

Indicates that the unit is waiting for a trigger.

:STATus:OPERation:ENABLE

Set →

→ Query

**Description** Sets which events are enabled in the Operation Status Enable register. The mask values are the bit weights of the events. See page 155 for details.

**Syntax** :STATus:OPERation:ENABLE <NR1>

**Query Syntax** :STATus:OPERation:ENABLE?

Parameter/ Return Parameter	<NR1>	Condition	<NR1>	Condition
	1	CAL	All other bits	Not used
	32	WTG		

**Example** :STATus:OPERation:ENABLE 32  
WTG is enabled in the OPERATION Status Enable register.

Query example :STATus:OPERation:ENABLE?  
>32

Indicates that the WTG bit is enabled in the Operation Status Enable register.

:STATus:OPERation[:EVENT]?

→ Query

**Description** Returns the status of the Operation Status Event register. The register is cleared upon reading. See page 155 for details.

**Query Syntax** :STATus:OPERation[:EVENT]?

Return parameter	<NR1>	Condition	<NR1>	Condition
	1	CAL	All other bits	Not used
	32	WTG		

Query example :STATus:OPERation:EVENT?  
> 1

Indicates that unit is currently calibrating.

**:STATus:OPERation:NTRansition**

Set →

→ Query

**Description** Determines whether a negative transition (NTR 1→0) in the Operation Status Condition register will set the corresponding event in the Operation Status Event register.

The mask values are the bit weights of the Operation Status NTR filters. See page 155 for details.

**Syntax** :STATus:OPERation:NTRansition <NR1>

**Query Syntax** :STATus:OPERation:NTRansition?

Parameter/ Return Parameter	<NR1>	Condition	<NR1>	Condition
	1	CAL	All other bits	Not used
	32	WTG		

**Example** :STATus:OPERation:NTRansition 1

Configures the CAL bit (Bit 1) in the Operation Status Condition register to set the corresponding bit in the Questionable Status Enable register on a negative transition

**Query example** :STATus:OPERation:NTRansition?  
>1

The CAL bit is configured to NTR in the Operation Status NTR filter.

Set →

→ Query

**:STATus:OPERation:PTRansition**

**Description** Determines whether a positive transition (PTR 0→1) in the Operation Status Condition register will set the corresponding event in the Operation Status Event register.

The mask values are the bit weights of the Operation Status PTR filters. See page 155 for details.

Syntax :STATus:OPERation:PTRansition <NR1>

Query Syntax :STATus:OPERation:PTRansition?

Parameter/ Return Parameter	<NR1>	Condition	<NR1>	Condition
	1	CAL	All other	Not used
	32	WTG	bits	

Example :STATus:OPERation:PTRansition 32  
 Configures the WTG bit (Bit 5) in the Operation Status Condition register to set the corresponding bit in the Operation Status Enable register on a positive transition.

Query example :STATus:OPERation:PTRansition?  
 >32  
 The WTG bit is configured to PTR in the Operation Status PTR filter.

**:STATus:CSUMmary:CONDition?** → Query

Description Returns the status of the CSummary Status Condition register. See page 153 for details.

Query Syntax :STATus:CSUMmary:CONDition?

Return parameter	<NR1>	Condition	<NR1>	Condition
	1	CC	256	PRUN
	2	CR	All other	Not used
	4	CV	bits	
	8	CP		

Query example :STATus:CSUMmary:CONDition?  
 >1  
 Indicates the unit is in CC mode.

**:STATus:CSUMmary:ENABLE** Set →  
→ Query

Description Sets which events are enabled in the CSummary Status Enable register. The mask values are the bit weights of the events. See page 153 for details.

Syntax	:STATus:CSUMmary:ENABLE <NR1>			
Query Syntax	:STATus:CSUMmary:ENABLE?			
Parameter/ Return Parameter	<NR1>	Condition	<NR1>	Condition
	1	CC	256	PRUN
	2	CR	All other	Not used
	4	CV	bits	
	8	CP		
Example	:STATus:CSUMmary:ENABLE 1 Enables the CC bit in the CSummary Status Enable register.			
Query example	:STATus:CSUMmary:ENABLE? >1 Indicates that the CC bit is enabled in the CSummary Status Enable register.			

**:STATus:CSUMmary[:EVENT]?** → Query

Description	Returns the status of the CSummary Status Event register. The register is cleared upon reading. See page 153 for details.			
Query Syntax	:STATus:CSUMmary[:EVENT]?			
Return parameter	<NR1>	Condition	<NR1>	Condition
	1	CC	256	PRUN
	2	CR	All other	Not used
	4	CV	bits	
	8	CP		
Query example	:STATus:CSUMmary:EVENT? > 1 Indicates that the unit is in CC mode.			

**:STATus:CSUMmary:NTRansition** Set →  
→ Query

Description	Determines whether a negative transition (NTR 1→0) in the CSummary Status Condition register will set the corresponding event in the CSummary Status Event register.			
-------------	--	--	--	--

The mask values are the bit weights of the CSUMmary Status NTR filters. See page 153 for details.

Syntax	:STATus:CSUMmary:NTRansition <NR1>			
Query Syntax	:STATus:CSUMmary:NTRansition?			
Parameter/ Return Parameter	<NR1>	Condition	<NR1>	Condition
	1	CC	256	PRUN
	2	CR	All other bits	Not used
	4	CV		
	8	CP		

**Example** :STATus:CSUMmary:NTRansition 3  
 Configures the CC and CR bits (Bits 1, 2) in the CSUMmary Status Condition register to set the corresponding bits in the CSUMmary Status Enable register on a negative transition.

**Query example** :STATus:CSUMmary:NTRansition?  
 >3  
 The CC and CR bits are configured to NTR in the CSUMmary Status NTR filter.

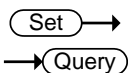

**:STATus:CSUMmary:PTRansition**

**Description** Determines whether a positive transition (PTR 0→1) in the CSUMmary Status Condition register will set the corresponding event in the CSUMmary Status Event register.  
 The mask values are the bit weights of the CSUMmary Status PTR filters. See page 153 for details.

Syntax	:STATus:CSUMmary:PTRansition <NR1>			
Query Syntax	:STATus:CSUMmary:PTRansition?			
Parameter/ Return Parameter	<NR1>	Condition	<NR1>	Condition
	1	CC	256	PRUN
	2	CR	All other bits	Not used
	4	CV		
	8	CP		

Example :STATus:CSUMmary:PTRansition 12  
Configures the CV and CP bits (Bits 3, 4) in the CSummary Status Condition register to set the corresponding bits in the CSummary Status Enable register on a positive transition.

---

Query example :STATus:CSUMmary:PTRansition?  
>12  
The CV and CP bits are configured to PTR in the CSummary Status PTR filter.



## Status Registers

To program the PEL-3000E Series effectively, the Status Register structure needs to be understood. This chapter explains in detail the structure of the status registers.

---

### Overview

The status registers are used to determine the status of the electronic load. The status registers maintain the status of the protection conditions, load conditions and channel conditions of the load modules.

The PEL-3000E series have a number of register groups:

CSummary Registers

Questionable Status Registers

Standard Event Status Registers

Status Byte Register

Service Request Generation Register

Each register group consists of a Condition, EVENT and ENABLE register. They also have PTR and NTR (positive and negative transition) filters.

The structure of the status registers is shown on the next page.

---

Status Registers

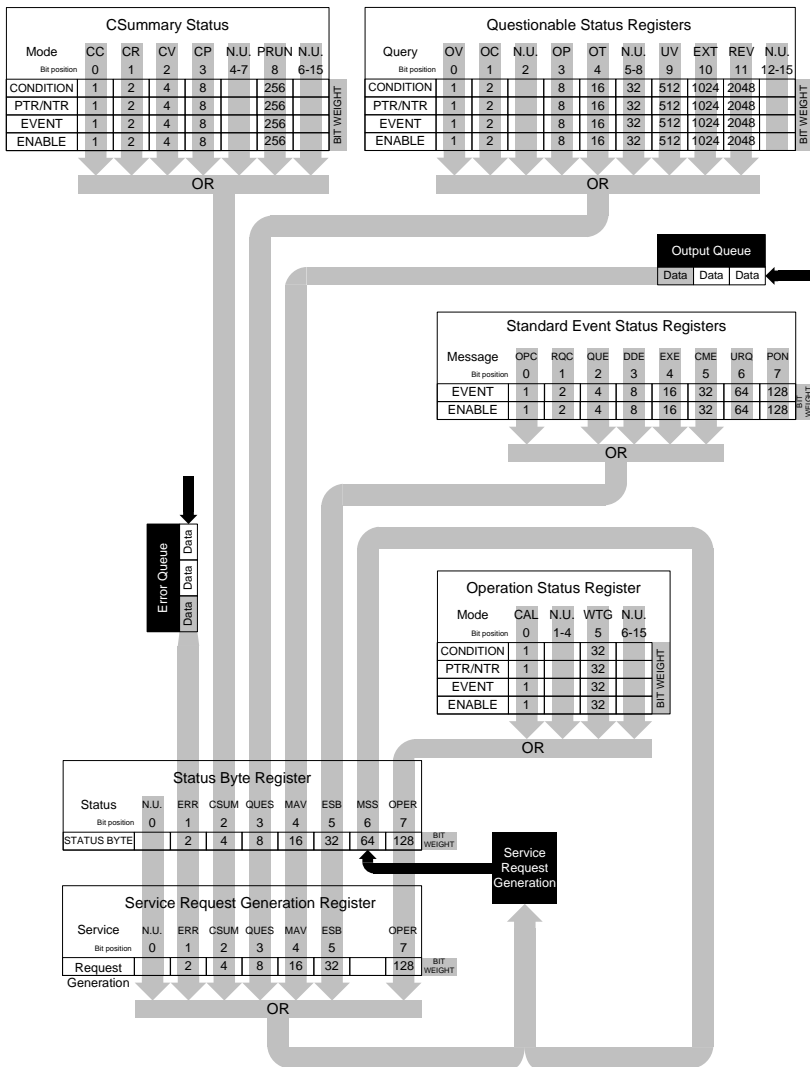

## CSummary Status Registers

**Overview** The CSummary Status registers indicate the current operation mode of the load generator.

CSummary Status Registers							
Bit Position	9-15	8	4-7	3	2	1	0
Condition	0	PRUN	0	CP	CV	CR	CP
PTR/NTR	0	PRUN	0	CP	CV	CR	CP
EVENT	0	PRUN	0	CP	CV	CR	CP
ENABLE	0	PRUN	0	CP	CV	CR	CP
Bit weight		256	16	8	4	2	1

**Event Bits**

CP: The unit has switched to CP mode.  
 CR: The unit has switched to CR mode.  
 CV: The unit has switched to CV mode.  
 CP: The unit has switched to CP mode.  
 PRUN: A program is running.

**Condition Register**

The condition register indicates the status of the electronic load. The condition register can only be changed by a change in the condition of the electronic load. Reading the condition register does not change the state of the condition register.

**PTR/NTR Filters**

The PTR/NTR (Positive/Negative transition) register determines the type of transition conditions that will trigger an event. Only the CSummary Status Register, Questionable Status Register and Operation Status Register can be transition programmed.

**Event Register**

The Event Register indicates if an event has been triggered according to the transition settings from the PTR/NTR Register.

**Enable Register**      The Enable register determines which status event(s) are enabled. Any status events (CC, CV, CR, CP, PRUN) that are enabled will set the corresponding bit in the CSummary Event Register.

## Questionable Status Registers

---

**Overview**      The Questionable Status Registers will show if any faults or errors have occurred.

Questionable Status Register										
Bit Position	12-15	11	10	9	5-8	4	3	2	1	0
Condition	0	REV	EXT	UV	0	OT	OP	0	OC	OV
PTR/NTR	0	REV	EXT	UV	0	OT	OP	0	OC	OV
EVENT	0	REV	EXT	UV	0	OT	OP	0	OC	OV
ENABLE	0	REV	EXT	UV	0	OT	OP	0	OC	OV
Bit weight	2048		1024	512	16		8	4	2	1

**Events Bits**

- OV: Over voltage condition occurred.
- OC: Over current condition occurred.
- OP: Over power condition occurred.
- OT: Over temperature condition occurred.
- UV: Under voltage condition occurred.
- EXT: External problem occurred. (Same a Para alarm event: UnReg, R.OCP, OHP condition occurred.)
- REV: A reverse voltage condition has occurred.

**Condition Register**      The condition register indicates the status of the protection systems. The condition register can only be changed by a change in the condition of the protection systems. Reading the condition register does not change the state of the condition register.

- PTR/NTR Filters      The PTR/NTR (Positive/Negative transition) register determines the type of transition conditions that will trigger an event. Only the CSummary Status Register, Questionable Status Register and Operation Status Register can be transition programmed.
- Event Register      The Event Register indicates if an event has been triggered according to the transition settings from the PTR/NTR Register.
- Enable Register      The Enable register determines which status event(s) are enabled. Any status events (OV, OC, OP, OT, UV, EXT or REV) that are enabled will set the corresponding bit in the Questionable Event Register.

## Operation Status Registers

---

Overview      The Operation Status Registers will show the operating state of electronic load (waiting for a trigger or in calibration mode).

Operation Status Registers			
Bit Position	5	1-4	0
Condition	WTG	0	CAL
PTR/NTR	WTG	0	CAL
EVENT	WTG	0	CAL
ENABLE	WTG	0	CAL
Bit weight	32		1

Events Bits      CAL: Indicates that the unit is currently in calibration mode.  
 WTG: Indicates that the unit is waiting for a trigger.

- Condition Register                      The condition register indicates the operating state of the unit. The condition register can only be changed by a change in the condition of operating state. Reading the condition register does not change the state of the condition register.
  
- PTR/NTR Filters                         The PTR/NTR (Positive/Negative transition) register determines the type of transition conditions that will trigger an event. Only the CSummary Status Register, Questionable Status Register and Operation Status Register can be transition programmed.
  
- Event Register                            The Event Register indicates if an event has been triggered according to the transition settings from the PTR/NTR Register.
  
- Enable Register                          The Enable register determines which status event(s) are enabled. Any status events (CAL or WTG) that are enabled will set the corresponding bit in the Operation Event Register.

## Standard Event Status Registers

---

Overview                                  The Standard Event Status Registers indicate any programming errors that occur. The Standard Event Status Register group comprises of the Event and Enable registers.

Standard Event Status Registers								
Bit Position	7	6	5	4	3	2	1	0
EVENT	PON	URQ	CME	EXE	DDE	QUE	RQC	OPC
ENABLE	PON	URQ	CME	EXE	DDE	QUE	RQC	OPC
Bit weight	128	64	32	16	8	4	2	1

---

Events Bits	<p>OPC: The operation complete bit is set when all selected pending operations are complete. This bit is set in response to the *OPC command.</p> <p>RQC: Not used.</p> <p>QUE: The query error bit is set when there is an error reading the output queue. This can be caused by trying to read the output queue when there is no data in it.</p> <p>DDE: The Device Dependent Error indicates a memory error/lost memory or failure of the self-test.</p> <p>EXE: The Execution bit indicates an execution error due to one of the following:</p> <ul style="list-style-type: none"><li>-Illegal command parameter</li><li>-Parameter out of range</li><li>-Invalid parameter</li><li>-Command didn't execute due to an overriding operation condition.</li></ul> <p>CME: The Command Error bit can be set when a syntax error has occurred, an unidentifiable header is received or when a &lt;GET&gt; command is received within a program message. (Group Execute Trigger) as defined in IEEE 488.1.</p> <p>URQ: Not used.</p> <p>PON: Not used.</p>
Event Register	The Event Register will be set to 0 when read.
Enable Register	The Enable Register determines which events will set the ESB Bit (bit 5) in the Status Byte Register.

## Status Byte Register

### Overview

The Status Byte register consolidates the status events of all the status registers. The Status Byte register can be read with the \*STB? query or a serial poll and can be cleared with the \*CLS command.

Status Byte Register								
Bit Position	7	6	5	4	3	2	1	0
Condition	OPER	MSS	ESB	MAV	QUES	CSUM	ERR	0
Bit weight	128	64	32	16	8	4	2	1

### Status Bits

**ERR:** The ERR bit is set when there is a message in the error queue.

**CSUM:** The CSUM bit is set when an event has occurred in the CSummary Status Register group.

**QUES:** The QUES bit is set when an event has occurred in the Questionable Status Register group.

**MAV:** The MAV bit is set when there is outstanding data in the Output Queue.

**ESB:** The Event Status bit is set if an enabled event in the Standard Event Status Register group has occurred.

**MSS & RQS:** The Master Summary Status is used with the \*STB? query. When the \*STB? query is read, the MSS bit is not cleared. The Request Service bit is cleared when it is polled during a serial poll.

**OPER:** The OPER bit is set when if an enabled event in the Operation Status Register has occurred.



## Service Request Register

---

### Overview

The Service Request Generation Register determines which events in the Status Byte Register will generate Service Requests. It is essentially the Status Byte Enable Register. The bit events are the same as the Status Byte Register, minus the MSS/RQS bit.

Service Request Generation Register (Status Byte Enable)								
Bit Position	7	6	5	4	3	2	1	0
Condition	OPER	0	ESB	MAV	QUES	CSUM	ERR	0
Bit weight	128	64	32	16	8	4	2	1

## Error Messages

The following error messages may be encountered when reading the error queue.

Error Code and string	Description
Command Errors	
0 NoError	No error
-100 Command Error	This is the generic syntax error for devices that cannot detect more specific errors.
-101 Invalid character	A syntactic element contains a character which is invalid for that type.
-102 Syntax error	An unrecognized command or data type was encountered.
-103 Invalid separator	The parser was expecting a separator and encountered an illegal character.
-104 Data type error	The parser recognized a data element different than the one allowed.
-105 GET not allowed	A Group Execute Trigger was received within a program message.
-108 Parameter not allowed	More parameters were received than expected for the header.
-109 Missing parameter	Fewer parameters were received than required for the header.
-110 Command header error	An error was detected in the header.

---

-111 Header separator error	A character which is not a legal header separator was encountered while parsing the header.
-112 Program mnemonic too long	The header contains more than twelve characters.
-113 Undefined header	The header is syntactically correct, but it is undefined for this specific device.
-114 Header suffix out of range	The value of a numeric suffix attached to a program mnemonic.
-115 Unexpected number of parameters	The number of parameters received does not correspond to the number of parameters expected.
-120 Numeric data error	This error is generated when parsing a data element which appears to be numeric, including the nondecimal numeric types.
-121 Invalid character in number	An invalid character for the data type being parsed was encountered.
-123 Exponent too large	The magnitude of the exponent was larger than 32000.
-124 Too many digits	The mantissa of a decimal numeric data element contained more than 255 digits excluding leading zeros.
-128 Numeric data not allowed	A legal numeric data element was received, but the device does not accept one in this position for the header
-130 Suffix error	This error, as well as errors -131 through -139, are generated when parsing a suffix.

-131 Invalid suffix	The suffix does not follow the syntax described in IEEE 488.2 or the suffix is inappropriate for this device.
-134 Suffix too long	The suffix contained more than 12 characters.
-138 Suffix not allowed	A suffix was encountered after a numeric element which does not allow suffixes.
-140 Character data error	This error is generated when parsing a character data element.
-141 Invalid character data	Either the character data element contains an invalid character or the particular element received is not valid for the header.
-144 Character data too long	The character data element contains more than twelve characters
-148 Character data not allowed	A legal character data element was encountered where prohibited by the device.
-150 String data error	This error is generated when parsing a string data element.
-151 Invalid string data	A string data element was expected, but was invalid for some reason.
-158 String data not allowed	A string data element was encountered but was not allowed by the device at this point in parsing.
-160 Block data error	This error is generated when parsing a block data element.
-161 Invalid block data	A block data element was expected, but was invalid for some reason.

-168 Block data not allowed	A legal block data element was encountered but was not allowed by the device at this point in parsing.
-170 Expression error	This error is generated when parsing an expression data element.
-171 Invalid expression	The expression data element was invalid.
-178 Expression data not allowed	A legal expression data was encountered but was not allowed by the device at this point in parsing.
-180 Macro error	This error is generated when defining a macro or executing a macro.
-181 Invalid outside macro definition	Indicates that a macro parameter placeholder (\$<number>) was encountered outside of a macro definition.
-183 Invalid inside macro definition	Indicates that the program message unit sequence, sent with a *DDT or *DMC command, is syntactically invalid.
-184 Macro parameter error	Indicates that a command inside the macro definition had the wrong number or type of parameters.

## Execution Errors

-200 Execution error	This is the generic syntax error for devices that cannot detect more specific errors. This code indicates only that an Execution Error as defined in IEEE 488.2 has occurred.
-201 Invalid while in local	Indicates that a command is not executable while the device is in local due to a hard local control
-202 Settings lost due to rtl	Indicates that a setting associated with a hard local control was lost when the device changed to LOCS from REMS or to LWLS from RWLS.
-203 Command protected	Indicates that a legal password-protected program command or query could not be executed because the command was disabled.
-210 Trigger error	
-211 Trigger ignored	Indicates that a GET, *TRG, or triggering signal was received and recognized by the device but was ignored because of device timing considerations.
-212 Arm ignored	Indicates that an arming signal was received and recognized by the device but was ignored.
-213 Init ignored	Indicates that a request for a measurement initiation was ignored as another measurement was already in progress.

-214 Trigger deadlock	Indicates that the trigger source for the initiation of a measurement is set to GET and subsequent measurement query is received. The measurement cannot be started until a GET is received, but the GET would cause an INTERRUPTED error.
-215 Arm deadlock	Indicates that the arm source for the initiation of a measurement is set to GET and subsequent measurement query is received. The measurement cannot be started until a GET is received, but the GET would cause an INTERRUPTED error.
-220 Parameter error	Indicates that a program data element related error occurred.
-221 Settings conflict	Indicates that a legal program data element was parsed but could not be executed due to the current device state.
-222 Data out of range	Indicates that a legal program data element was parsed but could not be executed because the interpreted value was outside the legal range as defined by the device.
-223 Too much data	Indicates that a legal program data element of block, expression, or string type was received that contained more data than the device could handle due to memory or related device-specific requirements.

-224 Illegal parameter value	Used where an exact value, from a list of possibilities, was expected.
-225 Out of memory.	The device has insufficient memory to perform the requested operation.
-226 Lists not same length.	Attempted to use LIST structure having individual LIST's of unequal lengths.
-230 Data corrupt or stale	Possibly invalid data; new reading started but not completed since last access.
-231 Data questionable	Indicates that measurement accuracy is suspect.
-232 Invalid format	Indicates that a legal program data element was parsed but could not be executed because the data format or structure is inappropriate.
-233 Invalid version	Indicates that a legal program data element was parsed but could not be executed because the version of the data is incorrect to the device.
-240 Hardware error	Indicates that a legal program command or query could not be executed because of a hardware problem in the device.
-241 Hardware missing	Indicates that a legal program command or query could not be executed because of missing device hardware.
-250 Mass storage error	Indicates that a mass storage error occurred.



-251 Missing mass storage	Indicates that a legal program command or query could not be executed because of missing mass storage.
-252 Missing media	Indicates that a legal program command or query could not be executed because of a missing media.
-253 Corrupt media	Indicates that a legal program command or query could not be executed because of corrupt media.
-254 Media full	Indicates that a legal program command or query could not be executed because the media was full.
-255 Directory full	Indicates that a legal program command or query could not be executed because the media directory was full.
-256 File name not found	Indicates that a legal program command or query could not be executed because the file name on the device media was not found.
-257 File name error	Indicates that a legal program command or query could not be executed because the file name on the device media was in error.
-258 Media protected	Indicates that a legal program command or query could not be executed because the media was protected.
-260 Expression error	Indicates that a expression program data element related error occurred.

-261 Math error in expression	Indicates that a syntactically legal expression program data element could not be executed due to a math error.
-270 Macro error	Indicates that a macro-related execution error occurred.
-271 Macro syntax error	Indicates that that a syntactically legal macro program data sequence, according to IEEE 488.2 could not be executed due to a syntax error within the macro definition.
-272 Macro execution error	Indicates that a syntactically legal macro program data sequence could not be executed due to some error in the macro definition.
-273 Illegal macro label	Indicates that the macro label defined in the *DMC command was a legal string syntax, but could not be accepted by the device.
-274 Macro parameter error	Indicates that the macro definition improperly used a macro parameter placeholder.
-275 Macro definition too long	Indicates that a syntactically legal macro program data sequence could not be executed because the string or block contents were too long for the device to handle.
-276 Macro recursion error	Indicates that a syntactically legal macro program data sequence could not be executed because the device found it to be recursive.

- 
- |                                     |   |
|-------------------------------------|---|
| -277 Macro redefinition not allowed | Indicates that a syntactically legal macro label in the *DMC command could not be executed because the macro label was already defined.             |
| -278 Macro header not found         | Indicates that a syntactically legal macro label in the *GMC? query could not be executed because the header was not previously defined.            |
| -280 Program error                  | Indicates that a downloaded program-related execution error occurred.   |
| -281 Cannot create program          | Indicates that an attempt to create a program was unsuccessful. A reason for the failure might include not enough memory.                           |
| -282 Illegal program name           | The name used to reference a program was invalid.   |
| -283 Illegal variable name          | An attempt was made to reference a nonexistent variable in a program.   |
| -284 Program currently running      | Certain operations dealing with programs may be illegal while the program is running.   |
| -285 Program syntax error           | Indicates that a syntax error appears in a downloaded program.  |
| -286 Program runtime error          |   |
| -290 Memory use error               | Indicates that a user request has directly or indirectly caused an error related to memory or <data_handle>s, this is not the same as "bad" memory. |
| -291 Out of memory                  |   |

- 292 Referenced name does not exist
- 293 Referenced name already exists
- 294 Incompatible type                      Indicates that the type or structure of a memory item is inadequate.

#### Device Specific Errors

- 300 Device-specific error                      This is the generic device-dependent error for devices that cannot detect more specific errors.
- 310 System error                              Indicates that some error, termed "system error" by the device, has occurred.
- 311 Memory error                              Indicates some physical fault in the device's memory, such as parity error.
- 312 PUD memory lost                          Indicates that the protected user data saved by the \*PUD command has been lost.
- 313 Calibration memory lost                      Indicates that nonvolatile calibration data used by the \*CAL? command has been lost.
- 314 Save/recall memory lost                      Indicates that the nonvolatile data saved by the \*SAV? command has been lost.
- 315 Configuration memory lost                      Indicates that nonvolatile configuration data saved by the device has been lost.

-320 Storage fault	[Indicates that the firmware detected a fault when using data storage. This error is not an indication of physical damage or failure of any mass storage element.
-321 Out of memory	An internal operation needed more memory than was available.
-330 Self-test failed	
-340 Calibration failed	
-350 Queue overflow	A specific code entered into the queue in lieu of the code that caused the error. This code indicates that there is no room in the queue and an error occurred but was not recorded.
-360 Communication error	This is the generic communication error.
-361 Parity error in program message	Parity bit not correct when data received.
-362 Framing error in program message	A stop bit was not detected when data was received.
-363 Input buffer overrun	Software or hardware input buffer on serial port overflows with data caused by improper or nonexistent pacing.
-365 Time out error	This is a generic device-dependent error.

#### Query Errors

-400 Query error	This is the generic query error.
-410 Query INTERRUPTED	Indicates that a condition causing an INTERRUPTED Query error occurred.

-420 Query UNTERMINATED	Indicates that a condition causing an UNTERMINATED Query error occurred.
-430 Query DEADLOCKED	Indicates that a condition causing an DEADLOCKED Query error occurred.
-440 Query UNTERMINATED after indefinite response	Indicates that a query was received in the same program message after a query requesting an indefinite response was executed

#### Power On Event Commands

-500 Power on	The instrument has detected an off to on transition in its power supply.
---------------	--

#### User Request Event

-600 User request	The instrument has detected the activation of a user request local control.
-------------------	---

#### Request Control Event

-700 Request control	The instrument requested to become the active IEEE 488.1 controller-in-charge.
----------------------	--

#### Operation Complete Event

-800 Operation complete	The instrument has completed all selected pending operations in accordance with the IEEE 488.2 synchronization protocol.
-------------------------	--