

Digital Storage Oscilloscope

GDS-1000-U Series

USER MANUAL

GW INSTEK PART NO. 82DS1112AU1



ISO-9001 CERTIFIED MANUFACTURER

GW INSTEK

This manual contains proprietary information, which is protected by copyright. All rights are reserved. No part of this manual may be photocopied, reproduced or translated to another language without prior written consent of Good Will Corporation.

The information in this manual was correct at the time of printing. However, Good Will continues to improve its products and therefore reserves the right to change the specifications, equipment, and maintenance procedures at any time without notice.

Table of Contents

SAFETY INSTRUCTIONS.....	7
Safety Symbols	7
Safety Guidelines.....	8
Power cord for the United Kingdom.....	11
GETTING STARTED	12
Main Features	12
Panel Overview.....	14
Front Panel	14
Rear Panel.....	18
Display.....	19
Setting up the Oscilloscope.....	20
QUICK REFERENCE	23
Menu Tree and Shortcuts.....	23
CH1/CH2 key	24
Cursor key 1/2	25
Cursor key 2/2	25
Display key.....	26
Autoset key	26
Hardcopy key.....	26
Help key.....	26
Horizontal menu key.....	27
Math key 1/2 (+/-)	27
Math key 2/2 (FFT)	28
Measure key.....	29
Run/Stop key.....	29
Save/Recall key 1/9	30
Save/Recall key 2/9	30
Save/Recall key 3/9	31
Save/Recall key 4/9	31
Save/Recall key 5/9	32
Save/Recall key 6/9	32
Save/Recall key 7/9	33
Save/Recall key 8/9	34
Save/Recall key 9/9	34
Trigger key 1/5.....	35
Trigger key 2/5.....	35

Trigger key 3/5	36
Trigger key 4/5	36
Trigger key 5/5	37
Utility key 1/10 (Utility #1)	37
Utility 2/10 (Utility #2)	38
Utility key 3/10 (Utility #3)	39
Utility key 4/10 (Hardcopy -Save All).....	39
Utility key 5/10 (Hardcopy -Save Image).....	39
Utility key 6/10 (Probe compensation)	40
Utility key 7/10 (Go-NoGo)	40
Utility key 8/10 (Data Logging 1/2)	41
Utility key 9/10 (Data Logging 2/2)	41
Utility key 10/10 (Self CAL Menu)	41
Default Settings	42
Built-in Help	43

MEASUREMENT **44**

Basic Measurements	44
Activating a channel.....	44
Using Autoset	45
Running and stopping the trigger	46
Changing the horizontal position and scale.....	47
Changing the vertical position and scale	48
Using the probe compensation signal	49
Automatic Measurements.....	51
Measurement items.....	51
Automatically measuring the input signals.....	53
Cursor Measurements	54
Using the horizontal cursors	54
Using the vertical cursors	55
Math Operations	57
Overview.....	57
Adding, subtracting or multiplying signals	58
Using the FFT function	58
Go No-Go Testing.....	60
Overview.....	60
Edit: NoGo When.....	61
Edit: Source	61
Edit: NoGo Violation Conditions.....	62
Edit: Template (boundary).....	62
Run Go-NoGo Tests	66
Data Logging	67
Overview.....	67

Edit: Source	68
Edit: Setup Parameters.....	68
Run Data logging.....	70
CONFIGURATION	71
Acquisition	71
Selecting the acquisition mode.....	71
Real time vs Equivalent time sampling mode	74
Display	75
Selecting vector or dot drawing	75
Accumulating the waveform	75
Adjusting the display contrast	76
Selecting the display grid	76
Horizontal View.....	77
Moving the waveform position horizontally.....	77
Selecting the horizontal scale	77
Selecting the waveform update mode	78
Zooming the waveform horizontally.....	79
Viewing waveforms in the X-Y mode	80
Vertical View (Channel)	81
Moving the waveform position vertically.....	81
Selecting the vertical scale	81
Selecting the coupling mode	81
Inverting the waveform vertically.....	82
Limiting the waveform bandwidth	82
Trigger.....	84
Trigger type.....	84
Trigger parameter.....	84
Configuring the edge trigger.....	86
Configuring the video trigger	88
Configuring the pulse width trigger	89
Manually triggering the signal	90
Rear Panel USB Port Interface	92
System Settings	93
Viewing the system information	93
Selecting the language	93
SAVE/RECALL	95
File Structures	95
Display image file format.....	95
Waveform file format	95
Setup file format.....	97

Using the USB file utilities.....	98
Quick Save (HardCopy)	100
Save	102
File type/source/destination.....	102
Saving the panel settings.....	103
Saving the waveform.....	104
Saving the display image	105
Saving all (panel settings, display image, waveform)	107
Recall	109
File type/source/destination.....	109
Recalling the default panel settings.....	110
Recalling a reference waveform to the display	111
Recalling panel settings	111
Recalling a waveform	112

MAINTENANCE..... 115

Vertical Resolution Calibration	115
Probe Compensation	116

FAQ..... 118

The input signal does not appear in the display.	118
I want to remove some contents from the display.	118
The waveform does not update (frozen).....	119
The probe waveform is distorted.....	119
Autoset does not catch the signal well.....	119
I want to clean up the cluttered panel settings.	119
The saved display image is too dark on the background..	119
The accuracy does not match the specifications.	120

APPENDIX..... 121

Fuse Replacement	121
GDS-1000-U Series Specifications	122
Model-specific specifications	122
Common specifications.....	123
Probe Specifications	125
GDS-1052-U & GDS-1072-U Probe	125
GDS-1102-U Probe.....	126
Dimensions.....	127
Declaration of Conformity	128

INDEX..... 129

S SAFETY INSTRUCTIONS

This chapter contains important safety instructions that should be followed when operating and storing the oscilloscope. Read the following before any operation to ensure your safety and to keep the oscilloscope in the best condition.

Safety Symbols

These safety symbols may appear in this manual or on the oscilloscope.



WARNING

Warning: Identifies conditions or practices that could result in injury or loss of life.



CAUTION

Caution: Identifies conditions or practices that could result in damage to the oscilloscope or to other objects or property.



DANGER High Voltage



Attention: Refer to the Manual



Protective Conductor Terminal



Earth (Ground) Terminal



Do not dispose electronic equipment as unsorted municipal waste. Please use a separate collection facility or contact the supplier from which this instrument was purchased.

Safety Guidelines

General Guideline





CAUTION

- Make sure the BNC input voltage does not exceed 300V peak.
- Never connect a hazardous live voltage to the ground side of the BNC connectors. It might lead to fire and electric shock.
- Do not place heavy objects on the oscilloscope.
- Avoid severe impact or rough handling that may damage the oscilloscope.
- Avoid discharges of static electricity on or near the oscilloscope.
- Use only mating connectors, not bare wires, for the terminals.
- Do not block the cooling fan vent.
- Do not perform measurements at power sources and building installation sites (Note below).
- The oscilloscope should only be disassembled by a qualified technician.

(Measurement categories) EN 61010-1:2001 specifies the measurement categories and their requirements as follows. The GDS-1000-U falls under category II.

- Measurement category IV is for measurement performed at the source of a low-voltage installation.
- Measurement category III is for measurement performed in a building installation.
- Measurement category II is for measurement performed on circuits directly connected to a low voltage installation.
- Measurement category I is for measurements performed on circuits not directly connected to Mains.

Power Supply	<ul style="list-style-type: none">• AC Input voltage: 100 ~ 240V AC, 47 ~ 63Hz• The power supply voltage should not fluctuate more than 10%.• Connect the protective grounding conductor of the AC power cord to an earth ground.
 WARNING	<ul style="list-style-type: none">• AC Input voltage: 100 ~ 240V AC, 47 ~ 63Hz• The power supply voltage should not fluctuate more than 10%.• Connect the protective grounding conductor of the AC power cord to an earth ground.
Fuse	<ul style="list-style-type: none">• Fuse type: T1A/250V• To ensure fire protection, replace the fuse only with the specified type and rating.• Disconnect the power cord before replacing the fuse.• Make sure the cause of fuse blowout is fixed before replacing the fuse.
 WARNING	<ul style="list-style-type: none">• Fuse type: T1A/250V• To ensure fire protection, replace the fuse only with the specified type and rating.• Disconnect the power cord before replacing the fuse.• Make sure the cause of fuse blowout is fixed before replacing the fuse.
Cleaning the oscilloscope	<ul style="list-style-type: none">• Disconnect the power cord before cleaning the oscilloscope.• Use a soft cloth dampened in a solution of mild detergent and water. Do not spray any liquid into the oscilloscope.• Do not use chemicals containing harsh products such as benzene, toluene, xylene, and acetone.
Operation Environment	<ul style="list-style-type: none">• Location: Indoor, no direct sunlight, dust free, almost non-conductive pollution (Note below)• Relative Humidity: $\leq 80\%$, 40°C or below $\leq 45\%$, 41°C~50°C• Altitude: < 2000m• Temperature: 0°C to 50°C

(Pollution Degree) EN 61010-1:2001 specifies pollution degrees and their requirements as follows. The oscilloscope falls under degree 2.

Pollution refers to “addition of foreign matter, solid, liquid, or gaseous (ionized gases), that may produce a reduction of dielectric strength or surface resistivity”.

- Pollution degree 1: No pollution or only dry, non-conductive pollution occurs. The pollution has no influence.
- Pollution degree 2: Normally only non-conductive pollution occurs. Occasionally, however, a temporary conductivity caused by condensation must be expected.
- Pollution degree 3: Conductive pollution occurs, or dry, non-conductive pollution occurs which becomes conductive due to condensation which is expected. In such conditions, equipment is normally protected against exposure to direct sunlight, precipitation, and full wind pressure, but neither temperature nor humidity is controlled.

Storage environment

- Location: Indoor
- Storage Temperature: $-10^{\circ}\text{C}\sim 60^{\circ}\text{C}$, no condensation-
- Relative Humidity: 93% @ 40°C
65% @ $41^{\circ}\text{C}\sim 60^{\circ}\text{C}$

Disposal



Do not dispose this instrument as unsorted municipal waste. Please use a separate collection facility or contact the supplier from which this instrument was purchased. Please make sure discarded electrical waste is properly recycled to reduce environmental impact.

Power cord for the United Kingdom

When using the oscilloscope in the United Kingdom, make sure the power cord meets the following safety instructions.

NOTE: This lead/appliance must only be wired by competent persons

 **WARNING: THIS APPLIANCE MUST BE EARTHED**

IMPORTANT: The wires in this lead are coloured in accordance with the following code:

Green/ Yellow:	Earth
Blue:	Neutral
Brown:	Live (Phase)



As the colours of the wires in main leads may not correspond with the coloured marking identified in your plug/appliance, proceed as follows:

The wire which is coloured Green & Yellow must be connected to the Earth terminal marked with either the letter E, the earth symbol  or coloured Green/Green & Yellow.

The wire which is coloured Blue must be connected to the terminal which is marked with the letter N or coloured Blue or Black.

The wire which is coloured Brown must be connected to the terminal marked with the letter L or P or coloured Brown or Red.

If in doubt, consult the instructions provided with the equipment or contact the supplier.

This cable/appliance should be protected by a suitably rated and approved HBC mains fuse: refer to the rating information on the equipment and/or user instructions for details. As a guide, a cable of 0.75mm² should be protected by a 3A or 5A fuse. Larger conductors would normally require 13A types, depending on the connection method used.

Any exposed wiring from a cable, plug or connection that is engaged in a live socket is extremely hazardous. If a cable or plug is deemed hazardous, turn off the mains power and remove the cable, any fuses and fuse assemblies. All hazardous wiring must be immediately destroyed and replaced in accordance to the above standard.

G GETTING STARTED

The Getting started chapter introduces the oscilloscope's main features, appearance, and set up procedure.

Main Features

Model name	Frequency bandwidth	Input channels
GDS-1052-U	DC – 50MHz (–3dB)	2
GDS-1072-U	DC – 70MHz (–3dB)	2
GDS-1102-U	DC – 100MHz (–3dB)	2
Performance	<ul style="list-style-type: none"> • 250MSa /S real-time sampling rate • 25GS/s equivalent-time sampling rate • Up to 10ns peak detection • 2mV~10V vertical scale 	
Features	<ul style="list-style-type: none"> • 5.7 inch color TFT display • Saving and recalling setups and waveforms • 19 automatic measurements • Multi-language menu (12 languages) • Math operation: Addition, Subtraction, FFT • Data logging • Go-NoGo testing • Edge, video, pulse width trigger • Compact size: (W) 310 x (D) 140 x (H) 142 mm 	

- Interface
- USB 2.0 full-speed interface for saving and recalling data
 - Calibration output
 - External trigger input
 - USB B type (slave) interface for remote control

Panel Overview

Front Panel

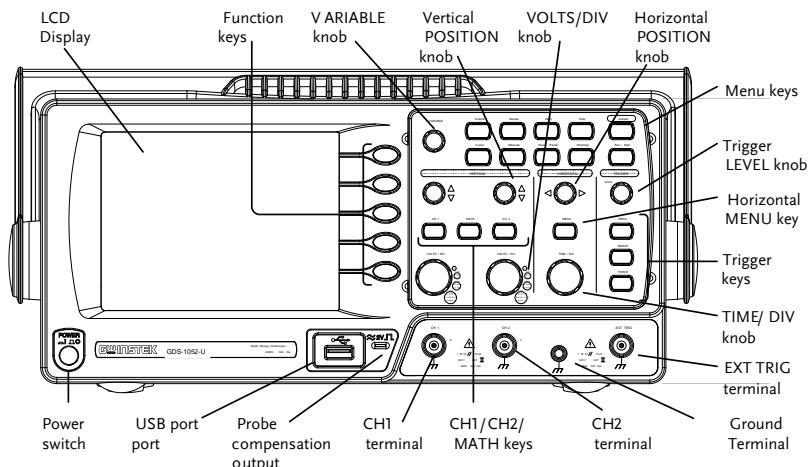



LCD display TFT color, 320 x 234 resolution, wide angle view LCD display.

Function keys:  Activates the functions which appear in the left side of the LCD display.
 F1 (top) to
 F5 (bottom)











Variable knob  **VARIABLE**
 Increases or decreases values and moves to the next or previous parameter.













Acquire key  **Acquire**
 Configures the acquisition mode (page 71).

Display key  **Display**
 Configures the display settings (page 75).

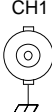
Cursor key  **Cursor**
 Runs cursor measurements (page 54).

(Continued on next page)

Utility key		Configures the Hardcopy function (page 100), shows the system status (page 93), selects the menu language (page 93), runs the self calibration (page 115), configures the probe compensation signal (page 116), and selects the USB host type (page 92).
Help key		Shows the Help contents on the display (page 43).
Autoset key		Automatically configures the horizontal, vertical, and trigger settings according to the input signal (page 45).
Measure key		Configures and runs automatic measurements (page 51).
Save/Recall key		Saves and recalls images, waveforms, or panel settings (page 95).
Hardcopy key		Stores images, waveforms, or panel settings to USB (page 100).
Run/Stop key		Runs or stops triggering (page 46).
Trigger level knob		Sets the trigger level (page 84).
Trigger menu key		Configures the trigger settings (page 84).
Single trigger key		Selects the single triggering mode (page 90).
Trigger force key		Acquires the input signal once regardless of the trigger condition at the time (page 90).

Horizontal menu key		Configures the horizontal view (page 77).
Horizontal position knob		Moves the waveform horizontally (page 77).
TIME/DIV knob		Selects the horizontal scale (page 77).
Vertical position knob		Moves the waveform vertically (page 81).
CH1/CH2 key		Configures the vertical scale and coupling mode for each channel (page 81).
VOLTS/DIV knob		Selects the vertical scale (page 81).
Input terminal		Accepts input signals: $1M\Omega \pm 2\%$ input impedance, BNC terminal.
Ground terminal		Accepts the DUT ground lead to achieve a common ground.
MATH key		Performs math operations (page 57).
USB port		Facilitates transferring waveform data, display images, and panel settings (page 98).
Probe compensation output		Outputs a 2Vp-p, square signal for compensating the probe (page 116) or demonstration.
External trigger input		Accepts an external trigger signal (page 84).

Power switch



Powers the oscilloscope on or off.

Rear Panel

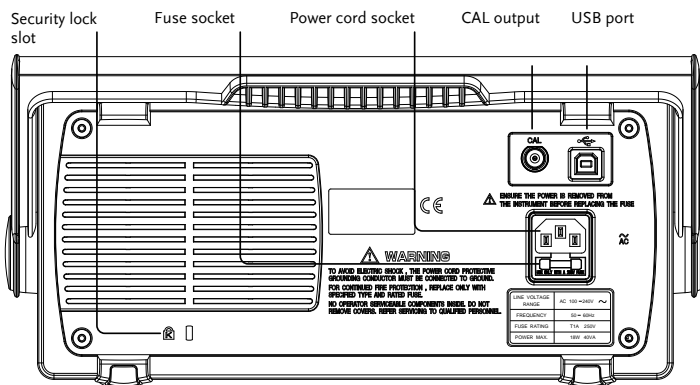

Power cord socket

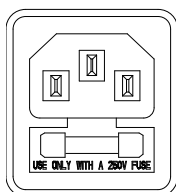

Power cord socket accepts the AC mains, 100 ~ 240V, 50/60Hz.

Fuse socket

The fuse socket holds the AC main fuse, T1A/250V.

For the fuse replacement procedure, see page 121.

USB slave port



Accepts a type B (slave) male USB connector for remote control of the oscilloscope (page 92).

Calibration output



Outputs the calibration signal used in vertical scale accuracy calibration (page 115).

Security lock slot



Standard laptop security lock slot for ensuring the security of the GDS-1000-U.

Display

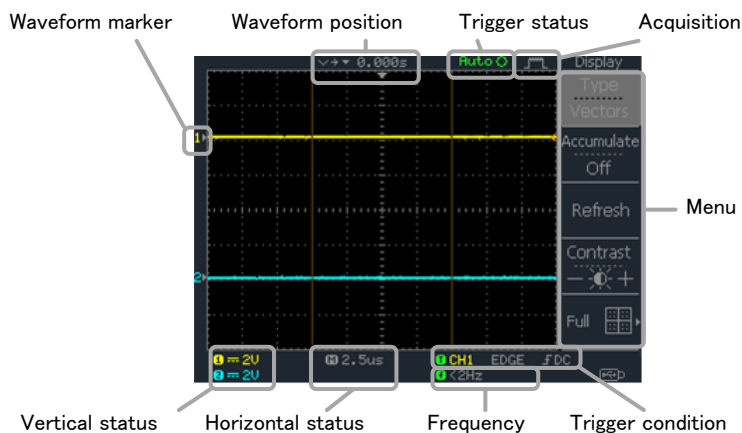

Waveforms	Channel 1: Yellow	Channel 2: Blue
Trigger status	Trig'd	A signal is being triggered
	Trig?	Waiting for a trigger condition
	Auto	Updating the input signal regardless of trigger conditions
	STOP	Triggering is stopped
	For trigger setting details, see page 83.	
Input signal frequency	Updates the input signal frequency (the trigger source signal) in real-time. “< 2Hz” Indicates that the signal frequency is less than the lower frequency limit (2Hz) and thus not accurate.	
Trigger configuration	Shows the trigger source, type, and slope. In case of the Video trigger, shows the trigger source and polarity.	
Horizontal status	Shows the channel configurations: coupling mode, vertical scale, and horizontal scale.	
Vertical status		

Setting up the Oscilloscope

Background This section describes how to set up the oscilloscope properly including adjusting the handle, connecting a signal, adjusting the scale, and compensating the probe. Before operating the oscilloscope in a new environment, run these steps to make sure the oscilloscope is functionally stable.

Procedure

1. Pull both bases of the handle out slightly.

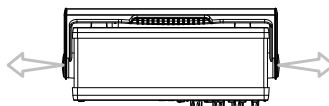

2. Turn to one of the three preset positions.

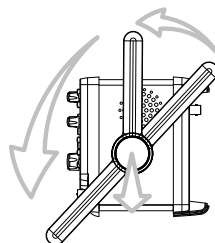

3. Connect the power cord.

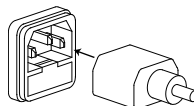

4. Press the power switch. The display will become active in approximately 10 seconds.



5. Reset the system by recalling the factory settings. Press the Save/Recall key, then Default Setup. For details regarding the factory settings, see page 42.

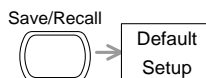

6. Connect the probe between the Channel1 input terminal and probe compensation signal output (2Vp-p, 1kHz square wave).
7. Set the probe attenuation voltage to x10.

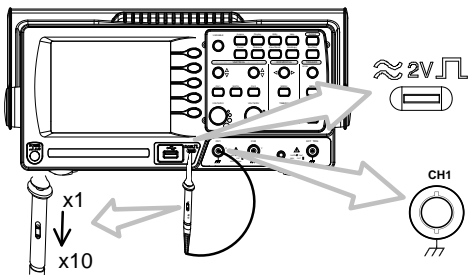

8. Press the Autoset key. A square waveform will appear in the center of the display. For details on Autoset, see page 45.



9. Press the Display key, then Type and select the vector waveform type.

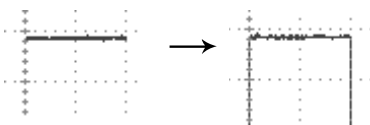
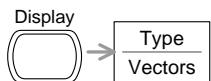

10. Turn the adjustment point on the probe to flatten the square waveform edge.

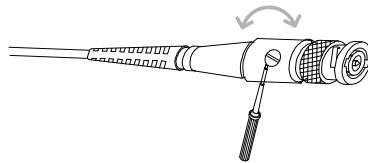
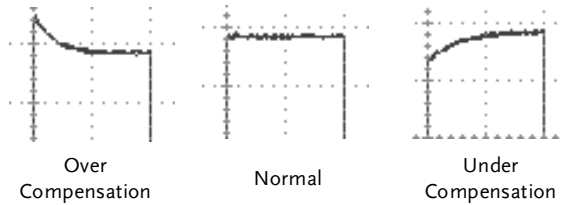



11. Setting up the oscilloscope is complete. You may continue with the other operations.

Measurement: page 44 Configuration: page 71

QUICK REFERENCE

This chapter lists the oscilloscope menu tree, operation shortcuts, built-in help coverage, and default factory settings. Use this chapter as a handy reference to access the oscilloscope functions.

Menu Tree and Shortcuts

Conventions	Examples
Normal	= Press the functional key for “Normal”
Average 	= Repeatedly press the functional key for “Average”
Normal ~ Average	= Select a menu from “Normal” to “Average” and press its functionality key
Normal → VAR 	= Press the functionality key for “Normal”, and then use the Variable knob

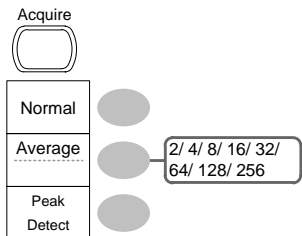

Select acquisition mode

Normal ~ Peak-Detect

Select average number

Average ↩

Turn Delay on/off



CH1/CH2 key

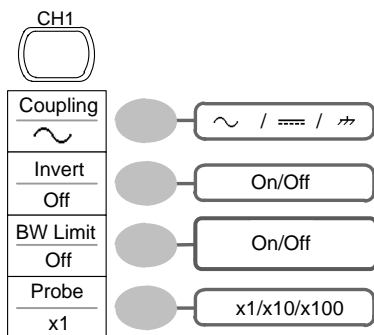

Turn channel on/off

CH 1/2 ↩

Select coupling mode

Coupling ↩

Invert waveform

Invert ↩

Turn bandwidth limit on/off

BW Limit ↩

Select probe attenuation

↔Probe

Cursor key 1/2

Cursor





Source
CH1
X1 123.4us 212.0mV
X2 22.9us 0.000V
X1X2 23.6us 11.9Hz 212.0mV
X↔Y

CH1/ 2/ MATH

Turn cursor on/off
Cursor 

Move X1 cursor
X1 → VAR 

Move X2 cursor
X2 → VAR 

Move both X1 and X2 cursor
X1X2 → VAR 

Switch to Y cursor
X ↔ Y

Cursor key 2/2

Cursor





Source
CH1
Y1 123.4mV
Y2 12.9mV
Y1Y2 10.5mV
X ↔ Y

CH1/ 2/ MATH

Turn cursor on/off
Cursor 







Move Y1 cursor
Y1 → VAR 

Move Y2 cursor
Y2 → VAR 

Move both Y1 and Y2 cursor
Y1Y2 → VAR 

Switch to X cursor
X ↔ Y

Display key

<p>Display</p> 	<p>Select waveform type</p> <p>Type ↩</p>								
<table border="1" style="border-collapse: collapse; width: 100px;"> <tr><td>Type</td></tr> <tr><td>Vectors</td></tr> <tr><td>Accumulate</td></tr> <tr><td>Off</td></tr> <tr><td>Refresh</td></tr> <tr><td>Contrast</td></tr> <tr><td style="text-align: center;">- ☉ +</td></tr> <tr><td>Full </td></tr> </table>	Type	Vectors	Accumulate	Off	Refresh	Contrast	- ☉ +	Full 	<p>Waveform accumulate On/Off</p> <p>Accumulate ↩</p> <p>Refresh accumulation</p> <p>Refresh</p> <p>Set display contrast</p> <p>Contrast → VAR </p> <p>Select display grid</p> <p> ↩</p>
Type									
Vectors									
Accumulate									
Off									
Refresh									
Contrast									
- ☉ +									
Full 									

Autoset key

<p>Autoset</p> 	<p>Automatically find the signal and set the scale</p> <p>Autoset</p>
--	---

Hardcopy key

<p>Hardcopy</p> 	<p>→ See Utility key (page 37)</p>
---	------------------------------------

Help key

<p>Help</p> 	<p>Turn help mode on/off</p> <p>Help ↩</p>
---	--

Horizontal menu key



Main	●
Window	●
Window Zoom	●
Roll	●
XY	●

Select main (default) display

Main

Select window mode

Window → TIME/DIV

Zoom in window mode

Window Zoom

Select window roll mode

Roll

Select XY mode

XY

Math key 1/2 (+/-)



Operation CH1+CH2	●	CH1+CH2 CH1-CH2 FFT
Position 0.00 Div	●	-12div ~ +12div
Unit/Div 2V	●	200mV ~ 10V/div

Math on/off

Math

Select math operation type (+/-
/FFT)

Operation

Set result position

Position → VAR

Math result Volt/Div

Unit/Div → VAR

Math key 2/2 (FFT)

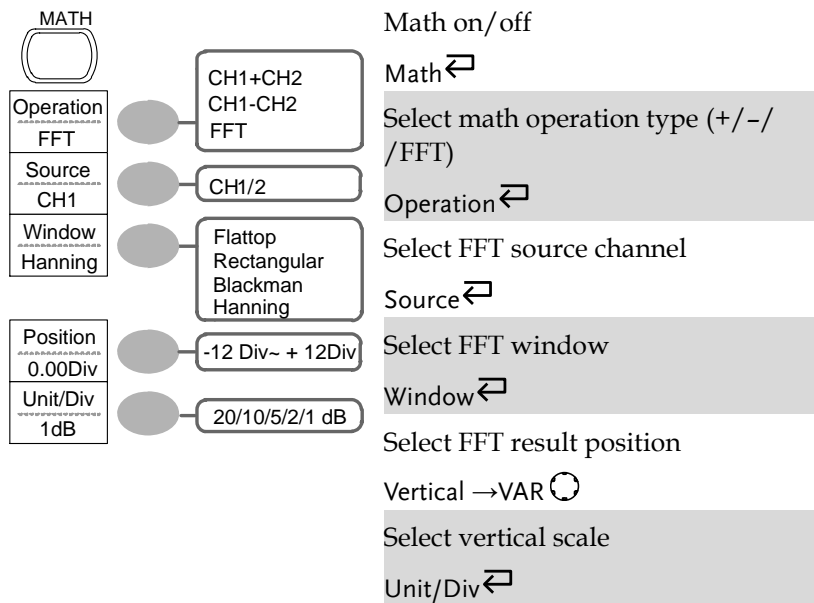

Measure key

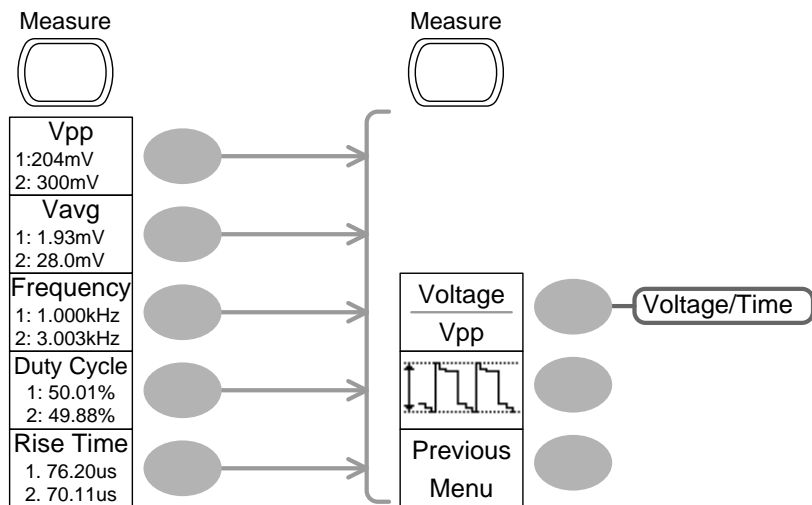

Turn on/off measurement	Measure
Select measurement type	Voltage/Time
Select measurement item	VAR or Icon(F3) / → VAR
Go back to previous menu	Previous Menu

Run/Stop key

Run/Stop	Freeze/unfreeze waveform or trigger Run/Stop
----------	---

Save/Recall key 1/9

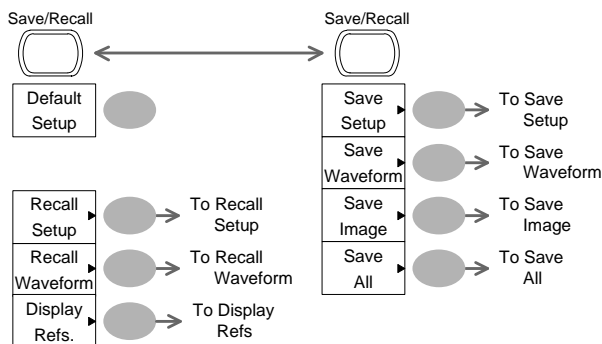

Switch to Save or Recall menu Save/Recall

Recall default setup Default Setup

Save/Recall key 2/9

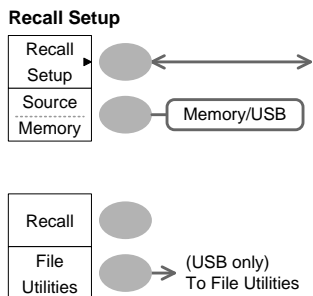

Select other menu

Recall Setup

Select setup source

Source → VAR

Recall setup

Recall

Go to USB file utilities

File Utilities

Save/Recall key 3/9

Recall Waveform

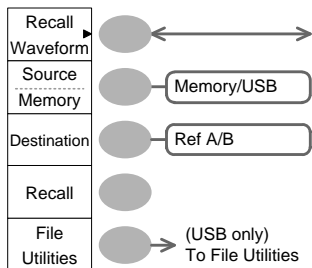

Select other menu
Recall Waveform ←

Select waveform source
Source ← → VAR

Select waveform destination
Destination → VAR

Recall waveform
Recall
Go to USB file utilities
File Utilities

Save/Recall key 4/9

Display Refs.

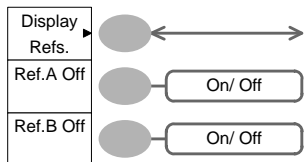

Select other menu
Display Refs. ←

Turn ref. waveform A on/off
Ref.A ←

Turn ref. waveform B on/off
Ref.B ←

Save/Recall key 5/9

Save Setup

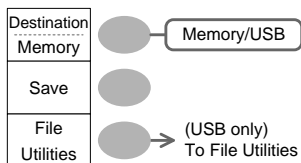
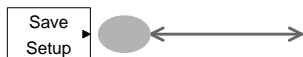

Select other menu

Save Setup

Select destination

Destination → VAR

Save setup

Save

Go to USB file utilities

File Utilities

Save/Recall key 6/9

Save Waveform

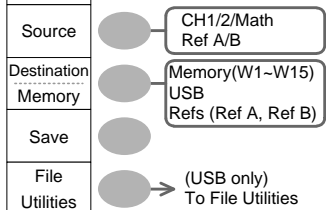
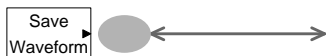

Select other menu

Save Waveform

Select source

Source → VAR

Select destination

Destination → VAR

Save waveform

Save

Go to USB file utilities

File Utilities

Save/Recall key 7/9

Save Image

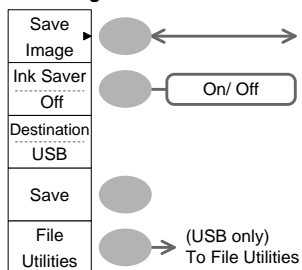

Select other menu

Save Image ↩

Turn on/off ink saver

Ink Saver ↩

Save image

Save

Go to USB file utilities

File Utilities

Save/Recall key 8/9

Save All

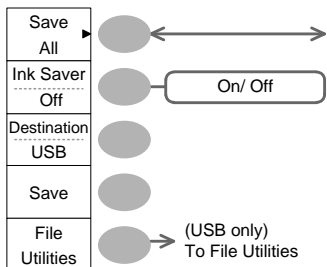

Select other menu

Save All ↩

Turn on/off ink saver

Ink Saver ↩

Select destination

Destination ↩ → VAR ○

Save all

Save

Go to USB file utilities

File Utilities

Save/Recall key 9/9

File Utilities

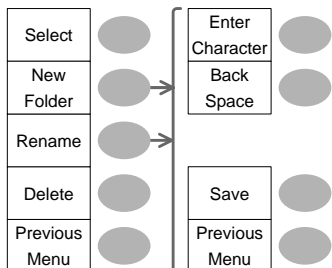

Select file/folder

VAR ○ → Select

Create or rename folder/file

New Folder/Rename

VAR ○ → Enter character / Backspace / Save / Previous menu

Delete folder/file

Delete

Go to previous menu

Previous menu

Trigger key 1/5

Trigger Type

MENU

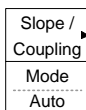
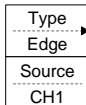

Select Trigger type

Type ↩

Trigger key 2/5

Video Trigger

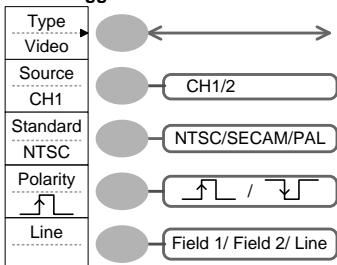

Select video trigger type

Type ↩

Select trigger source

Source ↩

Select video standard

Standard ↩

Select video polarity

Polarity ↩

Select video field/line

Line ↩ → VAR ○

Trigger key 3/5

Edge Trigger

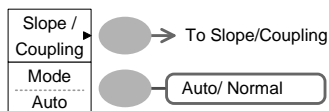
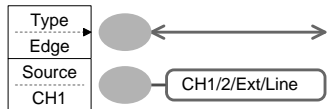

Select edge trigger type

Edge

Select trigger source

Source

Go to slope/coupling menu (page 37)

Slope/Coupling

Select trigger mode

Mode

Trigger key 4/5

Pulse Trigger

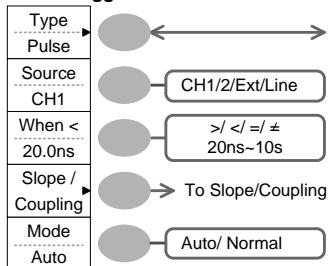

Select pulse trigger type

Type

Select trigger source

Source

Select pulse trigger condition and pulse width

When → VAR

Go to slope/coupling menu (page 37)

Slope/Coupling

Select trigger mode

Mode

Trigger key 5/5

Coupling/Slope

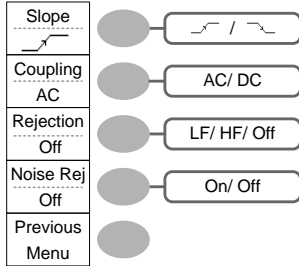

Select trigger slope type
Slope

Select trigger coupling mode
Coupling

Select frequency rejection
Rejection

Turn noise rejection on/off
Noise Rej

Go back to previous menu
Previous Menu

Utility key 1/10 (Utility #1)

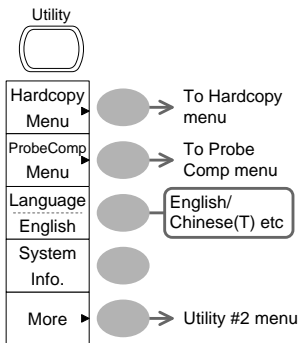

Go to hardcopy menu
Hardcopy

Go to probe compensation menu
ProbeComp

Select language
Language

Show system information
System Info.

Go to the next Utility menu
More

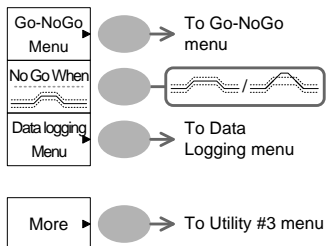

Utility 2/10 (Utility #2)

Utility



Go to the Go-NoGo menu

Go-NoGo

Set the NoGo conditions to inside
 / outside  limits

No Go When 

Go to the Data Logging Menu

Data Logging

Go to the next Utility menu

More

Utility key 3/10 (Utility #3)

Calibration



Enter self calibration
Self CAL



Go to the first Utility menu
More

Utility key 4/10 (Hardcopy -Save All)

Hardcopy

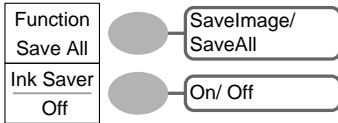

Select Hardcopy function

Function

Turn on/off Ink saver

Ink Saver

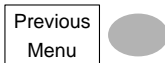

Go to previous menu

Previous Menu

Utility key 5/10 (Hardcopy -Save Image)

Hardcopy- Save Image

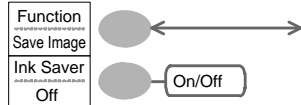

Select Hardcopy function

Function

Turn on/off Inksaver

Ink Saver

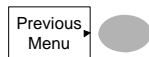

Go to previous menu

Previous Menu

Utility key 6/10 (Probe compensation)

Probe compensation

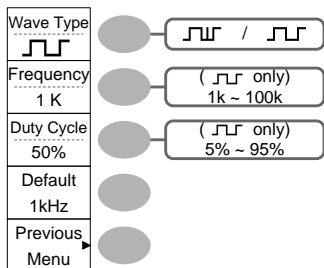

Select probe compensation signal

Wave Type

Set frequency for square wave

Frequency → VAR

Set duty cycle for square wave

Duty Cycle → VAR

Go to previous menu

Previous Menu

Utility key 7/10 (Go-NoGo)

Edit

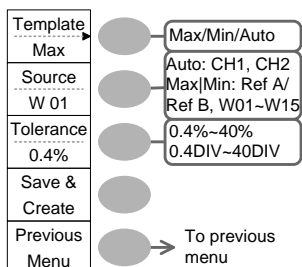

Switch between templates

Template

Select the template source

Source

Set the tolerance (% or Divisions)

Tolerance → VAR

Save the template

Save & Create

Go back to previous menu

Previous Menu

Utility key 8/10 (Data Logging 1/2)

Data logging

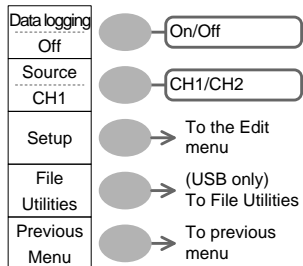

Turn Data Logging On/Off
Data logging ↩

Set the logging source
Source ↩

Go to the Data Logging Edit menu
Setup

Go to the File Utilities menu
File Utilities

Go back to previous menu
Previous Menu

Utility key 9/10 (Data Logging 2/2)

Edit

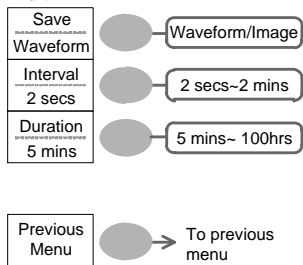

Save the logs as waveform data or as image files
Save ↩

Set the logging interval
Interval →VAR ⌚

Set the duration of the record log
Duration →VAR ⌚

Go back to previous menu
Previous Menu

Utility key 10/10 (Self CAL Menu)

Self Cal.

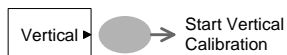

Start Vertical Calibration
Vertical

Default Settings

Here are the factory installed panel settings which appear when pressing the Save/Recall key → *Default Setup*.

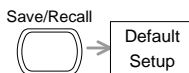

Acquisition	Mode: Normal	
Channel	Scale: 2V/Div	Invert: Off
	Coupling: DC	Probe attenuation voltage: x1
	BW limit: Off	Channel 1 & 2: On
Cursor	Source: CH1	Cursor: Off
Display	Type: Vectors	Accumulate: Off
	Grid: Full	
Horizontal	Scale: 2.5us/Div	Mode: Main Timebase
Math	Type: + (Add)	Position: 0.00 Div
Measure	Item: Vpp, Vavg, Frequency, Duty Cycle, Rise Time	
Trigger	Type: Edge	Source: Channel1
	Mode: Auto	Slope:
	Coupling: DC	Rejection: Off
	Noise Rejection: Off	
Utility	Hardcopy: SaveImage, InkSaver On	ProbeComp: Square wave, 1k, 50% duty cycle
Go-NoGo	Go-NoGo: Off	Source: CH1
	When:	Violating: Stop
Data Logging	Data logging: Off	Source: CH1
	Setup: Waveform	Interval: 2 secs
	Duration: 5 mins	

Built-in Help

The Help key shows the contents of the built-in help support. When you press a function key, its descriptions appear in the display.



Applicable keys

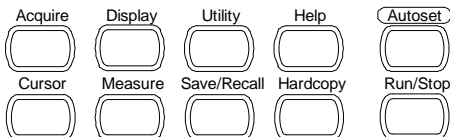

(Vertical)

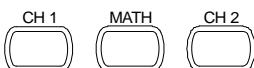

(Horizontal) (Trigger)

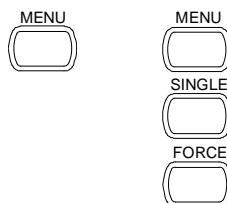

Procedure

1. Press the Help key. The display changes to the Help mode.



2. Press a functional key to access its help contents. (example: Acquire key)



3. Use the Variable knob to scroll the Help contents up and down.



4. Press the Help key again to exit the Help mode.



M EASUREMENT

The Measurement chapter describes how to properly observe a signal using the oscilloscope's basic functions, and how to observe a signal in a detailed manner using some of the advanced functions such as:

Automatic measurements, cursor measurements, and math operations.

Basic Measurements

This section describes the basic operations required in capturing and viewing an input signal. For more detailed operations, see the following chapters.

- Measurements → from page 44
- Configuration → from page 71

Activating a channel

Activating a channel

To activate an input channel, press the Channel key, CH1 or CH2. The channel indicator appears at the left side of the display and the channel icon changes accordingly.

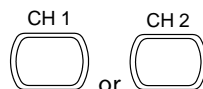

(Continued on next page)

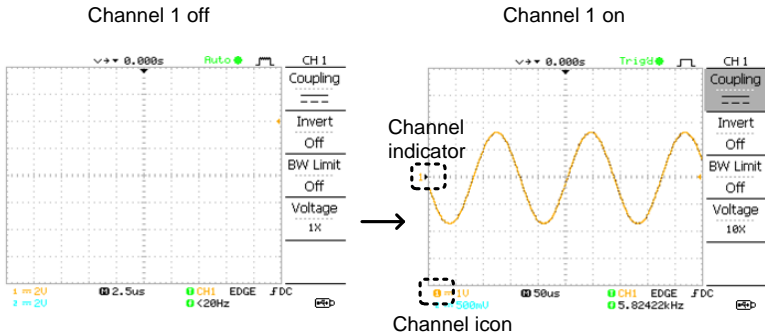

De-activating a channel

To de-activate the channel, press the Channel key twice (once if the channel menu is already selected).

Using Autoset

Background

The Autoset function automatically configures the panel settings to the best viewing conditions, in the following way.

- Selecting the horizontal scale
- Positioning the waveform horizontally
- Selecting the vertical scale
- Positioning the waveform vertically
- Selecting the trigger source channel
- Activating the channels

Procedure

1. Connect the input signal to the oscilloscope and press the Autoset key.
2. The waveform appears in the center of the display.



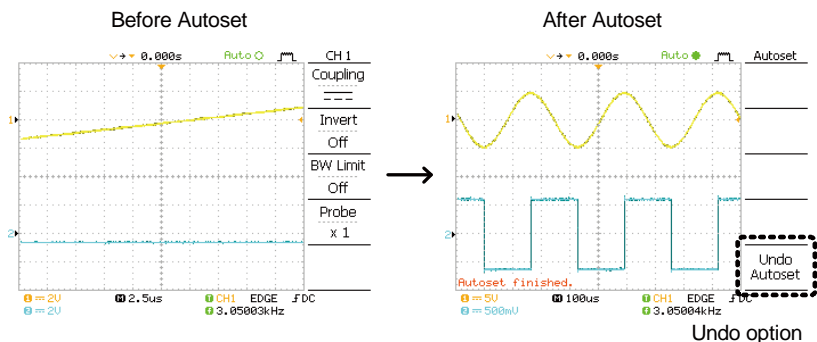

Undoing the Autoset

To undo the Autoset, press *Undo* (available for a few seconds).

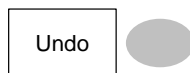

Adjusting the trigger level

If the waveform is still unstable, try adjusting the trigger level up or down by using the Trigger Level knob.



Limitation

Autoset does not work in the following situation.

- Input signal frequency less than 20Hz
- Input signal amplitude less than 30mV

Running and stopping the trigger

Background

In the trigger Run mode, the oscilloscope constantly searches for a trigger condition and updates the signal onto the display when the condition is met.

In the trigger Stop mode, the oscilloscope stops triggering and thus the last acquired waveforms stay in the display. The trigger icon at the top of the display changes into Stop mode.

Pressing the Trigger Run/Stop key switches between the Run and Stop mode.



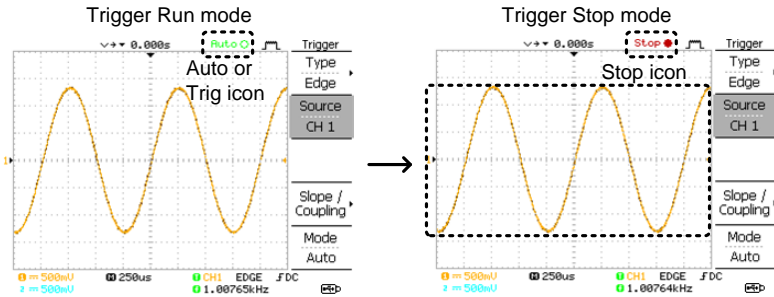

Waveform operation

Waveforms can be moved or scaled in both the Run and Stop mode. For details, see page 77 (Horizontal position/scale) and page 81 (Vertical position/scale).

Changing the horizontal position and scale

For more detailed configurations, see page 77.

Setting the horizontal position

The horizontal position knob moves the waveform left or right.

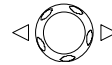

The position indicator moves along with the waveform and the distance from the center point is displayed as the offset in the upper side of the display.

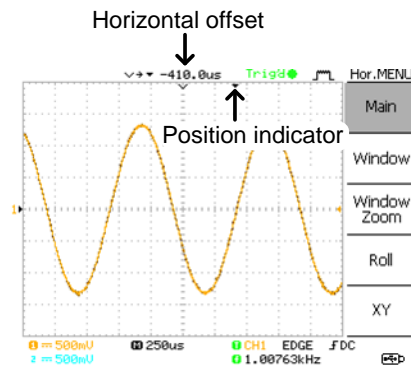

Selecting the horizontal scale

To select the timebase (scale), turn the TIME/DIV knob; left (slow) or right (fast).

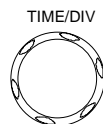

Range 1ns/Div ~ 10s/Div, 1-2.5-5 increment

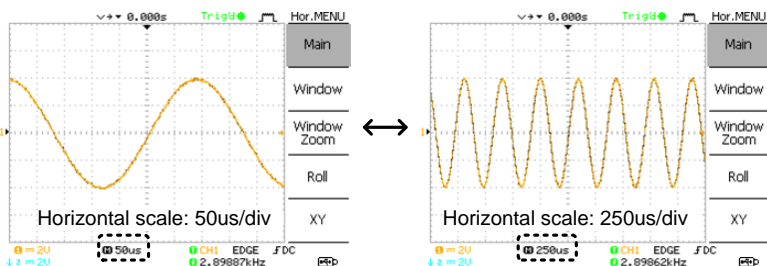

Changing the vertical position and scale

For more detailed configuration, see page 81.

Set vertical position

To move the waveform up or down, turn the vertical position knob for each channel.



As the waveform moves, the vertical position of the cursor appears at the bottom left corner of the display.

Run/Stop mode The waveform can be moved vertically in both Run and Stop mode.

Select vertical scale

To change the vertical scale, turn the VOLTS/DIV knob; left (down) or right (up).



Range 2mV/Div ~ 10V/Div, 1-2-5 increments



The vertical scale indicator for each channel on the bottom left of the display changes accordingly.

Using the probe compensation signal

Background This section introduces how to use the probe compensation signal for general usage, in case the DUT signal is not available or to get a second signal for comparison. For probe compensation details, see page 116.



Note: The frequency accuracy and duty factor are not guaranteed. Therefore the signal should not be used for reference purposes.

Waveform type		Square waveform used for probe compensation. 1k ~ 100kHz, 5% ~ 95%.
		Demonstration signal for showing the effects of peak detection. See page 71 for peak detection mode details.

View the probe compensation waveform

1. Connect the probe between the compensation signal output and Channel input.

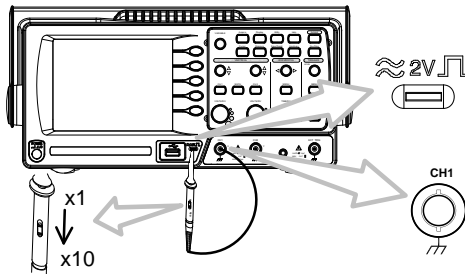

2. Press the Utility key.



3. Press *ProbeComp*.



4. Press Wave type repeatedly to select the wave type.

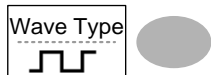

5. (For  only) To change the frequency, press *Frequency* and use the Variable knob.

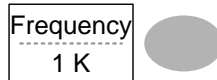

VARIABLE



Range 1kHz ~ 100kHz

6. (For  only) To change the duty cycle, press *Duty Cycle* and use the Variable knob.

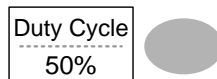

VARIABLE



Range 5% ~ 95%



















Probe compensation





For probe compensation details, see page 116.









Automatic Measurements

The automatic measurement function measures input signal attributes and updates them in the display. Up to 5 automatic measurement items can be updated at any one time on the side menus. All automatic measurement types can be displayed on screen if necessary.







Measurement items

Overview	Voltage type	Time type
	Vpp 	Frequency 
	Vmax 	Period 
	Vmin 	RiseTime 
	Vamp 	FallTime 
	Vhi 	+ Width 
	Vlo 	- Width 
	Vavg 	Dutycycle 
	Vrms 	
	ROVShoot 	
	FOVShoot 	
	RPREShoot 	
	FPREShoot 	

Voltage measurement items	Measurement Item	Description
	Vpp 	Difference between positive and negative peak voltage (=Vmax - Vmin)
	Vmax 	Positive peak voltage.
	Vmin 	Negative peak voltage.
	Vamp 	Difference between global high and global low voltage (=Vhi - Vlo)

Vhi		Global high voltage.
Vlo		Global low voltage.
Vavg		Averaged voltage of the first cycle.
Vrms		RMS (root mean square) voltage.
ROVShoot		Rise overshoot voltage.
FOVShoot		Fall overshoot voltage.
RPREShoot		Rise preshoot voltage.
FPREShoot		Fall preshoot voltage.

Time measurement items

Freq		Frequency of the waveform.
Period		Waveform cycle time (=1/Freq).
Risetime		Rising time of the pulse (~90%).
Falltime		Falling time of the pulse (~10%).
+Width		Positive pulse width.
-Width		Negative pulse width.
Duty Cycle		Ratio of signal pulse compared with whole cycle =100x (Pulse Width/Cycle)

Automatically measuring the input signals

Viewing the measurement result

1. Press the Measure key.



2. The measurement results appear on the menu bar, constantly updated. 5 measurement slots (F1 to F5) can be customized.

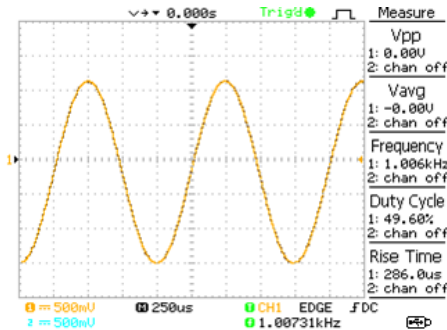

Selecting a measurement item

3. Press F3 repeatedly to select the measurement type: Voltage or Time.

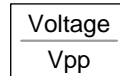

4. Use the Variable knob to select the measurement item.

VARIABLE

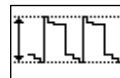

5. Press Previous Menu to confirm the item selection and to go back to the measurement results view.

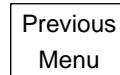

Cursor Measurements



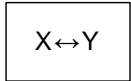
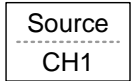

Cursor line, horizontal or vertical, shows the precise position of the input waveforms or the math operation results. The horizontal cursor can track time, voltage and frequency, whilst the vertical cursor can track voltage.

Using the horizontal cursors



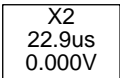

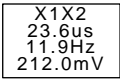
- | | |
|-----------|---|
| Procedure | <ol style="list-style-type: none"> 1. Press the Cursor key. The cursors appear in the display.  2. Press X↔Y to select the horizontal (X1&X2) cursor.  3. Press Source repeatedly to select the source channel.  <div style="margin-left: 20px;"> Range CH1, 2, MATH </div> 4. The cursor measurement results will appear in the menu, F2 to F4. |
|-----------|---|

Parameters	<table border="0"> <tr> <td>X1</td> <td>Time position of the left cursor. (relative to zero)</td> </tr> <tr> <td>X2</td> <td>Time position of the right cursor. (relative to zero)</td> </tr> <tr> <td>X1X2</td> <td>The difference between the X1 and X2.</td> </tr> <tr> <td>-uS</td> <td>The time difference between X1 and X2.</td> </tr> <tr> <td>-Hz</td> <td>The time distance converted to frequency.</td> </tr> <tr> <td>-V</td> <td>The voltage difference. (X1-X2)</td> </tr> </table>	X1	Time position of the left cursor. (relative to zero)	X2	Time position of the right cursor. (relative to zero)	X1X2	The difference between the X1 and X2.	-uS	The time difference between X1 and X2.	-Hz	The time distance converted to frequency.	-V	The voltage difference. (X1-X2)
X1	Time position of the left cursor. (relative to zero)												
X2	Time position of the right cursor. (relative to zero)												
X1X2	The difference between the X1 and X2.												
-uS	The time difference between X1 and X2.												
-Hz	The time distance converted to frequency.												
-V	The voltage difference. (X1-X2)												



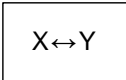

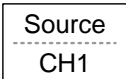
Moving the horizontal cursors	To move the left cursor, press X1 and then use the Variable knob. 
-------------------------------	---

	To move the right cursor, press X2 and then use the Variable knob.		
	To move both cursors at once, press X1X2 and then use the Variable knob.		
Remove cursors	Press Cursor to remove the onscreen cursors.		

Using the vertical cursors

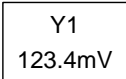
Procedure	1. Press the Cursor key.		
	2. Press X↔Y to select the vertical (Y1&Y2) cursor.		
	3. Press Source repeatedly to select the source channel.		
	Range CH1, 2, MATH		
	4. The cursor measurement results will appear in the menu.		

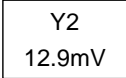
Parameters	Y1	Voltage level of the upper cursor
	Y2	Voltage level of the lower cursor
	Y1Y2	The difference between the upper and lower cursor

Moving the vertical cursors	To move the upper cursor, press Y1 and then use the Variable knob.		
	To move the lower cursor, press Y2 and then use the Variable knob.		

To move both cursors at once, press **Y1Y2** and then use the Variable knob.

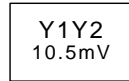

Remove cursors Press **Cursor** to remove the onscreen cursors.









Math Operations

The Math operations can add, subtract, or perform FFT on the input waveforms. The resulted waveform can be measured using the cursors, and saved or recalled just like normal input signals.

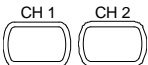

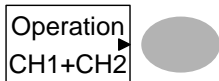
Overview

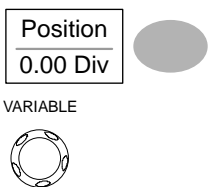

Addition (+)	Adds the amplitude of CH1 & CH2 signals.	
Subtraction (-)	Extracts the amplitude difference between CH1 & CH2.	
FFT	Performs a FFT calculation on a signal. Four types of FFT windows are available: Hanning, Flattop, Rectangular, and Blackman.	
Hanning FFT window	Frequency resolution	Good
	Amplitude resolution	Not good
	Suitable for...	Frequency measurement on periodic waveforms
Flattop FFT window	Frequency resolution	Not good
	Amplitude resolution	Good
	Suitable for...	Amplitude measurement on periodic waveforms
Rectangular FFT window	Frequency resolution	Very good
	Amplitude resolution	Bad
	Suitable for...	Single-shot phenomenon (this mode is the same as having no window at all)
Blackman FFT window	Frequency resolution	Bad
	Amplitude resolution	Very good
	Suitable for...	Amplitude measurement on periodic waveforms

Adding, subtracting or multiplying signals

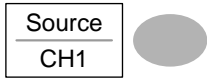

- | | | |
|-----------|---|---|
| Procedure | <ol style="list-style-type: none"> 1. Activate both CH1 and CH2. |  |
| | <ol style="list-style-type: none"> 2. Press the Math key. |  |
| | <ol style="list-style-type: none"> 3. Press Operation repeatedly to select addition (+) or subtraction (-). |  |
| | <ol style="list-style-type: none"> 4. The math measurement result appears in the display. |  |
| | <ol style="list-style-type: none"> 5. To move the math result vertically, use the Variable knob. The position will be displayed in Position. |  |
| | <ol style="list-style-type: none"> 6. To clear the math result from the display, press the Math key again. |  |

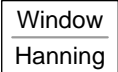
Using the FFT function

- | | | |
|-----------|--|---|
| Procedure | <ol style="list-style-type: none"> 1. Press the Math key. |  |
| | <ol style="list-style-type: none"> 2. Press Operation repeatedly to select FFT. |  |
| | <ol style="list-style-type: none"> 3. Press Source repeatedly to select the source channel. |  |

4. Press Window repeatedly to select the FFT window type.  

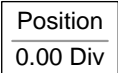

5. The FFT result appears. The horizontal scale changes from time to frequency, and the vertical scale from voltage to dB.

6. To move the FFT waveform vertically, press Position and use the Variable knob.  

VARIABLE

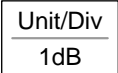

Range -12.00 Div ~ +12.00 Div

7. To select the vertical scale of FFT waveform, press Unit/Div repeatedly.  

Range 1, 2, 5, 10, 20 dB/Div

8. To clear the FFT result from the display, press the Math key again. 





Go No-Go Testing

Overview

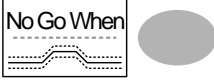
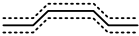

Background Go-NoGo testing checks if a waveform conforms to a user-specified maximum and minimum boundary (template). The testing can be set to stop or continue each time the template has or has not been violated by the input waveform.

Settings	Item	Default	Details
	NoGo criteria: When inside or outside the boundary	Inside	Page 61
	Source	Channel 1	Page 61
	Test continue or stop when NoGo occurs	Stop	Page 62
	Boundary (template) – selects the minimum and maximum boundaries (template) from a single waveform	Auto (0.4%)	Page 62
	Run Tests		Page 66



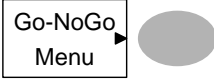
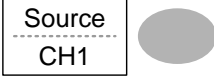

Edit: NoGo When

- | | | |
|-----------|---|---|
| Procedure | 1. Press the Utility key. |  |
| | 2. Press the <i>More</i> key. |  |
| | 3. Press <i>No Go When</i> repeatedly to select the NoGo conditions. |  |
| |  | NoGo when the waveform is inside the boundary (template) |
| |  | NoGo when the waveform is outside of the boundary (template) |

Edit: Source

- | | | |
|-----------|---|---|
| Procedure | 1. Press the Utility key. |  |
| | 2. Press the More key. |  |
| | 3. Press the Go-NoGo Menu key. |  |
| | 4. Press Source repeatedly to select the source channel (CH1 or CH2). |  |

Edit: NoGo Violation Conditions

- | | | |
|-----------|--|---|
| Procedure | <ol style="list-style-type: none"> 1. Press the Utility key. |  |
| | <ol style="list-style-type: none"> 2. Press the <i>More</i> key. |  |
| | <ol style="list-style-type: none"> 3. Press the <i>Go-NoGo</i> Menu key. |  |
| | <ol style="list-style-type: none"> 4. Press Violating repeatedly to select the NoGo conditions. |  |
-
- | | |
|----------|---|
| Stop | Stops the test when the NoGo conditions have been met. |
| Continue | The tests continue even when the NoGo conditions have been met. |

Edit: Template (boundary)

- | | |
|------------|--|
| Background | <p>The NoGo template sets the upper and lower amplitude boundary. Two methods are available: Min/Max and Auto.</p> |
| Min/Max | <p>Selects the upper boundary (Max) and lower boundary (Min) as separate waveforms, from the internal memory. The upper boundary is saved to Ref A, the lower boundary is saved to Ref. B.</p> <p>Advantage: The template shape and distance (allowance) between the source signal are fully</p> |

customizable.

Disadvantage: The waveforms (templates) have to be stored internally prior to this selection.

Auto

Creates the upper and lower boundary (template) from the source signal, not from an internally stored waveform.

Advantage: No need to store the waveforms prior to this selection.

Disadvantage: The template shape is proportional to the source signal. The distance (allowance) between the source signal and the upper and lower template is the same.

Max/Mix

1. The template is based on the source signal. Ensure the source signal appears on the display.

2. Press the Utility key.



3. Press the *More* key.



4. Press the *Go-NoGo Menu* key.

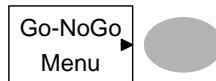

5. Press the *Template Edit* key.

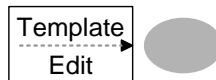

6. Press *Template* repeatedly to select the upper (Max) or lower (Min) boundaries.

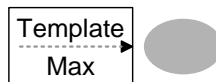

- Press *Source* and use the *Variable* knob to select the waveform template.

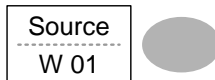

VARIABLE



Max Waveform A: Ref A, W01~W15

Min Waveform B: Ref B, W01~W15

- Press *Position* and use the *Variable* knob to set the waveform amplitude.

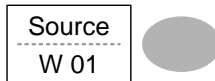

VARIABLE



- Repeat steps 5-7 for the other template setting (Max or Min).

- When both Max and Min templates have been configured, press *Save & Create* to save the templates.

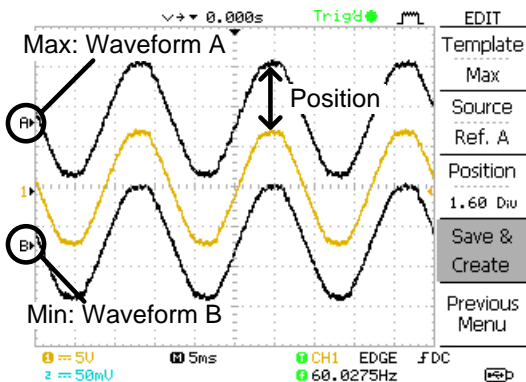
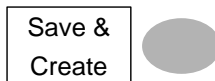

Auto

1. The template is based on the source signal. Ensure the source signal appears on the display.

2. Press the Utility key.



3. Press the *More* key.



4. Press the *Go-NoGo Menu* key.

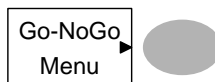

5. Press the *Template Edit* key.



6. Press *Template* repeatedly to select the Auto template.

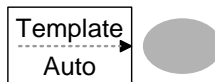

7. Press *Source* and use the Variable knob to select the template source.

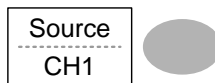

VARIABLE



Source CH1, CH2

8. Press *Tolerance* repeatedly to choose the tolerance units, % or Div. Use the Variable knob to set the tolerance. The tolerance is for both the horizontal and vertical axis.

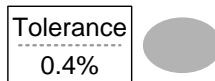

VARIABLE



% 0.4% ~ 40.0%

Div 0.04 Div ~ 4.0 Div

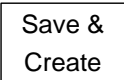
- When the Auto template has been configured, press *Save & Create* to save the template. 

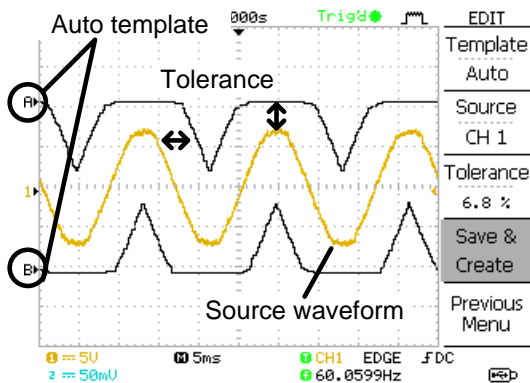

Run Go-NoGo Tests

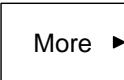
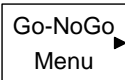
- Procedure
- Press the *Utility* key. 
 - Press the *More* key. 
 - Press the *Go-NoGo Menu* key. 

Ensure the source signal and boundary templates appear on the screen.

4. Press *Go-NoGo*. The test starts and stops according to the conditions set on page 61, 62. To stop the test that has already started, press *Go-NoGo* again.

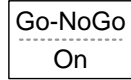

5. The test results appear in the Ratio soft-key. The numerator denotes the total number of failed tests. The denominator denotes the total number of tests.

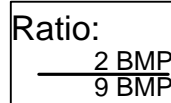

Numerator Number of “failed” tests.

Denominator Total number of tests.

Data Logging

Overview



Background

The Data logging function allows you to log data or a screen image over timed intervals for up to 100 hours to a USB flash drive.

The data or images are stored to a USB flash drive in a directory named LogXXXX. LogXXXX is incremented each time the data logging function is used.



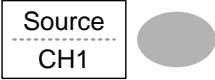

The files saved in the LogXXXX directory are named DSXXXX.CSV, or DSXXXX.BMP for data or image files, respectively. At each timed interval data or an image file is saved and the file number incremented. For example, DS0000 is the first logged data, DS0001 is the second and so on.

Edit: Source

- | | | |
|-----------|---|---|
| Procedure | 1. Press the Utility key. |  |
| | 2. Press the <i>More</i> key. |  |
| | 3. Press the <i>Data logging Menu</i> key. |  |
| | 4. Press Source repeatedly to select the source channel (CH1 or CH2). |  |

Edit: Setup Parameters

Background The logging function must set the type of data that will be logged (waveform/image), the capture interval time and the duration of the data logging.

- | | | |
|-----------|--|---|
| Procedure | 1. Press the Utility key. |  |
| | 2. Press the <i>More</i> key. |  |
| | 3. Press the <i>Data logging Menu</i> key. |  |
| | 4. Press the <i>Setup</i> key. |  |

5. Press *Save* repeatedly to log data or screen images.

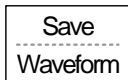

6. Press *Interval* and use the Variable knob to select the interval time.

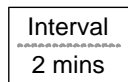

VARIABLE



Interval time 2 secs~ 2min (duration = 5 min)
 2 secs~ 5 min (duration 5~ 30 min)
 2 secs~ 30 min (duration 30+ min)

7. Press *Duration* and use the Variable knob to set the duration time.

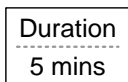

VARIABLE



Duration 5 mins ~ 100 hours

8. Press Previous menu to return to the Data logging menu. Data logging is now ready to begin.

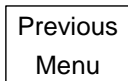

Run Data logging

Background Ensure the data source (page 68) and data logging setup has been set (page 68).

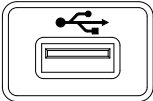
- Procedure**
1. Insert a USB flash drive into the USB front panel port.
 

 2. Press the Utility key.
 

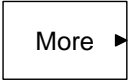
 3. Press the *More* key.
 

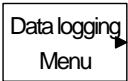
 4. Press the *Data logging Menu* key.
 

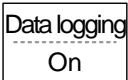
 5. Press *Data logging* to turn data logging On. Data/image files start logging to the USB flash drive automatically. To stop the Data logging, press the *Data logging* key again.
 

C ONFIGURATION

The Configuration chapter describes how to configure panel settings to make measurements and observations suited to the application needs.

Acquisition

The acquisition process samples the analog input signals and converts them into digital format for internal processing. You may select the normal, average, or peak detect acquisition mode.

Selecting the acquisition mode

Procedure

1. Press the Acquire key.



2. Select the acquisition mode between *Normal*, *Average* and *Peak Detect*.

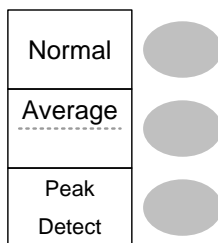

Range

Normal

All of the acquired data is used to draw the waveform.

- Average** Multiple data is averaged to form a waveform. This mode is useful for drawing a noise-free waveform. To select the number, press *Average* repeatedly.

Average number: 2, 4, 8, 16, 32, 64, 128, 256
- Peak detect** To activate the Peak detect mode, press *Peak-Detect*. Only the minimum and maximum value pairs for each acquisition interval (bucket) are used. This mode is useful for catching abnormal glitches in a signal.

Peak detect effect using the probe comp. waveform

1. One of the probe compensation waveforms can demonstrate the peak detection mode. Connect the probe to the probe compensation output.



2. Press the Utility key.



3. Press *ProbeComp*.



4. Press *Wave Type* and select the waveform.

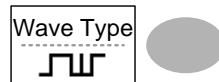

5. Press the Autoset key. The oscilloscope positions the waveform in the center of the display.



6. Press the Acquire key.



7. Press *Normal*.



8. Press *Peak-Detect* and see that a spike noise is captured.

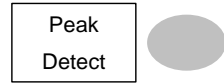

Example

The peak detect mode reveals the occasional glitch.

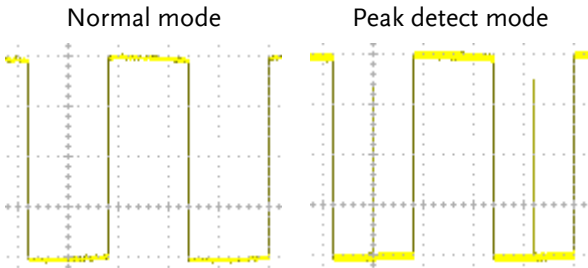

Real time vs Equivalent time sampling mode

Backgrounds	The oscilloscope automatically switches between two sampling modes, Real-time and Equivalent-time, according to the number of active channels and sampling rate.
Real-time sampling	One sampled data is used to reconstruct a single waveform. Short-time events might get lost if the sampling rate gets too high. This mode is used when the sampling rate is relatively low (250MSa/s or lower).
Equivalent-time sampling	Multiple numbers of sampled data are accumulated to reconstruct a single waveform. Restores greater waveform details but takes longer to update the waveform. This mode is used when the sampling rate becomes higher than 250MSa/s. The maximum equivalent-time sampling rate is 25GSa/s.

Display

The Display section describes how to configure the display settings: drawing type, waveform accumulation, contrast adjustment, and grid settings.

Selecting vector or dot drawing

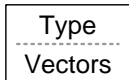
Procedure	1. Press the Display key.	
	2. Press <i>Type</i> repeatedly to select the waveform drawing.	

Types	Dots	Only the sampled dots are displayed.
	Vectors	The sampled dots are connected by lines.

Accumulating the waveform

Background	Accumulation preserves the old waveform drawings and overwrites new waveforms on top of it. It is useful for observing waveform variation.
------------	--

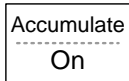
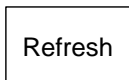
Procedure	1. Press the Display key.	
	2. Press <i>Accumulate</i> on the waveform accumulation.	
	3. To clear the accumulation and start it over (refresh), press <i>Refresh</i> .	

Example

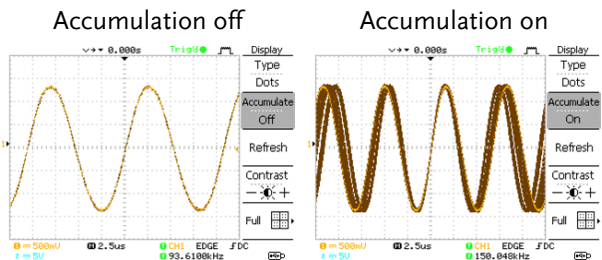

Adjusting the display contrast

Procedure

1. Press the Display key.
2. Press *Contrast*.

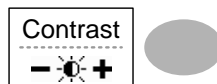

Turn the Variable knob left to lower the contrast (dark display) or right to raise the contrast (bright display).

VARIABLE



Selecting the display grid

Procedure

1. Press the Display key.
2. Press the grid icon repeatedly to select the grid.

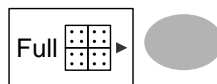

Parameters



Shows the full grid.



Shows the outer frame and X/Y axis.



Shows only the outer frame.

Horizontal View

The Horizontal view section describes how to configure the horizontal scale, position, waveform update mode, window zoom, and X-Y mode.

Moving the waveform position horizontally

Procedure

The horizontal position knob moves the waveform left or right. The position indicator at the top of the display shows the center and current position.

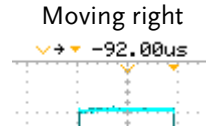
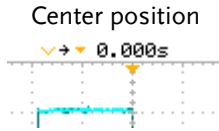
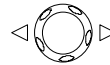

Selecting the horizontal scale

Select horizontal scale

To select the timebase (scale), turn the TIME/DIV knob; left (slow) or right (fast).

TIME/DIV



Range 1ns/Div ~ 50s/Div, 1-2.5-5-10 increment

The timebase indicator at the bottom of the display updates the current horizontal scale.

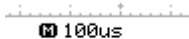
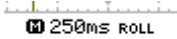

Selecting the waveform update mode

Background	The display update mode is switched automatically or manually according to the horizontal scale.
Main mode	<p>Updates the whole displayed waveform at once. The main mode is automatically selected when the horizontal scale (timebase) is fast.</p> <p>Horizontal scale $\leq 100\text{ms/div}$</p> <p>Trigger All modes available</p>
Roll mode	<p>Updates and moves the waveform gradually from the right side of the display to the left. The Roll mode is automatically selected when the horizontal scale (timebase).</p> <p>When in the Roll mode, an indicator appears at the bottom of the display.</p> <div style="display: flex; justify-content: space-around; align-items: center;"> <div style="text-align: center;"> <p>Main mode</p>  <p>100µs</p> </div> <div style="text-align: center;"> <p>Roll mode</p>  <p>250ms ROLL</p> </div> </div> <p>Timebase $\geq 50\text{ms/div}$ ($\leq 5\text{kS/s}$)</p> <p>Trigger Auto mode only</p>

Selecting the Roll mode manually

1. Press the Horizontal menu key.



2. Press *Roll*. The horizontal scale automatically becomes 50ms/div and the waveform starts scrolling from the right side of the display (If the oscilloscope is already in the Roll mode, there will be no change).

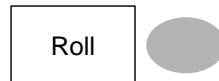

Zooming the waveform horizontally

Procedure/ range 1. Press the Horizontal Menu key.



2. Press *Window*.



3. Use the horizontal position knob to move the zoom range sideways, and TIME/DIV knob to change the zoom range width.

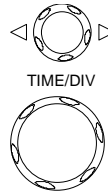

The width of the bar in the middle of the display is the actual zoomed area.

Zoom range 1ns ~ 25s

4. Press *Window Zoom*. The specified range gets zoomed.

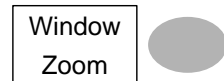

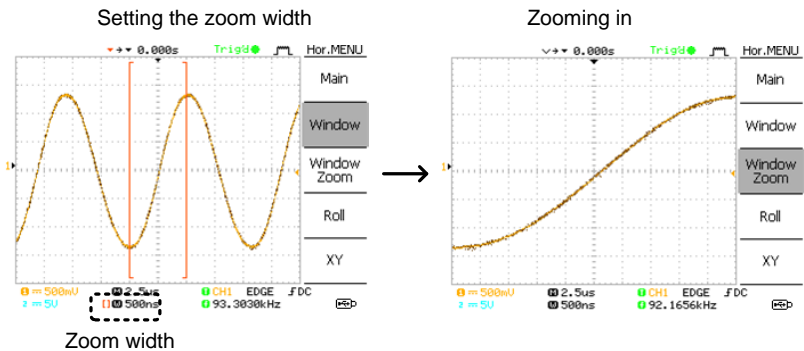

Example

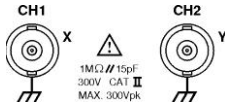
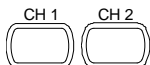

Viewing waveforms in the X-Y mode

Background The X-Y mode compares the voltage of Channel 1 and Channel 2 waveforms in a single display. This mode is useful for observing the phase relationship between the two waveforms.

- Procedure**
1. Connect the signals to Channel 1 (X-axis) and Channel 2 (Y-axis).
 
 2. Make sure both Channel 1 and 2 are activated.
 
 3. Press the Horizontal key.
 
 4. Press XY. The display shows two waveforms in X-Y format; Channel 1 as X-axis, Channel 2 as Y-axis.
 

Adjusting the X-Y mode waveform	Horizontal position	CH1 Position knob
	Horizontal scale	CH1 Volts/Div knob
	Vertical position	CH2 Position knob
	Vertical scale	CH2 Volts/Div knob

Example

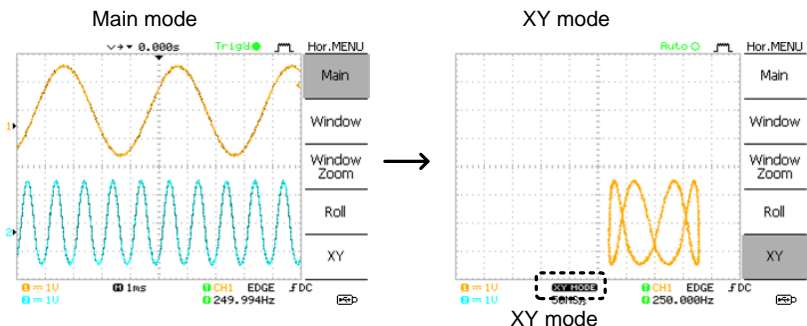

Vertical View (Channel)

The Vertical view section describes how to set the vertical scale, position, bandwidth limitation, coupling mode, and attenuation.

Moving the waveform position vertically

Procedure To move the waveform up or down, turn the vertical position knob for each channel. 



Selecting the vertical scale

Procedure To change the vertical scale, turn the VOLTS/DIV knob; left (down) or right (up). 

Range 2mV/Div ~ 10V/Div, 1-2-5 increments

Selecting the coupling mode

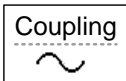
Procedure

1. Press the Channel key. 
2. Press *Coupling* repeatedly to select the coupling mode.  

Range

 DC coupling mode. The whole portion (AC and DC) of the signal appears on the display.

 Ground coupling mode. The display shows only the zero voltage level as a horizontal line. This mode is useful for measuring the signal amplitude with respect to the ground level.



AC coupling mode. Only the AC portion of the signal appears on the display. This mode is useful for observing AC waveforms mixed with DC components.

Inverting the waveform vertically

Procedure

1. Press the Channel key.



2. Press *Invert*. The waveform becomes inverted (upside down) and the Channel indicator in the display shows a down arrow.

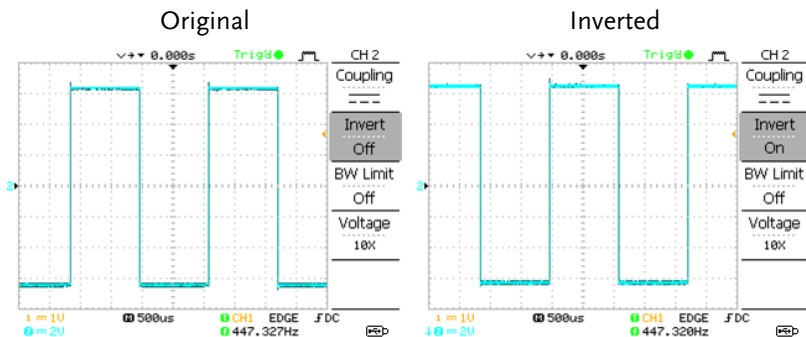
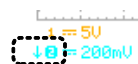
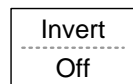

Limiting the waveform bandwidth

Background

Bandwidth limitation puts the input signal into a 20MHz (-3dB) low-pass filter. This function is useful for cutting off high frequency noise to see the clear waveform shape.

Procedure

1. Press the Channel key.



2. Press *BW Limit* to turn on or off the limitation. When turned on, the BW indicator appears next to the Channel indicator in the display.

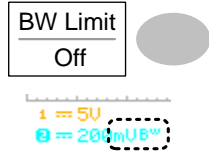

Example

BW Limit Off

BW Limit On

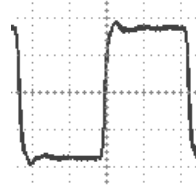
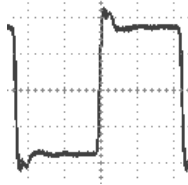

Selecting the probe attenuation level

Background

A signal probe has an attenuation switch to lower the original DUT signal level to the oscilloscope input range, if necessary. The probe attenuation selection adjusts the vertical scale so that the voltage level on the display reflects the real value, not the attenuated level.

Procedure

1. Press the Channel key.



2. Press Probe repeatedly to select the attenuation level.

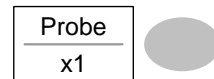

3. The voltage scale in the channel indicator changes accordingly. There is no change in the waveform shape.

Range

x1, x10, x100

Note

The attenuation factor adds no influence on the real signal; it only changes the voltage scale on the display.

Trigger

The Trigger function configures the conditions by which the oscilloscope captures the incoming signals.

Trigger type

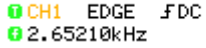
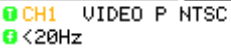
Edge	Triggers when the signal crosses an amplitude threshold in either a positive or negative slope.	
Video	Extracts a sync pulse from a video format signal and triggers on a specific line or field.	
Pulse	Triggers when the pulse width of the signal matches the trigger settings.	
Indicators	Edge/Pulse	Video
		
	(CH1, Edge, Rising edge, DC coupling)	(CH1, Video, Positive polarity, NTSC standard)

Trigger parameter

Trigger source	CH1, 2	Channel 1, 2 input signals	
	Line	AC mains signal	
	Ext	External trigger input signal	
Trigger mode	Auto	The oscilloscope updates the input signal regardless of the trigger conditions (if there is no trigger event, the oscilloscope generates an internal trigger). Select this mode especially when viewing rolling waveforms at a slow timebase.	

The Auto trigger status appears in the upper right corner of the display.

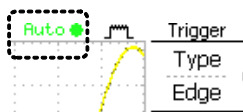

Single The oscilloscope acquires the input signals once when a trigger event occurs, then stops acquiring. Pressing the Single key again will repeat the process.





The Single trigger status appears in the upper right corner of the display.



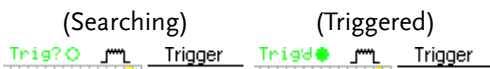

Normal The oscilloscope acquires and updates the input signals only when a trigger event occurs.







The Normal trigger status appears in the upper right corner of the display.

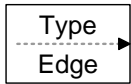

Video standard (video trigger)	NTSC	National Television System Committee
	PAL	Phase Alternative by Line
	SECAM	SEquential Couleur A Mémoire
Sync polarity (video trigger)		Positive polarity
		Negative polarity
Video line (video trigger)	Selects the trigger point in the video signal.	
	field	1 or 2
	line	1~263 for NTSC, 1~313 for PAL/SECAM
Pulse condition (pulse trigger)	Sets the pulse width (20ns ~ 10s) and the triggering condition.	

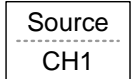
	>	Longer than	=	Equal to
	<	Shorter than	≠	Not equal to
Trigger slope		Triggers on the rising edge.		
		Triggers on the falling edge.		
Trigger coupling	AC	Triggers only on AC component.		
	DC	Triggers on AC+DC component.		
Frequency rejection	LF	Puts a high-pass filter and rejects the frequency below 50kHz.		
	HF	Puts a low-pass filter and rejects the frequency above 50kHz.		
Noise rejection	Rejects noise signals.			
Trigger level		Using the trigger level knob moves the trigger point up or down.		

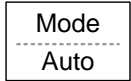
Configuring the edge trigger

- Procedure
1. Press the Trigger menu key. 
 2. Press *Type* repeatedly to select edge trigger.  
 3. Press *Source* repeatedly to select the trigger source.  
 Range Channel 1, 2, Line, Ext
 4. Press *Mode* repeatedly to select the Auto or Normal trigger mode. To select the single trigger mode, press the Single key.  

Range Auto, Normal

5. Press *Slope/coupling* to enter into the trigger slope and coupling selection menu.

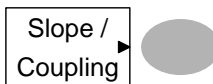

6. Press *Slope* repeatedly to select the trigger slope, rising or falling edge.

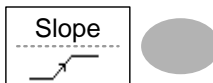

Range Rising edge, falling edge

7. Press *Coupling* repeatedly to select the trigger coupling, DC or AC.

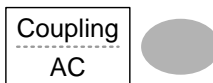

Range DC, AC

8. Press *Rejection* to select the frequency rejection mode.



Range LF, HF, Off

9. Press *Noise Rej* to turn the noise rejection on or off.

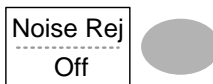

Range On, Off

10. Press *Previous* menu to go back to the previous menu.

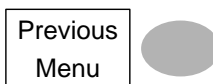

Configuring the video trigger

- Procedure
1. Press the Trigger menu key.

 2. Press *Type* repeatedly to select video trigger. The video trigger indicator appears at the bottom of the display.

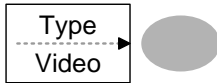

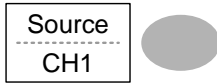
 3. Press *Source* repeatedly to select the trigger source channel.



Range Channel 1, 2
 4. Press *Standard* repeatedly to select the video standard.



Range NTSC, PAL, SECAM
 5. Press *Polarity* repeatedly to select the video signal polarity.



Range positive, negative
 6. Press *Line* repeatedly to select the video field line. Use the Variable knob to select the field.







VARIABLE

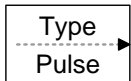
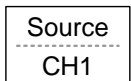
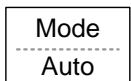

Field NTSC: 1 ~ 262 (Field 2), 1 ~ 263 (Field 1) PAL/SECAM: 1 ~ 312 (Field 2), 1 ~ 313 (Field1)

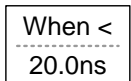
Configuring the pulse width trigger

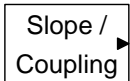
- | | | |
|-----------|---|---|
| Procedure | <p>1. Press the Trigger menu key.</p> |  |
| | <p>2. Press <i>Type</i> repeatedly to select pulse width trigger. The pulse width trigger indicator appears at the bottom of the display.</p> |  |
| | <p>3. Press <i>Source</i> repeatedly to select the trigger source.</p> |  |
| | <p>Range Channel 1, 2, Ext</p> | |
| | <p>4. Press <i>Mode</i> repeatedly to select the trigger mode, Auto or Normal. To select the Single trigger mode, press the Single key.</p> |  |
| | <p>Range Auto, Normal</p> |  |
| | <p>5. Press <i>When</i> repeatedly to select the pulse condition. Then use the Variable knob to set the pulse width.</p> |  |
| | <p>Condition > , < , = , ≠</p> <p>Width 20ns ~ 10s</p> | <p>VARIABLE</p>  |
| | <p>6. Press <i>Slope/Coupling</i> to set trigger slope and coupling.</p> |  |

7. Press *Slope* repeatedly to select the trigger slope, which also appears at the bottom of the display.
- Range Rising edge, falling edge
8. Press *Coupling* repeatedly to select the trigger coupling.
- Range DC, AC
9. Press *Rejection* to select the frequency rejection mode.
- Range LF, HF, Off
10. Press *Noise Rej* to turn the noise rejection on or off.
- Range On, Off
11. Press *Previous* menu to go back to the previous menu.

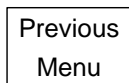
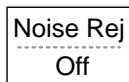
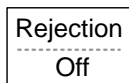
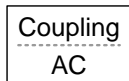
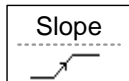

Manually triggering the signal



Note: This section describes how to manually trigger the input signals when the oscilloscope does not capture them. This section applies to the Normal and Single trigger mode, since in the Auto trigger mode, the oscilloscope keeps updating the input signal regardless of the trigger conditions.

To acquire the signal regardless of trigger conditions

To acquire the input signal regardless of the trigger condition, press the Force key. The oscilloscope captures the signals once.



In the Single trigger mode

Press the Single key to start waiting for the trigger condition. To break out of the Single mode, press the Run/Stop key. The trigger mode changes to the Normal mode.



Rear Panel USB Port Interface

The Remote control interface section describes how to set up the USB interface for PC connection. The details of remote control commands are described in the GDS-1000-U Programming Manual.

USB connection	PC end	Type A, host
	GDS-1000-U end	Type B, slave
	Speed	1.1/2.0 (full speed)

Procedure

1. Connect the USB cable to the USB slave port on the GDS-1000-U.

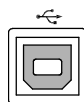

2. When the PC asks for the USB driver, select `dso_cdc_1000.inf` which is downloadable from the GW website, www.gwinstek.com.tw, GDS-1000-U product corner.
3. On the PC, activate a terminal application such as MTTY (Multi-Threaded TTY). To check the COM port No., see the Device Manager in the PC. For WindowsXP, select Control panel → System → Hardware tab.
4. Run this query command via the terminal application.
`*idn?`
 This command should return the manufacturer, model number, serial number, and firmware version in the following format.
`GW, GDS-1052-U, 000000001, V1.00`
5. Configuring the command interface is completed. Refer to the programming manual for the remote commands and other details.

System Settings

The system settings show the oscilloscope's system information and allow changing the language.

Viewing the system information

Procedure

1. Press the Utility key.



2. Press *System Info*. The upper half of the display shows the following information.

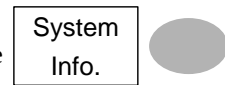

- Manufacturer
- Serial number
- Web address
- Model
- Firmware version

3. Press any other key to go back to the waveform display mode.



Selecting the language

Parameter

Language selection differs according to the region to which the oscilloscope is shipped.

- English
- Chinese (simplified)
- Korean
- German
- Portuguese
- Polish
- Chinese (traditional)
- Japanese
- French
- Russian
- Italian
- Spanish

Procedure

1. Press the Utility key.



2. Press *Language* repeatedly to select the language.

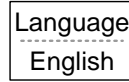

SAVE/RECALL

The save function allows saving display images, waveform data, and panel settings into the oscilloscope's internal memory or to the front panel USB port. The recall function allows recalling the default factory settings, waveform data, and panel settings from the oscilloscope's internal memory or from USB.

File Structures

Three types of file are available: display image, waveform file, and panel settings.

Display image file format

Format	xxxx.bmp (Windows bitmap format)
Contents	The current display image in 234 x 320 pixels, color mode. The background color can be inverted (Ink saver function).

Waveform file format

Format	xxxx.csv (Comma-separated values format which can be opened in spreadsheet applications such as Microsoft Excel)	
Waveform type	CH1, 2	Input channel signal
	Math	Math operation result (page 5757)
Storage location	Internal memory	The oscilloscope's internal memory, which can hold 15 waveforms.

External USB Flash drive A USB flash drive (FAT or FAT32 format) can hold practically an unlimited number of waveforms.

Ref A, B Two reference waveforms are used as a buffer to recall a waveform in the display. You have to save a waveform into internal memory or to USB, then copy the waveform into the reference waveform slot (A or B), and then recall the reference waveform into the display.

Waveform data format

One division includes 25 points of horizontal and vertical data. The vertical point starts from the center line. The horizontal point starts from the leftmost waveform.

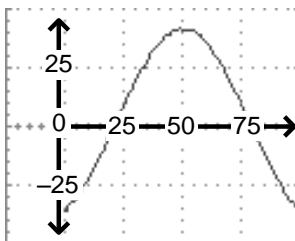

The time or amplitude represented by each data point depends on the vertical and horizontal scale. For example:

Vertical scale: 10mV/div (4mV per point)

Horizontal scale: 100us/div (4us per point)

Waveform file contents: other data

A waveform file also includes the following information.

- Memory length
- source channel
- vertical offset
- vertical scale
- coupling mode
- waveform last dot address
- date and time
- trigger level
- vertical position
- time base
- probe attenuation
- horizontal view
- horizontal scale
- sampling period
- sampling mode



Setup file format

Format xxxx.set (proprietary format)
A setup file saves or recalls the following settings.

Contents	Acquire	<ul style="list-style-type: none"> mode
	Cursor	<ul style="list-style-type: none"> source channel cursor on/off cursor location
	Display	<ul style="list-style-type: none"> dots/vectors grid type accumulation on/off
	Measure	<ul style="list-style-type: none"> item
	Utility	<ul style="list-style-type: none"> hardcopy type language Data Logging settings ink saver on/off Go-Nogo settings
	Horizontal	<ul style="list-style-type: none"> display mode position scale
	Trigger	<ul style="list-style-type: none"> trigger type trigger mode video polarity pulse timing source channel video standard video line slope/coupling
	Channel (vertical)	<ul style="list-style-type: none"> vertical scale coupling mode bandwidth limit on/off vertical position invert on/off probe attenuation
	Math	<ul style="list-style-type: none"> operation type vertical position FFT window source channel unit/div

Using the USB file utilities

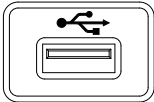
Background When a USB flash drive is inserted into the oscilloscope, file utilities (file deletion, folder creation and file/folder renaming) are available from the front panel.

- | | | |
|------------------|---|--|
| Procedure | <ol style="list-style-type: none"> 1. Insert a USB flash drive into the front panel USB port. |  |
| | <ol style="list-style-type: none"> 2. Press the Save/Recall key. Select any save or recall function. For example USB Destination in the Save image function. | <p>Save/Recall</p>  <p>(Example)</p> <div style="border: 1px solid black; padding: 5px; display: inline-block; margin-bottom: 5px;">Save Image</div> <div style="border: 1px solid black; padding: 5px; display: inline-block; margin-bottom: 5px;">Destination

USB</div> |
| | <ol style="list-style-type: none"> 3. Press <i>File Utilities</i>. The display shows the USB flash drive contents. | <div style="border: 1px solid black; padding: 5px; display: inline-block; margin-bottom: 5px;">File
Utilities</div> |
| | <ol style="list-style-type: none"> 4. Use the Variable knob to move the cursor. Press Select to go into the folder or go back to the previous directory level. | <p>VARIABLE</p>  <div style="border: 1px solid black; padding: 5px; display: inline-block; margin-top: 5px;">Select</div> |

USB flash drive indicator When a USB flash drive is inserted into the oscilloscope, an indicator appears at the right bottom corner of the display. (The USB flash drive shouldn't be removed when a file is saved or retrieved from USB).



Creating a new folder / renaming a file or folder

1. Move the cursor to the file or folder location and press *New Folder* or *Rename*. The file/folder name and the character map will appear on the display.

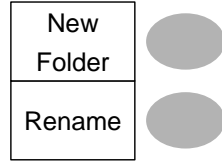

2. Use the Variable knob to move the pointer to the characters. Press *Enter Character* to add a character or *Back Space* to delete a character.

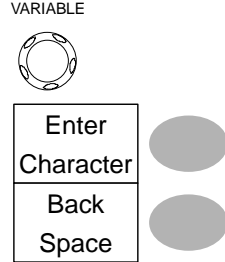

3. When editing is complete, press *Save*. The new/renamed file or folder will be saved.









Deleting a folder or file

1. Move the cursor to the folder or file location and press *Delete*. The message "*Press F4 again to confirm this process*" appears at the bottom of the display.
2. If the file/folder still needs to be deleted, press *Delete* again to complete the deletion. To cancel the deletion, press any other key.

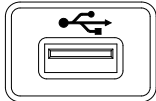

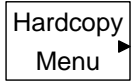
Quick Save (HardCopy)

Background	<p>The Hardcopy key works as a shortcut to save display images, waveform data, and panel settings onto a USB flash drive card.</p> <p>The Hardcopy key can be configured into two types of operations: save image and save all (image, waveform, setup).</p> <p>Using the Save/Recall key can also save files with more options. For details, see page 102.</p>	<p>Hardcopy</p>  <p>Save/Recall</p> 				
Functionalities	<table border="0"> <tr> <td style="padding-right: 20px;">Save image (*.bmp)</td> <td>Saves the current display image into a USB flash drive.</td> </tr> <tr> <td style="padding-right: 20px;">Save all</td> <td> <p>Saves the following items into a USB flash drive.</p> <ul style="list-style-type: none"> • Current display image (*.bmp) • Current system settings (*.set) • Current waveform data (*.csv) </td> </tr> </table>	Save image (*.bmp)	Saves the current display image into a USB flash drive.	Save all	<p>Saves the following items into a USB flash drive.</p> <ul style="list-style-type: none"> • Current display image (*.bmp) • Current system settings (*.set) • Current waveform data (*.csv) 	
Save image (*.bmp)	Saves the current display image into a USB flash drive.					
Save all	<p>Saves the following items into a USB flash drive.</p> <ul style="list-style-type: none"> • Current display image (*.bmp) • Current system settings (*.set) • Current waveform data (*.csv) 					
Procedure	<ol style="list-style-type: none"> 1. Insert a USB flash drive into the front panel USB port. 2. Press the Utility key. 3. Press <i>Hardcopy Menu</i>. 4. Press Function repeatedly to select <i>Save Image</i> or <i>Save All</i>. 	 <p>Utility</p>  <p>Hardcopy Menu</p>  <p>Function Save All</p> 				

5. To invert the color in the display image, press *Ink Saver*. This turns Ink Saver on or off.



6. Press the Hardcopy key. The file or folder will be saved to the root directory of the USB flash drive.



Save

This section describes how to save data using the Save/Recall menu.

File type/source/destination

Item	Source	Destination
Panel setup (xxxx.set)	<ul style="list-style-type: none"> Panel settings 	<ul style="list-style-type: none"> Internal memory: S1 ~ S15 External memory: USB
Waveform data (xxxx.csv)	<ul style="list-style-type: none"> Channel 1, 2 Math operation result Reference waveform A, B 	<ul style="list-style-type: none"> Internal memory: W1 ~ W15 Reference waveform A, B External memory: USB
Display image (xxxx.bmp)	<ul style="list-style-type: none"> Display image 	<ul style="list-style-type: none"> External memory: USB
Save All	<ul style="list-style-type: none"> Display image (xxxx.bmp) Waveform data (xxxx.csv) Panel settings (xxxx.set) 	<ul style="list-style-type: none"> External memory: USB

Saving the panel settings

Procedure

1. (For saving to USB flash drive) Insert the USB flash drive into the front panel USB port.

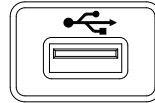

2. Press the Save/Recall key twice to access the Save menu.



3. Press *Save Setup*.



4. Press *Destination* repeatedly to select the saved location. Use the Variable knob to change the internal memory location (S1 ~ S15).

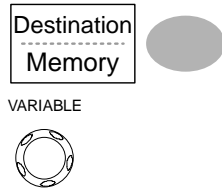

Memory	Internal memory, S1 ~ S15
USB	USB, no practical limitation for the amount of files. When saved, the setup file will be placed in the root directory.

5. Press *Save* to confirm saving. When completed, a message appears at the bottom of the display.



Note

The file will not be saved if the power is turned off or the USB flash drive is removed before completion.

File utilities

To edit the USB drive contents (create/ delete/ rename files and folders), press *File Utilities*. For details, see page 98.

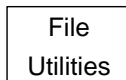

Saving the waveform

Procedure

1. (For saving to USB flash drive) Insert the USB flash drive into the front panel USB port.

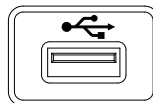

2. Press the Save/Recall key twice to access the Save menu.

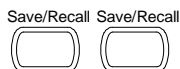

3. Press *Save Waveform*.

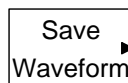

4. Press *Source*. Use the Variable knob to select the source signal.

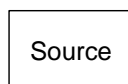

VARIABLE



- CH1 ~ CH2 Channel 1 ~ 2 signal
- Math Math operation result (page 57)
- RefA, B Internally stored reference waveforms A, B

5. Press *Destination* repeatedly to select the file destination. Use the Variable knob to select the memory location.

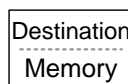

VARIABLE



Memory	Internal memory, W1 ~ W15
USB	Save to the USB flash drive with a 4k waveform memory length.
Ref	Internal reference waveform, A/B

6. Press *Save* to confirm saving. When completed, a message appears at the bottom of the display.



Note 

The file will not be saved if the power is turned off or the USB flash drive is removed from the USB port.

File utilities To edit the USB drive contents (create/ delete/ rename files and folders), press *File Utilities*. For details, see page 98.



Saving the display image

Background Saving the display image can be used as a screen capture or it can be used as a reference waveform.

- Procedure**
1. Insert the USB flash drive into the front panel USB port. (Image files can only be saved to USB)

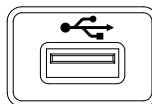

2. Press the Save/Recall key twice to access the Save menu.

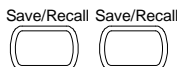

3. Press *Save Image*.

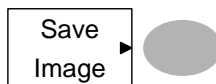

4. Press *Ink Saver* repeatedly to invert the background color (on) or not (off).



Note: *Destination* is set as USB. This cannot be changed.



5. Press *Save* to confirm saving. When completed, a message appears at the bottom of the display.



Note  The file will not be saved if the power is turned off or the USB flash drive is removed before completion.

File utilities

To edit the USB drive contents (create/ delete/ rename files and folders), press *File Utilities*. For details, see page 98.



Saving all (panel settings, display image, waveform)

Procedure

1. (For saving to USB flash drive) Insert the USB flash drive into the front panel USB port.

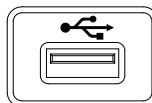

2. Press the Save/Recall key twice to access the Save menu.

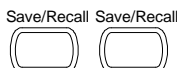

3. Press *Save All*. The following information will be saved.

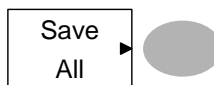

Setup file
(Axxx.set)

Two types of setups are saved: the current panel setting and the last internally saved settings (one of S1 ~ S15).

Display image
(Axxx.bmp)

The current display image in bitmap format.

Waveform data
(Axxx.csv)

Two types of waveform data are saved: the currently active channel data and the last internally saved data (one of W1 ~ W15).

4. Press Ink Saver repeatedly to invert the background color (on) or not (off) for the display image.



5. Press *Destination*.



USB

Save to the USB flash drive with a 4k waveform memory length.

6. Press *Save* to confirm saving. When completed, a message appears at the bottom of the display.

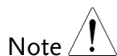
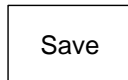

The file will not be saved if the power is turned off or the USB flash drive is removed from the USB port.

It takes approximately 1 min to save a 2M waveform to the USB drive in fast mode. Detailed mode may take over 10 times longer depending on the speed of the USB flash drive.

7. Together with the current setup/waveform/image, the last saved waveform file (one from W1 ~ W15) and setup file (one from S1 ~ S15) are also included in the folder.

File utilities

To edit the USB drive contents (create/ delete/ rename files and folders), press *File Utilities*. For details, see page 98.

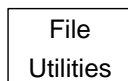





Recall

File type/source/destination

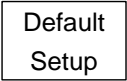
Item	Source	Destination
Default panel setup	<ul style="list-style-type: none"> Factory installed setting 	<ul style="list-style-type: none"> Current front panel
Reference waveform	<ul style="list-style-type: none"> Internal memory: A, B 	<ul style="list-style-type: none"> Current front panel
Panel setup (DSxxxx.set)	<ul style="list-style-type: none"> Internal memory: S1 ~ S15 External memory: USB flash drive 	<ul style="list-style-type: none"> Current front panel
Waveform data (DSxxxx.csv)	<ul style="list-style-type: none"> Internal memory: W1 ~ W15 External memory: USB flash drive 	<ul style="list-style-type: none"> Reference waveform A, B

Recalling the default panel settings

- Procedure
1. Press the Save/Recall key. 
 2. Press Default Setup. The factory installed setting will be recalled.  

Setting contents	The following is the default panel setting contents.	
Acquisition	Mode: Normal	
Channel	Coupling: DC	Invert: Off
		Probe attenuation: x1
	BW limit: Off	
Cursor	Source: CH1	Horizontal: None
	Vertical: None	
Display	Type: Vectors	Accumulate: Off
	Graticule: 	
Horizontal	Scale: 2.5us/Div	Mode: Main Timebase
Math	Type: + (Add)	Channel: CH1+CH2
	Position: 0.00 Div	Unit/Div: 2V
Measure	Item: Vpp, Vavg, Frequency, Duty cycle, Rise Time	
Trigger	Type: Edge	Source: Channel1
	Mode: Auto	Slope: 
	Coupling: DC	Rejection: Off
	Noise Rejection: Off	
Utility	SaveImage, InkSaver Off.	

Recalling a reference waveform to the display

Procedure The reference waveform must be stored in advance. See page 104 for details.

1. Press the Save/Recall key.



2. Press *Display Refs.* The reference waveform display menu appears.

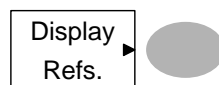

3. Select the reference waveform, *Ref A* or *Ref B*, and press it. The waveform appears on the display and the period and amplitude of the waveform appears in the menu.

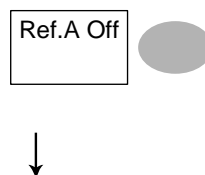

4. To clear the waveform from the display, press *RefA/B* again.

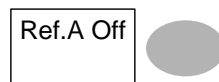

Recalling panel settings

- Procedure 1. (For recalling to USB) Insert the USB flash drive into the front panel USB port.

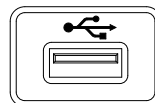

2. Press the Save/Recall key.



3. Press *Recall Setup*.

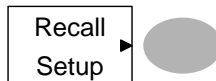

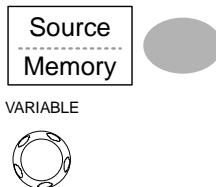

4. Press *Source* repeatedly to select the file source, internal or external memory. Use the Variable knob to change the memory.

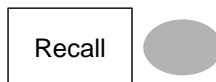

- Memory Internal memory, S1 ~ S15
- USB USB flash drive, DSXXXX.SET. The setup file(s) must be placed in the root directory to be recognized.

5. Press *Recall* to confirm recalling. When completed, a message appears at the bottom of the display.



Note  The file will not be recalled if the power is turned off or the USB flash drive is removed before completion.

File utilities

To edit the USB drive contents (create/ delete/ rename files and folders), press *File Utilities*. For details, see page 98.



Recalling a waveform

Procedure

1. (For recalling to USB) Insert the USB flash drive into the front panel USB port.
2. Press the Save/Recall key.

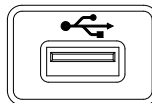

3. Press *Recall Waveform*. The display shows the available source and destination options.



4. Press *Source* repeatedly to select the file source, internal memory or USB. Use the Variable knob to change the memory location (W1 ~ W15)/DSXXXX.CSV.

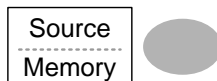

VARIABLE



- | | |
|--------|--|
| Memory | Internal memory, W1 ~ W15 |
| USB | USB flash drive, DSXXXX.CSV. The waveform file(s) must be placed in the root directory to be loaded. |

5. Press *Destination*. Use the Variable knob to select the memory location.



VARIABLE



- | | |
|---------|--|
| RefA, B | Internally stored reference waveforms A, B |
|---------|--|

6. Press *Recall* to confirm recalling. When completed, a message appears at the bottom of the display.



Note 

The file will not be recalled if the power is turned off or the USB flash drive is removed before completion.

File utilities

To edit the USB drive contents (create/ delete/ rename files and folders), press *File Utilities*. For details, see page 98.

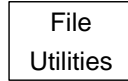

M AINTENANCE

Two types of maintenance operations are available: calibrating the vertical resolution, and compensating the probe. Run these operations when using the oscilloscope in a new environment.

Vertical Resolution Calibration

Procedure

1. Press the Utility key.



2. Press the *More* key twice.

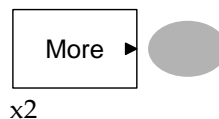

3. Press *Self Cal Menu*.

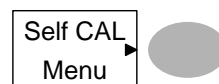

4. Press *Vertical*. The message "Set CAL to CH1, then press F5" appears at the bottom of the display.



5. Connect the calibration signal between the rear panel CAL out terminal and the Channel1 input.

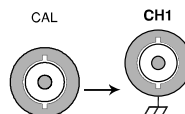

6. Press F5. The calibration automatically starts.

- The Channel1 calibration will complete in less than 5 minutes.

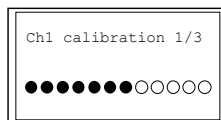

- When finished, connect the calibration signal to the Channel 2 input and repeat the procedure.



- When the calibration is complete the display will go back to the previous state.

Probe Compensation

Procedure

- Connect the probe between the Channel1 input and the probe compensation output (2Vp-p, 1kHz square wave) on the front panel. Set the probe voltage attenuation to x10.

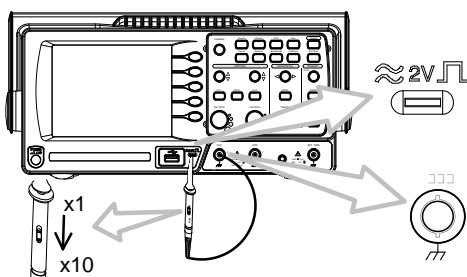

- Press the Utility key.



- Press *ProbeComp*.



4. Press *Wavetype* repeatedly to select the standard square wave.

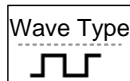

5. Press the Autoset key. The compensation signal will appear in the display.



6. Press the Display key, then Type to select the vector waveform.

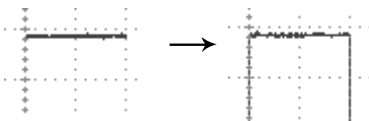
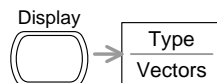

7. Turn the adjustment point on the probe until the signal edge becomes sharp.

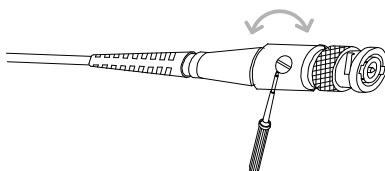
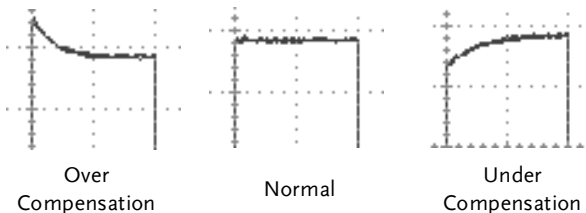

FAQ

- The input signal does not appear in the display.
- I want to remove some contents from the display.
- The waveform does not update (frozen).
- The probe waveform is distorted.
- Autoset does not catch the signal well.
- Autoset function cannot catch signals under 30mV or 30Hz. Please use the manual operation. See page45 for details.
- I want to clean up the cluttered panel settings.
- The accuracy does not match the specifications.

The input signal does not appear in the display.

Make sure you have activated the channel by pressing the CH key (page 44).

I want to remove some contents from the display.

To clear the math result, press the Math key again (page57).

To clear the cursor, press the Cursor key again (page 54).

To clear the Help contents, press the Help key again (page 43).

The waveform does not update (frozen).

Press the Run/Stop key to unfreeze the waveform. See page 46 for details. For trigger setting details, see page 83.

If this does not help, press the CH key. If the signal still does not appear, press the Autoset key.

The probe waveform is distorted.

You might need to compensate the probe. For details, see page 116. Note that the frequency accuracy and duty factor are not specified for probe compensation waveforms and therefore it should not be used for other reference purposes.

Autoset does not catch the signal well.

Autoset function cannot catch signals under 30mV or 30Hz. Please use the manual operation. See page 45 for details.

I want to clean up the cluttered panel settings.

Recall the default settings by pressing the Save/Recall key→Default Setting. For default setting contents, see page 42.

The saved display image is too dark on the background.

Use the Inksaver function which reverses the background color. For details, see page 105.

The accuracy does not match the specifications.

Make sure the device is powered on for at least 30 minutes, within +20°C~+30°C. This is necessary to stabilize the unit to match the specification.

For more information, contact your local dealer or GWInstek at www.gwinstek.com / marketing@goodwill.com.tw.

A PPENDIX

Fuse Replacement

- Procedure
1. Remove the power cord and remove the fuse socket using a minus driver.

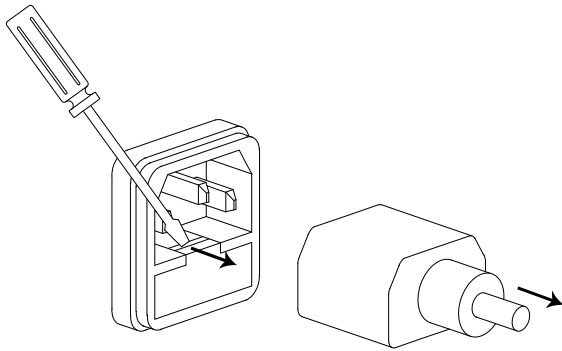

Replace the fuse in the holder.

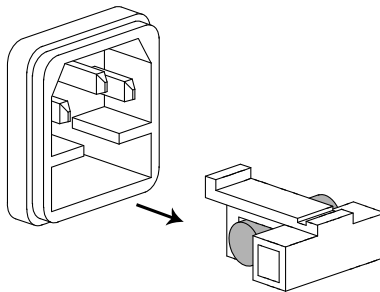

Ratings T1A, 250V

GDS-1000-U Series Specifications

The specifications apply when the oscilloscope is powered on for at least 30 minutes under +20°C~+30°C.

Model-specific specifications

GDS-1052-U	Bandwidth (-3dB)	DC coupling: DC ~ 50MHz AC coupling: 10Hz ~ 50MHz
	Bandwidth Limit	20MHz (-3dB)
	Trigger Sensitivity	0.5div or 5mV (DC ~ 25MHz) 1.5div or 15mV (25MHz~50MHz)
	External Trigger	~ 50mV (DC~25MHz)
	Sensitivity	~ 100mV (25MHz~50MHz)
	Rise Time	< 7ns approx.
GDS-1072-U	Bandwidth (-3dB)	DC coupling: DC ~ 70MHz AC coupling: 10Hz ~ 70MHz
	Bandwidth Limit	20MHz (-3dB)
	Trigger Sensitivity	0.5div or 5mV (DC ~ 25MHz) 1.5div or 15mV (25MHz~70MHz)
	External Trigger	~ 50mV (DC~25MHz)
	Sensitivity	~ 100mV (25MHz~70MHz)
	Rise Time	< 5ns approx.
GDS-1102-U	Bandwidth (-3dB)	DC coupling: DC ~ 100MHz AC coupling: 10Hz ~ 100MHz
	Bandwidth Limit	20MHz (-3dB)
	Trigger Sensitivity	0.5div or 5mV (DC ~ 25MHz) 1.5div or 15mV (25MHz~100MHz)
	External Trigger	~ 50mV (DC~25MHz)
	Sensitivity	~ 100mV (25MHz~100MHz)
	Rise Time	< 3.5ns approx.

Common specifications

Vertical	Sensitivity	2mV/div~10V/Div (1-2-5 increments)
	Accuracy	± 3% full scale
	Bandwidth	See model-specific specifications
	Rise Time	See model-specific specifications
	Input Coupling	AC, DC, Ground
	Input Impedance	1MΩ±2%, ~15pF
	Polarity	Normal, Invert
	Maximum Input	300V (DC+AC peak), CAT II
	Math Operation	+, -, FFT
Offset Range		2mV/div~50mV/div: ±0.4V
		100mV/div~500mV/div: ±4V
		1V/div~5V/div: ±40V
		10V/div : ±300V
Trigger	Sources	CH1, CH2, Line, EXT
	Modes	Auto, Normal, Single, TV, Edge, Pulse
	Coupling	AC, DC, LF rej, HF rej, Noise rej
	Sensitivity	See model-specific specifications
External trigger	Range	DC: ±15V, AC: ±2V
	Sensitivity	See model-specific specifications
	Input Impedance	1MΩ±2%, ~15pF
	Maximum Input	300V (DC+AC peak), CATII
Horizontal	Range	1ns/div~50s/div, 1-2.5-5 increment Roll: 50ms/div – 50s/div
	Modes	Main, Window, Window Zoom, Roll, X-Y
	Accuracy	±0.01%
	Pre-Trigger	10 div maximum
	Post-Trigger	1000 div
X-Y Mode	X-Axis Input	Channel 1
	Y-Axis Input	Channel 2
	Phase Shift	±3° at 100kHz
Signal Acquisition	Real-Time	250M Sa/s maximum
	Equivalent	25G Sa/s maximum
	Vertical	8 bits
	Resolution	
	Record Length	4k points maximum
	Acquisition	Normal, Peak Detect, Average
	Peak Detection	10ns (500ns/div ~ 50s/div)
Average	2, 4, 8, 16, 32, 64, 128, 256	

Cursors and Measurement	Voltage	Vpp, Vamp, Vavg, Vrms, Vhi, Vlo, Vmax, Vmin, Rise Preshoot/ Overshoot, Fall Preshoot/ Overshoot
	Time	Freq, Period, Rise Time, Fall Time, + Width, – Width, Duty Cycle
	Cursors	Voltage difference (ΔV) and Time difference (ΔT) between cursors
	Auto Counter	Resolution: 6 digits, Accuracy: $\pm 2\%$ Signal source: All available trigger source except the Video trigger
Control Panel Function	Autoset	Automatically adjust Vertical Volt/div, Horizontal Time/div, and Trigger level
	Save/Recall	Up to 15 sets of measurement conditions and waveforms
Display	LCD	5.7 inch, TFT, brightness adjustable
	Resolution (dots)	234 (Vertical) x 320 (Horizontal)
	Graticule	8 x 10 divisions
	Display Contrast	Adjustable
Interface	*USB Slave Connector	USB 2.0 full speed (CDC-ACM)
	*USB Host Connector	Image (BMP) and waveform data (CSV)
Probe Compensation Signal	Frequency range	1kHz ~ 100kHz adjustable, 1kHz step
	Duty cycle	5% ~ 95% adjustable, 5% step
	Amplitude	2Vpp $\pm 3\%$
Power Source	Line Voltage	100V~240V AC, 47Hz~63Hz
	Power Consumption	18W, 40VA maximum
	Fuse Rating	1A slow, 250V
Operation Environment	Relative humidity :	$\leq 80\%$, 40°C or below $\leq 45\%$, 41°C~50°C
	Altitude:	< 2000 meters
	Temperature :	0 ~ 50°C
Storage Environment	Storage temperature:	-10°C ~ 60°C, no condensation
	Relative humidity:	93% @40°C 65% @41°C ~ 60°C
Dimensions	310(W) x 142(H) x 140(D) mm	
Weight	Approx. 2.5kg	

* USB 3.0 & USB 3.1 not compatible

Probe Specifications

GDS-1052-U & GDS-1072-U Probe

Applicable model & probe	GDS-1052-U, GDS-1072-U GTP-070B-4	
Position x 10	Attenuation	10
	Bandwidth	DC ~ 70MHz
	Input Resistance	10M Ω (when used with oscilloscopes which have 1M Ω input)
	Input Capacitance	14.5~17.5pF
	Maximum Input Voltage	\leq 600V DC +ACpk
	Compensation Range	10~35pF
Position x 1	Attenuation	1
	Bandwidth	DC ~ 10MHz
	Input Resistance	1M Ω (oscilloscope input resistance)
	Input Capacitance	85~115pF
	Maximum Input Voltage	\leq 200V DC +ACpk
Operating Cond.	Temperature	-10°C ~ 50°C
	Humidity	\leq 85% (Relative Humidity)
Net Weight	<55g	
Length	130cm \pm 1.5cm	

GDS-1102-U Probe

Applicable model & probe	GDS-1102-U GTP-100B-4	
Position x 10	Attenuation	10
	Bandwidth	DC ~ 100MHz
	Input Resistance	10M Ω (when used with oscilloscopes which have 1M Ω input)
	Input Capacitance	14.5~17.5pF
	Maximum Input Voltage	\leq 600V DC +ACpk
	Compensation Range	5~30pF
Position x 1	Attenuation	1
	Bandwidth	DC ~ 10MHz
	Input Resistance	1M Ω (oscilloscope input resistance)
	Input Capacitance	85~115pF
	Maximum Input Voltage	\leq 200V DC +ACpk
Operating Cond.	Temperature	-10°C ~ 50°C
	Humidity	\leq 85% (Relative Humidity)
Net Weight	<55g	
Length	130cm \pm 1.5cm	

Dimensions

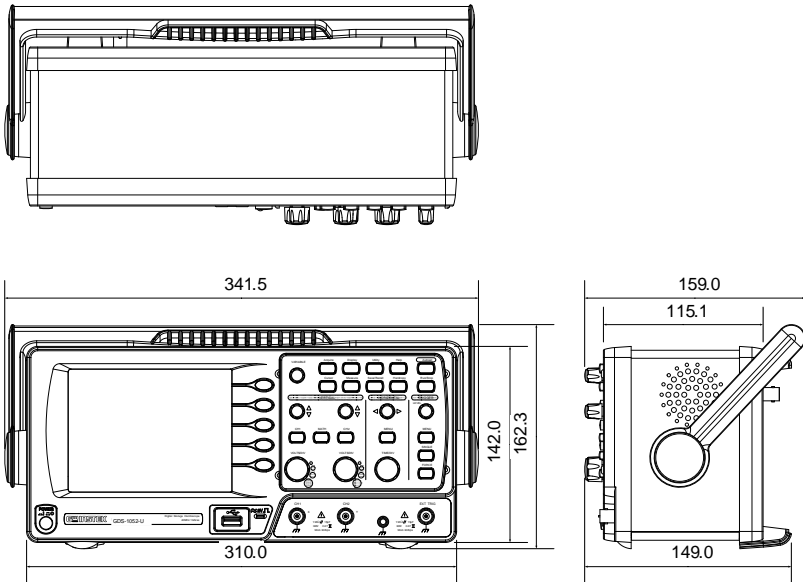

Declaration of Conformity

We

GOOD WILL INSTRUMENT CO., LTD.

declare that the below mentioned product

Type of Product: **Digital Storage Oscilloscope**

Model Number: **GDS-1102U, GDS-1072U, GDS-1052U**

are herewith confirmed to comply with the requirements set out in the Council Directive on the Approximation of the Law of Member States relating to Electromagnetic Compatibility (2014/30/EU) and Low Voltage Directive (2014/35/EU).

For the evaluation regarding the Electromagnetic Compatibility and Low Voltage Directive, the following standards were applied:

◎ EMC	
EN 61326-1: EN 61326-2-1:	Electrical equipment for measurement, control and laboratory use -- EMC requirements (2013)
Conducted & Radiated Emission EN 55011: 2009+A1:2010	Electrical Fast Transients EN 61000-4-4: 2012
Current Harmonics EN 61000-3-2: 2014	Surge Immunity EN 61000-4-5: 2006
Voltage Fluctuations EN 61000-3-3: 2013	Conducted Susceptibility EN 61000-4-6: 2014
Electrostatic Discharge EN 61000-4-2: 2009	Power Frequency Magnetic Field EN 61000-4-8: 2010
Radiated Immunity EN 61000-4-3: 2006 +A1:2008+ A2:2010	Voltage Dip/ Interruption EN 61000-4-11: 2004

◎ Safety

Low Voltage Equipment Directive 2014/35/EU	
Safety Requirements	EN 61010-1: 2010 (Third Edition) EN 61010-2-030: 2010 (First Edition)

GOOD WILL INSTRUMENT CO., LTD.

No. 7-1, Jhongsing Road, Tucheng Dist., New Taipei City 236, Taiwan

Tel: +886-2-2268-0389

Fax: +866-2-2268-0639

Web: www.gwinstek.com

Email: marketing@goodwill.com.tw

GOOD WILL INSTRUMENT (SUZHOU) CO., LTD.

No. 521, Zhujiang Road, Snd, Suzhou Jiangsu 215011, China

Tel: +86-512-6661-7177

Fax: +86-512-6661-7277

Web: www.instek.com.cn

Email: marketing@instek.com.cn

GOOD WILL INSTRUMENT EURO B.V.

De Run 5427A, 5504DG Veldhoven, The Netherlands

Tel: +31(0)40-2557790

Fax: +31(0)40-2541194

Email: sales@gw-instek.eu

INDEX

AC coupling	82	menu tree	25
Accumulating waveform	75	specification	124
Acquisition	71	Cycle time measure	52
menu tree	24	Data logging	
specification	123	menu tree	41
Addition	58	overview	67
Amplitude measure	51	run	70
auto set		setup	68
faq	118, 119	source	68
Auto set	45	DC coupling	81
exception	46	Declaration of conformity	128
specification	124	Default setup	110
Auto trigger	84	contents	42
Automatic measurement	53	menu tree	30
menu tree	29	Display	76
overview	51	contrast setting	76
specification	124	diagram	19
Average acquisition	72	grid setting	76
Average voltage measure	52	menu tree	26
Bandwidth limitation	82	specification	124
Blackman window	57	Display image	
Calibration		faq	119
menu tree	39	file format	95
Calibration, vertical resolution	115	save	105
Caution symbol	7	save menu tree	33
Channel	44	Disposal instructions	10
faq	118	Dot waveform	75
menu tree	24	Duty cycle measure	52
Cleaning the instrument	9	Edge trigger	86
configure remote control	92	menu tree	36
Coupling mode	81	EN61010	
menu tree	24	measurement category	8
cursor		pollution degree	10
horizontal operation	54	Environment	124
Cursor	54	safety instructions	9
faq	118	equivalent time sampling	74
		External trigger	84
		input terminal	16

Falling time measure.....	52	Ink saver	
Faq.....	119	in hardcopy.....	101
FFT.....	58	in save all.....	107
menu tree.....	28	Input frequency indicator.....	19
overview.....	57	Invert waveform.....	82
File format.....	95	Language selection.....	93
Firmware version.....	93	List of features.....	12
Flattop window.....	57	Low voltage measure.....	52
Force trigger.....	91	Math	
frequency		faq.....	118
cursor tracking.....	54	menu tree.....	27
Frequency measure.....	52	Measurement.....	44
Frequency rejection.....	86	Model comparison.....	12
Front panel diagram.....	14	Multiplication.....	58
Fuse replacement.....	121	Negative peak measure.....	51
safety instruction.....	9	Noise rejection.....	86
General purpose signal.....	49	Normal acquisition.....	71
Go-NoGo		Normal trigger.....	85
conditions.....	62	NTSC.....	85
menu tree.....	38	Operating environment.....	124
overview.....	60	Overshoot voltage measure.....	52
run.....	66	PAL.....	85
source.....	61	Peak detect acquisition.....	72
template.....	62	Peak to peak measure.....	51
when.....	61	Peak voltage measure.....	51
Ground		Power on/off	
coupling.....	81	safety instruction.....	9
symbol.....	7	switch overview.....	18
terminal.....	16	Preshoot voltage measure.....	52
Hanning window.....	57	probe	
Hardcopy.....	100	attenuation level.....	83
Hardcopy - Save All		Probe.....	116
menu tree.....	39	compensation menu tree.....	40
Hardcopy - Save image		compensation signal overview...	49
menu tree.....	39, 41	faq.....	119
Help.....	43	peak detect demonstration.....	72
faq.....	118	Pulse time measure.....	52
High voltage measure.....	52	Pulse width trigger.....	89
Horizontal.....	77	condition.....	85
basic operation.....	47	menu tree.....	36
cursor operation.....	54	real time sampling.....	74
menu tree.....	27	Rear panel diagram.....	18
position.....	77	Recall.....	109
scale.....	77	default setup.....	110
shortcut.....	27	menu tree.....	30
specification.....	123	reference waveform.....	111
IEC 1010-1.....	125, 126		

setup.....	111	edge	86
waveform.....	112	force	91
Rectangular window	57	indicator	84
Reference waveform		level knob.....	86
menu tree.....	31	menu tree	35
recall.....	111	parameter.....	84
Remote control interface.....	92	pulse width.....	89
Rising time measure.....	52	specification.....	123
roll mode.....	78	status indicator.....	19
Root mean square measure	52	video.....	88
Run/stop	46	UK power cord.....	11
faq.....	119	USB	
Save.....	102	file operation.....	98
display image.....	105	file utilities menu tree.....	34
menu tree.....	30	USB for remote control.....	92
setup.....	103	Utility	
specification.....	124	key overview	15
waveform.....	104	menu tree	37
Save all	107	Vector waveform.....	75
menu tree.....	34	Vertical	81
SECAM.....	85	basic operation	48
Security lock slot.....	18	cursor operation.....	55
Serial number	93	position.....	81
Service operation		resolution calibration.....	115
about disassembly.....	8	scale	81
contact.....	120	specification.....	123
Setting the handle	20	Video line	85
Setting up the oscilloscope	20	Video trigger.....	88
Setup		menu tree	35
default contents	42	voltage	
file format	97	cursor tracking	54
how to save.....	103	Warning symbol.....	7
recall.....	111	waveform	
recall menu tree	30	roll mode.....	78
save menu tree	32	zoom mode	79
Single trigger	91	Waveform	
Single trigger mode	85	file format.....	95
Specifications.....	122	invert waveform.....	82
faq.....	120	recall	112
Subtraction.....	58	recall menu tree.....	31
System information	93	save	104
time		save menu tree.....	32
cursor tracking.....	54	x-y mode	80
Timebase indicator	77	Waveform accumulation.....	75
Trigger.....	84	X-Y mode	80
coupling.....	86	specification.....	123
		zoom waveform	79