

# Spectrum Analyzer

GSP-730

---

## USER MANUAL

GW Part No. 82SP-73000M01



ISO-9001 CERTIFIED MANUFACTURER

**GW INSTEK**

This manual contains proprietary information, which is protected by copyright. All rights are reserved. No part of this manual may be photocopied, reproduced or translated to another language without prior written consent of Good Will company.

The information in this manual was correct at the time of printing. However, Good Will continues to improve products and reserves the rights to change specification, equipment, and maintenance procedures at any time without notice.

**Good Will Instrument Co., Ltd.**  
**No. 7-1, Jhongsing Rd., Tucheng Dist., New Taipei City 236, Taiwan.**

# Table of Contents

<b>SAFETY INSTRUCTIONS</b> .....	<b>3</b>
<b>GETTING STARTED</b> .....	<b>7</b>
GSP-730 Introduction .....	8
Appearance.....	10
First Time Use Instructions .....	17
<b>BASIC OPERATION</b> .....	<b>26</b>
Frequency Settings.....	28
Span Settings.....	31
Amplitude Settings .....	34
Autoset .....	36
Marker .....	38
Measurement.....	50
Limit Line Testing .....	57
Bandwidth.....	61
Trace.....	62
Display.....	67
Save/Recall Files .....	71
System Settings .....	76
<b>REMOTE CONTROL</b> .....	<b>78</b>
Interface Configuration .....	80
Configure Remote Interface .....	80
Command Syntax .....	82
Command List .....	85
<b>FAQ</b> .....	<b>104</b>
<b>APPENDIX</b> .....	<b>106</b>
GSP-730 Default Settings .....	106

GSP-730 Specifications ..... 108  
GSP-730 Dimensions ..... 110  
Declaration of Conformity ..... 111

**I**NDEX..... 112

# S SAFETY INSTRUCTIONS

This chapter contains important safety instructions that you must follow during operation and storage. Read the following before any operation to insure your safety and to keep the instrument in the best possible condition.

## Safety Symbols

These safety symbols may appear in this manual or on the instrument.

---



WARNING

Warning: Identifies conditions or practices that could result in injury or loss of life.



CAUTION

Caution: Identifies conditions or practices that could result in damage to the instrument or to other properties.



DANGER High Voltage



Attention Refer to the Manual



Earth (ground) Terminal



Frame or Chassis Terminal



Do not dispose electronic equipment as unsorted municipal waste. Please use a separate collection facility or contact the supplier from which this instrument was purchased.

## Safety Guidelines

---

### General Guideline



#### CAUTION

- Do not place any heavy object on the instrument.
- Avoid severe impact or rough handling that leads to damaging the instrument.
- Do not discharge static electricity to the instrument.
- Use only mating connectors, not bare wires, for the terminals.
- Ensure signals to the RF input do not exceed +30dBm/±25V DC.
- Do not block the cooling fan opening.
- Do not disassemble the instrument unless you are qualified.

(Measurement categories) EN 61010-1:2010 specifies the measurement categories and their requirements as follows. The instrument falls under category II.

- Measurement category IV is for measurement performed at the source of low-voltage installation.
- Measurement category III is for measurement performed in the building installation.
- Measurement category II is for measurement performed on the circuits directly connected to the low voltage installation.
- Measurement category I is for measurements performed on circuits not directly connected to Mains.

---

### Power Supply



#### WARNING

- AC Input voltage range: 100V~240V
  - Frequency: 50/60Hz
  - To avoid electrical shock connect the protective grounding conductor of the AC power cord to an earth ground.
-

- Cleaning
- Disconnect the power cord before cleaning.
  - Use a soft cloth dampened in a solution of mild detergent and water. Do not spray any liquid.
  - Do not use chemicals containing harsh material such as benzene, toluene, xylene, and acetone.
- 

- Operation Environment
- Location: Indoor, no direct sunlight, dust free, almost non-conductive pollution (Note below)
  - Temperature: 5°C to 45°C
  - Humidity: 90% @ 45°C
- (Pollution Degree) EN 61010-1:2010 specifies the pollution degrees and their requirements as follows. The instrument falls under degree 2.
- Pollution refers to “addition of foreign matter, solid, liquid, or gaseous (ionized gases), that may produce a reduction of dielectric strength or surface resistivity”.
- Pollution degree 1: No pollution or only dry, non-conductive pollution occurs. The pollution has no influence.
  - Pollution degree 2: Normally only non-conductive pollution occurs. Occasionally, however, a temporary conductivity caused by condensation must be expected.
  - Pollution degree 3: Conductive pollution occurs, or dry, non-conductive pollution occurs which becomes conductive due to condensation which is expected. In such conditions, equipment is normally protected against exposure to direct sunlight, precipitation, and full wind pressure, but neither temperature nor humidity is controlled.
- 

- Storage environment
- Location: Indoor
  - Temperature: -20°C to 60°C; <60°C/70% RH
- 

Disposal



Do not dispose this instrument as unsorted municipal waste. Please use a separate collection facility or contact the supplier from which this instrument was purchased. Please make sure discarded electrical waste is properly recycled to reduce environmental impact.

## Power cord for the United Kingdom

When using the instrument in the United Kingdom, make sure the power cord meets the following safety instructions.

**NOTE:** This lead/appliance must only be wired by competent persons

 **WARNING: THIS APPLIANCE MUST BE EARTHED**

**IMPORTANT:** The wires in this lead are coloured in accordance with the following code:

Green/ Yellow:	Earth
Blue:	Neutral
Brown:	Live (Phase)



As the colours of the wires in main leads may not correspond with the coloured marking identified in your plug/appliance, proceed as follows:

The wire which is coloured Green & Yellow must be connected to the Earth terminal marked with either the letter E, the earth symbol  or coloured Green/Green & Yellow.

The wire which is coloured Blue must be connected to the terminal which is marked with the letter N or coloured Blue or Black.

The wire which is coloured Brown must be connected to the terminal marked with the letter L or P or coloured Brown or Red.

If in doubt, consult the instructions provided with the equipment or contact the supplier.

This cable/appliance should be protected by a suitably rated and approved HBC mains fuse: refer to the rating information on the equipment and/or user instructions for details. As a guide, a cable of 0.75mm<sup>2</sup> should be protected by a 3A or 5A fuse. Larger conductors would normally require 13A types, depending on the connection method used.

Any exposed wiring from a cable, plug or connection that is engaged in a live socket is extremely hazardous. If a cable or plug is deemed hazardous, turn off the mains power and remove the cable, any fuses and fuse assemblies. All hazardous wiring must be immediately destroyed and replaced in accordance to the above standard.



# G E T T I N G S T A R T E D

This chapter provides a brief overview of the GSP-730, the package contents, instructions for first time use and an introduction to the front panel, rear panel and GUI.

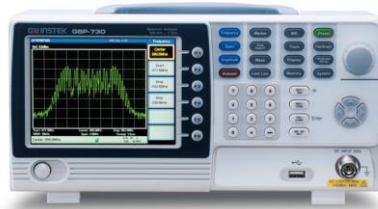

---

GSP-730 Introduction .....	8
Main Features.....	8
Package Contents .....	9
Appearance .....	10
GSP-730 Front Panel .....	10
Rear Panel.....	14
Display.....	15
First Time Use Instructions .....	17
Tilting the Stand .....	17
Power UP and Down .....	18
Software Update.....	19
USB Driver Installation.....	20
Restoring Default Settings.....	21
Conventions .....	22

## GSP-730 Introduction

The GSP-730 is a low-cost, basic spectrum analyzer. The GSP-730 has all the basic features of our more advanced models, but in a smaller package, designed especially for education.

### Main Features

---

Performance	<ul style="list-style-type: none"><li>• 150kHz~3GHz bandwidth</li><li>• 100kHz resolution</li></ul>
Features	<ul style="list-style-type: none"><li>• Autoset with automatic floor level and span.</li><li>• Marker table function</li><li>• Limit line testing</li><li>• Split window display</li><li>• ACPR measurement</li><li>• OCBW measurement</li><li>• Automatic resolution bandwidth mode.</li></ul>
Interface	<ul style="list-style-type: none"><li>• 480×640 color LCD display</li><li>• On-screen menu icons</li><li>• VGA video output</li><li>• RS-232C</li><li>• USB 2.0 Host port for data storage</li><li>• USB 2.0 Device port for the virtual com port communication</li></ul>

## Package Contents

Check the contents before using the GSP-730.

---

Opening the box

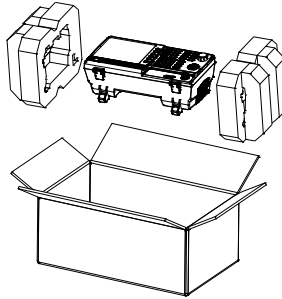

Contents  
(single unit)



- Main unit
- Quick Start Guide
- User Manual CD
- Power cord x1 (region dependent)
- Calibration certificate

# Appearance

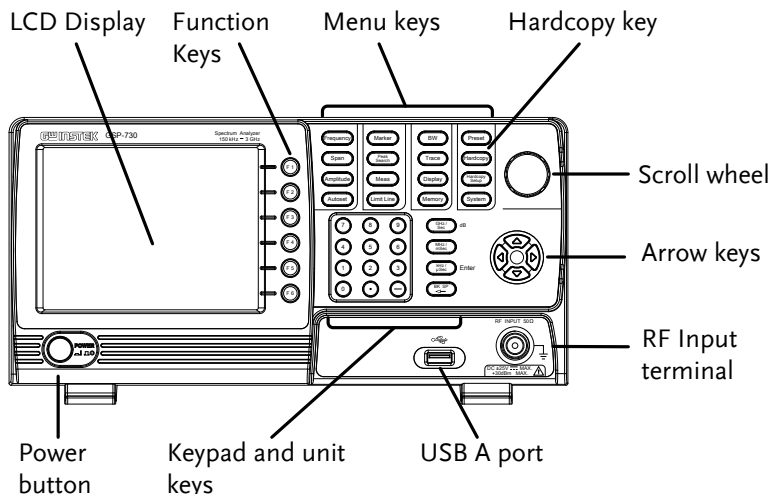
## GSP-730 Front Panel







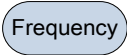





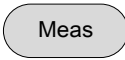
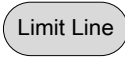

**LCD display**      640 X 480 color LCD display. The display shows the soft keys for the current function, frequency, amplitude and marker information.

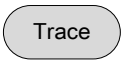
**Function keys**       ~  The F1 to F6 function keys directly correspond to the soft keys on the right-hand side of display.

**Frequency**       Sets the center frequency, start frequency, stop frequency and step frequency.

**Span**       Sets the span, with options for full span, zero span and last span.

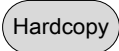
Amplitude		Sets the amplitude reference level, scale and amplitude units.
Autoset		Automatically searches the peak signal with maximum amplitude and displays it with appropriate horizontal and vertical scales.
<hr/>		
Marker		The Marker key is used to configure the markers, trace markers as well as other related functionality.
Peak Search		Finds each maximum and minimum peak. Used with the Marker functions.
Meas		Configures ACPR and OCBW measurements.
Limit Line		Sets and tests Pass/Fail limit lines.
BW		Sets the resolution bandwidth.
Trace		Sets traces and trace related functions.
Display		The Display key configures the split-screen windowing mode and the basic display properties.
Memory		The memory key is used to save or recall setup, trace and limit line data.

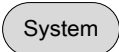
Preset		The <i>Preset</i> key will restore the spectrum analyzer to the factory settings.
Hardcopy		The hardcopy key is a quick save key that will save a screen-shot of the display.
Hardcopy setup		Configures the hardcopy options.
System		The System key is used to configure the RS232 interface, language, update the firmware as well as other system options.

Power key  Turns the instrument on/off.

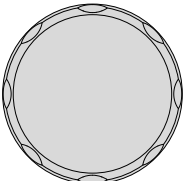
Scroll wheel  Edit values, select listed items.

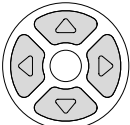
Arrow keys  Increment/decrement values (in steps), select listed items.

RF input terminal

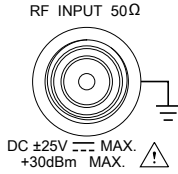

RF input port. Accepts RF inputs.

- Maximum input: +30dBm (+20dBm measurable)
- Input impedance: 50Ω
- Maximum DC voltage: ±25V
- N-type: female

Numeric keypad

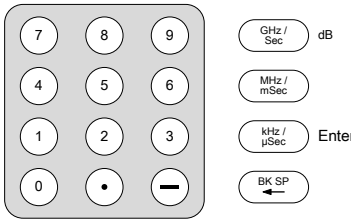

The numeric keypad is used to enter values and parameters. It is often used in conjunction with the arrow keys and scroll wheel.

USB A, Micro SD



USB A port for saving/recalling settings/files to external memory. Only supports FAT/FAT32 formatting.

Rear Panel

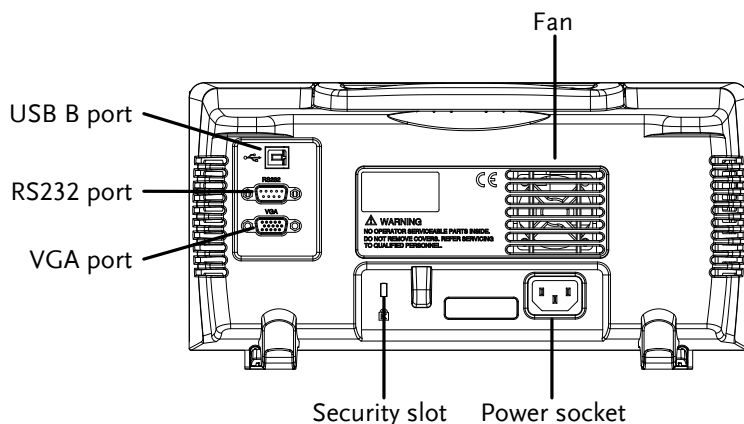

RS232

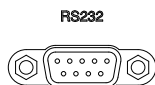

RS232 9 pin DSUB port.

USB B

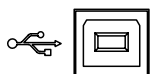

USB B Device port. USB 1.1/2.0

VGA



VGA video-out port. Supports SVGA (480X640)

Fan

Power Socket

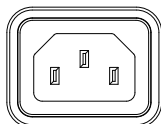

Power Socket:  
100~240V, 50/60Hz.  
15W Max

Security Slot



Kensington-type security slot.





## Display

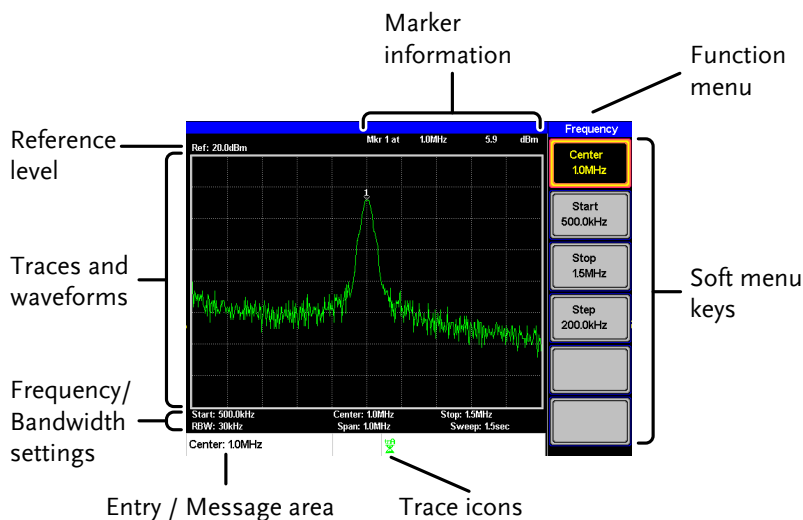

- Reference level      Displays the reference level. For details, see page 34.
  
- Marker information      Displays marker information. For details see page 38.
  
- Function menu      Displays the current function menu.
  
- Soft menu keys      The Soft menu keys are associated with the F1 to F6 function keys to the right of the display.
  
- Trace Icons      Displays the color of each active trace and the trace mode of each active trace. See page 62 for more information about traces.
  
- Entry/Message area      This area is used to show system messages, errors and input values/parameters.

Frequency/  
Bandwidth  
settings

Displays the Start, Center and Stop frequencies, RBW, Span and Sweep settings.

Trace and  
waveforms

Main display showing the traces (page 62), limit lines (57) and marker positions (38).

## First Time Use Instructions

Use the procedures below when first using the GSP-730 to tilt the stand, power up the instrument, update the firmware and restore the unit back to the default settings. Lastly, the Conventions sections will introduce you to the basic operating conventions used throughout the user manual.

### Tilting the Stand

---

**Description** The GSP-730 has two adjustable tabs at the front that can be used to position the instrument into two preset orientations.

**Leaning Position** Set the tabs down to have the GSP-730 leaning backward.

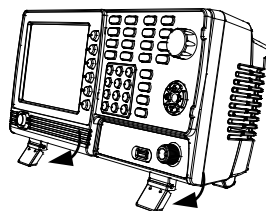

**Upright Position** Set the tabs flat to have the GSP-730 in an upright position.

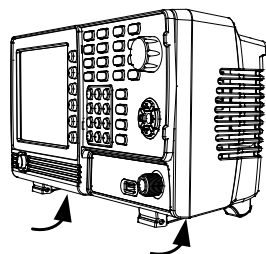

## Power UP and Down

---

### Power Up

1. Insert the AC power cord into the power socket.

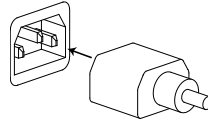

2. Press the power button to turn the GSP-730 on.

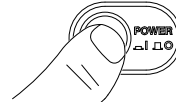

3. The GSP-730 will begin to boot up in under a few seconds.



### Note

If system fails to start, please see your local GW Instek distributor.

---

### Power Down

1. Press the power button to power down.

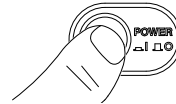

## Software Update

---

**Description** The GSP-730 allows the software to be updated by end-users. Before using the GSP-730, please check the GW Instek website or ask your local distributor for the latest software.

The update file, MAIN1.BIN, must be placed in the root directory of a USB flash drive.

---

**System version** Before updating the software, please check the software version.

1. Press  > *Information* [F4].
2. The system version is displayed on the SW Ver [F4] icon.

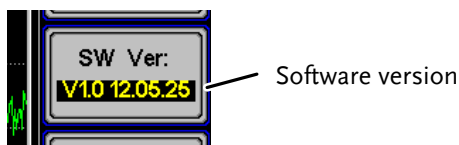

- Update software**
1. Place the update file, MAIN1.BIN, into the root directory of a USB flash drive.
  2. Insert the USB flash drive into the USB port on the front panel.
  3. Press  > *Update From USB Flash* [F5].
  4. Press *Update Now* [F3] to execute the update process.
    - *When the message "Programmed Successful" is displayed, the software has successfully completed the update procedure.*

5. Reboot the system when the update procedure has finished by cycling the power button.
6. Check the software version again to confirm the update procedure.



Note

The upgrade process may take a few minutes.

## USB Driver Installation

Description	If the type B USB port on the rear panel is to be used for remote control, then the USB driver must be installed. The USB driver is located in the CD that accompanied this manual.
-------------	-------------------------------------------------------------------------------------------------------------------------------------------------------------------------------------

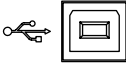
- Driver installation
1. Ensure the GSP-730 is turned on.
  2. Connect the USB cable from the PC to the rear panel USB B port. 
  3. Windows will automatically detect the GSP-730 as a new device.
  4. Follow the instructions to locate the GSP-730 driver on the accompanying CD and install the driver.
  5. To see if the driver has been successfully installed, you can check to see if the GSP-730 is recognized by the Windows Device Manager when the GSP-730 is connected to the PC.

In Windows XP go to: Start>Control Panel>Device Manager.

The GSP-730 should be shown under the Ports (COM & LPT) node:



Note

If the USB driver installation fails, you can try to manually install the driver.

You can tell that the driver hasn't been installed if you see the AT91USBSerial icon in the ports node.

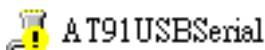

Right clicking this icon will allow you to manually install the GSP-730.ini driver.

## Restoring Default Settings

Description	The factory default settings can be easily restored using the Preset key on the front panel. The default settings cannot be changed. See page 106 for a list of the factory default settings.
Steps	<ol style="list-style-type: none"> <li>1. Press  . <ul style="list-style-type: none"> <li>• <i>The spectrum analyzer will load the default factory settings.</i></li> </ul> </li> </ol>

## Conventions

The following conventions are used throughout the user manual. Read the conventions below for a basic grasp of how to operate the GSP-730 menu system and front panel keys.

**Soft Menu keys** The F1 to F6 function keys on the right side of the display correspond directly to the soft-menu keys on their left.

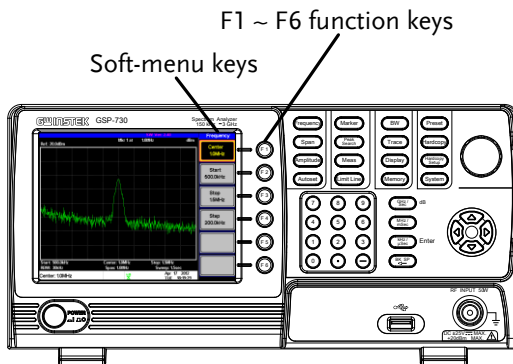

**Input Parameter Values**



Selecting this type of menu key will allow you to enter a new value with the numeric keypad or increment/decrement the value using the scroll wheel or number pad. See the parameter input description below for more details.



Toggle State



Pressing this menu key will toggle the state. Notice that any soft-menu key that can be toggled will have the active parameter underlined.

Toggle State &  
Input Parameter



Pressing this menu key will allow you to toggle the state of the function between on and off. When in the on-state, the parameter value can be manually edited. Use the numeric keypad to enter the new value or use the scroll wheel to increment/decrement the current value. Again, the setting that is underlined is the active setting.

Sub Menu



Pressing the *More* menu key will enter a submenu.

Sub Menu to  
select parameter



Pressing this type of menu key will enter a submenu to select a parameter.

Return to the Start of a Menu Tree.

When you have navigated down a menu tree and you wish to return to the start of the menu tree, simply press the same Menu again.

For example if you pressed:

**Trace** > *More*[F6] > *Min Hold*[F2],

simply press **Trace** again to return to the start of the Trace menu.

Active Function



Pressing this type of menu key will activate that function. The menu key will be highlighted to show it is the active function.

Parameter input

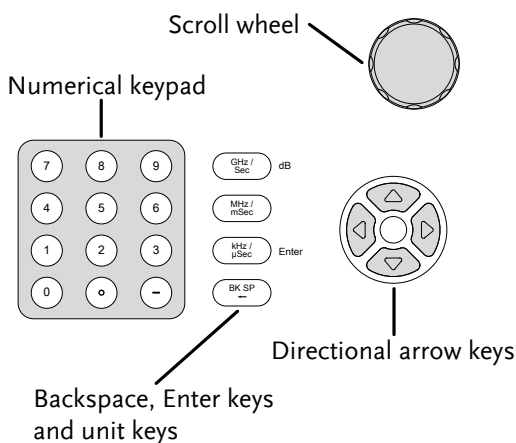

Parameter values can be entered using the numeric keypad, the scroll wheel and the arrow keys.

Using the numeric keypad

When prompted to enter a parameter, use the number keys (0~9), the decimal key (.) and the minus key (-) to enter a value. After a value has been entered, the unit keys can be used to select the units.

The value of the parameter is shown at the bottom of the screen as it is edited.

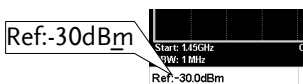

Edited parameter

Back Space

Use the backspace key to delete the last character or number entered.

Using the scroll wheel

Use the scroll wheel to alter the current value. Clockwise increases the value, anti-clockwise decreases the value. The scroll wheel is usually used for values that highly variable, such as the center frequency settings.

Directional arrows

Use the directional arrows to select discrete parameters or to alter values by a coarser resolution than the scroll wheel. Left/down decreases the value, right/up increases the value. The directional arrows are usually used for values that are of a discrete nature, such as selecting a memory location.

# BASIC OPERATION

---

Frequency Settings .....	28
Center Frequency .....	28
Start and Stop Frequency .....	29
Center Frequency Step .....	30
Span Settings .....	31
Span .....	31
Full Span .....	32
Zero Span .....	32
Last Span .....	33
Amplitude Settings .....	34
Reference Level .....	34
Amplitude Units .....	35
Scale/Div .....	35
Autoset .....	36
Using Autoset .....	36
Limiting the Autoset Vertical Search Range .....	37
Limiting the Autoset Horizontal Search Range .....	37
Marker .....	38
Activating a Marker .....	39
Move Marker to Trace .....	43
Show Markers in Table .....	44
Peak Search .....	46
Peak Table .....	48
Measurement .....	50
Channel Analysis Overview .....	50
Limit Line Testing .....	57
Activate a Limit Line .....	57
Creating a Limit (Point by Point) .....	58
Bandwidth .....	61
Resolution Bandwidth Setting (RBW) .....	61
Trace .....	62
Selecting a Trace .....	62
Trace Math .....	64

Average Trace .....	65
<b>Display .....</b>	<b>67</b>
Adjusting the LCD Brightness.....	67
Setting a Display Line (Reference Level Line).....	67
Using the Video Out Port .....	68
Split Spectrum View .....	68
<b>Save/Recall Files .....</b>	<b>71</b>
Save/Recall Setup.....	71
Save/Recall Trace Data.....	72
Save/Recall Limit Lines .....	73
Saving an Image File (Hardcopy).....	73
Load Default Settings.....	75
<b>System Settings .....</b>	<b>76</b>
System Information .....	76
System Language .....	77

# Frequency Settings

## Center Frequency

**Description**                      The center frequency function sets the center frequency and centers the display to the center frequency.

**Operation**                      1. Press **Frequency** > **Center[F1]** and enter the frequency and unit.

Range:                                      0kHz~3GHz  
 Default                                      1.5GHz

### Display

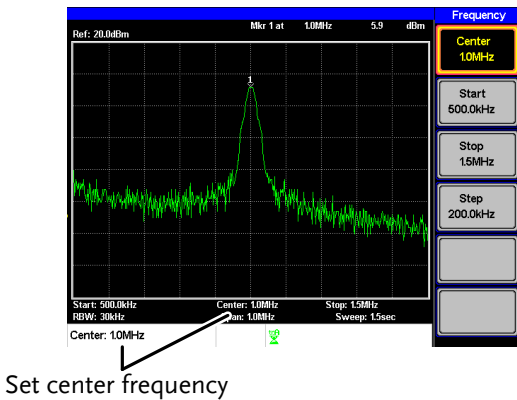

## Start and Stop Frequency

**Description** The start/stop frequency function will set the start and stop frequency of the span.

- Operation**
1. To set the start frequency, press **Frequency** > *Start*[F2] and enter the frequency and unit.
  2. To set the stop frequency, press **Frequency** > *Stop*[F3] and enter the frequency and unit.

Range: 0kHz~3GHz  
 Default Start frequency: 0Hz  
 Default Stop frequency: 3GHz

**Display**

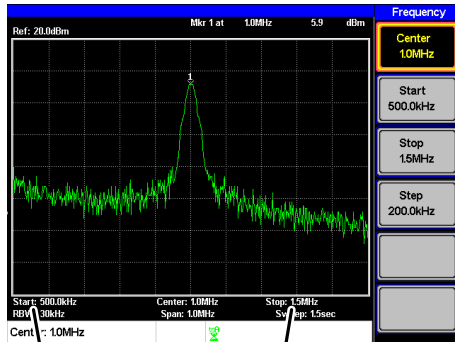

Start Frequency

Stop Frequency

 **Note**

The start and stop frequency can change when the span settings are used.  
 The stop frequency must be set higher than the start frequency (for spans  $\neq$  0).

## Center Frequency Step

**Description**                      The *Step* function sets the step size of the center frequency when using the arrow keys.

When the arrow keys are used to alter the center frequency, each press will move the center frequency by the step size specified by the *Step* function.

By default, the center frequency step size is equal to 10% of the span.

**Operation**                      1. Press **Frequency** > *Step*[F4] and set the center frequency step size.

Range:                                      1Hz~3GHz

**Display**

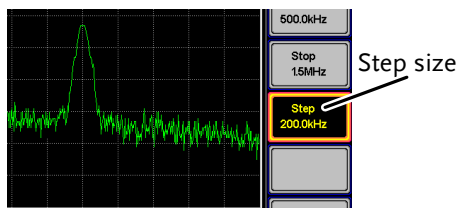



# Span Settings

## Span

**Description**                      The Span function will set the frequency range of the sweep. The sweep will be centered around the center frequency.

Setting the span will alter the start and stop frequencies.

**Operation**                      1. Press **Span** > *Span*[F1] and enter the span frequency range and unit.

Range:                                      0kHz~3GHz  
 Default Span:                          3GHz

## Display

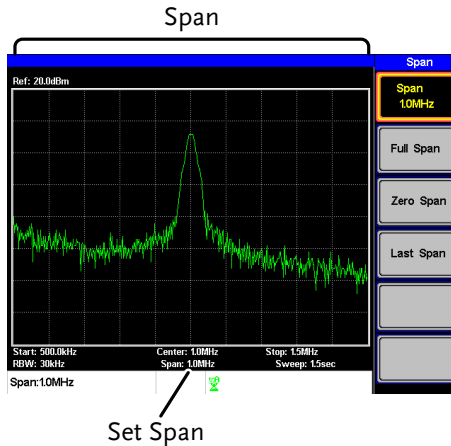

## Full Span

---

**Description**                      The Full Span function will set the span to the full frequency range.

                                         This function will set the start and stop frequencies to 0Hz and 3GHz respectively.

---

**Operation**                      1. Press  > *Full Span*[F2].

## Zero Span

---

**Description**                      The Zero Span function will set the frequency range of the sweep to 0Hz and fixes the start and stop frequencies to the center frequency. The Zero Span function measures the time domain characteristics of the input signal at the center frequency. The horizontal axis is displayed in the time domain.

---

**Operation**                      1. Press  > *Zero Span*[F3].

                                         The span changes accordingly.

Display

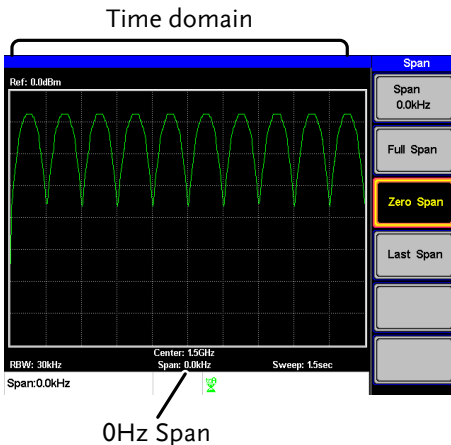

Example: Amplitude modulation



Note

The measurement functions such as ACPR and OCBW are not available with the zero span setting:

## Last Span

---

Description

The last span function returns the spectrum analyzer to the previous span settings.

Operation

1. Press Span > *Last Span*[F4].

## Amplitude Settings

The vertical display scale is defined by the reference level amplitude, attenuation, scale and external gain/loss.

### Reference Level

---

**Description**                      The reference level defines the absolute level of the amplitude on the top graticule in voltage or power.

---

**Operation**                      1. Press **Amplitude** > *Ref. Level*[F1] and enter the reference level amplitude.

Range:                                -20dBm ~ 20dBm  
 Resolution:                        10dBm

**Display**                            Ref Level reading

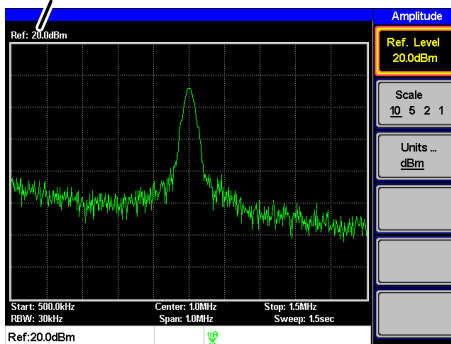

## Amplitude Units

**Description** The amplitude units can be set from dBm, dBmV or dBuV.

1. Press **Amplitude** > *Units ...*[F3] to change the amplitude units.

Units: dBm, dBmV, dBuV

## Scale/Div

**Description** Sets the logarithmic units for the vertical divisions.

- Operation**
1. Press **Amplitude** > *Scale*[F2] repeatedly to select the vertical division units.

Scale Range: 10, 5, 2, 1

**Display**

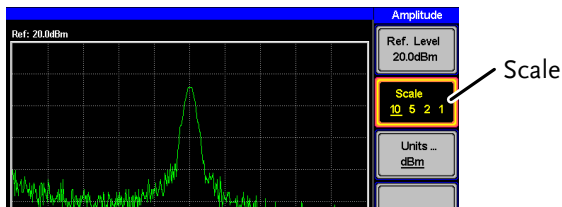





Note

RBW setting is reset to Auto when the Autoset function is used.

## Limiting the Autoset Vertical Search Range

---

Description	You can set the amplitude floor so that the signals lower than the setting will be ignored by the Autoset search.
Operation	<ol style="list-style-type: none"> <li>1. Press  &gt; <i>Amp.Floor[F2]</i> and switch the range from Auto to Man.</li> <li>1. Enter the amplitude limit with the number pad and Enter key.</li> </ol> <p>Range: -50 to +20dBm</p>



Note

See page 35 for setting the amplitude units.

## Limiting the Autoset Horizontal Search Range

---

Description	You can change the frequency span limit in the display to get a better view of the Autoset result. By default, the frequency span after Autoset is set at 3MHz.
Operation	<ol style="list-style-type: none"> <li>1. Press  &gt; <i>Span[F3]</i> and switch the range from Auto to Man.</li> <li>2. Enter the span frequency for the Autoset search.</li> </ol> <p>Manual Range: full amplitude range.</p>

## Marker

A Marker shows the frequency and amplitude of a waveform point. The GSP-730 can activate up to 5 markers or marker pairs simultaneously.

The marker table and peak table functions help editing and viewing multiple markers in a single display.

The delta marker function allows you to see the frequency and amplitude differences between reference markers.

The GSP-730 can automatically move a marker to various locations including the peak signal, center frequency, and start/stop frequency. Other marker operations regarding signal peaks are available in the Peak Search function.

- Activating a Marker → from page 39
- Activate a Delta Marker → from page 40
- Move Marker Manually → from page 41
- Move Marker to Preset Locations → from page 42
- Move Marker to Trace → from page 43
- Turn All Markers On or Off → from page 44
- Show Markers in Table → from page 44
- Peak Search → from page 46
- Move Marker to Peak → from page 46
- Move Marker and Peak to Center → from page 46
- Search for Peaks → from page 47
- Peak Table → from page 48



## Activating a Marker

There are two basic marker types, normal markers and delta markers. Normal markers are used to measure the frequency/time or amplitude of a point on the trace. Delta markers are used to measure the difference between a reference point and a selected point on the trace.

### Activate a Normal Marker

- Operation
1. Press **Marker** > **Marker[F1]** and select a marker number.  
  
Marker: 1~5
  2. Press **[F2]** to turn the selected marker on.
  3. Press **Mode[F3]** and set the marker mode to Normal.
  4. The display will show the marker on the trace (centered by default) with the marker measurement at the top of the display.

Marker No., Frequency, Amplitude

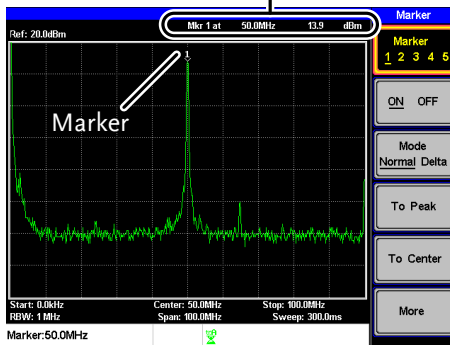

## Activate a Delta Marker

---

Description	<p>Delta markers are marker pairs that measure the difference in frequency and amplitude between a reference marker and a delta marker.</p> <p>When delta markers are activated, the reference and delta marker appear at the position of the selected marker, or in the center of the display if the selected marker has not yet be activated.</p> <p>The marker measurement is located at the top of the display, under the “normal marker” measurement.</p>
Delta Markers	<p>Ref:           Reference marker, designated as <math>\overset{1}{\downarrow}</math>.</p> <p>Delta:         Delta marker, designated as <math>\overset{\uparrow}{1}</math>.</p>
Operation	<ol style="list-style-type: none"> <li>1. Press  &gt; <i>Marker</i>[F1] and select a marker number.</li> <li>2. Press [F2] to turn the selected marker on.</li> <li>3. Press <i>Mode</i>[F3] to set the mode to Delta to activate the delta marker.</li> </ol>

Delta maker No., Frequency, Amplitude

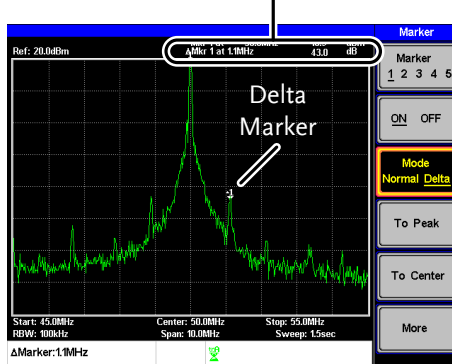

### Move Marker Manually

#### Operation

1. Press **Marker** > *Marker[F1]* and select a marker number.
2. Use the left/right arrow keys to move the marker one screen division at a time or the use the scroll wheel to move the marker in fine increments (one pixel at a time).
3. Alternatively, the numeric keypad can be used to directly enter the frequency of the marker position.

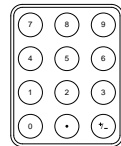

## Move Marker to Preset Locations

---

Preset conditions      The currently selected marker (normal marker or delta marker) can be moved to a number of preset positions:

Center:	Move to center frequency.
Peak	Move to the highest peak.
Start:	Move to start frequency.
Stop:	Move to stop frequency.
Step:	Move to step frequency.
Ref. Level:	Move to reference level amplitude.

---



Note

When a marker is moved to a preset position the span and other settings may be automatically changed.

---

Move marker to peak:

Press  > *To Peak*[F4].

---

Move marker to center:

Press  > *To Center*[F5].

---

Move marker to other positions

Press  > *More*[F6]>*Marker to ...*[F4] and select one of the preset positions:

*Marker to Start*[F2]

*Marker to Stop*[F3]

*Marker to Step*[F4]

*Marker to Ref. Level*[F5]

## Move Marker to Trace

**Description** The Marker Trace function moves the selected marker to the currently active trace.

- Operation**
1. Press **Marker** > *Marker[F1]* and select a marker number.
  2. Press *More[F6]>Marker Trace* and select a trace to assign the selected marker to. If *Auto* is selected, the selected marker is automatically assigned a trace.

*Marker Trace:* Auto, A, B, C

3. In the example below, marker 1 is set to trace B.

Marker 1, Trace B

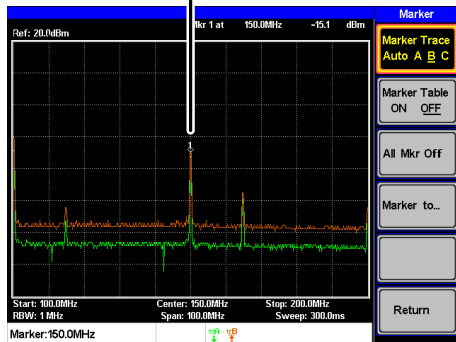

## Turn All Markers On or Off

**Description** All markers that have been activated, both normal and delta markers, can be turned off at the same time with the All Mrk Off function.

**Operation** Press **Marker** > *Marker[F1]* > *More[F6]* > *All Mrk Off[F3]* and turn all the markers off.

## Show Markers in Table

**Description** The GSP-730 has a Marker Table function to show all the active markers and measurements at once.

- Operation**
1. Press **Marker** > *Marker[F1]* > *More[F6]* > *Marker Table[F2]* and turn the marker table on.
  2. The display will split into two screens. The bottom half will show the Marker Table with the marker No. (normal, reference or delta), frequency and the amplitude of the marker.

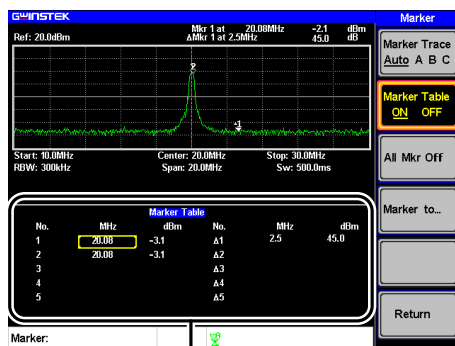

Marker Table

## Edit Markers in Marker Table

Description While the Marker Table function is the active function, the position of each marker and delta marker can be edited within the marker table.

1. Use the arrow keys to move the cursor to the frequency column of the desired marker.

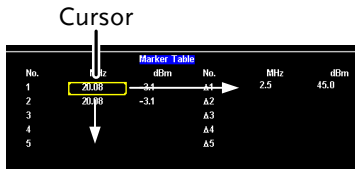



2. Enter the new position of the marker using the keypad and units keys.

## Peak Search

The Peak Search key is used to find trace peaks. The currently active marker is used in conjunction with the peak functions to mark the peaks that are found. Peaks can be sorted by frequency or amplitude in the peak table.



### Move Marker to Peak

---

Description	Move the active marker to the highest peak. The highest peak can be either found once or continuously.
Operation	<ol style="list-style-type: none"> <li>1. Press  &gt; <i>Marker[F1]</i> and select a marker number.</li> <li>2. Press  &gt; <i>Peak Search[F1]</i>. The marker will move to the highest signal peak.</li> <li>3. To continually search for the peak each sweep, press,  &gt; <i>More[F6]</i> &gt; <i>Peak Track[F1]</i> and set <i>Peak Track</i> to ON.</li> </ol>

### Move Marker and Peak to Center

---

Description	The <i>Peak to Center</i> function moves the marker to the highest signal peak and moves the center frequency to that peak.
Operation	<ol style="list-style-type: none"> <li>1. Press  &gt; <i>Select Marker[F1]</i> and select a marker number.</li> <li>2. Press  &gt; <i>Peak to Center[F5]</i>.</li> </ol>



Note

The span will not be changed.



## Search for Peaks

Description The **Peak Search** key can be used to search for a number of different peaks.

Peak Search	Next Peak:	Searches for next highest peak visible on the display.
	Next Peak Right:	Searches for the next peak to the right of the marker.
	Next Peak Left:	Searches for the next peak to the left of the marker.
	Min Search:	Searches for the lowest peak.

- Operation
1. Press **Marker** > *Select Marker[F1]* and select a marker number.
  2. Press **Peak Search** and select the type of peak you wish to find.

Example:  
Next Peak

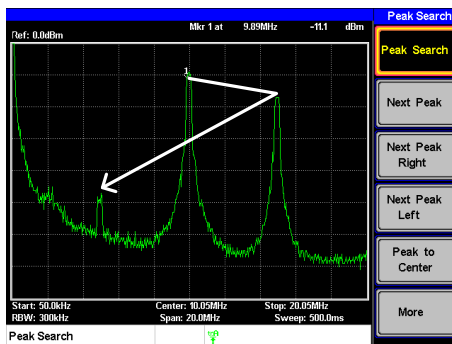

Example:  
Next Peak Right

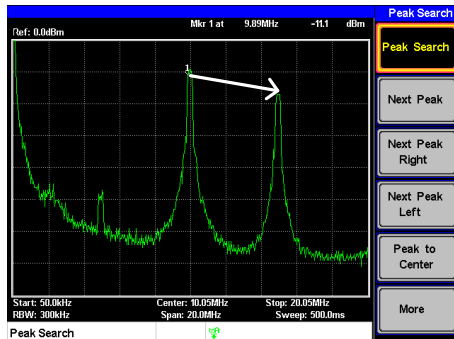

Example:  
Next Peak Left

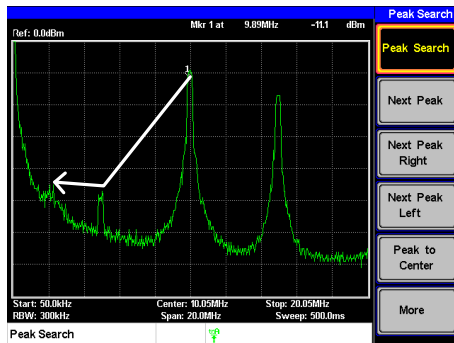

## Peak Table

**Description** The Peak Table function will display up to 5 peaks. The amplitude and frequency for each peak is listed.

**Operation**

1. Press **Peak Search** > **More [F6]** > **Peak Table [F1]** and turn the peak table on.

2. Press *Peak Sort*[F2] and set the sorting type:

- Freq: Sort by frequency in ascending order.
- Amp: Sort by amplitude in ascending order.

Display

The bottom-half of the screen shows the peak table with the peak marker no., frequency and amplitude.

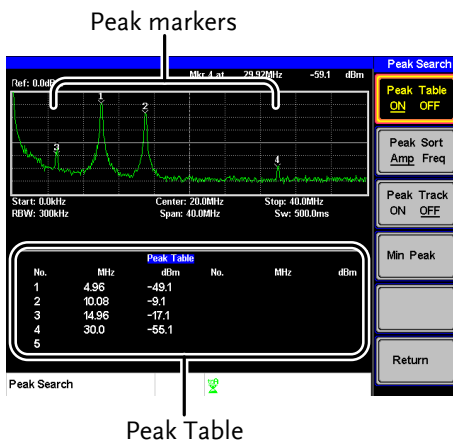

## Measurement

This section describes how to use the automatic measurement modes. The GSP-730 includes the following measurements:

- ACPR → from page 51.
- OCBW → from page 54.

## Channel Analysis Overview

Description	Channel analysis measurement includes ACPR (adjacent channel power) and OCBW (occupied bandwidth) measurements.
-------------	-----------------------------------------------------------------------------------------------------------------

Parameters	Channel bandwidth	The frequency bandwidth the target channel occupies. Range: Between 0Hz~3GHz (0Hz excepted)
	Channel Space	The frequency distance between each main channel. Range: Between 0Hz~3GHz
	Adjacent channel bandwidth 1 & 2	The frequency bandwidth the adjacent channels occupy. Range: Between 0Hz~3GHz (0Hz excepted)

Adjacent channel offset 1 ~ 2	The frequency distance between the adjacent channels and main channel. Range: 1 Between 0Hz~3GHz (0Hz excepted)
OCBW%	The ratio of occupied bandwidth to the amount of power consumed. Range: 0% to 100%, 0.1% resolution.

**ACPR**

**Description** Adjacent channel power refers to the amount of power leaked to the adjacent channel from the main channel. This measurement is a ratio of the main channel power to power in the adjacent channel.

**Example**

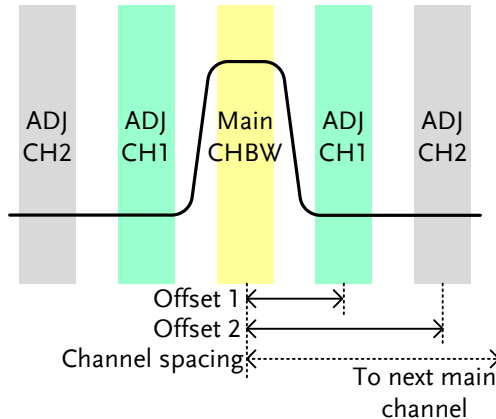

**Operation:**  
Setting up the main channel

1. Press Meas > ACPR[F2] and turn ACPR on.
  - Any other measurement mode will automatically be

disabled.

2. The display splits into two screens. The top screen shows the sweep waveform. The bottom screen shows the ACPR settings and measurement results in real time.
  - Turn ACPR off to return back to the normal mode.

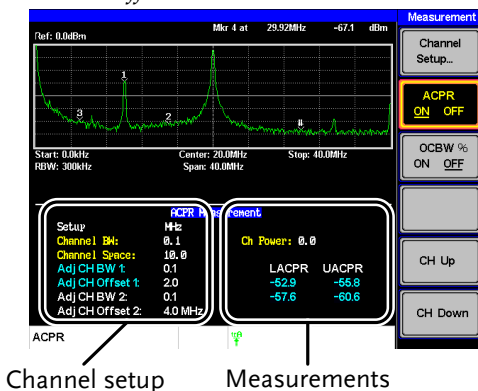

3. Press *Channel Setup...[F1]* and set the following:

- Main CH BW[F1]*                      Set the bandwidth of the main channel.
- Main CH Space[F2]*                Specify the channel spacing.

**Note**                                      The main channel bandwidth and space settings are shown in the setup area at the bottom of the screen, not on the soft-key icon.

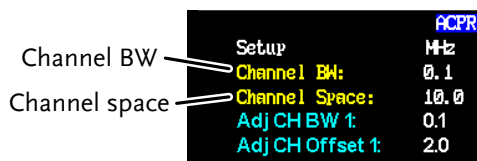

- Operation: Setting up the adjacent channel(s)
1. Press *ADJCH Setup...[F3]* to setup the adjacent channels:
 

<i>Adj CH BW 1[F1]</i>	Sets the bandwidth of the 1 <sup>st</sup> adjacent channel.
<i>Adj CH Offs 1[F2]</i>	Sets the channel offset of the 1 <sup>st</sup> adjacent channel.
<i>Adj CH BW 2[F3]</i>	Sets the bandwidth of the 2 <sup>nd</sup> adjacent channel.
<i>Adj CH Offs 2[F4]</i>	Sets the channel offset of the 2 <sup>nd</sup> adjacent channel.

**Note** The adjacent channel bandwidth and space settings are shown in the setup area at the bottom of the screen, not on the soft-key icons.

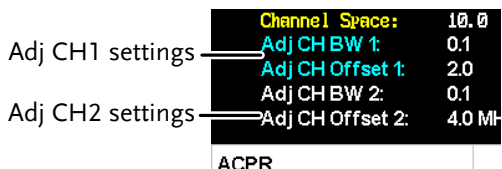

- Move Channels Up/Down
1. Press the  again or press *Return[F6]* repeatedly to return to the start of the Measure menu tree.
  2. Press *CH Up[F5]* to go to the next main channel.
  3. Press *CH Down[F6]* to go to the previous main channel.



The channel space (Main CH Space) setting determines where the next main channel is located.

## OCBW

**Description** Occupied bandwidth measurements are used to measure the power of the occupied channel as a percentage to the power of the channel.

### Example

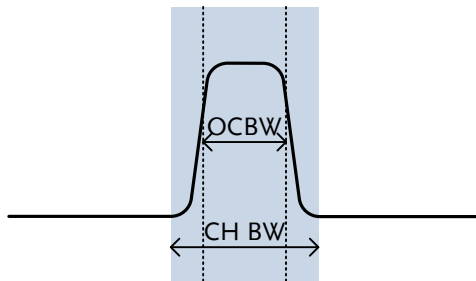

**Operation:**  
Setting up the main channel

1. Press **Meas** > **OCBW % [F3]** and turn OCBW on.
  - *Any other measurement mode will automatically be disabled.*
2. The display splits into two screens. The top shows the channel bandwidth. The bottom screen shows the OCBW measurement results in real time.
  - *Turn OCBW off to return back to the normal mode.*



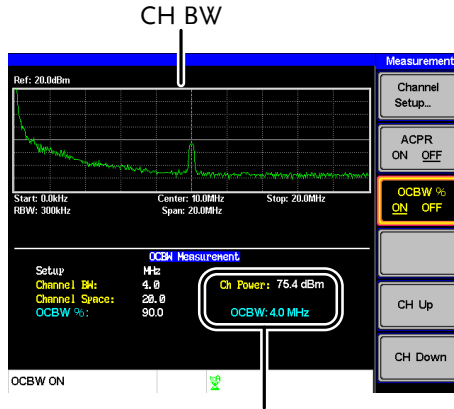

Channel power and OCBW power results

3. Press *Channel Setup...[F1]* and set the following:

- Main CH BW[F1]* Set the bandwidth of the main channel.
- Main CH Space[F2]* Specify the channel spacing.

Note

The main channel bandwidth and space settings are shown in the setup area at the bottom of the screen, not on the soft-key icon.

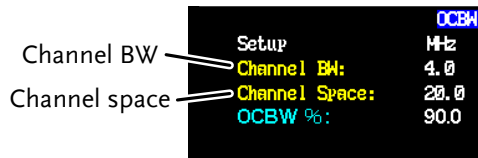

- Move Channels Up/Down
1. Press  again or press *Return*[F6] repeatedly to return to the start of the Measure menu tree.
  2. Press CH Up[F5] to go to the next main channel.
  3. Press CH Down[F6] to go to the previous main channel.
- 

**Note**

The channel space (Main CH Space) setting determines where the next main channel is located.

## Limit Line Testing

The Limit Line function is used to set the upper or lower amplitude limits over the entire frequency range. The limit lines can be used to detect whether the input signal is above, below or within the limit lines.

The limit lines can be manually edited using 10 frequency points from the start to the stop frequencies.

To save and recall limit lines, please see page 73.

### Activate a Limit Line

Operation

1. Press **Limit Line** to enter the Limit Line menu.
2. Press *H Limit*[F1] or *L Limit*[F2] and turn the high or low limit on or off.

H Limit/L Limit:            On, Off

- *The H Limit is shown as a blue line.*
- *The L Limit is shown as a pink line.*

High limit line

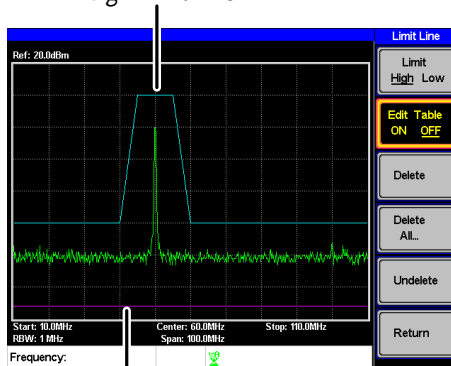

Low Line

## Creating a Limit (Point by Point)

**Description** Create a limit manually, point by point. Ten manually selected frequency points can be used to create the upper or lower limit line.

**Operation**

1. Press **Limit Line** > *Limit[F1]* and select the limit line you wish to edit.

Limit: High, Low

2. Press *Edit Table[F2]*, and turn the edit table on.

The GSP-730 is split into two screens. The top screen shows the trace and the selected limit line (high or low) and the bottom screen shows the limit line table.

Spectrum display

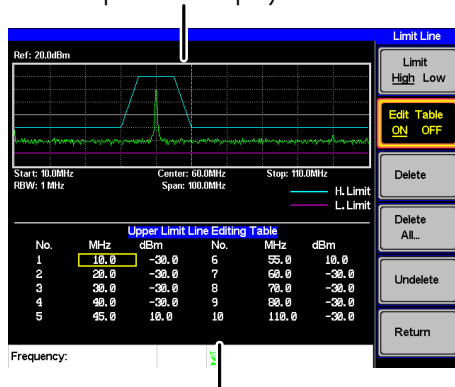

Limit Line Table

All 10 points will be displayed in a limit line table at the bottom of the display. By default, each point is set to 0dBm.

3. Use the arrow keys to move the cursor to the

frequency column of the desired point.  
Cursor

No.	MHz	dBm	No.	MHz	dBm
1	10.0	-30.0	6	50.0	-30.0
2	20.0	-30.0	7	60.0	-30.0
3	30.0	-30.0	8	70.0	-30.0
4	40.0	-30.0	9	80.0	-30.0
5	50.0	-30.0	10	110.0	-30.0

4. Enter the new frequency and amplitude of the point using the keypad and the unit keys.
5. Repeat steps 3-5 for the remaining points (A maximum of ten points).
6. To delete the selected point, press *Delete* [F3].
7. To delete all the points, press *Delete All...* [F4].
  - *The points will revert to their default frequency and amplitude values.*
8. To delete a point from the editing table, press *Delete*.
  - *The whole points, including the frequency value and the amplitude are removed. This command reduces the number of points used in the limit line.*
9. Press *Undelete*[F5] the restore the last point that was deleted.

## Pass/Fail Testing

---

### Description

The Pass/Fail testing uses the limit lines as boundaries. When the input signal escapes the boundary of the limit lines, then the test is judged as a FAIL, if the signal stays within the boundary, the test is judged as a PASS.

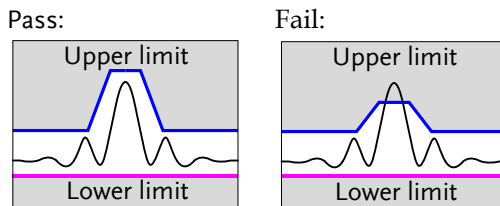

Note

Before pass/fail testing can begin, limit lines for the upper and/or lower limits must first be saved and activated. See the page 57.

Operation

1. Press **Limit Line** > *Pass/Fail*[F4] to turn the testing on or off.
2. The test result is updated in real-time at the bottom of the display.

Pass: **PASS**

Fail: **FAIL**



Note

At least one limit line (high or low) must be turned on to enable testing.

If only high limit line is on, each trace point has to be lower than the high limit line to get a PASS judgment, otherwise get the judgment will be FAIL.

Conversely, if only low limit line is on then each trace point has to be higher than the low limit line to get a PASS, otherwise get the test will be judged a FAIL.

## Bandwidth

BW key sets the resolution bandwidth (RBW). The resolution bandwidth and the sweep time are related. Please take into account how the sweep time is effected by the resolution bandwidth.

### Resolution Bandwidth Setting (RBW)

---

Description	The RBW (Resolution Bandwidth) defines the width of the IF (intermediate frequency) filter that is used to separate signal peaks from one another. The narrower the RBW, the greater the capability to separate signals at close frequencies. But it also makes the sweep time longer under specific frequency spans (the display is updated less frequently).
Operation	<ol style="list-style-type: none"> <li>1. Press  &gt; <i>RBW[F1]</i> and set the RBW to Auto or Man.</li> <li>2. Set the resolution bandwidth and unit for Man mode.</li> </ol> <p>Mode: Auto, Man Frequency Range: 1MHz, 300kHz, 100kHz</p>



Note

The manual RBW is only available when the span  $\geq 10$ MHz. If the span is greater than 10MHz then the RBW is automatically set to Auto.

## Trace

The GSP-730 is able to set the parameters of up to 3 different traces on the display at once. Each trace is represented by a different color and is updated with each sweep.

To save or recall traces to/from memory, see page 71.

### Selecting a Trace

---

**Description** Each trace (A, B, C) is represented by a different color. Trace A is green, trace B is orange and trace C is yellow. When activated, an icon for each trace color and function is shown at the bottom of the display. When a trace is selected, parameters can be set/edited from the Trace menu.

Display Icons

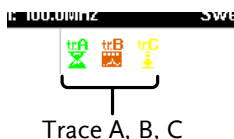



**Trace Type & Icon** The type of trace used determines how the trace data is stored or manipulated before being displayed. The analyzer updates each trace according to the type of trace used.

 Clear & Write

The GSP-730 continuously updates the display with each sweep. This is the default trace type.



 Peak Hold	The maximum or minimum points are maintained for the selected trace. The trace points are updated each sweep if new maximum or minimum points are found.
 Min Hold	
 View	View will hold the selected trace and stop updating the trace data for the selected trace. Pressing <i>View</i> [F4] will display the trace data that was cleared using the <i>Blank</i> [F5] key.
Blank	Clears the selected trace from the display and stores trace data. The trace data can be restored by pressing <i>View</i> [F4].

Operation 1. Press  > *Trace*[F1] and choose a trace.

Trace: A, B, C

2. Select the trace type:

*Clear & Write*[F2]

*Peak Hold*[F3]

*View*[F4]

*Blank*[F5]

*More*[F6] > *Min Hold*[F1]



Traces B and C are set to *Blank* by default.

## Trace Math

**Description**                      Performs trace math from two traces (A, B) and stores the results in trace A or swaps the data from trace A to trace B.

<b>Math functions</b>	$A \leftrightarrow B$	Swaps the data from trace A to B and vice versa.
	$A + B \rightarrow A$	Adds trace A and B and stores the result in trace A.
	$A - B \rightarrow A$	Subtracts trace B from trace and stores the result in trace A.
	$A + \text{const} \rightarrow A$	Adds an offset to trace A.
	$A - \text{const} \rightarrow A$	Subtracts an offset from trace A.

**Operation**

1. Press Trace > *Trace Math..* [F3] and select a trace math function.

- $A \leftrightarrow B$  [F1]
- $A + B \rightarrow A$  [F2]
- $A - B \rightarrow A$  [F3]
- $A + \text{const} \rightarrow A$  [F4]
- $A - \text{const} \rightarrow A$  [F5]

2. If  $A + \text{const} \rightarrow A$  or  $A - \text{const} \rightarrow A$  was selected, set the constant (offset value).

Constant:                                      -40dBm ~ 40dBm

## Average Trace

---

Description	The Average function averages the currently selected trace for a user-defined number of times before it is displayed. This feature smooths the noise level, but has the drawback of slowing down the display update rate.
Operation	<ol style="list-style-type: none"><li>1. Press  &gt; <i>More[F6]</i> and toggle Avg on.</li><li>2. Set the number of averages.  Range: 4 ~ 100 Default: 4</li></ol>

Example:

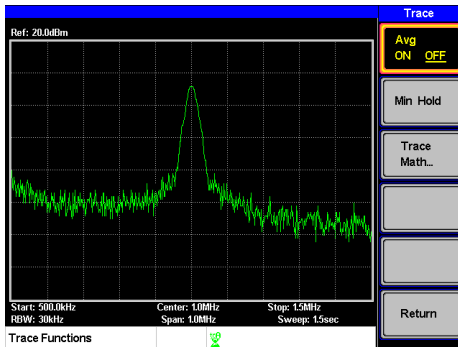

Average: Off

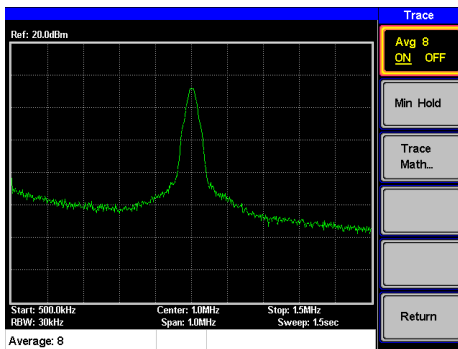

Average: On (8x)

# Display

The Display key configures the basic display settings as well as the split screen modes.

## Adjusting the LCD Brightness

Description	The LCD brightness levels can be adjusted to five pre-set levels.
Operation	<ol style="list-style-type: none"> <li>1. Press <b>Display</b> &gt; <i>LCD Dimmer[F1]</i> and use either the number pad, the scroll wheel or arrow keys to set the brightness.</li> </ol>

## Setting a Display Line (Reference Level Line)

Description	The Display Line function is used to superimpose a reference level line over the traces.
Operation	<ol style="list-style-type: none"> <li>1. Press <b>Display</b> &gt; <i>Display Line[F3]</i> to turn the display line on.</li> <li>2. Set the display line level and press <i>Enter</i>.</li> </ol>

Example:

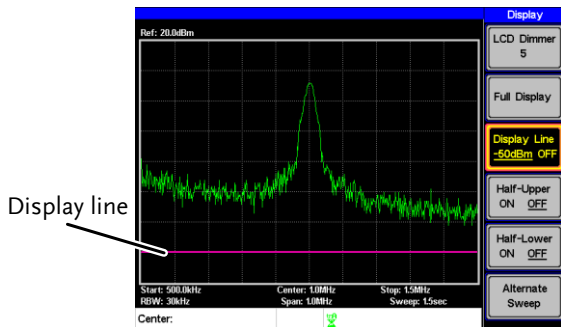

Display line set at -50dBm

## Using the Video Out Port

**Description** The GSP-730 has a dedicated VGA terminal to output the display to an external monitor. The video output is always on.

Output resolution 480 x 640 (fixed)

**Operation** 1. Connect an external monitor to the rear panel VGA terminal.



## Split Spectrum View

**Description** The split spectrum view is able to view two different sweep ranges on the display at the same time using a split screen view. The top and bottom view can have independent sweep ranges, amplitudes, spans and other settings. However only one split screen (top or bottom) can be swept each time.

**Example**

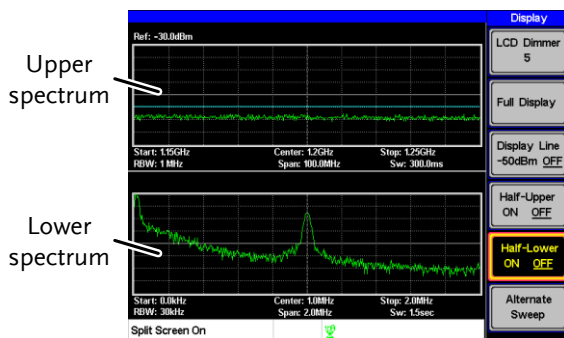

Split spectrum functions	Half-Upper	Half-Upper will put the spectrum analyzer into split screen mode. It will make the top sweep the active sweep and pause the bottom sweep. When Half-Upper is on, only the upper sweep parameters can be edited.
	Half-Lower	Half-Lower will put the spectrum analyzer into split screen mode. It will make the bottom sweep the active sweep and pause the top sweep. When Half-Lower is on, only the lower sweep settings can be edited.
	Alternate Sweep	This setting will alternate the sweep between the bottom and top spectrums. If alternate sweep is turned on, only the upper sweep parameters can be edited.

## Operation

1. Press  > *Half-Upper*[F4] or *Half-Lower*[F5] or *Alternate Sweep*[F6] to enable the split spectrum view.
    - *Turning Half-Upper on will automatically turn Half-Lower off.*
    - *Turning Half-Lower on will automatically turn Half-Upper off.*
    - *If Alternate Sweep is turned on, each sweep will alternate, but only the upper sweep parameters can be edited.*
  2. To return to a full-screen, single spectrum display, press *Full Display*[F2].
- 



## Note

After exiting the split spectrum view, the analyzer will use the settings from the active window. The settings for the inactive screen will be retained for the next time that split spectrum view is used.

If the spectrum analyzer was in the Alternate mode, then the upper sweep settings will be returned.



## Save/Recall Files

The GSP-730 can save and recall setup data, trace data and limit line data to and from internal memory. There are five memory locations for each save file type. These files cannot be saved to USB.

The Hardcopy key can be used to save image files to a USB flash drive.

### Save/Recall Setup

---

**Description** Setup data contains all the data necessary to recall the state of the GSP-730 to known state.

Setup data contains the following data:

Center frequency, Start frequency, Stop frequency, Step frequency, Ref. Level, Scale, Units, RBW

---

**Save** 1. To save the current settings, press **Memory** > *Setup To*[F1] and choose a memory location to save to with the arrow keys.

Setup To: 1~5

2. Press **kHz /  $\mu$ Sec** Enter to execute the save.

---

**Recall** 1. To recall a setup, press **Memory** > *Setup From*[F2] and choose a memory location to recall from with the arrow keys.

Setup From: 1~5

2. Press **kHz /  $\mu$ Sec** Enter to execute the recall.

## Save/Recall Trace Data

---

**Description**                    The trace data can be saved/recalled for any of the A, B or C traces to/from one of 5 pre-set internal memory locations. The trace data cannot be recalled or saved to USB.

When saving or recalling trace data from a split spectrum, only the active spectrum is saved/recalled.

---

**Save**                            1. To save the current trace data, press  > *Save Trace Data..*[F3]

2. Press *Source Trace*[F1] and select the source:

Source:                            A, B, C

3. Press *Destination*[F2] and select the memory location to save to:

Destination:                      1~5

4. Press *Start*[F5] to save the selected trace data.

---

**Recall**                            5. To recall trace data, press  > *Recall Trace Data..*[F3]

6. Press *Source Trace*[F1] and select the memory location to recall from:

Source:                            1~5

7. Press *Destination*[F2] and select the destination trace

Destination:                      A, B, C

- 
8. Press *Start*[F5] to recall the selected trace data.
- 

## Save/Recall Limit Lines

---

**Description** Upper and lower limit lines can be saved to one of 5 pre-set internal memory locations. The limit line data cannot be saved to USB.

---

- Save**
- To save the current upper and lower limit lines, press  > *Limitln to*[F5] and choose a memory location to save to with the arrow keys.

Limit line: 1~5

- Press  Enter to execute the save.
- 

- Recall**
- To recall pre-saved upper and lower limit lines, press  > *Limitln from*[F6] and choose a memory location to recall from with the arrow keys.

Limit line: 1~5

- Press  Enter to execute the recall.

## Saving an Image File (Hardcopy)

---

**Description** The Hardcopy key can be used to save a screenshot of the display to a USB flash drive. The screen shot is saved as a bitmap file.

- Operation
1. Insert a USB flash drive into the USB port.
  2. Press  and the image file will begin saving.
    - *Wait a few moments for the file to save. When the file has finished saving, "Screen Saved OK" will appear at the bottom of the display.*



Note

The file name will be automatically created in the following format:

File name: SCRXX.bmp

Where XX is a number that is incremented each time the file is saved.



Warning

Do not remove the USB drive until the file has completed saving.

## Hardcopy Setup

Description

The Hardcopy Setup key is used set the image file properties of the bitmap file that is created when the Hardcopy key is pressed.

Ink Normal: This is the normal, default image setting.

Ink Saving: This will invert all the colors on the display so that the file will conserve ink when printed.

- Operation
1. Press  and choose the image type:

*Ink Normal*[F1]

*Ink Saving*[F2]



Note

The next time the Hardcopy key is pressed, the image will be saved using the settings above.

## Load Default Settings

---

Description

The Preset key is used to load the default settings. The default settings are listed in the appendix on page 106.

---

Operation

1. Press .
  - *The system will load the preset settings and the screen will update with the new settings.*
- 



Note

The default settings cannot be changed.

# System Settings

## System Information

Description	The System Information displays the following:	
	Serial Number:	XX digit serial number
	HW Version:	Hardware version
	FW Version:	Firmware version
	SW Version:	Software version
	Language:	Shows the language number as seen in the System>Language menu.

- Operation
1. Press **(System)**>Information[F4] to display the system information.
    - *The system information will be displayed on the system menu soft-keys.*

### Example

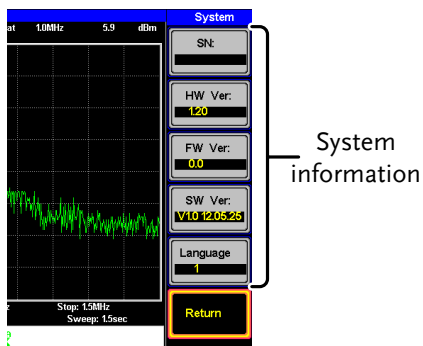

## System Language

---

Description	The language option sets the icon display language.				
Operation	<ol style="list-style-type: none"><li>1. Press  &gt; <i>Language...[F3]</i> to bring up the Language menu.</li><li>2. Choose a system language. The language number is the number that will be displayed in the system information.</li></ol>				
	<table><tr><td><i>Language 1 English</i></td><td>Sets the language to English</td></tr><tr><td><i>Language 2 Chinese S</i></td><td>Sets the language to simplified Chinese</td></tr></table>	<i>Language 1 English</i>	Sets the language to English	<i>Language 2 Chinese S</i>	Sets the language to simplified Chinese
<i>Language 1 English</i>	Sets the language to English				
<i>Language 2 Chinese S</i>	Sets the language to simplified Chinese				

# REMOTE CONTROL

This chapter describes basic configuration of IEEE488.2 based remote control. For a command list, refer to the programming manual, downloadable from GW Instek website, [www.gwinstek.com](http://www.gwinstek.com)

Interface Configuration.....	80
Configure Remote Interface.....	80
Remote Control Function Check.....	81
Command Syntax.....	82
Command List.....	85
IEEE488.2 Standard Commands.....	87
*IDN?.....	87
Sweep Commands.....	87
si.....	87
sn.....	87
ts.....	88
Frequency Commands.....	88
meas:freq:cen.....	88
meas:freq:st.....	88
meas:freq:stp.....	89
Span Commands.....	89
meas:span.....	89
meas:span:full.....	90
Amplitude Commands.....	90
meas:refl:unit.....	90
meas:refl.....	90
Marker and Peak Search Commands.....	91
meas:mark:on.....	91
meas:mark:off.....	92
meas:mark:norm.....	92
meas:mark:norm:freq?.....	92
meas:mark:norm:level?.....	93
meas:mark:delta.....	93



meas:mark:delta:freq?	93
meas:mark:delta:level?	94
meas:mark:tomin	94
meas:mark:topeak	94
meas:mark:tonp	95
meas:mark:trace	95
Trace Commands	95
meas:tra:val1:val2	95
meas:tra:avg:on	96
meas:tra:avg:off	96
meas:tra:read	97
Power Measurement Commands	97
meas:acpr	97
meas:acpr:lower?	98
meas:acpr:upper?	98
meas:ocbw	98
meas:ocbw:bw?	99
meas:ocbw:chpw?	99
Limit Line Commands	99
meas:lmpline:passfail	99
meas:lmpline:on	100
meas:lmpline:off	100
BW Commands	100
con:rbw:auto	100
con:rbw?	101
con:rbw:man	101
con:rbw:mode?	101
con:swt?	102
Display Commands	102
con:disp:split:upper	102
con:disp:split:lower	102
con:disp:split:alt	102
con:disp:split:full	103
Preset Commands	103
con:preset	103
System Commands	103
con:sys:ser?	103

## Interface Configuration

### Configure Remote Interface

USB configuration	PC side connector	Type A, host
	GSP side connector	Rear panel Type B, slave
	Speed	1.1/2.0 (full speed)
RS232 configuration	PC side connector	RS232 male port
	GSP side connector	RS232 female port
	Baud Rate:	9600, 19200, 38400, 57600, 115200.
	Parity:	None, Even, Odd, Space, Mark, Multidrop.
	Stop bit:	1, 1.5, 2.
	Data bit:	5, 6, 7, 8
Description	<p>The GSP-730 can use either the type B USB port or the RS232 on the rear panel for remote control.</p> <p>When using the USB B port, the GSP-730 uses a USB driver to simulate an RS232 connection with a PC via USB. It is these RS232 settings that are configured for remote control.</p> <p>Before using the USB B port for remote control, please install the USB driver. See page 20 for details.</p>	

- Panel operation
1. USB Connection:  
Connect a USB cable from the PC to the rear panel USB B port.

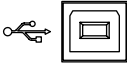
  - RS232 Connection:  
Connect an RS232C cable from the PC to the rear panel RS232 port.

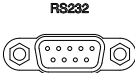
  2. Press **System** > *Serial Port...[F1]* > *Serial[F1]* to enter the remote configuration.

3. Set the following RS-232 settings using the arrow keys:

*Baud Rate[F1]:* 9600, 19200, 38400, 57600, 115200.

*Parity[F2]:* None, Even, Odd, Space, Mark, Multidrop.

*Stop Bit[F3]:* 1, 1.5, 2.

*Data[F4]:* 5, 6, 7, 8

## Remote Control Function Check

---

Functionality check      Invoke a terminal application such as MTTY (Multi-Threaded TTY).

To check the COM port No., see the Device Manager in the PC.

For WinXP go to;

Control panel → System → Hardware tab.

---

Run this query command via the terminal after the instrument has been configured for remote control (page 80).

\*idn?

---

This should return the Manufacturer, Model number, Serial number, and Firmware version in the following format.

- *GW-INSTEK, GSP-730, XXXXXXXXX, V.VV*

Manufacturer: GW-INSTEK  
 Model number : GSP-730  
 Serial number : XXXXXXXXXXXXX  
 Firmware version : V.VV



Note

For further details or if you have trouble running this function check, please see the programming manual, available on the GW Instek web site @ [www.gwinstek.com](http://www.gwinstek.com).

## Command Syntax

Compatible Standard	IEEE488.2	Partial compatibility
	SCPI, 1999	Partial compatibility
Command Structure	SCPI (Standard Commands for Programmable Instruments) commands follow a tree-like structure, organized into nodes. Each level of the command tree is a node. Each keyword in a SCPI command represents each node in the command tree. Each keyword (node) of a SCPI command is separated by a colon (:).	

For example, the diagram below shows an SCPI sub-structure and a command example.

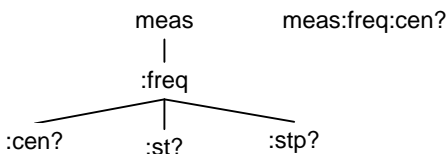

**Command types**      There are a number of different instrument commands and queries. A command sends instructions or data to the unit and a query receives data or status information from the unit.

Command types

**Single Command**      A single command with/without a parameter

**Example**      meas:freq:cen 100 MHz

**Query**      A query is a simple or compound command followed by a question mark (?). A parameter (data) is returned.

**Example**      meas:freq:cen?

**Command Format**



- |                   |                    |
|-------------------|--------------------|
| 1. Command header | 4. Optional space  |
| 2. Space          | 5. Unit or suffix. |
| 3. Parameter 1    |                    |

**Common Input/Return Parameters**

Type	Description	Example
<Boolean>	Boolean logic	0, 1
<NR1>	integers	0, 1, 2, 3
<NR2>	decimal numbers	0.1, 3.14, 8.5
<NRf>	any of NR1, 2	1, 1.5

<freq>	<NRf> + unit    2.5 mhz Unit = kHz, MHz, GHz. Note: The unit can be omitted (defaults to currently set unit).
<refl>	<NRf> + unit    -30 dBm Unit = dBm, dBmV, dBuV Note: The unit can be omitted (defaults to currently set unit).
<ampl>	NR3 +unit        30.0 dBm Note: The unit can be omitted. (Unit defaults to current unit)
<trace data>	{ -92, -91, ....., -89, -92, -92, -91 } CSV data that represents each point in a trace.
<string>	ASCII string data.

Message Terminator	LF	Line feed code (0x0A)
--------------------	----	-----------------------

## Command List

---

IEEE488.2 Standard Commands	*IDN? .....	87
Sweep Commands	si .....	87
	sn .....	87
	ts .....	88
Frequency Commands	meas:freq:cen .....	88
	meas:freq:st .....	88
	meas:freq:stp .....	89
Span Commands	meas:span .....	89
	meas:span:full .....	90
Amplitude Commands	meas:refl:unit .....	90
	meas:refl .....	90
Marker Commands	meas:mark:on .....	91
	meas:mark:off .....	92
	meas:mark:norm .....	92
	meas:mark:norm:freq? .....	92
	meas:mark:norm:level? .....	93
	meas:mark:delta .....	93
	meas:mark:delta:freq? .....	93
	meas:mark:delta:level? .....	94
	meas:mark:tomin .....	94
	meas:mark:topeak .....	94
	meas:mark:tonp .....	95
	meas:mark:trace .....	95
Trace commands	meas:tra:val1:val2 .....	95
	meas:tra:avg:on .....	96
	meas:tra:avg:off .....	96
	meas:tra:read .....	97
Power measurement	meas:acpr .....	97
	meas:acpr:lower? .....	98

---

commands	meas:acpr:upper? .....	98
	meas:ocbw .....	98
	meas:ocbw:bw? .....	99
	meas:ocbw:chpw? .....	99
Limit Line	meas:lmtnline:passfail .....	99
commands	meas:lmtnline:on .....	100
	meas:lmtnline:off .....	100
BW commands	con:rbw:auto .....	100
	con:rbw? .....	101
	con:rbw:man .....	101
	con:rbw:mode? .....	101
	con:swt? .....	102
Display	con:disp:split:upper .....	102
commands	con:disp:split:lower .....	102
	con:disp:split:alt .....	102
	con:disp:split:full .....	103
Preset	con:preset .....	103
commands		
System	con:sys:ser? .....	103
commands		



## IEEE488.2 Standard Commands

*IDN? .....	87
-------------	----

### \*IDN? → Query

**Description**      Queries the manufacturer, model number, serial number, and firmware version of the instrument.

**Query Syntax**      \*IDN?

**Return parameter** <string> Returns the instrument identification as a string in the following format:  
 GW-INSTEK, GSP-730, XXXXXXXX, V.VV  
 Manufacturer: GWINSTEK  
 Model number : GSP-730  
 Serial number : XXXXXXXX  
 Firmware version : V.VV

## Sweep Commands

si .....	87
sn .....	87
ts .....	88

### si Set →

**Description**      Stops the sweep.

**Example**          si

### sn Set →

**Description**      Continues a stopped sweep.

**Example**          sn

ts

Set →

Description	Resets the sweep and starts it once (i.e., sweeps one time).
Example	ts

### Frequency Commands

meas:freq:cen.....	88
meas:freq:st.....	88
meas:freq:stp .....	89

meas:freq:cen

Set →  
→ Query

Description	Sets or queries the center frequency.
Syntax	meas:freq:cen <freq>
Query Syntax	meas:freq:cen?
Parameter	<freq> Center frequency.
Return parameter	<freq> Returns the frequency and unit.
Example	meas:freq:cen 100 khz Sets the center frequency to 100kHz.
Query example	Meas:freq:cen? >100 kHz

meas:freq:st

Set →  
→ Query

Description	Sets or queries the start frequency.
Syntax	meas:freq:st <freq>
Query Syntax	meas:freq:st?

Parameter	<freq>	Start frequency
Return parameter	<freq>	Returns the start frequency and unit
Example	meas:freq:st 100 mhz Sets the start frequency to 100MHz	
Query Example	meas:freq:st? > 100000 kHz	

Set →  
 → Query

**meas:freq:stp**

---

Description	Sets or queries the stop frequency.	
Syntax	meas:freq:stp <freq>	
Query Syntax	meas:freq:stp?	
Parameter	<freq>	Stop frequency
Return parameter	<freq>	Returns the stop frequency and unit
Example	meas:freq:stp 100 mhz Sets the stop frequency to 100MHz	
Query Example	meas:freq:stp? > 100000 kHz	

### Span Commands

meas:span.....	89
meas:span:full.....	90

Set →  
 → Query

**meas:span**

---

Description	Sets or queries the frequency span.	
Syntax	meas:span <freq>	
Query Syntax	meas:span?	

Parameter	<freq>	Span frequency range
Return parameter	<freq>	Returns the span and unit
Example	meas:span 10 mhz Sets the span to 10MHz	
Query Example	meas:span? > 10000.0 kHz	

**meas:span:full** (Set) →

Description	Sets the span to the full span.	
Syntax	meas:span:full	

**Amplitude Commands**

meas:refl:unit.....	90
meas:refl.....	90

**meas:refl:unit** (Set) →  
→ (Query)

Description	Sets the reference level unit.	
Syntax	meas:refl:unit {1 2 3}	
Query Syntax	meas:refl:unit?	
Parameter/	1	dBm
Return parameter	2	dBmV
	3	dBuV
Query Example	Meas:refl:unit? >1 The reference level units are dBm.	

**meas:refl** (Set) →  
→ (Query)

Description	Sets or queries the reference level.	
-------------	--------------------------------------	--

Syntax	meas:refl <refl>	
Query Syntax	meas:refl?	
Parameter	<refl>	Reference level in the currently selected unit (from the meas:refl:unit command).
Return parameter	<refl>	Returns reference level and unit.
Example	meas:refl 10 Sets the reference level to 10 dBm (for unit = dBm).	
Query Example	Meas:refl? >10 dBm	

### Marker and Peak Search Commands

meas:mark:on .....	91
meas:mark:off .....	92
meas:mark:norm .....	92
meas:mark:norm:freq? .....	92
meas:mark:norm:level? .....	93
meas:mark:delta .....	93
meas:mark:delta:freq? .....	93
meas:mark:delta:level? .....	94
meas:mark:tomin .....	94
meas:mark:topeak .....	94
meas:mark:tonp .....	95
meas:mark:trace .....	95

#### meas:mark:on

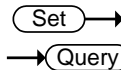

Description	Sets or queries which markers are turned on.	
Syntax	meas:mark:on {<NR1> all}	
Query Syntax	meas:mark:on <NR1>?	
Parameter	<NR1>	Marker number 1~ 5.
	all	All markers.
Return parameter	ON	The selected marker is on.
	OFF	The selected marker is off.

Example            meas:mark on 1  
                          Turns marker 1 on.

Query Example    Meas:mark 1?  
                          >OFF

**meas:mark:off** (Set) →

Description       Sets which markers are turned off.

Syntax            meas:mark:off {<NR1>|all}

Parameter	<b>&lt;NR1&gt;</b>	Marker number 1~ 5.
	All	All markers.

Example            meas:mark off 1  
                          Turns marker 1 off.

**meas:mark:norm** (Set) →

Description       Sets the selected marker to normal mode.

Syntax            meas:mark:norm <NR1>

Parameter	<b>&lt;NR1&gt;</b>	Marker number 1~ 5.
-----------	--------------------	---------------------

Example            meas:mark:norm 1  
                          Sets marker 1 to normal mode.

**meas:mark:norm:freq?** → (Query)

Description       Queries the frequency of the selected normal marker.

Query syntax      meas:mark:norm:freq <NR1>?

Parameter	<b>&lt;NR1&gt;</b>	Marker number 1~ 5.
-----------	--------------------	---------------------

Return parameter	<code>&lt;freq&gt;</code>	Returns the frequency and unit of the selected marker.
------------------	---------------------------	--------------------------------------------------------

Example	<code>meas:mark:norm:freq 1?</code> <code>&gt;1.5GHz.</code>
---------	-----------------------------------------------------------------

**meas:mark:norm:level?** → Query

Description	Queries the amplitude of the selected normal marker.
-------------	------------------------------------------------------

Query syntax	<code>meas:mark:norm:level &lt;NR1&gt;?</code>
--------------	------------------------------------------------

Parameter	<code>&lt;NR1&gt;</code>	Marker number 1~ 5.
-----------	--------------------------	---------------------

Return parameter	<code>&lt;amp&gt;</code>	Returns the amplitude and unit of the selected marker.
------------------	--------------------------	--------------------------------------------------------

Example	<code>meas:mark:norm:level 1?</code> <code>&gt;10.0dBm.</code>
---------	-------------------------------------------------------------------

**meas:mark:delta** Set →

Description	Sets the selected marker to delta mode. It also sets the relative frequency of the delta marker (in relation to the normal marker frequency).
-------------	-----------------------------------------------------------------------------------------------------------------------------------------------

Syntax	<code>meas:mark:delta &lt;NR1&gt; &lt;freq&gt;</code>
--------	-------------------------------------------------------

Parameter	<code>&lt;NR1&gt;</code>	Marker number 1~ 5.
	<code>&lt;freq&gt;</code>	Relative frequency of the delta marker.

Example	<code>meas:mark:freq 1 10 MHz</code> Turns delta marker 1 on and sets its offset to 10MHz.
---------	-----------------------------------------------------------------------------------------------

**meas:mark:delta:freq?** → Query

Description	Queries the (relative) frequency of the selected delta marker.
-------------	----------------------------------------------------------------

Query syntax	<code>meas:mark:delta:freq &lt;NR1&gt;?</code>
--------------	------------------------------------------------

Parameter	<NR1>	Marker number 1~ 5.
Return parameter	<freq>	Returns the relative frequency and unit of the selected delta marker.
Example	meas:mark:norm:freq 1? >12.0kHz.	

**meas:mark:delta:level?** → Query

Description	Queries the amplitude of the selected delta marker.	
Query syntax	meas:mark:delta:level <NR1>?	
Parameter	<NR1>	Marker number 1~ 5.
Return parameter	<amp>	Returns the amplitude and unit of the selected delta marker.
Example	meas:mark:delta:level 1? >10.0dBm.	

**meas:mark:tomin** Set →

Description	Sets the selected marker to the minimum peak.	
Syntax	meas:mark:tomin <NR1>	
Parameter	<NR1>	Marker number 1~ 5.
Example	meas:mark:tomin 1 Sets marker 1 to the minimum peak.	

**meas:mark:topeak** Set →

Description	Sets the selected marker to the peak.	
Syntax	meas:mark:topeak <NR1>	
Parameter	<NR1>	Marker number 1~ 5.
Example	meas:mark:topeak 1 Sets marker 1 to the peak.	



**meas:mark:tonp** (Set) →

**Description** Moves the selected normal or delta marker to the next peak.

**Syntax** meas:mark:tonp <NR1>

**Parameter** <NR1> Marker number 1~ 5.

**Example** meas:mark:tono 1  
 Moves marker 1 to the next peak.

**meas:mark:trace** (Set) →

**Description** Sets the selected marker to the selected trace.

**Syntax** meas:mark:topeak <NR1> <trace>

<b>Parameter</b>	<NR1>	Marker number 1~ 5.
	<trace>	0 Auto (auto assign a trace)
		1 Trace A
		2 Trace B
		3 Trace C

**Example** meas:mark:trace 1 2  
 Sets marker 1 to trace B.

**Trace Commands**

meas:tra:val1:val2 .....	95
meas:tra:avg:on .....	96
meas:tra:avg:off.....	96
meas:tra:read .....	97

**meas:tra:val1:val2** (Set) →

**Description** Sets the mode for the selected trace.

**Syntax** meas:tra <trace><mode>

Parameter	<trace>	1	Trace A
		2	Trace B
		3	Trace C
	<mode>	1	Clear and write mode
		2	Peak hold mode
		3	View mode
4		Blank mode	
	5	Minimum hold mode	

Example            meas:tra 1 1  
                       Sets trace A to clear and write mode.

**meas:tra:avg:on** (Set) →

Description       Turns the average function on and sets the number of averages for the selected trace.

Syntax             meas:tra:avg:on <trace> <NR1>

Parameter	<trace>	1	Trace A
		2	Trace B
		3	Trace C
	<NR1>	4~20	Number of averages.

Example            meas:tra:avg:on 1 4  
                       Sets the number of averages used for Trace A to 4.

**meas:tra:avg:off** (Set) →

Description       Turns the average function off for the selected trace.

Syntax             meas:tra:avg:off <trace>

Parameter	<trace>	1	Trace A
		2	Trace B
		3	Trace C
		all	All traces

Example            meas:tra:avg:off all  
                       Turns the average function off for all the traces.

**meas:tra:read**

→ Query

Description	Returns the all the trace data for the selected trace.		
Query syntax	meas:tra:read? <trace>		
Parameter	<trace>	1	Trace A
		2	Trace B
		3	Trace C
		all	All traces
Return parameter	<trace data>	Comma separated data values encapsulated in brackets. i.e., {-92, -91, -90, .....-81}	
Example	<pre>meas:tra:read? 1 &gt;{-92, -91, -90, -90, -90, -88, ....., -89, -92, -92, -91 }</pre> <p>Returns the trace data for the selected trace(s). A total of 501 trace points are returned, from the start frequency to the stop frequency. If “all” is selected, the trace data is returned in three lots, {trace A}{trace B}{traceC}. The units are in decibels. If the selected trace is not active, 0s will be returned for each trace point.</p>		

**Power Measurement Commands**

meas:acpr .....	97
meas:acpr:lower? .....	98
meas:acpr:upper? .....	98
meas:ocbw .....	98
meas:ocbw:bw? .....	99
meas:ocbw:chpw? .....	99

**meas:acpr**

Set →

→ Query

Description	Turns the ACPR function on or off, or queries its status.
Syntax	meas:acpr {on off}

Query Syntax	meas:acpr?	
Parameter/	on	ACPR mode = on
Return parameter	off	ACPR mode = off
Example	meas:acpr on Turns the ACPR function on.	

**meas:acpr:lower?** → Query

Description	Returns the lower ACPR measurement result for the selected channel offset (offset 1 or 2).	
Query syntax	meas:acpr:lower? {1 2}	
Parameter	1	Channel offset 1
	2	Channel offset 2
Return parameter	<NR2>	Returns the ACPR measurement result.
Example	meas:acpr:lower? 1 >6.0	

**meas:acpr:upper?** → Query

Description	Returns the upper ACPR measurement result for the selected channel offset (offset 1 or 2).	
Query syntax	meas:acpr:upper? {1 2}	
Parameter	1	Channel offset 1
	2	Channel offset 2
Return parameter	<NR2>	Returns the ACPR measurement result.
Example	meas:acpr:upper? 1 >-11.8	

**meas:ocbw** Set →  
→ Query

Description	Turns the OCBW function on or off, or queries its status.	
-------------	-----------------------------------------------------------	--

Syntax	meas:ocbw {on off}	
Query Syntax	meas:ocbw?	
Parameter/	On	OCBW mode = on
Return parameter	Off	OCBW mode = off
Example	meas:ocbw on Turns the OCBW function on.	

**meas:ocbw:bw?** → Query

Description	Returns the OCBW in kHz.	
Query syntax	meas:ocbw:bw?	
Return parameter	<freq>	Returns the OCBW in kHz
Example	meas:ocbw:bw? >4000kHz	

**meas:ocbw:chpw?** → Query

Description	Returns the channel power in the current unit.	
Query syntax	meas:ocbw:chpw?	
Return parameter	<power>	Returns the channel power
Example	meas:ocbw:chpw? >-63.5	

**Limit Line Commands**

meas:lm:line:passfail .....	99
meas:lm:line:on .....	100
meas:lm:line:off .....	100

**meas:lm:line:passfail** Set →  
→ Query

Description	Turns the Pass/Fail test on/off or queries its state.
-------------	-------------------------------------------------------

Syntax	meas:limitline:passfail {on off}	
Query Syntax	meas:limitline:passfail	
Parameter	on	Turns the pass/fail test on.
	off	Turns the pass/fail test off.
Return parameter	0	Fail
	1	Pass
Query example	meas:limitline:passfail? >0	

**meas:limitline:on** Set →

Description	Turns the limit lines on.
Syntax	meas:limitline:on

**meas:limitline:off** Set →

Description	Turns the limit lines off.
Syntax	meas:limitline:off

**BW Commands**

con:rbw:auto.....	100
con:rbw?.....	101
con:rbw:man.....	101
con:rbw:mode?.....	101
con:swt?.....	102

**con:rbw:auto** Set →

Description	Sets the RBW to Auto.
Syntax	con:rbw:auto

**con:rbw?**

→ Query

Description	Returns the RBW.		
Query Syntax	con:rbw?		
Return parameter	<NR1>	0	30kHz
		1	100kHz
		2	300kHz
		3	1MHz
Example	con:rbw? >1		

**con:rbw:man**

Set →

Description	Sets the RBW for manual mode.		
Syntax	con:rbw:man {0 1 2 3}		
Parameter	<NR1>	1	100kHz
		2	300kHz
		3	1MHz
Example	con:rbw:man 1 Sets the RBW to 100kHz.		

**con:rbw:mode?**

→ Query

Description	Returns the RBW mode.		
Query Syntax	con:rbw:mode?		
Return parameter	auto	Auto mode	
	manual	Manual mode	
Example	con:rbw:mode? >auto		

con:swt? → Query

Description	Returns the sweep time in milliseconds.
Query Syntax	con:swt?
Return parameter	<NRf>
Example	Con:swt? >1500

### Display Commands

con:disp:split:upper .....	102
con:disp:split:lower .....	102
con:disp:split:alt .....	102
con:disp:split:full.....	103

con:disp:split:upper Set →

Description	Turns on the split window function and sweeps the top window.
Syntax	con:disp:split:upper

con:disp:split:lower Set →

Description	Turns on the split window function and sweeps the bottom window.
Syntax	con:disp:split:lower

con:disp:split:alt Set →

Description	Sweeps the upper and lower windows alternatively in the split window mode.
Syntax	con:disp:split:lower



**con:disp:split:full**

Set →

**Description** Returns the spectrum analyzer to single window mode. The upper window is used as the active window.

**Syntax** con:disp:split:full

**Preset Commands**

con:preset ..... 103

**con:preset**

Set →

**Description** Loads the factory default settings. This is the equivalent to pressing the Preset key.

**Syntax** con:preset

**System Commands**

con:sys:ser? ..... 103

**con:sys:ser?**

→ Query

**Description** Returns the serial number.

**Query syntax** con:sys:ser?

**Return parameter** <string> Returns the serial number in the following format:  
XXXXXXXXXX

**Example** con:sys:ser?  
> XXXXXXXXX

# FAQ

---

- I connected the signal but it does not appear on screen.
- The trace is updated too slowly.
- I cannot see the trace on the screen.
- The performance does not match the specification.

I connected the signal but it does not appear on screen.

---

Run Autoset and let the GSP-730 find the best display scale for your target signal. Press the Autoset key, then press *Autoset[F1]*. For details, see page 36.

The trace is updated too slowly on the screen.

---

The sweep time determines how often the trace is updated on the screen. To increase the sweep time, try reducing the span or using a wider RBW setting.

I cannot see the trace on the screen.

---

If you cannot see the trace on the screen, there may be a number of possibilities.

1. The trace is just off screen: Try to adjust the reference level with the amplitude key.
2. The trace may be in the “Blank” mode: Putting the trace into view mode will enable the trace to be viewed again.

The performance does not match the specification.

---

Make sure the device is powered On for at least 30 minutes, within +20°C~+30°C. This is necessary to stabilize the unit to match the specification.

For more information, contact your local dealer or GWInstek at [www.gwinstek.com](http://www.gwinstek.com) / [marketing@goodwill.com](mailto:marketing@goodwill.com).

# A PPENDIX

## GSP-730 Default Settings

The following default settings are the factory configuration settings for the spectrum analyzer (Function settings/Test settings).

Frequency	Center Frequency: 1.5GHz Stop Frequency: 3GHz	Start Frequency: 0Hz CF Step: Auto
Span	Span: 3GHz	
Amplitude	Reference level: -30.0dBm Units: dBm	Scale Div: 10
Autoset	Amp.Floor: Auto	Span: Auto
Marker	Marker: Off	
Peak Search	N/A	
Meas	ACPR: Off	OCBW: Off
Limit Line	H Limit: Off Pass/Fail: Off	L Limit: Off
BW	RBW: Auto	
Trace	Trace: A: Clear&Write	Average: Off
Display		

---

	Full Display: Active	Display line: off
Memory	N/A	
Preset	N/A	
Hardcopy	N/A	
Hardcopy Setup	Ink Normal	
System	N/A	

## GSP-730 Specifications

The specifications apply when the GSP is powered on for at least 30 minutes to warm-up to a temperature of 20°C to 30°C, unless specified otherwise.

### Frequency

<b>Frequency Range</b>	
Setting Range	150kHz to 3GHz
<b>Center Frequency</b>	
Setting Resolution	0.1MHz
Accuracy	within ±50kHz (frequency span : 0.3GHz to 2.6GHz, 20 ±5°C)
<b>Frequency Span</b>	
Setting range	1MHz to 3GHz
Accuracy	within ±3% (frequency span : 0.3GHz to 2.6GHz, 20 ±5°C)
<b>Resolution Bandwidth</b>	
Setting Range	30KHz, 100KHz, 300KHz,1MHz,
<b>SSB Phase Noise</b>	
-85dBc / Hz (typical, 500kHz offset, RBW : 30kHz, Sweep time: 1.5s, Span:1MHz@1GHz)	
<b>Inherent Spurious Response</b>	
less than -45dBc @ -40dBm Ref. Level (typical less than -50dBc)	

### Amplitude

<b>Reference Level</b>	
Input Range	+20 to -40dBm
Unit	dBm, dBV, dBμV
<b>Average Noise Level</b>	
≤ -100dBm (typical, center frequency : 1GHz RBW : 30kHz)	
<b>Frequency Characteristic</b>	
within ±3.0dB @300MHz~2.6GHz, within ±6.0dB @ 80~300MHz, 2.6~3GHz	
Accuracy	Within ±2dB (1GHz);SPAN:5MHz; Ref. level 0dBm, input signal -10dBm

## Input

Input Impedance	50ohm
Input VSWR	less than 2.0@input att $\geq 10$ dB
Input damage level	+30dBm (CW average power), 25VDC
Input connector	N connector

## Sweep

## Sweep Time

Setting Range	300ms to 8.4s, auto (not adjustable)
Accuracy	within $\pm 2\%$ ( frequency span : full span)

## General

## Communication

Display	640*480 RGB color LCD
---------	-----------------------

## Interface

RS-232C	Sub-D female-D 9 pins
USB Connector	USB Host/Device full speed supported
USB Format	Supports FAT/FAT32 only

## VGA Output

Sub-D female 15 pins

## Power Source

AC 100~240V, 50/60Hz

## Other

Operating Temperature	5 to 45°C (Guaranteed at 25 $\pm 5$ °C, without soft carrying case)
Operating Humidity	Less than 45°C / 90%RH
Storage Temperature	-20 to 60°C, less than 60°C / 70%RH
Dimensions	296 (L) $\times$ 153 (W) $\times$ 105 (H) mm
Weight	Approx. 2.2kg

## GSP-730 Dimensions

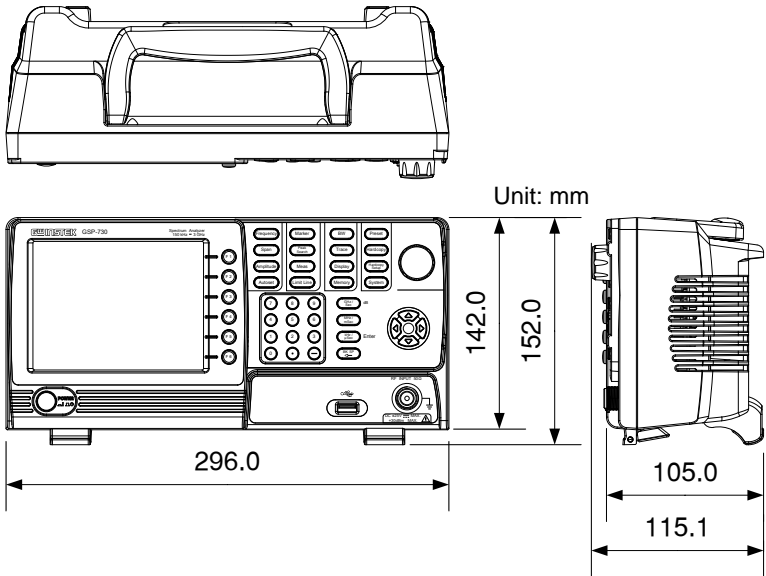



# Declaration of Conformity

We

**GOOD WILL INSTRUMENT CO., LTD.**

No. 7-1, Jhongsing Rd, Tucheng Dist., New Taipei City 236, Taiwan

**GOOD WILL INSTRUMENT (SUZHOU) CO., LTD.**

No. 69 Lushan Road, Suzhou New District Jiangsu, China.

declare that the below mentioned product

**Type of Product: Spectrum Analyzer**

**Model Number: GSP-730**

is herewith confirmed to comply with the requirements set out in the Council Directive on the Approximation of the Laws of the Member States relating to Electromagnetic Compatibility (2004/108/EEC & 2014/30/EU) and Low Voltage Directive (2006/95/EEC).

For the evaluation regarding the Electromagnetic Compatibility and Low Voltage Directive, the following standards were applied:

© EMC

<b>EN 61326-1:</b>	Electrical equipment for measurement, control and laboratory use -- EMC requirements (2013)
<b>EN 61326-2-1:</b>	
<b>EN 61326-2-2:</b>	
Conducted and Radiated Emissions EN 55011: 2009+A1: 2010	Electrostatic Discharge EN 61000-4-2: 2009
Current Harmonic EN 61000-3-2: 2006+A1: 2009+A2: 2009	Radiated Immunity EN 61000-4-3: 2006+A1: 2008+A2 :2010
Voltage Fluctuation EN 61000-3-3: 2013	Electrical Fast Transients EN 61000-4-4: 2012
-----	Surge Immunity EN 61000-4-5: 2006
-----	Conducted Susceptibility EN 61000-4-6: 2014
-----	Power Frequency Magnetic Field EN 61000-4-8: 2010
-----	Voltage Dip/ Interruption EN 61000-4-11: 2004

Low Voltage Equipment Directive 2006/95/EEC	
Safety Requirements	EN 61010-1: 2010 (Third Edition) EN 61010-2-030: 2010 (First Edition)

# INDEX

ACPR .....	51	Symbol .....	3
Adjacent channel power .....	51	Limit lines	
Amplitude		Creation .....	58
Reference level .....	34, 35	Overview .....	57
Scale/div .....	35	Pass/fail testing .....	59
Autoset .....	36	List of features .....	8
Horizontal settings .....	37	Marker	
Vertical settings .....	37	Delta markers .....	40
Average		Move to trace .....	43
Trace .....	65	Moving markers manually .....	41
Bandwidth		Moving markers to preset	
RBW .....	61	positions .....	42
Caution symbol .....	3	Normal marker .....	39
Cleaning the instrument .....	5	Peak search .....	46
Conventions .....	22	Peak table .....	48
Declaration of conformity .....	111	Table .....	44
Default settings .....	106	Marketing	
Display		Contact .....	105
Brightness .....	67	Measurement	
Reference level line .....	67	ACPR .....	51
Spit spectrum view .....	68	OCBW .....	54
Video out .....	68	Overview .....	50
Display diagram .....	15	OCBW .....	54
Disposal instructions .....	5	Occupied bandwidth .....	54
Disposal symbol .....	3	Package contents .....	9
EN61010		Peak search .....	46
Measurement category .....	4	Peak table .....	48
Pollution degree .....	5	Power down .....	18
Environment		Power on/off	
Safety instruction .....	5	Safety instruction .....	4
FAQ .....	104	Power up .....	18
Firmware update .....	19	RBW .....	61
First time use instructions .....	17	Rear panel diagram .....	14
Frequency		Remote control .....	78
Center frequency .....	28	Command list .....	85
Center frequency step .....	30	Command syntax .....	82
Start frequency .....	29	USB configuration .....	80
Stop frequency .....	29	Remote control function check .....	81
Front panel diagram .....	10	Restore default settings .....	21
Ground		Service operation	
		About disassembly .....	4

---

Contact.....	105	View error messages.....	77
Span		Tilting stand.....	17
Full span.....	32	Trace	
Last span.....	33	Icons.....	62
Setting.....	31	Math.....	64
Zero span.....	32	Selecting trace.....	62
Specifications.....	108	Type.....	62
Amplitude.....	108	UK power cord.....	6
Dimensions.....	110	USB driver installation.....	20
Frequency.....	108	Video out port.....	68
Sweep.....	109	Warning symbol.....	3
System			
System information.....	76		