

# Spectrum Analyzer

GSP-730

## QUICK START GUIDE

CW INSTEK PART NO. 82SP-73000MC1



## SAFETY INSTRUCTIONS

This section contains the basic safety symbols that may appear on the accompanying user manual CD or on the instrument. For detailed safety instructions and precautions, please see the Safety Instructions chapter in the user manual CD.

### Safety Symbols

These safety symbols may appear in the user manual or on the instrument.

	<b>Warning:</b> Identifies conditions or practices that could result in injury or loss of life.
	<b>Caution:</b> Identifies conditions or practices that could result in damage to the instrument or to other properties.
	<b>DANGER High Voltage</b>
	<b>Attention Refer to the Manual</b>
	<b>Protective Conductor Terminal</b>
	<b>Earth (ground) Terminal</b>
	Do not dispose electronic equipment as unsorted municipal waste. Please use a separate collection facility or contact the supplier from which this instrument was purchased.

### Power Cord for the United Kingdom

When using the instrument in the United Kingdom, make sure the power cord meets the following safety instructions.

NOTE: This lead/appliance must only be wired by competent persons.

**! WARNING: THIS APPLIANCE MUST BE EARTHED**  
**IMPORTANT:** The wires in this lead are coloured in accordance with the following code:

Green/ Yellow: Earth  
 Blue: Neutral  
 Brown: Live (Phase)



As the colours of the wires in main leads may not correspond with the coloured marking identified in your plug/appliance, proceed as follows:  
 The wire which is coloured Green & Yellow must be connected to the Earth terminal marked with either the letter E, the earth symbol  $\oplus$  or coloured Green/Green & Yellow.  
 The wire which is coloured Blue must be connected to the terminal which is marked with the letter N or coloured Blue or Black.  
 The wire which is coloured Brown must be connected to the terminal marked with the letter L or P or coloured Brown or Red.  
 If in doubt, consult the instructions provided with the equipment or contact the supplier.  
 This cable/appliance should be protected by a suitably rated and approved HBC mains fuse: refer to the rating information on the equipment and/or user instructions for details. As a guide, a cable of 0.75mm<sup>2</sup> should be protected by a 3A or 5A fuse. Larger conductors would normally require 13A types, depending on the connection method used.  
 Any exposed wiring from a cable, plug or connection that is engaged in a live socket is extremely hazardous. If a cable or plug is deemed hazardous, turn off the mains power and remove the cable, any fuses and fuse assemblies. All hazardous wiring must be immediately destroyed and replaced in accordance to the above standard.

## GETTING STARTED

This chapter provides a brief overview of the GSP-730, the package contents, instructions for first time use and an introduction to the front panel, rear panel and GUI.

### Main Features

<b>Performance</b>	<ul style="list-style-type: none"> <li>150kHz~3GHz bandwidth</li> <li>100kHz resolution</li> </ul>
<b>Features</b>	<ul style="list-style-type: none"> <li>Autoset with automatic floor level and span.</li> <li>Marker table function</li> <li>Limit line testing</li> <li>Split window display</li> <li>ACPR measurement</li> <li>OCBW measurement</li> <li>Automatic resolution bandwidth mode.</li> </ul>
<b>Interface</b>	<ul style="list-style-type: none"> <li>480x640 color LCD display</li> <li>On-screen menu icons</li> <li>VGA video output</li> <li>RS-232C</li> <li>USB 2.0 Host port for data storage</li> <li>USB 2.0 Device port for the virtual com port communication</li> </ul>

### Package Contents

Please the package contents to ensure you have all of the following items:

Part Number	Description
	User Manual CD
	Quick Start Guide (this document)
Region Dep.	Power cord x1
	Cal. Certificate

### Display and Panel Overview

#### Display Overview

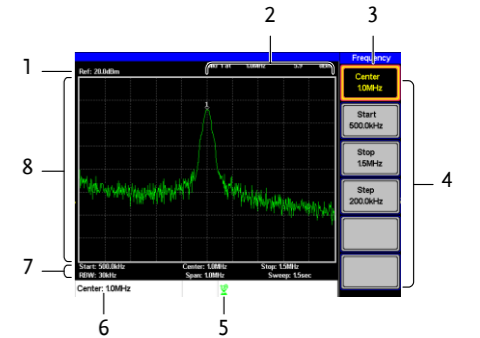

Description	
1. Reference level	2. Marker information
3. Function menu	4. Soft menu keys
5. Trace icons	6. Entry/Message area
7. Frequency / Bandwidth settings	8. Trace and waveforms

### Front Panel

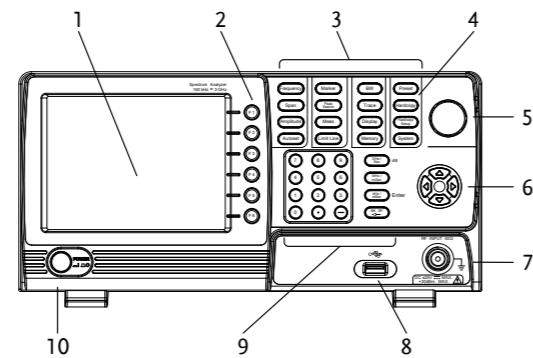

Description	
1. LCD display	2. Function keys
3. Menu keys	4. Hardcopy key
5. Scroll wheel	6. Arrow keys
7. RF terminal input	8. USB A port
9. Keypad and unit keys	10. Power button

### Rear Panel

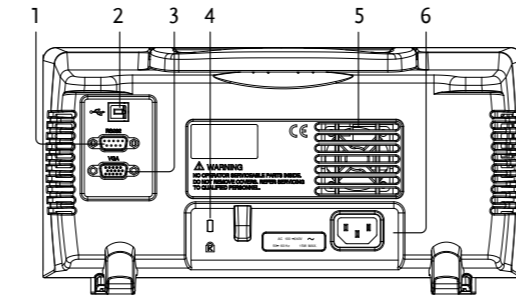

Description	
1. RS-232 port	2. USB B port
3. VGA output	4. Security slot
5. Fan	6. Power socket

### First Time Use Instructions

Use the procedures below when first using the GSP-730 to tilt the stand, power up the instrument, update the firmware and restore the unit back to the default settings. Lastly, the Conventions sections will introduce you to the basic operating conventions used throughout the user manual. For further details, please see the user manual.

### Tilting the Stand

The GSP-730 has two adjustable tabs at the front that can be used to position the instrument into two preset orientations.

Leaning position:

Set the tabs down to have the GSP-730 leaning backward.

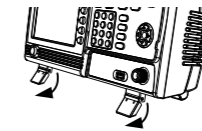

Upright Position:

Set the tabs flat to have the GSP-730 in an upright position.

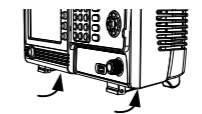

### Power Up and Down

Power Up:

1. Insert the AC power cord into the power socket.

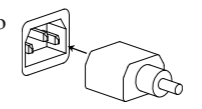

2. Press the power button to turn the GSP-730 on.



Power Down:

Press the power button to power down.



### Software Update

The GSP-730 allows the software to be updated by end-users. Before using the GSP-730, please check the GW Instek website or ask your local distributor for the latest software.

The update file, MAIN1.BIN, must be placed in the root directory of a USB flash drive.

System Version:

- Press **System** > Information[F4].
- The system version is displayed on the SW Ver[F4] icon.

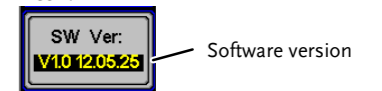

Update Software:

- Place the update file, MAIN1.BIN, into the root directory of a USB flash drive.
- Insert the USB flash drive into the USB port on the front panel.
- Press **System** > Update From USB Flash[F5].
- Press **Update Now**[F3] to execute the update process.
  - When the message  $\square$  Programmed Successful  $\square$  is displayed, the software has completed the update.
- Reboot the system when the update procedure has finished by cycling the power button.
- Check the software version again to confirm the update procedure.



This manual contains proprietary information, which is protected by copyright. All rights are reserved. No part of this manual may be photocopied, reproduced or translated to another language without prior written consent of Good Will Corporation.

The information in this manual was correct at the time of printing. However, Good Will continues to improve its products and therefore reserves the right to change the specifications, equipment, and maintenance procedures at any time without notice.

## USB Driver Installation

If the type B USB port on the rear panel is to be used for remote control, then the USB driver must be installed. The USB driver is located in the CD that accompanied this manual.

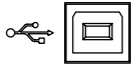
### Driver Installation:

1. Ensure the GSP-730 is turned on.
2. Connect the USB cable from the PC to the rear panel USB B port. 
3. Windows will automatically detect the GSP-730 as a new device.
4. Follow the instructions to locate the driver on the accompanying CD and install the driver.
5. To see if the driver has been successfully installed, you can check to see if the GSP-730 is recognized by the Windows Device Manager when the GSP-730 is connected to the PC.
6. In Windows XP go to: Start>Control Panel>Device Manager.
7. The GSP-730 should be shown under the Ports (COM & LPT) node: 
  - If the USB driver installation fails, you can try to manually install the driver by right clicking on the **AT91 USBSerial** icon and selecting the **Install** option.

## Restoring Default Settings

The factory default settings can be easily restored using the Preset key on the front panel. The default settings cannot be changed. See the user manual for a list of the factory default settings.

### Restore Default Settings:

Press .

- The spectrum analyzer will load the default factory settings.

### Conventions

The following conventions are used throughout the user manual. Read the conventions below for a basic grasp of how to operate the GSP-730 menu system and front panel keys.

### Soft Menu keys:

The F1 to F6 function keys on the right side of the display correspond directly to the soft-menu keys on their left.

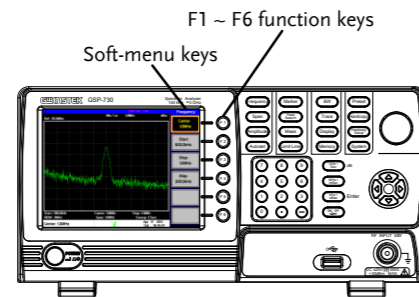

### Input Parameter Values:



Selecting this type of menu key will allow you to enter a new value with the numeric keypad or increment/decrement the value using the scroll wheel or number pad. See the parameter input description below for more details.

### Toggle State:

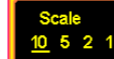

Pressing this menu key will toggle the state. Notice that any soft-menu key that can be toggled will have the active parameter underlined.

### Toggle State & Input Parameter:



Pressing this menu key will allow you to toggle the state of the function between on and off. When in the on-state, the parameter value can be manually edited. Use the numeric keypad to enter the new value or use the scroll wheel to increment/decrement the current value. Again, the setting that is underlined is the active setting.

### Sub Menu:



Pressing the More menu key will enter a submenu.

### Sub Menu to select parameter



Pressing this type of menu key will enter a submenu to select a parameter.

### Active Function:

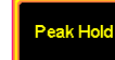

Pressing this type of menu key will activate that function. The menu key will be highlighted to show it is the active function.

### Parameter Input

Parameter values can be entered using the numeric keypad, the scroll wheel and the arrow keys.

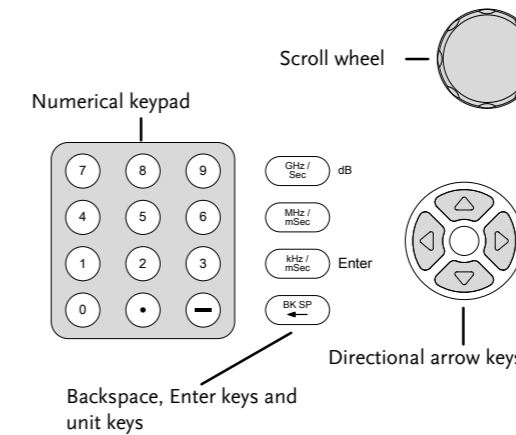

### Using the numeric keypad:

When prompted to enter a parameter, use the number keys (0-9), the decimal key (.) and the minus key (-) to enter a value. After a value has been entered, the unit keys can be used to select the units.

The value of the parameter is shown at the bottom of the screen as it is edited.



### Back Space:

Use the backspace key to delete the last character or number entered.

### Using the scroll wheel:

Use the scroll wheel to alter the current value. Clockwise increases the value, anti-clockwise decreases the value. The scroll wheel is usually used for values that highly variable, such as the center frequency settings.

### Directional arrows:

Use the directional arrows to select discrete parameters or to alter values by a coarser resolution than the scroll wheel. Left/down decreases the value, right/up increases the value. The directional arrows are usually used for values that are of a discrete nature, such as selecting a memory location.

## SPECIFICATIONS

The specifications apply when the GSP is powered on for at least 30 minutes under +20°C~+30°C.

### Frequency Specifications

<b>Frequency Range</b>	
Setting Range	150kHz to 3GHz

<b>Center Frequency</b>	
Setting Resolution	0.1MHz
Accuracy	within ±50kHz (frequency span : 0.3GHz to 2.6GHz, 20 ±5°C)

<b>Frequency Span</b>	
Setting range	1MHz to 3GHz
Accuracy	within ±3% (frequency span : 0.3GHz to 2.6GHz, 20 ±5°C)

<b>Resolution Bandwidth</b>	
Setting Range	30KHz, 100KHz, 300KHz, 1MHz, nominal -3dB bandwidth

<b>SBB Phase Noise</b>	
-85dBc / Hz (typical, 500kHz offset, RBW : 30kHz, Sweep time : 1.5s, Span: 1MHz@1GHz)	

<b>Inherent Spurious Response</b>	
less than -45dBc @ -40dBm Ref. Level (typical less than -50dBc)	

### Amplitude Specifications

<b>Reference Level</b>	
Input Range	+20 to -40dBm
Unit	dBm, dBV, dBμV

<b>Average Noise Level</b>	
≤ -100dBm (typical, center frequency : 1GHz RBW : 30kHz)	

<b>Frequency Characteristics</b>	
within ±3.0dB @300MHz~2.6GHz, within ±6.0dB @ 80~300MHz, 2.6~3GHz	
Accuracy	Within ±2dB (1GHz); SPAN:5MHz; Ref. level 0dBm, input signal -10dBm

<b>Input</b>	
Input Impedance	50ohm, nominal
Input VSWR	less than 2.0@input att≥10dB
Input damage level	+30dBm (CW average power), 25VDC
Input connector	N connector

### Sweep Specifications

<b>Sweep Time</b>	
Range	300ms to 8.4s, auto (not adjustable)
Accuracy	within ±2% ( frequency span : full span)

### General Specifications

<b>Interface</b>	
RS-232C	Sub-D female-D 9 pins
USB Connector	USB Host/Device full speed supported
VGA Output	Sub-D female 15 pins
Display	640*480 RGB color LCD

### Other Specifications

<b>Operating Temperature</b>	5 to 45°C (Guaranteed at 25 ±5°C, without soft carrying case)
<b>Operating Humidity</b>	less than 45°C / 90%RH
<b>Storage Temperature</b>	-20 to 60°C, less than 60°C / 70%RH
<b>Dimensions</b>	296 (L) × 153 (W) × 105 (H) mm
<b>Weight</b>	Approx. 2.2kg
<b>Power Source</b>	AC 100~240V, 50/60Hz

### Dimensions

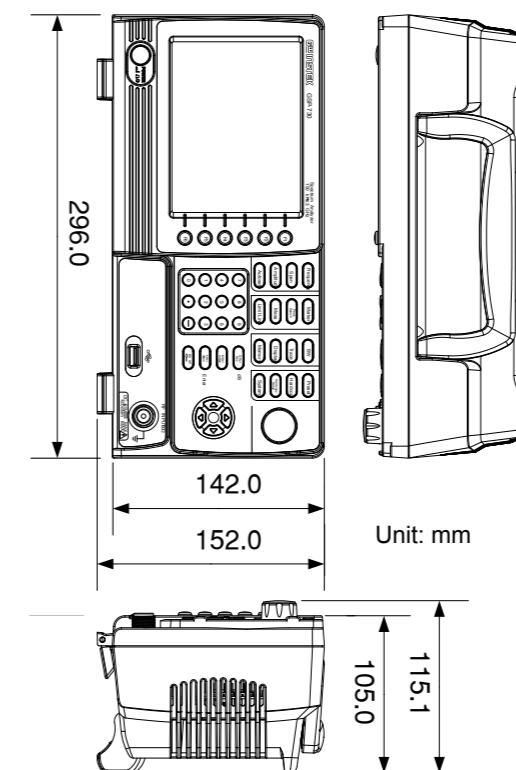

### EC Declaration of Conformity

We  
**GOOD WILL INSTRUMENT CO., LTD.**  
declare that the below mentioned product  
**Type of Product:** Spectrum Analyzer  
**Model Number:** GSP-730  
is herewith confirmed to comply with the requirements set out in the Council Directive on the Approximation of the Law of Member States relating to the EMC: 2014/30/EU, LVD: 2014/35/EU, WEEE: 2012/19/EU and RoHS: 2011/65/EU  
For the evaluation regarding the Electromagnetic Compatibility and Low Voltage Directive, the following standards were applied:

© EMC	
EN 61326-1:	Electrical equipment for measurement, control and laboratory use -- EMC requirements (2013)
EN 61326-2-1:	
Conducted & Radiated Emission EN 55011: 2016	Electrical Fast Transients IEC 61000-4-4: 2012
Current Harmonics EN 61000-3-2: 2014	Surge Immunity EN 61000-4-5: 2014
Voltage Fluctuations EN 61000-3-3: 2013	Conducted Susceptibility EN 61000-4-6: 2014
Electrostatic Discharge EN 61000-4-2: 2009	Power Frequency Magnetic Field EN 61000-4-8: 2010
Radiated Immunity EN 61000-4-3: 2006+A1:2008+A2:2010	Voltage Dip/ Interruption EN 61000-4-11: 2004

Low Voltage Equipment Directive 2014/35/EU	
Safety Requirements	EN 61010-1: 2010 (Third Edition) EN 61010-2-030: 2010 (First Edition)

**GOODWILL INSTRUMENT CO., LTD.**  
No. 7-1, Jhongsing Road, Tucheng District, New Taipei City 236, Taiwan  
Tel: +886-2-2268-0389 Fax: +886-2-2268-0639  
Web: <http://www.gwinstek.com> Email: [marketing@goodwill.com.tw](mailto:marketing@goodwill.com.tw)

**GOODWILL INSTRUMENT (SUZHOU) CO., LTD.**  
No. 521, Zhujiang Road, Snd, Suzhou Jiansu 215011, China  
Tel: +86-512-6661-7177 Fax: +86-512-6661-7277  
Web: <http://www.instek.com.cn> Email: [marketing@instek.com.cn](mailto:marketing@instek.com.cn)

**GOODWILL INSTRUMENT EURO B.V.**  
De Run 5427A, 5504DG Veldhoven, The Netherlands  
Tel: +31-(0)40-2557790 Fax: +31-(0)40-2541194  
Email: [sales@gw-instek.eu](mailto:sales@gw-instek.eu)