

Current Probe and Power Supply

USER MANUAL

GW INSTEK PART NO. 82CP-425PoMo1



ISO-9001 CERTIFIED MANUFACTURER

GW INSTEK

November 2010 edition

This manual contains proprietary information, which is protected by copyright. All rights are reserved. No part of this manual may be photocopied, reproduced or translated to another language without prior written consent of Good Will Corporation.

The information in this manual was correct at the time of printing. However, Good Will continues to improve its products and therefore reserves the right to change the specifications, equipment, and maintenance procedures at any time without notice.

Good Will Instrument Co., Ltd.
No. 7-1, Jhongsing Rd., Tucheng City, Taipei County 236, Taiwan.

Table of Contents

SAFETY INSTRUCTIONS	5
Safety Symbols	5
PRECAUTIONS	7
Preliminary Check	7
OVERVIEW	13
Current Probe Overview	13
Features	13
Names of Parts (Current Probe)	14
External view.....	14
Parts of the Sensor	15
Names of Parts (Power supply)	17
MEASURE PROCEDURE	20
Preparations for Measurement (Current Probe).....	20
Demagnetizing and Zero Adjustment	22
Measurement Procedure (Current Probe)	24
Preparations (Power supply)	30
Measurement Procedure (Power supply)	31
APPENDIX	32
Fuse Replacement (for GCP-206P only)	32
Change the power supply voltage setting	34
Current Probe Specifications	35
Model-specific specifications.....	35
Common specifications (for GCP-530 and GCP-1030)	36
Power Supply Specifications	39
Model-specific specifications.....	39
Common specifications (for GCP-206P and GCP-425P).....	40

S SAFETY INSTRUCTIONS

Safety Symbols

This manual contains information and warnings essential for safe operation of the device and for maintaining it in safe operating condition. Before using the device, be sure to carefully read the following safety notes.



The **⚠** symbol printed on the device indicates that the user should refer to a corresponding topic in the manual (marked with the **⚠** symbol) before using the relevant function.

In the manual, the **⚠** symbol indicates particularly important information that the user should read before using the device.



Indicates that application around or removal from live lines is only permitted on condition that the lines are insulated.



Indicates a grounding terminal



Indicates AC (Alternating Current)



Indicates the ON side of the power switch.





Indicates the OFF side of the power switch.



Indicates a fuse.

The following symbols in this manual indicate the relative importance of cautions and warnings.

 **DANGER** Indicates that incorrect operation presents an extreme hazard that could result in serious injury or death to the user.

 **WARNING** Indicates that incorrect operation presents a significant hazard that could result in serious injury or death to the user.

 **CAUTION** Indicates that incorrect operation presents a possibility of injury to the user or damage to the device.

NOTE Indicates advisory items related to performance or correct operation of the device.

(Measurement categories) EN 61010-1:2001 specifies the measurement categories and their requirements as follows. The device falls under category I.

- Measurement category IV is for measurement performed at the source of a low-voltage installation.
- Measurement category III is for measurement performed in a building installation.
- Measurement category II is for measurement performed on circuits directly connected to a low voltage installation.
- Measurement category I is for measurements performed on circuits not directly connected to Mains.

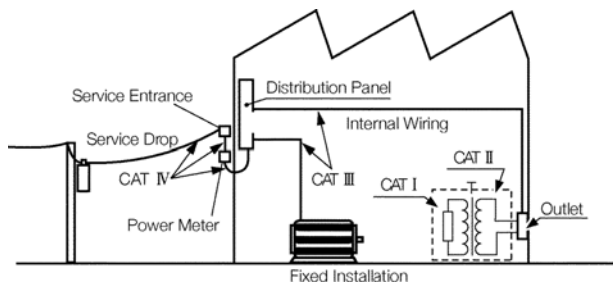

P RECAUTIONS

Follow these precautions to ensure safe operation and to obtain the full benefits of the various functions.

Preliminary Check

Before using the device the first time, verify that it operates normally to ensure that no damage occurred during storage or shipping. If you find any damage, contact your dealer.



- To avoid short circuits and potentially life-threatening hazards, never attach the GCP-530 or GCP-1030 to a circuit that operates at more than 300V, or over bare conductors.
- When conductors being measured carry in excess of the safe voltage level (SELV-E) and not more than 300 V, to prevent short circuits and electric shock while the core section is open, make sure that conductors to be measured are insulated with material conforming to
 - (1) Measurement Category I ,
 - (2) Basic Insulation Requirements for Working Voltages of 300 V, and
 - (3) Pollution Degree 2.For safety's sake, never use this sensor on bare conductors. The core and shield case are not insulated.

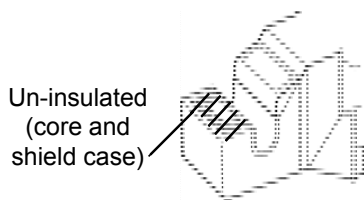

- Be careful to avoid damaging the insulation surface while taking measurements.
 - This instrument is made for use with the GCP-206P or GCP-425P POWER SUPPLY. It is possible to use a power supply other than the GCP-206P or GCP-425P, provided that the connector and pin assignments match, and that voltage and other electrical specifications are satisfied. In the interest of safety, make sure that the power supply has a protective earthing with double- insulation construction.
 - Make sure that the waveform measuring equipment connected to this device's output terminal (BNC) is equipped with a protective earthing with double-insulation construction.
 - If the waveform measuring instrument being connected to the output terminal (BNC) on this device is equipped with any other measurement terminals, take the following precautions to ensure that the other instrument does not form a bridge between the probe and any hazardous live of a part.
1. Isolate the terminal to which the probe is connected from other terminals on the measuring instrument using basic insulation conforming to the measurement category, working voltage, and pollution degree requirements of the circuit being tested.

2. If basic insulation requirements cannot be met between the terminal to which this device is connected and other terminals of the measuring instrument, make sure that the voltage input to the measurement terminal does not exceed the safe voltage level (SELV- E).
3. Read and observe all warnings and precautions relating to electrical safety for the measuring instrument being connected to the probe.

Refer to the following standards regarding the meanings of underlined terms.

IEC61010-1

IEC61010-031

IEC61010-2-032

- Be sure to observe all operating precautions for the waveform monitoring instrument (oscilloscope or recorder) and other measurement instruments to which this device is connected.
- When using a measurement instrument that does not provide isolation between its input terminals and chassis or other input terminals, please pay attention to the following points. If a signal is applied to an input terminal other than that to which this device is connected, do not connect the ground-side terminal to any non-ground potential. Otherwise, short-circuit current will flow through the GCP-206P or GCP-425P or this device from the ground terminal, which could cause an electrical accident or damage.

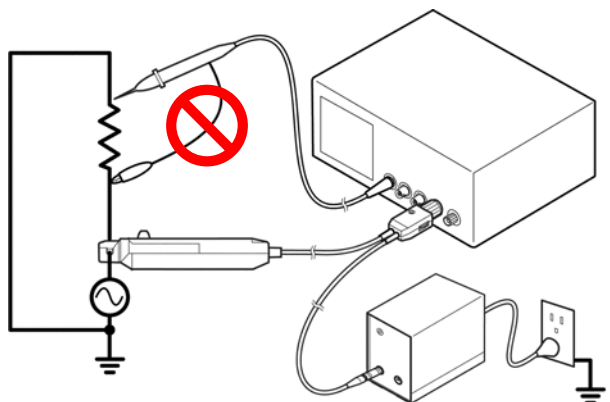

 WARNING

- Do not allow the device to get wet, and do not take measurements with wet hands. This may cause an electric shock.
- To avoid electric shock when measuring live lines, wear appropriate protective gear, such as insulated rubber gloves, boots and a safety helmet.

 CAUTION

- To avoid damage to the device, protect it from physical shock when transporting and handling. Be especially careful to avoid physical shock from dropping.
- This device should be installed and operated indoors only, between 0 and 40°C (32 to 104°F) and 80% RH or less.
- Do not store or use the device where it could be exposed to direct sunlight, high temperature or humidity, or condensation. Under such conditions, the device may be damaged and insulation may deteriorate so that it no longer meets specifications.
- This device is not designed to be entirely waterproof or dustproof. To avoid damage, do not use it in a wet or dusty environment.

- The sensor head is a precision assembly including a molded component, a ferrite core, and a Hall effect element. It may be damaged if subjected to sudden changes in ambient temperature, or mechanical strain or shock, and therefore great care should be exercised in handling it.
- The matching surfaces of the sensor head are precisely ground, and should be treated with care. If these surfaces are scratched, performance may be impaired.
- To avoid damaging the sensor cables, do not bend or pull the sensor cable and power supply cable.
- To clean the device, wipe it gently with a soft cloth moistened with water or mild detergent. Never use solvents such as benzene, alcohol, acetone, ether, ketones, thinners or gasoline, as they can deform and discolor the case.
- When the power is on, keep the core section of the sensor closed, except when clamping them onto the conductor to be measured. The facing surface of the core section can be scratched while it is open.
- Keep the clamp jaws and core slits free from foreign objects, which could interfere with clamping action.
- Keep the sensor head closed when not in use, to avoid accumulating dust or dirt on the mating core surfaces, which could interfere with clamp performance.
- Avoid stepping on or pinching the cable, which could damage the cable insulation.
- Keep the cables well away from heat sources, as bare conductors could be exposed if the insulation melts.

NOTE

- Correct measurement may be impossible in the presence of strong magnetic fields, such as near transformers and high-current conductors, or in the presence of strong electromagnetic fields such as near radio transmitters.
- When sending the device for repair, carefully to prevent damage in transit. Include cushioning material so the instrument cannot move within the package. Be sure to include details of the problem.

O VERVIEW

Current Probe Overview

This device can be directly connected to a BNC input connector of a waveform measuring instrument such as an oscilloscope or recorder, and by clamping on a conductor to be measured, allows the current waveform to be easily captured.

Features

- Highly accurate current detection
- Easy current measurement
- Broadband frequency characteristics DC to 50 MHz(for GCP-530)
- Broadband frequency characteristics DC to 100 MHz(for GCP-1030)
- Compact and permits measurement of low current levels
- Easy protect function at excessive input

Names of Parts (Current Probe)

External view

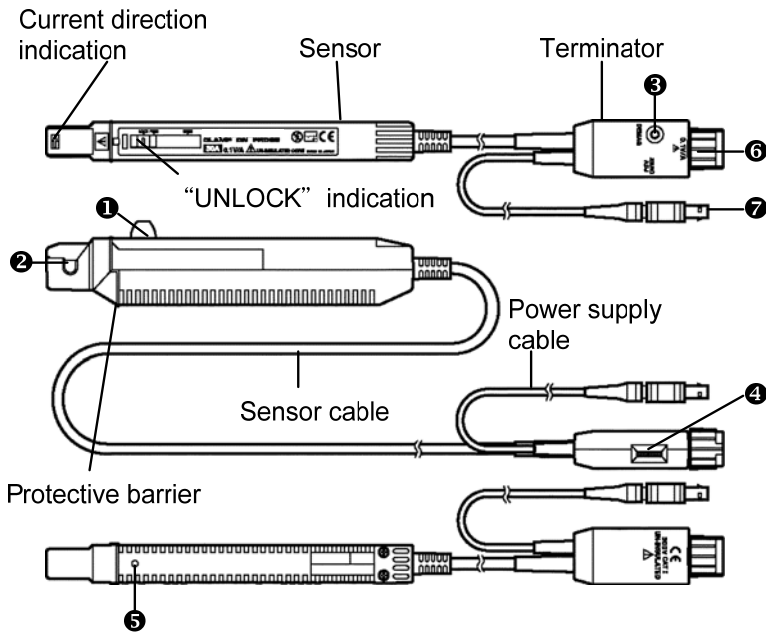

Parts of the Sensor

- 1** Opening lever Operating lever for opening the sensor head. Always use this lever to open the sensor head.
- 2** Sensor head This clamps the conductor being measured, and carries out the actual current measurement. It is a precision assembly including a molded component, a ferrite core, and a Hall effect element. It may be damaged if subjected to sudden changes in ambient temperature, or mechanical strain or shock, and therefore great care should be exercised in handling it.
- 3** Demagnetizing switch (DEMAG) This demagnetizes the core if it has been magnetized by switching the power on and off, or by an excessive input. Always carry out demagnetizing before measurement. The demagnetizing process takes about one second. During demagnetizing, a demagnetizing waveform is output.
- 4** Zero adjustment dial (ZERO ADJ) Use the zero adjustment dial to correct for the effect of a voltage offset or temperature drift on the device. When beginning measurement, after demagnetizing always carry out zero adjustment.
- 5** Coarse adjustment trimmer Use this only when adjustment is not possible within the range of the zero adjustment dial. Use a nonconductive screwdriver (e.g. ceramic driver) for adjustment.
- 6** Output connector The current waveform of the measured conductor is output at a constant rate (0.1 V/A).

Connect to the BNC input connector of the waveform measuring instrument.
- 7** Power plug Connect this to the GCP-206P or GCP-425P POWER SUPPLY receptacle to supply power to the sensor terminator.



To avoid electric shock, do not touch the portion beyond the protective barrier during use.

NOTE

- The output of this device is terminated internally. Use a high-impedance input to the measuring instrument. With an input impedance of 50Ω , accurate measurement is not possible.
- If using BNC-banana plug adapters or similar to connect to input terminals other than BNC connectors, make sure the polarity is correct.
- Turn the collar until it clicks, and check that it is locked securely.

Names of Parts (Power supply)

Front view

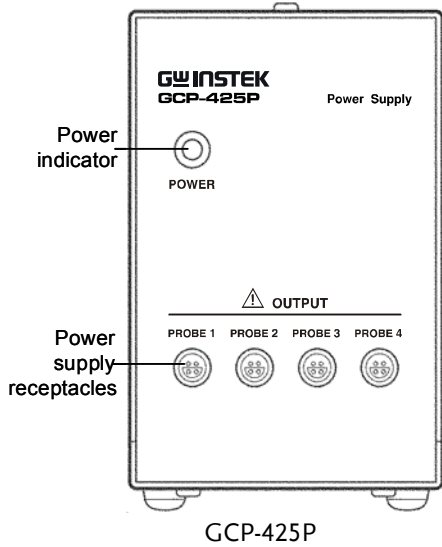

Rear View

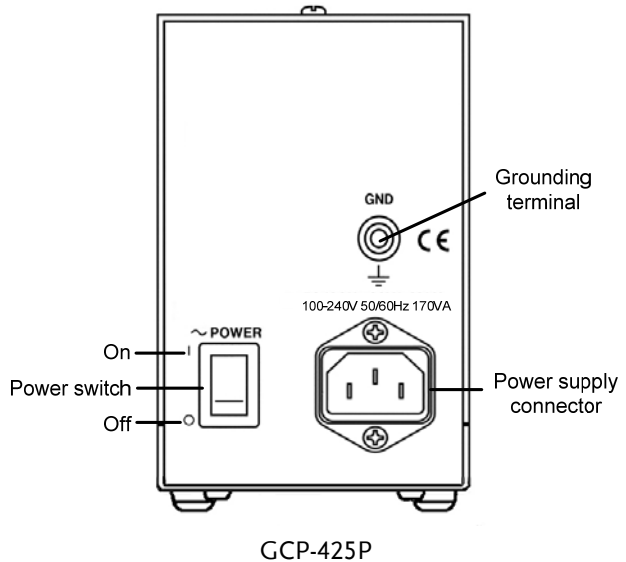

Front view

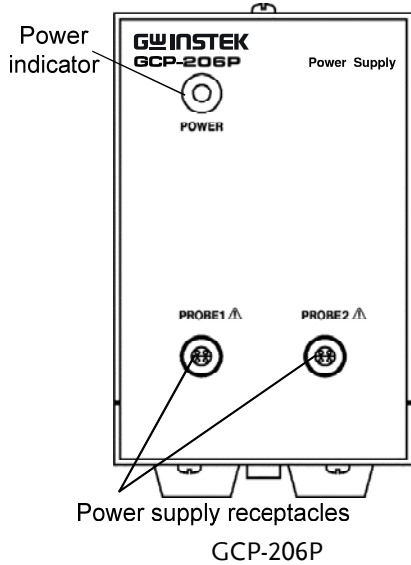

Rear View

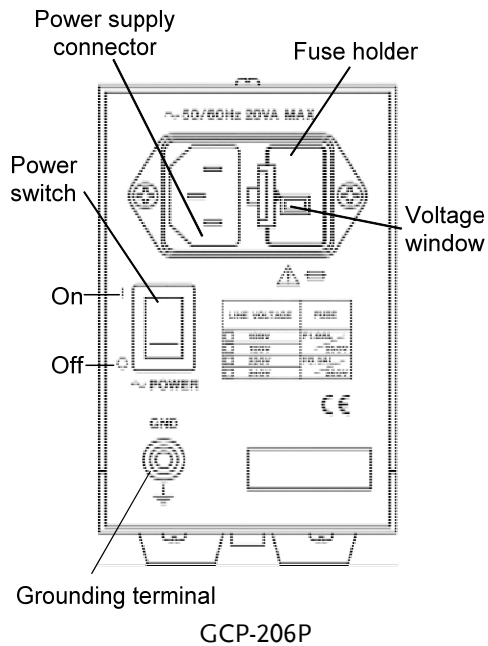

Power Supply
Receptacle

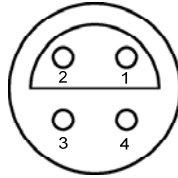

1 Not used

2 Ground

3 -12V

4 +12V

M EASURE PROCEDURE

Preparations for Measurement (Current Probe)

Procedure

1. Have the GCP-206P or GCP-425P POWER SUPPLY, and oscilloscope or recorder for waveform measurement ready.



CAUTION

Before turning on the power, make sure that the voltage of the power supply being used matches the supply voltage indicated on the rear panel of the GCP-206P or GCP-425P

NOTE

The output of this device is terminated internally. Use a high-impedance input to the measuring instrument. With an input impedance of 50Ω , accurate measurement is not possible.

2. Turn the power switch off and connect the power cord.
3. Connect the power plug of the GCP-530 or GCP-1030 to the power receptacle of the GCP-206P or GCP-425P.

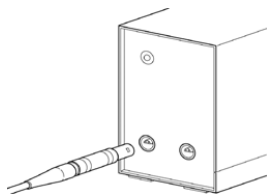

4. Turn the GCP-206P or GCP-425P power switch

Demagnetizing and Zero Adjustment

- Procedure
1. With the waveform measurement instrument input at ground, adjust the trace to the zero position.
 2. Set the input coupling of the waveform measurement instrument to DC.
 3. Connect the output connector of the GCP-530 or GCP-1030 to the input connector of the waveform measurement instrument. Turn the collar until it clicks, and check that it is locked securely.

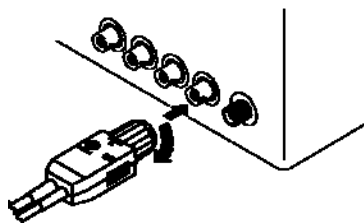

 CAUTION

- When disconnecting the output connector, be sure to release the lock before pulling off the connector. Forcibly pulling the connector without releasing the lock, or pulling on the cable, can damage the terminator.
- If using BNC-banana plug adapters or similar to connect to input terminals other than BNC connectors, make sure the polarity is correct.

- Do not demagnetize while the GCP-530 or GCP-1030 is clamping a conductor to be measured. Demagnetizing causes current to flow into the conductor, which may damage parts in the circuit to be measured.

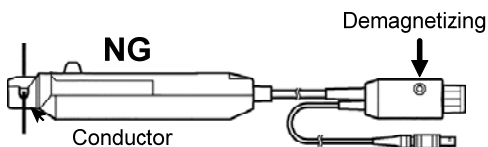

- Check that the conductor being measured is not clamped when supplying power to the GCP-530 or GCP-1030 for the same reason. Demagnetized waveforms are generated when supplying electric power.

4. Without clamping the conductor to be measured, press the opening lever until the "UNLOCK" indication disappears, and check that the sensor head is properly closed.
5. Press the demagnetizing switch (DEMAG) on the terminator.
6. Turn the zero adjustment dial on the terminator, to adjust the trace to the zero position.
7. If zero adjustment is not possible in step 6, turn the coarse adjustment trimmer to bring the trace within the range of adjustment by the zero adjustment dial.

Measurement Procedure (Current Probe)

- Procedure
1. Check that the system is safe, and that the preparations described in the preceding section have been carried out.
 2. Pull the sensor opening lever, so that the sensor head opens.

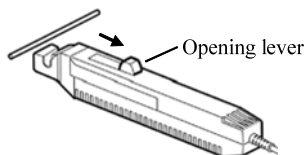

3. Align the sensor so that the current direction indication corresponds to the direction of current flow through the conductor to be measured, and clamp so that the conductor is in the center of the sensor aperture.
4. Press the opening lever on the sensor head until the "UNLOCK" indication disappears, and check that the opening lever is firmly locked and the sensor head securely closed.

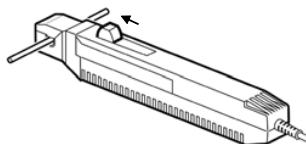

5. It is now possible to monitor the current waveform. The output rate of the GCP-530 or GCP is 0.1 V/A. The current sensitivity can be derived from the voltage sensitivity of the waveform measurement instrument. For example, if the voltage sensitivity is 10mV/division, the current sensitivity is 100mA/division.

NOTE

- When using the GCP-530 or GCP-1030, note that two current probes may not be used simultaneously with the GCP-425P POWER SUPPLY, depending on the current to be measured.
- The current consumption of current probes depends on the current to be measured. Confirm that the total current consumption of the current probes do not exceed the rated output current of the GCP-425P. See Fig. 1.

Fig. 1

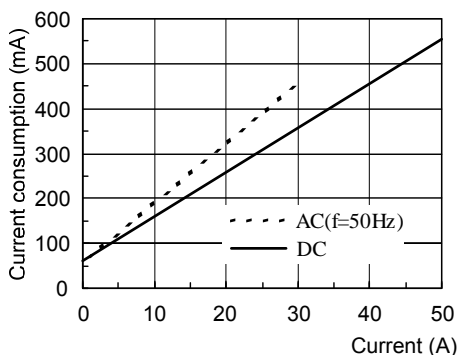

Current consumption* vs. current to be measured(typical)

*The sum total of a positive and negative current consumption



- The maximum continuous input range is based on heat that is internally generated during measurement. Never input current in excess of this level. Exceeding the rated level may result in damage to the probe.
- The maximum continuous input range varies according to the frequency of the current being measured. See the figures 3 on page 37 .
- If excess current is input, generated heat activates a built-in safety function that blocks normal output. If this happens, remove the input immediately (remove the sensor from the conductor being measured, or reduce the input current to zero). Wait until the sensor has had sufficient time to cool before resuming operation.
- Even if the input current does not exceed the rated continuous maximum, continuous input for an extended period of time may result in activation of the safety circuit to prevent damage resulting from heating of the sensor.
- At high ambient temperatures, the built-in safety circuit may activate at current input levels below the rated continuous maximum.
- Continuous input of current exceeding the rated maximum or repeated safety circuit activation will degrade performance of the safety circuit, possibly resulting in damage to the device.
- The maximum input range is indicated by the continuous maximum input range. It is also indicated by another product specification Maximum peak current: Noncontinuous 50 A peak. This means that the upper limit of the waveform response is 50 A peak. Make sure that the input does not exceed the continuous maximum input range in rms.

- Do not place any unclamped conductor with an electric current of a frequency of 10 kHz or more near the sensor head. Current flowing in the conductor nearby may heat up the sensor head and cause its temperature to rise, leading to damage to the sensor. For example, when one side of a go-and-return conductor is clamped and the other side is also placed near the sensor head as shown in the diagram, even if the electric current is lower than the consecutive maximum current, electric currents in both sides will heat up the wires and raise the temperature, thereby causing damage to the sensor.

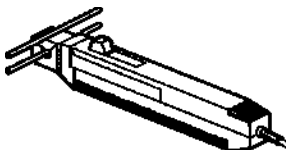

- When opening the sensor head of the probe, be sure to operate with the opening lever. If an upper core is forced to open, when the sensor head is locked, the open-close mechanism can be damaged.

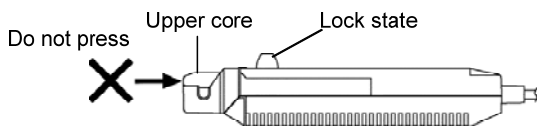

NOTE

- The output of this device is terminated internally. Use a waveform measurement instrument with an input impedance of at least 1 M Ω .
- Immediately after powering on, this device may be subject to an appreciable offset drift due to the effect of self-heating. To counteract this, allow the device to warm up for about 30 minutes before carrying out measurement.

- Depending on the measured current frequency, however some sound may be produced by resonance, it has no effect on measurements.
- When performing continuous measurements, it is necessary to be aware that the offset voltage drifts, depending on factors such as the ambient temperature.
- Under certain circumstances, oscillation may occur if the probe is connected to the GCP-206P or GCP-425P POWER SUPPLY while the power supply is on. This does not indicate a malfunction. Oscillation can be stopped and operation restored to normal by opening and closing the sensor head.
- Depending on the measured current frequency, however some sound may be produced by resonance, it has no effect on measurement.
- The measurement may be affected by the position within the clamp aperture of the conductor being measured. The conductor should be in the center of the clamp aperture.
- When carrying out measurement, press the opening lever until the "UNLOCK" indication disappears, and check that the sensor head is properly closed. If the sensor head is not properly closed, accurate measurement will not be possible.

- At high frequencies, common mode noise may affect measurements taken on the high voltage side of circuits. If this occurs, reduce the frequency range of the waveform measuring instrument, or clamp onto the low voltage side of the circuit, as appropriate.

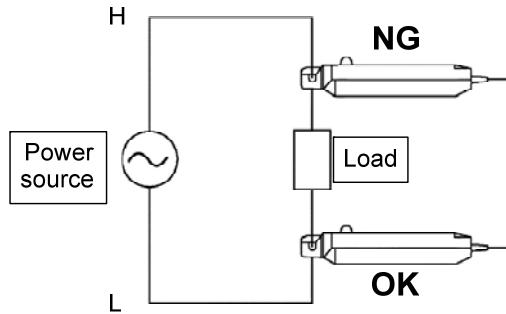

- Accurate measurement may be impossible in locations subject to strong external magnetic fields, such as transformers and high-current conductors, or in locations subject to strong external electric fields, such as radio transmission equipment.

Preparations (Power supply)

- Procedure
1. Turn the power switch off and connect the power cord. To ensure safety, connect the power cord to a properly grounded outlet.
 2. Connect the power plug of the sensor to be used to the power receptacle of the GCP-206 or GCP-425P.
 3. Turn the GCP-206 or GCP-425P power switch on, and check that the front panel power indicator lights.
-

**WARNING**

Before turning the device on, make sure the supply voltage matches that indicated on its power connector. Connection to an improper supply voltage may damage the device and present an electrical hazard.

**DANGER**

- To avoid accidents, when using other measurement devices with this one, observe the usage precautions described for each device.
- To avoid electric shock or damage, when connecting the current probe to a measurement device that does not have its input terminals isolated from the chassis, or to an device that does not have its input terminals isolated from one another and signals are applied to other terminals, do not connect the grounding terminal to any point that is not at ground potential. Otherwise, if the grounding terminal is connected to a point that is not at ground potential, a short circuit will occur.

Measurement Procedure (Power supply)

NOTE

- Make sure the sum of the current consumption of the connected current probe(s) does not exceed the rated output current of the GCP-425P (See Fig.1) on page 25.
- When using the GCP-425P with Model GCP-530 or GCP-1030 Current Probe, in general only one current probe may be connected. However, depending on the current level of the object under test, two current probes may be connected simultaneously.
- The current consumption of a current probe is dependent upon the current level of the object under test.

APPENDIX

The power supply fuse for the GCP-425P, and the power supply voltage selector, are housed in the power input socket on the rear panel.

Fuse Replacement (for GCP-206P only)

- Procedure
1. Turn the power switch off, and then disconnect the power cord.
 2. Using a flat screwdriver, pry the catch which holds the fuse holder into the power input socket as shown in the figure, and then remove the fuse holder.

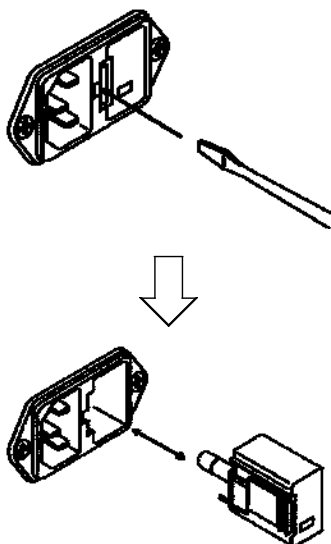

3. Remove the fuse on the fuse holder and replace with a new one of the same rating and specification.

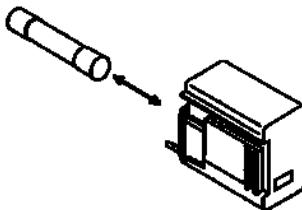

4. Insert the fuse holder back into the power input socket to finish the replacement of fuse.

Change the power supply voltage setting

- Procedure
1. Repeat steps 1-2 in the “Fuse replacement” section on page 32.
 2. Remove the voltage selector from the fuse holder, rotate it to the desired supply voltage value and then insert back into the fuse holder. The voltage value will appear in the voltage window. Check the setting value again.

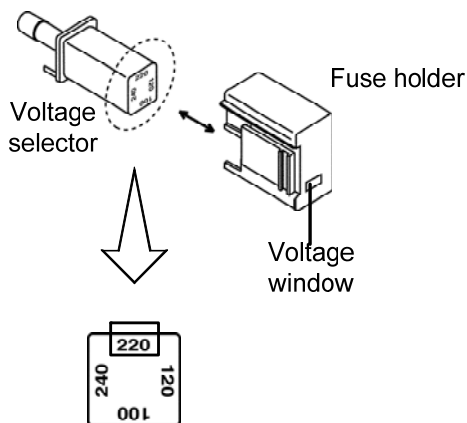

3. Insert the fuse holder back into the power input socket to finish setting the supply voltage setting.

Current Probe Specifications

Accuracy is guaranteed at 23°C~+5°C (72°F±9°F) after the power has been on for 30 minutes.

Model-specific specifications

	GCP-530	GCP-1030
Frequency range	DC to 50 MHz (-3 dB) (Characteristics shown in Fig. 2A)	DC to 100 MHz (-3 dB) (Characteristics shown in Fig. 2B)
Rise time	7 ns or less	3.5 ns or less
Maximum rated power	5.6 VA	5.3 VA
Weight	Approx. 230g(8.1oz)	Approx. 240g(8.5oz)
Accessories	Instruction manual, Soft case	Instruction manual, Carrying case

Fig. 2A
Frequency characteristics
(Typical characteristics)

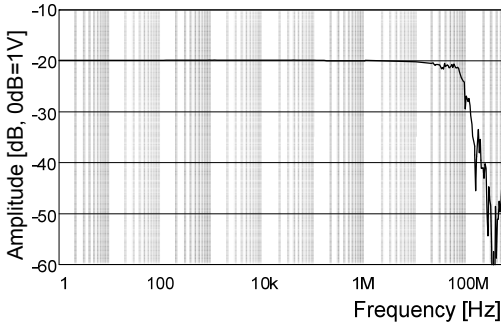
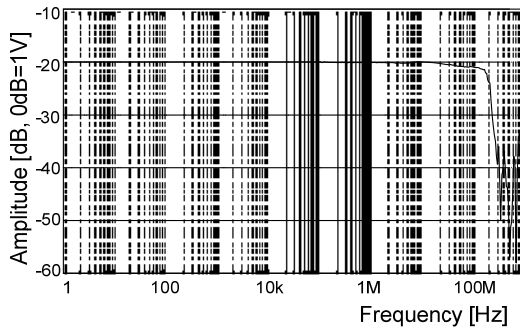

Fig. 2B
Frequency characteristics
(Typical characteristics)



Common specifications (for GCP-530 and GCP-1030)

	GCP-530	GCP-1030
Operating temperature and humidity range	0 to 40°C (32 to 104°F), 80 % RH or less (no condensation)	
Rated Supply voltage	±12 V ±0.5 V	
Maximum Peak Current Input	Non-continuous 50 Apeak	
Maximum Continuous Input Range	30 Arms (Derating according to frequency shown in Fig. 3A and 3B)	
Output Voltage Rate	0.1 V/A	
Amplitude Accuracy	+1.0% rdg. ±1 mV ; up to 30 Arms +2.0% rdg. ; over 30 Arms to 50 Apeak (DC, and 45 to 66 Hz, input within continuous maximum input range)	
Noise	Equivalent to 2.5 mArms or less (for 20 MHz band measuring instrument)	
Input Impedance	(Characteristics shown in Fig.4A and 4B)	
Temperature Coefficient for Sensitivity	±2% or less (During input of 50 Hz 30 Arms within range of 0 to 40°C (32 to 104°F)	
Storage Temperature and Humidity Range	-10 to 50°C (14 to 122°F), 80 % RH or less (no condensation)	
Location for Use	Indoor, altitude up to 2000 m (6562 feet)	
Effect of External Magnetic Fields	Equivalent to a maximum of 20 mA (DC and 60 Hz, Magnetic field of 400 A/m)	
Maximum Rated Voltage	300 V, CAT I (insulated conductor)	
Diameter of Measurable Conductors	5 mm dia. 0.2" dia.	
Guaranteed Accuracy Period	1 year (Opening/closing up to 10,000 times)	
Cable Lengths	Sensor cable Approx. 1.5 m (59.0"), Power supply cable Approx. 1 m (39.4")	

External dimensions	Sensor:
	Approx. 175(W)×18(H)×40(D)mm
	Approx. 6.89"(W)×0.71"(H)×1.58"(D)(excluding protrusions)
	Terminator:
	Approx. 55(W)×27(H) ×18(D) mm
	Approx. 2.17"(H) ×1.06"(W)×0.71"(D)

Fig.3 Derating according to frequency (For GCP -530)

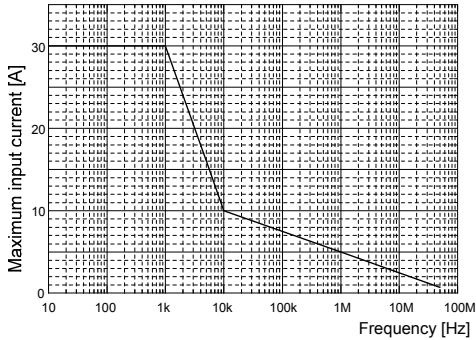

Fig.3 Derating according to frequency (For GCP -1030)

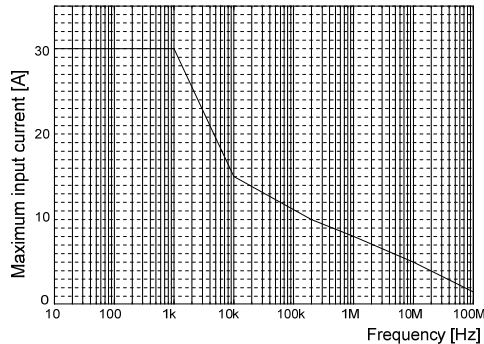

Fig.4 Input impedance (For GCP-530)

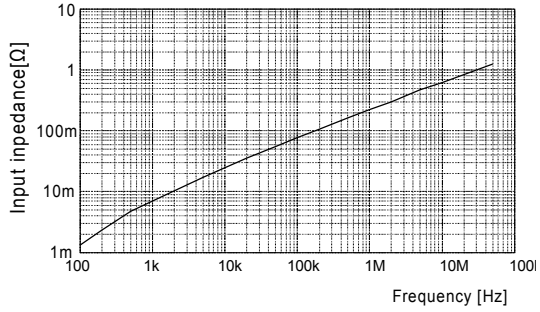
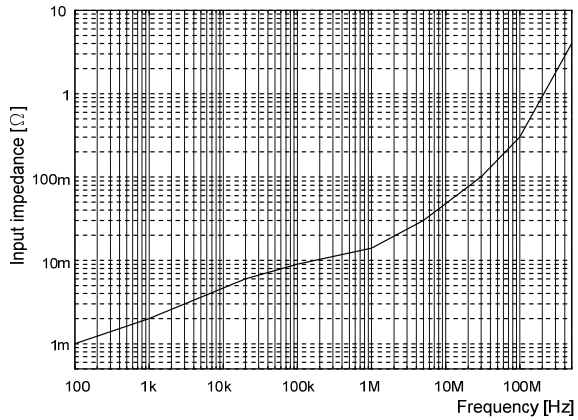

Fig.4 Input impedance (For GCP-1030)



Power Supply Specifications

Model-specific specifications

Cable Lengths Sensor cable Approx. 1.5 m (59.0"),
 Power supply cable Approx. 1 m (39.4")

	GCP-425P	GCP-206P
Number of power supply connectors	4	2
Rated output current	±2.5 A (sum total of all channels)	600 mA (sum total of all channels and all output voltages)
Ripple voltage	50 mVp-p or less	3 mVp-p or less (at rated output current)
Load influence	Within output voltage limits indicated above for current output in the range 0 to ±2.5 A	Within output voltage limits indicated above for current output in the range 0 to 600 mA
Maximum rated power	170 VA	20 VA
Dimensions	Approx. 80W × 119H × 200D mm 3.15"W × 4.69"H × 7.87"D	Approx. 73W × 110H × 186D mm 2.87"W × 4.33"H × 7.32"D
Weight	Approx. 1.2 kg (42.3 oz.)	Approx. 1.1 kg (38.8 oz.)
Accessories	Instruction Manual, Power cord	Power cord, Instruction manual, Spare fuse F1.0 AL/250 V, 20 mm × 5 mm dia. (for 100 V and 120 V models) or F0.5 AL/250 V, 20 mm × 5 mm dia. (for 220 V and 240 V models)
Rated supply voltage	100 to 240V AC (50/60Hz) (Voltage fluctuations of ±10% from the rated supply voltage are taken into account.)	100 V AC (120, 220, and 240 V require specification) (Voltage fluctuation of 10% from the rated supply voltage are taken into account.)
Power supply voltage influence	Within output voltage limits indicated above for the rated power supply voltage, 10%	

Rated supply frequency 50/60 Hz

Common specifications (for GCP-206P and GCP-425P)

Compatible sensors	GCP-530, GCP-1030 Current Probe
Output voltage	$\pm 12\text{ V} \pm 0.5\text{ V}$
Temperature influence	Within output voltage limits indicated above for ambient temperature in the range 0 to 40°C (32 to 104°F)
Operating temperature and humidity range	0 to 40°C(32 to 104°F), 80%RH or less (no condensation)
Storage temperature and humidity range	-10 to 50°C(14 to 122°F), 80%RH or less (no condensation)
Location for use	
Standards applying	Indoor, altitude up to 2000 m (6562 feet)