

# Multi-Range DC Power Supply

PSW Series

---

**USER MANUAL**



ISO-9001 CERTIFIED MANUFACTURER

**GW INSTEK**

This manual contains proprietary information, which is protected by copyright. All rights are reserved. No part of this manual may be photocopied, reproduced or translated to another language without prior written consent of Good Will company.

The information in this manual was correct at the time of printing. However, Good Will continues to improve products and reserves the rights to change specification, equipment, and maintenance procedures at any time without notice.

# Table of Contents

<b>SAFETY INSTRUCTIONS .....</b>	<b>5</b>
<b>GETTING STARTED.....</b>	<b>8</b>
PSW Series Overview .....	9
Appearance.....	15
Theory of Operation .....	22
<b>OPERATION .....</b>	<b>42</b>
Set Up .....	44
Basic Operation.....	62
Parallel / Series Operation .....	75
Test Scripts.....	89
<b>CONFIGURATION.....</b>	<b>100</b>
Configuration .....	101
<b>ANALOG CONTROL.....</b>	<b>120</b>
Analog Remote Control Overview .....	121
Remote Monitoring.....	137
<b>COMMUNICATION INTERFACE .....</b>	<b>142</b>
Interface Configuration.....	143
<b>MAINTENANCE .....</b>	<b>158</b>
<b>FAQ.....</b>	<b>160</b>
<b>APPENDIX.....</b>	<b>162</b>
PSW Default Settings.....	163
Error Messages & Messages.....	166

LED Display Format .....	166
PSW Specifications .....	167
PSW Dimensions .....	182
Certificate Of Compliance .....	187
<b>I</b> NDEX .....	<b>188</b>

# S SAFETY INSTRUCTIONS

This chapter contains important safety instructions that you must follow during operation and storage. Read the following before any operation to insure your safety and to keep the instrument in the best possible condition.

## Safety Symbols

These safety symbols may appear in this manual or on the instrument.

---



WARNING

Warning: Identifies conditions or practices that could result in injury or loss of life.



CAUTION

Caution: Identifies conditions or practices that could result in damage to the PSW or to other properties.



DANGER High Voltage



Attention Refer to the Manual



Protective Conductor Terminal



Earth (ground) Terminal



Do not dispose electronic equipment as unsorted municipal waste. Please use a separate collection facility or contact the supplier from which this instrument was purchased.

## Safety Guidelines

---

### General Guideline



CAUTION

- Do not place any heavy object on the PSW.
- Avoid severe impact or rough handling that leads to damaging the PSW.
- Do not discharge static electricity to the PSW.
- Use only mating connectors, not bare wires, for the terminals.
- Do not block the cooling fan opening.
- Do not disassemble the PSW unless you are qualified.

### Power Supply



WARNING

- AC Input voltage rating: 100Vac-240Vac +/-10%
- Frequency: 47Hz~63Hz
- To avoid electrical shock connect the protective grounding conductor of the AC power cord to an earth ground.

### Cleaning the PSW

- Disconnect the power cord before cleaning.
- Use a soft cloth dampened in a solution of mild detergent and water. Do not spray any liquid.
- Do not use chemicals containing harsh material such as benzene, toluene, xylene, and acetone.

### Operation Environment

- Location: Indoor, no direct sunlight, dust free, almost non-conductive pollution (Note below)
- Relative Humidity: 20%~ 85%
- Altitude: < 2000m
- Temperature: 0°C to 50°C

- Mains supply voltage fluctuations: +/-10 %
- Overvoltage category: OVC II
- If the equipment is used in a manner not specified by the manufacturer, the protection provided by the equipment may be impaired.
- LAN, RS232/RS485, USB, and GPIB ports are only to be connected to the circuits which are separated from mains supply by double / reinforce insulation.

(Pollution Degree) EN 61010-1 and EN 61010-2-030 specify the pollution degrees and their requirements as follows. The PSW falls under degree 2.

Pollution refers to “addition of foreign matter, solid, liquid, or gaseous (ionized gases), that may produce a reduction of dielectric strength or surface resistivity”.

- Pollution degree 1: No pollution or only dry, non-conductive pollution occurs. The pollution has no influence.
- Pollution degree 2: Normally only non-conductive pollution occurs. Occasionally, however, a temporary conductivity caused by condensation must be expected.
- Pollution degree 3: Conductive pollution occurs, or dry, non-conductive pollution occurs which becomes conductive due to condensation which is expected. In such conditions, equipment is normally protected against exposure to direct sunlight, precipitation, and full wind pressure, but neither temperature nor humidity is controlled.

---

#### Storage environment

- Location: Indoor
  - Temperature: -25°C to 70°C
  - Relative Humidity: <90%, no condensation
- 

#### Disposal



Do not dispose this instrument as unsorted municipal waste. Please use a separate collection facility or contact the supplier from which this instrument was purchased. Please make sure discarded electrical waste is properly recycled to reduce environmental impact.

s. All hazardous wiring must be immediately destroyed and replaced in accordance to the above standard.

# GETTING STARTED

This chapter describes the power supply in a nutshell, including its main features and front / rear panel introduction. After going through the overview, please read the theory of operation to become familiar with the operating modes, protection modes and other safety considerations.



<b>PSW Series Overview .....</b>	<b>9</b>
Series lineup .....	9
Main Features .....	10
Accessories .....	11
PSW 30/40/80/160 Accessories .....	11
PSW 250/800 Accessories .....	13
<b>Appearance .....</b>	<b>15</b>
PSW Front Panel .....	15
Rear Panel .....	18
<b>Theory of Operation .....</b>	<b>22</b>
Operating Area Description .....	22
CC and CV Mode .....	25
Slew Rate .....	27
Bleeder Control .....	27
Sink Current Table .....	29
Internal Resistance .....	36
Alarms .....	37
Considerations .....	37
Grounding .....	40



## PSW Series Overview

### Series lineup

The PSW series consists of 18 models, divided into 3 different model types covering 3 power capacities: Type I (360 Watt), Type II (720 Watt) and Type III (1080 Watt).



Note

Throughout the user manual, PSW 30, PSW 40, PSW 80, PSW 160, PSW 250 or PSW 800 will refer to any of the PSW models with a maximum voltage rating of 30V, 40V, 80V, 160V, 250V or 800V, respectively.

Model name	Type	Voltage Rating	Current Rating	Power
PSW 30-36	Type I	0~30V	0~36A	360W
PSW 40-27	Type I	0~40V	0~27A	360W
PSW 80-13.5	Type I	0~80V	0~13.5A	360W
PSW 160-7.2	Type I	0~160V	0~7.2A	360W
PSW 250-4.5	Type I	0~250V	0~4.5A	360W
PSW 800-1.44	Type I	0~800V	0~1.44A	360W
PSW 30-72	Type II	0~30V	0~72A	720W
PSW 40-54	Type II	0~40V	0~54A	720W
PSW 80-27	Type II	0~80V	0~27A	720W
PSW 160-14.4	Type II	0~160V	0~14.4A	720W
PSW 250-9	Type II	0~250V	0~9A	720W
PSW 800-2.88	Type II	0~800V	0~2.88A	720W
PSW 30-108	Type III	0~30V	0~108A	1080W
PSW 40-81	Type III	0~40V	0~81A	1080W
PSW 80-40.5	Type III	0~80V	0~40.5A	1080W
PSW 160-21.6	Type III	0~160V	0~21.6A	1080W

PSW 250-13.5	Type III 0~250V	0~13.5A	1080W
PSW 800-4.32	Type III 0~800V	0~4.32A	1080W

Apart from the differences in output, each unit differs in size. The 720 and 1080 watt models are larger than the 360 watt models to accommodate the increase in power.

360 Watt models

720 Watt models

1080 Watt models

Type I

Type II

Type III

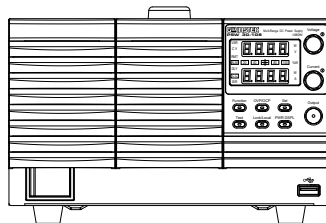
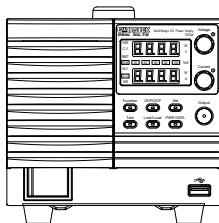
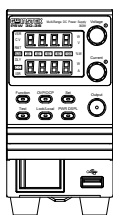

## Main Features

### Performance

- High performance/power
- Power efficient switching type power supply
- Low impact on load devices
- Fast transient recovery time of 1ms
- Fast output response time

### Features

- OVP, OCP and OHP (OTP) protection
- Adjustable voltage and current slew rates
- User adjustable bleeder control to quickly dissipate the power after shutdown to safe levels.
- Extensive remote monitoring and control options
- Support for serial\* and parallel connections.  
\*(30, 40, 80, 160 volt models only)

- Power on configuration settings.
- Supports test scripts
- Web server monitoring and control

Interface

- Ethernet port
- Analog connector for analog voltage and current monitoring
- USB host and device port

Accessories

Please check the contents before using the PSW.

PSW 30/40/80/160 Accessories

Standard Accessories	Part number	Description
	CD-ROM	User manual, programming manual
		Power cord (Type I/II)
		Power cord (Type III)
		Output terminal cover
	GTL-123	Test leads: 1x red, 1x black
	GTL-240	USB Cable
	PSW-004	Basic Accessory Kit: M4 terminal screws and washers x2, M8 terminal bolts, nuts and washers x2, Air filter x1, Analog control protection dummy x1, Analog control lock level x1

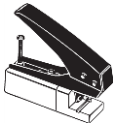
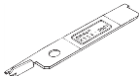
Optional Accessories	Part number	Description
	GET-001	Extended terminal with max. 30A
	GET-005	Extended European terminal with max. 20A
	PSW-001	Accessory Kit: Pin contact x10, Socket x1, Protection cover x1
	PSW-002	Simple IDC Tool 
	PSW-003	Contact Removal Tool 
	PSW-005	Series operation cable for 2 units.
	PSW-006	Parallel operation cable for 2 units.
	PSW-007	Parallel operation cable for 3 units.
	GRA-410-J	Rack mount adapter (JIS)
	GRA-410-E	Rack mount adapter (EIA)
	GUG-001	GPIB to USB adapter
	GTL-240	USB Cable
	PSW-010	Large filter (Type II/III)
	GUR-001A	RS-232 to USB adapter with M3 rivet nut (Support only when firmware version is 2.25 or above)
	GUR-001B	RS-232 to USB adapter with #4-40 UNC rivet nut (Support only when firmware version is 2.25 or above)

Download	Name	Description
	psw_cdc.inf	USB driver

PSW 250/800 Accessories

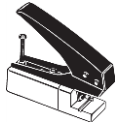
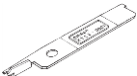
Standard Accessories	Part number	Description
	CD-ROM	User manual, programming manual Power cord (Type I/II) Power cord (Type III) High voltage output terminal cover
	GTL-240	USB Cable High voltage output terminal
	PSW-008	Basic Accessory Kit: (Air filter x1, Analog control protection dummy x1, Analog control lock level x1)
Optional Accessories	Part number	Description
	GET-002	Extended terminal with max. 10A
	PSW-001	Accessory Kit: Pin contact x10, Socket x1, Protection cover x1
	PSW-002	Simple IDC Tool 
	PSW-003	Contact Removal Tool 
	PSW-006	Parallel operation cable for 2 units.
	PSW-007	Parallel operation cable for 3 units.
	GRA-410-J	Rack mount adapter (JIS)
	GRA-410-E	Rack mount adapter (EIA)
	GTL-130	Test leads: 2x red, 2x black

GUG-001	GPIB to USB adapter
GTL-240	USB Cable
PSW-010	Large filter (Type II/III)
GUR-001A	RS-232 to USB adapter with M3 rivet nut (Support only when firmware version is 2.25 or above)
GUR-001B	RS-232 to USB adapter with #4-40 UNC rivet nut (Support only when firmware version is 2.25 or above)

Download	Name	Description
	psw_cdc.inf	USB driver

# Appearance

## PSW Front Panel

720W: PSW 30-72, 40-54, 80-27, 160-14.4, 250-9, 800-2.88

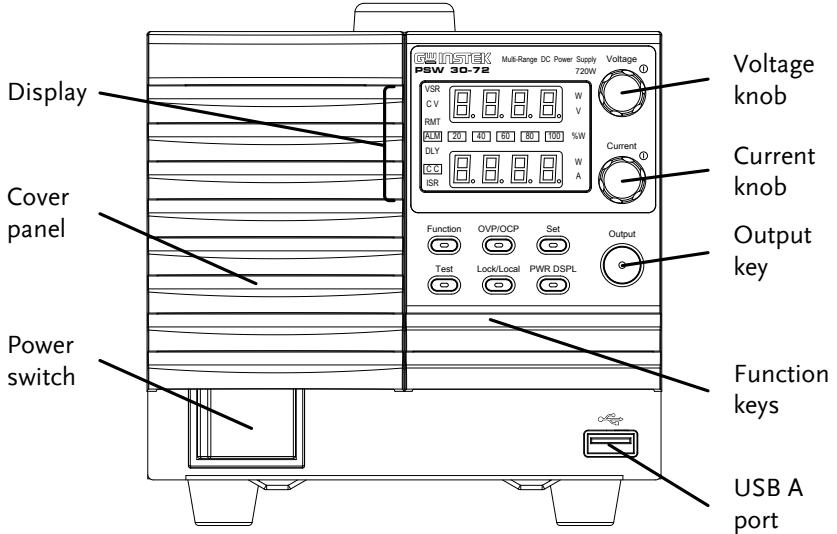

1080W: PSW 30-108, 40-81, 80-40.5, 160-21.6, 250-13.5, 800-4.32

360W: PSW 30-36, 40-27, 80-13.5, 160-7.2, 250-4.5, 800-1.44

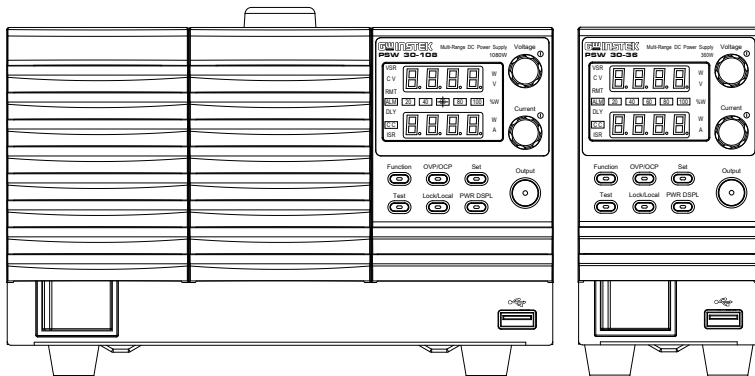

**Function Keys**      The Function keys along with the Output key will light up when a key is active.

- Function



The Function key is used to configure the power supply.
- OVP/OCF



Set the over current or over voltage protection levels.
- Set



Sets the current and voltage limits.
- Test



Used to run customized scripts for testing.
- Lock/Local



Locks or unlocks the panel keys to prevent accidentally changing panel settings.
- PWR DSPL



Toggles the display from viewing V/A → V/W or A/W\*.  
\*Press the Voltage knob for V/W, press the Current knob for A/W.

- Display Indicators**
- VSR

Voltage Slew Rate
  - C V

Constant Voltage Mode
  - RMT

Remote Control Mode
  - ALM**

Alarm on
  - DLY

Delay Output
  - C C**

Constant Current Mode
  - ISR

Current Slew Rate
  - 20** **40** **60**

Power bar
  - 80** **100** % W

Indicates the current power output as a percentage.



Voltage Knob

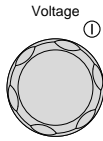

Sets the voltage.

Current Knob

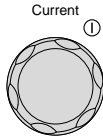

Sets the current.

Output

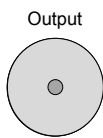

Press to turn on the output. The Output key will light up when the output is active.

USB

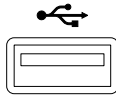

USB A port for data transfer, loading test scripts etc.

Power Switch

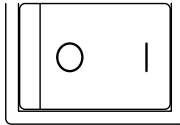

Used to turn the power on/off.

**Rear Panel**

720W: PSW 30-72, 40-54, 80-27, 160-14.4

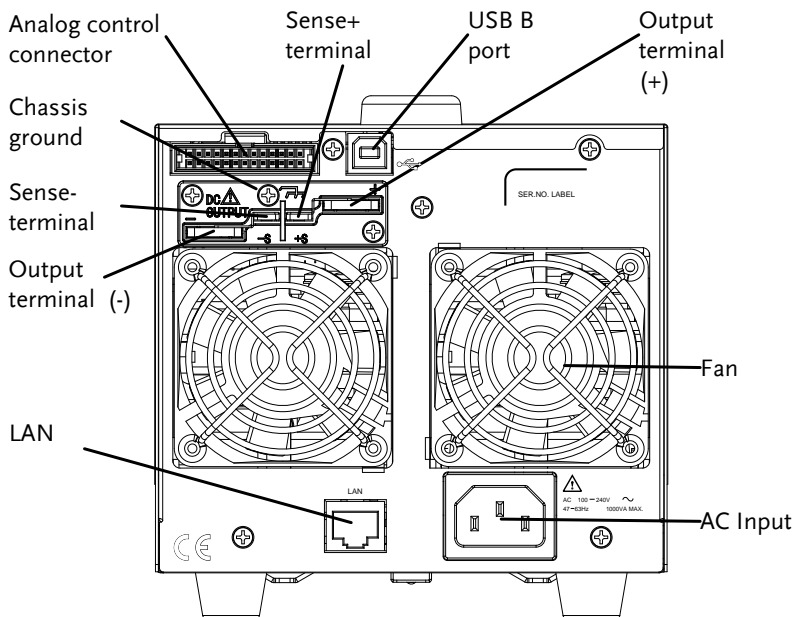

1080W: PSW 30-108, 40-81, 80-40.5, 160-21.6

360W: PSW 30-36, 40-27, 80-13.5, 160-7.2

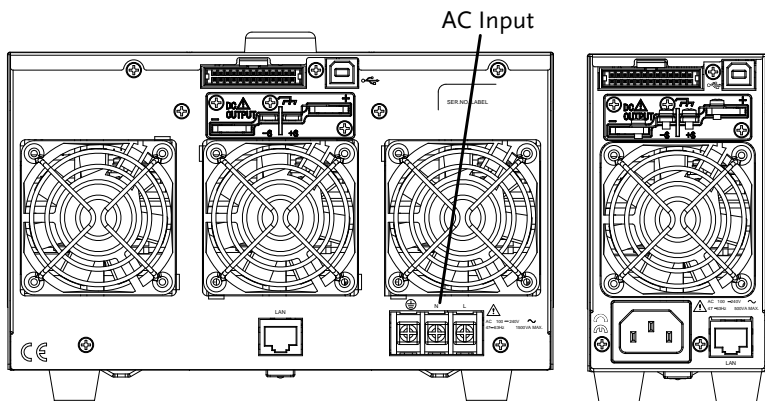

720W: PSW 250-9, 800-2.88

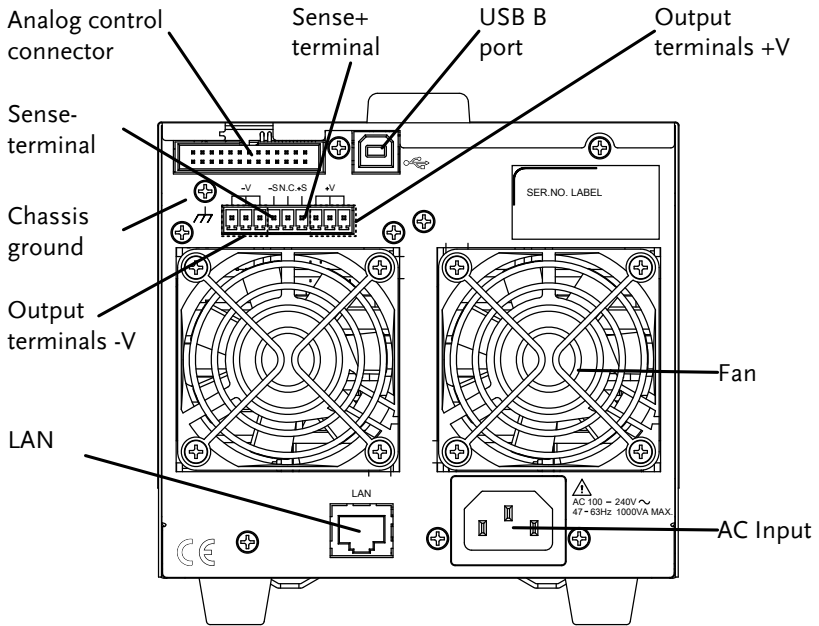

1080W: PSW 250-13.5, 800-4.32

360W: PSW 250-4.5, 800-1.44

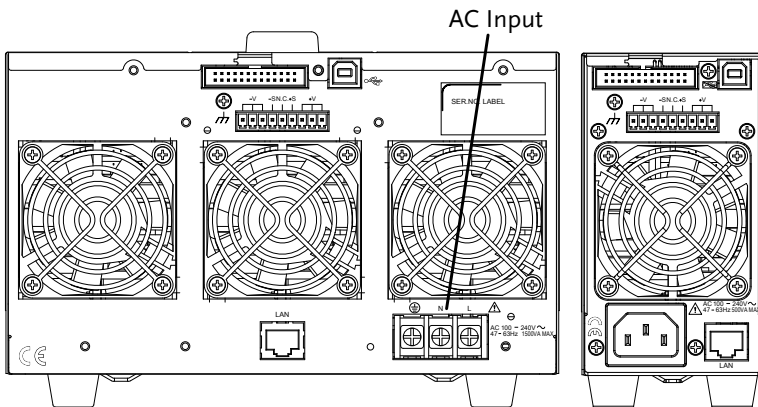

Analog Control Connector



Standard 26 pin MII connector (OMRON XG4 IDC plug).

The analog control connector is used to monitor current and voltage output, machine status (OVP, OCP, OHP (OTP) etc.), and for analog control of the current and voltage output.

Use an OMRON XG5 IDC socket as the mating socket.

Output Terminals (30, 40, 80, 160 volt models)

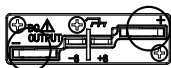

Positive (+) and negative (-) output terminals.



Chassis ground



Sense (-S) and Sense (+S) terminals.

Output Terminals (250, 800 volt models)

The 250 and 800 volt models use a 9 pin connector and a plug for the output and sense terminal connections. The plug is a MC420-38109Z plug by DECA SwitchLab Inc. This plug is also available separately (GW part number PSW-012).

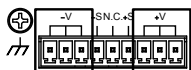

Positive (V+) and negative (V-) output terminals (3 of each).

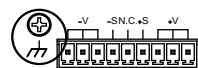

Chassis ground

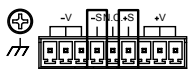

Sense (-S) and Sense (+S) terminals.

USB B port

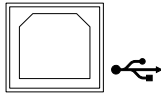

The USB B port is used for remote control.

Fans

Temperature controlled fans

Ethernet Port

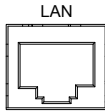

The ethernet port is used for remote control and digital monitoring from a PC.

Line Voltage Input

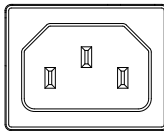

Type I: PSW 30-36/40-27/80-13.5/  
160-7.2/250-4.5, 800-1.44

(Type I/Type II)

Type II: PSW 30-72/40-54/80-27/  
160-14.4/250-9, 800-2.88

- Voltage Input: 100~240 VAC
- Line frequency: 50Hz/60 Hz (Automatically switchable)

Line Voltage Input

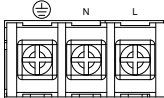

Type III:  
PSW 30-108/40-81/80-40.5/  
160-21.6/250-13.5/800-4.32

(Type III)

- Voltage Input: 100~240 VAC
- Line frequency: 50Hz/60 Hz (Automatically switchable)

## Theory of Operation

The theory of operation chapter describes the basic principles of operation, protection modes and important considerations that must be taken into account before use.

### Operating Area Description

---

#### Background

The PSW power supplies are regulated DC power supplies with a high voltage and current output. These operate in CC or CV mode within a wide operating range limited only by the output power.

The operating area of each power supply is determined by the rated output power as well as the voltage and current rating. For example the operating area and rated power output for the PSW 30-36 is shown below.

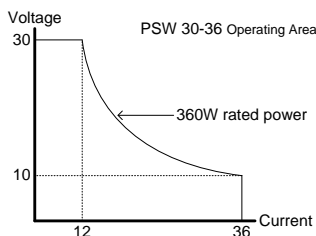

When the power supply is configured so that the total output (current x voltage output) is less than the rated power output, the power supply functions as a typical constant current, constant voltage power supply.

If however, the power supply is configured such that the total output (current x voltage output) exceeds the rated power output, the effective output is actually limited to the power limit of the

unit. In this case the output current and voltage then depend purely on the load value.

Below is a comparison of the operating areas of each power supply.

**PSW 800V Series Operating Area**

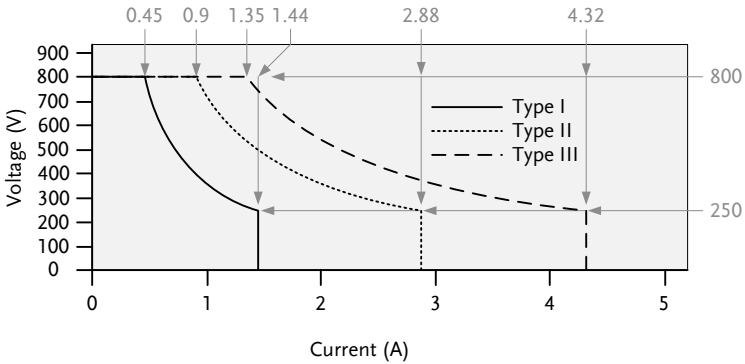

**PSW 250V Series Operating Area**

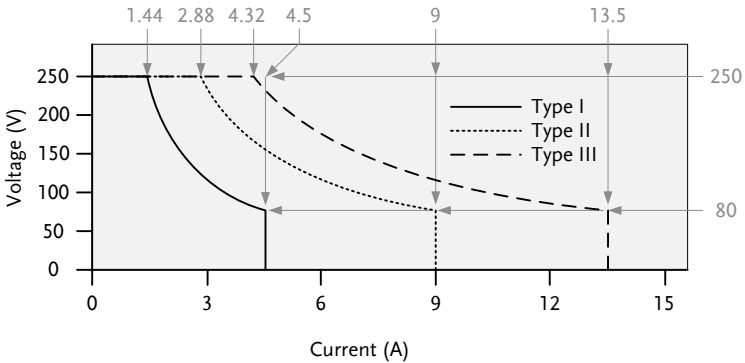

**PSW 160V Series Operating Area**

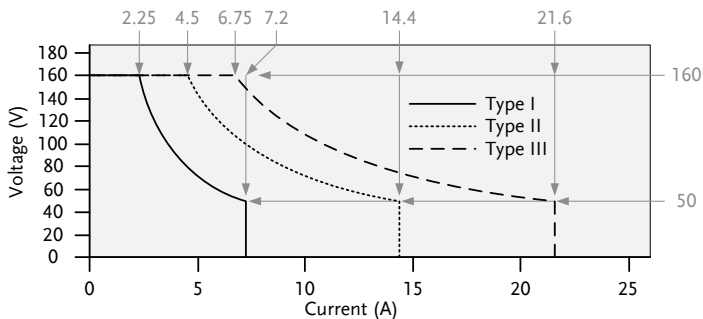

**PSW 80V Series Operating Area**

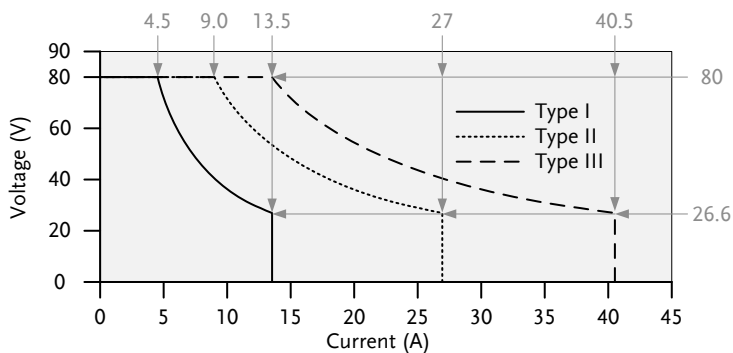

**PSW 40V Series Operating Area**

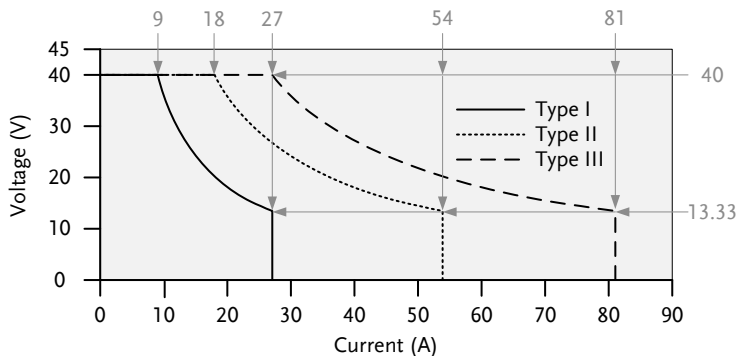



## PSW 30V Series Operating Area

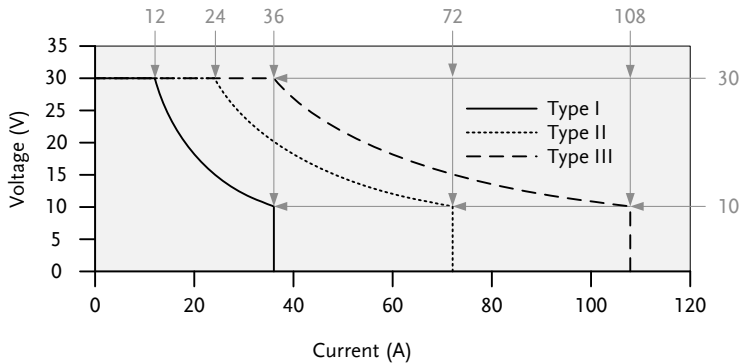

## CC and CV Mode

**CC and CV mode Description** When the power supply is operating in constant current mode (CC) a constant current will be supplied to the load. When in constant current mode the voltage output can vary, whilst the current remains constant. When the load resistance increases to the point where the current limit ( $I_{SET}$ ) can no longer be sustained the power supply switches to CV mode. The point where the power supply switches modes is the crossover point.

When the power supply is operating in CV mode, a constant voltage will be supplied to the load, whilst the current will vary as the load varies. At the point that the load resistance is too low to maintain a constant voltage, the power supply will switch to CC mode and maintain the set current limit.

The conditions that determine whether the power supply operates in CC or CV mode depends on

the set current ( $I_{SET}$ ), the set voltage ( $V_{SET}$ ), the load resistance ( $R_L$ ) and the critical resistance ( $R_C$ ). The critical resistance is determined by  $V_{SET}/I_{SET}$ . The power supply will operate in CV mode when the load resistance is greater than the critical resistance. This means that the voltage output will be equal to the  $V_{SET}$  voltage but the current will be less than  $I_{SET}$ . If the load resistance is reduced to the point that the current output reaches the  $I_{SET}$  level, the power supply switches to CC mode.

Conversely the power supply will operate in CC mode when the load resistance is less than the critical resistance. In CC mode the current output is equal to  $I_{SET}$  and the voltage output is less than  $V_{SET}$ .

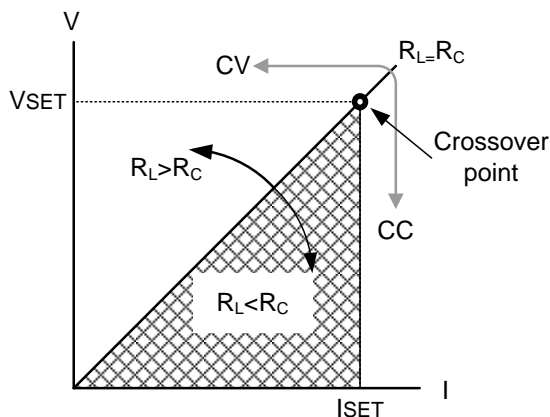

## Slew Rate

---

### Theory

The PSW has selectable slew rates for CC and CV mode. This gives the PSW power supply the ability to limit the current/voltage draw of the power supply. Slew rate settings are divided into High Speed Priority and Slew Rate Priority. High Speed Priority mode disables slew rate settings for CC or CV mode. Slew Rate Priority mode allows for user adjustable slew rates for CC or CV mode. The rising and falling slew rate can be set independently.

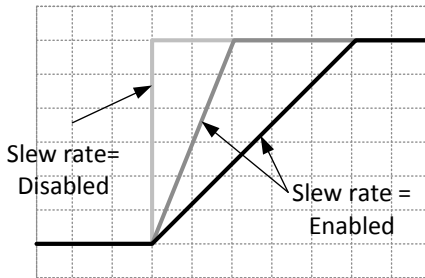

## Bleeder Control

---

### Background

The PSW DC power supplies employ a bleed resistor in parallel with the output terminals.

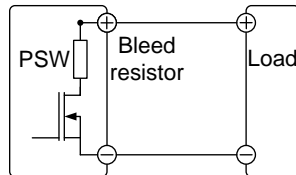

Bleed resistors are designed to dissipate the power from the power supply filter capacitors when power is turned off and the load is

disconnected. Without a bleed resistor, power may remain charged on the filter capacitors for some time and be potentially hazardous.

In addition, bleed resistors also allow for smoother voltage regulation of the power supply as the bleed resistor acts as a minimum voltage load.

The bleed resistance can be turned on or off using the configuration settings.

---



Note

By default the bleed resistance is on. For battery charging applications, be sure to turn the bleed resistance off as the bleed resistor can discharge the connected battery when the unit is off.

## Sink Current Table

---

Background Sink current (reference value) from an external voltage source according to the bleeder circuit setting.

---

PSW 30-36

Vout	Bleeder ON	Bleeder OFF
	Sink Current	
(V)	(A)	(mA)
1	1.455	0.000
3	1.733	0.000
5	1.559	0.002
10	1.123	0.009
15	0.715	0.014
20	0.471	0.021
25	0.353	0.031
30	0.267	0.038

PSW 30-72

Vout	Bleeder ON	Bleeder OFF
	Sink Current	
(V)	(A)	(mA)
1	2.378	0.000
3	3.613	0.000
5	3.249	0.004
10	2.340	0.008
15	1.487	0.014
20	0.974	0.022
25	0.730	0.028
30	0.544	0.048

PSW 30-108

Vout	Bleeder ON	Bleeder OFF
	Sink Current	
(V)	(A)	(mA)
1	3.645	0.000
3	5.373	0.000
5	4.838	0.001
10	3.510	0.008
15	2.261	0.011
20	1.512	0.018
25	1.153	0.029
30	0.884	0.042

PSW 40-27

Vout	Bleeder ON	Bleeder OFF
	Sink Current	
(V)	(A)	(mA)
5	1.193	0.002
10	0.994	0.009
15	0.799	0.014
20	0.625	0.021
25	0.51	0.025
30	0.445	0.03
35	0.397	0.035
40	0.356	0.041

PSW 40-54

Vout	Bleeder ON	Bleeder OFF
	Sink Current	
(V)	(A)	(mA)
5	2.408	0.002
10	2.010	0.01
15	1.629	0.013
20	1.274	0.021
25	1.060	0.026
30	0.982	0.031
35	0.876	0.035
40	0.801	0.042

PSW 40-81

Vout	Bleeder ON	Bleeder OFF
	Sink Current	
(V)	(A)	(mA)
5	3.601	0.002
10	2.997	0.012
15	2.403	0.016
20	1.880	0.021
25	1.593	0.028
30	1.458	0.033
35	1.301	0.037
40	1.182	0.043

PSW 80-13.5

Vout	Bleeder ON	Bleeder OFF
	Sink Current	
(V)	(A)	(mA)
5	0.640	0.002
10	0.589	0.009
20	0.488	0.015
30	0.387	0.026
40	0.292	0.032
50	0.224	0.045
60	0.188	0.058
80	0.140	0.084

PSW 80-27

Vout	Bleeder ON	Bleeder OFF
	Sink Current	
(V)	(A)	(mA)
5	1.292	0.004
10	1.191	0.009
20	0.989	0.017
30	0.789	0.028
40	0.607	0.036
50	0.485	0.046
60	0.415	0.058
80	0.315	0.095

PSW 80-40.5

Vout	Bleeder ON	Bleeder OFF
	Sink Current	
(V)	(A)	(mA)
5	1.932	0.000
10	1.776	0.007
20	1.468	0.014
30	1.164	0.024
40	0.912	0.035
50	0.725	0.043
60	0.616	0.054
80	0.465	0.101

PSW 160-7.2

Vout	Bleeder ON	Bleeder OFF
	Sink Current	
(V)	(A)	(mA)
10	0.173	0.009
20	0.164	0.017
40	0.146	0.034
60	0.128	0.057
80	0.112	0.076
100	0.101	0.095
130	0.093	0.128
160	0.088	0.207

PSW 160-14.4

Vout	Bleeder ON	Bleeder OFF
	Sink Current	
(V)	(A)	(mA)
10	0.356	0.004
20	0.339	0.013
40	0.303	0.028
60	0.269	0.048
80	0.237	0.065
100	0.216	0.088
130	0.201	0.119
160	0.191	0.171



PSW 160-21.6

Vout	Bleeder ON	Bleeder OFF
	Sink Current	
(V)	(A)	(mA)
10	0.539	0.005
20	0.512	0.013
40	0.458	0.032
60	0.405	0.052
80	0.355	0.070
100	0.321	0.103
130	0.298	0.136
160	0.283	0.185

PSW 250-4.5

Vout	Bleeder ON	Bleeder OFF
	Sink Current	
(V)	(A)	(mA)
10	0.158	0.031
30	0.143	0.098
50	0.129	0.164
80	0.107	0.267
100	0.092	0.333
150	0.061	0.508
200	0.463	0.697
250	0.035	0.961

PSW 250-9

Vout	Bleeder ON	Bleeder OFF
	Sink Current	
(V)	(A)	(mA)
10	0.317	0.055
30	0.288	0.169
50	0.259	0.291
80	0.215	0.470
100	0.186	0.587
150	0.124	0.885
200	0.096	1.193
250	0.072	1.538

PSW 250-13.5

Vout	Bleeder ON	Bleeder OFF
	Sink Current	
(V)	(A)	(mA)
10	0.471	0.086
30	0.427	0.252
50	0.382	0.425
80	0.316	0.678
100	0.273	0.849
150	0.179	1.272
200	0.136	1.693
250	0.100	2.136

PSW 800-1.44

Vout	Bleeder ON	Bleeder OFF
	Sink Current	
(V)	(A)	(mA)
20	0.061	0.056
50	0.058	0.138
100	0.054	0.274
200	0.046	0.550
300	0.037	0.823
400	0.029	1.097
600	0.020	1.653
800	0.015	2.214

PSW 800-2.88

Vout	Bleeder ON	Bleeder OFF
	Sink Current	
(V)	(A)	(mA)
20	0.119	0.096
50	0.114	0.224
100	0.105	0.494
200	0.089	0.993
300	0.072	1.496
400	0.056	1.998
600	0.038	3.001
800	0.028	4.088

PSW 800-4.32

Vout	Bleeder ON	Bleeder OFF
	Sink Current	
(V)	(A)	(mA)
20	0.181	0.214
50	0.173	0.361
100	0.161	0.714
200	0.136	1.435
300	0.111	2.173
400	0.867	2.890
600	0.060	4.375
800	0.044	5.950

## Internal Resistance

---

**Background** On the PSW, the internal resistance of the power supply can be user-defined in software. (Internal Resistance Setting, page 103). When the internal resistance is set it can be seen as a resistance in series with the positive output terminal. This allows the power supply to simulate power sources that have internal resistances such as lead acid batteries.

Internal Resistance Range	Unit Model	Internal Resistance Range
	PSW 30-36	0.000 ~ 0.833Ω
	PSW 30-72	0.000 ~ 0.417Ω
	PSW 30-108	0.000 ~ 0.278Ω
	PSW 40-27	0.000 ~ 1.481Ω
	PSW 40-54	0.000 ~ 0.741Ω
	PSW 40-81	0.000 ~ 0.494Ω
	PSW 80-13.5	0.000 ~ 5.926Ω
	PSW 80-27	0.000 ~ 2.963Ω
	PSW 80-40.5	0.000 ~ 1.975Ω
	PSW 160-7.2	0.000 ~ 22.222Ω
	PSW 160-14.4	0.000 ~ 11.111Ω
	PSW 160-21.6	0.000 ~ 7.407Ω
	PSW 250-4.5	0.00 ~ 55.55Ω
	PSW 250-9	0.00 ~ 27.77Ω
	PSW 250-13.5	0.00 ~ 18.51Ω
	PSW 800-1.44	0.0 ~ 555.5Ω
	PSW 800-2.88	0.0 ~ 277.8Ω
	PSW 800-4.32	0.0 ~ 185.1Ω

## Alarms

The PSW power supplies have a number of protection features. When one of the protection alarms are set, the ALM icon on the display will be lit. For details on how to set the protection modes, please see page 62.

---

OVP	Overvoltage protection (OVP) prevents a high voltage from damaging the load.
OCP	Overcurrent protection prevents high current from damaging the load.
OHP (OTP)	Overheat (Over temperature) protection protects the instrument from overheating.
Power Switch Trip	When the Power Switch Trip configuration setting is enabled, the power supply will automatically shut down when a protection setting has been tripped (OCP, OVP, OHP (OTP)).
Alarm output	Alarms are output via the analog control connector. The alarm output is an isolated open-collector photo coupler output.

## Considerations

The following situations should be taken into consideration when using the power supply.

---

Inrush current	When the power supply switch is first turned on, an inrush current is generated. Ensure there is enough power available for the power supply when first turned on, especially if a number of units are turned on at the same time.
----------------	--

---



Caution

Cycling the power on and off quickly can cause the inrush current limiting circuit to fail as well as reduce the working life of the input fuse and power switch.

Pulsed or Peaked loads

When the load has current peaks or is pulsed, it is possible for the maximum current to exceed the mean current value. The PSW power supply ammeter only indicates mean current values, which means for pulsed current loads, the actual current can exceed the indicated value. For pulsed loads, the current limit must be increased, or a power supply with a greater capacity must be chosen. As shown below, a pulsed load may exceed the current limit and the indicated current on the power supply ammeter.

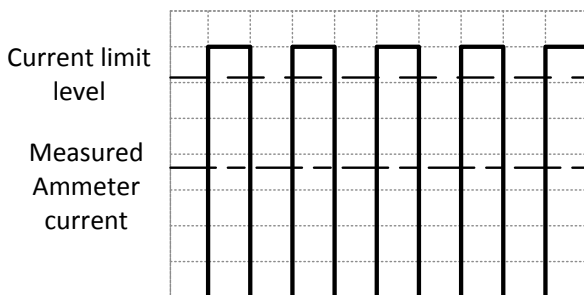

Reverse Current: Regenerative load

When the power supply is connected to a regenerative load such as a transformer or inverter, reverse current will feed back to the power supply. The PSW power supply cannot absorb reverse current. For loads that create reverse current, connect a resistor in parallel (dummy load) to the power supply to bypass the reverse current.

To calculate the resistance for the dummy resistor,  $R_D$ , first determine the maximum reverse current,  $I_R$ , and determine what the output voltage,  $E_O$ , will be.

$$R_D(\Omega) \leq E_O(V) \div I_R(A)$$

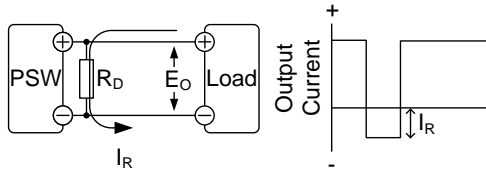

Note

The current output will decrease by the amount of current absorbed by the dummy resistor.

Ensure the resistor used can withstand the power capacity of the power supply/load.

Reverse Current:  
Accumulative  
energy.

When the power supply is connected to a load such as a battery, reverse current may flow back to the power supply. To prevent damage to the power supply, use a reverse-current-protection diode in series between the power supply and load.

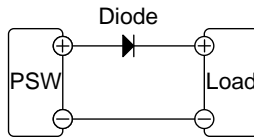

CAUTION

Ensure the reverse withstand voltage of the diode is able to withstand 2 times the rated output voltage of the power supply and the forward current capacity can withstand 3 to 10 times the rated output current of the power supply.

Ensure the diode is able to withstand the heat generated in the following scenarios.

When the diode is used to limit reverse voltage, remote sensing cannot be used.

## Grounding

The output terminals of the PSW power supplies are isolated with respect to the protective grounding terminal. The insulation capacity of the load, the load cables and other connected devices must be taken into consideration when connected to the protective ground or when floating.

### Floating

As the output terminals are floating, the load and all load cables must have an insulation capacity that is greater than the isolation voltage of the power supply.

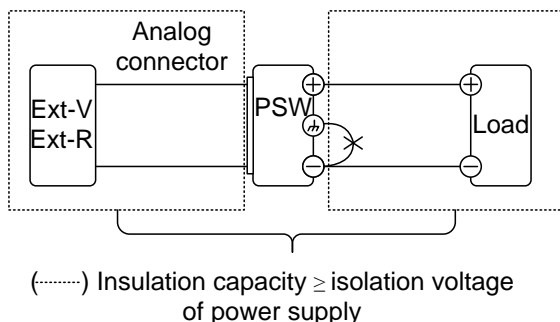

### WARNING

If the insulation capacity of the load and load cables is not greater than the isolation voltage of the power supply, electric shock may occur.

### Grounded output terminal

If the positive or negative terminal is connected to the protective ground terminal, the insulation capacity needed for the load and load cables is greatly reduced. The insulation capacity only needs to be greater than the maximum output voltage of the power supply with respect to ground.



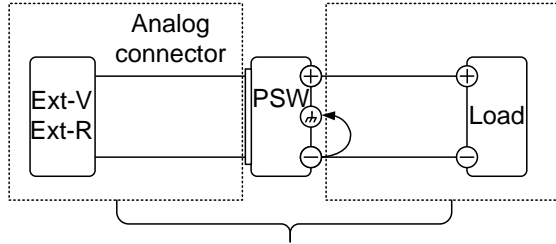

(-----) Insulation capacity  $\geq$  voltage of power supply with respect to ground



**CAUTION**

If using external voltage control, do not ground the external voltage terminal as this will create a short circuit.

# OPERATION

---

Set Up .....	44
Line Voltage Connection – Type III Models.....	44
Filter Installation .....	46
Power Up.....	46
Wire Gauge Considerations .....	47
Output Terminals PSW-30/40/80/160.....	48
Using the Output Terminal Cover PSW-30/40/80/160.....	50
Output Terminals PSW-250/800.....	51
Using the Output Terminal Cover PSW-250/800.....	55
Using the Rack Mount Kit .....	56
How to Use the Instrument.....	56
Reset to Factory Default Settings.....	58
View System Version and Build Date .....	59
Basic Operation .....	62
Setting OVP/OCP Levels .....	62
Set to C.V. Mode.....	64
Set to C.C. Mode.....	67
Display Modes .....	70
Panel Lock.....	71
Remote Sense.....	71
Parallel / Series Operation.....	75
Master-Slave Parallel Overview .....	76
Master-Slave Parallel Connection.....	79
Master-Slave Parallel Operation .....	81
Master-Slave Series Overview.....	83
Master-Slave Series Connection .....	85
Master-Slave Series Operation.....	87
Test Scripts .....	89
Test Script File Format .....	90
Test Script Settings .....	90
Setting the Test Script Settings .....	91
Load Test Script from USB.....	92
Run Test Script (Manual).....	94
Run Test Script (Automatically at Startup).....	96

Export Test Script to USB .....	97
Remove Test Script .....	98
Checking the Available Memory .....	99

## Set Up

### Line Voltage Connection – Type III Models

---

**Background** The Type III (PSW 30-108/40-81/80-40.5/160-21.6/250-13.5/800-4.32) models use a universal power input that can be used with 100 and 200 VAC systems. To connect or replace the power cord (GW Instek part number: 4320-91001101, use the procedure below:

---



Warning

The following procedure should only be attempted by competent persons.

Ensure the AC power cord is not connected to power.

---

**Removal**

1. Turn off the power switch.

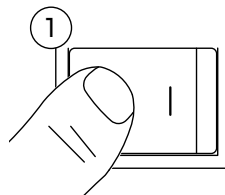

2. Unscrew the power cord protective sheath.

3. Remove the 2 screws holding the power cord cover and remove.

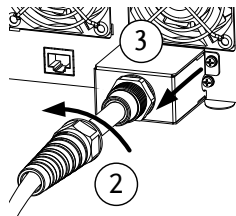

4. Slide the cover off the AC terminals.
5. Remove the AC power cord wires.

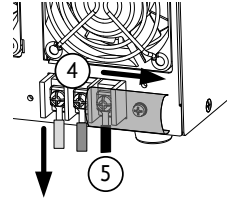

**Installation**

1. Connect the AC power cord wires to the AC input terminals.
  - White/Blue → Neutral (N)
  - Green/Green-yellow → GND (⊕)
  - Black/Brown → Line (L)

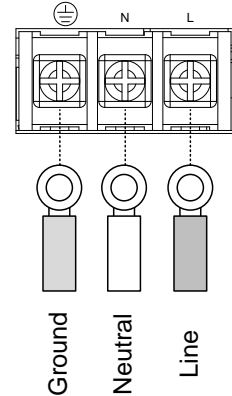

2. Set the cover back over the AC terminals.

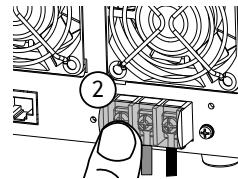

3. Re-install the power cord cover.

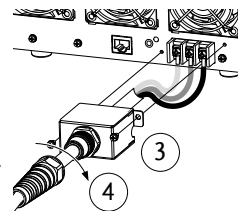

4. Screw the power cord sheath back onto the cover.

## Filter Installation

**Background** The PSW has a small filter (GW Instek part number, 57RG-30B001X1) that must first be inserted under the control panel before operation. The small filter must be inserted for all model types (Type I/II/III).

**Steps**

1. Insert the small filter in the open area under the control panel.



Type II shown as an example

2. The unit is now ready to power up.

## Power Up

**Steps**

1. Type I or II: Connect the power cord to the rear panel socket.

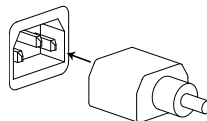

Type III: Connect the power cord to the universal power input.

Page 44

2. Press the POWER key. If used for the first time, the default settings will appear on the display, otherwise The PSW recovers the state right before the power was last turned OFF.

For default configuration settings, see page 163.

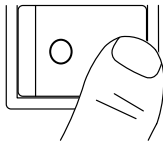
**CAUTION**

The power supply takes around 8 seconds to fully turn on and shutdown.

Do not turn the power on and off quickly. Please wait for the display to fully turn off.

## Wire Gauge Considerations

---

**Background** Before connecting the output terminals to a load, the wire gauge of the cables should be considered.

It is essential that the current capacity of the load cables is adequate. The rating of the cables must equal or exceed the maximum current rated output of the instrument.

Recommended wire gauge	Wire Gauge	Nominal Cross Section	Maximum Current
	20	0.5	9
	18	0.75	11
	18	1	13
	16	1.5	18
	14	2.5	24
	12	4	34
	10	6	45
	8	10	64
	6	16	88
	4	25	120
	2	32	145
	1	50	190
	0	70	240

0	95	290
0	120	340

The maximum temperature rise can only be 60 degrees above the ambient temperature. The ambient temperature must be less than 30 deg.

## Output Terminals PSW-30/40/80/160

---

**Background** Before connecting the output terminals to the load, first consider whether voltage sense will be used, the gauge of the cable wiring and the withstand voltage of the cables and load.

The output terminals can be connected to load cables using M4 sized screws or M8 sized bolts.



**WARNING**

Dangerous voltages. Ensure that the power to the instrument is disabled before handling the power supply output terminals. Failing to do so may lead to electric shock.

**Steps**

1. Turn the power switch off.

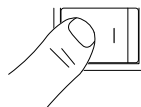

2. Remove the output terminal cover. [Page 50](#)

3. If necessary, screw the chassis ground terminal to either the positive or negative terminal. See [Page 40](#) the grounding chapter for details.



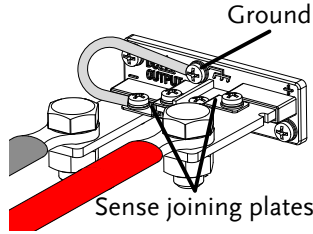

4. Choose a suitable wire gauge for the load cables. Page 47
5. Choose a suitable crimp for the terminals.
6. If using voltage sense, remove the sense terminal joining plates and connect sensing wires to the load(s). Page 71
7. Connect the positive load cable to the positive output terminal and the negative cable to the negative output terminal.
8. Reattach the output terminal cover. Page 50

Connection with local sense wiring

Using M4 screws

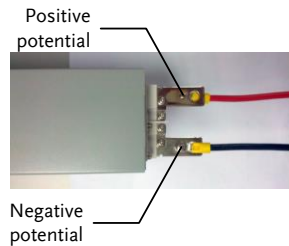

Using M8 bolts

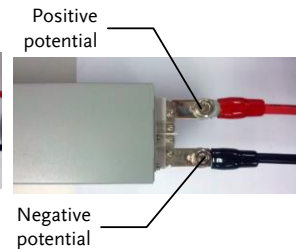

Connection with  
voltage sense  
wiring

Using M4 screws

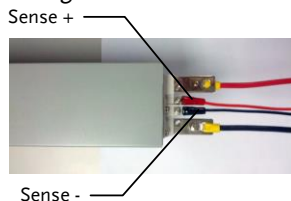

Using M8 bolts

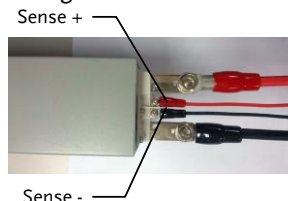

## Using the Output Terminal Cover PSW-30/40/80/160

Steps

1. Remove the screw holding the top cover to the bottom cover.
2. Line-up the bottom cover with the notches in the output terminals.
3. Place the top terminal cover over the bottom cover.

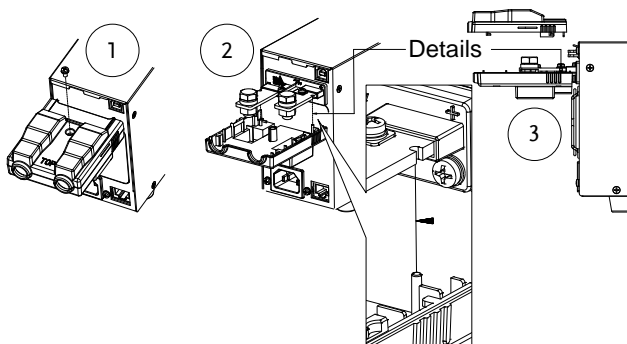

4. Use your thumb to slide the terminal covers shut, as shown in the diagram below.
5. When the top and bottom covers are flush, re-insert the screw that was removed in step 1.

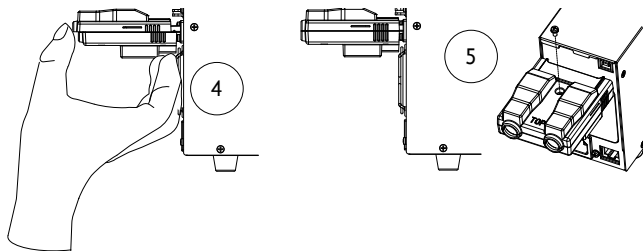

**Removal** Reverse the procedure to remove the terminal covers.

## Output Terminals PSW-250/800

**Background** The high voltage models (PSW 250 and PSW 800 models) use a 9 pin socket for the output voltage and sense connections. The corresponding plugs (GW part number PSW-012 //DECA SwitchLab MC420-38109Z) should be used to connect the terminals to the appropriate cable.

Before connecting the output terminals to the load, first consider whether voltage sense will be used, the gauge of the cable wiring and the withstand voltage of the cables and load.



### WARNING

Dangerous voltages. Ensure that the power to the instrument is disabled before handling the power supply output terminals. Failing to do so may lead to electric shock.

Please note the wire gauge used and the capacity of the plug/socket. It may be necessary to wire the load to a number of terminals to offset the capacity over a number of terminals.

**Output Connector Overview** When using the output connector make sure the wires that are used follow the following guidelines:

Wire gauge:	AWG 26 to AWG 16
Strip length	6.5mm // 0.26 in.
Current rating	10A
Insulation resistance	AC 2000V min
Insulation withstand voltage	>2000MΩ DC500V
Operation Temperature	-40°C to +105°C

**Output Connector Pinout**

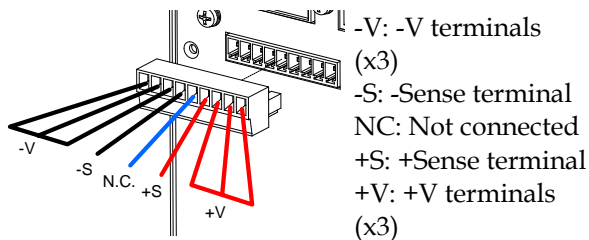

**Wiring the Connector Plug**

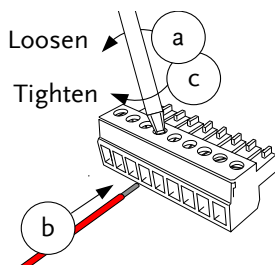

- a. Unscrew the appropriate terminal anticlockwise to release the receptacle.
- b. Insert a wire that has had at least ~7mm stripped from the insulation.
- c. Tighten the receptacle by screwing clockwise.

**Steps**

1. Turn the power switch off.

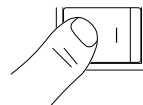

2. Remove the output terminal cover. Page 55
3. Choose a suitable wire gauge for the load cables. Page 47
4. Strip ~7mm from one end of each load cable.
5. Connect the positive load cable to one of the +V pins and the negative cable to one of the -V pins.

**WARNING**

Please note the wire gauge used and the capacity of the plug/socket. It may be necessary to wire the load to a number of terminals to offset the capacity over a number of terminals.

6. If using local sense, connect the -S pin to a -V pin, and connect the +S pin to a +V pin.

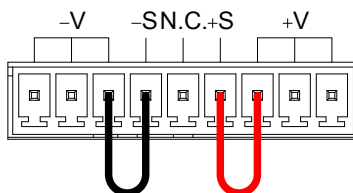

7. If not using local sense, see the remote sense section to wire the sense terminals for remote sensing. Page 71
8. If necessary, connect the chassis ground terminal to either the -V or +V pin. See the grounding chapter for details. Page 40

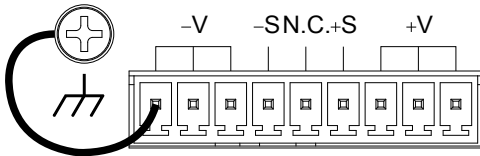

9. Reattach the output terminal cover.

Page 55

Local Sense Wiring

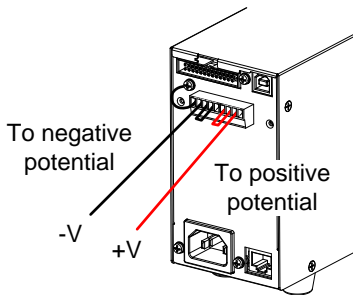

Remote Sense Wiring

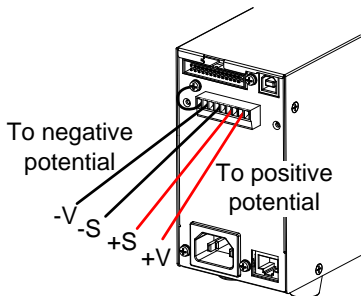

## Using the Output Terminal Cover PSW-250/800

---

### Steps

1. Screw the bottom cover onto the rear panel using the two M4 screws.

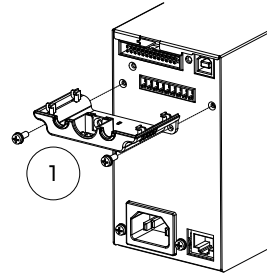

2. Slide the top cover over the bottom cover.

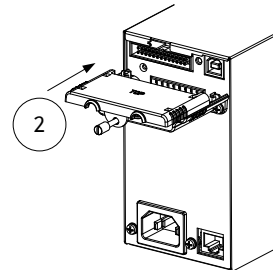

3. Finally, secure the top cover with the screw in the center of the top cover.

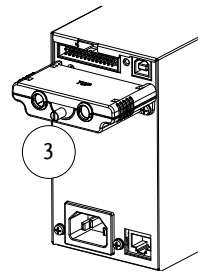

### Removal

Reverse the procedure to remove the terminal covers.

## Using the Rack Mount Kit

**Background** The PSW series has an optional Rack Mount Kit (GW Instek part number: [JIS] GRA-410-J, [EIA] GRA-410-E[EIA]) that can be used to hold 6x PSW Type I models, 3x Type II models, 2x Type III models or a combination of all models (1x Type I, 1x Type II and 1x Type III).

**Rack mount diagram**

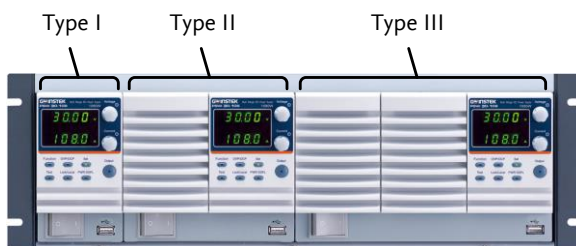

## How to Use the Instrument

**Background** The PSW power supplies use a novel method of configuring parameter values only using the Voltage or Current knobs. The knobs are used to quickly edit parameter values at 0.01, 0.1 or 1 unit steps at a time.

When the user manual says to set a value or parameter, use the steps below.

**Example** Use the Voltage knob to set a voltage of 10.05 volts.



1. Repeatedly press the Voltage knob until the last digit is highlighted. This will allow the voltage to be edited in 0.01 volt steps.

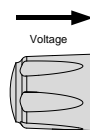

2. Turn the Voltage knob till 0.05 volts is shown.

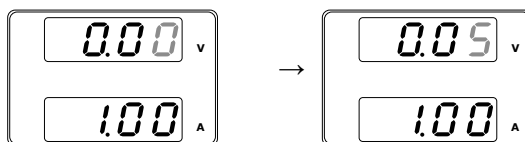
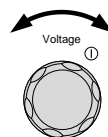

3. Repeatedly press the Voltage knob until the first digit is highlighted. This will allow the voltage to be edited in 1 volt steps.
4. Turn the Voltage knob until 10.05 is shown.

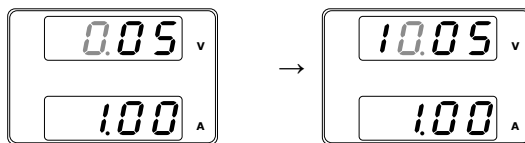







Note

Notice the Set key becomes illuminated when setting the current or voltage.

If the Voltage or Current knobs are unresponsive, press the Set key first.

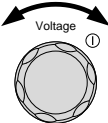
## Reset to Factory Default Settings

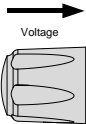
**Background** The F-88 configuration setting allows the PSW to be reset back to the factory default settings. See page 163 for the default factory settings.

- |              |  |   |
|--------------|--|---|
| <b>Steps</b> | <ol style="list-style-type: none"> <li>1. Press the Function key. The Function key will light up.</li> </ol>                                       | <p>Function</p>    |
|              | <ol style="list-style-type: none"> <li>2. The display should show F-01 on the top and the configuration setting for F-01 on the bottom.</li> </ol> |                    |
|              | <ol style="list-style-type: none"> <li>3. Rotate the Voltage knob to change the F setting to F-88 (Factory Set Value).</li> </ol>                  | <p>Voltage ①</p>   |
|              | <ol style="list-style-type: none"> <li>4. Use the Current knob to set the F-88 setting to 1 (Return to factory settings).</li> </ol>               | <p>Current ①</p>   |
|              | <ol style="list-style-type: none"> <li>5. Press the Voltage knob to confirm. Conf will be displayed when successful.</li> </ol>                    | <p>Voltage</p>   |
|              |   |   |
|              | <ol style="list-style-type: none"> <li>6. Press the Function key again to exit. The function key light will turn off.</li> </ol>                   | <p>Function</p>  |

## View System Version and Build Date

**Background** The F-89 configuration setting allows you to view the PSW version number, build date, keyboard version, analog-control version, kernel build, test command version, test command build date, and the USB driver version.

- Steps**
1. Press the Function key. The Function key will light up.
 

Function



  
  2. The display should show F-01 on the top and the configuration setting for F-01 on the bottom.
 

  
  3. Rotate the Voltage knob to change the F setting to F-89 (Show Version).
 

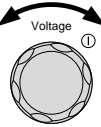
Voltage

  
  4. Rotate the Current knob to view the version and build date for the various items.
 

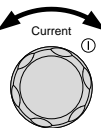
Current

- F-89**

  - 0-XX: PSW Main Program Version
  - 1-XX: PSW Main Program Version
  - 2-XX: PSW Main Program Build On-Year.
  - 3-XX: PSW Main Program Build On-Year.
  - 4-XX: PSW Main Program Build On-Month.
  - 5-XX: PSW Main Program Build On-Day.
  - 6-XX: Keyboard CPLD version.
  - 7-XX: Keyboard CPLD version.
  - 8-XX: Analog CPLD version.

- 9-XX: Analog CPLD version.
- A-XX: Reserved.
- B-XX: Reserved.
- C-XX: Kernel Build On-Year.
- D-XX: Kernel Build On-Year.
- E-XX: Kernel Build On-Month.
- F-XX: Kernel Build On-Day.
- G-XX: Test Command Version.
- H-XX: Test Command Version.
- I-XX: Test Command Build On-Year.
- J-XX: Test Command Build On-Year.
- K-XX: Test Command Build On-Month.
- L-XX: Test Command Build On-Day.
- M-XX: USB Driver version (Major).
- N-XX: USB Driver version (Minor).

5. Press the Function key again to exit. The function key light will turn off.

Function



Example                      Main Program Version: Vt1.50, 2014/08-03

- 0-t1: PSW Main Program Version
- 1-50: PSW Main Program Version
- 2-20: PSW Main Program Build On-Year.
- 3-14: PSW Main Program Build On-Year.
- 4-01: PSW Main Program Build On-Month.
- 5-13: PSW Main Program Build On-Day.

Example                      Keyboard CPLD Version: 0x030c

- 6-03: Keyboard CPLD Version.
- 7-0c: Keyboard CPLD Version.

Example                      Analog CPLD Version: 0x0427

- 8-04: Analog CPLD Version.
- 9-27: Analog CPLD Version.

Example                      Kernel Version: 2013/03/22

C-20: Kernel Build On-Year.  
D-13: Kernel Build On-Year.  
E-03: Kernel Build On-Month.  
F-22: Kernel Build On-Day.

Example            Test Command Version: V01:00, 2011/08/01

G-01: Test Command Version.  
H-00: Test Command Version.  
I-20: Test Command Build On-Year.  
J-11: Test Command Build On-Year.  
K-08: Test Command Build On-Month.  
L-01: Test Command Build On-Day.

Example            USB Driver Version: V02.01:

M-02: USB Driver Version (Major release).  
N-01: USB Driver Version (Minor release).

## Basic Operation

This section describes the basic operations required to operate the power supply.

- Setting OVP/OCP → from page 62
- C.V. mode → from page 63
- C.C. mode → from page 67
- Display modes → page 70
- Panel lock → page 71
- Remote sensing → from page 71

Before operating the power supply, please see the Getting Started chapter, page 8.

### Setting OVP/OCP Levels

---

**Background** For most models the OVP level has a selectable range of approximately\* 10% to 110% of the rated output voltage. Likewise the OCP level for most models has a selectable range of approximately\* 10%~ 110% of the rated output current. The OVP and OCP level is set to the maximum by default. The OCP level can also be turned off.

\*Note that the *actual* setting range differs for each model.

When one of the protection measures are on, ALM is shown on the panel display. By default, the power switch will turn off when any of the protection levels are tripped.

---



Before setting the OVP or OCP level:

- Ensure the load is not connected.
- Ensure the output is set to off.

**Setting Ranges**

PSW (360W)	30-36	40-27	80-13.5	160-7.2	250-4.5	800-1.44
OVP Range (V)	3-33	4-44	8-88	16-176	20-275	20-880
OCP Range (A)	3.6-39.6	2.7-29.7	1.35-14.85	0.72-7.92	0.45-4.95	0.144-1.584
PSW (720W)	30-72	40-54	80-27	160-14.4	250-9	800-2.88
OVP Range (V)	3-33	4-44	8-88	16-176	20-275	20-880
OCP Range (A)	5-79.2	5-59.4	2.7-29.7	1.44-15.84	0.9-9.9	0.288-3.168
PSW (1080W)	30-108	40-81	80-40.5	160-21.6	250-13.5	800-4.32
OVP Range (V)	3-33	4-44	8-88	16-176	20-275	20-880
OCP Range (A)	5-118.8	5-89.1	4.05-44.55	2.16-23.76	1.35-14.85	0.432-4.752

**Steps**



1. Press the OVP/OCP key. The OVP/OCP key lights up.

OVP/OCP

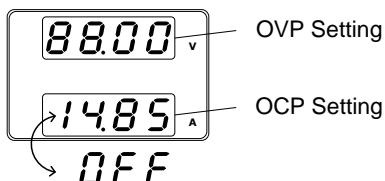

2. The OVP setting will be displayed on the top and the OCP setting (or OFF) will be displayed on the bottom.



OVP Level	3. Use the Voltage knob to set the OVP level.	<p>Voltage ①</p> 
OCP Level	4. Use the Current knob to set the OCP level, or to turn OCP off.	<p>Current ①</p> 
	5. Press OVP/OCP again to exit. The OVP/OCP indicator will turn off.	<p>OVP/OCP</p> 

Power switch trip	Set F-95 (Power switch trip) to 1 (to disable the power switch trip) or to 0 (to enable the power switch trip) and save.	Page 118
	F-95            1 (Disable) or 0 (Enable)	

Clear OVP/OCP protection	<p>The OVP or OCP protection can be cleared after it has been tripped by holding the OVP/OCP button for 2 seconds.</p> <p>(Only applicable when the power switch trip setting is disabled [F-95 = 1])</p>	<p>OVP/OCP</p>  <p>(hold)</p>
--------------------------	---	--

### Set to C.V. Mode

When setting the power supply to constant voltage mode, a current limit must also be set to determine the crossover point. When the current exceeds the crossover point, the mode switches to C.C. mode. For details about C.V. operation, see page 22. C.C. and C.V. mode have two selectable slew rates: High Speed Priority and Slew Rate Priority. High Speed Priority will use the fastest slew rate for the instrument while Slew Rate Priority will use a user-configured slew rate.



Background Before setting the power supply to C.V. mode, ensure:

- The output is off.
- The load is connected.

Steps

1. Press the Function key. The Function key will light up.



2. The display should show F-01 on the top and the configuration setting for F-01 on the bottom.



3. Rotate the Voltage knob to change the F setting to F-03 (V-I Mode Slew Rate Select).

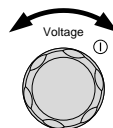

4. Use the Current knob to set the F-03 setting.

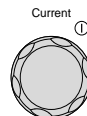

Set F-03 to 0 (CV High Speed Priority) or 2 (CV Slew Rate Priority).

F-03      0 = CV High Speed Priority  
             2 = CV Slew Rate Priority

5. Press the Voltage knob to save the configuration setting. Conf will be displayed when successful.

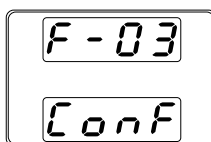
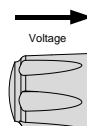

6. If CV Slew Rate Priority was chosen as the operating mode, repeat steps 3~5 to set F-04 (Rising Voltage Slew Rate) and the F-05 (Falling Voltage Slew Rate) and save.

F-04 / F-05 0.1V/s~60V/s (PSW 30-XX)  
 0.1V/s~80V/s (PSW 40-XX)  
 0.1V/s~160V/s (PSW 80-XX)  
 0.1V/s~320V/s (PSW 160-XX)  
 0.1V/s~500.0V/s (PSW 250-XX)  
 1V/s~1600V/s (PSW 800-XX)

7. Press the Function key again to exit the configuration settings. The function key light will turn off.

Function



8. Use the Current knob to set the current limit (crossover point).

Current ①



9. Use the Voltage knob to set the voltage.

Voltage ①



Note

Notice the Set key becomes illuminated when setting the current or voltage. If the Voltage or Current knobs are unresponsive, press the Set key first.

10. Press the Output key. The Output key becomes illuminated.

Output

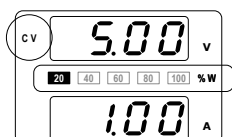
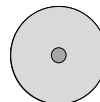

CV and the Power Bar will become illuminated (top left & center)



Note

Only the voltage level can be altered when the output is on. The current level can only be changed by pressing the Set key.

For more information on the Normal Function Settings (F-00 ~ F-61, F-88~F-89) see page 107.

## Set to C.C. Mode

When setting the power supply to constant current mode, a voltage limit must also be set to determine the crossover point. When the voltage exceeds the crossover point, the mode switches to C.V. mode. For details about C.C. operation, see page 22. C.C. and C.V. mode have two selectable slew rates: High Speed Priority and Slew Rate Priority. High Speed Priority will use the fastest slew rate for the instrument while Slew Rate Priority will use a user-configured slew rate.

- |            |   |
|------------|---|
| Background | <p>Before setting the power supply to C.C. mode, ensure:</p> <ul style="list-style-type: none"> <li>• The output is off.</li> <li>• The load is connected.</li> </ul> |
|------------|---|

## Steps

1. Press the Function key. The Function key will light up.



2. The display should show F-01 on the top and the configuration setting for F-01 on the bottom.



3. Rotate the Voltage knob to change the F setting to F-03 (V-I Mode Slew Rate Select).

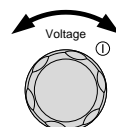

- Use the Current knob to set the F-03 setting.



Set F-03 to 1 (CC High Speed Priority) or 3 (CC Slew Rate Priority) and save.

F-03            1 = CC High Speed Priority  
                   3 = CC Slew Rate Priority

- Press the Voltage knob to save the configuration setting. ConF will be displayed when successful.

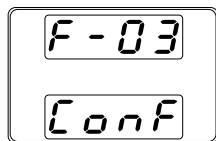
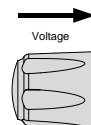

- If CC Slew Rate Priority was chosen as the operating mode, set F-06 (Rising Current Slew Rate) and F-07 (Falling Current Slew Rate) and save.

F-06 / F-07   0.01A/s~72.00A/s (PSW 30-36)  
                   0.1A/s~144.0A/s (PSW 30-72)  
                   0.1A/s~216.0A/s (PSW 30-108)  
                   0.01A/s~54.00A/s (PSW 40-27)  
                   0.1A/s~108.0A/s (PSW 40-54)  
                   0.1A/s~162.0A/s (PSW 40-81)  
                   0.01A/s~27.00A/s (PSW 80-13.5)  
                   0.01A/s~54.00A/s (PSW 80-27)  
                   0.01A/s~81.00A/s (PSW 80-40.5)  
                   0.01A/s~14.40A/s (PSW 160-7.2)  
                   0.01A/s~28.80A/s (PSW 160-14.4)  
                   0.01A/s~43.20A/s (PSW 160-21.6)  
                   0.001A/s~9.000A/s (PSW 250-4.5)  
                   0.01A/s~18.00A/s (PSW 250-9)  
                   0.01A/s~27.00A/s (PSW 250-13.5)  
                   0.001A/s~2.880A/s (PSW 800-1.44)  
                   0.001A/s~5.760A/s (PSW 800-2.88)  
                   0.001A/s~8.640A/s (PSW 800-4.32)

7. Press the Function key again to exit the configuration settings. The function key light will turn off.

Function



8. Use the Voltage knob to set the voltage limit (crossover point).

Voltage ①



9. Use the Current knob to set the current.

Current ①



Note

Notice the Set key becomes illuminated when setting the current or voltage. If the Voltage or Current knobs are unresponsive, press the Set key first.

10. Press the Output key. The Output key becomes illuminated.

Output

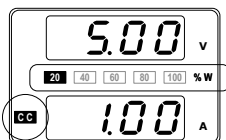
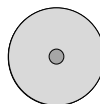

CC and the Power Bar will become illuminated (bottom left & center)



Note

Only the current level can be altered when the output is on. The voltage level can only be changed by pressing the Set key.

For more information on the Normal Function Settings (F-00 ~ F-61, F-88~F-89) see page 107.

## Display Modes

The PSW power supplies allow you to view the output in three different modes: voltage and current, voltage and power or current and power.

- |       |  |   |
|-------|--|---|
| Steps | <ol style="list-style-type: none"> <li>1. Press the PWR/DSPL key. The PWR DSPL key lights up.</li> <li>2. The display changes to voltage and power (V/W).</li> <li>3. To switch between displaying A/W and V/W, simply press the corresponding Voltage or Current knob.</li> </ol> | <p>PWR DSPL</p>  |
|-------|--|---|

For example: when in A/W mode, press the Voltage knob to display V/W. Conversely when in V/W mode, press the Current knob to display A/W.

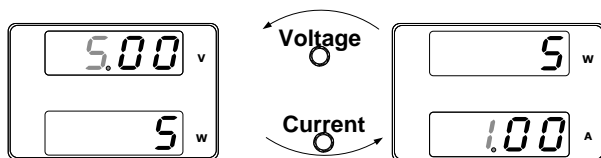

- When V/W is displayed, the Voltage knob can still be used to change the voltage level.
- When A/W is displayed, the Current knob can still be used to change the current level.

- |      |   |   |
|------|---|---|
| Exit | <p>Press the PWR/DSPL key again to return to normal display mode. The PWR DSPL light will turn off.</p> | <p>PWR DSPL</p>  |
|------|---|---|

## Panel Lock

The panel lock feature prevents settings from being changed accidentally. When activated, the Lock/Local key will become illuminated and all keys and knobs except the Lock/Local key and Output key (if active) will be disabled.

If the instrument is remotely controlled via the USB/LAN interface, the panel lock is automatically enabled.

---

Activate the panel lock	Press the Lock/Local key to activate the panel lock. The key will become illuminated.	
-------------------------	---	---

---

Disable the panel lock	Hold the Lock/Local key for ~3 seconds to disable the panel lock. The Lock/Local light turns off.	
------------------------	---	---

---

## Remote Sense

Remote sense is used to compensate for the voltage drop seen across load cables due to the resistance inherent in the load cables. The remote sense terminals are connected to the load terminals to determine the voltage drop across the load cables.

Remote sense can compensate up to 0.6 volts for 30V/40V/80V/160V models and 1V for 250V/800V models (compensation voltage). Load cables should be chosen with a voltage drop less than the compensation voltage.

---



**WARNING**

Ensure the output is off before connecting any sense cables.

Use sense cables with a voltage rating exceeding the isolation voltage of the power supply.

Never connect sensing cables when the output is on. Electric shock or damage to the power supply could result.

---



Note

Be sure to remove the Sense joining plates so the units are not using local sensing.

Single Load

1. Connect the Sense+ terminal to the positive potential of the load. Connect the Sense- terminal to the negative potential of the load.

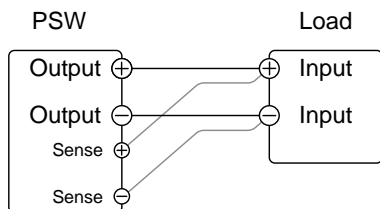

2. Operate the instrument as normal. [Page 62](#)  
See the Basic Operation chapter for details.

Parallel PSW Units

1. Connect the Sense+ terminals to the positive potential of the load. Connect the Sense- terminals to the negative potential of the load.

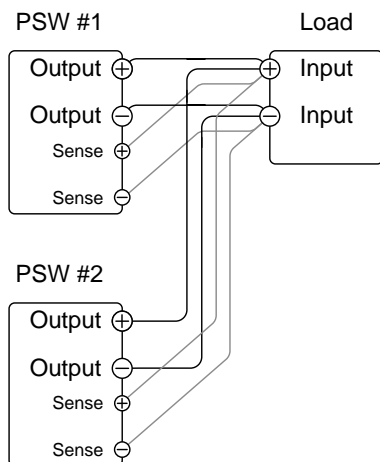



2. Operate the instrument as normal. Page 76  
See the Parallel Operation chapter for details.

- Serial PSW Units
1. a. Connect the 1<sup>st</sup> Sense+ terminal to the positive potential of the load.
  - b. Connect the 1<sup>st</sup> Sense- terminal to the positive output terminal of the second PSW unit.
  - c. Connect the 2<sup>nd</sup> Sense+ terminal to the positive terminal of the second PSW unit.
  - d. Connect the 2<sup>nd</sup> Sense- terminal to negative terminal of the load.

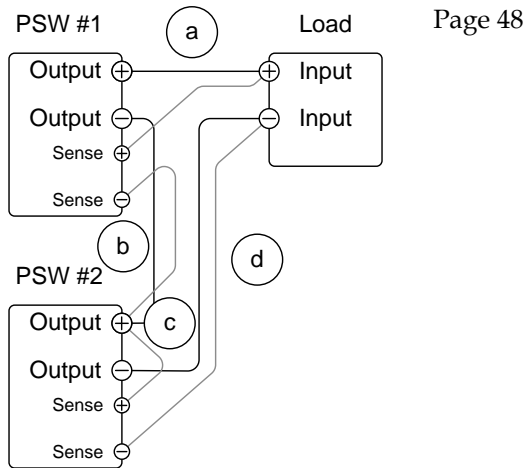

2. Operate the instrument as normal. Page 83  
See the Serial Operation chapter for details.

Wire Shielding  
and Load line  
impedance

To help to minimize the oscillation due to the inductance and capacitance of the load cables, use an electrolytic capacitor in parallel with the load terminals.

To minimize the effect of load line impedance use twisted wire pairing.

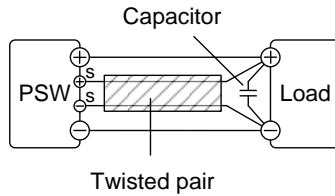

## Parallel / Series Operation

This section describes the basic operations required to operate the power supply in series or parallel. Operating the PSW series in parallel increases the total power output of the power supply units. When used in series, the total output voltage of the power supplies can be increased.

The number of the power supplies that can be connected in series or parallel depends on the model and the mode:

- Series Mode: 2 units maximum; 30V, 40V, 80V and 160V models only.
  - Parallel Mode: 3 units maximum
- 



CAUTION

250V and 800V models do not support series operation!

In series mode, the Bleeder function of the slave will be locked and set to open to prevent electric shock due to there isn't any discharge circuit after the output is turned off. Therefore, when connecting in series for battery test, it is required to connect external diodes in series.

---

To use the power supplies in series or parallel, units must be used in a Master-Slave configuration. In the master-slave configuration a "master" power supply controls any other connected "slave" power supplies.

- Master-Slave Parallel overview → from page 76
- Parallel connection → from page 79
- Parallel operation → from page 81
- Master-Slave Series overview → page 83
- Series connection → page 85
- Series operation → from page 87

Before operating the power supply, please see the Getting Started chapter, page 8.

## Master-Slave Parallel Overview

**Background** When connecting the PSW power supplies in parallel, up to 3 units can be used in parallel and all units must be of the same model. The Analog Control Connector is used as the interface for parallel the connections.

When the units are used in parallel, a number of precautions and limitations apply. Please read this overview before operating the power supplies in parallel.

**Parallel Connection Overview**

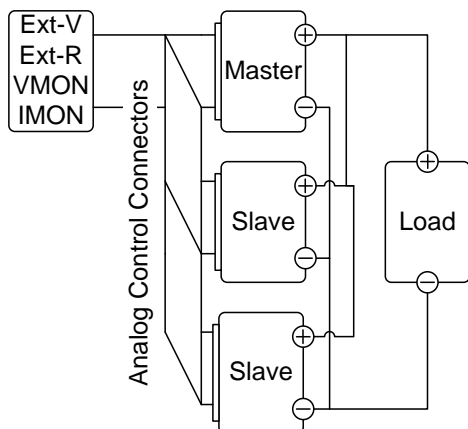

**Limitations**

**Display**

- Only the master unit will display the voltage and current.

**OVP/ OCP**

- The master unit can shut down slave units when OVP/OCP is tripped on the master unit (if the slave connector is wired for shut down on alarm).

- OVP/OCP can be independently tripped on each slave unit, however the shutdown of the power or output of the unit is disabled. Only the alarm will be enabled.

#### Remote monitoring

- Voltage monitoring (VMON) and current monitoring (IMON) are only supported on the master unit.
- The IMON current represents the total current of the all the parallelized units.

#### Remote Sense

- Please see the remote sense chapter for details, page 71.

#### External Voltage and Resistance Control

- Voltage/Resistance controlled remote control can only be used with the master unit.
- The full scale current (in parallel) is equivalent to the maximum external voltage or resistance.

#### Internal Resistance

- For 2 units in parallel, the internal resistance is actually half of the setting value.
- For 3 units in parallel, the internal resistance is actually a third of the setting value.

#### Bleeder Control

- The Master unit is used to control the bleeder settings. The bleeder resistors in all the slave units are always turned off when in parallel mode.

	Model	Single unit	2 units	3 units
Output Voltage/ Output Current	PSW 30-36	30V	30V	30V
		36A	72A	108A
	PSW 40-27	40V	40V	40V
		27A	54A	81A
	PSW 80-13.5	80V	80V	80V
		13.5A	27A	40.5A
	PSW 160-7.2	160V	160V	160V
		7.2A	14.4A	21.6A
	PSW 250-4.5	250V	250V	250V
		4.5A	9A	13.5A
	PSW 800-1.44	800V	800V	800V
		1.44A	2.88A	4.32A
	PSW 30-72	30V	30V	30V
		72A	144A	216A
	PSW 40-54	40V	40V	40V
		54A	108A	162A
	PSW 80-27	80V	80V	80V
		27A	54A	81A
	PSW 160-14.4	160V	160V	160V
		14.4A	28.8A	43.2A
	PSW 250-9	250V	250V	250V
		9A	18A	27A
	PSW 800-2.88	800V	800V	800V
		2.88A	5.76A	8.64A
	PSW 30-108	30V	30V	30V
		108A	216A	324A
	PSW 40-81	40V	40V	40V
		81A	162A	243A
	PSW 80-40.5	80V	80V	80V
		40.5A	81A	121.5A
	PSW 160-21.6	160V	160V	160V
		21.6A	43.2A	64.8A
	PSW 250-13.5	250V	250V	250V
		13.5A	27A	40.5A
	PSW 800-4.32	800V	800V	800V
		4.32A	8.64A	12.96A

## Master-Slave Parallel Connection

**Master-Slave Connector** The Analog Control Connector is used for both serial and parallel connections. The way the connector is configured determines the behavior of the master and slave units. For the complete connector pin assignment, see page 121.

**Analog Connector Connection** To operate the power supplies in parallel, connect the analog connectors on the master and slave units as shown in the diagrams below.

Alternatively pre-configured cables (optional) can be used. The PSW-006 is used for two units in parallel. The PSW-007 is used for 3 units in parallel.

Master with 2 slave units:

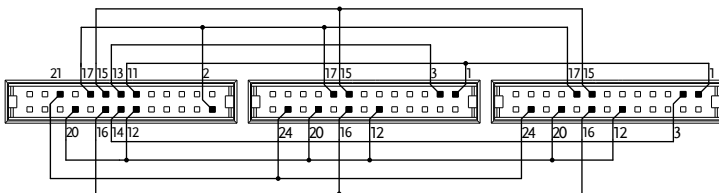

Master unit	Slave Unit 1	Slave Unit 2
11 I MON	1 CURRENT SHARE	1 CURRENT SHARE
21 OUTPUT ON STATUS	24 OUT ON/OFF CONT	24 OUT ON/OFF CONT
20 ALM STATUS	12 SHUTDOWN	12 SHUTDOWN
17 STATUS COM	17 STATUS COM	17 STATUS COM
15 FEEDBACK	15 FEEDBACK	15 FEEDBACK
14 CURRENT_SUM_2	3 CURRENT SUM OUT	3 CURRENT SUM OUT
13 CURRENT_SUM_1	20 ALM STATUS	20 ALM STATUS
12 SHUTDOWN	16 A COM	16 A COM
2 D COM		
16 A COM		

Master with 1 slave unit:

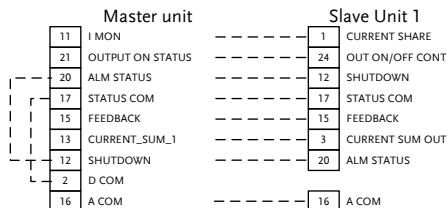
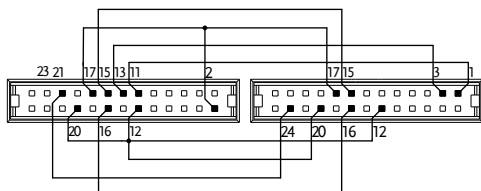

**Parallel Output Connection**

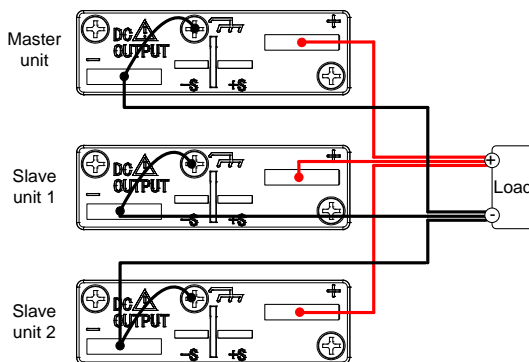

**Steps**

1. Ensure the power is off on all power supplies.
2. Choose a master and a slave unit(s).
3. Connect the analog connectors for the master and slave unit as shown above.
4. Remove the Output Terminal covers and the protection dummy plug from the analog control connector.



5. Connect the master and slave unit in parallel as shown above.

6. Reattach the terminal covers. Page 50



Note

Ensure the load cables have sufficient current capacity. Page 47

Re-attach the Protection dummy plug when not in use.

## Master-Slave Parallel Operation

**Master-Slave Configuration** Before using the power supplies in parallel, the master and slave units need to be configured.

**Steps** 1. Configure the OVP and OCP settings for the master unit. Page 62

2. For each unit, hold the Function key while turning the power on to enter the power on configuration settings.

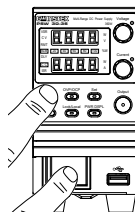

3. Configure F-93 (Master/Slave) setting for each master/slave unit. Page 118

Unit	F-93
Master (with 1 slave in parallel)	1
Master (with 2 slaves in parallel)	2
Slave unit (parallel slave)	3

4. Cycle the power on the units (reset the power).



Note

Configuration settings can be checked for both the master and slave units by pressing the Function key and checking F-93.

Only the Master OVP and OCP level is used for over voltage and current protection. Slave OVP and OCP level is disregarded.

OHP (OTP) works independently for each unit.

**Master-Slave Operation**

Only operate the power supplies in parallel if the units are configured correctly.

1. Turn on the master and slave units. The slave unit(s) will show a blank display.

Master unit



Slave units

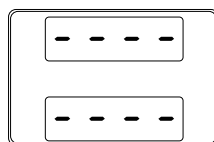

2. Operation of all units is controlled via the master unit. Operation of the master unit is the same as for a single unit. See the Basic Operation chapter. Page 62.

3. Press the Output key to begin.

Output

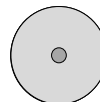

Caution

Only operate the power supplies in parallel if using units of the same model number.

Only a maximum of 3 units can be used in parallel.



Note

The panel controls are disabled on slave units, including the output key. On slave units only the Function key can be used to view the current settings.

## Master-Slave Series Overview

---

### Background

When connecting PSW power supplies in series, up to 2 units\* can be used in series and all units must be of the same model. The Analog Control Connector is used as the interface for serial connections.

When the units are used in series, a number of precautions and limitations apply. Please read this overview before operating the power supplies in series.



CAUTION

\*250V and 800V models do not support series operation!

### Series Connection Overview

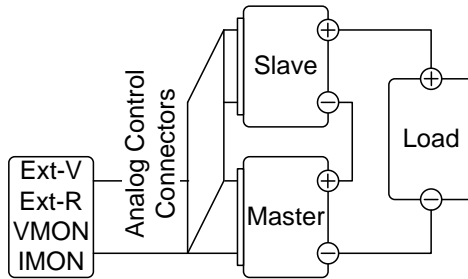

### Limitations

#### Display

- Only the master unit will display the current.
- Master and slave units display the voltage. The total voltage is the sum of the units.

#### OVP/OCP

- The master unit can shut down the slave unit

when OVP/OCP is tripped on the master unit (if the slave connector is wired for shut down on alarm).

- OVP and OCP level is determined by the master OVP and OCP level. The OVP and OCP level on the slave unit is ignored.

#### Remote monitoring

- Voltage monitoring (VMON) and current monitoring (IMON) are only supported on the master unit.
- The VMON voltage represents the total voltage of the all the serialized units.

#### Remote Sense

- Please see the remote sense chapter for details, page 71.

#### External Voltage and Resistance Control

- Voltage/Resistance controlled remote control can only be used with the master unit.
- The full scale voltage (in series) is equivalent to the maximum external voltage or resistance.

#### Slew Rate

- The actual slew rate is double that of the setting slew rate. I.e., A slew rate setting of 60.00V/s is actually 120V/s when in series.

#### Internal Resistance

- The internal resistance is actually twice that of the setting value.

#### Bleeder Control

- The Master unit is used to control the bleeder settings. The bleeder resistor is always turned on for the slave unit in series mode.

	Model	Single unit	2 units
Output Voltage/ Output Current	PSW 30-36	30V	60V
		36A	36A
	PSW 40-27	40V	80V
		27A	27A
	PSW 80-13.5	80V	160V
		13.5A	13.5A
	PSW 160-7.2	160V	320V
		7.2A	7.2A
	PSW 30-72	30V	60V
		72A	72A
	PSW 40-54	40V	80V
		54A	54A
	PSW 80-27	80V	160V
		27A	27A
	PSW 160-14.4	160V	320V
		14.4A	14.4A
	PSW 30-108	30V	60V
		108A	108A
	PSW 40-81	40V	80V
		81A	81A
	PSW 80-40.5	80V	160V
		40.5A	40.5A
	PSW 160-21.6	160V	320V
		21.6A	21.6A

## Master-Slave Series Connection

---

### Master-Slave Connector

The Analog Control Connector is used for both serial and parallel connections. The way the connector is configured determines the behavior of the master and slave units. For the connector pin assignment, see page 121.

---

**Analog Connector Connection** To operate the power supplies in series, connect the analog connectors on the master and slave unit as shown in the diagram below.

Alternatively, the optional PSW-005 cable is pre-configured for serial use.

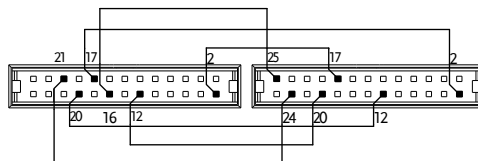

Master unit		Slave Unit 1	
16	A COM	25	SER SLV IN
21	OUTPUT ON STATUS	24	OUT OFF/ON CONT
20	ALM STATUS	12	SHUTDOWN
17	STATUS COM	2	D COM
12	SHUTDOWN	20	ALM STATUS
2	D COM	17	STATUS COM

**Series Output Connection**

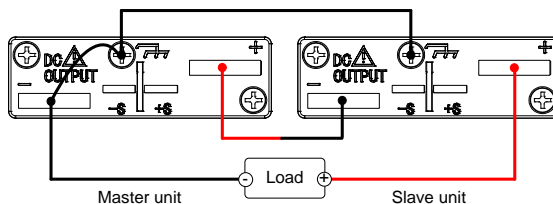

**Steps**

1. Ensure the power is off on both power supplies.
2. Choose a master and slave unit.
3. Connect the analog connectors for the master and slave unit as shown above.
4. Remove the output terminal cover Page 50 and the protection dummy plug from the analog control connector.

5. Connect the master and slave unit in series as shown above.

6. Reattach the terminal cover. Page 50



Note

Ensure load cables have sufficient current capacity. Page 47

Re-attach the protection dummy plug when not in use.

## Master-Slave Series Operation

**Master-Slave Configuration**      Before using the power supplies in series, the master and slave units need to be configured.

1. Configure the OVP and OCP settings for the master unit. Page 62

2. For each unit, hold the Function key while turning the power on to enter the power on configuration settings.

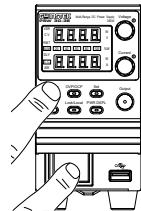

3. Configure F-93 (Master/Slave) setting for each master/slave unit. Page 118

Unit	F-93
Master (local or series operation)	0
Slave unit (series)	4

4. Cycle the power on the units (reset the power).



Note

Configuration settings can be checked for both the master and slave units by pressing the Function key.

**Master-Slave Operation**

Only operate the power supplies in series if the units are configured correctly.

1. Turn on the master and slave unit. The slave unit will only show the voltage of the slave units while the master unit will show the voltage of the master unit and show the combined current of both units.

Master unit



Slave unit

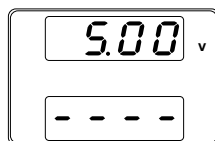

2. Operation of all units is controlled via the master unit. Operation of the master unit is the same as for a single unit. Please see the basic operation chapter for details.

Page 62

3. Press the Output key to begin.

Output



CAUTION

Only operate the power supplies in series if using units of the same model number. 250V and 800V models do not support series operation!

Only a maximum of 2 units can be used in series.



Note

The panel controls are disabled on slave units, including the output key.



## Test Scripts

This section describes how to use the Test function to run, load and save test scripts for automated testing. The Test function is useful if you want to perform a number of tests automatically. The PSW test function can store ten test scripts in memory.

Each test script is programmed in a scripting language. For more information on how to create test scripts, please contact GW Instek.

- Test Script File Format → from page 90
- Test Script Settings → from page 90
- Setting the Test Script Settings → from page 91
- Load Test Script → from page 92
- Run Test Script (Manually) → from page 94
- Run Test Script (Automatically at startup) → from page 96
- Export Test Script → from page 97
- Remove Test Script → from page 98
- Check the Available Memory Capacity → from page 99

## Test Script File Format

---

Background	The test files are saved in *.tst file format.  Each file is saved as tXXX.tst, where XXX is the save file number 001~010.
------------	--

## Test Script Settings

---

Test Run	Runs the chosen test script from the internal memory. A script must first be loaded into the internal memory before it can be run. See the test function Test Save, below.  The script will run as soon as the test function is started.
	T-01                      1~10
Test Load	Loads a test script from the USB drive to the designated save slot in memory. A script must first be loaded into internal memory before it can be run.
	T-02                      1~10 (USB→PSW)
Test Export	Exports a script from the designated memory save slot to the USB drive.
	T-03                      1~10 (PSW→USB)
Test Remove	Deletes the chosen test file from the PSW internal memory.
	T-04                      1~10
Test Memory	Displays the amount of internal memory that is available on the unit in kilobytes (1024 bytes).
	T-05                      Max: 1848 KB

## Setting the Test Script Settings

Steps                      The test script settings (T-01~T-04) are set with the Test key.

1. Press the Test key. The Test key will light up. 
2. The display will show T-01 on the top and the memory no. for T-01 on the bottom. The bottom of the screen will also indicate whether the memory no. has a script loaded, "y" (yes) or "n" (no).

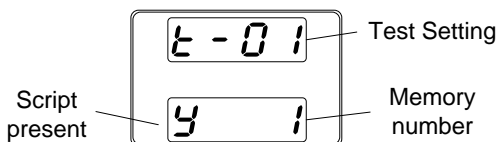
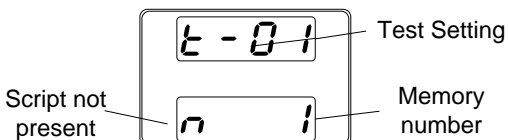

3. Rotate the Voltage knob to change the T setting (Test setting).

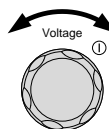

Test Run	T-01
Test Load	T-02
Test Export	T-03
Test Remove	T-04
Test Memory	T-05

4. Rotate the Current knob to choose a memory number.

Range 1~10

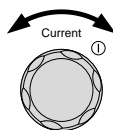

5. Press the Voltage knob to complete the setting.

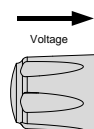

Exit

Press the Test key again to exit the Test settings. The Test key light will turn off.



## Load Test Script from USB

Overview

Before a test script can be run, it must first be loaded into a one of the 10 memory save slots. Before loading a test script into memory:

- Ensure the script file is placed in the root directory.
- Ensure the file name number corresponds to the memory number that you wish to save to.

For example: A test file named t001.tst can only be saved to memory number 01, t002.tst can only be saved to memory number 02, and so on.

Steps

1. Insert a USB flash drive into the front panel USB-A slot. Ensure the flash drive contains a test script in the root directory.

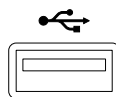

2. Turn on the power. MS (Mass Storage) will be displayed on the screen after a few seconds if the USB drive is recognized.

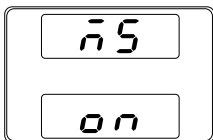

Note

If the USB drive is not recognized, check to see that the function settings for F-20 = 1 (page 112). If not, reinsert the USB flash drive.

3. Configure T-02 (Test Load) to 1~10 Page 91 (save memory slot)  
T-02 range 1~10 (t001 ~t010)
4. The script will now be available in the memory slot the script was saved to.



Note

Error messages: If you load a file that is not present on the USB drive “Err 002” will be displayed on the display.

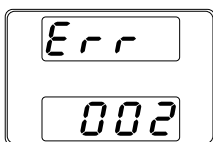

## Run Test Script (Manual)

---

Overview A test script can be run from one of ten memory slots.

---

- Steps
1. Before a test script can be run, it must first be loaded into one of the 10 memory save slots. Page 92
  2. Configure T-01 (Run Test) to 1~10 (save memory slot#)  
T-01 range 1~10 Page 91
  3. The loading screen will appear. For example if memory slot #1 is loaded, the following screen will appear.

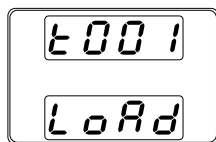

Note

If the script is very small, the loading screen may not appear on the screen for very long.

When the “t00X Load” screen is shown on the display, pushing the TEST key will abort the loading procedure.

---

- If there are no errors during loading, the script engine will enter the wait state. The wait state indicates that the unit is ready to execute the script.

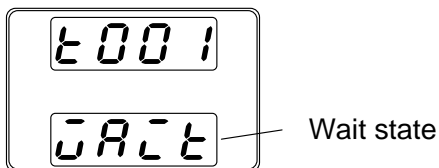

- To execute the script, press the Output key. The Output key becomes illuminated.

Output

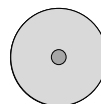

- When the script is executing, the measurement results will display as normal.
- The Test LED will flash.



Note

When a script is running, press the Output key again to return the script engine to the wait state.



Note

When a script is running, press the Test key to abort the execution of the script and return to normal operating mode. The Test LED will turn off after the script has been aborted.



Note

Error messages: If you try to run a test script from an empty memory location "Err 003" will be displayed on the display.

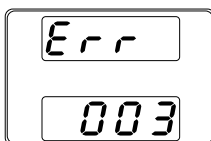

## Run Test Script (Automatically at Startup)

---

Overview	The power supply can be configured to automatically run a test script at startup.	
Steps	<ol style="list-style-type: none"><li>1. Before a test script can be run, it must first be loaded into one of the 10 memory save slots.</li><li>2. Turn the unit off.</li><li>3. Enter the power-on configuration settings and set F-92 (Power-ON Output) to run the desired test script. Range      T001~T010*</li><li>4. The selected test script will automatically start to run the next time the unit is powered on.</li></ol>	Page 92   Page 118

---



Note

\*Setting F-92 to 0 or 1 will disable loading a test script at startup. 0 will turn the output off at startup. 1 will turn the output on at startup. See the power on configuration settings for details, page 114.

---



Note

When a script is running, press the Output key to pause the script. To resume the script, press the Output key again.



## Export Test Script to USB

---

### Overview

The Export Test function saves a test file to the root directory of a USB flash drive.

- Files will be saved as tXXX.tst where XXX is the memory number 001~010 from which the test script was exported from.
- Files of the same name on the USB flash drive will be written over.

### Steps

1. Insert a USB flash drive into the front panel USB-A slot.



2. Turn on the power. MS (Mass Storage) will be displayed on the screen after a few seconds if the USB drive is recognized.

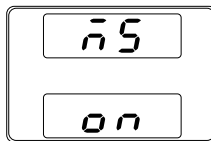

### Note

If the USB drive is not recognized, check to see that the function settings for F-20 = 1 (page 112). If not, reinsert the USB flash drive.

3. Configure T-03 (Test Export) to 0~10 (save memory slot) Page 91

T-03 range 1~10

4. The script will now be copied to the USB flash drive.
-



Note

Error messages: If you try to export a test script from an empty memory location “Err 003” will be displayed on the display.

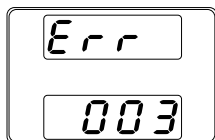

## Remove Test Script

---

### Overview

The Remove Test function will delete a test script from the internal memory.

---

### Steps

1. Select T-04 (Test Remove) and choose which test script to remove from the internal memory. Page 91  
T-04 range 1~10
  2. The test script will be removed from the internal memory.
- 



Note

Error messages: If you try to remove a test script from an empty memory location “Err 003” will be displayed on the display.

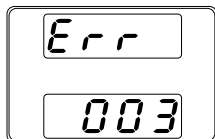

## Checking the Available Memory

---

**Overview**            The T-05 function displays the amount of internal memory that is left on the unit to load test scripts. The displayed units are in kilobytes (1024 bytes).

---

**Steps**                Select T-05 (Test Memory). The available memory in kilobytes is displayed. Page 91

T-05 range 1~1848 KB

# C ONFIGURATION

---

Configuration.....	101
Configuration Table.....	101
Normal Function Settings .....	107
USB/GPIB Settings .....	112
LAN Settings .....	112
System Settings .....	114
Power On Configuration Settings .....	114
Calibration .....	116
Setting Normal Function Settings.....	116
Setting Power On Configuration Settings .....	118

## Configuration

Configuration of the PSW power supplies is divided into five different configuration settings: Normal Function, USB/GPIB/RS232, LAN, Power ON Configuration, Calibration Settings and System Settings. Power ON Configuration differs from the other settings in that the settings used with Power ON Configuration settings can only be set during power up. The other configuration settings can be changed when the unit is already on. This prevents some important configuration parameters from being changed inadvertently. Power On Configuration settings are numbered F-90 to F-95 and the other configuration settings are numbered F-00 to F-61, F-71 to F-74 and F-88 to F-89.

### Configuration Table

Please use the configuration settings listed below when applying the configuration settings.

Normal Function		
Settings	Setting	Setting Range
Output ON delay time	F-01	0.00s~99.99s
Output OFF delay time	F-02	0.00s~99.99s
V-I mode slew rate select	F-03	0 = CV high speed priority 1 = CC high speed priority 2 = CV slew rate priority 3 = CC slew rate priority
Rising voltage slew rate	F-04	0.01V/s~60.00V/s (PSW 30-XX) 0.01V/s~80.00V/s (PSW 40-XX) 0.1V/s~160.0V/s (PSW 80-XX) 0.1V/s~320.0V/s (PSW 160-XX) 0.1V/s~500.0V/s (PSW 250-XX) 1V/s~1600V/s (PSW 800-XX)
Falling voltage slew rate	F-05	0.01V/s~60.00V/s (PSW 30-XX) 0.01V/s~80.00V/s (PSW 40-XX) 0.1V/s~160.0V/s (PSW 80-XX) 0.1V/s~320.0V/s (PSW 160-XX) 0.1V/s~500.0V/s (PSW 250-XX) 1V/s~1600V/s (PSW 800-XX)

		0.01A/s~72.00A/s (PSW 30-36)
		0.1A/s~144.0A/s (PSW 30-72)
		0.1A/s~216.0A/s (PSW 30-108)
		0.01A/s-54.00A/s (PSW 40-27)
		0.1A/s-108.0A/s (PSW 40-54)
		0.1A/s-162.0A/s (PSW 40-81)
		0.01A/s~27.00A/s (PSW 80-13.5)
		0.01A/s~54.00A/s (PSW 80-27)
		0.01A/s~81.00A/s (PSW 80-40.5)
Rising current slew rate	F-06	0.01A/s~14.40A/s (PSW 160-7.2)
		0.01A/s~28.80A/s (PSW 160-14.4)
		0.01A/s~43.20A/s (PSW 160-21.6)
		0.001A/s ~ 9.000A/s (PSW 250-4.5)
		0.01A/s ~ 18.00A/s (PSW 250-9)
		0.01A/s ~ 27.00A/s (PSW 250-13.5)
		0.001A/s ~ 2.880A/s (PSW 800-1.44)
		0.001A/s ~ 5.760A/s (PSW 800-2.88)
		0.001A/s ~ 8.640A/s (PSW 800-4.32)
<hr/>		
		0.01A/s~72.00A/s (PSW 30-36)
		0.1A/s~144.0A/s (PSW 30-72)
		0.1A/s~216.0A/s (PSW 30-108)
		0.01A/s-54.00A/s (PSW 40-27)
		0.1A/s-108.0A/s (PSW 40-54)
		0.1A/s-162.0A/s (PSW 40-81)
		0.01A/s~27.00A/s (PSW 80-13.5)
		0.01A/s~54.00A/s (PSW 80-27)
		0.01A/s~81.00A/s (PSW 80-40.5)
Falling current slew rate	F-07	0.01A/s~14.40A/s (PSW 160-7.2)
		0.01A/s~28.80A/s (PSW 160-14.4)
		0.01A/s~43.20A/s (PSW 160-21.6)
		0.001A/s ~ 9.000A/s (PSW 250-4.5)
		0.01A/s ~ 18.00A/s (PSW 250-9)
		0.01A/s ~ 27.00A/s (PSW 250-13.5)
		0.001A/s ~ 2.880A/s (PSW 800-1.44)
		0.001A/s ~ 5.760A/s (PSW 800-2.88)
		0.001A/s ~ 8.640A/s (PSW 800-4.32)

		0.000Ω ~ 0.833Ω (PSW 30-36)
		0.000Ω ~ 0.417Ω (PSW 30-72)
		0.000Ω ~ 0.278Ω (PSW 30-108)
		0.000Ω ~ 1.481Ω (PSW 40-27)
		0.000Ω ~ 0.741Ω (PSW 40-54)
		0.000Ω ~ 0.494Ω (PSW 40-81)
		0.000Ω ~ 5.926Ω (PSW 80-13.5)
		0.000Ω ~ 2.963Ω (PSW 80-27)
Internal resistance setting	F-08	0.000Ω ~ 1.975Ω (PSW 80-40.5)
		0.000Ω ~ 22.222Ω (PSW 160-7.2)
		0.000Ω ~ 11.111Ω (PSW 160-14.4)
		0.000Ω ~ 7.407Ω (PSW 160-21.6)
		0.00Ω ~ 55.55Ω (PSW 250-4.5)
		0.00Ω ~ 27.77Ω (PSW 250-9)
		0.00Ω ~ 18.51Ω (PSW 250-13.5)
		0.0Ω ~ 555.5Ω (PSW 800-1.44)
		0.0Ω ~ 277.8Ω (PSW 800-2.88)
		0.0Ω ~ 185.1Ω (PSW 800-4.32)
Bleeder circuit control	F-09	0 = OFF, 1 = ON, 2 = AUTO
Buzzer ON/OFF control	F-10	0 = OFF, 1 = ON
Measurement Average Setting	F-17	0 = Low, 1 = Middle, 2 = High
Lock Mode	F-19	0 = Panel lock: allow output off 1 = Panel lock: allow output on/off
<b>USB/GPIB/RS232 settings</b>		
Front panel USB State	F-20	0 = Absent, 1 = Mass Storage
Rear panel USB State	F-21	0 = Absent, 2 = USB-CDC, 3 = GPIB-USB adapter, 5 = RS232-USB adapter
Rear panel USB mode	F-22	0 = Disable, 1 = USB Host, 2 = Auto detect speed, 3 = Full speed only
GPIB address	F-23	0~30
<b>LAN settings</b>		
MAC Address-1	F-30	0x00~0xFF
MAC Address-2	F-31	0x00~0xFF
MAC Address-3	F-32	0x00~0xFF
MAC Address-4	F-33	0x00~0xFF
MAC Address-5	F-34	0x00~0xFF
MAC Address-6	F-35	0x00~0xFF
LAN	F-36	0 = Disable, 1 = Enable

DHCP	F-37	0 = Disable, 1 = Enable
IP Address-1	F-39	0~255
IP Address-2	F-40	0~255
IP Address-3	F-41	0~255
IP Address-4	F-42	0~255
Subnet Mask-1	F-43	0~255
Subnet Mask-2	F-44	0~255
Subnet Mask-3	F-45	0~255
Subnet Mask-4	F-46	0~255
Gateway-1	F-47	0~255
Gateway-2	F-48	0~255
Gateway-3	F-49	0~255
Gateway-4	F-50	0~255
DNS address -1	F-51	0~255
DNS address -2	F-52	0~255
DNS address-3	F-53	0~255
DNS address-4	F-54	0~255
Sockets active	F-57	0 = Disable, 1 = Enable
Web Server active	F-59	0 = Disable, 1 = Enable
Web password active	F-60	0 = Disable, 1 = Enable
Web setting password	F-61	0000~9999
<b>UART Settings**</b>		
UART Baud Rate	F-71	0 = 1200, 1 = 2400, 2 = 4800, 3 = 9600, 4 = 19200, 5 = 38400, 6 = 57600, 7 = 115200
UART Data Bits	F-72	0 = 7 bits, 1 = 8 bits
UART Parity	F-73	0 = None, 1 = Odd, 2 = Even
UART Stop Bit	F-74	0 = 1 bit, 1 = 2 bits
<b>System Settings</b>		
Factory Set Value	F-88	0 = No effect 1 = Return to factory settings
Show Version	F-89	0, 1 = PSW version 2, 3 = PSW build year 4, 5 = PSW build month/day 6, 7 = Keyboard CPLD version 8, 9 = Analog-Control CPLD version A, B = Reserved C, D = Kernel build year E, F = Kernel build month/day G, H = Test command version



I, J = Test command build year  
 K, L = Test command build month/day  
 M, N = USB Driver version.

Power On Configuration Settings*		
CV Control	F-90	0 = Panel control (local) 1 = External voltage control 2 = External resistance control (Ext-R $\searrow$ 10k $\Omega$ = Vo, max) 3 = External resistance control (Ext-R $\nearrow$ 10k $\Omega$ = 0)
CC Control	F-91	0 = Panel control (local) 1 = External voltage control 2 = External resistance control (Ext-R $\searrow$ 10k $\Omega$ = Io,max) 3 = External resistance control (Ext-R $\nearrow$ 10k $\Omega$ = 0)
Power-ON Output	F-92	0 = OFF at startup 1 = ON at startup T001 ~ T010 = Run test script TXX at start up
Master/Slave	F-93	0 = Master/Local 1 = Master/Parallel1 2 = Master/Parallel2 3 = Slave/Parallel 4 = Slave/Series (Only 30V, 40V, 80V, 160V models)
External Out Logic	F-94	0 = High ON, 1 = Low ON
Power Switch trip	F-95	0 = Enable , 1 = Disable
Calibration Settings*		
Calibration	F-00	0000 ~ 9999



\* Note

Power On and Calibration settings can only be set during power up.



\*\* Note

GUR-001A and GUR-001B is only available from firmware version 2.25 or above.



## Normal Function Settings

---

**Output ON Delay Time** Delays turning the output on for a designated amount of time. The Delay indicator will light when the Delay time is not 0.

Note: The Output ON Delay Time setting has a maximum deviation (error) of 20ms.

The Output ON Delay Time setting is disabled when the output is set to external control.

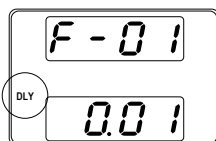

F-01 0.00s~99.99s

---

**Output OFF Delay Time** Delays turning the output off for a designated amount of time. The Delay indicator will light when the Delay time is not 0.

Note: The Output OFF Delay Time setting has a maximum deviation (error) of 20ms.

The Output OFF Delay Time setting is disabled when the output is set to external control.

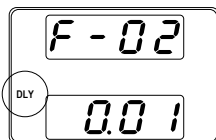

F-02 0.00s~99.99s

---

**V-I Mode** Selects High Speed Priority or Slew Rate Priority for CV or CC mode. The voltage or current slew rate can only be edited if CC/CV Slew Rate Priority is selected. The ISR indicator will be lit for CC Slew Rate Priority and the VSR indicator will be lit for CV Slew Rate Priority.

Note: CC and CV Slew Rate Priority mode are disabled when voltage/current output is set to external control.

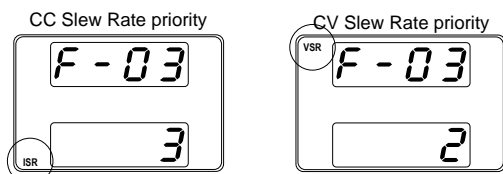

- F-03
- 0 = CV high speed priority
  - 1 = CC high speed priority
  - 2 = CV slew rate priority
  - 3 = CC slew rate priority

**Rising Voltage Slew Rate** Sets the rising voltage slew rate. Only applicable if V-I Mode is set to CV Slew Rate Priority.

- F-04
- 0.01V/s~60V/s (PSW 30-XX)
  - 0.01V/s~80.00V/s (PSW 40-XX)
  - 0.1V/s~160V/s (PSW 80-XX)
  - 0.1V/s~320V/s (PSW 160-XX)
  - 0.1V/s~500.0V/s (PSW 250-XX)
  - 1V/s~1600V/s (PSW 800-XX)

**Falling Voltage Slew Rate** Sets the falling voltage slew rate. Only applicable if V-I Mode is set to CV Slew Rate Priority.

- F-05
- 0.01V/s~60V/s (PSW 30-XX)
  - 0.01V/s~80.00V/s (PSW 40-XX)
  - 0.1V/s~160V/s (PSW 80-XX)
  - 0.1V/s~320V/s (PSW 160-XX)
  - 0.1V/s~500.0V/s (PSW 250-XX)
  - 1V/s~1600V/s (PSW 800-XX)

Rising Current Slew Rate	Sets the rising current slew rate. Only applicable if V-I Mode is set to CC Slew Rate Priority.
F-06	0.01A/s~72.00A/s (PSW 30-36) 0.1A/s~144.0A/s (PSW 30-72) 0.1A/s~216.0A/s (PSW 30-108) 0.01A/s~54.00A/s (PSW 40-27) 0.1A/s~108.0A/s (PSW 40-54) 0.1A/s~162.0A/s (PSW 40-81) 0.01A/s~27.00A/s (PSW 80-13.5) 0.01A/s~54.00A/s (PSW 80-27) 0.01A/s~81.00A/s (PSW 80-40.5) 0.01A/s~14.40A/s (PSW 160-7.2) 0.01A/s~28.80A/s (PSW 160-14.4) 0.01A/s~43.20A/s (PSW 160-21.6) 0.001A/s~9.000A/s (PSW 250-4.5) 0.01A/s~18.00A/s (PSW 250-9) 0.01A/s~27.00A/s (PSW 250-13.5) 0.001A/s~2.880A/s (PSW 800-1.44) 0.001A/s~5.760A/s (PSW 800-2.88) 0.001A/s~8.640A/s (PSW 800-4.32)
Falling Current Slew Rate	Sets the falling current slew rate. Only applicable if V-I Mode is set to CC Slew Rate Priority.
F-07	0.01A/s~72.00A/s (PSW 30-36) 0.1A/s~144.0A/s (PSW 30-72) 0.1A/s~216.0A/s (PSW 30-108) 0.01A/s~54.00A/s (PSW 40-27) 0.1A/s~108.0A/s (PSW 40-54) 0.1A/s~162.0A/s (PSW 40-81) 0.01A/s~27.00A/s (PSW 80-13.5) 0.01A/s~54.00A/s (PSW 80-27) 0.01A/s~81.00A/s (PSW 80-40.5) 0.01A/s~14.40A/s (PSW 160-7.2) 0.01A/s~28.80A/s (PSW 160-14.4) 0.01A/s~43.20A/s (PSW 160-21.6) 0.001A/s~9.000A/s (PSW 250-4.5) 0.01A/s~18.00A/s (PSW 250-9) 0.01A/s~27.00A/s (PSW 250-13.5) 0.001A/s~2.880A/s (PSW 800-1.44) 0.001A/s~5.760A/s (PSW 800-2.88) 0.001A/s~8.640A/s (PSW 800-4.32)

Internal Resistance Settings	Sets the internal resistance of the power supply. F-08	<p>0.000Ω ~0.833Ω (PSW 30-36)</p> <p>0.000Ω ~0.417Ω (PSW 30-72)</p> <p>0.000Ω ~0.278Ω (PSW 30-108)</p> <p>0.000Ω ~ 1.481Ω (PSW 40-27)</p> <p>0.000Ω ~ 0.741Ω (PSW 40-54)</p> <p>0.000Ω ~ 0.494Ω (PSW 40-81)</p> <p>0.000Ω ~5.926Ω (PSW 80-13.5)</p> <p>0.000Ω ~2.963Ω (PSW 80-27)</p> <p>0.000Ω ~1.975Ω (PSW 80-40.5)</p> <p>0.000Ω ~22.222Ω (PSW 160-7.2)</p> <p>0.000Ω ~11.111Ω (PSW 160-14.4)</p> <p>0.000Ω~7.407Ω (PSW 160-21.6)</p> <p>0.00Ω ~ 55.55Ω (PSW 250-4.5)</p> <p>0.00Ω ~ 27.77Ω (PSW 250-9)</p> <p>0.00Ω ~ 18.51Ω (PSW 250-13.5)</p> <p>0.0Ω ~ 555.5Ω (PSW 800-1.44)</p> <p>0.0Ω ~ 277.8Ω (PSW 800-2.88)</p> <p>0.0Ω ~ 185.1Ω (PSW 800-4.32)</p>
------------------------------	---	---

**Bleeder Control**    Bleeder control turns ON/OFF the bleeder resistor. When set to AUTO the bleeder resistor is automatically turned on when the output is turned on and turned off when the output or power is turned off. See page 27 for usage details.



**Caution**

When Bleeder Control is turned OFF or set to AUTO, the bleeder resistor is turned off when the power or output is turned off.

The AUTO setting is only applicable to firmware version 1.59 or above.

The following table shows how the state of the bleeder resistor depends on the Bleeder Control settings, the power state and the output state.

Bleeder Control Setting			
F-09	0 = OFF	1 = ON	2 = AUTO
Bleeder resistor State			
Output ON	OFF	ON	ON
Output OFF	OFF	ON	OFF
Power OFF	OFF	ON	OFF

F-09                      0 = OFF, 1 = ON, 2 = AUTO

**Buzzer ON/OFF**      Turns the buzzer sound on or off. The buzzer is associated with alarm sounds and keypad entry sounds.

F-10                      0 = OFF, 1 = ON

**Measurement Average Setting**      Determines the level of smoothing for the average setting.

Only available for firmware version 1.5 or above.

F-17                      0 = Low, 1 = Middle, 2 = High

**Lock Mode**                      Determines the behavior of the Output key when the panel lock is on.

Only available for firmware version 1.54 or above.

F-19                      0 = Panel lock: allow output off, 1 = Panel lock: allow output on/off

## USB/GPIB Settings

---

Front Panel USB State	Displays the front panel USB-A port state. This setting is not configurable. F-20	0 = Absent, 1 = Mass Storage
Rear Panel USB State	Displays the rear panel USB-B port state. This setting is not configurable. F-21	0 = Absent, 2 = USB-CDC, 3 = GPIB-USB adapter
Rear Panel USB Mode	Sets the rear panel USB mode.  Note: Option #3, USB CDC Full Speed Only, can be used to reduce the data transmission speed when there are sources of interference in the operating environment. This option is only available for firmware version 1.42 and above. F-22	0 = Disable, 1 = USB Host, 2 = Auto detect speed, 3 = Full speed only
GPIB Address	Sets the GPIB address. F-23	0~30

## LAN Settings

---

MAC Address-1~6	Displays the MAC address 1~6. This setting is not configurable. F-30~F-35	0x00~0xFF
LAN	Turns Ethernet on or off. F-36	0 = Disable, 1 = Enable
DHCP	Turns DHCP on or off. F-37	0 = Disable, 1 = Enable



---

IP Address-1~4	Sets the default IP address. IP address 1~4 splits the IP address into four sections. (F-39 : F-40 : F-41 : F-42) (0~255 : 0~255 : 0~255 : 0~255)
Subnet Mask 1~4	Sets the subnet mask. The subnet mask is split into four parts. (F-43 : F-44 : F-45 : F-46) (0~255 : 0~255 : 0~255 : 0~255)
Gateway 1~4	Sets the gateway address. The gateway address is split into 4 parts. (F-47 : F-48 : F-49 : F-50) (0~255 : 0~255 : 0~255 : 0~255)
DNS Address 1~4	Sets the DNS address. The DNS address is split into 4 parts. (F-51 : F-52 : F-53 : F-54) (0~255 : 0~255 : 0~255 : 0~255)
Sockets active	Enables WebSocket connections. F-57                      0 = Disable, 1 = Enable
Web server active	Turns Web server control on/off. F-59                      0 = Disable, 1 = Enable
Web Password active	Turns a web password on/off. F-60                      0 = Disable, 1 = Enable
Web Password	Sets the Web password. F-61                      0000 ~ 9999

---

## System Settings

---

**Factory Set Value** Returns the PSW to the factory default settings. See page 163 for a list of the default settings.  
**F-88** 0 = Disable, 1 = Return to factory default settings.

---

**Show Version** Displays the PSW version number, build date, keyboard version, analog-control version, kernel build, test command version and test command build date.  
**F-89** 0, 1 = PSW version  
 2, 3 = PSW build year  
 4, 5 = PSW build month/day  
 6, 7 = Keyboard CPLD version  
 8, 9 = Analog-Control CPLD version  
 A, B = Reserved  
 C, D = Kernel build year  
 E, F = Kernel build month/day  
 G, H = Test command version  
 I, J = Test command build year  
 K, L = Test command build month/day  
 M, N = USB Driver version

---

## Power On Configuration Settings

---

**CV Control** Sets the constant voltage (CV) control mode between local and external voltage/resistance control. For external voltage control, see page 123 (External Voltage Control of Voltage Output) and page 128(External Resistance Control of Voltage Output).

	F-90	<p>0= Panel control (local)  1 = External voltage control  2 = External resistance control  (Ext-R<math>\leq</math> 10k<math>\Omega</math> = <math>V_{o,max}</math>)  3 = External resistance control  (Ext-R<math>\geq</math> 10k<math>\Omega</math> = 0)</p>	
CC Control		<p>Sets the constant current (CC) control mode between local and external voltage/resistance control. For details on external voltage control, see page 126 (External Voltage Control of Current Output) and 130 (External Resistance Control of Current Output).</p> <p>F-91</p>	<p>0= Panel control (local)  1 = External voltage control  2 = External resistance control  (Ext-R<math>\leq</math> 10k<math>\Omega</math> = <math>I_{o,max}</math>)  3 = External resistance control  (Ext-R<math>\geq</math> 10k<math>\Omega</math> = 0)</p>
Power-ON Output		<p>Configures the power supply to do one of the following at startup: keep the output off, turn the output on, or load a test script.</p> <p>F-92</p>	<p>0 = OFF at startup  1 = ON at startup  T001 ~ T010 = Run test script TXX at start up</p>
Master/Slave		<p>Sets the power supply as master or slave. See the parallel/series operation for details, page 75.</p> <p>F-93</p>	<p>0 = Master/Local  1 = Master/Parallel1  2 = Master/Parallel2  3 = Slave/Parallel  4 = Slave/Series (Only for 30V, 40V, 80V, 160V models)</p>
External Out Logic		<p>Sets the external logic as active high or low.</p> <p>F-94</p>	<p>0= High ON, 1 = Low ON</p>

Power Switch Trip Turns the power off if enabled when the protection settings are tripped.  
 F-95                      1 = Disable, 0 = Enable

## Calibration

---

Programmable Calibration The calibration password is used to access the local mode calibration or other special functions. The password used determines which function is accessed. Please see your distributor for details.  
 F-00                      0000 ~ 9999

## Setting Normal Function Settings

---

The normal function settings (F-01~F-61, F-88~F-89) can be easily configured with the Function key.

- Ensure the load is not connected.
- Ensure the output is off.



Note

Function setting F-89 (Show Version) can only be viewed, not edited.

Configuration settings F-90~F-95 cannot be edited in the Normal Function Settings. Use the Power On Configuration Settings. See page 118 for details.

Steps

1. Press the Function key. The function key will light up.

Function



2. The display will show F-01 on the top and the configuration setting for F-01 on the bottom.

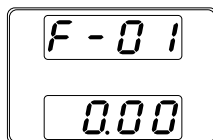

3. Rotate the Voltage knob to change the F setting.

Range F-00~ F-61, F-88~F-89

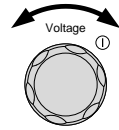

4. Use the Current knob to set the parameter for the chosen F setting.

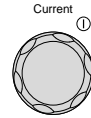

5. Press the Voltage knob to save the configuration setting. ConF will be displayed when successful.

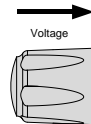

Exit

Press the Function key again to exit the configuration settings. The function key light will turn off.



## Setting Power On Configuration Settings

**Background** The Power On configuration settings can only be changed during power up to prevent the configuration settings being inadvertently changed.

- Ensure the load is not connected.
- Ensure the power supply is off.

**Steps**

1. Hold the Function key whilst turning the power on.
2. The display will show F-90 on the top and the configuration setting for F-90 on the bottom.

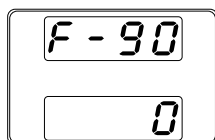
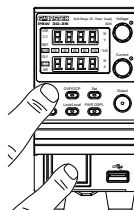

3. Rotate the Voltage knob to change the F setting.

F-90~ F-95

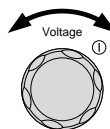

4. Use the Current knob to set the parameter for the chosen F setting.



5. Press the Voltage knob to save the configuration setting. ConF will be displayed when successful.

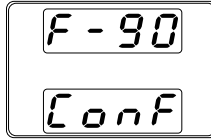
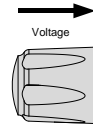

---

Exit

Cycle the power to save and exit the configuration settings.

# A ANALOG CONTROL

The Analog Control chapter describes how to control the voltage or current output using an external voltage or resistance, monitor the voltage or current output as well as remotely turning off the output or shutting down the power supply.

---

<b>Analog Remote Control Overview .....</b>	<b>121</b>
Analog Control Connector Overview .....	121
External Voltage Control of Voltage Output .....	123
External Voltage Control of Current Output .....	126
External Resistance Control of Voltage Output .....	128
External Resistance Control of Current Output .....	130
External Control of Output .....	132
External control of Shutdown .....	135
<b>Remote Monitoring.....</b>	<b>137</b>
External Voltage and Current Monitoring .....	137
External Operation and Status Monitoring.....	139



## Analog Remote Control Overview

The PSW power supply series have a number of analog control options. The Analog Control connectors are used to control output voltage and current using external voltage or resistance. The power supply output and power switch can also be controlled using external switches.

- Analog Control connector overview → from page 121
- External voltage control of voltage output → from page 123
- External voltage control of current output → from page 126
- External resistance control of voltage output → from page 128
- External resistance control of current output → from page 130
- External control of output → from page 132
- External control of the power switch → from page 135

## Analog Control Connector Overview

Overview	The Analog Control Connector is a standard Mil 26 pin connector (OMRON XG4 IDC plug). The connector is used for all analog remote control. The pins used determine what remote control mode is used.
----------	--



**WARNING**

To prevent electric shock, ensure that the cover for the Analog Control Connector is used when the connector is not in use.

Pin Assignment

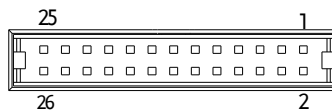

Pin name	Pin number	Description
Current Share	1	Used when operating 2 or more units in parallel.
D COM	2	Connected to the (-S) sense- terminal when remote sense is used. Connected to the negative output terminal when remote sense is not used.
CURRENT SUM OUT	3	Current sum output signal when used in parallel mode.
EXT-V CV CONT	4	External voltage control of the voltage output. A voltage of 0~10V is used to control the full scale voltage output (0%~100%) of the instrument.
EXT-V CC CONT	5	External voltage control of the current output. A voltage of 0~10V is used to control the full scale current output (0%~100%) of the instrument
EXT-R CV CONT PIN1	6	External resistance control of the voltage output. A resistance of 0k $\Omega$ ~ 10k $\Omega$ is used to control the full scale voltage output (0%~100%) of the instrument.
EXT-R CV CONT PIN2	7	External resistance control of the voltage output. A resistance of 0k $\Omega$ ~ 10k $\Omega$ is used to control the full scale voltage output (0%~100%) of the instrument.
EXT-R CC CONT PIN1	8	External resistance control of the current output. A resistance of 0k $\Omega$ ~ 10k $\Omega$ is used to control the full scale current output (0%~100%) of the instrument.
EXT-R CC CONT PIN2	9	External resistance control of the current output. A resistance of 0k $\Omega$ ~ 10k $\Omega$ is used to control the full scale current output (0%~100%) of the instrument.
V MON	10	Voltage Monitor Output. Outputs the full scale voltage (0~100%) as a voltage (0V~10V).
I MON	11	Current Monitor Output. Outputs the full scale current (0~100%) as a voltage (0V~10V).
SHUTDOWN	12	The shut down signal will turn off the output or power when a low TTL signal is applied. The shutdown signal is pulled up to 5V with a 10k $\Omega$ pull-up resistor.
CURRENT_SUM_1	13	Master unit current sum input signal from first slave CURRENT SUM OUTPUT. Used in parallel mode only.

CURRENT_SUM_2	14	Master unit current sum input signal from second slave CURRENT SUM OUTPUT. Used in parallel mode only.
FEEDBACK	15	Parallel control signal during master-slave parallel operation.
A COM	16	Analog signal common. Connected to the sense-terminal when remote sense is used. Connected to the negative output terminal when remote sense is not used.
STATUS COM	17	Common for status signals 18, 19, 20, 21 and 22.
CV STATUS	18	Turns on when CV mode is active. (photo coupled open collector output)
CC STATUS	19	Turns on when CC mode is active. (photo coupled open collector output)
ALM STATUS	20	Turns on when any of the protection modes are tripped (OVP, OCP) or if a shutdown signal is input. (photo coupled open collector output)
OUTPUT ON STATUS	21	Turns on when the output has been turned on. (photo coupled open collector output)
POWER OFF STATUS	22	Turns on when the power switch is turned off.
N.C.	23	Not connected
OUT ON/OFF CONT	24	Turns the output on/off when (default setting) a low TTL signal is applied. Internally, the circuit is pulled up to +5V with 10kΩ resistance.
SER SLV IN	25	Series slave input during master-slave series operation. (30V/40V/80V/160V models only)
N.C.	26	Not connected

## External Voltage Control of Voltage Output

**Background** External voltage control of the voltage output is accomplished using the MIL-26 connector on the rear panel. A voltage of 0~10V is used to control the full scale voltage of the instrument, where:

$$\text{Output voltage} = \text{full scale voltage} \times (\text{external voltage}/10)$$

**Connection** When connecting the external voltage source to the MIL connectors, use shielded or twisted paired wiring.

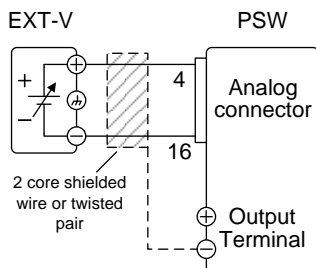

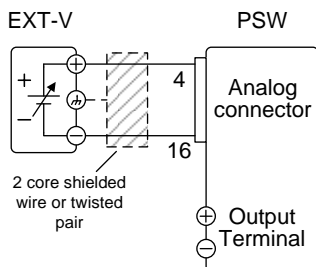

- Pin16 → EXT-V (-)
- Pin4 → EXT-V (+)
- Wire shield → negative (-) output terminal

**Connection- alt. shielding** If the wire shield needs to be grounded at the voltage source (EXT-V), then the shield cannot also be grounded at the negative (-) terminal output of the PSW power supply. This would short the output.



- Pin16 → EXT-V(-)
- Pin4 → EXT-V(+)
- Wire shield → EXT-V ground (GND)

**Panel operation** 1. Connect the external voltage according to the connection diagrams above.

2. Set the F-90 power on configuration setting to 1 (CV control – Ext voltage). Page 118
  - Be sure to cycle the power after the power on configuration has been set.
3. Press the Function key and confirm the new configuration settings (F-90=1). Function  

4. Press the Output key. The voltage can now be controlled with the External voltage. Output  



Note

The input impedance for external voltage control is 10k $\Omega$ .

Use a stable voltage supply for the external voltage control.



Note

CV and CC Slew Rate Priority are disabled for V-I mode (F-03) when using external voltage control. See the normal function settings on page 107.



CAUTION

Ensure no more than 10.5 volts are input into the external voltage input.

Ensure the voltage polarity is correct when connecting the external voltage.

## External Voltage Control of Current Output

**Background** External voltage control of the current output is accomplished using the MIL-26 connector on the rear panel. A voltage of 0~10V is used to control the full scale current of the instrument, where:

$$\text{Output current} = \text{full scale current} \times (\text{external voltage}/10)$$

**Connection** When connecting the external voltage source to the MIL connectors, use shielded or twisted paired wiring.

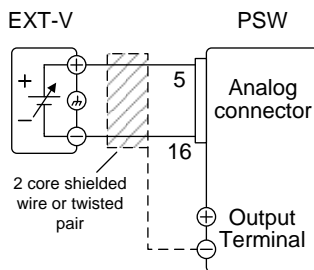

- Pin16 → EXT-V (-)
- Pin5 → EXT-V (+)
- Wire shield → negative (-) output terminal

Connection- alt. shielding If the wire shield needs to be grounded at the voltage source (EXT-V), then the shield cannot also be grounded at the negative (-) terminal output of the PSW power supply. This would short the output.

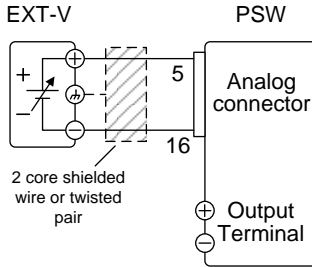

- Pin16 → EXT-V (-)
- Pin5 → EXT-V (+)
- Wire shield → EXT-V ground (GND)

- Steps
1. Connect the external voltage according to the connection diagrams above.
  2. Set the F-91 power on configuration setting to 1 (CC control - Ext voltage). Page 118
    - Be sure to cycle the power after the power on configuration has been set.
  3. Press the Function key and confirm the new configuration settings (F-91=1). Function
  4. Press the Output key. The current can now be controlled with the External voltage. Output

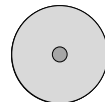



Note

The input impedance for external voltage control is 10k $\Omega$ .

Use a stable voltage supply for the external voltage control.



Note

CV and CC Slew Rate Priority are disabled for V-I mode (F-03) when using external voltage control. See the normal function settings on page 107.



CAUTION

Ensure the voltage polarity is correct when connecting the external voltage.

Ensure no more than 10.5 volts are input into the external voltage input.

## External Resistance Control of Voltage Output

---

### Background

External resistance control of the voltage output is accomplished using the MIL-26 connector on the rear panel. A resistance of 0k $\Omega$ ~10k $\Omega$  is used to control the full scale voltage of the instrument.

The output voltage (0 to full scale) can be controlled with the external resistance going up (Ext-R  $\swarrow$ ) 0k $\Omega$ ~10k $\Omega$  (10k $\Omega$  =  $V_{o,max}$ ) or down (Ext-R  $\searrow$ ) 10k $\Omega$ ~0k $\Omega$  (10k $\Omega$  = 0).

For 0k $\Omega$ ~10k $\Omega$ : Output voltage = full scale voltage  $\times$  (external resistance/10)

For 10k $\Omega$ ~0k $\Omega$ : Output voltage = full scale voltage  $\times$  ([10-external resistance]/10)

---





Note

The Ext-R $\nabla$  configuration is recommended for safety reasons. In the event that the cables become accidentally disconnected, the voltage output will drop to zero. Under similar circumstances using Ext-R $\sphericalangle$ , an unexpected high voltage would be output.

If switches are used to switch between fixed resistances, use switches that avoid creating open circuits. Use short-circuit or continuous resistance switches.

Connection

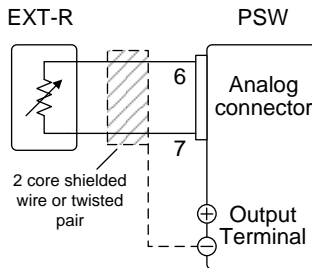

- Pin6 → EXT-R
- Pin7 → EXT-R
- Wire shield → negative (-) output terminal

Steps

1. Connect the external resistance according to the connection diagrams above.
2. Set the F-90 (CV Control) configuration settings to 2 for Ext-R $\sphericalangle$  or 3 for Ext-R $\nabla$ . Page 118
- Be sure to cycle the power after the power on configuration has been set.
3. Press the Function key and confirm the new configuration settings (F-90=2 or 3).



4. Press the Output key. The voltage can now be controlled with the External resistance.

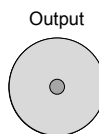

Note

Ensure the resistor(s) and cables used exceed the isolation voltage of the power supply. For example: insulation tubes with a withstand voltage higher than the power supply can be used.

When choosing an external resistor ensure the resistor can withstand a high degree of heat.



Note

CV and CC Slew Rate Priority are disabled for V-I mode (F-03) when using external resistance control. See the normal function settings on page 107.

## External Resistance Control of Current Output

### Background

External resistance control of the current output is accomplished using the MIL-26 connector on the rear panel. A resistance of  $0\text{k}\Omega\sim 10\text{k}\Omega$  is used to control the full scale current of the instrument.

The output current (0 to full scale) can be controlled with the external resistance going up (Ext-R  $\swarrow$ )  $0\text{k}\Omega\sim 10\text{k}\Omega$  ( $10\text{k}\Omega = V_{o,max}$ ) or down (Ext-R  $\searrow$ )  $10\text{k}\Omega\sim 0\text{k}\Omega$  ( $10\text{k}\Omega = 0$ ).

For  $0\text{k}\Omega\sim 10\text{k}\Omega$ : Output current = full scale current  $\times$  (external resistance/10)

For  $10\text{k}\Omega\sim 0\text{k}\Omega$ : Output current = full scale current  $\times$  ([10-external resistance]/10)



Note

The Ext- $R_{\nabla}$  configuration is recommended for safety reasons. In the event that the cables become accidentally disconnected, the current output will drop to zero. Under similar circumstances using Ext- $R_{\sphericalangle}$ , an unexpected high current would be output.

If switches are used to switch between fixed resistances, use switches that avoid creating open circuits. Use short-circuit or continuous resistance switches.

Connection

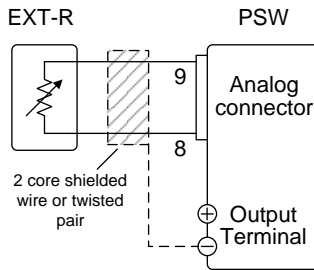

- Pin9 → EXT-R
- Pin8 → EXT-R
- Wire shield → negative (-) output terminal

Steps

1. Connect the external resistance according to the connection diagrams above.

1. Set the F-91 (CC Control) configuration settings to 2 for Ext- $R_{\sphericalangle}$  or 3 for Ext- $R_{\nabla}$ . Page 118

- Be sure to cycle the power after the power on configuration has been set.

2. Press the Function key and confirm the new configuration settings (F-91=2 or 3).

Function



3. Press the Output key. The current can now be controlled with the External resistance.

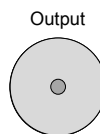

Ensure the resistor(s) and cables used exceed the isolation voltage of the power supply. For example: insulation tubes with a withstand voltage higher than the power supply can be used.

When choosing an external resistor ensure the resistor can withstand a high degree of heat.



CV and CC Slew Rate Priority are disabled for V-I mode (F-03) when using external resistance control. See the normal function settings on page 107.

## External Control of Output

---

### Background

The output can be turned on or off externally using a switch. The analog control connector can be set to turn the output on from a high or low signal. The voltage across pins 2 and 24 are internally pulled to +5V  $\pm 5\%$  @ 500uA with 10k $\Omega$  pull-up resistor. A short (closed switch) produces a low signal.

When set to High = On, the output is turned on when the pins 2-24 are open.

When Low = On, the output is turned on when pins 2-24 are shorted.

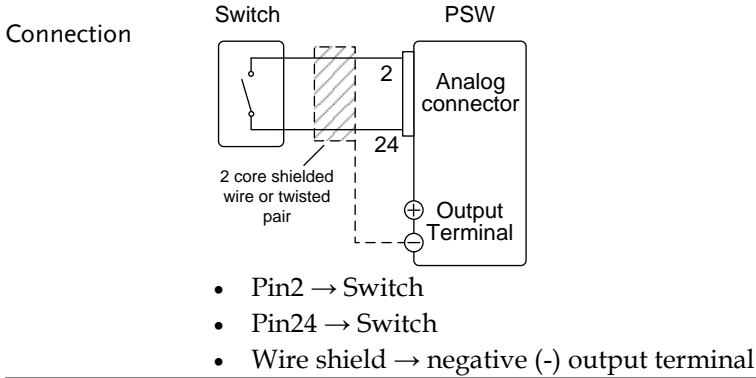

- Steps
1. Connect the external switch according to the connection diagrams above.
 

Set F-94 (External output logic) in Page 118 the power on configuration settings to 0 (High = On) or 1 (Low = On).

    - Be sure to cycle the power after setting the power on configuration settings.
  2. Press the Function key and confirm the new configuration settings.
 

Function
  3. The switch is now ready to set the output on or off.



Note

When using a switch over long distances, please use a switch relay to extend the line from the coil side of the relay.

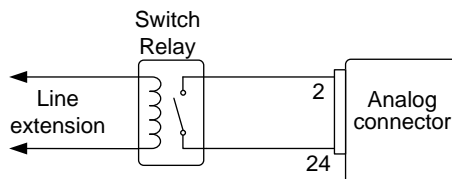

If a single switch control is to be used for multiple units, please isolate each instrument. This can be achieved by using a relay.



Warning

Ensure the cables used and the switch exceed the isolation voltage of the power supply. For example: insulation tubes with a withstand voltage higher than the power supply can be used.



Note

Messages: If F-94 = 0 (High = on) and the pin 24 is low (0) "MSG 001" will be displayed on the display.

If F-94 = 1 (Low = on) and the pin 24 is high (1) "MSG 002" will be displayed on the display.

Output off (High=on)

Output off (Low=on)



## External control of Shutdown

**Background**      The output of the power supplies can be configured to shut down via an external switch. The ability to externally shut down the power supply must first be enabled in the power on configuration settings. The voltage across pins 2 and 12 are internally pulled to +5V  $\pm$ 5% @ 500uA with 10k $\Omega$  pull-up resistor.

**Connection**

Switch      PSW

2 core shielded wire or twisted pair

2      12

Analog connector

Output Terminal

- Pin2 → Switch
- Pin12 → Switch
- Wire shield → negative (-) output terminal

- Steps**
1. Connect the external switches according to the connection diagrams above.
  2. Set F-95 to in the configuration settings to 0 (Enable). This will allow the external control of shutdown. Page 118
  3. Press the function key and confirm the new configuration settings. Function 
  4. The switch will now shut down the power supply when shorted.

**Note**

When using a switch over long distances, please use a switch relay to extend the line from the coil side of the relay.

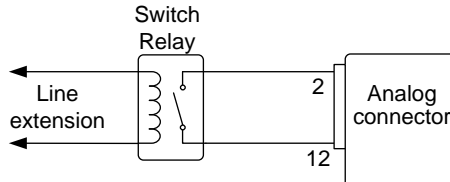

If a single switch control is to be used for multiple units, please isolate each instrument. This can be achieved by using a relay.

---

**Warning**

Ensure the cables and switch used exceed the isolation voltage of the power supply. For example: insulation tubes with a withstand voltage higher than the power supply can be used.



## Remote Monitoring

The PSW power supplies have remote monitoring support for current and voltage output. They also support monitoring of operation and alarm status.

- External monitoring of output voltage and current → from page 137
- External monitoring of operation mode and alarm status → from page 139

### External Voltage and Current Monitoring

#### Background

The MIL 26 pin connector is used to monitor the current (IMON) or voltage (VMON) output.

An output of 0~10V represents the voltage or current output of 0~ rated current/voltage output.

- $IMON = (\text{current output}/\text{full scale}) \times 10$
- $VMON = (\text{voltage output}/\text{full scale}) \times 10$

External voltage and current monitoring doesn't need to be enabled in the configuration settings.

#### VMON Connection

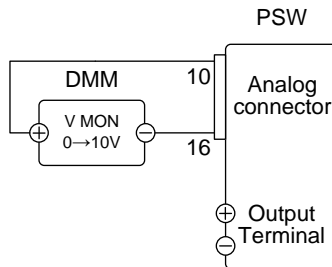

- Pin16 → Neg (-)
- Pin10 → Pos (+)

**IMON  
Connection**

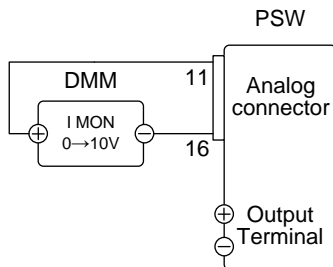

- Pin16 → Neg (-)
- Pin11 → Pos (+)



**Note**

The output impedance of the voltage (VMON) and current (IMON) monitor pins is 1kΩ.

Maximum current is 10mA.

The monitor outputs are strictly DC and should not be used to monitor analog components such as transient voltage response or ripple etc.



**CAUTION**

Ensure IMON (pin 11) and VMON (pin 10) are not shorted together. This will cause damage to the unit.

## External Operation and Status Monitoring

**Background** The MIL 26 pin connector can also be used to monitor the status operation and alarm status of the instrument.

The pins are isolated from the power supply internal circuitry by photo couplers. Status Com (Pin 17) is a photo coupler emitter output, whilst pins 18~22 are photo coupler collector outputs.

A maximum of 30V and 8mA can be applied to each pin.

Name and Pin	Description
STATUS COM 17	Common (photo coupler emitter) for status signals 18, 19, 20, 21 and 22.
CV STATUS 18	Low when CV mode is active.
CC STATUS 19	Low when CC mode is active.
ALM STATUS 20	Low when any of the protection modes are tripped (OVP, OCP). Active low.
OUT ON STATUS 21	Low when the output is on.
PWR OFF STATUS 22	Active low.

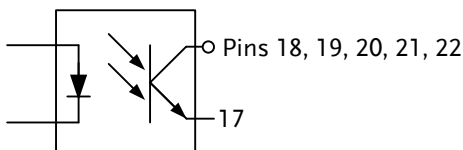

**Timing diagrams** Below are 4 example timing diagrams covering a number of scenarios. Note that pins 18~22 are all active low.

**CV MODE:** The diagram below shows the timing diagram  
 Output turned on when the output is turned on when the PSW is set to CV mode.

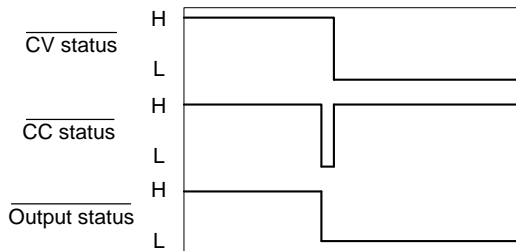

**CV MODE:** The diagram below shows the output status lines  
 Output turned off when the output is turned off in CV mode.

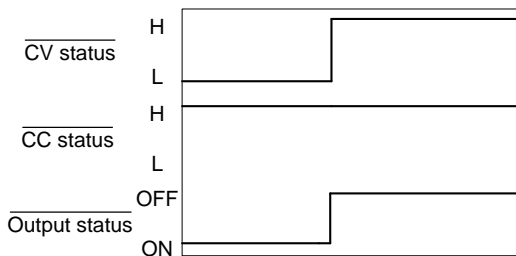

**CC MODE:** The diagram below shows the timing diagram  
 Output turned on when the output is turned on when the PSW is set to CC mode.

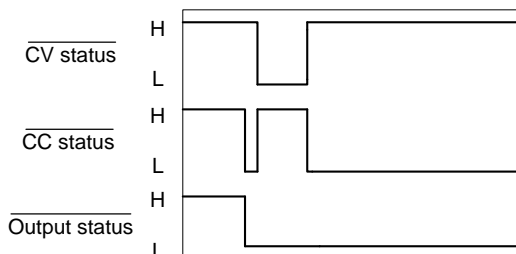

CC MODE:            The diagram below shows the output status lines  
Output turned off when the output is turned off in CC mode.

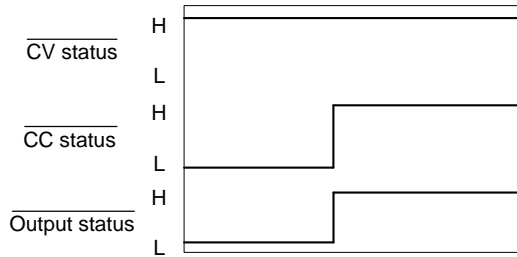

# C**OMMUNICATION**

## **INTERFACE**

This chapter describes basic configuration of IEEE488.2 based remote control. For a command list, refer to the programming manual, downloadable from GW Instek website, [www.gwinstek.com](http://www.gwinstek.com)

---

Interface Configuration .....	143
USB Remote Interface .....	143
Configure GPIB Interface .....	143
Configure Ethernet Connection .....	145
Web Server Configuration .....	145
Sockets Server Configuration .....	146
USB Remote Control Function Check .....	147
Using Realterm to Establish a Remote Connection .....	148
Web Server Remote Control Function Check .....	152
Socket Server Function Check .....	152

## Interface Configuration

### USB Remote Interface

USB configuration	PC side connector	Type A, host
	PSW side connector	Rear panel Type B, slave
	Speed	1.1/2.0 (full speed/high speed)
	USB Class	CDC (communications device class)

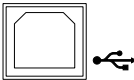
- Steps
1. Connect the USB cable to the rear panel USB B port. 
  2. Change the Rear panel-USB (F-22) Page 116 setting to USB-CDC (2).

### Configure GPIB Interface

To use GPIB, the optional GPIB to USB (GUG-001) adapter must be used. Only one GPIB address can be used at a time.

- Configure GPIB
1. Ensure the PSW is off before proceeding.
  2. Connect the USB cable from the rear panel USB B port on the PSW to the USB A port on the GPIB to USB adapter.
  3. Connect a GPIB cable from a GPIB controller to the GPIB port on the adapter.

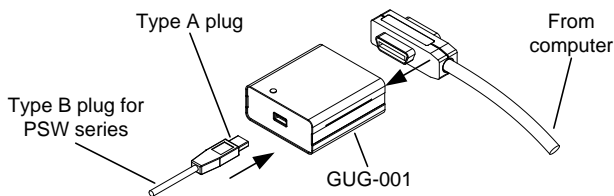

4. Turn the PSW on.
5. Press the Function key to enter the Page 116 Normal configuration settings.

Set the following GPIB settings

F-22 = 1                      Set the rear panel USB port to USB Host.

F-23 = 0~30                 Set the GPIB address (0~30)

GPIB constraints

- Maximum 15 devices altogether, 20m cable length, 2m between each device
- Unique address assigned to each device
- At least 2/3 of the devices turned On
- No loop or parallel connection



## Configure Ethernet Connection

The Ethernet interface can be configured for a number of different applications. Ethernet can be configured for basic remote control or monitoring using a web server or it can be configured as a socket server.

The PSW series supports both DHCP connections so the instrument can be automatically connected to an existing network or alternatively, network settings can be manually configured.

Ethernet configuration Parameters For details on how to configure the Ethernet settings, please see the configuration chapter on page 112.

MAC Address (display only)	LAN
DHCP	IP Address
Subnet Mask	Gateway
DNS Address	Sockets Active
Web Server Active	Web Password Active
Web set password	0000~9999 (default 0000)

## Web Server Configuration

Configuration This configuration example will configure the PSW as a web server and use DHCP to automatically assign an IP address to the PSW.

1. Connect an Ethernet cable from the network to the rear panel Ethernet port.

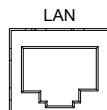

2. Press the Function key to enter the Normal configuration settings.

Page 116

Set the following LAN settings:

- |          |                        |
|----------|------------------------|
| F-36 = 1 | Enable LAN             |
| F-37 = 1 | Turn DHCP to enable    |
| F-59 = 1 | Turn the web server on |



Note

It may be necessary to cycle the power or refresh the web browser to connect to a network.

## Sockets Server Configuration

**Configuration** This configuration example will configure the PSW socket server.

The following configuration settings will manually assign the PSW an IP address and enable the socket server. By default, the socket server port number is 2268 and cannot be configured.

1. Connect an Ethernet cable from the network to the rear panel Ethernet port.

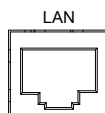

2. Press the Function key to enter the Normal configuration settings. Page 116

Set the following LAN settings:

- |            |                         |
|------------|-------------------------|
| F-36 = 1   | Enable LAN              |
| F-37 = 0   | Disable DHCP            |
| F-39 = 172 | IP Address part 1 of 4  |
| F-40 = 16  | IP Address part 2 of 4  |
| F-41 = 5   | IP Address part 3 of 4  |
| F-42 = 133 | IP Address part 4 of 4  |
| F-43 = 255 | Subnet Mask part 1 of 4 |
| F-44 = 255 | Subnet Mask part 2 of 4 |
| F-45 = 128 | Subnet Mask part 3 of 4 |
| F-46 = 0   | Subnet Mask part 4 of 4 |
| F-47 = 172 | Gateway part 1 of 4     |

---

F-48 = 16	Gateway part 2 of 4
F-49 = 21	Gateway part 3 of 4
F-50 = 101	Gateway part 4 of 4
F-51 = 172	DNS Address 1 of 4
F-52 = 16	DNS Address 2 of 4
F-53 = 1	DNS Address 3 of 4
F-54 = 252	DNS Address 4 of 4
F-57 = 1	Enable Sockets

---



Note

The socket function is only available for firmware version V1.12 or above. See page 114 to check your firmware version number.

## USB Remote Control Function Check

---

Functionality  
check

Invoke a terminal application such as Realterm. The PSW will appear as a COM port on the PC.

To check the COM port No, see the Device Manager in the PC. For WinXP; Control panel → System → Hardware tab.

---



Note

If you are not familiar with using a terminal application to send/receive remote commands via a USB connection, please page 148 (Using Realterm to Establish a Remote Connection) for more information.

---

Run this query command via the terminal after the instrument has been configured for USB remote control (page 143).

```
*idn?
```

This should return the Manufacturer, Model number, Serial number, and Firmware version in the following format.

---

GW-INSTEK,PSW-XXX-X,TW123456,01.00.  
20110101

Manufacturer: GW-INSTEK

Model number : PSW-XXX-X

Serial number : TW123456

Firmware version : 01.00.20110101

---



Note

For further details, please see the programming manual, available on the GW Instek web site @ [www.gwinstek.com](http://www.gwinstek.com).

---

## Using Realterm to Establish a Remote Connection

---

### Background

Realterm is a terminal program that can be used to communicate with a device attached to the serial port of a PC or via an emulated serial port via USB.

The following instructions apply to version 2.0.0.70. Even though Realterm is used as an example to establish a remote connection, any terminal program can be used that has similar functionality.

---



Note

Realterm can be downloaded on Sourceforge.net free of charge.

For more information please see <http://realterm.sourceforge.net/>

---

### Operation

1. Download Realterm and install according to the instructions on the Realterm website.
2. Connect the PSW via USB (page 143).

3. Go to the Windows device manager and find the COM port number for the connection. For example, go to the Start menu > Control Panel > Device Manager

Double click the *Ports* icon to reveal the connected serial port devices and the COM port for the each connected device.

The baud rate, stop bit and parity settings can be viewed for the virtual COM port by right-clicking connected device and selecting the *Properties* option.

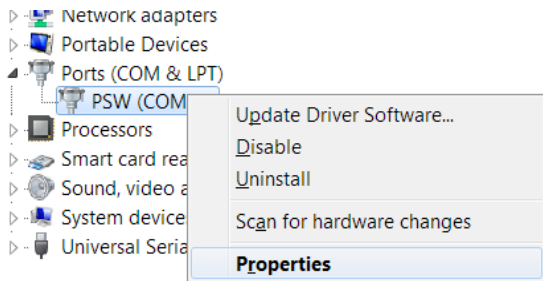

4. Start Realterm on the PC as an administrator. Click:  
Start menu>All Programs>RealTerm>realterm

Tip: to run as an administrator, you can right click the Realterm icon in the Windows Start menu and select the *Run as Administrator* option.

5. After Realterm has started, click on the *Port* tab.

Enter the *Baud*, *Parity*, *Data bits*, *Stop bits* and *Port* number configuration for the connection.

The *Hardware Flow Control*, *Software Flow Control* options can be left at the default settings.

Press *Open* to connect to the PSW.

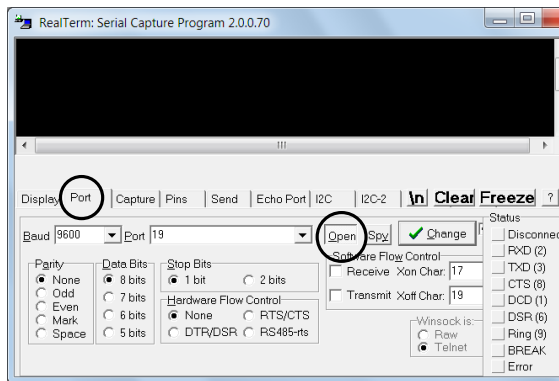

- Click on the *Send* tab.

In the *EOL* configuration, check on the *+CR* and *+LF* check boxes.

Enter the query:

*\*idn?*

Click on *Send ASCII*.

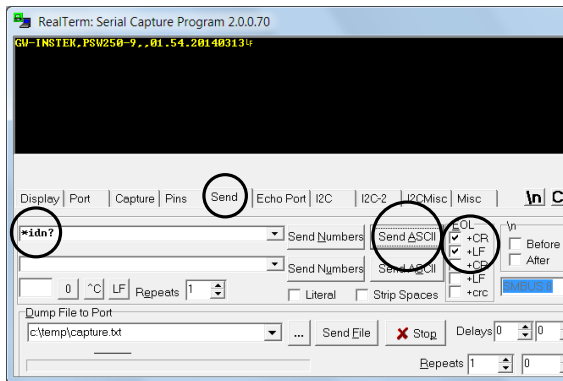

- The terminal display will return the following:

```
GW-INSTEK,PSW-XXX-X,TW123456,01.00.20110101
```

(manufacturer, model, serial number, version)

- If Realterm fails to connect to the PSW, please check all the cables and settings and try again.

## Web Server Remote Control Function Check

---

Functionality check      Enter the IP address of the power supply in a web browser after the instrument has been configured as a web server (page 145).

http:// XXX.XXX.XXX.XXX

The web browser interface appears.

---



Note

For further details, please see the programming manual, available on the GW Instek web site @ [www.gwinstek.com](http://www.gwinstek.com).

## Socket Server Function Check

---

Background      To test the socket server functionality, National Instruments Measurement and Automation Explorer can be used. This program is available on the NI website, [www.ni.com](http://www.ni.com), via a search for the VISA Run-time Engine page, or “downloads” at the following URL, <http://www.ni.com/visa/>

---

Requirements      Firmware: V1.12  
Operating System: Windows XP, 7

---



Functionality  
check

1. Start the NI Measurement and Automation Explorer (MAX) program. Using Windows, press:

*Start>All Programs>National Instruments>Measurement & Automation*

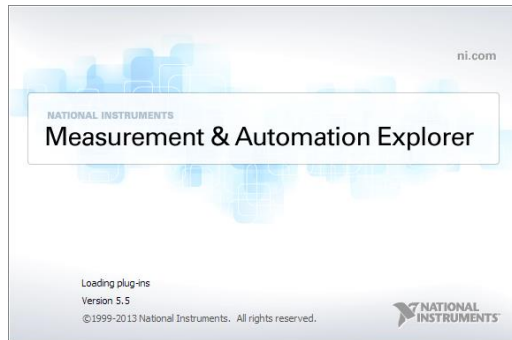

2. From the Configuration panel access;

*My System>Devices and Interfaces>Network Devices*

3. Click *Create New...*

4. Select *Visa TCP/IP Resource*.

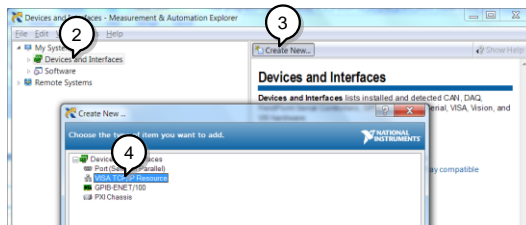

5. Select *Manual Entry of Raw Socket* from the popup window.
6. Click *Next*.

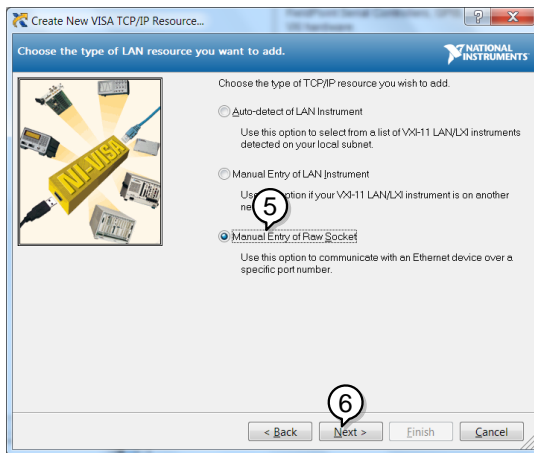

7. Enter the IP address and the port number of the PSW. The port number is fixed at 2268.
8. Click the Validate button. A popup box will appear when successful.
9. Click *Next*.

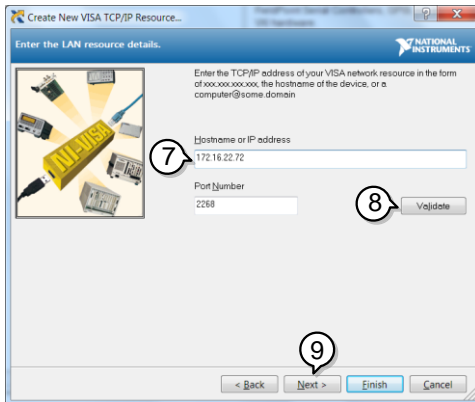

10. Next configure the Alias (name) of the PSW connection. In this example the Alias is: PSW\_DC1

11. Click finish.

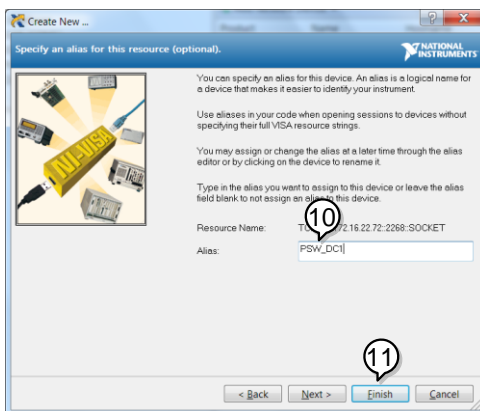

12. The IP address of the PSW will now appear under Network Devices in the configuration panel. Select this icon now.

13. Press *Open VISA Test Panel*.

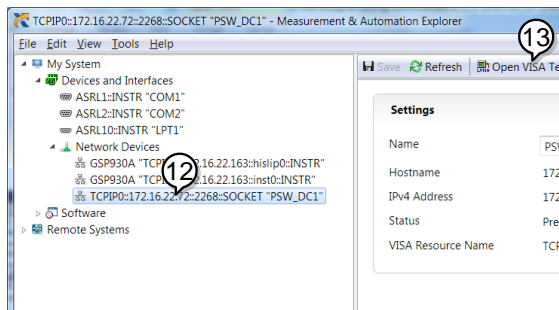

14. Click *Configuration* icon.

15. In the *I/O Settings* tab, select the *Enable Termination Character* check box. Ensure *Line Feed - \n* is selected as the line feed character.

16. Click *Apply Changes*.

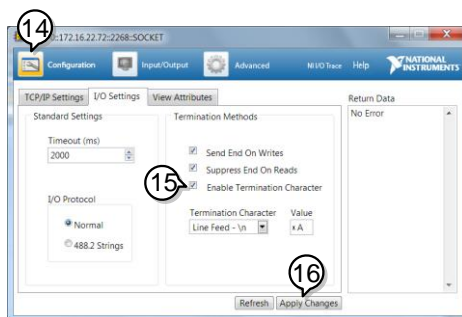

17. Click the *Input/Output* icon.

18. Ensure *\*IDN? \n* is selected in the *Select or Enter Command* dropdown text box.

19. Click the *Query* button.

20. The *\*IDN?* query should be returned to the buffer area:  
 GW-INSTEK,PSW250-9,,01.54.20140313\n

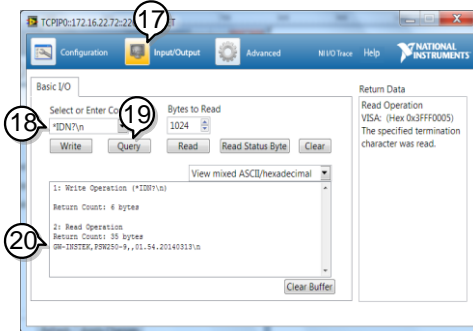

For further details, please see the programming manual, available on the GW Instek web site @ [www.gwinstek.com](http://www.gwinstek.com).

# **M** AINTENANCE

The PSW power supply filters should be replaced on a periodic schedule to maintain performance and specification characteristics.

---

Replacing the Dust Filter .....	159
---------------------------------	-----

## Replacing the Dust Filter

The dust filter should be replaced at least 2 times a year. Not replacing the filter on a regular basis will reduce performance and may cause the unit to overheat.

---

Front panel filter  
(all models)

1. Turn the instrument off.
2. Pull the filter out from the bottom of the front panel.

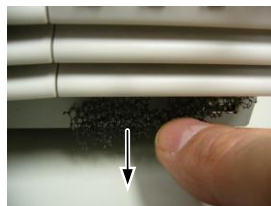

3. Replace the filter with GW Instek part number 57RG-30B001X1.
- 

Side panel filters  
(Type II & Type III)

1. Lift the side panel up and away from the case.

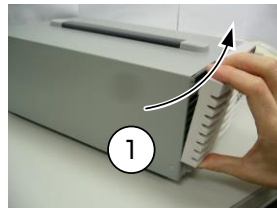

2. Remove the filter from the grill and replace with a new filter (GW Instek part number PSW-010).

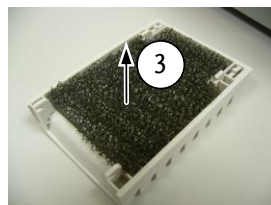

# FAQ

---

- The power supply won't let me change the mode (C.V. mode ↔ C.C. mode).
- The OVP voltage is triggered earlier than expected.
- Can I combine more than 1 cable together for the output wiring?
- The accuracy does not match the specification.

The power supply won't let me change the mode (C.V. mode ↔ C.C. mode).

---

To set the power supply to CC or CV mode, the Function key must be held when the power is turned on to enter the Power On Configuration Mode. See page 118.

The OVP voltage is triggered earlier than expected.

---

When setting the OVP voltage, take into account the voltage drop from the load cables. As the OVP level is set from the output terminals and not the load terminals, the voltage at the load terminals may be slightly lower.

Can I combine more than 1 cable together for the output wiring?

---

Yes. Cables can be used together (in parallel) if the current capacity of a single cable is insufficient. However the withstand voltage should also be taken into account. Ensure the cables are twisted together and are the same length.



The accuracy does not match the specification.

---

Make sure the device is powered On for at least 30 minutes, within +20°C~+30°C. This is necessary to stabilize the unit to match the specification.

For more information, contact your local dealer or GWInstek at [www.gwinstek.com](http://www.gwinstek.com) / [marketing@goodwill.com.tw](mailto:marketing@goodwill.com.tw).

# APPENDIX

PSW Default Settings .....	163
Error Messages & Messages .....	166
LED Display Format .....	166
PSW Specifications .....	167
PSW 360W .....	167
PSW 30-36, PSW 40-27, PSW 80-13.5, PSW 160-7.2, PSW 250-4.5, 800-1.44 .....	167
PSW 720W .....	172
PSW 30-72, PSW 40-54, PSW 80-27, PSW 160-14.4, PSW 250-9, 800-2.88 .....	172
PSW 1080W .....	177
PSW 30-108, PSW 40-81, PSW 80-40.5, PSW 160-21.6, PSW 250-13.5, 800-4.32 .....	177
PSW Dimensions .....	182
Type I .....	182
PSW 160-7.2/PSW 80-13.5/PSW 40-27/PSW 30-36 (scale: mm) .....	182
PSW 250-4.5/PSW 800-1.44 (scale: mm) .....	182
Type II .....	183
PSW 160-14.4/ .....	183
Type II .....	184
Type III .....	185
PSW 160-21.6/ .....	185
Type III .....	186
PSW 250-13.5/PSW 800-4.32 (scale: mm) .....	186
Certificate Of Compliance .....	187

## PSW Default Settings

The following default settings are the factory configuration settings for the power supply (Function settings/Test settings).

For details on how to return to the factory default settings, see page 58.

Initial Settings	Default Setting	
Output	Off	
LOCK	0 (Disabled)	
Voltage	0V	
Current	0A	
OVP	Maximum	
OCP	Maximum	
Normal Function Settings	Setting	Default Setting
Output ON delay time	F-01	0.00s
Output OFF delay time	F-02	0.00s
V-I mode slew rate select	F-03	0 = CV high speed priority
Rising voltage slew rate	F-04	60.00V/s (PSW 30-XX) 80.00V/s (PSW 40-XX) 160.0V/s (PSW 80-XX) 320.0V/s (PSW 160-XX) 500.0V/s (PSW 250-XX) 1600V/s (PSW 800-XX)
Falling voltage slew rate	F-05	60.00V/s (PSW 30-XX) 80.00V/s (PSW 40-XX) 160.0V/s (PSW 80-XX) 320.0V/s (PSW 160-XX) 500.0V/s (PSW 250-XX) 1600V/s (PSW 800-XX)

---

Rising current slew rate	F-06	72.00A/s (PSW 30-36)
		144.0A/s (PSW 30-72)
		216.0A/s (PSW 30-108)
		54.00A/s (PSW 40-27)
		108.0A/s (PSW 40-54)
		162.0A/s (PSW 40-81)
		27.00A/s (PSW 80-13.5)
		54.00A/s (PSW 80-27)
		81.00A/s (PSW 80-40.5)
		14.40A/s (PSW 160-7.2)
		28.80A/s (PSW 160-14.4)
		43.20A/s (PSW 160-21.6)
		9.000A/s (PSW 250-4.5)
		18.00A/s (PSW 250-9)
		27.00A/s (PSW 250-13.5)
		2.880A/s (PSW 800-1.44)
		5.760A/s (PSW 800-2.88)
8.640A/s (PSW 800-4.32)		
Falling current slew rate	F-07	72.00A/s (PSW 30-36)
		144.0A/s (PSW 30-72)
		216.0A/s (PSW 30-108)
		54.00A/s (PSW 40-27)
		108.0A/s (PSW 40-54)
		162.0A/s (PSW 40-81)
		27.00A/s (PSW 80-13.5)
		54.00A/s (PSW 80-27)
		81.00A/s (PSW 80-40.5)
		14.40A/s (PSW 160-7.2)
		28.80A/s (PSW 160-14.4)
		43.20A/s (PSW 160-21.6)
		9.000A/s (PSW 250-4.5)
		18.00A/s (PSW 250-9)
		27.00A/s (PSW 250-13.5)
		2.880A/s (PSW 800-1.44)
		5.760A/s (PSW 800-2.88)
8.640A/s (PSW 800-4.32)		
Internal resistance setting	F-08	0.000Ω
Bleeder circuit control	F-09	1 = ON
Buzzer ON/OFF control	F-10	1 = ON

---

Measurement Average Setting	F-17	0 = Low
Lock Mode	F-19	0 = Panel lock: allow output off
USB/GPIB setting		
Rear Panel USB Mode	F-22	2 = USB CDC
GPIB address	F-23	8
LAN setting		
LAN	F-36	1 = Enable
DHCP	F-37	1 = Enable
Sockets active	F-57	1 = Enable
Web Server active	F-59	1 = Enable
Web password active	F-60	1 = Enable
Web setting password	F-61	0000
Power On Configuration		
CV Control	F-90	0= Panel control (local)
CC Control	F-91	0= Panel control (local)
Power-ON Output	F-92	0 = OFF at startup
Master/Slave	F-93	0 = Master/Local
External Out Logic	F-94	0= High ON
Power Switch trip	F-95	0 = Enable

## Error Messages & Messages

The following error messages or messages may appear on the PSW screen during operation.

Error Messages	Description
Err 001	USB Mass Storage is not present
Err 002	No (such)file in USB mass storage
Err 003	Empty memory location
Err 004	File access error
 Note	For error messages other than Err 001 to Err 004, please contact your distributor for service repair.
Messages	Description
MSG 001	External control of output. Output off (F-94=0, High=on)
MSG 002	External control of output. Output off (F-94=1, Low=on)
MSG 003	F-93 is not zero. Unable to calibrate.
LOCK F-19	F-19 is zero. Unable to turn the output on.

## LED Display Format

Use the following table to read the LED display messages.

0	1	2	3	4	5	6	7	8	9	A	B	C	D
0	1	2	3	4	5	6	7	8	9	A	b	C	d
E	F	G	H	I	J	K	L	M	N	O	P	Q	R
E	F	G	H	I	J	K	L	M	N	O	P	Q	R
S	T	U	V	W	X	Y	Z	( )	+	-	,		
S	T	U	V	W	X	Y	Z	( )	+	-	,		

## PSW Specifications

The specifications apply when the PSW is powered on for at least 30 minutes.

### PSW 360W

PSW 30-36, PSW 40-27, PSW 80-13.5, PSW 160-7.2,  
PSW 250-4.5, 800-1.44

Model	Unit	PSW 30-36	PSW 40-27	PSW 80-13.5	PSW 160-7.2	PSW 250-4.5	PSW 800-1.44
Rated Output Voltage	V	30	40	80	160	250	800
Rated Output Current	A	36	27	13.5	7.2	4.5	1.44
Rated Output Power	W	360	360	360	360	360	360
Power Ratio	--	3	3	3	3.2	3.125	3.2
<b>Constant Voltage Mode</b>							
Line Regulation* <sup>1</sup>	mV	18	23	43	83	128	403
Load Regulation* <sup>2</sup>	mV	20	25	45	85	130	405
<b>Ripple and Noise*<sup>3</sup></b>							
p-p* <sup>4</sup>	mV	60	60	60	60	80	150
r.m.s.* <sup>5</sup>	mV	7	7	7	12	15	30
Temperature coefficient	ppm/°C	100ppm/°C of rated output voltage, after a 30 minute warm-up.					
Remote sense compensation voltage (single wire)	V	0.6	0.6	0.6	0.6	1	1
<b>Rise Time*<sup>6</sup></b>							
Rated Load	ms	50	50	50	100	100	150
No Load	ms	50	50	50	100	100	150
<b>Fall Time*<sup>7</sup></b>							
Rated Load	ms	50	50	50	100	150	300
No Load	ms	500	500	500	1000	1200	2000
Transient response time* <sup>8</sup>	ms	1	1	1	2	2	2
<b>Constant Current Mode</b>							
Line regulation* <sup>1</sup>	mA	41	32	18.5	12.2	9.5	6.44
Load regulation* <sup>9</sup>	mA	41	32	18.5	12.2	9.5	6.44
<b>Ripple and noise</b>							
r.m.s.* <sup>5</sup>	mA	72	54	27	15	10	5

Temperature coefficient	ppm 200ppm/°C of rated output current, after a 30 /°C minute warm-up.						
<b>Protection Function</b>							
<b>Over voltage protection (OVP)</b>							
Setting range	V	3-33	4-44	8-88	16-176	20-275	20-880
Setting accuracy	± (2% of rated output voltage)						
<b>Over current protection (OCP)</b>							
Setting range	A	3.6-39.6	2.7-29.7	1.35-14.85	0.72-7.92	0.45-4.95	0.144-1.584
Setting accuracy	± (2% of rated output current)						
<b>Overheat(Over temperature) protection (OHP (OTP))</b>							
Operation	Turn the output off.						
<b>Low AC input protection (AC-FAIL)</b>							
Operation	Turn the output off.						
<b>Power limit (POWER LIMIT)</b>							
Operation	Over power limit.						
Value (fixed)	Approx. 105% of rated output power						
<b>Analog Programming and Monitoring</b>							
External voltage control output voltage	Accuracy and linearity: ±0.5% of rated output voltage.						
External voltage control output current	Accuracy and linearity: ±1% of rated output current.						
External resistor control output voltage	Accuracy and linearity: ±1.5% of rated output voltage.						
External resistor control output current	Accuracy and linearity: ±1.5% of rated output current.						
<b>Output voltage monitor</b>							
Accuracy	%	±1	±1	±1	±1	±2	±2
<b>Output current monitor</b>							
Accuracy	%	±1	±1	±1	±1	±2	±2
Shutdown control	Turns the output or power off with a LOW (0V to 0.5V) or short-circuit.						
Output on/off control	Possible logic selections: Turn the output on using a LOW (0V to 0.5V) or short-circuit, turn the output off using a HIGH (4.5V to 5V) or open-circuit. Turn the output on using a HIGH (4.5V to 5V) or open-circuit, turn the output off using a LOW (0V to 0.5V) or short-circuit.						
CV/CC/ALM/PWR ON/OUT ON indicator	Photocoupler open collector output; Maximum voltage 30V, maximum sink current 8mA.						



<b>Front Panel</b>						
Display, 4 digits						
Voltage accuracy 0.1% +	mV	20	20	20	100	200 400
Current accuracy 0.1% +	mA	40	30	20	5	5 2
Indications	GREEN LED's: CV, CC, VSR, ISR, DLY, RMT, 20, 40, 60, 80, 100, %W, W, V, A RED LED's: ALM					
Buttons	Function, OVP/OCP, Set, Test, Lock/Local, PWR DSPL, Output					
Knobs	Voltage, Current					
USB port	Type A USB connector					
<b>Programming and Measurement (USB, LAN, GPIB)</b>						
Output voltage programming accuracy 0.1% +	mV	10	10	10	100	200 400
Output current programming accuracy 0.1% +	mA	30	20	10	5	5 2
Output voltage programming resolution	mV	1	1	2	3	5 14
Output current programming resolution	mA	1	1	1	1	1 1
Output voltage measurement accuracy 0.1% +	mV	10	10	10	100	200 400
Output current measurement accuracy 0.1% +	mA	30	20	10	5	5 2
Output voltage measurement resolution	mV	1	1	2	3	5 14
Output current measurement resolution	mA	1	1	1	1	1 1
<b>Series and Parallel Capability</b>						
Parallel number	Units	3	3	3	3	3 3
Series Number	Units	2	2	2	2	None None
<b>Input Characteristics</b>						
Nominal input rating	100Vac to 240Vac, 50Hz to 60Hz, single phase					
Input voltage range	85Vac ~ 265Vac					
Input voltage range	47Hz ~ 63Hz					
Maximum input current						
100Vac	A	5				
200Vac	A	2.5				
Inrush current	Less than 25A.					
Maximum input power	VA	500				
Power factor						
100Vac	0.99					
200Vac	0.97					

<b>Efficiency</b>							
100Vac	%	77	78	78	79	79	80
200Vac	%	79	80	80	81	81	82
Hold-up time	20ms or greater						
<b>Interface Capabilities</b>							
USB	TypeA: Host, TypeB: Slave, Speed: 1.1/2.0, USB Class: CDC(Communications Device Class)						
LAN	MAC Address, DNS IP Address, User Password, Gateway IP Address, Instrument IP Address, Subnet Mask						
GPIB	Optional: GUG-001 (GPIB to USB Adapter)						
<b>Environmental Conditions</b>							
Operating temperature	0°C to 50°C						
Storage temperature	-25°C to 70°C						
Operating humidity	20% to 85% RH; No condensation						
Storage humidity	90% RH or less; No condensation						
Altitude	Maximum 2000m						
<b>General Specifications</b>							
Weight (main unit only)	kg	Approx. 3kg					
Dimensions (W x H x D)	mm	71 x 124 x 350					
Cooling	Forced air cooling by internal fan.						
EMC	Complies with the European EMC directive for Class A test and measurement products.						
Safety	Complies with the European Low Voltage Directive and carries the CE-marking.						
Withstand voltage	Between input and chassis: No abnormalities at 1500 Vac for 1 minute. Between input and output: No abnormalities at 3000 Vac for 1 minute. Between output and chassis: No abnormalities at 500 Vdc for 1 minute for 30V, 40, 80V, 160V models. No abnormalities at 1500 Vdc for 1 minute for 250V, 800V models.						
Insulation resistance	Between input and chassis: 500 Vdc, 100MΩ or more Between input and output: 500 Vdc, 100MΩ or more Between output and chassis: 500 Vdc, 100MΩ or more for 30V, 40V, 80V, 160V and 250V models. 1000Vdc, 100MΩ or more for 800V models.						

\*1 At 85 ~ 132Vac or 170 ~ 265Vac, constant load.

- \*2 From No-load to Full-load, constant input voltage. Measured at the sensing point in Remote Sense.
  - \*3 Measure with JEITA RC-9131B (1:1) probe
  - \*4 Measurement frequency bandwidth is 10Hz to 20MHz.
  - \*5 Measurement frequency bandwidth is 5Hz to 1MHz.
  - \*6 From 10% to 90% of rated output voltage, with rated resistive load.
  - \*7 From 90% to 10% of rated output voltage, with rated resistive load.
  - \*8 Time for output voltage to recover within 0.1% + 10mV of its rated output for a load change from 50 to 100% of its rated output current.
  - \*9 For load voltage change, equal to the unit voltage rating, constant input voltage.
-

**PSW 720W**

**PSW 30-72, PSW 40-54, PSW 80-27, PSW 160-14.4,  
PSW 250-9, 800-2.88**

Model	Unit	PSW 30-72	PSW 40-54	PSW 80-27	PSW 160-14.4	PSW 250-9	PSW 800-2.88
Rated Output Voltage	V	30	40	80	160	250	800
Rated Output Current	A	72	54	27	14.4	9	2.88
Rated Output Power	W	720	720	720	720	720	720
Power Ratio	--	3	3	3	3.2	3.125	3.2
<b>Constant Voltage Mode</b>							
Line Regulation*1	mV	18	23	43	83	128	403
Load Regulation*2	mV	20	25	45	85	130	405
Ripple and Noise*3							
p-p*4	mV	80	80	80	80	100	200
r.m.s.*5	mV	11	11	11	15	15	30
Temperature coefficient	ppm /°C	100ppm/°C of rated output voltage, after a 30 minute warm-up.					
Remote sense compensation voltage (single wire)	V	0.6	0.6	0.6	0.6	1	1
Rise Time*6							
Rated Load	ms	50	50	50	100	100	150
No Load	ms	50	50	50	100	100	150
Fall Time*7							
Rated Load	ms	50	50	50	100	150	300
No Load	ms	500	500	500	1000	1200	2000
Transient response time*8	ms	1	1	1	2	2	2
<b>Constant Current Mode</b>							
Line regulation*1	mA	77	59	32	19.4	14	7.88
Load regulation*9	mA	77	59	32	19.4	14	7.88
Ripple and noise							
r.m.s.*5	mA	144	108	54	30	20	10
Temperature coefficient	ppm /°C	200ppm/°C of rated output current, after a 30 minute warm-up.					
<b>Protection Function</b>							
Over voltage protection (OVP)							
Setting range	V	3-33	4-44	8-88	16-176	20-275	20-880

Setting accuracy	± (2% of rated output voltage)						
Over current protection (OCP)							
Setting range	A	5-79.2	5-59.4	2.7-29.7	1.44-15.84	0.9-9.9	0.288-3.168
Setting accuracy	± (2% of rated output current)						
Overheat(Over temperature) protection (OHP (OTP))							
Operation	Turn the output off.						
Low AC input protection (AC-FAIL)							
Operation	Turn the output off.						
Power limit (POWER LIMIT)							
Operation	Over power limit.						
Value (fixed)	Approx. 105% of rated output power						
<b>Analog Programming and Monitoring</b>							
External voltage control output voltage	Accuracy and linearity: ±0.5% of rated output voltage.						
External voltage control output current	Accuracy and linearity: ±1% of rated output current.						
External resistor control output voltage	Accuracy and linearity: ±1.5% of rated output voltage.						
External resistor control output current	Accuracy and linearity: ±1.5% of rated output current.						
Output voltage monitor							
Accuracy	%	±1	±1	±1	±1	±2	±2
Output current monitor							
Accuracy	%	±1	±1	±1	±1	±2	±2
Shutdown control	Turns the output or power off with a LOW (0V to 0.5V) or short-circuit.						
Output on/off control	Possible logic selections: Turn the output on using a LOW (0V to 0.5V) or short-circuit, turn the output off using a HIGH (4.5V to 5V) or open-circuit. Turn the output on using a HIGH (4.5V to 5V) or open-circuit, turn the output off using a LOW (0V to 0.5V) or short-circuit.						
CV/CC/ALM/PWR ON/OUT ON indicator	Photocoupler open collector output; Maximum voltage 30V, maximum sink current 8mA.						
<b>Front Panel</b>							
Display, 4 digits							
Voltage accuracy 0.1% +	mV	20	20	20	100	200	400
Current accuracy 0.1% +	mA	70	60	40	30	10	4
Indications	GREEN LED's: CV, CC, VSR, ISR, DLY, RMT, 20, 40, 60, 80, 100, %W, W, V, A						

		RED LED's: ALM						
Buttons		Function, OVP/OCP, Set, Test, Lock/Local, PWR DSPL, Output						
Knobs		Voltage, Current						
USB port		Type A USB connector						
Programming and Measurement (USB, LAN, GPIB)								
Output voltage programming accuracy 0.1% +	mV	10	10	10	100	200	400	
Output current programming accuracy 0.1% +	mA	60	50	30	15	10	4	
Output voltage programming resolution	mV	1	1	2	3	5	14	
Output current programming resolution	mA	2	2	2	2	1	1	
Output voltage measurement accuracy 0.1% +	mV	10	10	10	100	200	400	
Output current measurement accuracy 0.1% +	mA	60	50	30	15	10	4	
Output voltage measurement resolution	mV	1	1	2	3	5	14	
Output current measurement resolution	mA	2	2	2	2	1	1	
Series and Parallel Capability								
Parallel number	Units	3	3	3	3	3	3	
Series Number	Units	2	2	2	2	None	None	
Input Characteristics								
Nominal input rating		100Vac to 240Vac, 50Hz to 60Hz, single phase						
Input voltage range		85Vac ~ 265Vac						
Input voltage range		47Hz ~ 63Hz						
Maximum input current								
	100Vac	A	10					
	200Vac	A	5					
Inrush current		Less than 50A.						
Maximum input power	VA	1000						
Power factor								
	100Vac	0.99						
	200Vac	0.97						
Efficiency								
	100Vac	%	77	78	78	79	79	80
	200Vac	%	79	80	80	81	81	82
Hold-up time		20ms or greater						

Interface Capabilities	
USB	TypeA: Host, TypeB: Slave, Speed: 1.1/2.0, USB Class: CDC(Communications Device Class)
LAN	MAC Address, DNS IP Address, User Password, Gateway IP Address, Instrument IP Address, Subnet Mask
GPIB	Optional: GUG-001 ( GPIB to USB Adapter)
Environmental Conditions	
Operating temperature	0°C to 50°C
Storage temperature	-25°C to 70°C
Operating humidity	20% to 85% RH; No condensation
Storage humidity	90% RH or less; No condensation
Altitude	Maximum 2000m
General Specifications	
Weight (main unit only)	kg Approx. 5kg
Dimensions (W x H x D)	mm 142 x 124 x 350
Cooling	Forced air cooling by internal fan.
EMC	Complies with the European EMC directive for Class A test and measurement products.
Safety	Complies with the European Low Voltage Directive and carries the CE-marking.
Withstand voltage	Between input and chassis: No abnormalities at 1500 Vac for 1 minute. Between input and output: No abnormalities at 3000 Vac for 1 minute. Between output and chassis: No abnormalities at 500 Vdc for 1 minute for 30V, 40, 80V, 160V models. No abnormalities at 1500 Vdc for 1 minute for 250V, 800V models.
Insulation resistance	Between input and chassis: 500 Vdc, 100MΩ or more Between input and output: 500 Vdc, 100MΩ or more Between output and chassis: 500 Vdc, 100MΩ or more for 30V, 40V, 80V, 160V and 250V models. 1000Vdc, 100MΩ or more for 800V models.

\*1 At 85 ~ 132Vac or 170 ~ 265Vac, constant load.

\*2 From No-load to Full-load, constant input voltage. Measured at the sensing point in Remote Sense.

\*3 Measure with JEITA RC-9131B (1:1) probe

\*4 Measurement frequency bandwidth is 10Hz to 20MHz.

- \*5 Measurement frequency bandwidth is 5Hz to 1MHz.
  - \*6 From 10% to 90% of rated output voltage, with rated resistive load.
  - \*7 From 90% to 10% of rated output voltage, with rated resistive load.
  - \*8 Time for output voltage to recover within 0.1% + 10mV of its rated output for a load change from 50 to 100% of its rated output current.
  - \*9 For load voltage change, equal to the unit voltage rating, constant input voltage.
-



## PSW 1080W

PSW 30-108, PSW 40-81, PSW 80-40.5, PSW 160-21.6,  
PSW 250-13.5, 800-4.32

Model	Unit	PSW 30-108	PSW 40-81	PSW 80-40.5	PSW 160-21.6	PSW 250-13.5	PSW 800-4.32
Rated Output Voltage	V	30	40	80	160	250	800
Rated Output Current	A	108	81	40.5	21.6	13.5	4.32
Rated Output Power	W	1080	1080	1080	1080	1080	1080
Power Ratio	--	3	3	3	3.2	3.125	3.2
Constant Voltage Mode							
Line Regulation <sup>*1</sup>	mV	18	23	43	83	128	403
Load Regulation <sup>*2</sup>	mV	20	25	45	85	130	405
Ripple and Noise <sup>*3</sup>							
p-p <sup>*4</sup>	mV	100	100	100	100	120	200
r.m.s <sup>*5</sup>	mV	14	14	14	20	15	30
Temperature coefficient	ppm/°C	100ppm/°C of rated output voltage, after a 30 minute warm-up.					
Remote sense compensation voltage (single wire)	V	0.6	0.6	0.6	0.6	1	1
Rise Time <sup>*6</sup>							
Rated Load	ms	50	50	50	100	100	150
No Load	ms	50	50	50	100	100	150
Fall Time <sup>*7</sup>							
Rated Load	ms	50	50	50	100	150	300
No Load	ms	500	500	500	1000	1200	2000
Transient response time <sup>*8</sup>	ms	1	1	1	2	2	2
Constant Current Mode							
Line regulation <sup>*1</sup>	mA	113	86	45.5	26.6	18.5	9.32
Load regulation <sup>*9</sup>	mA	113	86	45.5	26.6	18.5	9.32
Ripple and noise							
r.m.s <sup>*5</sup>	mA	216	162	81	45	30	15
Temperature coefficient	ppm/°C	200ppm/°C of rated output current, after a 30 minute warm-up.					
Protection Function							
Over voltage protection (OVP)							

Setting range	V	3-33	4-44	8-88	16-176	20-275	20-880
Setting accuracy		± (2% of rated output voltage)					
<b>Over current protection (OCP)</b>							
Setting range	A	5-118.8	5-89.1	4.05-44.55	2.16-23.76	1.35-14.85	0.432-4.752
Setting accuracy		± (2% of rated output current)					
<b>Overheat(Over temperature) protection (OHP (OTP))</b>							
Operation		Turn the output off.					
<b>Low AC input protection (AC-FAIL)</b>							
Operation		Turn the output off.					
<b>Power limit (POWER LIMIT)</b>							
Operation		Over power limit.					
Value (fixed)		Approx. 105% of rated output power					
<b>Analog Programming and Monitoring</b>							
External voltage control output voltage		Accuracy and linearity: ±0.5% of rated output voltage.					
External voltage control output current		Accuracy and linearity: ±1% of rated output current.					
External resistor control output voltage		Accuracy and linearity: ±1.5% of rated output voltage.					
External resistor control output current		Accuracy and linearity: ±1.5% of rated output current.					
<b>Output voltage monitor</b>							
Accuracy	%	±1	±1	±1	±1	±2	±2
<b>Output current monitor</b>							
Accuracy	%	±1	±1	±1	±1	±2	±2
Shutdown control		Turns the output or power off with a LOW (0V to 0.5V) or short-circuit.					
<b>Output on/off control</b>							
		Possible logic selections: Turn the output on using a LOW (0V to 0.5V) or short-circuit, turn the output off using a HIGH (4.5V to 5V) or open-circuit. Turn the output on using a HIGH (4.5V to 5V) or open-circuit, turn the output off using a LOW (0V to 0.5V) or short-circuit.					
CV/CC/ALM/PWR ON/OUT ON indicator		Photocoupler open collector output; Maximum voltage 30V, maximum sink current 8mA.					
<b>Front Panel</b>							
<b>Display, 4 digits</b>							
Voltage accuracy 0.1% +	mV	20	20	20	100	200	400
Current accuracy 0.1% +	mA	100	80	50	30	20	6

Indications	GREEN LED's: CV, CC, VSR, ISR, DLY, RMT, 20, 40, 60, 80, 100, %W, W, V, A						
	RED LED's: ALM						
Buttons	Function, OVP/OCP, Set, Test, Lock/Local, PWR DSPL, Output						
Knobs	Voltage, Current						
USB port	Type A USB connector						
Programming and Measurement (USB, LAN, GPIB)							
Output voltage programming accuracy 0.1% +	mV	10	10	10	100	200	400
Output current programming accuracy 0.1% +	mA	100	80	40	20	15	6
Output voltage programming resolution	mV	1	1	2	3	5	14
Output current programming resolution	mA	3	3	3	3	1	1
Output voltage measurement accuracy 0.1% +	mV	10	10	10	100	200	400
Output current measurement accuracy 0.1% +	mA	100	80	40	20	15	6
Output voltage measurement resolution	mV	1	1	2	3	5	14
Output current measurement resolution	mA	3	3	3	3	1	1
Series and Parallel Capability							
Parallel number	Units	3	3	3	3	3	3
Series Number	Units	2	2	2	2	None	None
Input Characteristics							
Nominal input rating	100Vac to 240Vac, 50Hz to 60Hz, single phase						
Input voltage range	85Vac ~ 265Vac						
Input voltage range	47Hz ~ 63Hz						
Maximum input current							
100Vac	A	15					
200Vac	A	7.5					
Inrush current	Less than 75A.						
Maximum input power	VA	1500					
Power factor							
100Vac	0.99						
200Vac	0.97						
Efficiency							
100Vac	%	77	78	78	79	79	80
200Vac	%	79	80	80	81	81	82
Hold-up time	20ms or greater						

<b>Interface Capabilities</b>	
USB	TypeA: Host, TypeB: Slave, Speed: 1.1/2.0, USB Class: CDC(Communications Device Class)
LAN	MAC Address, DNS IP Address, User Password, Gateway IP Address, Instrument IP Address, Subnet Mask
GPIB	Optional: GUG-001 (GPIB to USB Adapter)
<b>Environmental Conditions</b>	
Operating temperature	0°C to 50°C
Storage temperature	-25°C to 70°C
Operating humidity	20% to 85% RH; No condensation
Storage humidity	90% RH or less; No condensation
Altitude	Maximum 2000m
<b>General Specifications</b>	
Weight (main unit only)	kg Approx. 7.5kg
Dimensions (W x H x D)	mm 214 x 124 x 350
Cooling	Forced air cooling by internal fan.
EMC	Complies with the European EMC directive for Class A test and measurement products.
Safety	Complies with the European Low Voltage Directive and carries the CE-marking.
Withstand voltage	Between input and chassis: No abnormalities at 1500 Vac for 1 minute. Between input and output: No abnormalities at 3000 Vac for 1 minute. Between output and chassis: No abnormalities at 500 Vdc for 1 minute for 30V, 40, 80V, 160V models. No abnormalities at 1500 Vdc for 1 minute for 250V, 800V models.
Insulation resistance	Between input and chassis: 500 Vdc, 100MΩ or more Between input and output: 500 Vdc, 100MΩ or more Between output and chassis: 500 Vdc, 100MΩ or more for 30V, 40V, 80V, 160V and 250V models. 1000Vdc, 100MΩ or more for 800V models.

\*1 At 85 ~ 132Vac or 170 ~ 265Vac, constant load.

\*2 From No-load to Full-load, constant input voltage. Measured at the sensing point in Remote Sense.

\*3 Measure with JEITA RC-9131B (1:1) probe

\*4 Measurement frequency bandwidth is 10Hz to 20MHz.

\*5 Measurement frequency bandwidth is 5Hz to 1MHz.

- \*6 From 10% to 90% of rated output voltage, with rated resistive load.
  - \*7 From 90% to 10% of rated output voltage, with rated resistive load.
  - \*8 Time for output voltage to recover within 0.1% + 10mV of its rated output for a load change from 50 to 100% of its rated output current.
  - \*9 For load voltage change, equal to the unit voltage rating, constant input voltage.
-

# PSW Dimensions

## Type I

PSW 160-7.2/PSW 80-13.5/PSW 40-27/PSW 30-36 (scale: mm)

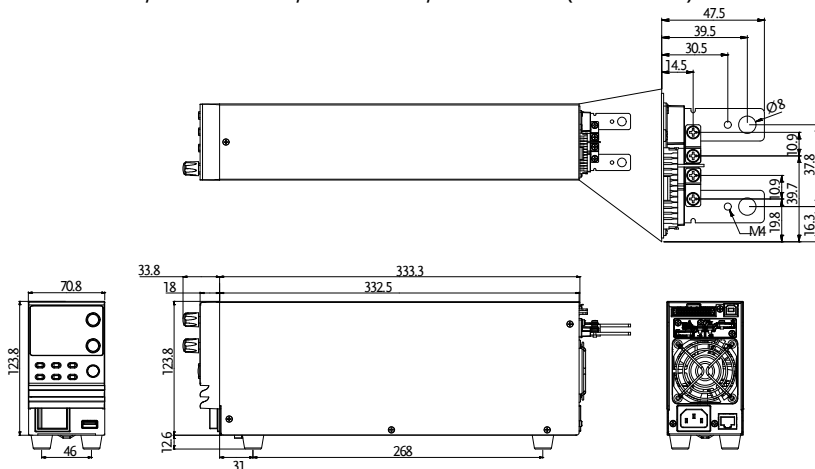

PSW 250-4.5/PSW 800-1.44 (scale: mm)

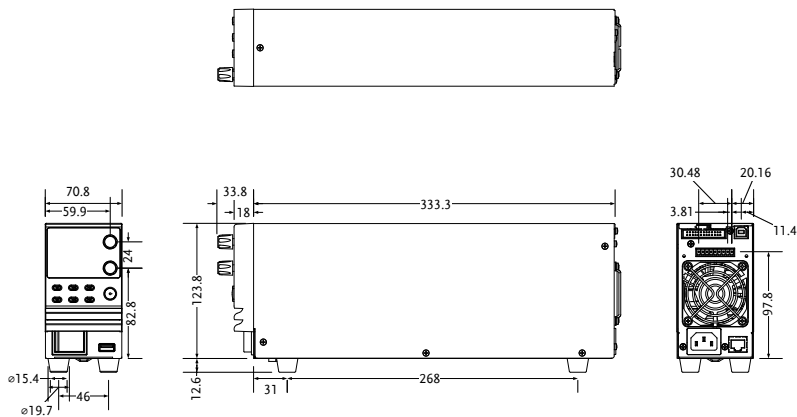

Type II

PSW 160-14.4/PSW 80-27/PSW 40-54/PSW 30-72 (scale: mm)

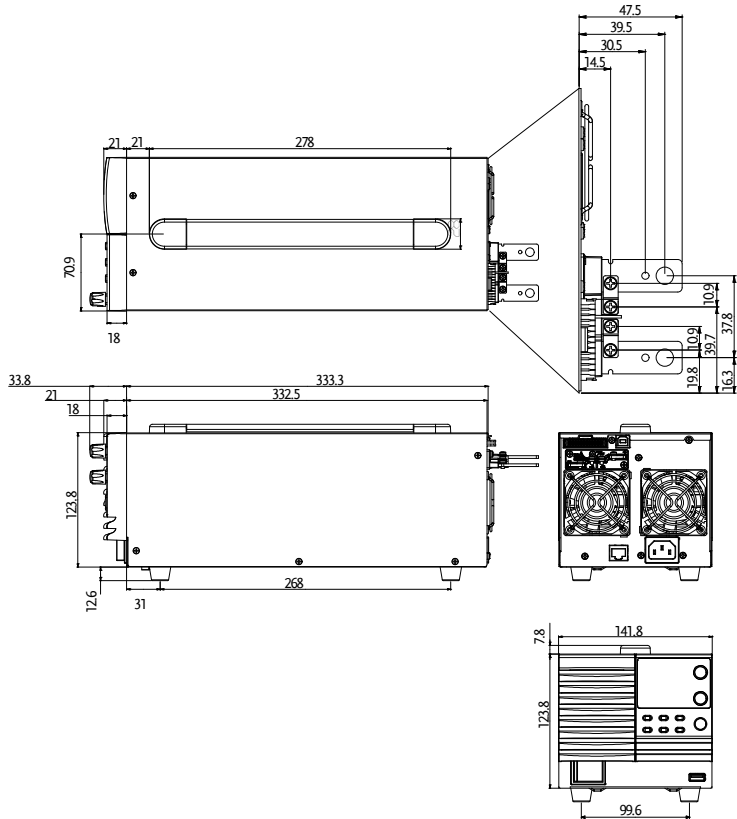

Type II

PSW 250-9/PSW 800-2.88 (scale: mm)

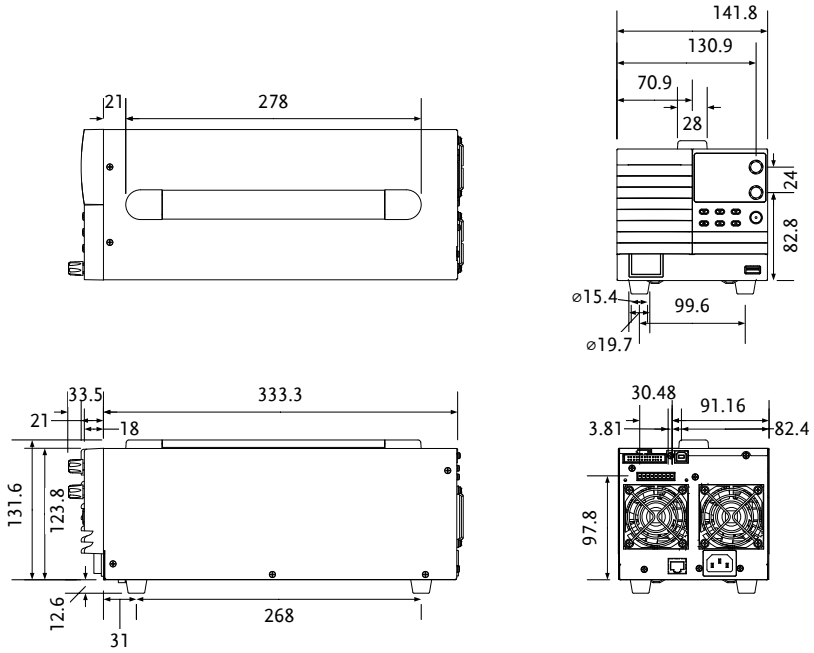



Type III

PSW 160-21.6/PSW 80-40.5/PSW 40-81/PSW 30-108 (scale: mm)

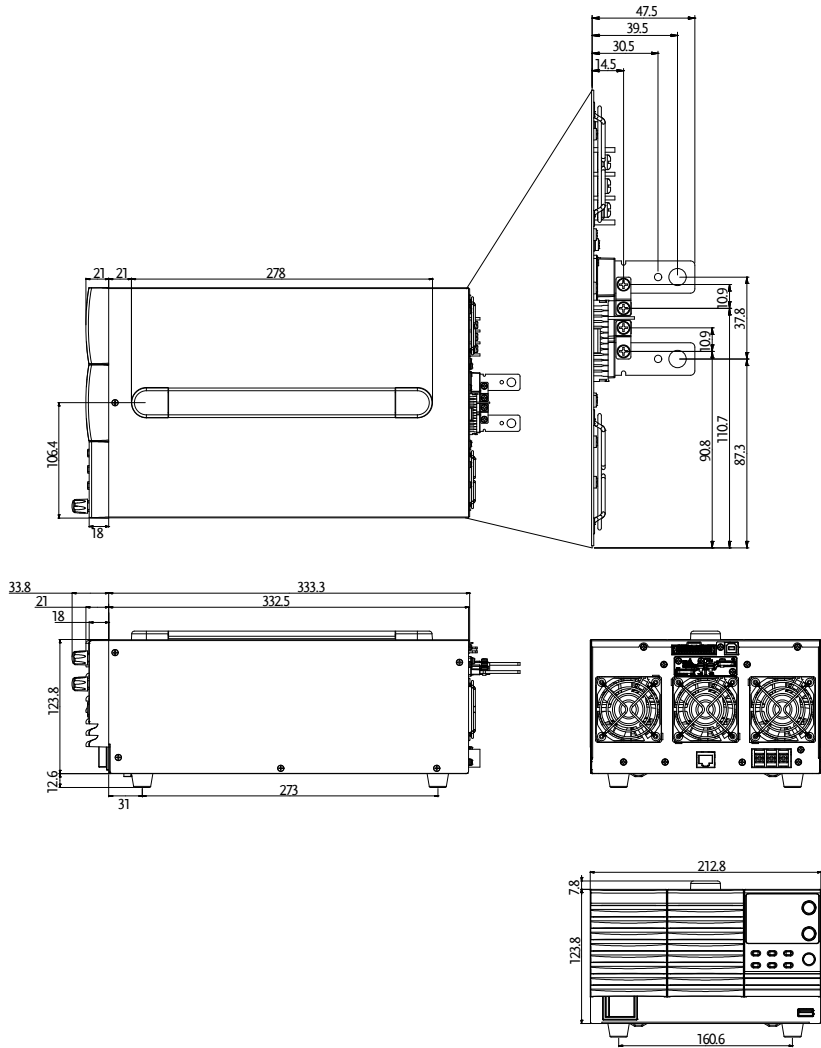

### Type III

PSW 250-13.5/PSW 800-4.32 (scale: mm)

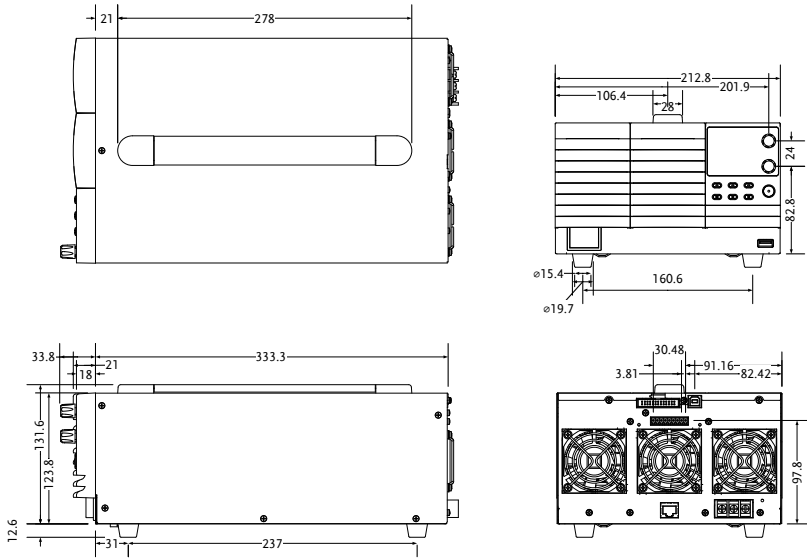

## Certificate Of Compliance

We

**GOOD WILL INSTRUMENT CO., LTD.**

declare that the CE marking mentioned product

satisfies all the technical relations application to the product within the scope of council:

Directive: EMC; LVD; WEEE; RoHS

The product is in conformity with the following standards or other normative documents:

© EMC	
EN 61326-1	Electrical equipment for measurement, control and laboratory use -- EMC requirements
Conducted & Radiated Emission EN 55011 / EN 55032	Electrical Fast Transients EN 61000-4-4
Current Harmonics EN 61000-3-2 / EN 61000-3-12	Surge Immunity EN 61000-4-5
Voltage Fluctuations EN 61000-3-3 / EN 61000-3-11	Conducted Susceptibility EN 61000-4-6
Electrostatic Discharge EN 61000-4-2	Power Frequency Magnetic Field EN 61000-4-8
Radiated Immunity EN 61000-4-3	Voltage Dip/ Interruption EN 61000-4-11 / EN 61000-4-34
© Safety	
EN 61010-1 :	Safety requirements for electrical equipment for measurement, control, and laboratory use - Part 1: General requirements

**GOODWILL INSTRUMENT CO., LTD.**

No. 7-1, Jhongsing Road, Tucheng District, New Taipei City 236, Taiwan

Tel: [+886-2-2268-0389](tel:+886-2-2268-0389)

Fax: [+886-2-2268-0639](tel:+886-2-2268-0639)

Web: <http://www.gwinstek.com>

Email: [marketing@goodwill.com.tw](mailto:marketing@goodwill.com.tw)

**GOODWILL INSTRUMENT (SUZHOU) CO., LTD.**

No. 521, Zhujiang Road, Snd, Suzhou Jiangsu 215011, China

Tel: [+86-512-6661-7177](tel:+86-512-6661-7177)

Fax: [+86-512-6661-7277](tel:+86-512-6661-7277)

Web: <http://www.instek.com.cn>

Email: [marketing@instek.com.cn](mailto:marketing@instek.com.cn)

**GOODWILL INSTRUMENT EURO B.V.**

De Run 5427A, 5504DG Veldhoven, The Netherlands

Tel: [+31-\(0\)40-2557790](tel:+31-(0)40-2557790)

Fax: [+31-\(0\)40-2541194](tel:+31-(0)40-2541194)

Email: [sales@gw-instek.eu](mailto:sales@gw-instek.eu)

# INDEX

Accessories .....	11
Alarm	
description .....	37
Analog connector	
pin assignment .....	121
Analog control	
output control .....	132
overview .....	120
remote monitoring .....	137
resistance control – current	
output .....	130
resistance control – voltage	
output .....	128
shutdown control .....	135
status monitoring .....	139
voltage control – current output	126
voltage control – voltage output	123
Bleeder control	
description .....	29
Description .....	27
Build date	
view .....	59
Caution symbol .....	5
CC and CV mode	
description .....	25
CC mode	
operation .....	67
Cleaning the instrument .....	6
Configuration	
calibration settings .....	116
LAN settings .....	112
Normal function settings .....	107
normal function settings	
operation .....	116
overview .....	101
power on configuration operation	118
power on configuration settings	114
script test settings .....	90
System settings .....	114
table .....	101
test function settings .....	91
USB/GPIB settings .....	112
Connector plug manufacturer	20, 51
Conventions .....	56
CV mode	
operation .....	65
DECA SwitchLab .....	20, 51
Declaration of conformity .....	187
Default settings .....	163
reset .....	58
Dimensions	
diagram .....	182
Display format .....	166
Display mode	
operation .....	70
Disposal instructions .....	7
EN61010	
pollution degree .....	7
Environment	
safety instruction .....	6
Error messages .....	166
Ethernet	
interface .....	145
sockets .....	146
web server .....	145
FAQ .....	160
Filter installation .....	46
Front panel diagram .....	15
Ground	
symbol .....	5
Grounding .....	40
Internal resistance	
description .....	36
LCD conversion .....	166
Line voltage	
PSW 30-108/40-81/80-40.5/160-	
21.6 .....	44

List of features.....	10	Service operation	
Load connection		about disassembly.....	6
PSW-250/800 .....	51	contact .....	161
PSW-30/40/80/160.....	48	Slew rate	
Maintenance		description .....	27
replacing the filter .....	159	Socket server function check ..	152
Marketing		Specifications .....	167
contact.....	161	PSW 160-14.4 .....	172
Messages.....	166	PSW 160-21.6 .....	177
Model differences .....	9	PSW 160-7.2 .....	167
OCP level.....	62	PSW 250-13.5 .....	177
Operating area description.....	22	PSW 250-4.5 .....	167
Operation considerations .....	37	PSW 250-9 .....	172
floating output .....	40	PSW 30-108 .....	177
inrush current .....	37	PSW 30-36 .....	167
Pulsed loads .....	38	PSW 30-72 .....	172
reverse current .....	38	PSW 40-27 .....	167
Output connector pinout .....	52	PSW 40-54 .....	172
Output connector wiring.....	52	PSW 40-81 .....	177
OVP level.....	62	PSW 800-1.44 .....	167
Panel lock.....	71	PSW 800-2.88 .....	172
Parallel mode		PSW 800-4.32 .....	177
connection .....	79	PSW 80-13.5 .....	167
operation.....	81	PSW 80-27 .....	172
overview.....	76	PSW 80-40.5 .....	177
Power on/off		System version	
safety instruction .....	6	view .....	59
Power up.....	46	Terminal cover	
Rack mount		PSW-30/40/80/160 .....	50
description.....	56	Test script	
Rear panel diagram .....	18	check available memory.....	99
Remote control.....	142	export.....	97
interface configuration.....	143	load.....	92
Remote control function check.....	147	overview .....	90
Realterm.....	148	remove/delete test.....	98
Remote sense		run	
connection .....	74	automatically .....	96
operation.....	71	manually.....	94
Series mode		USB driver version	
connection .....	85	view .....	59
Operation.....	87	Warning symbol.....	5
overview.....	83	Web server function check.....	152
		Wire gauge chart.....	47