

LEAKAGE CURRENT TESTER

GLC-9000

QUICK START GUIDE

GWINSTEK PART NO. : 82LC-90000MB1



ISO-9001 CERTIFIED MANUFACTURER

GW INSTEK

This manual contains proprietary information, which is protected by copyright. All rights are reserved. No part of this manual may be photocopied, reproduced or translated to another language without prior written consent of Good Will Corporation.

The information in this manual was correct at the time of printing. However, Good Will continues to improve its products and therefore reserves the right to change the specifications, equipment, and maintenance procedures at any time without notice.

Good Will Instrument Co., Ltd.
No. 7-1, Jhongsing Rd., Tucheng City, Taipei County 236, Taiwan.

Table of Contents

I	INTRODUCTION.....	5
	Introduction	5
	Front Panel.....	6
	Rear Panel	8
	Leakage Current Modes.....	9
	Key Features	10
	Power and Probe Connection.....	14
	Preparation	17
	Interface.....	19
O	PERATION	23
	Measurement Terminals	23
	Non-medical Network (General Electrical Appliance)	23
	Medical Equipment.....	24
	Leakage Current Testing Connections	25
O	OTHER.....	29
	EUT Voltage and Current Check.....	29
	Voltage Measurement.....	30

I NTRODUCTION

This quick start guide is designed to help those who are not familiar with the GLC-9000 to quickly learn the fundamentals. For details on system settings, parameter settings, save/recall, remote instructions and other operation features and functions, please refer to the user manual.

Introduction

Overview



This quick start guide provides the basics on:

- Front and rear panels with descriptions of all features and functions on the panels
- Description of the Leakage current modes
- Basic preparation and power up
- Main screen display overview
- Summaries of the different leakage current measurement operations
- Summary of the EUT Voltage and Current Check function and the Voltage Meter function.

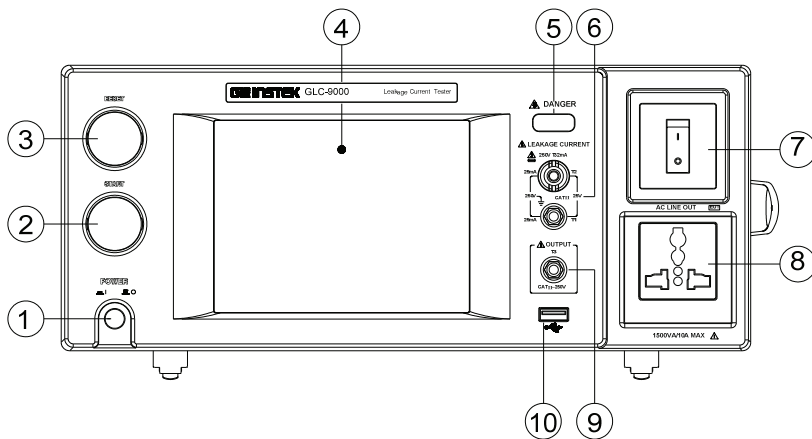
Front Panel

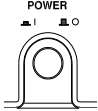
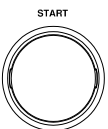
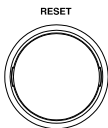
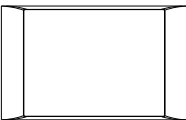

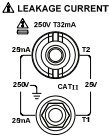
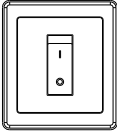
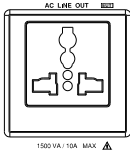

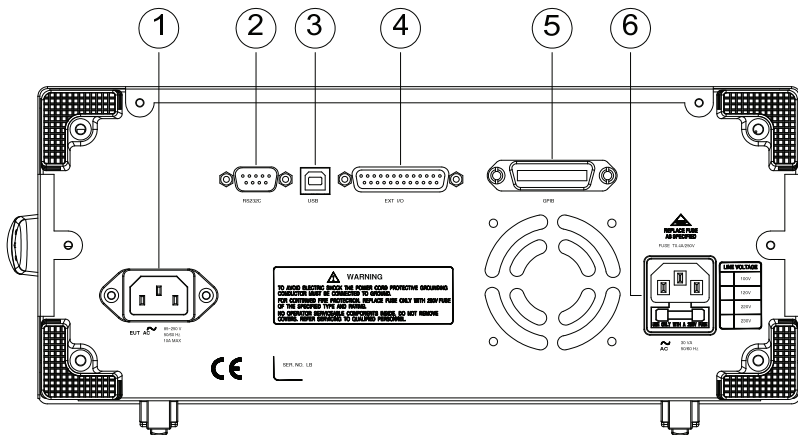

Item		Description
1. POWER		The power switch turns the power on or off. ■ : ON ■ ○ : OFF
2. START		The green START button starts measurements.
3. RESET		The red RESET button stops measurements.
4. Display		5.6" inch touch screen LCD display. The touch screen display is the primary user interface.

- | | | |
|--------------------------------|---|--|
| 5. Warning Indicator |  | <p>The warning indicator lights up when high voltages are produced from terminals T1, T2 or T3. The warning indicator will flash when in standby mode.</p> |
| 6. Measuring Terminals |  | <p>Measuring Terminals T1 and T2 are used to measure leakage current. Terminal T2 has a replaceable fuse (250V, 32mA).</p> |
| 7. Circuit Breaker |  | <p>The circuit breaker has over-current protection for the EUT rated at 15A. When testing, the warning indicator will illuminate.</p> <p>I: ON, normal operation
O: OFF, inactive or during over-current protection.</p> |
| 8. EUT AC Terminal Block |  | <p>Supplies AC power for the EUT. Includes automatic shut-down (circuit breaker) with over-current protection. Maximum current output 10A, maximum power output, 1500VA.</p> |
| 9. T3 110% Voltage Application |  | <p>An isolated voltage (1:1) is output to T3 from the EUT AC IN voltage by an isolation transformer. This terminal is limited to medical networks (MD:F)</p> |
| 10. USB HOST |  | <p>USB host terminal.</p> |

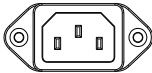
Rear Panel

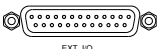
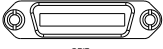

ITEM	Description
1. EUT AC IN	 <p>EUT AC inlet. AC voltage range: 85V~ 250V AC, 50~60Hz 10A Max</p>
2. RS-232 Terminal	 <p>RS-232 Interface</p>
3. USB connector	 <p>USB terminal for remote control.</p>
4. EXT I/O connector	 <p>External input/output remote control connector.</p>
5. GPIB connector	 <p>GPIB Interface for remote control.</p>
6. Power Socket/ Fuse socket.	 <p>The power socket accepts AC mains power for the GLC-9000.</p> <p>Power: 100V/120/220/ 230V AC Fuse: T0.4A/250V</p>

Leakage Current Modes

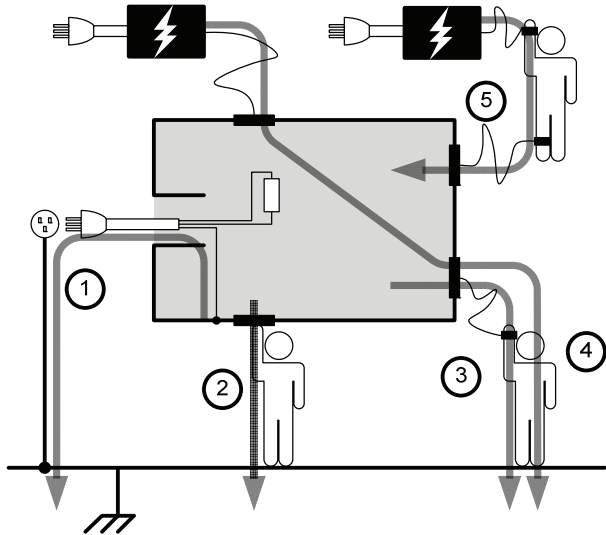

- | | |
|-------------------------------|---|
| 1. Earth Leakage Current | Refers to the current that flows through a protective grounding wire to earth. (General Electrical, Medical Equipment) |
| 2. Enclosure Leakage Current | Refers to the current that flows through a human body in contact with a device enclosure. (General Electrical, Medical Equipment) |
| 3. Patient Leakage Current I | Refers to the current that flows through a human body that is directly connected to a device. (Medical Equipment) |
| 4. Patient Leakage Current II | Refers to the current that flows through a human body that is directly connected to a device under faulty conditions. (Medical Equipment) |

- | | |
|--------------------------------|--|
| 5. Patient Leakage Current III | Refers to the current that flows through a human body that is directly connected to a device that malfunctions. (Medical Equipment) |
| 6. Patient Auxiliary Current | Refers to the current that flows through a human and a device during normal operation. This is not intended to be perceptible. (Medical Equipment) |

Key Features

International Standards and Regulations

The GLC-9000 has nine measurement networks (Measuring Devices: MD) supporting GB/12113, IEC/UL and other international standards for electrical products:

- (1) MD-A:IEC60990
 - (2) MD-B:IEC60990
 - (3) MD-C:IEC60990
 - (4) MD-D:UL
 - (5) MD-E(1k Ω):-general application
 - (6) MD-F: Medical
 - (7) MD-G:UL
 - (8) MD-H:(2k Ω):-general application
 - (9) MD-I:JIS
-

Measurement Modes	<p>There are a number of leakage current measurement tests covering general electrical equipment and medical electrical equipment.</p> <ol style="list-style-type: none"> (1) Earth Leakage Current. (2) Leakage current from enclosure and earth. (3) Leakage current from enclosure to enclosure. (4) Leakage current from enclosure to line. (5) Patient Auxiliary Current*. (6) Patient leakage current I*. (7) Patient leakage current II*. (8) Patient leakage current III*. <p>*Tests 5,6,7,8 are applicable to medical MD-F devices.</p>
-------------------	--

Leakage Current Types	Leakage current measurement modes : DC, AC, AC+DC, AC Peak.
-----------------------	--

Measurement Range	<p>Automatic/Manual ranges:</p> <p>DC/AC/AC+DC : 50uA/500uA/5mA/25mA (Range : 4uA~25mA)</p> <p>AC Peak : 500uA/1mA/10mA/75mA (Range : 40uA~75mA)</p>
-------------------	--

Operation	<ul style="list-style-type: none"> • Auto/Manual/Programmable Single fault conditions and power supply polarity switch • Measurement/Delay time settings • Maximum / minimum hold • PASS/FAIL(Upper, Lower) Judgement (limits) • save and recall setup and measurement results • System clock settings • Multilanguage support • System Self test • EUT voltage/current/power consumption • High output alarm and led indicators. • Remote control interface options
Interface	<p>With the exception of the Start, Reset and power switches, the user-interface is entirely controlled via a touch screen.</p>
LCD	<p>The simple, user-friendly interface is extremely intuitive with a large 5.6" color TFT screen.</p>
EUT Test Status	<p>The voltage, current and power consumption of the EUT can be measured.</p>
Built-in Voltage Meter	<p>The built in voltage meter detects 0-300V. The voltage meter is activated when the Safety Extra Low Voltage (SELV) function is on.</p>
Memory	<ul style="list-style-type: none"> • 30 sets of memory for user defined test conditions • 50 sets of standard test conditions. (e.g., IEC60990) • 100 sets of measurements can be saved/recalled

Remote Interface There are a variety of remote control interfaces including: RS-232, USB (Host/Device), GPIB and the EXT I/O connector.

Protection The LED warning indicator will illuminate and emit a tone by default for:

- Judgment limits. (high/low limits).
- High Voltages output from the testing terminals.
- Overload protection (fuse protection).
- Relay protection for EUT overloads.

Power and Probe Connection

- Mains Power
1. Ensure the power is switched off from the front panel.
 2. Insert the AC mains power into the power socket on the right-hand side of the rear panel.

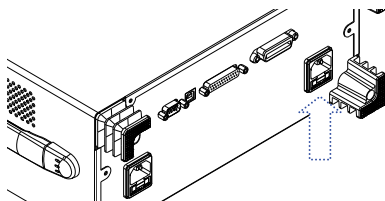

The arrow above shows the location of the AC main power socket.

- EUT Power
1. Ensure the power switch is off on the front panel.
 2. Insert the power cord as shown on the right into the EUT AC Line In.

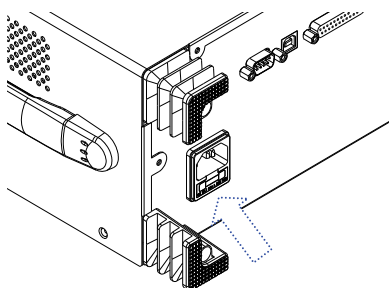

The arrow above shows the EUT AC line in socket, located on the left-hand side of the rear panel.



Caution

If network B (MD B) is selected an isolation transformer that outputs 110% of the rated voltage specified for the EUT is required. The neutral line must be grounded (from the secondary side of the transformer).

Measurement networks (MD)A, B, C all require an isolation transformer.

T1/T2/T3
Terminals

1. Insert the test leads to one of the terminals
2. The measuring mode determines which terminal will be used.

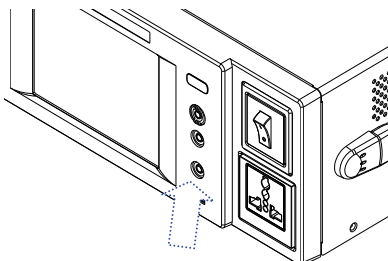

Terminals T1, T2 and T3 are shown above.



Warning: To avoid the risk of electric shock, do not touch the tips of the test leads when operating.

Foil Probe

1. The foil probe is used to measure the surface leakage current (touch current) of the EUT. Attach the probe metal-foil-side down onto the enclosure of the EUT.
2. Attach the test leads to the foil probe using alligator clips to the area on the right, as shown in the diagram

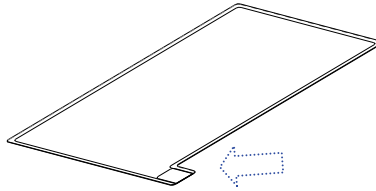

The arrow above shows the contact point for the test lead.

Alligator Clips

1. Plug a test lead into the rear panel.
2. Use an alligator clip to clip to the metal foil or to other points under test.

The arrow mark indicates the location that the test lead and alligator clips are clipped together.

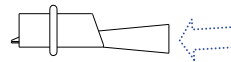

Preparation

Voltage Line Selection

Before power is turned on, ensure the line voltage is correct for the environment. The line voltage is shown on the rear panel.

LINE VOLTAGE	
	100V
	120V
	220V
	230V

Voltage: 100/120/220/230V
 ±10% Frequency: 50~60Hz



Warning

Ensure a three pronged grounded power socket is used.

Fuse

Ensure the correct fuse is used before power up. (Fuse: T0.4A/250V)



EUT AC Line In

Before connecting power to the EUT AC Line In, confirm the EUT input power and test requirements do not exceed the EUT AC Line In requirements.

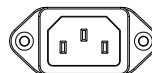

Voltage Range: 85V ~ 250V / 50 ~ 60Hz



Caution

* EUT : 10A(max), 1500VA(max)

Power Up

Press the power switch to turn on the power. The system will enter the measurement interface after a quick initialization. The interface panel will appear after a short time.

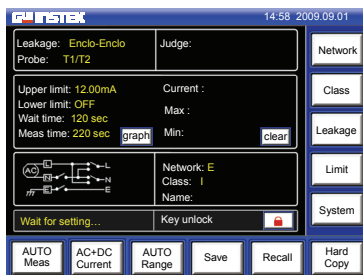
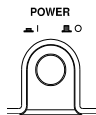

Shutdown

Before shutdown, ensure the EUT is shut down properly. As illustrated below, power off the circuit breaker before turning off the equipment. After the EUT is powered down, the GLC-9000 can be powered down.

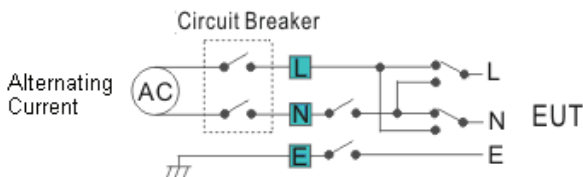

Interface

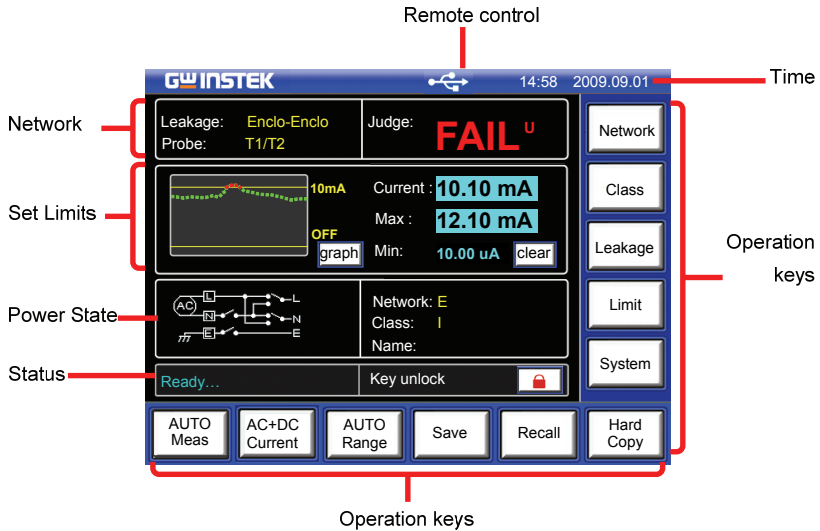

Main Display

Network	Leakage	Displays the current measuring network types (general electrical equipment and medical networks): <ul style="list-style-type: none"> • Earth leakage current • Enclosure to earth leakage current • Enclosure to enclosure leakage current • Enclosure to line leakage current • Patient auxiliary leakage current • Patient leakage current I • Patient leakage current II • Patient leakage current III
	Probe	Shows the probe terminals used for the current measuring network.

	Judge:	Shows the test result judgment.
Set Limits	Upper Limit:	Displays the upper test limit.
	Lower Limit:	Displays the lower test limit
	Wait Time:	Displays the wait time before a test commences.
	Meas Time	Measurement time.
	<input type="button" value="graph"/> <input type="button" value="text"/> <input type="button" value="clear"/>	Toggles the Set Limit display from graphical to text mode. Graphical mode graphs the results in real-time. Clears the Max/Min test results from the screen.
Power State	Displays the current power state settings.	
Status	Displays the status of the test. There are three status types.	
	Wait for Setting	Occurs when the instrument is powered up or when the measurement network, class or leakage current mode has changed.
	Ready	Occurs when the <i>Meas</i> key is pressed after <i>Network</i> , <i>Class</i> or <i>Leakage</i> is chosen.
	Testing	Press the <i>START</i> button whilst in Ready mode to enter Testing mode. The <i>RESET</i> option will be displayed when in Testing mode.



Indicates that the touch panel is currently unlocked. Press the *Lock* key to lock the front panel.



Indicates the front panel is locked. To unlock press and hold the unlock key for a 3 seconds.

Note: The front panel will also become locked when *Start* is pressed or the remote control function is used.

Remote Control



There are four types of remote control.



Time

Displays the current system date and time.

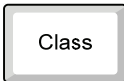
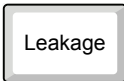
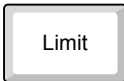
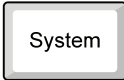
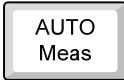
Operation Keys

	Measuring network selection		Equipment class type
	Leakage current mode selection		Set leakage current limits
	Access the system parameters		Sets the measurement mode
	Leakage current type selection		Leakage current range selection



Save a screen image (BMP)



Save settings. Manual measurements can be saved in real-time.

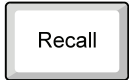

Recall settings

OPERATION

Measurement Terminals

When a measurement network is selected, different measuring terminals are required for each test and equipment class. The tables below list which terminals are used for with which network/test.

Non-medical Network (General Electrical Appliance)

MD-A, B, C, D, E, G, H, I

	CLASS I	CLASS II	Internal Power Supply
Earth leakage current	Not used	N/A	N/A
Enclosure and earth leakage current	T2	T2	T2
Enclosure and enclosure leakage current	T1,T2	T1,T2	T1,T2
Enclosure and line leakage current	T2	T2	N/A

Medical Equipment

MD-F

		CLASS I		CLASS II		Internal Power	
		Type B	Type F*	Type B	Type F*	Type B	Type F*
Earth leakage current		Not Used		N/A		N/A	
Enclosure and earth leakage current	Normal	T2	T2	T2	T2	T2	T2
	Fault	T2,T3	T2,T3	T2,T3	T2,T3	T2,T3	T2,T3
Enclosure and enclosure leakage current	Normal	T1,T2	T1,T2	T1,T2	T1,T2	T1,T2	T1,T2
	Fault	T1~3	T1~3	T1~3	T1~3	T1~3	T1~3
Patient auxiliary current		T1,T2	T1,T2	T1,T2	T1,T2	T1,T2	T1,T2
Patient leakage current I		T2	T2	T2	T2	T1,T2	T1,T2
Patient leakage current II		T2,T3	N/A	T2,T3	N/A	T2,T3	N/A
Patient leakage current III		N/A	T2	N/A	T2	N/A	T2

*Type F = Type BF and Type CF.

Leakage Current Testing Connections

Background Confirm all settings including MD, leakage current mode, measurement time, upper and lower limits, and other parameters.

Earth Leakage Current

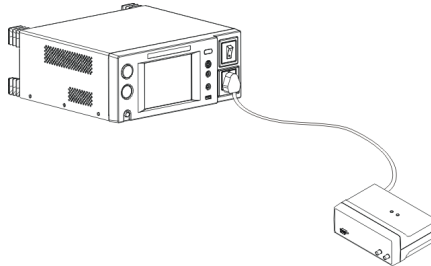

Enclosure Leakage Current

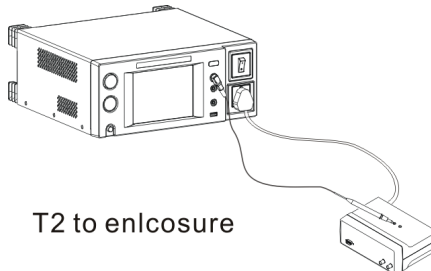

T2 to enclosure

Non-medical type (General electrical equipment)

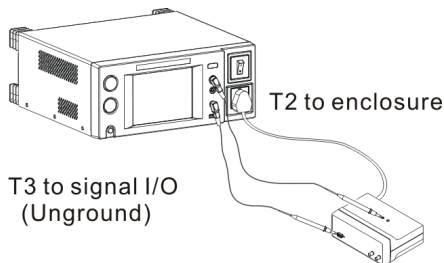

T2 to enclosure

T3 to signal I/O (Unground)

Medical type (MD-F) Requires 110% power supply voltage output.



The T3 terminal is high voltage. Avoid contact with the terminal. The T3 terminal should not be connected with an earth conductor.

Enclosure to
Enclosure
Leakage Current

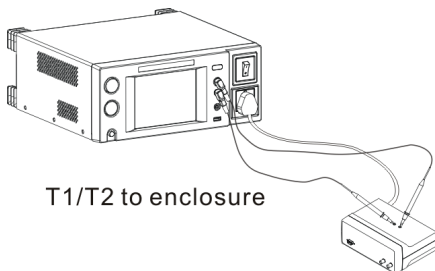

T1/T2 to enclosure

Non-medical type (General electrical equipment)

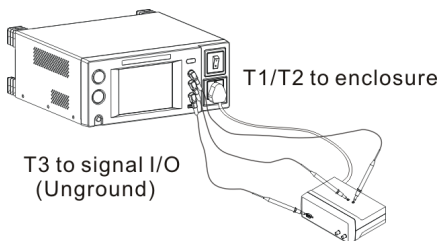

T1/T2 to enclosure

T3 to signal I/O
(Unground)

Medical type (MD-F) Requires 110% power supply voltage output.



The T3 terminal is high voltage. Avoid contact with the terminal. The T3 terminal should not be connected with an earth conductor.

Enclosure and
Line Leakage
Current

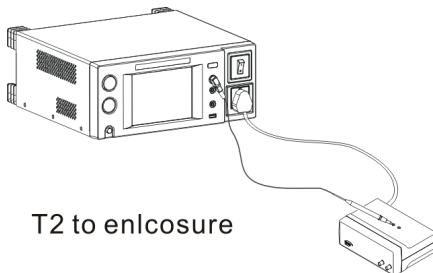

Non-medical type (General electrical equipment)



The T2 terminal is high voltage. Avoid contact with the terminal. The T2 terminal should not be connected with an earth conductor.

Patient Auxiliary
Current

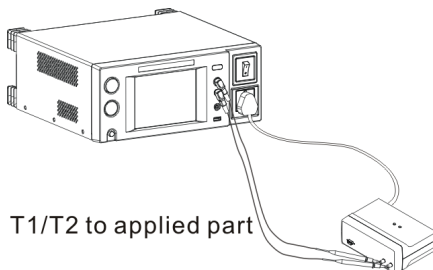

Medical network

Patient Leakage
Current I

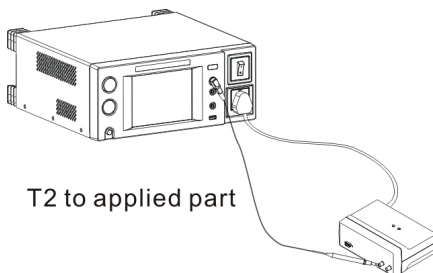

Medical network (Class I and Class II)

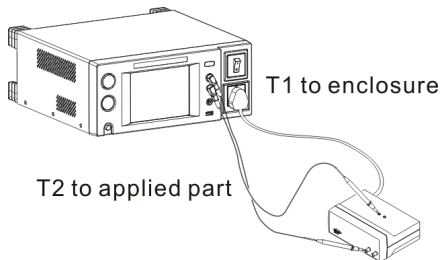

Medical network (Internal power supply)

Patient Leakage Current II

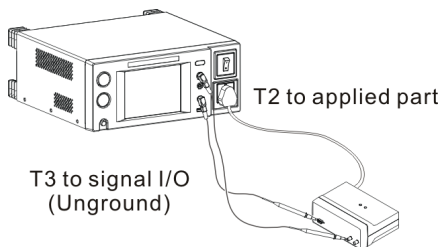

Type B Medical Network



The T3 terminal is high voltage. Avoid contact with the terminal. The T3 terminal should not be connected with an earth conductor.

Patient Leakage Current III

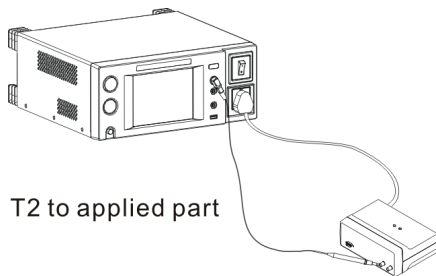

Type F Medical Network



The T2 terminal is high voltage. Avoid contact with the terminal. The T2 terminal should not be connected with an earth conductor.

For more details on leakage current connections, please see the GLC-9000 user manual.



EUT Voltage and Current Check

Background The EUT voltage and current check tests voltage, current and power consumption.

- Panel Operation** 1. To access the *EUT voltage & current check* menu, press the *V/A Check* key from the *System setup* menu.

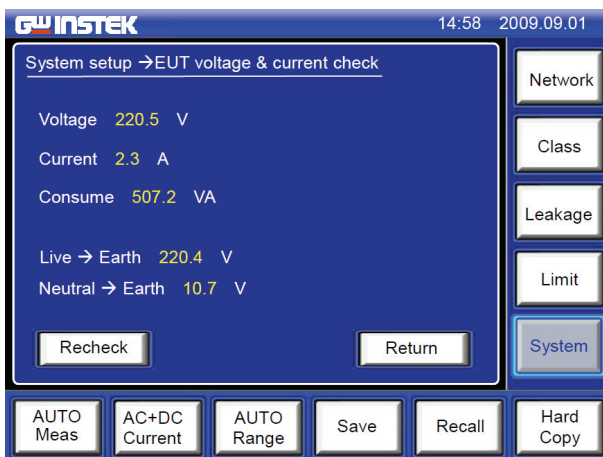
A rectangular button with a light gray background and a thin black border, containing the text 'V/A Check' in a black sans-serif font.

Voltage, current, power consumption and voltage between Live and Earth as well as Neutral to Earth will be displayed.

2. To perform the voltage and current check again, press *Recheck*.

A rectangular button with a light gray background and a thin black border, containing the text 'Recheck' in a black sans-serif font.

Voltage Measurement

Background From the System menu, the meter function can measure different types of voltages: AC, DC, AC+DC and AC peak. The safety extra low voltage limit can also be set from the Meter menu.

Meter Mode

1. From the *System* Menu, press the *Meter* key to access the Voltage Meter (T1/T2) menu.

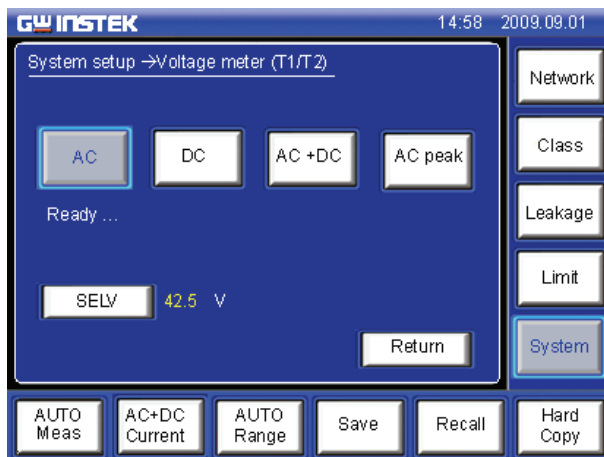
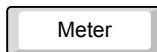

Ready will be displayed before starting measurements.

2. Choose the measurement type. Press the *START* button to begin measuring. Press *RESET* to stop measuring.

Range AC, DC, AC+DC, AC Peak

SELV When a voltage exceeds the safety extra low voltage (SELV), the warning indicator will become illuminated and an alarm will sound. SELV can be auto configured or turned off.

- To set the safety extra low voltage, press the SELV key.

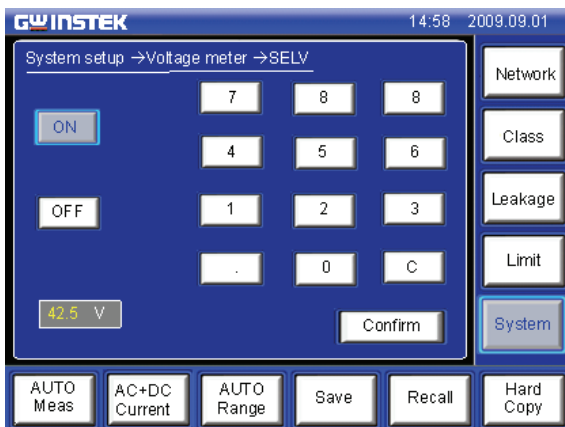

- To set the SELV use the number pad and press *Confirm*.

SELV Range 0~99 volts

- Press *ON* to enable the SELV.

SELV Setting On/Off

For more details see the *System Settings* chapter of the GLC-9000 user manual.