

Digital Storage Oscilloscope

GBS-1000 Series

USER MANUAL

GW INSTEK PART NO. 82BS-12040E01



ISO-9001 CERTIFIED MANUFACTURER

GW INSTEK

December 2013

This manual contains proprietary information, which is protected by copyrights. All rights are reserved. No part of this manual may be photocopied, reproduced or translated to another language without prior written consent of Good Will company.

The information in this manual was correct at the time of printing. However, Good Will continues to improve products and reserves the rights to change specification, equipment, and maintenance procedures at any time without notice.

Good Will Instrument Co., Ltd.
No. 7-1, Jhongsing Rd., Tucheng City, Taipei County 236, Taiwan.

Table of Contents

SAFETY INSTRUCTIONS	5
GETTING STARTED	10
GBS-1000 Series Overview	11
Appearance	14
Set Up	22
QUICK REFERENCE	26
Menu Tree / Operation Shortcuts	28
Default Settings	49
Built-in Help	50
MEASUREMENT	51
Basic Measurement	53
Automatic Measurement	60
Cursor Measurement	67
Math Operation	73
Go-NoGo Test	78
Program	87
Data Logging	92
CONFIGURATION	97
Acquisition	99
Display	104
Horizontal View	108
Vertical View (Channel)	118
Trigger	124
System Info / Language / Clock	132
SAVE/RECALL	135
File Format/Utility	136







Quick Save (HardCopy)	143
Save	145
Recall	155
PRINT OUT	163
REMOTE CONTROL CONFIG	166
Interface Configuration	167
MAINTENANCE	171
Vertical Resolution Calibration	171
Probe Compensation	172
FAQ	174
APPENDIX	177
Fuse Replacement	177
GBS-1000 Specifications	178
Probe Specifications	181
INDEX	184

S SAFETY INSTRUCTIONS

This chapter contains important safety instructions that you must follow when operating GBS-1000 and when keeping it in storage. Read the following before any operation to ensure your safety and to keep the best condition for GBS-1000.

Safety Symbols

These safety symbols may appear in this manual or on GBS-1000.

	WARNING	Warning: Identifies conditions or practices that could result in injury or loss of life.
	CAUTION	Caution: Identifies conditions or practices that could result in damage to GBS-1000 or to other properties.
	DANGER	High Voltage
	Attention	Refer to the Manual
	Protective Conductor Terminal	
	Earth (ground) Terminal	



Do not dispose electronic equipment as unsorted municipal waste. Please use a separate collection facility or contact the supplier from which this instrument was purchased.

Safety Guidelines

General Guideline



CAUTION

- Make sure the BNC input voltage does not exceed 300V peak.
- Never connect a hazardous live voltage to the ground side of the BNC connectors. It might lead to fire and electric shock.
- Do not place any heavy object on GBS-1000.
- Avoid severe impacts or rough handling that leads to damaging GBS-1000.
- Do not discharge static electricity to GBS-1000.
- Use only mating connectors, not bare wires, for the terminals.
- Do not block the cooling fan opening.
- Do not perform measurement at power source and building installation site (Note below).
- Do not disassemble GBS-1000 unless you are qualified.

(Measurement categories) EN 61010-1:2001 specifies the measurement categories and their requirements as follows. GBS-1000 falls under category II.

- Measurement category IV is for measurement performed at the source of low-voltage installation.
 - Measurement category III is for measurement performed in the building installation.
 - Measurement category II is for measurement performed on the circuits directly connected to the low voltage installation.
 - Measurement category I is for measurements performed on circuits not directly connected to Mains.
-

- Power Supply
- AC Input voltage: 100 ~ 240V AC, 48 ~ 63Hz
 - The power supply voltage should not fluctuate more than 10%.
 - Connect the protective grounding conductor of the AC power cord to an earth ground, to avoid electrical shock.
-

- Fuse
- Fuse type: T2A/250V
 - Make sure the correct type of fuse is installed before power up.
 - To ensure fire protection, replace the fuse only with the specified type and rating.
 - Disconnect the power cord before fuse replacement.
 - Make sure the cause of fuse blowout is fixed before fuse replacement.
-

- Cleaning GBS-1000
- Disconnect the power cord before cleaning.
 - Use a soft cloth dampened in a solution of mild detergent and water. Do not spray any liquid.
 - Do not use chemical containing harsh material such as benzene, toluene, xylene, and acetone.
-

- Operation Environment
- Location: Indoor, no direct sunlight, dust free, almost non-conductive pollution (Note below)
 - Relative Humidity: $\leq 80\%$, 40°C or below
 $\leq 45\%$, 41°C~50°C
 - Altitude: < 2000m
 - Temperature: 0°C to 50°C

(Pollution Degree) EN 61010-1:2001 specifies the pollution degrees and their requirements as follows. GBS-1000 falls under degree 2.

Pollution refers to “addition of foreign matter, solid, liquid, or gaseous (ionized gases), that may produce a reduction of dielectric strength or surface resistivity”.

- Pollution degree 1: No pollution or only dry, non-conductive pollution occurs. The pollution has no influence.
- Pollution degree 2: Normally only non-conductive pollution occurs. Occasionally, however, a temporary conductivity caused by condensation must be expected.
- Pollution degree 3: Conductive pollution occurs, or dry, non-conductive pollution occurs which becomes conductive due to condensation which is expected. In such conditions, equipment is normally protected against exposure to direct sunlight, precipitation, and full wind pressure, but neither temperature nor humidity is controlled.

Storage environment

- Location: Indoor
- Storage Temperature: $-10^{\circ}\text{C}\sim 60^{\circ}\text{C}$, no condensation-
- Relative Humidity: 93% @ 40°C
65% @ $41^{\circ}\text{C}\sim 60^{\circ}\text{C}$

Disposal



Do not dispose this instrument as unsorted municipal waste. Please use a separate collection facility or contact the supplier from which this instrument was purchased. Please make sure discarded electrical waste is properly recycled to reduce environmental impact.

Power cord for the United Kingdom

When using GBS-1000 in the United Kingdom, make sure the power cord meets the following safety instructions.

NOTE: This lead/appliance must only be wired by competent persons



WARNING: THIS APPLIANCE MUST BE EARTHED

IMPORTANT: The wires in this lead are coloured in accordance with the following code:

Green/ Yellow:	Earth
Blue:	Neutral
Brown:	Live (Phase)



As the colours of the wires in main leads may not correspond with the colours marking identified in your plug/appliance, proceed as follows: The wire which is coloured Green & Yellow must be connected to the Earth terminal marked with the letter E or by the earth symbol \oplus or coloured Green or Green & Yellow.

The wire which is coloured Blue must be connected to the terminal which is marked with the letter N or coloured Blue or Black.

The wire which is coloured Brown must be connected to the terminal marked with the letter L or P or coloured Brown or Red.

If in doubt, consult the instructions provided with the equipment or contact the supplier.

This cable/appliance should be protected by a suitably rated and approved HBC mains fuse: refer to the rating information on the equipment and/or user instructions for details. As a guide, cable of 0.75mm^2 should be protected by a 3A or 5A fuse. Larger conductors would normally require 13A types, depending on the connection method used.

Any moulded mains connector that requires removal /replacement must be destroyed by removal of any fuse & fuse carrier and disposed of immediately, as a plug with bared wires is hazardous if engaged in live socket. Any re-wiring must be carried out in accordance with the information detailed on this label.

GETTING STARTED

This chapter describes GBS-1000 in a nutshell, including its main features and front / rear panel introduction. After going through the overview, follow the Set Up section to properly set up the operation environment.



GBS-1000 series overview	Series lineup 11 Main Features..... 11 Package Contents 13
Appearance	GBS-1074/1104/1204 Front Panel 14 Rear Panel 18 Display 20
Set Up	Tilt stand 22 Power up 23 First Time Use 24

GBS-1000 Series Overview

Series lineup

GBS-1000 series consists of 3 models, divided up by frequency.

Model name	Frequency bandwidth
GBS-1074	70MHz
GBS-1104	100MHz
GBS-1204	200MHz

Main Features

Performance	<ul style="list-style-type: none">• High sampling rate: up to 1GS/S real-time, 25GS/s equivalent-time• Deep memory: 25k points record length• Minimum 10ns peak detection
Feature	<ul style="list-style-type: none">• Wide selection range: 70MHz to 200MHz bandwidth• Powerful display: 5.6 in. color TFT, wide viewing angle, 8x12 divisions waveform support• Automatic measurements: maximum 27 types• FFT/ FFT rms analysis• Triggers: Edge, Video, Pulse Width• Program and play mode• Color printout of display contents• Go-No Go test• Built-in Help• Data Logger• Horizontal and vertical expand settings

Interface

- USB host port: front and rear panel, to printers and storage devices
- USB slave port, RS-232C port: for remote control
- USB slave port for PC software connection
- Calibration output
- Go-No Go output

Package Contents

Check the contents before using GBS-1000.

Opening the box

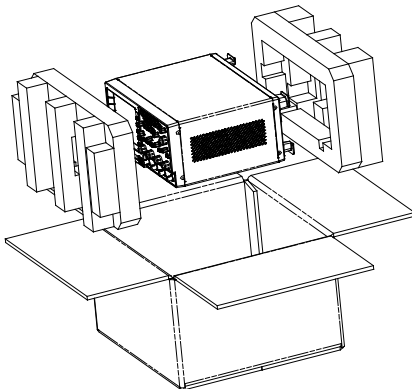

Contents

- Main unit
 - Probe set
 - GBS-1074: GTP-070A-4 x 4
 - GBS-1104: GTP-100A-4 x 4
 - GBS-1204: GTP-250A-2 x 4
 - Power cord
 - CD User manual (this document)
 - Quick Start Guide
-

Note



- For detailed probe specifications, see page 181.
- The Programming manual, PC software, and USB driver are available on the User Manual CD or downloadable from GWINSTEK website. Visit www.gwinstek.com, GBS-1000 corner.

Appearance

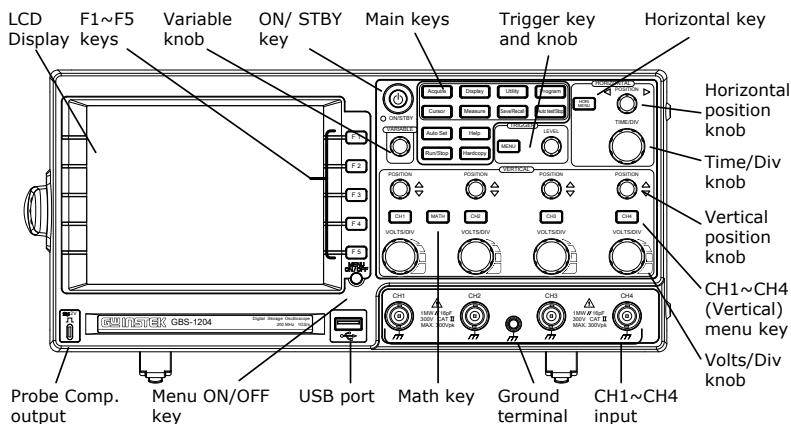
GBS-1074/1104/1204 Front Panel











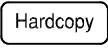
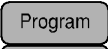
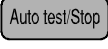
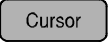
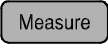
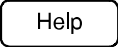

LCD display TFT color, 320 x 234 resolution, wide angle view LCD display.



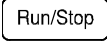

F1 ~ F5 function keys  ~  Activates the functions which appear on the left side of the LCD display.

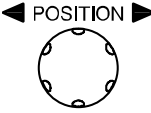
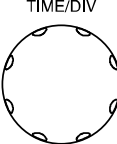
Variable knob **VARIABLE**  Increases/decreases values or moves to the next/previous parameter.

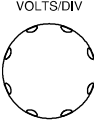
On/Standby key  Switches between the power On state (green indicator) and the standby state (red indicator). For the power up sequence, see page23.

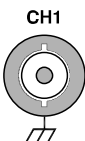
Acquire key		Configures acquisition mode (page99).
Display key		Configures display settings (page104).
Utility key		Configures or shows hardcopy (page143), printer configuration (page163), interface (page167), system info (page132), date/time (page133), menu language (page132), Go-No Go (page78), calibration (page171), data logging (page92) and probe compensation (page172).
Hardcopy key		Prints out display image (page163) or transfers data to USB flash drive (page143).
Program key + Auto test key	 	Edits, runs, and stops program operation (page87).
Cursor key		Configures and runs cursor measurements (page67).
Measure key		Configures and runs automatic measurements (page60).
Help key		Shows Help contents on the LCD display (page50).
Save/Recall key		Saves and recalls waveform, image, and panel setups (page135).

Auto Set key		Finds signals and sets the appropriate horizontal / vertical / trigger settings (page54).
Run/Stop key		Freezes (Stop) or continues (Run) signal acquisition (page55).
Trigger menu key		Configures trigger settings (page124).
Trigger knob		Sets trigger level (page124).
Horizontal menu key		Configures horizontal view (page108).
Horizontal position knob		Sets the horizontal position of waveforms (page108).
Time/Div knob		Selects the horizontal scale (page109).
Vertical position knob		Sets the vertical position of waveforms (page118).
Channel menu key		Configures the vertical scale and coupling mode for each channel (page118).
Volts/Div knob		Selects the vertical scale (page118).

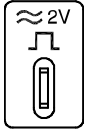
Input terminal		Accepts input signals. Input impedance: $1M\Omega \pm 2\%$.
Ground terminal		Accepts the DUT ground lead for common ground.
Math key		Configures and runs math operation (page72).
USB host port		TypeA, 1.1/2.0 compatible. Prints out display image (page163) or transfers data (page135).
Menu On/Off key		Shows or hides the menu on the LCD display (page107).
Probe compensation output		Outputs 2Vp-p, square signal for probe compensation (page172) or demonstration. Can be used for generic purposes (page58) as well.

Rear Panel

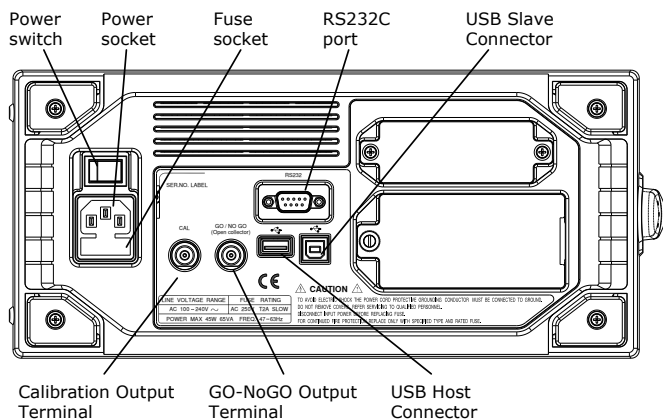

Power switch

Power cord socket

Fuse socket

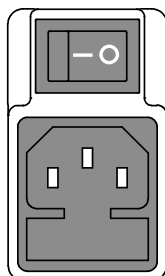

Power switch turns the main power On (I) / Off (O).

Power cord socket accepts AC mains, 100 ~ 240V, 50/60Hz.

Fuse socket holds AC main fuse, T2A/250V.

For power up sequence, see page23.

For fuse replacement procedure, see page177.

RS232C port

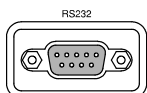

Accepts DB-9 RS-232C connector for remote control (page168).

USB slave port

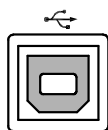

Accepts typeB connector for remote control (page167) or PC software connection. USB 1.1/2.0 full speed compatible.

USB host port

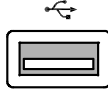

Accepts typeA connector for display image printout (page163) or data transfer (page135). Simultaneous use with the front panel host port is not allowed. TypeA, 1.1/2.0 full speed compatible.

Go-No Go output

GO / NO GO
(Open collector)

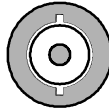

Outputs Go-No Go test result (page78) as 10us pulse signal.

Calibration
output

CAL

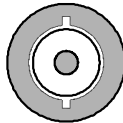

Outputs the signal for vertical scale accuracy calibration (page171).



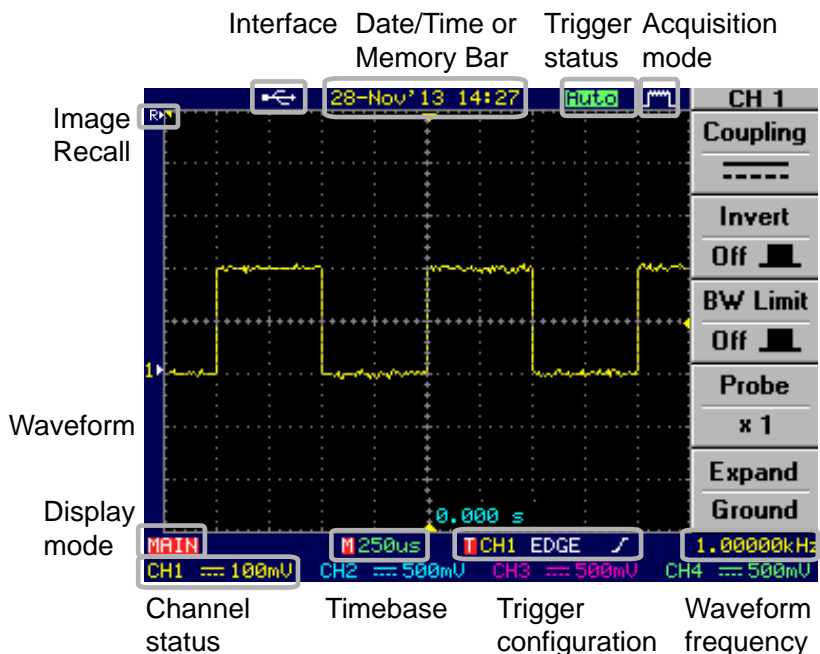





Display

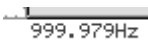
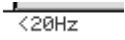

Waveforms	Shows input signal waveforms.	
	Channel 1: Yellow	Channel 2: Blue
	Channel 3: Pink	Channel 4: Green
Image recall		The "R" indicator indicates that a pre-recorded image has been recalled to the display.

Interface	Shows the active interface for remote connection (page166) and PC software connection.	
		USB
		RS-232C

Date/Time 28-Nov'13 14:18 Current date and time (page133).

Memory bar		The ratio and the position of the displayed waveform compared with the internal memory (page108).
Trigger status	<p>Trig'd Triggered.</p> <p>Trig? Not triggered, display not updated.</p> <p>Auto Not triggered, display updated.</p> <p>STOP Trigger stopped. Also appears in Run/Stop (page55).</p>	
		For trigger details, see page124.
Acquisition mode	 Normal mode  Peak detect mode  Average mode	
		For acquisition details, see page99.
Input signal frequency	 Shows the input signal frequency.  Indicates the frequency is less than 20Hz (lower frequency limit).	
Trigger configuration	<p>CH1 EDGE  Trigger source, type, slope. (Video trigger)</p> <p>CH1 VIDEO  trigger source, polarity.</p>	
		For trigger details, see page124.
Channel status	<p>CH1  500mV Channel 1, bw limit On, DC coupling, 500mV/Div</p> <p>CH1  500mV Channel 1, bw limit Off, AC coupling, 500mV/Div</p>	
		For channel details, see page118.

Set Up

Tilt stand

Low angle

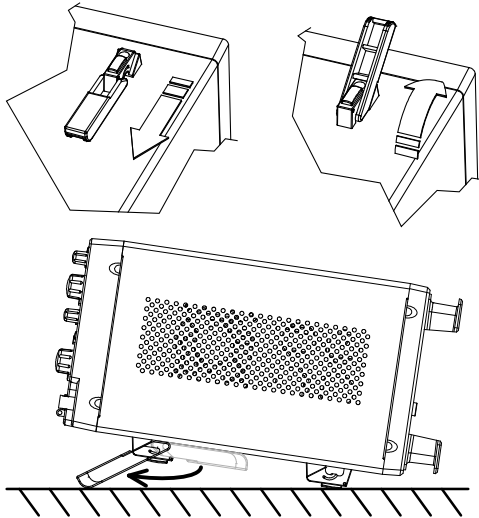

High angle

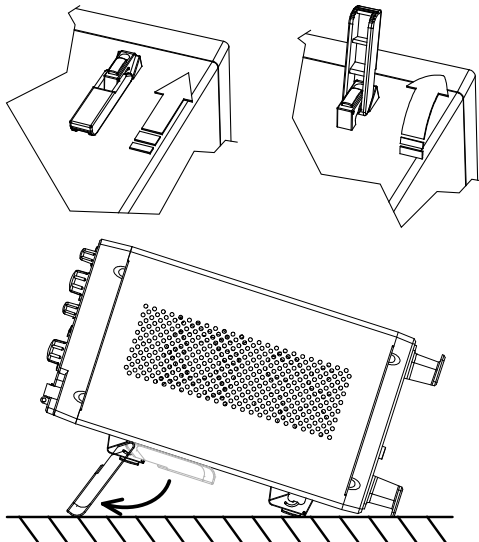

Power up

Step

1. Connect the power cord to the rear panel socket.

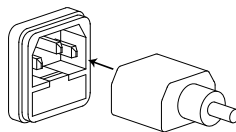

2. Turn On the main power switch. | : On, ○ : Off.

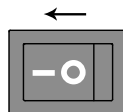

3. The ON/STBY indicator on the front panel turns red.



4. Press the ON/STBY key. The indicator turns green and the display becomes active in 6 ~ 8 seconds.



Note

GBS-1000 recovers the state from right before the power was last turned off. The default setting can be recovered by pressing the Save/Recall key → F1 (Default Setup). For details, see page155.

First Time Use

Background This section describes how to connect a signal, adjust the scale, and compensate the probe. Before operating GBS-1000 in a new environment, run these steps to make sure the instrument is functionally stable and that you are comfortable operating it.

1. Power On Follow the procedure on the previous page.

2. Reset system Reset the system by recalling the factory setting. Press the Save/Recall key, then F1 (Default Setup). For factory setting details, see page49.

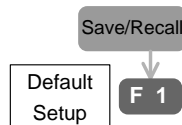

2. Connect probe Connect the probe to Channel1 input terminal and to the probe compensation signal output (2Vp-p, 1kHz square wave). Set the probe attenuation to x10.

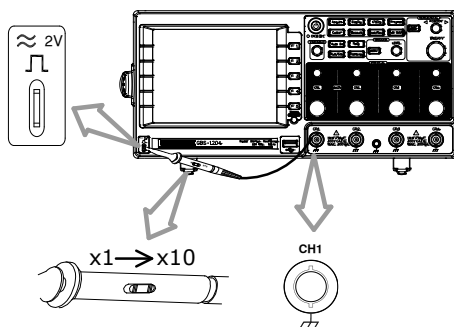

3. Capture signal (Auto Set) Press the Auto Set key. A square waveform appears in the center of the display. For Auto Set details, see page54.



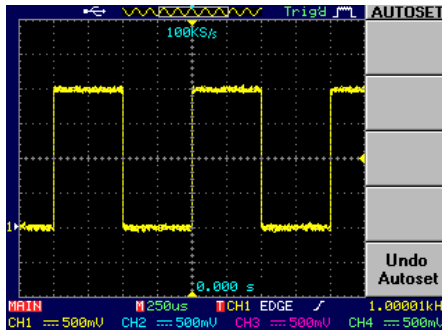

4. Select vector waveform

Press the Display key, then F1 (Type) twice to select the vector waveform.

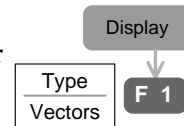
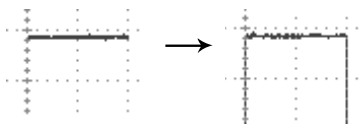

5. Compensate probe

Turn the adjustment point on the probe to make the square waveform edge flat.

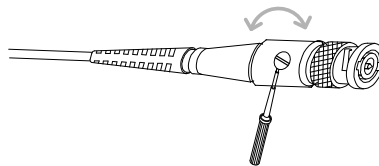
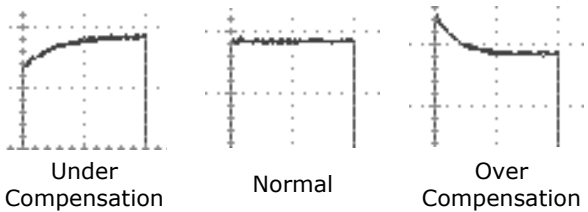

6. Start operation Continue with the other operations.

Measurement: page51 Configuration: page92

Remote control: page166

QUICK REFERENCE

This chapter describes GBS-1000 menu tree, shortcuts to major operations, built-in Help access, and default factory settings. Use them as a handy reference to get a quick access to the functionality.



Menu tree /
shortcut

Menu Tree / Operation Shortcuts	28
Convention	28
Acquire key	28
Auto Set key	28
Auto test/Stop key	29
CH1 ~ 4 key	29
Cursor key	29
Display key	30
Hardcopy key	30
Help key	30
Horizontal menu key	31
Math key (1/2)	31
Math key (2/2)	32
Measure key (1/2)	33
Measure key (2/2)	33
Program key (1/2)	34
Program key (2/2)	34
Run/Stop key	34
Save/Recall key (1/10)	35
Save/Recall key (2/10)	35
Save/Recall key (3/10)	36
Save/Recall key (4/10)	36
Save/Recall key (5/10)	37
Save/Recall key (6/10)	37
Save/Recall key (7/10)	38
Save/Recall key (8/10)	38
Save/Recall key (9/10)	39
Save/Recall key (10/10)	39



	Trigger key (1/5).....	40
	Trigger key (2/5).....	40
	Trigger key (3/5).....	41
	Trigger key (4/5).....	41
	Trigger key (5/5).....	42
	Utility key (1/11).....	43
	Utility key (2/11).....	43
	Utility key (3/11).....	44
	Utility key (4/11).....	44
	Utility key (5/11).....	45
	Utility key (6/11).....	45
	Utility key (7/11).....	46
	Utility key (8/11).....	46
	Utility key (9/11).....	47
	Utility key (10/11).....	47
	Utility key (11/11).....	48
<hr/>		
Default setup	Default Settings	49
Help	Built-in Help	50

Menu Tree / Operation Shortcuts

Convention

- F1 = Press F1
- F1  = Press F1 repeatedly
- F1 ~ F4 = Select one from F1 to F4 and press it
- F1 → VAR  = Press F1, then use the Variable knob
- Auto Set = Press the function key itself (AutoSet in this case)

Acquire key

Acquire			Select acquisition mode F1~F3
ACQUIRE			
Normal	F 1		Select average number (only in average mode)
Peak Detect	F 2		F3 
Average 2	F 3	2/ 4/ 8/ 16/ 32/ 64/ 128/ 256	Select horizontal expansion mode
Hor. Expand Center	F 4	Trigger / Center	F4 
Mem Leng 500	F 5	500/25000 (1CH) 500/12500 (2CH) 500/5000 (3/4CH)	Select memory length F5 

Auto Set key

Auto Set	Automatically find signal and Auto Set set scale
	Undo Auto Set (available for 5 F5 seconds)

Auto test/Stop key

Auto test/Stop

→ See Program key (page34)

CH1 ~ 4 key

CH1			Select coupling mode F1 ↵
Coupling -----	F 1	~ / ---- / ↗	Turn waveform invert On/Off F2 ↵
Invert Off ■	F 2	On/ Off	Turn bandwidth limit On/Off F3 ↵
BW Limit Off ■	F 3	On/ Off	Select probe attenuation factor F4 ↵
Probe x1	F 4	x1/ x10/ x100	Select vertical expansion mode F5 ↵
Expand Ground	F 5	Center/Ground	

Cursor key

Cursor			Select cursor source channel F1 ↵
CURSOR Source CH1	F 1	CH1/ 2/ 3/ 4/ MATH	Select active horizontal cursor F2 ↵
Horizontal : : : : : : : : :	F 2	: : : / : : : : : : / : : :	Select active vertical cursor F3 ↵
Vertical : : : : : : : : : : : : : : : : : :	F 3	: : : : : : / : : : : : : : : : : : : / : : : : : :	
T ₁ : 236.0us T ₂ : 160.0us Δ: 396.0us f: 2.525kHz	F 4		
V ₁ : 1.54V V ₂ : 460mV Δ: 2.00V	F 5		

Display key

Display	
DISPLAY	
Type	F 1 Vectors/ Dots
Dots	
Accumulate	F 2 On/ Off
On	
Refresh	F 3
Contrast	F 4
	F 5

Select waveform display type
F1

Waveform accumulation On/Off
F2 , F3 (refresh the display)

Set display contrast
F4 → VAR

Select display grid
F5

Hardcopy key

Hardcopy → See Utility key (page42)

Help key

Help Turn help mode On/Off Help

Horizontal menu key

HORI MENU

Hor.MENU

Main	F 1
Window	F 2
Window Zoom	F 3
Roll	F 4
XY	F 5

Select main (default) display

F1→TIME/DIV 

Select Window mode and zoom

F2→TIME/DIV  , F3

Select windows roll mode

F4→TIME/DIV 

Select XY mode

F5→VOLTS/DIV 

Math key (1/2)

MATH

MATH

Operation	F 1	↔	CH1+CH2/ CH3+CH4
+			
CH1+CH2	F 2		

Position	F 4	-12div ~ +12div
0.00 Div		
Unit/Div	F 5	
2V		

Select math operation (+/-/x)

F1 

Select channel combination

F2 

Set result position

F4→VAR 

Math result vertical scale

F5→VOLTS/DIV 

Math key (2/2)

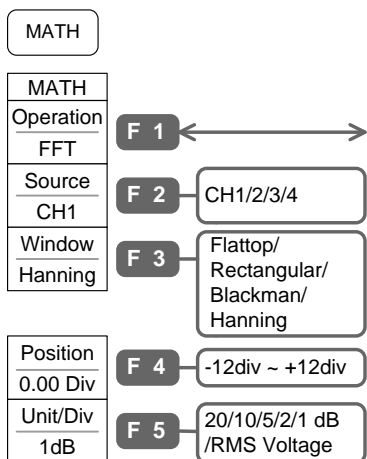

Select math operation type
(FFT/FFT rms)

F1 ↩

Select FFT source channel

F2 ↩

Select FFT window

F3 ↩

Select FFT result position

F4 → VAR ⌚

Select vertical scale

F5 ↩

Measure key (1/2)

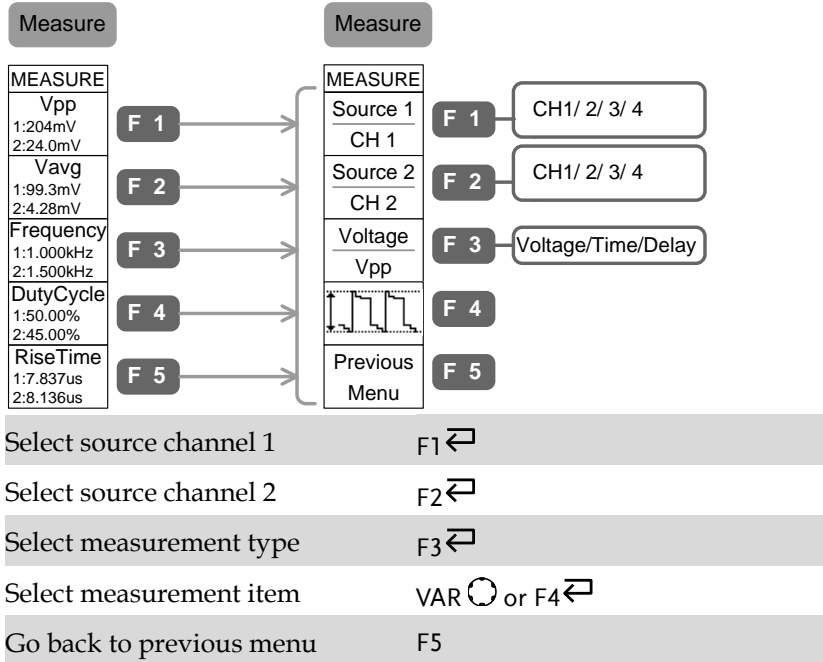

Measure key (2/2)

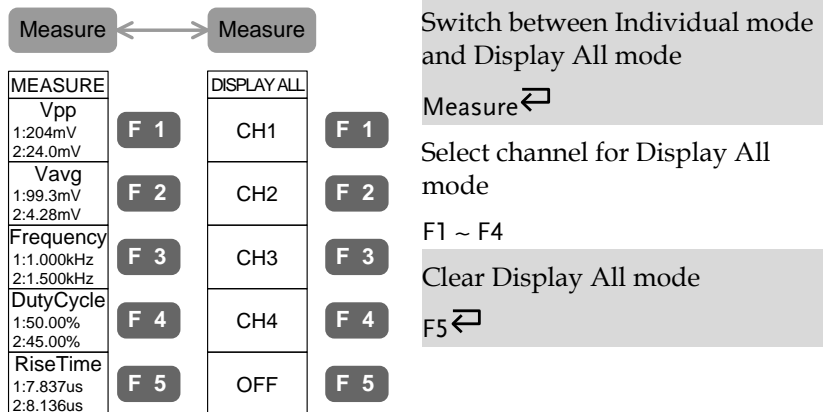

Program key (1/2)

Program		Select Program Edit mode
PROGRAM		F1
▶ Edit	F 1	Select program step
Play		F2 → VAR
Step	F 2	Select edit item and setting of item
01.		1 ~ 20
Item	F 3	F3 → VAR
Menu		Menu/Time/Setup
Save		Save edited program
F 5		F5

Program key (2/2)

Program		Select Program Play mode
Auto test/Stop		F1
PROGRAM		Select program loop count
▶ Edit	F 1	F2 → VAR
Play		Select first step (From:)
Cycle	F 2	F3 → VAR
99		1 ~ 99
▶ From: 1	F 3	Select last step (To:)
To: 4		1 ~ 20 (From ≤ To)
Start		Start /stop program running
F 5		F5 (start), Auto test/Stop (stop)

Run/Stop key

Run/Stop	Freeze/unfreeze signal acquisition	Run/Stop
----------	------------------------------------	----------

Save/Recall key (1/10)

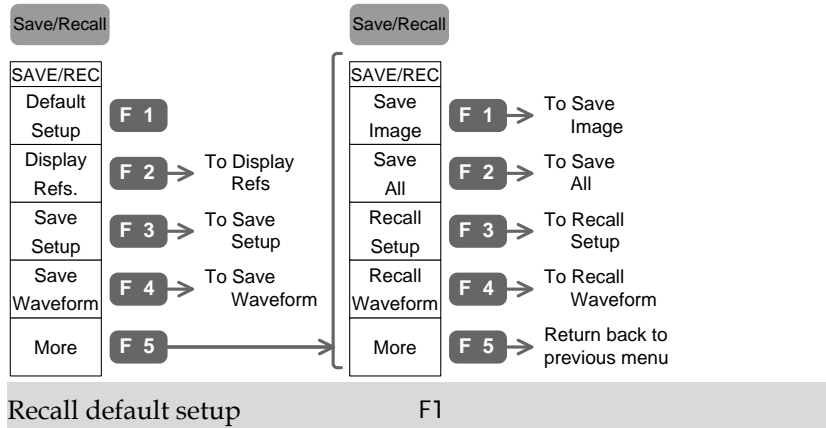

Save/Recall key (2/10)

Display Refs.

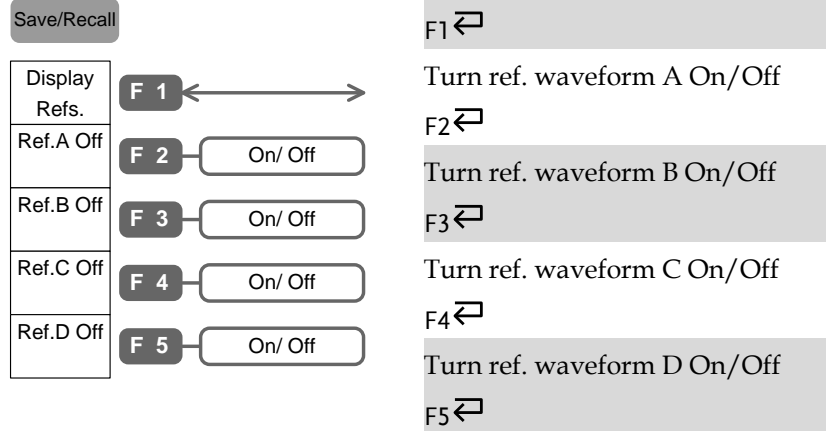

Save/Recall key (3/10)

Save Setup

Save/Recall

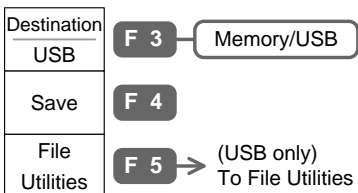

Select Save Setup menu

F1

Select destination

F3 → VAR

Save setup

F4

Go to USB flash drive contents edit mode

F5

Save/Recall key (4/10)

Save Waveform

Save/Recall

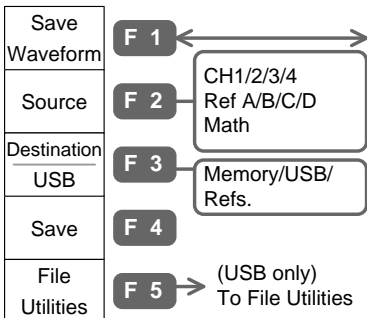

Select Save Waveform menu

F1

Select waveform source

F2 → VAR

Select waveform destination

F3 → VAR

Save waveform

F4

Go to USB flash drive contents edit mode

F5

Save/Recall key (5/10)

Save Image

Save/Recall

Save Image	F 1 ← →
Ink Saver Off 	F 2 <input type="button" value="On/ Off"/>
Destination USB	F 3
Save	F 4
File Utilities	F 5 → (USB only) To File Utilities

Select Save Waveform menu

F1 ↵

Select waveform source

F2 ↵

Select waveform destination

F3 → VAR 

Save waveform

F4

Go to USB flash drive contents edit mode

F5

Save/Recall key (6/10)

Save All

Save/Recall

Save All	F 1 ← →
Ink Saver Off 	F 2 <input type="button" value="On/ Off"/>
Destination USB	F 3
Save	F 4
File Utilities	F 5 → (USB only) To File Utilities

Select Save All menu

F1 ↵

Turn ink saver On/Off

F2 ↵

Select destination

F3 → VAR 

Save all

F4

Go to USB flash drive contents edit mode

F5

Save/Recall key (7/10)

Recall Setup

Save/Recall

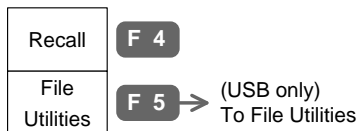
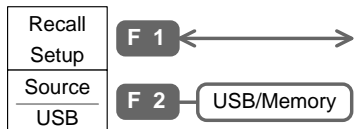

Select Recall Setup menu

F1 ↩

Select setup source

F2 ↩ → VAR ⦿

Recall setup

F4

Go to USB flash drive contents edit mode

F5

Save/Recall key (8/10)

Recall Waveform

Save/Recall

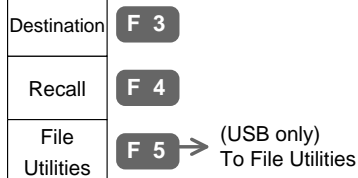
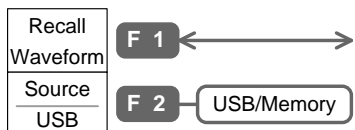

Select Recall Waveform menu

F1 ↩

Select waveform source

F2 ↩ → VAR ⦿

Select waveform destination

F3 → VAR ⦿

Recall waveform

F4

Go to USB flash drive contents edit mode

F5

Save/Recall key (9/10)

File Utilities

Save/Recall

FILE UTILS

Select	F 1	
New Folder	F 2	→ To Keypad Utilities
Rename	F 3	→ To Keypad Utilities
Delete	F 4	
Previous Menu	F 5	

Select file/folder or enter into sub folder

VAR  → F1

Create new folder or rename folder/file

F2, F3 (Enter new folder or rename menu)

Delete folder/file

F4

Save/Recall key (10/10)

Keypad Utilities

Save/Recall

KEYPAD

Enter Character	F 1
Back Space	F 2



Enter new character

VAR  → F1

Delete character

F2 (Backspace)

Save file name/folder name

F4

Save	F 4
------	------------

Previous Menu	F 5
---------------	------------

Trigger key (1/5)

Edge

MENU

TRIGGER

Type	Edge
Source	CH1
Mode	Auto

F 1 ↔ F 2

F 2 → CH1/2/3/4/Line

F 3 → Auto/ Normal/ Single

Select edge trigger type

F1 ↵

Select trigger source

F2 ↵

Select trigger mode

F3 ↵

Go to slope coupling menu.

F5

Slope / Coupling

F 5 → To Slope/Coupling

Trigger key (2/5)

Video

MENU

TRIGGER

Type	Video
Source	CH1
Standard	NTSC
Polarity	
Line	

F 1 ↔

F 2 → CH1/2/3/4

F 3 → NTSC/SECAM/ PAL

F 4 →

F 5 → Line/ Field 1/ Field 2
1~263 (NTSC)
1~313 (SECAM/PAL)

Select Video trigger type

F1 ↵

Select trigger source

F2 ↵

Select video standard

F3 ↵

Select video polarity

F4 ↵

Select video line

F5 ↵ → VAR

Trigger key (3/5)

Pulse

MENU

TRIGGER

Type	F 1	← →
Pulse		
Source	F 2	CH1/2/3/4
CH1		
Mode	F 3	Auto/ Normal/ Single
Auto		
When <	F 4	>/ </ =/ ≠ 20ns~10s
20.0ns		
Slope /	F 5	→ To Slope/Coupling
Coupling		

Select Pulse trigger type

F1 ↵

Select trigger source

F2 ↵

Select trigger mode

F3 ↵

Select pulse trigger condition and pulse width

F4 ↵ → VAR ⦿

Go to slope/coupling menu

F5

Trigger key (4/5)

Slope/Coupling

MENU

TRIGGER

Slope	F 1	
Coupling	F 2	
Rejection	F 3	LF/ HF/ Off
Off		
Noise Rej	F 4	On/ Off
Off		
Previous Menu	F 5	

Select trigger slope type

F1 ↵

Select trigger coupling mode

F2 ↵

Select Frequency Rejection

F3 ↵

Turn Noise Rejection On/Off

F4 ↵

Go back to previous menu

F5

Trigger key (5/5)

Press the MENU key twice

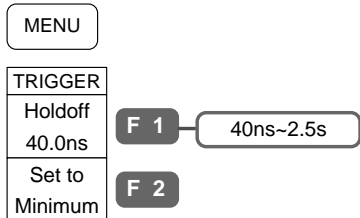

Set Holdoff time

F1→VAR

Set Holdoff time to minimum

F2



Turn Auto Level trigger On/Off

F5



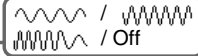



Utility key (1/11)

Utility	
UTILITY	
Hardcopy Menu	F 1 → To Hardcopy menu
Interface Menu	F 2 → To Interface menu
Off 	F 3  / Off
Language English	F 4 English/Chinese(S) Chinese(T)/Spanish Korean/ etc
More	F 5 ↔

Go to Hardcopy menu	F1
Go to Interface menu	F2
Select buzzer sound	F3 
Select language	F4 
Go to other menu	F5 

Utility key (2/11)

Utility	
UTILITY	
Self CAL Menu	F 1  Vertical
System Info.	F 2
Go-NoGo Menu	F 3 → To Go-NoGo menu
NoGoWhen 	F 4  / 
More	F 5 ↔

Start Vertical calibration	F1 → F1
Show system information	F2
Go to Go-NoGo menu	F3
Select NoGo condition	F4 
Go to other menu	F5

Utility key (3/11)

H-COPY
Function Save All
Ink Saver Off 

F 1 — SaveImage/
SaveAll/ Printer

F 2 — On/ Off

Ratio 50%
Previous Menu

F 4 — (Printer only)
10 ~ 100%

F 5

Select Hardcopy function

F1 

Turn Ink Saver On/Off

F2 

Select printout ratio (only in
printout mode)

F4 → VAR 

Run Hardcopy

Hardcopy

Utility key (4/11)

Interface

Utility

Type RS232
Baud Rate 9600
Stop Bit 2
Parity None
Previous Menu

F 1 — RS232/ USB

F 2 — (RS232C only)
2400/ 4800/ 9600/
19200/ 38400

F 3 — (RS232C only)
1/ 2

F 4 — (RS232C only)
Odd/ Even/ None

F 5

Select interface

F1 

Select RS-232C baud rate

F2 

Select RS-232C stop bit

F3 

Select RS-232C parity

F4 

Utility key (5/11)

Go-NoGo

Utility

Go-NoGo	
Template	F 1 → To Go-NoGo Template menu
Edit	
Source	F 2 CH1/ 2/ 3/ 4
CH1	
Violating	F 3 STOP / STOP+ / Continue / Cont.+
Stop	
Go-NoGo	F 4 On/ Off
Off	
Ratio:	F 5
0	
0	

Go to Go-NoGo template menu

F1

Select Go-NoGo source channel

F2 ↩

Select violating condition

F3 ↩

Start/Stop Go-NoGo test

F4 ↩

Clear no Go-NoGo test result

F5

Utility key (6/11)

Go-NoGo Template

Utility

Template	F 1 Max/ Min/Auto
Max	(Max/Min template)
Source	F 2 Max: Ref A/ W1~20
RefA	Min: Ref B/ W1~20
Source	F 2 (Auto template)
CH1	CH1/ 2/ 3/ 4
Position	F 3 (Max/Min template)
3.00 Div	-12Div ~ +12Div
Tolerance	F 3 (Auto template)
0.4%	0.4% ~ 40%
Save & Create	F 4 0.04div ~ 4.0div
Previous Menu	F 5

Select template

F1 ↩

Select template source

F2 ↩ → VAR

Select template position or tolerance

F3 ↩ → VAR

Save and create template

F4

Go to previous menu

F5

Utility key (7/11)

Utility

UTILITY

ProbeComp
Menu

F 1 → To Probe menu

Time Set
Menu

F 2 → To Time set menu

Data
Logging

F 3 → To Data logging menu

More

F 5 ←————→

Go to Probe Compensation menu

F1

Go to Time Set menu

F2

Go to other menu

F5 ←



Utility key (8/11)

Probe compensation

Utility

ProbeComp

Wave Type

F 1 —  /  / 

Frequency
1 K

F 2 — ( only)
1k ~ 100k

Duty Cycle
50%

F 3 — ( only)
5% ~ 95%

Default
1k

F 4

Previous
Menu

F 5

Select probe compensation signal

F1 ←

Set frequency for square wave

F2 → VAR 

Set duty cycle for square wave

F3 → VAR 

Default compensation signal frequency

F4

Go to previous menu

F5

Utility key (9/11)

Time set

Utility

TIME SET	
Date	F 1
Time	F 1
Day	F 2
Hour	F 2
Save	F 4
Previous Menu	F 5

(Day/Month/Year)
Day: 1 ~ 31
Year: 2000 ~ 2037
Month: 1 ~ 12

(Hour/Minute)
Hour: 0 ~ 23
Minute: 0 ~ 59

Select date/time setting

F1 ↵

Select day/month/year

F2 ↵ → VAR ⦿

Select hour/minute

F2 ↵ → VAR ⦿

Save date/time setting

F4

Go to previous menu

F5

Utility key (10/11)

Data logging

Utility

TIME SET	
Data log	F 1
Source	F 2
Setup	F 3
File Utilities	F 4
Previous Menu	F 5

CH1/2/3/4/Math

→ To Data logging Setup

→ (USB only)
To File Utilities

Toggle data logging on/off

F1 ↵

Select the source channel.

F2 ↵

Go to the Data Logging Setup menu

F3

Go to File Utilities

F4

Go to previous menu

F5

Utility key (11/11)

Data logging Setup

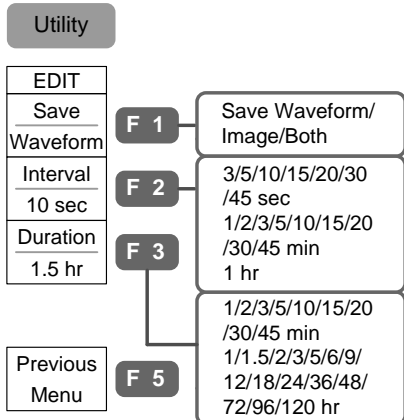

Save waveform/image or both
F1 ↵

Select the interval time between data.

F2 ↵ → VAR ⌚

Select the duration of the data logging
F3 ↵ → VAR ⌚

Go to previous menu

F5

Default Settings

Here is the factory installed panel setting which appears when pressing the Save/Recall key→F1 (Default Setup).

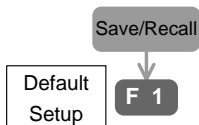

Acquisition	Mode: Normal Hor. Expand: Center	Memory length: 500
Channel	Scale: 2V/Div Coupling: DC BW limit: Off Expand: Ground	CH1: On, CH2/3/4: Off Invert: Off Probe attenuation: x1
Cursor	Source: CH1 Vertical: None	Horizontal: None
Display	Accumulate: Off	Graticule:
Go-NoGo	Go-No: Off Violating: Stop	Source: CH1
Horizontal	Scale: 2.5us/Div	Mode: Main
Math	Type: + (Add) Position: 0.00 Div Math Off	Channel: CH1+CH2 Unit/Div: 2V
Measure	Source1, 2: CH1, CH2	Type: VPP, Avg, Freq, Duty Cycle, Risetime
Program	Mode: Edit	Step: 1
Trigger	Type: Edge Mode: Auto Coupling: DC Noise Rejection: Off	Source: Channel1 Slope:
Utility	Square wave probe, 1k, 50% duty cycle Sound: Off	Hardcopy: save image, ink saver on Interface: USB

Built-in Help

The Help key shows help contents. When a functional key is pressed, simple explanations of its major functionalities appear on the display.

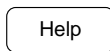

Applicable keys

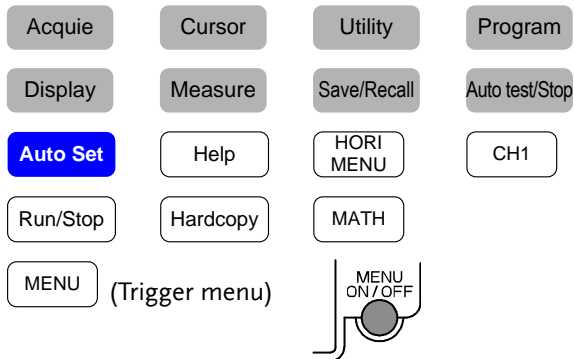

Panel operation

1. Press the Help key. The display changes to Help mode.

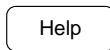

2. Press each key to access its help contents. (example: Acquire key)

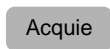

3. Use the Variable knob to scroll the Help contents up and down.

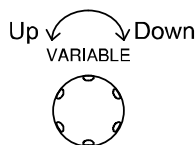

4. Press the Help key again to exit the Help mode.



M EASUREMENT

Basic measurement	Channel activation	53
	Auto Set.....	54
	Run/Stop	55
	Horizontal position/scale	56
	Vertical position/scale	57
	Probe compensation signal.....	58
Automatic measurement	Measurement items	60
	Individual mode.....	62
	Display All mode.....	64
	Gated Measurements	65
Cursor measurement	Use horizontal cursor	67
	Use vertical cursor.....	70
	Toggle cursors on or off.....	72
Math operation	Addition/Subtraction/Multiplication	74
	FFT	76
Go-NoGo test	Edit: Buzzer sound.....	79
	Edit: NoGo when	79
	Edit: Source signal	80
	Edit: Continue or stop after NoGo	80
	Edit: Template (boundary)	81
	Run Go-NoGo test	85

Program	Edit program	88
	Run program	90
<hr/>		
Data Logging	Overview	92
	Edit: Source.....	93
	Edit: Setup Parameters	93
	Run Data logging.....	95

Basic Measurement

This section describes the basic operations required in capturing and viewing the input signal. For detailed operation, see the following chapters.

- Measurements → from page51
- Configurations → from page92

Channel activation

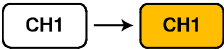
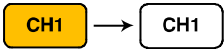
Activate channel	To activate an input channel, press the Channel key. The LED turns On and the input signal waveform appears on the display.	
De-activate channel	To disable the channel, press the Channel key again. If the display menu is different from the Channel menu, press twice (the first press shows the Channel menu).	
Default setup	When the default setup is recalled (Save/Recall key → F1), Channel 1 automatically turns On. Channel 2, 3, and 4 turn Off.	
Auto Set	Auto Set (page54) does NOT automatically activate the channels to which input signals are connected.	

Auto Set

Background Auto Set function automatically configures the panel settings to position the input signal for the best viewing conditions. The GBS-1000 automatically configures the following parameters.

- Horizontal scale
- Vertical scale
- Trigger source channel

Panel operation 1. Connect the input signal to GBS-1000 and press the **Auto Set** key.

2. The waveform appears in the center of the display.



3. To undo Auto Set, press F5 (Undo Autoset).

Limitation Auto Set does not work in the following situation.

- Input signal frequency is less than 20Hz
- Input signal amplitude is less than 30mV

Run/Stop

Background By default, the waveform on the display is constantly updated (Run mode). Freezing the waveform by stopping signal acquisition (Stop mode) allows flexible observation and analysis. To enter the Stop mode, two methods are available: pressing the Run/Stop key or using the Single Trigger mode.

Stop mode icon When in Stop mode, the Stop icon appears at the top of the display.



Freeze waveform by Run/Stop key

1. Press the Run/Stop key once. The waveform and signal acquisition freezes. To unfreeze, press the Run/Stop key again.

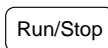

Freeze waveform by Single Trigger mode

2. In the Single Trigger mode, the waveform always stays in the Stop mode, and is updated only when the Run/Stop key is pressed. For details, see page124. Note: pressing the Run/Stop key only updates the waveform once - it does not switch to Run mode (continuous update).

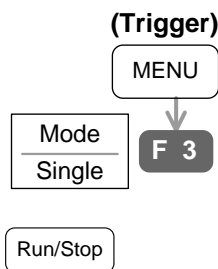

Waveform operation

The waveform can be moved or scaled in both Run and Stop mode, but in different manners. For details, see page108 (Horizontal position/scale) and page118 (Vertical position/scale).

Horizontal position/scale

For detailed configuration, see page108.

Set horizontal position

The horizontal position knob moves the waveform left/right. As the waveform moves, the memory bar appears on the top of the display, indicating the portion of the displayed waveform that is in memory.

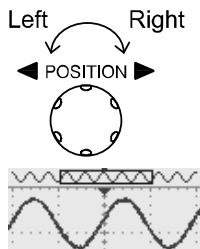

Stop mode In the Stop mode, the memory bar moves along with the waveform until it reaches the end of the memory.

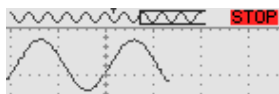

Select horizontal scale

To select the timebase (scale), turn the TIME/DIV knob; left (slow) or right (fast).

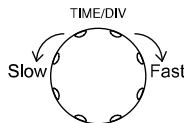

Range 1ns/Div ~ 10s/Div, 1-2-5 increment

The corresponding sampling rate appears on the upper side of the display. The timebase indicator appears on the lower side.

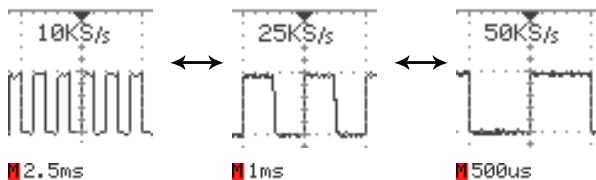

Stop mode In the Stop mode, the memory bar and waveform size changes according to the scale.

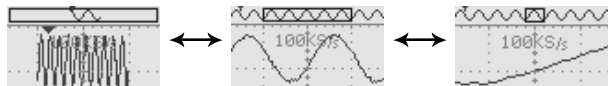

Vertical position/scale

For more detailed configuration, see page118.

Set vertical position

To move the waveform up or down, turn the vertical position knob for each channel.

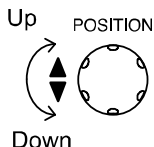

As the waveform moves, the vertical position of the cursor appears at the bottom left corner of the display.

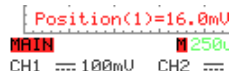

Run/Stop mode

The waveform can be moved vertically in both Run and Stop mode.

Select vertical scale

To change the vertical scale, turn the VOLTS/DIV knob; left (down) or right (up).

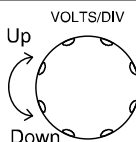

Range 2mV/Div ~ 5V/Div, 1-2-5 increment

The vertical scale indicator for each channel on the bottom left of the display changes accordingly.

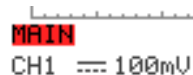

Stop mode

In Stop mode, the vertical scale setting can be changed but the shape of the waveform does not change until the next acquisition.

Probe compensation signal

Background

This section introduces how to use the probe compensation signal for general usage, in case the DUT signal is not available. For probe compensation details, see page172.

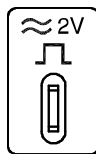

Note that the frequency accuracy and duty factor are not guaranteed. Therefore the signal should not be used for reference purpose.

Waveform type



Square waveform for probe compensation. 1k ~ 100kHz, 5% ~ 95%.



Demonstration signal to show the effect of peak detection. See page99 for peak detection mode details.



Demonstration signal to show the effect of long memory. See page101 for memory length details.

View compensation waveform

1. Connect the probe between the compensation signal output and Channel input.

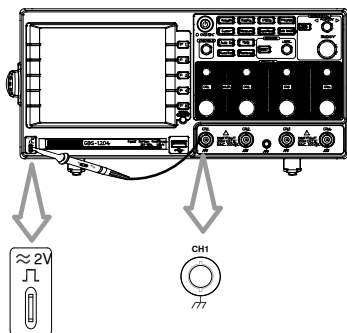

2. Press the Utility key.



3. Press F5 (More) twice.



4. Press F1 (Probe Comp. Menu).



5. Press F1 (Wave type) repeatedly to select the wave type.



6. (For square wave  only) To change the frequency, press F2 (Frequency) and use the Variable knob.

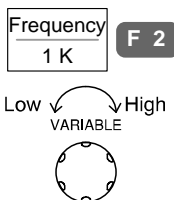

Range 1kHz ~ 100kHz

7. (For square wave  only) To change the duty cycle, press F3 (Duty Cycle) and use the Variable knob.

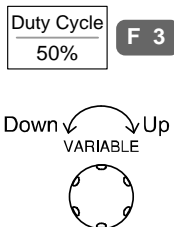

Range 5% ~ 95%

Probe compensation

For probe compensation details, see page172.







Automatic Measurement







Automatic measurement function measures and updates major items for Voltage, Time, and Delay type.



Measurement items







Overview	Voltage type	Time type	Delay type
	Vpp	Frequency	FRR
	Vmax	Period	FRF
	Vmin	RiseTime	FFR
	Vamp	FallTime	FFF
	Vhi	+Width	LRR
	Vlo	-Width	LRF
	Vavg	Dutycycle	LFR
	Vrms		LFF
	ROVShoot		
	FOVShoot		
	RPREShoot		
	FPREShoot		

Voltage measurement	Vpp		Difference between positive and negative peak voltage (=Vmax - Vmin)
	Vmax		Positive peak voltage
	Vmin		Negative peak voltage
	Vamp		Difference between global high and global low voltage (=Vhi - Vlo)
	Vhi		Global high voltage
	Vlo		Global low voltage

	Vavg		Averaged voltage of the first cycle
	Vrms		RMS (root mean square) voltage
	ROVShoot		Rise overshoot voltage
	FOVShoot		Fall overshoot voltage
	RPREShoot		Rise preshoot voltage
	FPREShoot		Fall preshoot voltage

Time measurement	Freq		Frequency of the waveform
	Period		Waveform cycle time (=1/Freq)
	Risetime		Rising time of the pulse (~90%)
	Falltime		Falling time of the pulse (~10%)
	+Width		Positive pulse width
	-Width		Negative pulse width
	Duty Cycle		Ratio of signal pulse compared with whole cycle =100x (Pulse Width/Cycle)

Delay measurement	FRR		Time between: Source 1 first rising edge and Source 2 first rising edge
	FRF		Time between: Source 1 first rising edge and Source 2 first falling edge

FFR		Time between: Source 1 first falling edge and Source 2 first rising edge
FFF		Time between: Source 1 first falling edge and Source 2 first falling edge
LRR		Time between: Source 1 first rising edge and Source 2 last rising edge
LRF		Time between: Source 1 first rising edge and Source 2 last falling edge
LFR		Time between: Source 1 first falling edge and Source 2 last rising edge
LFF		Time between: Source 1 first falling edge and Source 2 last falling edge

Individual mode

Individual mode shows five selected measurement items, two channels each, on the menu bar.

View
measurement
result

1. Press the Measure key. Measure
2. The measurement results for two selected channels appear on the menu bar, constantly updated. Press F1 ~ F5 to change the measurement item.

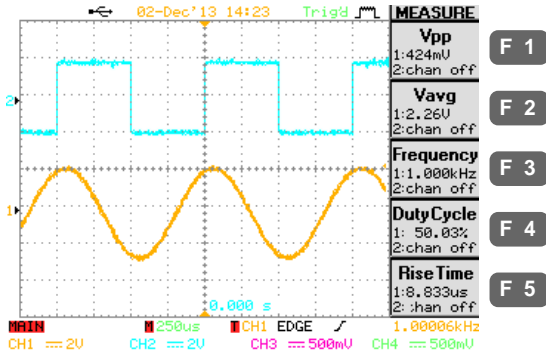

Select measurement item

- The selection menu appears. Press F1 (Source 1) repeatedly to select the first source channel.

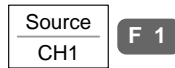

- Press F2 (Source 2) repeatedly to select the second source channel.

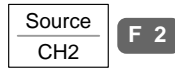

- Press F3 repeatedly to select the measurement type: Voltage, Time, and Delay.



- Use the Variable knob or press F4 repeatedly to select the measurement item.

VARIABLE

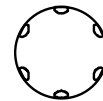

- Press F5 (Previous Menu) to confirm the item selection and to go back to the measurement results view.



View Automatic Measurements – Menu Off

Pressing the Menu ON/OFF key (when in the Measure menu) will superimpose the automatic measurement on the grid.

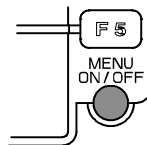

Menu On

Menu Off

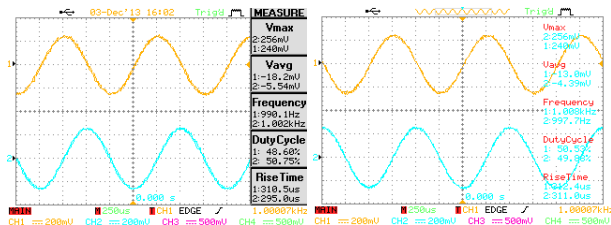

Display All mode

Display All mode shows and updates all items from Voltage and Time type measurement.

View measurement result

1. Press the Measure key twice.

Measure

Measure

2. Press the channel for which the measurement results need to be observed.

CH1

F 1

3. The results of Voltage and Time type measurements appear on the display.

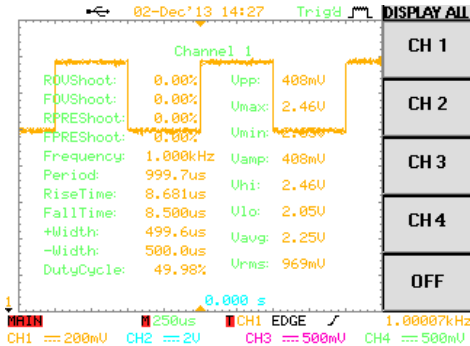

4. Press F5 (OFF) to clear the measurement results from the display.



Delay type Delay type measurement is not available in this mode. Use the Individual measurement mode (page62) instead.

Gated Measurements

Background Automatic measurements can be restricted to a specific area (gating). When cursors are turned on, the area between the cursors is used for automatic measurements (Individual and Display All mode). When cursors are turned off, measurements are derived from all the points that are displayed on screen (default mode).

- Turn gating on
1. Turn cursors on to enable gated measurement. Page 67

Set the cursors to a specific area to create the gated measurement region.

2. Turn on either Individual mode or Display All mode
 Individual: Page 62
 Display All: Page 64
 measurement.

3. The measurement results will now be restricted to the gated area, defined by the cursors.

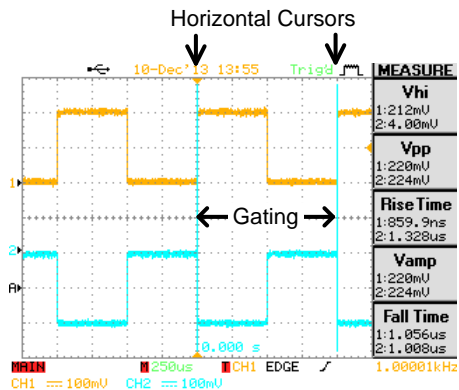

Turn off gated measurement

Turn off the cursors to turn off gated measurements. Page 72

Cursor Measurement

Cursor line, horizontal or vertical, shows the position and value of the waveform and math operation result.

Use horizontal cursor

Panel operation/
Range

1. Press the Cursor key.

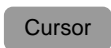

2. Press F1 (Source) repeatedly to select the source channel.

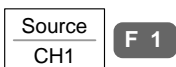

Range CH1, 2, 3, 4, Math

3. Press F2 (Horizontal) repeatedly to activate the horizontal cursor.



Range

- | | |
|-----|--|
| ⋮ ⋮ | Horizontal cursor not activated |
| ⋮ | Left cursor movable, right cursor position fixed |
| ⋮ | Right cursor movable, left cursor position fixed |
| | Left and right cursor movable together |

4. The cursor position information appears on the F4 and F5 menu.

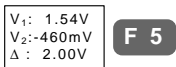
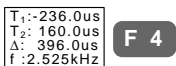

Parameter

- T₁ Time position of the left cursor
- T₂ Time position of the right cursor
- Δ The time distance between the left and right cursor
- f The time distance (Δ) converted to frequency
- V₁ Voltage level of the left cursor*
- V₂ Voltage level of the right cursor*
- Δ The voltage difference between the left and right cursor*

*Note: The horizontal voltage cursors are overridden by the vertical cursors when the vertical cursors are activated.

5. Use the Variable knob to move the cursor left or right. The F4, F5 content changes accordingly.

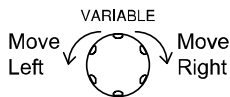

Example

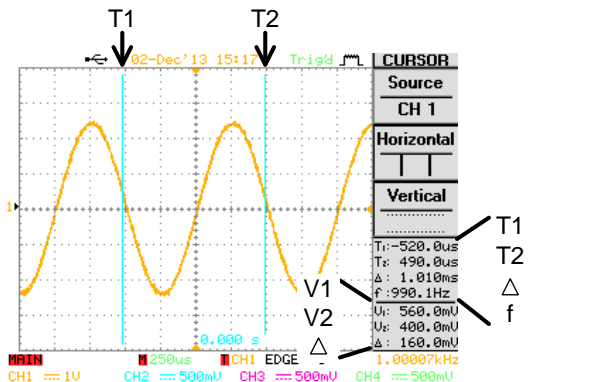

FFT Math

The FFT Math has different F4 content. For FFT math details, see page76.

f₁:29.00kHz
f₂:78.50kHz
Δ:49.50kHz
Div:12.5kHz

F 4

- f₁ Frequency position of the left cursor
- f₂ Frequency position of the right cursor
- Δ The frequency distance between the left and right cursor
- Div The frequency distance per horizontal division

XY Mode

The horizontal cursor can be used in XY mode for the X1 axis. For XY mode details, see page115.

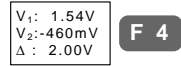

- V₁ Voltage level of the left cursor.
- V₂ Voltage level of the right cursor.
- Δ The voltage difference between the left and right cursor.

View Cursor Measurements - Menu Off

When in the Cursor menu, pressing the Menu ON/OFF key will superimpose the cursor measurements onto the grid.

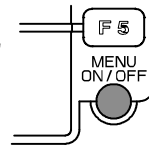

Menu On

Menu Off

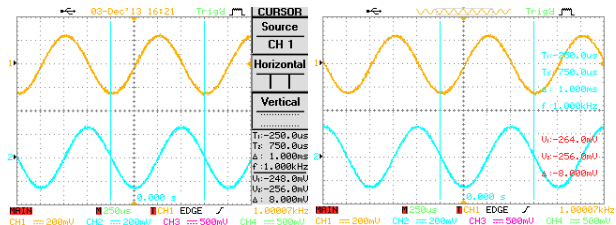

Use vertical cursor

Panel operation/
Range

1. Press the Cursor key.

Cursor

2. Press F1 (Source) repeatedly to select the source channel.

Source
CH1

F 1

Range CH1, 2, 3, 4, Math

3. Press F2 (Vertical) repeatedly to activate the vertical cursor.

Vertical
.....
.....

F 3

Range

.....

Vertical cursor not activated

=====

Upper cursor movable, lower cursor position fixed

Lower cursor movable, upper cursor position fixed

=====

Upper and lower cursor movable together

4. The cursor position information appears on F5 menu.

V₁: 1.54V
V₂: -460mV
Δ: 2.00V

F 5

Parameter

V₁ Voltage level of the upper cursor

V₂ Voltage level of the lower cursor

Δ The voltage difference between the upper and lower cursor

- Use the Variable knob to move the cursor up or down. The F5 content changes accordingly.

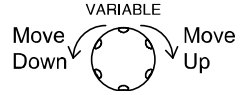

Example

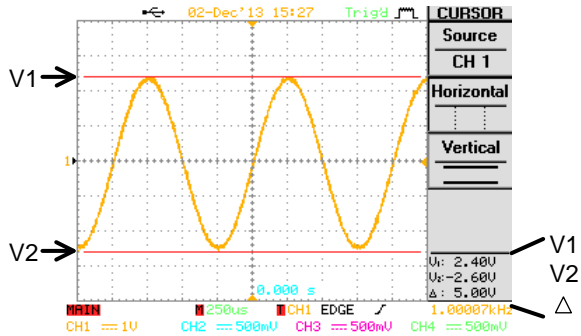

Note: FFT Math

The FFT Math has different F5 content. For FFT math details, see page 76.

M ₁ : 83.6 dB	F 5
M ₂ : 3.66 dB	
Δ: 80.0 dB	

- M₁ Magnitude of the left cursor
- M₂ Magnitude of the right cursor
- Δ The frequency distance between the left and right cursor

View Cursor Measurements - Menu Off

When in the Cursor menu, pressing the Menu ON/OFF key will superimpose the cursor measurement on the grid.

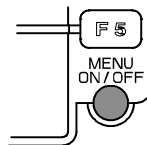

Menu On

Menu Off

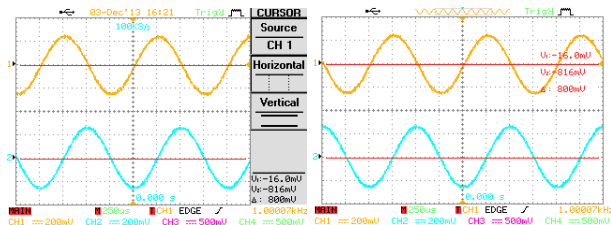

Toggle cursors on or off

- Panel operation
1. Press the Cursor key to toggle the both the horizontal and vertical cursors on or off.

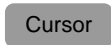

Math Operation

Overview

Background	Math operation runs addition, subtraction, multiplication, or FFT using the input signals and shows the result on the display. The resulted waveform characteristics can be measured using the cursors.	
Addition (+)	Adds amplitude of two signals.	
	Channel pairs	Channel 1 + 2, 3 + 4
Subtraction (-)	Extracts the amplitude difference between two signals.	
	Channel pairs	Channel 1 - 2, 3 - 4
Multiplication (*)	Multiplies amplitude of two signals.	
	Channel pairs	Channel 1 * 2, 3 * 4
FFT	Runs FFT calculation on a signal. Four types of FFT windows are available: Hanning, Flattop, Rectangular, and Blackman.	
	Channel	Channel 1, 2, 3, 4
FFT rms	Runs FFT rms calculation on a signal. Four types of FFT windows are available: Hanning, Flattop, Rectangular, and Blackman.	
	Channel	Channel 1, 2, 3, 4
Hanning FFT window	Frequency resolution	Good
	Amplitude resolution	Not good
	Suitable for...	Frequency measurement on periodic waveform

Flattop FFT window	Frequency resolution	Not good
	Amplitude resolution	Good
	Suitable for...	Amplitude measurement on periodic waveform
Rectangular FFT window	Frequency resolution	Very good
	Amplitude resolution	Bad
	Suitable for...	Single-shot phenomenon (this mode is the same as having no window at all)
Blackman FFT window	Frequency resolution	Bad
	Amplitude resolution	Very good
	Suitable for...	Amplitude measurement on periodic waveform

Addition/Subtraction/Multiplication

- Panel operation
1. Activate the channel pairs: CH1&2, 3&4

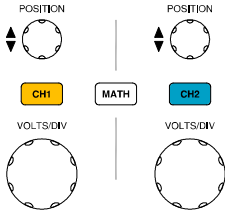
 2. Press the Math key.



 3. Press F1 (Operation) repeatedly to select addition (+), subtraction (-), or multiplication (x).

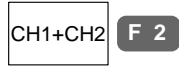

4. Press F2 repeatedly to select the channel pairs, 1&2 or 3&4.

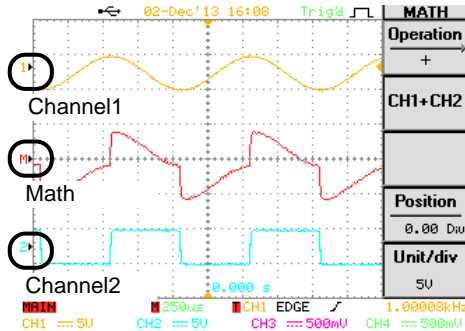

5. The math measurement result appears on the display. The vertical scale (fixed) of math waveform appears in F5 (Unit/div).



6. To move the math waveform vertically, press F4 (Position) and use the Variable knob.

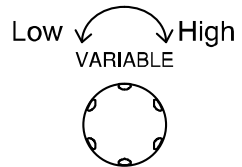

7. To clear the math result from the display, press the Math key again.



FFT/FFT rms

- Panel operation
1. Press the Math key. MATH
 2. Press F1 (Operation) repeatedly to select FFT or FFT rms. Operation
FFT F 1
 3. Press F2 repeatedly to select the source channel. Source
CH1 F 2
 4. Press F3 repeatedly to select the FFT window type. Window
Hanning F 3
 5. The FFT/FFT rms result appears. For FFT, the horizontal scale changes from time to frequency, and the vertical scale from voltage to dB. For FFT rms, the horizontal scale changes from time to frequency.

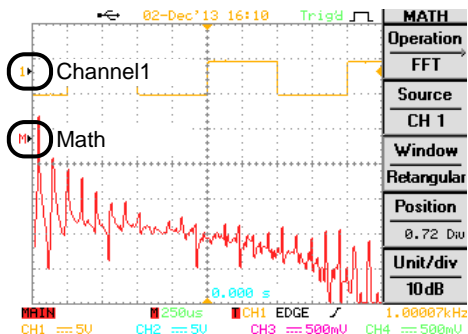

6. To move the FFT/FFT rms waveform vertically, press F4 (Position) and use the Variable knob.

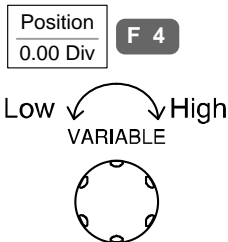

Range -12.00 Div ~ +12.00 Div

7. To select the vertical scale of FFT: FFT waveform, press F5 (Unit/Div) repeatedly.



To select the vertical scale of FFT rms: the FFT rms waveform, use the VOLTS/DIV knob of the selected source channel.

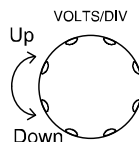

Range 1, 2, 5, 10, 20 dB/Div
RMS Voltage

8. To clear the FFT/FFT rms result from the display, press the Math key again.



Go-NoGo Test

Overview

Background The Go-NoGo test checks if a waveform fits inside a user-specified maximum and minimum amplitude boundary (template). The test result is communicated in three ways: the display (menu contents), buzzer sound, and pulse signal output from the rear panel terminal.

Test parameters	item	default setting	setup details
	Buzzer sound when the test fails (NoGo)	Off	page79
	NoGo criteria: in or out of the boundary	Out	page79
	Test signal	Channel 1	page80
	Test continue or stop when NoGo occurs	Stop	page80
	Boundary (template) – select minimum and maximum as separate waveforms or create both boundaries from a single waveform	Min/Max separately	page81

Default setting To recall the default setting, press the Save/Recall key, then press F1 (Default Setup). See page49 for details.

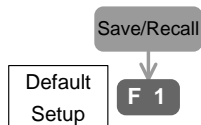

Edit: Buzzer sound

Panel operation

1. Press the Utility key.

Utility

2. Press F3 repeatedly to select the buzzer for a test fail (NoGo) notification.

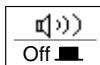

F 3

 High pitch

 Middle pitch

 Low pitch

Off  Sound Off

Note

The buzzer setting also affects the vertical resolution calibration (page171) – the buzzer notifies the completion of calibration.

Edit: NoGo when

1. Press the Utility key.

Utility

2. Press F5 (More).

More

F 5

3. Press F4 (NoGo When) repeatedly to select the NoGo condition.

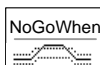

F 4

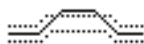



NoGo when the waveform is outside of the boundary





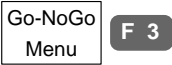
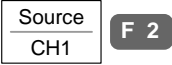

NoGo when the waveform is inside the boundary

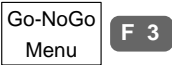

Edit: Source signal

1. Press the Utility key. 
2. Press F5 (More). 
3. Press F3 (Go-NoGo Menu). 
4. Press F2 (Source) repeatedly to select the channel to be tested. (Note: the selected channel is automatically activated) 

Edit: Continue or stop after NoGo

1. Press the Utility key. 
2. Press F5 (More). 
3. Press F3 (Go-NoGo Menu). 
4. Press F3 (Violating) repeatedly to select whether to continue or stop the test after the NoGo condition is met. 

<p>Stop</p>	<p>The test stops when the NoGo condition is met. The buzzer does not sound.</p>
-------------	--

Stop+ 	The test stops and the buzzer sounds when the NoGo condition is met.
Continue	The test continues even when the NoGo condition is met. The buzzer does not sound.
Continue+ 	The test continues even when the NoGo condition is met. The buzzer also sounds.

Note If the sound is turned Off in the buzzer setting (page79), the sound is not produced even when selecting Stop/Continue+.

Edit: Template (boundary)

Background The NoGo template sets the upper and lower amplitude boundary. Two methods are available: Min/Max and Auto.

Min/Max Selects the upper boundary (Max) and lower boundary (Min) as separate waveforms, from the internal memory.









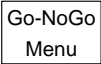

Advantage: The template shape and the distance (allowance) between the source signal are fully customizable.

Disadvantage: The waveforms (templates) have to be stored internally prior to this selection.

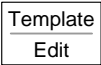
Auto Creates the upper and lower boundary from an input signal, not from an internally stored waveform.

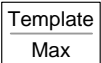
Advantage: No need to store the waveforms prior to this selection.

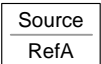
Disadvantage: The template shape is proportional to the source signal. The distance (allowance) between the source signal and upper/lower template are always symmetrical.

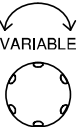
- Min/Max setting**
1. Make sure the source signal, on which the templates are based, appears on the display.
 2. Press the Utility key. 
 3. Press F5 (More).  
 4. Press F3 (Go-NoGo Menu).  
 5. Press F1 (Template Edit).  
 6. Press F1 (Template) repeatedly to select the upper (Max) or lower (Min) boundary template.  
 7. Press F2 (Source). Use the Variable knob to select the template from an internally stored waveform. For the waveform store procedure, see page147.  

- Max (marked as waveform "A" in the display) Maximum boundary: RefA, W1 ~ 20 internal memory
- Min (marked as waveform "B" in the display) Minimum boundary: RefB, W1 ~ 20 internal memory

8. Press F3 (Position). Use the Variable knob to move the waveform amplitude level.

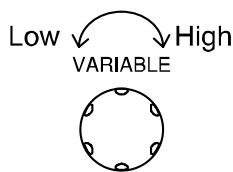

9. Repeat step 6, 7, 8 for the other template setting, Min or Max.



10. When the templates are set, press F4 (Save & Create) to save them.

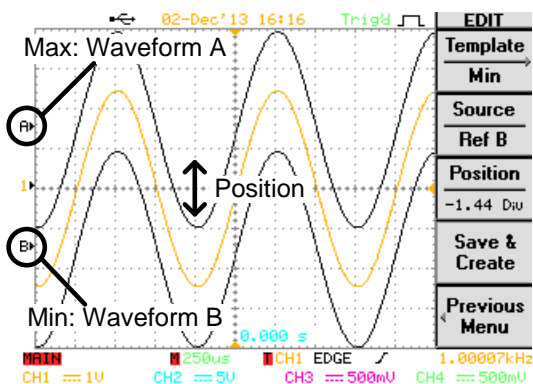

Auto setting

1. Make sure the source signal, on which the templates are based, appears on the display.

2. Press the Utility key.



3. Press F5 (More).



4. Press F3 (Go-NoGo Menu).



5. Press F1 (Template Edit).



6. Press F1 repeatedly to Auto position.



7. Press F2 repeatedly to select the signal channel on which the template is created.

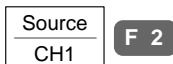

8. The template appears on the screen as waveform A (maximum) and waveform B (minimum). Use the Variable knob to set the tolerance range. The template in the display changes accordingly.

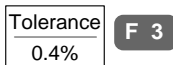
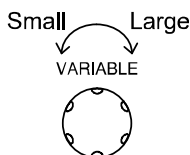

9. If necessary, press F3 (tolerance) repeatedly to select the tolerance unit: percentage (%) or division (div).



10. When the templates are set, press F4 (Save & Create) to save it.

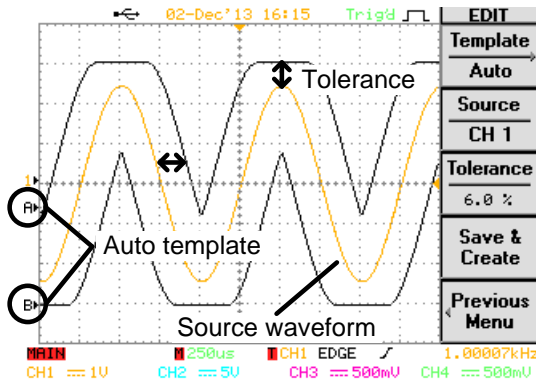

Run Go-NoGo test

This section assumes all Go-NoGo settings (page78) are completed.

Panel operation

1. Press the Utility key.



2. Press F5 (More).



3. Press F3 (Go-NoGo Menu).



4. Make sure the source signal and the templates (boundary) both appear on the display.

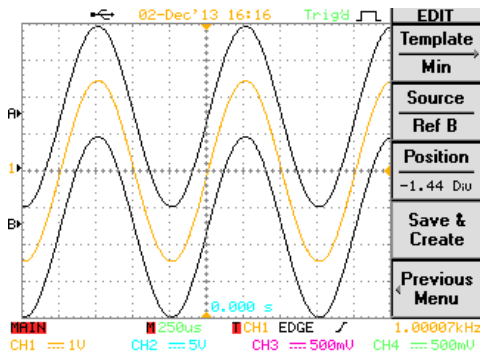

- Press F4 (Go-NoGo). The Go-NoGo test starts running and stops according to the continue/stop condition (page80). To stop the test manually, Press F4 again.



- The test results appear in the F5 menu. The denominator (lower side) shows the number of completed tests. The numerator (upper side) shows the number of failed tests (NoGo).

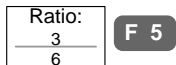

Pressing F5 will also clear the test results from the icon.

- The Go/NoGo terminal (open collector) on the rear panel sends out a 5Vpp, 10us pulse signal to an external device every time the NoGo condition is met.

GO / NO GO
(Open collector)

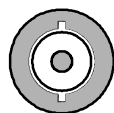

Program

Overview

Background The Program function measures input signals using cursors or automatic measurement functions, with a user-defined sequence, duration, loop count, and panel settings. This feature is useful for automated and repetitive measurement, such as in assembly lines or quality inspection tests.

Parameter	Program set	1 set
	Program step	Maximum 20 steps
	Measurement item	Cursor or Automatic measurement
	Time (duration) per step	1 ~ 99 seconds, or user activation
	Program loop	1 ~ 99 loops, the first and last step settable

- Programming step**
1. Show the target waveform on the display and decide the type of measurement that needs to be done: Horizontal/Vertical Cursor or Automatic measurement.
 2. Setup the other panel configurations: trigger, acquisition, horizontal/vertical scale, etc. Save the settings to the internal memory. See page146 for details.
 3. Edit the program (page88) using the internally stored panel setup.
 4. Run the program (page90).

Edit program

This section assumes that the panel setting is already defined and saved (step 1 and 2 in the previous page).

- Panel operation
1. Press the Program key. The display changes into program edit mode.

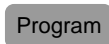

2. Press F1 (Edit/Play) to select the Edit side.

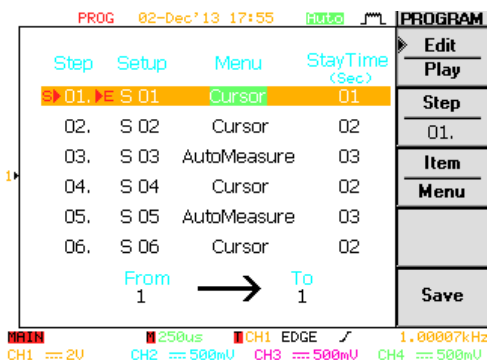

3. Press F2 (Step). Use the Variable knob to select the step that needs to be edited. The cursor on the display moves accordingly.

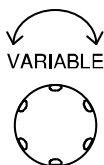
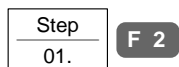

4. Press F3 (Item) repeatedly to select the three parameters for a step: panel setup, menu (Cursor or Automatic measurement), and time.



Use the variable knob to edit the valued of the selected item.



- | | |
|-------|--|
| Setup | Selects the panel setup stored in the internal memory. S01 ~ S20. For panel setup store/recall details, see page146 (save) or page157 (recall). |
| Menu | Selects the measured item: Cursor or Automatic measurement. |
| Time | Sets the duration of the step, 1 ~ 99 seconds or user control (Run/Stop). When Run/Stop is selected, the program freezes at that step until the user presses the Run/Stop key. |

5. Continue the above for all program steps. When completed, press F5 (Save) to confirm and save the program.



Run program

This section assumes that the program editing (see previous page) is completed.

Panel operation 1. Press the Program key. The display changes into program mode.

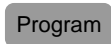

2. Press F1 (Edit/Play) repeatedly to select the Play side.



F 1

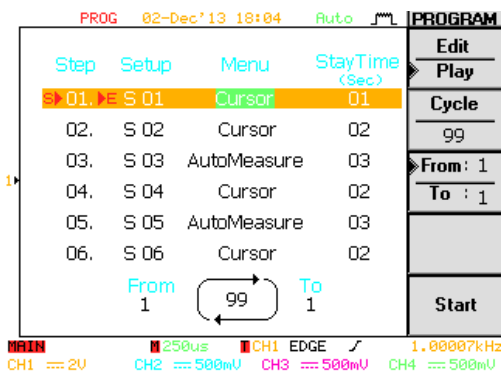

3. Press F2 (Cycle). Use the Variable knob to select the number of program loop: 1 ~ 99.

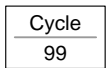

F 2

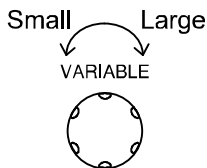

4. Press F3 (From/To) to select the From: side. Use the Variable knob to select the program start step: 1 ~ 20. The "S" mark appears in the selected step.

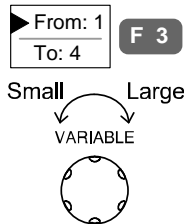

➔ 01. S 01 Cursor Run/Stop

5. Press F3 (From/To) to select the To: side. Use the Variable knob to select the program end step: 1 ~ 20. Note that the To: step must be larger or equal to the From: step. The "E" mark appears in the selected step.

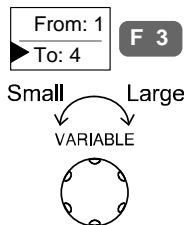

04. E S 04 AutoMeasure 99

6. Press F5 (Start). The display changes into program running mode and starts executing the first step.



7. The message "Press Run/Stop key to continue" on the bottom of the display shows that the user has to activate the next step manually. Press the Run/Stop key to move to the next step.

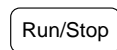

8. To stop the program manually, press the Auto test/Stop key. When all steps are completed, the program stops running.

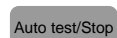



Data Logging

Overview

Background	<p>The Data logging function allows you to log data or a screen image over timed intervals for up to 120 hours to a USB flash drive.</p> <p>The data or images are stored to a USB flash drive in a directory named LogXXXX. LogXXXX is incremented each time the data logging function is used.</p> <p>The files saved in the LogXXXX directory are named DSXXXX.CSV, or DSXXXX.BMP for data or image files, respectively. At each timed interval, data or an image file is saved and the file number incremented. For example, DS0000 is the first logged data, DS0001 is the second and so on.</p>
------------	---

Edit: Source

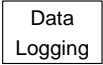
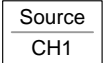
- | | | |
|-----------|---|---|
| Procedure | 1. Press the Utility key. |  |
| | 2. Press F5 (More) twice. |  F 5 x2 |
| | 3. Press F3 (Data Logging). |  F 3 |
| | 4. Press F2 (Source) repeatedly to select the source channel (CH1/2/3/4 or math). |  F 2 |

Edit: Setup Parameters

Background The type of data that will be logged (waveform/image/both), the capture interval time and the duration of the data logging must first be set before logging function can be used.

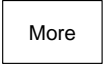
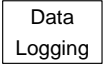
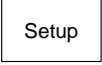
- | | | |
|-----------|-----------------------------|---|
| Procedure | 1. Press the Utility key. |  |
| | 2. Press F5 (More) twice. |  F 5 x2 |
| | 3. Press F3 (Data Logging). |  F 3 |
| | 4. Press F3 (Setup). |  F 3 |

5. Press F1 (Save) repeatedly to log waveform data, save screen images or both.



6. Press F2 (Interval) and use the Variable knob to select the interval time.



Interval 3 secs ~ 1 hour
time

Note: The selectable interval times depend on the duration time, see below.

7. Press F3 (Duration) and use the Variable knob to set the duration time.

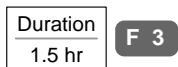

Duration 1 min ~ 120 hours

8. Press F5 (Previous Menu) to return to the Data Logging menu.



Data logging is now ready to begin.

Run Data logging

Background Ensure the data source (page 93) and data logging setup has been set (page 93).

Procedure

1. Insert a USB flash drive into the USB front panel port.

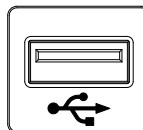

2. Press the Utility key.



3. Press F5 (More) twice.



4. Press F3 (Data Logging).



5. Press F1 (Data Log) to turn data logging On. Data/image files start logging to the USB flash drive automatically. To stop the data logging, press F2 (Data Log) again.



- Each time data/an image is saved, an hour glass timer icon appears over the File Utilities icon (F4).

“Data log completed” will be displayed when data logging has finished, or has been turned off.

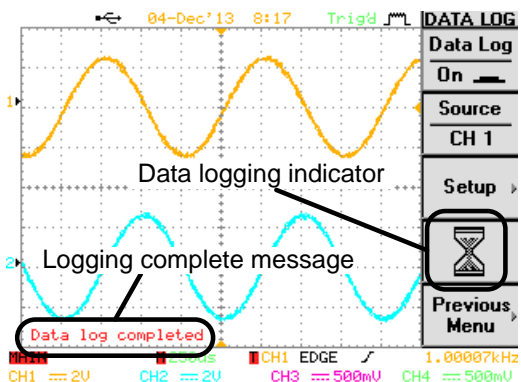

Note The front panel is locked when data logging is activated.

C ONFIGURATION

Acquisition	Select acquisition mode	99
	Select waveform memory length.....	101
	Real time vs Equivalent time sampling mode	103
Display	Select waveform drawing (vector/dot).....	104
	Accumulate waveform	105
	Set display contrast.....	106
	Freeze the waveform	106
	Select display grid.....	107
	Turn Off menu	107
Horizontal	Move waveform position horizontally.....	108
	Select horizontal scale	109
	Set the horizontal expansion mode	110
	Select horizontal scaleSelect waveform update mode	111
	Zoom waveform horizontally.....	114
	Show waveform in X-Y mode	115

Vertical (Channel)	Move waveform position vertically	118
	Select vertical scale	118
	Select coupling mode	119
	Invert waveform vertically	120
	Limit bandwidth	120
	Select probe attenuation level.....	121
	Set the vertical expansion mode	122
<hr/>		
Trigger	Trigger type overview	124
	Trigger parameter overview.....	124
	Use edge trigger	127
	Use video trigger	128
	Use pulse width trigger.....	130
<hr/>		
System	View system information	132
	Select menu language.....	132
	Set date and time	133



Acquisition

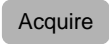

The acquisition process samples the analog input signals and converts them into digital format for internal processing.

Select acquisition mode

Panel operation

1. Press the Acquire key. 
2. Select the acquisition mode from F1 (Normal) ~ F3 (Average). The acquisition icon on the top right corner of the display changes accordingly.

Normal	
Peak Detect	
Average 2	

Range	<p>Normal  All of the acquired data is used to draw the waveform.</p> <p>Peak Detect  Only the minimum and maximum value pairs for each acquisition interval (bucket) are used. This mode is useful for catching abnormal glitches in the signal.</p> <p>Average  Multiple acquired data are averaged. This mode is useful for drawing a noise-free waveform. To select the average number, press F3 repeatedly. Average number: 2, 4, 8, 16, 32, 64, 128, 256</p>
-------	---

Example

Normal

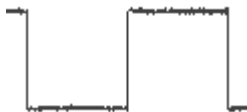

Peak Detect



Average (2 times)



Average (256 times)



Peak detect effect using probe comp. waveform

1. One of the probe compensation waveforms can demonstrate peak detection mode. Connect the probe to the probe compensation output.

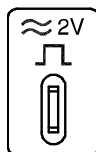

2. Press the Utility key.



3. Press F5 (More) twice.



4. Press F1 (Probe Comp. Menu)

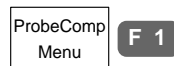

5. Press F1 (Wave Type) and select the square wave waveform.



6. Press the Auto Set key. GBS-1000 positions the waveform in the center of the display.



7. Press the Acquire key.

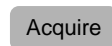

8. Press F2 (Peak Detect) or F1 (Normal) and see that in the Peak detection mode, spike noise is captured.

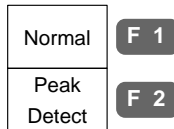

Peak Detect



Normal

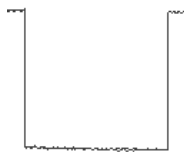

Select waveform memory length

Background

Memory length defines the amount of waveform data (points) included in each trigger event. Two modes are available: short and long.

Short mode Each waveform includes fewer points and is updated rapidly. It is useful for observing the shape of fast-changing waveform such as Frequency Modulation.

Long mode Each waveform includes more points and is updated relatively slowly. It is useful for observing the details of single-shot phenomenon such as spike noise.

Panel operation

1. Press the Acquire key.

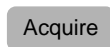

2. Press F5 (Mem Leng) to select the memory length (points), short or long.



Range (memory point)	500	Short memory length; useful for catching high frequency signal.
	5000	Long memory length when three or four channels are active.
	12500	Long memory length when two channels are active.
	25000	Long memory length when only one channel is active.

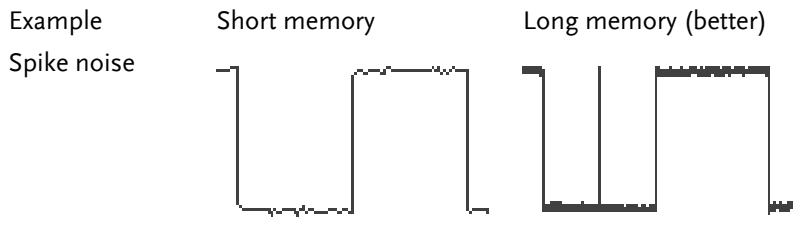
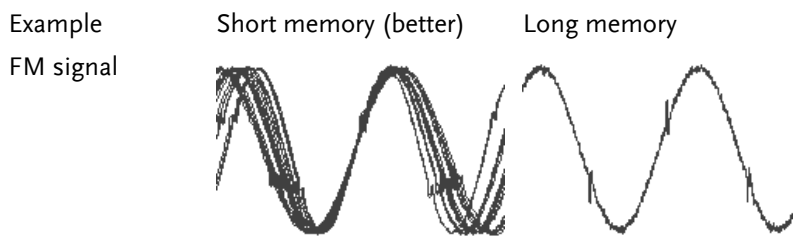

Note The display always shows 250 points (300 when the menu is turned Off) regardless of the memory length. In short memory length, all 500 points can be observed. In long memory length, either the memory points are condensed into 500 points (Real-time sampling mode) or all points can be observed (Equivalent-time sampling mode). For sampling mode details, see page103.

Real time vs Equivalent time sampling mode

Background GBS-1000 automatically switches between two sampling modes, Real-time and Equivalent-time, according to the number of active channels and the sampling rate.

Parameter	Real-time sampling	One-time sampled data is used to reconstruct a single waveform. Short-time events might get lost if the sampling rate gets too high. This mode is used when the sampling rate is relatively low.
	Equivalent-time sampling	Multiple numbers of sampled data are accumulated to reconstruct a single waveform. Restores greater waveform details but takes longer to update the waveform. This mode is used when the sampling rate becomes higher.

Real-time / Equivalent-time sampling threshold

Input channel: ○ Activated
 ✕ Not activated
 — Does not matter

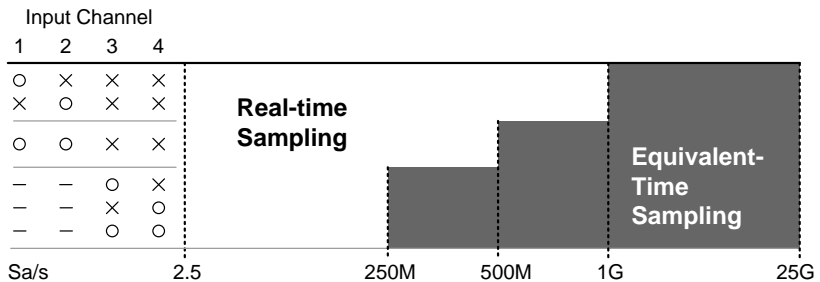

Display

Display menu defines how the waveforms and parameters appear on the main LCD display.

Select waveform drawing (vector/dot)

Panel operation 1. Press the Display key.

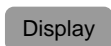

2. Press F1 (Type) repeatedly to select the waveform drawing.



Range	Dots	Only the sampled dots are displayed.
	Vectors	Both the sampled dots and the connecting line are displayed.

Example: Dots (square wave)

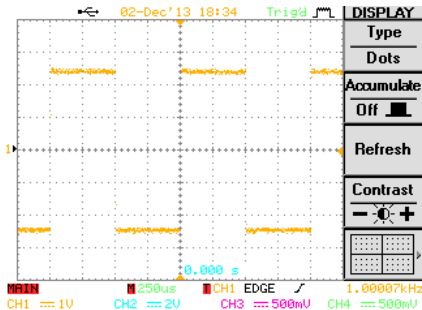

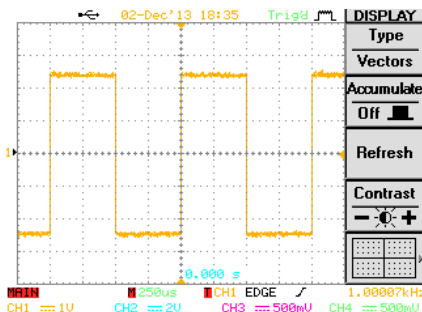

Example: Vectors (square wave)



Accumulate waveform

Background Accumulation preserves the old waveform drawings and overwrites new waveforms on top of it. It is useful for observing waveform variation.

- Panel operation**
1. Press the Display key. 
 2. Press F2 (Accumulate) to turn On waveform accumulation. 
 3. To clear the accumulation and start over (refresh), press F3 (Refresh). 

Example

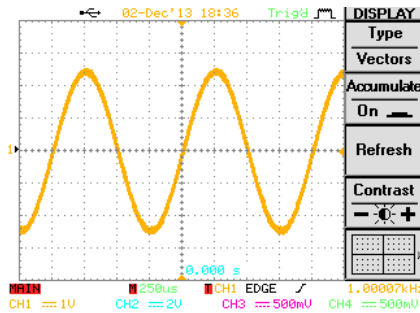

Accumulation On



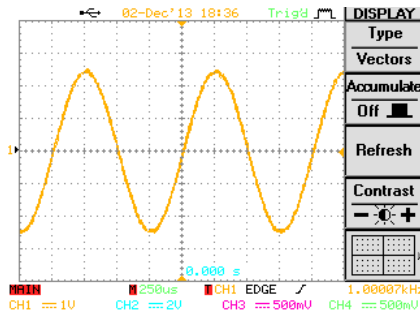

Accumulation Off

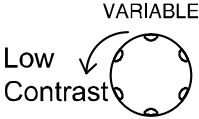

Set display contrast

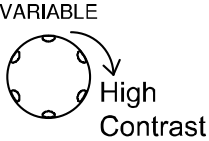

- Panel operation
1. Press the Display key.
 
 2. Press F4 (Contrast).
 
 - 3a. Turn the Variable knob left to lower the contrast (dark display).
 

 - 3b. Turn the Variable knob right to raise the contrast (bright display).
 

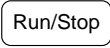

Freeze the waveform (Run/Stop)

For more details about Run/Stop mode, see page55.

- Panel operation
1. Press the Run/Stop key. To unfreeze the waveform, press the Run/Stop key again.
 
 2. The waveform and the trigger freezes. The trigger indicator on the top right of the display shows Stop.
 

Select display grid

Panel operation

1. Press the Display key.



2. Press F5 (Grid type) repeatedly to select the grid.

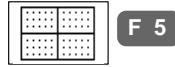

Range



Shows the full grid; X and Y axis for each division.



Shows only the center X and Y frame.



Shows only the outer frame.

Turn Off menu

Panel operation

1. Press the MENU ON/OFF key below F1 ~ F5.

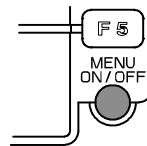

2. The menu disappears. The waveform points changes from 250 to 300.

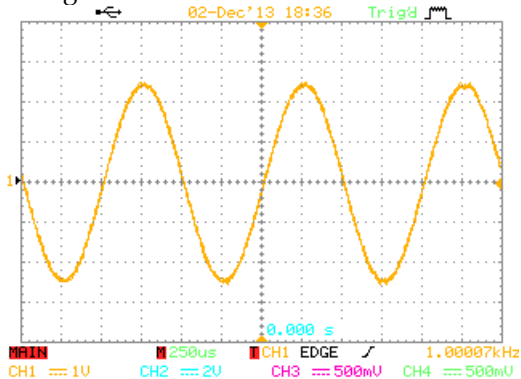

Horizontal View

This section describes how to set the horizontal scale, position, and waveform display mode.

Move waveform position horizontally

Panel operation

The horizontal position knob moves the waveform left/right. As the waveform moves, the memory bar appears on the top of the display indicating the portion of the displayed waveform that is in memory.

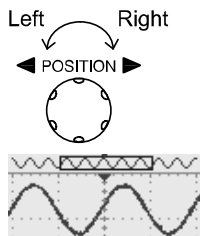

Run mode

In Run mode, the memory bar keeps its relative position in the memory since the entire memory is continuously captured and updated.

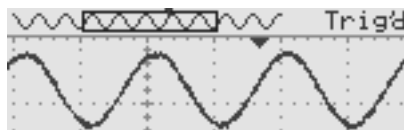

Stop mode

In Stop mode, the memory bar moves along with the waveform until it reaches the end of the memory.

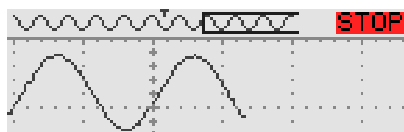

Select horizontal scale

Select horizontal scale To select the timebase (scale), turn the TIME/DIV knob; left (slow) or right (fast).

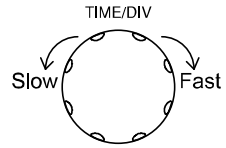

Range 1 ns/Div ~ 10 s/Div, 1-2-5 increment

The corresponding sampling rate appears on the upper side of the display. The timebase indicator appears on the lower side.

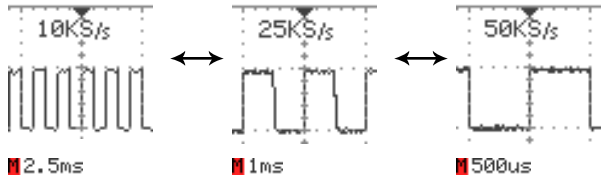

Run mode

In Run mode, the memory bar and waveform size keep their proportion. When the timebase becomes slower, it automatically switches to Scan mode (see the next page).

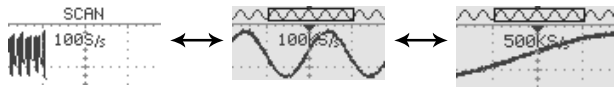

Stop mode

In Stop mode, the memory bar and waveform size changes according to the scale.



Set the horizontal expansion mode

Background The Horizontal Expand function allows you to set how the waveform will scale horizontally with the Time/Div knob.

Center The Center option will scale the waveform from the center of the display.

Trigger The Trigger option will expand the waveform from the trigger point.

Panel operation 1. Press the Acquire key.

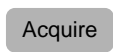

2. Press F4 (Hor. Expand) to select the horizontal expansion mode.



Example Center

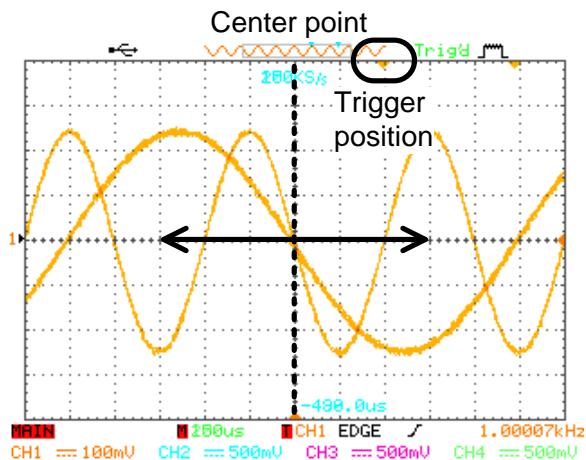

Trigger

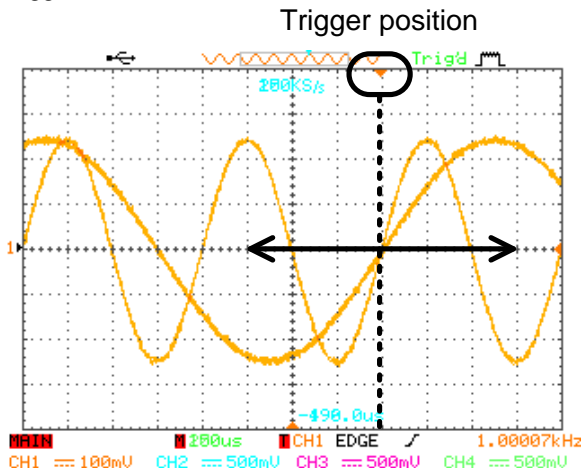

Select waveform update mode

Background

The display update mode is switched automatically or manually according to the timebase and the trigger. The indicator on the bottom left of the display shows the current mode.

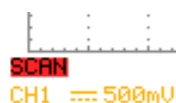

Main mode

MAIN Updates the whole displayed waveform at once. Automatically selected when the timebase (sampling rate) is fast.

Timebase $\leq 50\text{ms}/\text{div}$ ($\geq 500\text{Sa}/\text{s}$)

Trigger all modes

Scan mode

SCAN Updates the waveform gradually from the left side of the display to the right. The waveform position is fixed. Automatically selected when the timebase (sampling rate) is slow.

Timebase $\geq 100\text{ms}/\text{div}$ ($\leq 250\text{Sa}/\text{s}$)

Trigger Auto mode only

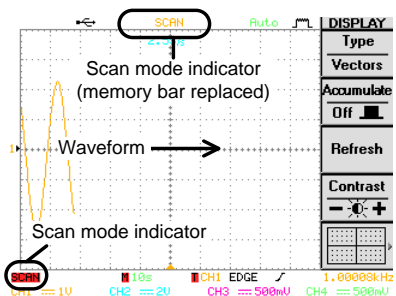

Note

- When the update mode switches from Main to Scan, The GBS-1000 automatically selects the Auto trigger mode. See page124 for trigger details.
- To view the signal peak clearly in Scan mode, turn on the Peak detection (page99).

Roll mode

ROLL Updates and moves the waveform gradually from the right side of the display to the left. Manually selected when the timebase (sampling rate) is slow.

Timebase $\geq 250\text{ms}/\text{div}$ ($\leq 100\text{Sa}/\text{s}$)

Trigger all modes

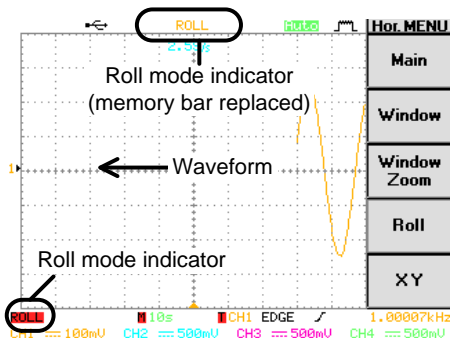

Select Roll mode manually

1. Press the Horizontal menu key.



2. Press F4 (Roll). The waveform starts scrolling from the right side of the display. The update mode indicator shows Roll mode.

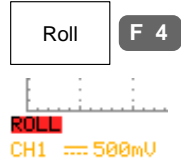

Note

The Roll mode locks the timebase to be at least 250ms/div (100Sa/s). If faster timebase or sampling rate is required, get out of the Roll mode by pressing F1 (Main).

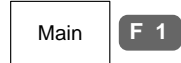

Zoom waveform horizontally

Panel operation/
range

1. Press the Horizontal Menu key.



2. Press F2 (Window) key.



3. The WINDOW indicator, which shows the zoom range, appears on the bottom left corner of the display. Use the horizontal position knob to move the zoom range sideways, and TIME/DIV knob to change the zoom range width.

WINDOW 50us

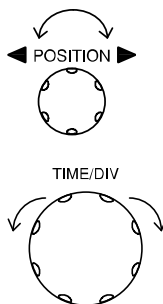

The width of the bar in the middle of the display is the actual zoomed area.

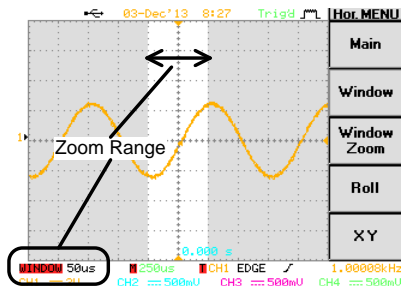

Zoom range 1ns ~ 5s

- Press F3 (Window Zoom). The specified range gets zoomed. The ZOOM indicator appears on the bottom left side of the display.

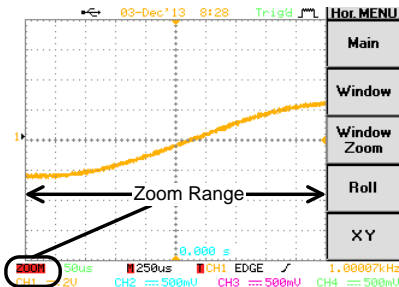
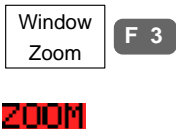

- To go back to the original view, press F1 (Main).



Show waveform in X-Y mode

Background

The X-Y mode compares the voltage of the Channel 1 waveform and the Channel 2, 3 & 4 waveforms in a single display. This mode is useful for observing the phase relationship between two or more channels.

- Panel operation
1. Connect the X-axis signal to Channel 1 (X1-axis) and the Y-axis signal to CH2.

To compare more than one signal to the X-axis, up to 2 more Y-axis signals can be compared by connecting to signals to channels 3 and 4.

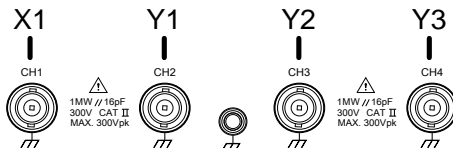

2. Make sure at least one pair of channels are activated (LED On). Press the appropriate Channel key if necessary.

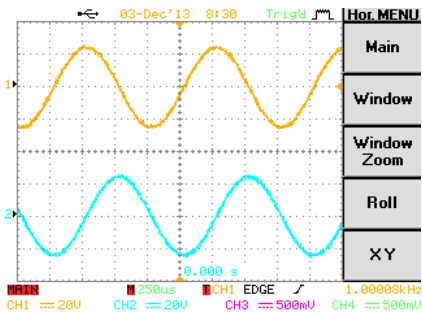

3. Press the Horizontal menu key.



- Press F5 (XY). The display shows up to three waveforms in X-Y format waveforms simultaneously; Channel 1 as X1-axis, Channel 2 as Y1-axis, Channel 3 as the Y2-axis and Channel 4 as the Y3-axis.

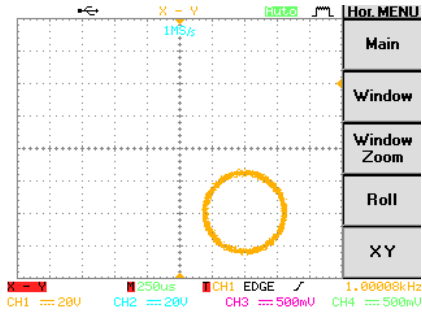

A single X-Y waveform is shown above.

- The Horizontal Position knob and Time/Div knob are disabled under the X-Y mode. To move the waveform position, use the vertical position knobs:

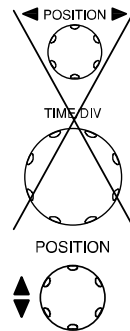

Channel 1 knob moves all the waveforms horizontally.

Channel 2 moves the first vertically.

Channel 3 moves the second waveform vertically.

Channel 4 moves the third waveform vertically.

Vertical View (Channel)

This section describes how to set the vertical scale, position, and coupling mode.

Move waveform position vertically

Panel operation To move the waveform up or down, turn the vertical position knob for each channel.

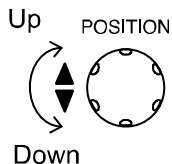

As the waveform moves, the vertical position of the cursor appears at the bottom left corner of the display.

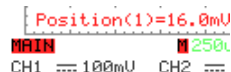

Run/Stop mode The waveform can be moved vertically in both Run and Stop mode.

Select vertical scale

Panel operation To change the vertical scale, turn the VOLTS/DIV knob; left (down) or right (up).

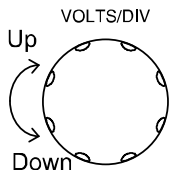

The vertical scale indicator on the bottom left of the display changes accordingly.

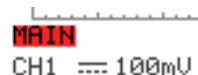

Range 2mV/Div ~ 5V/Div, 1-2-5 increments

Stop mode In Stop mode, the vertical scale setting can be changed but the waveform shape stays the same.

Select coupling mode

Panel operation

1. Press the Channel key.



2. Press F1 (Coupling) repeatedly to select the coupling mode.



Range



DC coupling mode. The whole portion (AC and DC) of the signal appears on the display.



Ground coupling mode. The display shows only the zero voltage level as a horizontal line. This mode is useful for measuring the signal voltage with respect to the ground level.



AC coupling mode. Only the AC portion of the signal appears on the display. This mode is useful for observing AC waveforms mixed with DC signals.

Example

Observing the AC portion of the waveform using AC coupling

DC coupling

AC coupling

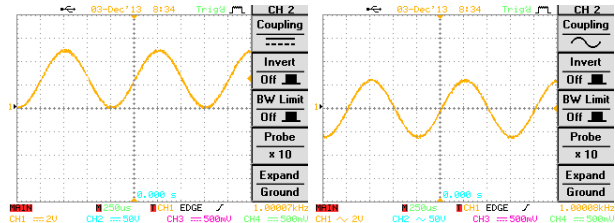

Invert waveform vertically

Panel operation

1. Press the Channel key.



2. Press F2 (Invert) to invert the waveform.



Example

CH2 (below) Invert Off

CH2 (below) Invert On

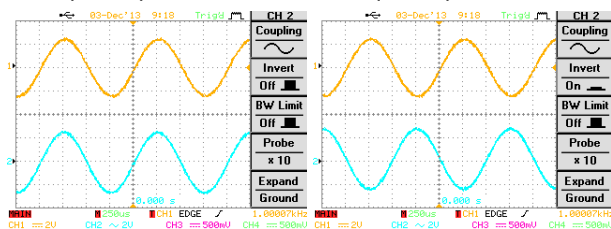

Limit bandwidth

Background

Bandwidth limitation puts the input signal into a 20MHz (-3dB) low-pass filter. This function is useful for cutting off high frequency noise to see the clear waveform shape.

Panel operation

1. Press the Channel key.



2. Press F3 (BW Limit) to turn Off the limitation.



3. The BW icon  appears in the channel indicator at the bottom of the display.

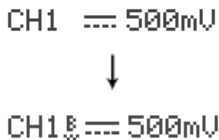

Example

BW Limit Off

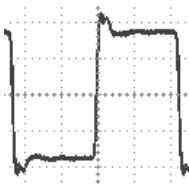

BW Limit On

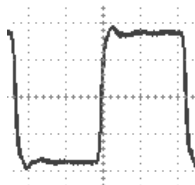

Select probe attenuation level

Background

A signal probe has an attenuation switch to lower the original DUT signal level to the oscilloscope input range, if necessary. The probe attenuation selection adjusts the vertical scale so that the voltage level on the display reflects the real value on DUT.

Panel operation

1. Press the Channel key.



2. Press F4 (Probe) repeatedly to select the attenuation level.



3. The voltage scale in the channel indicator changes accordingly. There is no change in the waveform shape.

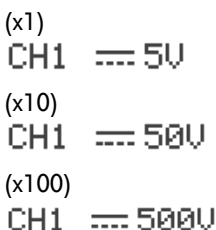

Range



x1, x10, x100

Note

The attenuation factor adds no influence on the real signal. It just changes the voltage scale on the display.

Set the vertical expansion mode

Background	The Expand Ground/Center functions allow you to set where the waveform will scale from when the Volts/Div knob is used to change the vertical scale.
Center	The Center option will scale the waveform from the center of the display. This mode can be useful for signals that have a voltage bias.
Ground	The Ground option will scale the waveform from the ground point.

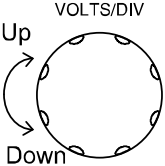
- Panel operation
1. Press a channel key. 
 2. Press F5 (Expand) to select the Center or the Ground expansion mode. This function is channel independent: a different setting can be made for each channel. 
 3. Use the VOLTS/DIV knob to scale the waveform from the ground position or from the center of the display. 

Example

Center

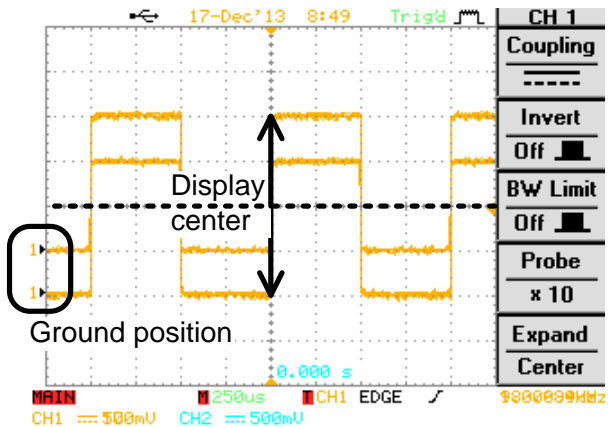

Ground

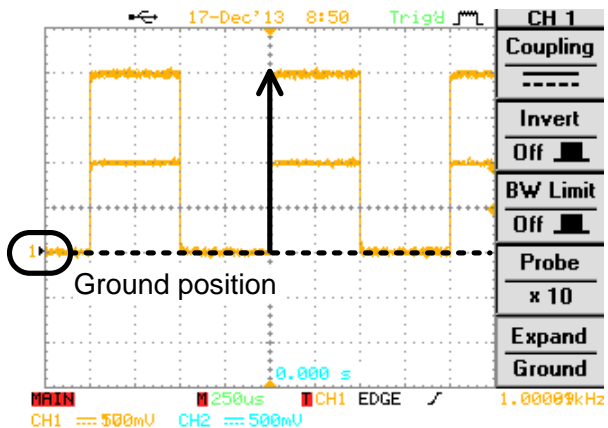

Trigger





The trigger settings configure the conditions under which the GBS-1000 can capture the incoming signals.



Trigger type overview

Edge	Triggers when the signal crosses an amplitude threshold in either a positive or negative slope.
Video	Extracts a sync pulse from a video format signal, and triggers on a specific line or field.
Pulse	Triggers when the pulse width of the signal is too narrow or too wide compared to the setting.

Trigger parameter overview

Trigger source	CH1 ~ 4	Channel 1 ~ 4 input signals
	Line	AC mains signal
Trigger mode	Auto	GBS-1000 generates an internal trigger if there is no trigger event, to make sure waveforms are constantly updated regardless of trigger events. Select this mode especially when viewing rolling waveforms at slower timebases.
	Normal	GBS-1000 acquires a waveform only when a trigger event occurs.

Single	GBS-1000 acquires a waveform once when a trigger event occurs, then stops acquiring. Press the Run/Stop key to acquire a waveform again.	
Auto level	When turning this function ON, GBS-1000 automatically adjusts the trigger level to the center amplitude of the waveform.	
Holdoff	The holdoff function defines the waiting period before GBS-1000 starts triggering again after a trigger point. The Holdoff function ensures a stable display.	
Video standard (video trigger)	NTSC National Television System Committee PAL Phase Alternative by Line SECAM SEquential Couleur A Memoire	
Sync polarity (video trigger)	 Positive polarity  Negative polarity	
Video line (video trigger)	Selects the trigger point in the video signal. field 1 or 2 line 1~263 for NTSC, 1~313 for PAL/SECAM	
Pulse condition (pulse trigger)	Sets the pulse width (20ns ~ 10s) and the triggering condition. > Longer than = Equal to < Shorter than ≠ Not equal to	
Trigger slope	 Triggers on the rising edge.  Triggers on the falling edge.	



Trigger coupling		Triggers only on the AC component.
		Triggers on AC+DC component.

Frequency rejection	LF	Puts a high-pass filter and rejects the frequency below 50kHz.
	HF	Puts a low-pass filter and rejects the frequency above 50kHz.

Noise rejection Rejects noise signal.

Setup Holdoff and Auto level

Background The Holdoff function defines the waiting period before the GBS-1000 starts triggering again after a trigger point. The Auto level function automatically adjusts the trigger level to the center amplitude of the waveform.

- Panel operation**
- Press the Trigger menu key   twice.
 - To set the Holdoff time, press F1 (Holdoff) and use the Variable knob. The resolution depends on the horizontal scale.

Holdoff
40.00ns

F 1

VARIABLE

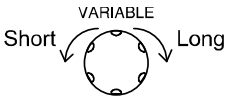

Range 40ns~2.5s

Pressing F2 (Set to Minimum) sets the Holdoff time to the minimum, 40ns.

Set To
Minimum



F 2

 **Note**

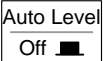
The holdoff function is automatically disabled when the waveform update mode is in Roll or Scan mode (page110).

3. To turn Auto Level On/Off, press F5 (Auto Level).  **F 5**

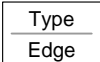
Use edge trigger

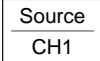
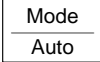
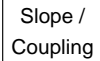
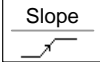
- Panel operation
1. Press the Trigger menu key. 
 2. Press F1 repeatedly to select edge trigger. The edge trigger indicator appears at the bottom of the display.  **F 1**

 From left: channel, edge trigger, slope
 3. Press F2 repeatedly to select the trigger source.  **F 2**
 Range Channel 1 ~ 4, Line
 4. Press F3 repeatedly to select the trigger mode.  **F 3**
 Range Auto, Normal, Single
 5. Press F5 (Slope/coupling) to set trigger slope and coupling.  **F 5**
 6. Press F1 (Slope) repeatedly to select the trigger slope, which also appears at the bottom of the display.  **F 1**
 Range Rising edge, falling edge

7. Press F2 (Coupling) repeatedly to select the trigger coupling.

Coupling

F 2
 Range DC, AC

8. Press F3 (Rejection) to select the frequency rejection mode.

Rejection
Off

F 3
 Range LF, HF, Off

9. Press F4 (Noise Rej) to turn the noise rejection On/Off.

Noise Rej
Off

F 4
 Range On, Off

10. Press F5 (Previous menu) to go back to the previous menu.

Previous
Menu

F 5

Use video trigger

- Panel operation
1. Press the Trigger menu key.

MENU

 2. Press F1 repeatedly to select the video trigger. The video trigger indicator appears at the bottom of the display.

Type
Video

F 1

█ CH1 VIDEO █

From left: channel, video trigger, polarity

 3. Press F2 repeatedly to select the trigger source channel.

Source
CH1

F 2
 Range Channel 1 ~ 4

4. Press F3 repeatedly to select the video standard.



Range NTSC, PAL, SECAM

5. Press F4 repeatedly to select the video signal polarity.



Range positive, negative

6. Press F5 repeatedly to select the video field line. Use the Variable knob to select the video line.

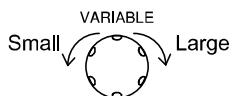

Field 1, 2

Video line NTSC: 1 ~ 262 (Even), 1 ~ 263 (Odd)
PAL/SECAM: 1 ~ 312 (Even),
1 ~ 313 (Odd)

Use pulse width trigger

Panel operation

1. Press the Trigger menu key.



2. Press F1 repeatedly to select pulse width trigger. The pulse width trigger indicator appears at the bottom of the display.

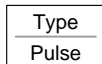

F 1

CH1 PULSE

From left: channel, pulse width trigger, slope

3. Press F2 repeatedly to select the trigger source.

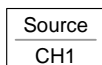

F 2

Range Channel 1 ~ 4, Line

4. Press F3 repeatedly to select the trigger mode.

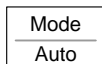

F 3

Range Auto, Normal, Single

5. Press F4 repeatedly to select the pulse condition. Then use the Variable knob to set the pulse width.

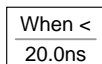

F 4

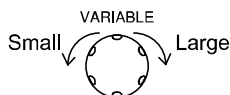







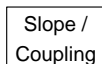

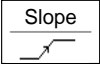

Condition > , < , = , ≠

Width 20ns ~ 10s

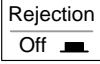
6. Press F5 to set trigger slope and coupling.

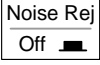

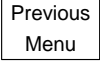





F 5

7. Press F1 (Slope) repeatedly to select the trigger slope, which also appears at the bottom of the display.
-  
- Range Rising edge, falling edge
8. Press F2 (Coupling) repeatedly to select the trigger coupling.
-  
- Range DC, AC
9. Press F3 (Rejection) to select the frequency rejection mode.
-  
- Range LF, HF, Off
10. Press F4 (Noise Rej) to turn the noise rejection On/Off.
-  
- Range On, Off
11. Press F5 (Previous menu) to go back to the previous menu.
-  

System Info / Language / Clock

This section describes how to set the interface, beeper, language, time/date, and probe compensation signal.



View system information

- Panel operation
1. Press the Utility key. 
 2. Press F5 (More).  
 3. Press F2 (System Info). The upper half of the display shows the system information in the following format.
 - Manufacturer name
 - Model name
 - Serial number
 - Firmware version 
 4. Press any other key (for example F5 (More)) to go back to the waveform display mode.  



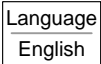

Select menu language



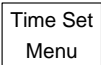

- Parameter
- The following is the list of menu language available by default. Language selection differs according to the region to which GBS-1000 is shipped.
- English
 - Chinese (traditional)
 - Chine (simplified)
 - Korean
 - Japanese
 - Spanish

- Russian
- Polish
- French
- German
- Italian
- Portuguese

- Panel operation
1. Press the Utility key. 
 2. Press F4 (Language) repeatedly to select the language.  

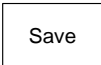
Set date and time

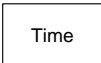
- Panel operation/
parameter
1. Press the Utility key. 
 2. Press F5 (More) twice.   x2
 3. Press F2 (Time Set Menu).  
 4. Press F2 (Year/ Month/ Date) repeatedly. Use the Variable knob to change the value.

Year	2000 ~ 2037
Month	1 ~ 12
Day	1 ~ 31
 5. Press F4 (Save) to confirm the value.  
 6. Press F1 (Date) to switch to the Time setting menu.  

7. Press F2 (Hour/ Minute) repeatedly. Use the Variable knob to change the value.

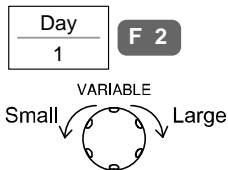

Hour 0 ~ 23

Minute 0 ~ 59

8. Press F4 (Save) to confirm the value.

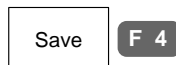

9. Turn Off the display and turn it On again (power cycle).



10. Make sure the date/time setting is correctly reflected at the top of the display.



SAVE/RECALL

File format / Utility	Display image file format	136
	Waveform file format	136
	Setup file format	138
	USB flash drive file utility.....	140
Save	File type/source/destination	145
	Save panel setting.....	146
	Save waveform	147
	Save All.....	151
Recall	File type/source/destination	155
	Recall default panel setting.....	155
	Recall reference waveform on the display	157
	Recall panel setting.....	158
	Recall waveform	160

File Format/Utility

Display image file format

Format	DSxxxx.bmp or Axxxx.bmp (Windows bitmap format)
Contents	The current display image in 234 x 320 pixels, color format. The background color can be inverted (Ink saver function).

Waveform file format

Format	DSxxxx.csv or Axxxx.csv (Comma-separated values format, can be opened in spreadsheet applications such as Microsoft Excel)	
Waveform type	CH1 ~ 4	Input channel signal
	Math	Math operation result (page72)
Storage location	W1 ~ W20	Waveform file stored in the internal memory. Stored waveforms can be copied to USB flash drive for transfer, or to Ref. A ~ D for showing on the display (W1 ~ W20 waveforms cannot be directly recalled on the display).
	Ref A ~ D	Reference waveforms stored in the internal memory, separate from W1 ~ W20. From Ref A ~ D, waveforms can be recalled directly on the display with amplitude and frequency information. Useful for reference purposes.
Contents: waveform data	The waveform data can be used for detailed analysis. It consists of horizontal and vertical position information of the waveform for the entire memory length.	

One division includes 25 points of horizontal and vertical data. The vertical point starts from the center line. The horizontal point starts from the leftmost part of the waveform.

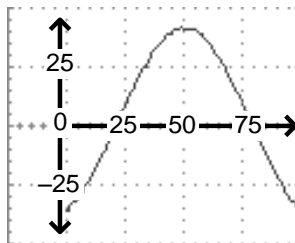

The time length or voltage level which each data point represents differs according to the vertical and horizontal scale. For example:

Vertical scale: 10mV/div (4mV per point)

Horizontal scale: 100us/div (4us per point)

Contents: other data

The following information is also included in the waveform file.

- Memory length
- source channel
- vertical offset
- vertical scale
- coupling mode
- waveform last dot address
- date and time
- trigger level
- vertical position
- time base
- probe attenuation
- horizontal view
- horizontal scale
- sampling period
- sampling mode
- Horizontal Expand mode
- Vertical Expand mode

Setup file format

Format	DSxxxx.set or Axxxx.set (proprietary format)	
	The setup file saves or recalls the following setting.	
Contents	Acquire	<ul style="list-style-type: none"> • Mode • memory length • Horizontal expand mode
	Cursor	<ul style="list-style-type: none"> • source channel • cursor on/off • cursor location
	Display	<ul style="list-style-type: none"> • dots/vectors • grid type • accumulation on/off
	Measure	<ul style="list-style-type: none"> • item • source channel
	Utility	<ul style="list-style-type: none"> • hardcopy type • interface type • buzzer type • Go-NoGo cond. • ink saver on/off • RS-232 config • menu language
	Program	<ul style="list-style-type: none"> • step contents • start/stop steps • loop count
	Horizontal	<ul style="list-style-type: none"> • display mode • position • scale
	Trigger	<ul style="list-style-type: none"> • trigger type • trigger mode • video polarity • pulse timing • source channel • video standard • video line • slope/coupling
	Channel (vertical)	<ul style="list-style-type: none"> • vertical scale • coupling mode • bandwidth limit on/off • vertical position • invert on/off • probe attenuation • Vertical expand mode

- Math
- operation type
 - source channel
 - vertical position
 - unit/div
 - FFT window

USB flash drive file utility

Background For the USB flash drive, file deletion, folder creation, file/folder rename are available from the front panel. This feature is not available for internally stored files.

Panel operation

1. Connect the drive to the front or rear panel USB port.
Note: Only one host connection, front or rear, is allowed at a time.

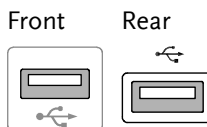

2. Press the Save/Recall key. Select any save or recall functionality, for example USB destination in Save Image function.



3. Press F5 (File Utilities). The display shows the USB flash drive contents from the root directory.

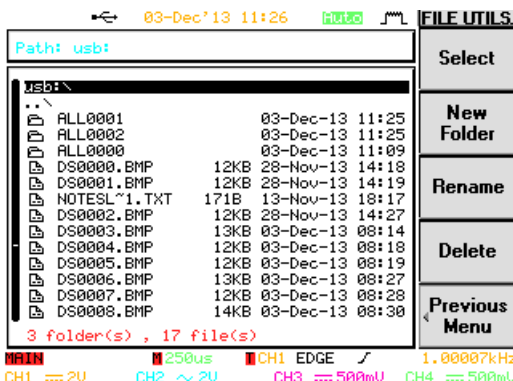

4. Use the Variable knob to move the cursor. Press F1 (Select) to go into the folder or go back to the previous directory level.

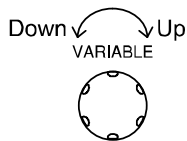

Go back to the root directory



Go back to the previous (higher) directory



Go into the folder



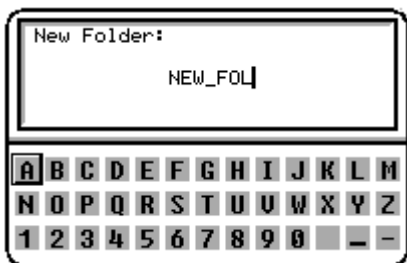
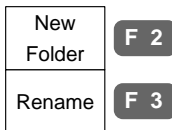

Create new folder / Rename file or folder

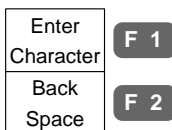
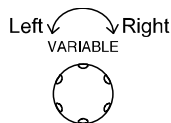

1. Move the cursor to the file or folder location and press F2 (New Folder) or F3 (Rename). The file/folder name and the character map appear on the display.







2. Use the Variable knob to move the pointer to the characters. Press F1 (Enter Character) to add a character or F2 (Back Space) to delete a character.



3. When editing is completed, press F4 (Save). A new folder or a new folder/file name is created.  
 4. Press F5 (Previous Menu) to go back to the previous menu.  
-

- Delete folder/file
1. Move the cursor to the folder or file location and press F4 (Delete). A message appears at the bottom of the display, asking additional confirmation.  

Press F4 again to confirm this process.

2. If the file/folder still needs to be deleted, press F4 (Delete) again to complete deletion. To cancel deletion, press any other key.  
3. The USB flash drive content is updated. Press F5 (Previous Menu) to go back to the Save/Recall menu.  

Panel operation

1. Connect the drive to the front or rear panel USB port.
Note: Only one host connection, front or rear, is allowed at a time.

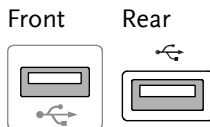

2. Press the Utility key.



3. Press F1 (Hardcopy Menu).



4. Press F1 (Function) repeatedly to select Save image or Save All.



5. To invert the color for the saved or printed display image, press F2 (Ink Saver) and turn On the Ink Saver.



Ink Saver On (inverted) Ink Saver Off (normal)

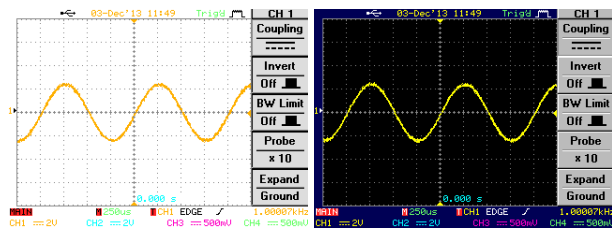

6. To save the image or folder, press the Hardcopy key.
The file or folder is saved to the root directory of the USB flash drive.

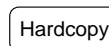

Save

File type/source/destination

Item	Source	Destination
Panel setup (DSxxxx.set)	<ul style="list-style-type: none"> • Front panel settings 	<ul style="list-style-type: none"> • Internal memory: S1 ~ S20 • External memory: USB
Waveform data (DSxxxx.csv)	<ul style="list-style-type: none"> • Channel 1 ~ 4 • Math operation result • Reference waveform A ~ D 	<ul style="list-style-type: none"> • Internal memory: Reference waveform A ~ D, W1 ~ W20 • External memory: USB
Display image (DSxxxx.bmp)	<ul style="list-style-type: none"> • Display image 	<ul style="list-style-type: none"> • External memory: USB
Save All	<ul style="list-style-type: none"> • Display image (Axxxx.bmp) • Waveform data (Axxxx.csv) • Front panel settings (Axxxx.set) 	<ul style="list-style-type: none"> • External memory: USB

Save panel setting

Panel operation

- (For saving to an external USB flash drive) Connect the drive to the front or rear panel USB port.

Front



Rear



Note: Only one host connection, front or rear, is allowed at a time.

- Press the Save/Recall key.

Save/Recall

- Press F3 (Save Setup). The display shows the available file destinations.

Save Setup

F 3

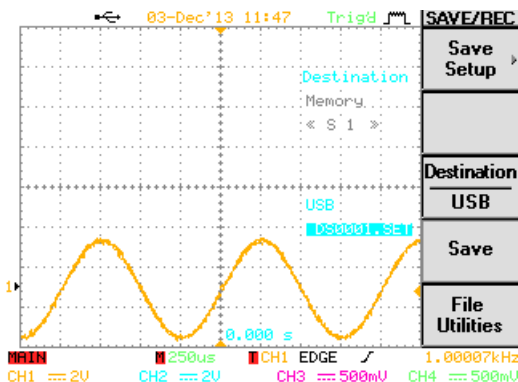

- Press F3 (Destination) repeatedly to select the saved location. Use the Variable knob to change the memory location (S1 ~ S20) or the file name (DSxxxx.set).

Destination
USB

F 3



Memory Internal memory, S1 ~ S20

USB External flash drive, no practical limitation on the number of files. When saved, the setup file is placed in the root directory.

5. Press F4 (Save) to confirm saving. When completed, a message appears at the bottom of the display.



Note

The file will not be saved if the power is turned Off or the USB drive is taken out before the message appears.

USB file utility

To edit the USB flash drive contents (create/delete/rename files and folders), press F5. For details, see page140.



Save waveform

Panel operation

1. (For saving to an external USB flash drive) Connect the drive to the front or rear panel USB port.
Note: Only one host connection, front or rear, is allowed at a time.

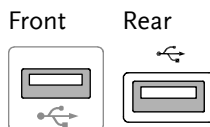

2. Press the Save/Recall key.



3. Press F4 (Save Waveform). The display shows the available source and destination options.



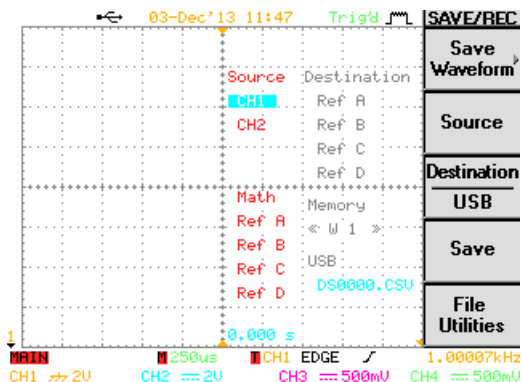

4. Press F2 (Source). Use the Variable knob to select the source signal.



CH1 ~ CH4 Channel 1 ~ 4 signal

Math Math operation result (page72)

RefA ~ D Internally stored reference waveforms A ~ D

5. Press F3 (Destination) repeatedly to select the file destination. Use the Variable knob to select the memory location or file name.



Memory Internal memory, W1 ~ W20

USB External flash drive, no practical limitation on the number of files. When saved, the waveform file is placed in the root directory.

Ref Internal reference waveform, A~D

- Press F4 (Save) to confirm saving. When completed, a message appears at the bottom of the display.



Waveform save to RefA completed

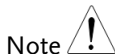

Note The file will not be saved if the power is turned Off or the USB drive is taken out before the message appears.

USB file utility

To edit the USB flash drive contents (create/delete/rename files and folders), press F5. For details, see page140.



PC software (FreeWave)

Saving a waveform is also available through the proprietary PC software, downloadable from GWInstek website.



Save display image

Panel operation

- Connect the drive to the front or rear panel USB port. Note: Only one host connection, front or rear, is allowed at a time.

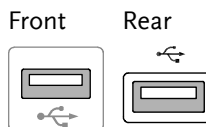

- Press the Save/Recall key.



- Press F5 (More).



- Press F1 (Save Image). The display shows the available file destinations.

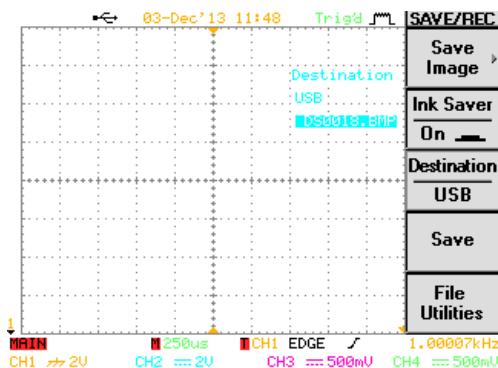
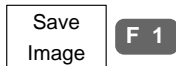

- Press F2 (Ink Saver) repeatedly to invert the background color (On) or not (Off).



Ink Saver On (inverted) Ink Saver Off (normal)

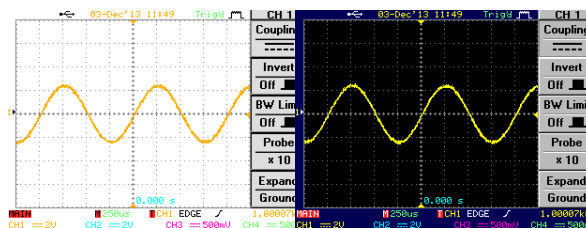

- Press F3 (Destination). Use the Variable knob to select the file name.

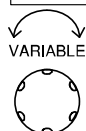

USB External flash drive, no practical limitation on the number of files. When saved, the image file is placed in the root directory.

- Press F4 (Save) to confirm saving. When completed, a message appears at the bottom of the display.

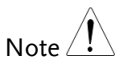

Note

The file will not be saved if the power is turned Off or USB drive is taken out before the message appears.

USB file utility

To edit the USB flash drive contents (create/delete/rename files and folders), press F5. For details, see page140.



PC software (FreeWave)

Saving a display image is also available through proprietary PC software, downloadable from GWInstek website.



Save All

Panel operation

- Connect the drive to the front or rear panel USB port. Note: Only one host connection, front or rear, is allowed at a time.

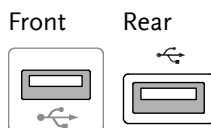

- Press the Save/Recall key.



- Press F5 (More).



- Press F2 (Save All). The display shows the available file destinations. The following files are saved, contained in a folder.



Setup file (Axxx.set) Two types of setups are saved: the current panel setting and the last internally saved setting (one of S1 ~ S20).

Display image (Axxx.bmp) The current display image in bitmap format.

Waveform data (Axxx.csv) Two types of waveform data are saved: the currently active channel data and the last internally saved data (one of W1 ~ W20).

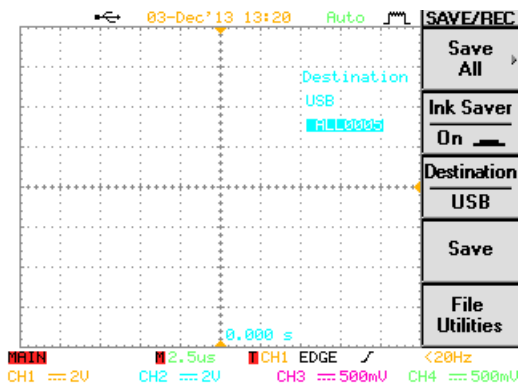

- Press F2 (Ink Saver) repeatedly to invert the background color (On) or not (Off) for the display image.



Ink Saver On (inverted) Ink Saver Off (normal)

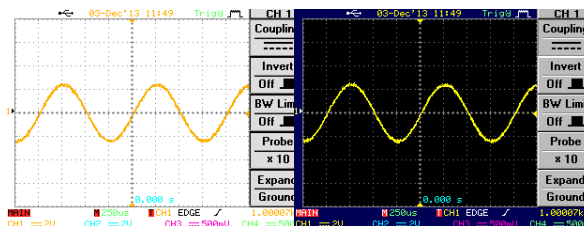

6. Press F3 (Destination). Use the Variable knob to select the file name.

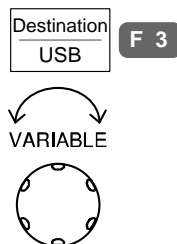

USB External flash drive, no practical limitation on the number of files. When saved, the folder is placed in the root directory.

7. Press F4 (Save) to confirm saving. When completed, a message appears at the bottom of the display.



Note  The file will not be saved if the power is turned Off or USB drive is taken out before the message appears.

8. Together with the current setup/waveform/image, the last saved waveform file (one from W1 ~ W20) and setup file (one from S1 ~ S20) are also included in the folder.

USB file utility To edit USB flash drive contents (create/delete/rename files and folders), press F5. For details, see page140.

File Utilities



F 5



Recall

File type/source/destination

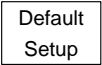
Item	Source	Destination
Default panel setup	<ul style="list-style-type: none"> Factory installed setting 	<ul style="list-style-type: none"> Current front panel setting
Reference waveform	<ul style="list-style-type: none"> Internal memory: A ~D 	<ul style="list-style-type: none"> Current front panel setting
Panel setup (DSxxx.set)	<ul style="list-style-type: none"> Internal memory: S1 ~ S20 External memory: USB 	<ul style="list-style-type: none"> Current front panel setting
Waveform data (DSxxx.csv)	<ul style="list-style-type: none"> Internal memory: W1 ~ W20 External memory: USB 	<ul style="list-style-type: none"> Reference waveform A ~ D
Display image (DSxxx.bmp)	<ul style="list-style-type: none"> External memory: USB 	<ul style="list-style-type: none"> Display

Recall default panel setting

- Panel operation
1. Press the Save/Recall key. 
 2. Press F1 (Default Setup).  
The factory installed setting is recalled and replaces the current panel setting.

Setting contents	The following is the default setting contents.	
Acquisition	Mode: Normal	Memory length: 500
	Hor. Expand: Center	
Channel	Scale: 2V/Div	CH1: On, CH2/3/4: Off
	Coupling: DC	Invert: Off
	BW limit: Off	Probe attenuation: x1
	Expand: Ground	
Cursor	Source: CH1	Horizontal: None
	Vertical: None	
Display	Type: Dots	Accumulate: Off
	Graticule: 	
Go-NoGo	Go-No: Off	Source: CH1
	NoGo when: 	Violating: Stop
Horizontal	Scale: 2.5us/Div	Mode: Main Timebase
Math	Type: + (Add)	Channel: CH1+CH2
	Position: 0.00 Div	Unit/Div: 2V
Measure	Source1, 2: CH1, CH2	Type: VPP, Freq, FRR
Program	Mode: Edit	Step: 1
Trigger	Type: Edge	Source: Channel1
	Mode: Auto	Slope: 
	Coupling: DC	Rejection: Off
	Noise Rejection: Off	
Utility	SaveImage, InkSaver Off	Sound: Off

Recall reference waveform on the display

Panel operation 1. The reference waveform must be stored in advance. See page 147 for waveform store details.

2. Press the Save/Recall key.

Save/Recall

3. Press F2 (Display Refs). The reference waveform display menu appears.

Display Refs. **F 2**

4. Select the reference waveform from F1 (Ref A) to F4 (Ref D) and press it. The waveform appears on the display and the period and amplitude of the waveform appears in the menu.

Ref.A Off **F 2**



Ref.A Off
1V
2.5ms **F 2**

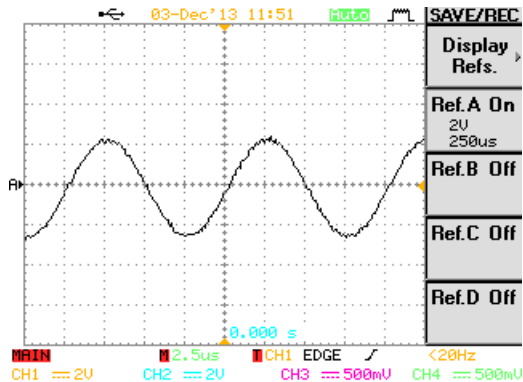

5. To clear the waveform from the display, press F1 ~ F4 key again.

Ref.A Off **F 2**

Recall panel setting

Panel operation

1. (For recalling from an external USB flash drive) Connect the drive to the front or rear panel USB port.
Note: Only one host connection, front or rear, is allowed at a time.

Front



Rear



2. Press the Save/Recall key.

Save/Recall

3. Press F5 (More).

More **F 5**

4. Press F3 (Recall Setup). The display shows the available file sources.

Recall Setup **F 3**

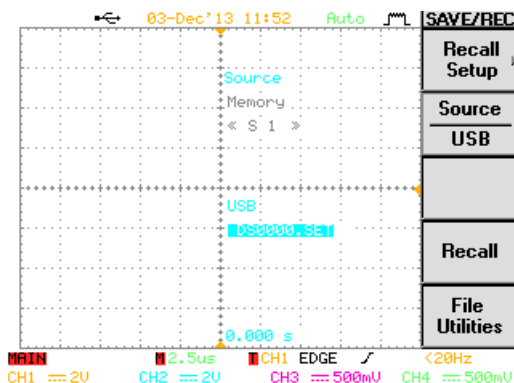

5. Press F2 (Source) repeatedly to select the file source, internal memory or external USB. Use the Variable knob to change the memory location (S1 ~ S20) or the file name (DSxxxx.set).

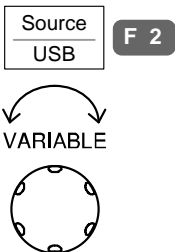

Memory Internal memory, S1 ~ S20

USB External flash drive, no practical limitation on the number of files. The setup file must be placed in the root directory to be recognized.

6. Press F4 (Recall) to confirm recalling. When completed, a message appears at the bottom of the display.



Setup recalled from S 1

Note  The file will not be saved if the power is turned Off or the USB drive is taken out before the message appears.

USB file utility To edit the USB flash drive contents (create/delete/rename files and folders), press F5. For details, see page140.



Recall waveform

- Panel operation
- (For recalling from an external USB flash drive) Connect the drive to the front or rear panel USB port.

Note: Only one host connection, front or rear, is allowed at a time.

Front



Rear

 - Press the Save/Recall key.



 - Press F5 (More).

More

F 5
 - Press F4 (Recall Waveform). The display shows the available source and destination options.

Recall Waveform

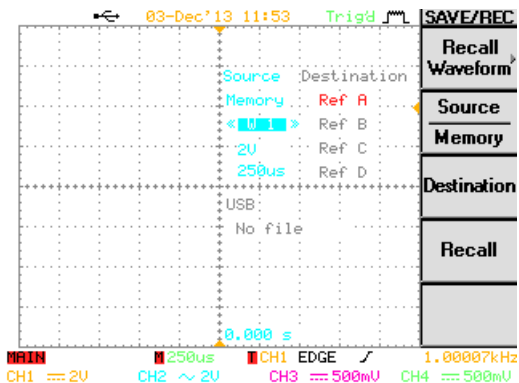
F 4



5. Press F2 (Source) repeatedly to select the file source, internal memory or external USB. Use the Variable knob to change the memory location (S1 ~ S20) or the file name (DSxxxx.csv).

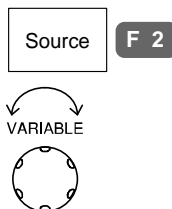

Memory	Internal memory, W1 ~ W20
USB	External flash drive, no practical limitation on the numbers of files. The waveform file must be placed in the root directory to be recognized.

6. Press F3 (Destination). Use the Variable knob to select the memory location.

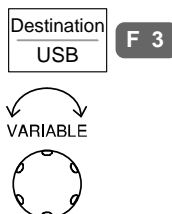

RefA ~ D	Internally stored reference waveforms A ~ D
----------	---

7. Press F4 (Recall) to confirm recalling. When completed, a message appears at the bottom of the display.



Waveform recalled from W 1

Note

The file will not be saved if the power is turned Off or the USB drive is taken out before the message appears.

USB file utility

To edit the USB flash drive contents (create/delete/rename files and folders), press F5. For details, see page140.

File
Utilities

F 5

P RINT OUT

The Hardcopy key is used as quick-save or quick-print key. The Hardcopy key can be assigned either to printout screenshots or to save files.

When assigned to “Print” the screen image can be printed to a PictBridge compatible printer using the USB device port. To reduce the amount of printer ink used for each print, images can be printed using the Ink Saver function.

Display printout is also available using proprietary PC software, downloadable from the GWInstek website.

Overview

Printout step Listed below are the steps that have to be followed when printing out the display image through the USB port.

1. Connect the printer to the USB host port.
2. Configure the interface to printout mode.
3. Configure the content and printout.
4. Printout.

1 Connect printer

1. Connect the PictBridge compatible printer to the USB host port, front or rear panel.

Front panel







Rear panel



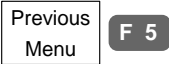

USB Note Using the front and rear USB host port at the same time is forbidden (Example: printer to the rear panel, storage device to the front panel).

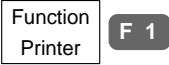
2 Configure interface

- | | | |
|-----------------|--|---|
| Panel operation | 1. Press the Utility key. |  |
| | 2. Press F2 (Interface menu). |  |
| | 3. Press F1 (Type) repeatedly to select USB. |  |
| | 4. Press F5 (Previous menu). |  |
| | 5. Press F1 (Hardcopy menu). |  |
| | 6. Press F1 (Function) repeatedly to select Printer. |  |

3 Configure content

- | | | |
|-----------------|--|---|
| Panel operation | 1. Press the Utility key. |  |
| | 2. Press F1 (Hardcopy Menu). |  |
| | 3. Press F1 (Function) repeatedly to select Printer if it is not selected yet. |  |

- To invert the color for the saved or printed display image, press F2 (Ink Saver) and turn On the Ink Saver.



F 2

Ink Saver On (inverted)

Ink Saver Off (normal)

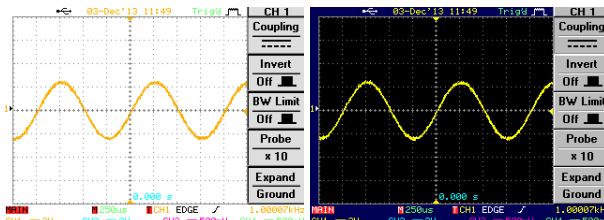

- To select the printed size, press F4 (Ratio). Use the Parameter knob to change the ratio with respect to the real display size.

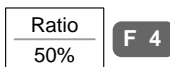

F 4

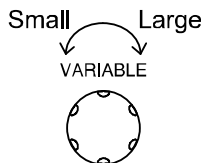

Range 10% ~ 100%

4 Printout

Press the Hardcopy key. The display image is printed out.

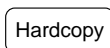

REMOTE CONTROL

CONFIG





This chapter describes basic configuration of IEEE488.2 based remote control. For a command list, refer to the programming manual on the User Manual CD or downloadable from the GWInstek website, www.gwinstek.com

Configuration	Configure USB interface	167
	Configure RS-232C interface	168
	USB/RS-232C remote control software.....	170

Interface Configuration





Configure USB interface

USB configuration	PC side connector	Type A, host
	GBS-1000 side connector	Type B, slave
	Speed	1.1/2.0 (full speed)

- Panel operation
1. Press the Utility key. 
 2. Press F2 (Interface Menu). 
 3. Press F1 (Type) repeatedly to select USB. 
 4. The interface icon at the top of the display changes into USB type. 
 5. Connect the USB cable to the rear panel slave port. 
 6. When the PC asks for the USB driver, select the dso_vpo.inf driver included in the FreeWave software package in the User Manual CD or downloadable from the GW website, www.gwinstek.com, GBS-1000 product corner.

Configure RS-232C interface

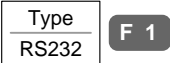
RS-232C configuration	Connector	DB-9, Male
	Baud rate	2400, 4800, 9600, 19200, 38400
	Parity	None, Odd, Even
	Data bit	8 (fixed)
	Stop bit	1, 2

- Panel operation
1. Press the Utility key. 
 2. Press F2 (Interface Menu). 
 3. Press F1 (Type) repeatedly to select RS-232C. 
 4. The interface icon at the top of the display changes into RS-232C type. 
 5. To change the baud rate, press F2 (Baud Rate) repeatedly. 

Range 2400, 4800, 9600, 19200, 38400
 6. To change the stop bit, press F3 (Stop Bit) repeatedly. 

Range 1, 2
 7. Data bit is fixed at 8.
 8. To change the parity, press F4 (Parity) repeatedly. 

Range None, Odd, Even

9. Connect the RS-232C cable to the rear panel port: DB-9 male connector. For functionality check see page170.

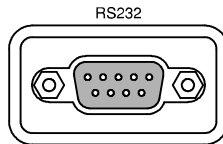

Pin assignment

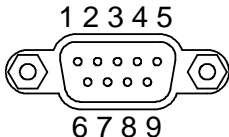

- 2: RxD (Receive data)
- 3: TxD (Transmit data)
- 5: GND
- 4, 6 ~ 9: No connection

PC connection

Use the Null Modem connection as in the below diagram.

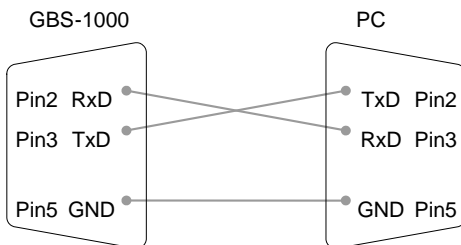

USB/RS-232C remote control software

Terminal application (USB/RS-232C) Invoke the terminal application such as MTTY (Multi-Threaded TTY). For RS-232C, set the COM port, baud rate, stop bit, data bit, and parity accordingly.

To check the COM port No, see the Device Manager in the PC. For WinXP, Control panel → System → Hardware tab.

Functionality check Run this query command via the terminal.
*!dn?

This should return the Manufacturer, Model number, Serial number, and Firmware version in the following format.







GW, GBS-1074, 000000001, V1.00

PC Software (USB only) The proprietary PC software, downloadable from GWInstek website, can be used for remote control. This mode is available only for the USB interface.

M AINTENANCE

Two types of maintenance operations are available: calibrate vertical resolution, and compensate the probe. Run these operations when using GBS-1000 in a new environment.

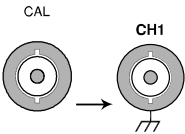
Vertical Resolution Calibration

- Panel operation
1. Press the Utility key. 
 2. Press F5 (More). 
 3. Press F1 (Self Cal Menu). 
 4. Press F1 (Vertical). 
 5. The buzzer sounds and the message "Set CAL to CH1, then press F5" appears at the bottom of the display.
 6. Connect the calibration signal from the rear panel CAL out to Channel1 input. 
 7. Press F5. 
(no menu item)

8. The calibration for Channel1 starts and ends automatically, in less than 5 minutes.

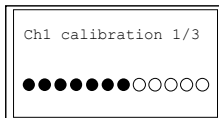

9. When finished, connect the calibration signal to Channel2 and press F5. Channel2 calibration starts.

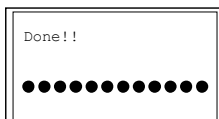

10. Repeat the above step for Channel 3 and 4.
11. When the calibration for all channels is completed, the display goes back to the default state.

Probe Compensation

- Panel operation
1. Connect the probe between the Channel1 input and the probe compensation output (2Vp-p, 1kHz square wave) on the front panel. Set the probe attenuation to x10.

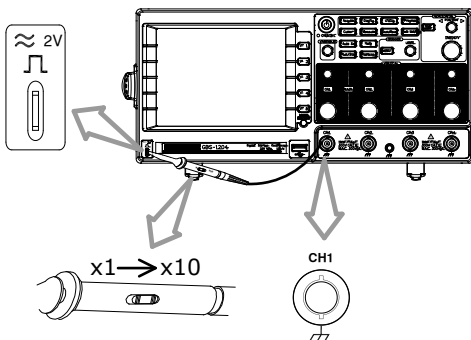

2. Press the Utility key.



3. Press F5 (More) twice.



4. Press F1 (ProbeComp Menu).



5. Press F1 (Wavetype) repeatedly to select the standard square wave.



6. Press the Auto Set key. The compensation signal appears on the display.



7. Press the Display key, then F1 (Type) twice to select the vector waveform.

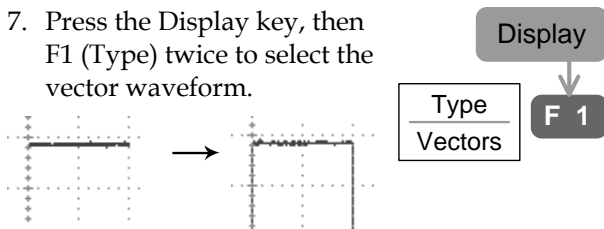

8. Turn the adjustment point on the probe until the signal edge becomes sharp.

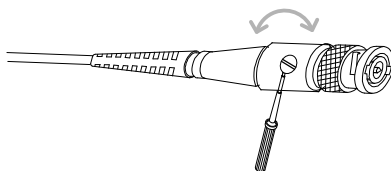
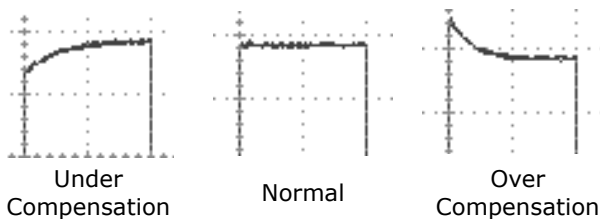

FAQ

- I pressed the Power (On/Standby) key on the front panel but nothing happens.
- I connected the signal but it does not appear on the display.
- I want to remove the (Measurement result / FFT result / Help contents) from the display.
- The waveform does not update (frozen).
- The probe waveform is distorted.
- Auto Set does not catch the signal well.
- I want to clean up the cluttered panel settings.
- The display image printout is too dark on the background.
- The date and time settings are not correct.
- USB does not work.
- The accuracy does not match the specification.

I pressed the Power (On/Standby) key on the front panel but nothing happens.

Make sure you turned On the rear panel Power switch. For the power up sequence, see page 23.

I connected the signal but it does not appear on the display.

Make sure you have activated the channel by pressing the Channel key (the LED turns On).

I want to remove the (Measurement result / FFT result / Help contents) from the display.

To clear the automatic measurement results, press the Measure key twice, then Press F5 (OFF). See page60 for details.

To clear the FFT results, press the Math key twice. See page72 for details.

To clear the Help results, press the Help key again. See page50 for details.

The waveform does not update (frozen).

Press the Run/Stop key to unfreeze the waveform. See page55 for details.

If this does not help, the trigger mode might be set to Single. Press the Trigger menu key, then F3 (Mode) to Auto. See page124 for trigger setting details.

The probe waveform is distorted.

You might need to compensate the probe. For details, see page172. Note that the frequency accuracy and duty factor are not specified for the probe compensation waveform and therefore it should not be used for other reference purposes.

Auto Set does not catch the signal well.

The Autoset function cannot catch signals under 30mV or 30Hz. Please manual trigger the waveform under those conditions. See page54 for Auto Set details.

I want to clean up the cluttered panel settings.

Recall the default settings by pressing Save/Recall key→F1. For default setting contents, see page49.

The display image printout is too dark on the background.

Use the Inksaver function which reverses the background color. For details, see page163.

The date and time settings are not correct.

For date and time setting details, please see page133. If it does not help, the internal battery controlling the clock might be worn out. Contact your dealer or GWInstek.

USB does not work.

Make sure you are not using the front and the rear USB host connector at the same time. Disconnect either of the USB devices and try again.

The accuracy does not match the specification.

Make sure the device is powered On for at least 30 minutes, within +20°C~+30°C. This is necessary to stabilize the unit to match the specification.

For more information, contact your local dealer or GWInstek at www.gwinstek.com / marketing@goodwill.com.tw.

APPENDIX

Fuse Replacement

- Step 1. Take off the power cord and remove the fuse socket using a minus driver.

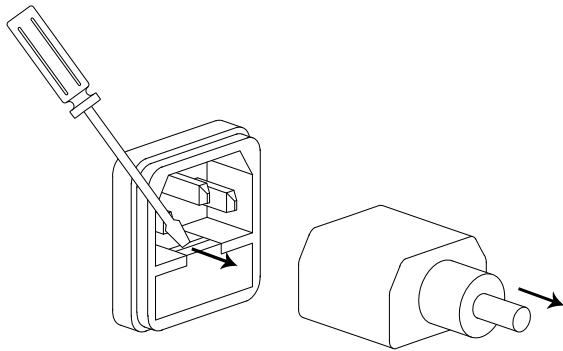

2. Replace the fuse in the holder.

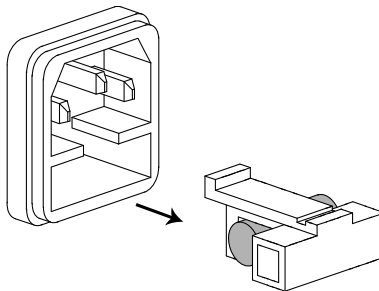

Rating T2A, 250V

GBS-1000 Specifications

The specifications apply when GBS-1000 is powered on for at least 30 minutes under +20°C~+30°C.

Model-specific

GBS-1074	Channels	4
	Bandwidth	DC ~ 70MHz (-3dB)
	Rise time	5ns approx.
GBS-1104	Channels	4
	Bandwidth	DC ~ 100MHz (-3dB)
	Rise time	3.5ns approx.
GBS-1204	Channels	4
	Bandwidth	DC ~ 200MHz (-3dB)
	Rise time	1.75ns approx.

Common

Vertical	Sensitivity	2mV/div~5V/Div (1-2-5 increments)
	Accuracy	± (3% x Readout +0.05div x Volts/div + 0.8mV)
	Input Coupling	AC, DC, Ground
	Input Impedance	1MΩ±2%, ~16pF
	Polarity	Normal & Invert
	Maximum Input	300V (DC+AC peak), CAT II
	Math operation	+, -, FFT, FFT rms
	Offset Range	2mV/div~20mV/div: 0.5V
		50mV/div~200mV/div: 5V
		500mV/div~2V/div: 50V
		5V/div: 300V
Bandwidth Limit	20MHz (-3dB)	

Trigger	Sources	CH1, CH2, CH3, CH4, Line
	Modes	Auto-Level, Auto, Normal, Single, TV, Edge, Pulse Width
	Coupling	AC, DC, LFrej, HFrej, Noise rej
	Sensitivity	DC~25MHz: Approx. 0.5div or 5mV 25MHz~max: Approx. 1div or 10mV
Horizontal	Range	1ns/div~10s/div, 1-2-5 increment Roll mode: 250ms/div ~ 10s/div
	Modes	Main, Window, Window Zoom, Roll, Scan, X-Y
	Accuracy	±0.01%
	Pre-Trigger	20 div maximum
	Post-Trigger	1000 div
X-Y Mode	X-Axis Input	Channel 1
	Y-Axis Input	Channel 2, 3, 4
	Phase Shift	±3° at 100kHz
Signal Acquisition	Real-Time	1G Sa/s maximum
	Equivalent	25G Sa/s maximum
	Vertical	8 bits
	Resolution	
	Record Length	25K Dots Maximum
	Acquisition	Normal, Peak Detect, Average
	Peak Detection	10ns
Cursors and Measurement	Average	2, 4, 8, 16, 32, 64, 128, 256
	Voltage	Vpp, Vamp, Vavg, Vrms, Vhi, Vlo, Vmax, Vmin, Rise Preshoot/ Overshoot, Fall Preshoot/ Overshoot
	Time	Freq, Period, Rise Time, Fall Time, Positive Width, Negative Width, Duty Cycle
	Delay	FRR, FRF, FFR, FFF, LRR, LRF, LFR, LFF
	Cursors	Voltage difference (ΔV) and Time difference (ΔT) between cursors
	Auto Counter	Resolution: 6 digits Accuracy: ±2% Signal source: All available trigger source except the Video trigger
	Control Panel Function	Auto Set
Save Setup		Internal memory: 20 sets USB Flash drive: unlimited
Save Waveform		Internal memory: 20 sets USB Flash drive: unlimited
Save display image		USB Flash drive: unlimited

Display	LCD	5.6 inch, TFT, brightness adjustable
	Resolution (dots)	234 (Vertical) x 320 (Horizontal)
	Graticule	8 x 10 divisions (menu On) 8 x 12 divisions (menu Off)
Interface	Go-No Go Output	5V max/ 10mA TTL open collector
	RS-232C	DTE DB 9-pin male
	USB	Host: Flash drive, Printer Device: Remote control 2.0 full speed supported
Power Source	Line Voltage	100V~240V AC, 48Hz~63Hz
Miscellaneous	Language Selection	English, Traditional Chinese, Simplified Chinese, others (depend on the region)
	On-Line Help	Available for most keys
	Real-Time Clock	Display: yy/mm/dd/hh/ss (time stamp for saved data)
	Operation Environment	Ambient temperature 0 ~ 50°C Relative humidity ≤ 80%, 40°C or below ≤ 45%, 41°C~50°C
Storage Environment	Storage Temperature: -10°C~60°C, no condensation- Relative humidity 93% @ 40°C 65% @ 41°C~60°C	
Dimensions	254 (D) x 142 (H) x 310 (W) mm	
Weight	Approx. 4.3kg	

Probe Specifications

GTP-070A-4

Applicable to: GBS-1074

Position X10	Attenuation Ratio	10:1
	Bandwidth	DC to 70MHz
	Input Resistance	10M Ω when used with oscilloscopes with 1M Ω input.
	Input Capacitance	28pF~32pF
	Compensation Range	25pF~ 45pF
Position X1	Max. Input Voltage	\leq 600Vpk, Derating with frequency
	Attenuation Ratio	1:1
	Bandwidth	DC to 6MHz
	Input Resistance	1M Ω when used with 1M Ω input
Safety	Input Capacitance	120pF~220pF
	Max. Input Voltage	\leq 200Vpk, Derating with frequency
		EN61010-031 CAT II

GTP-100A-4

Applicable to: GBS-1104

Position x 10	Attenuation Ratio	10:1
	Bandwidth	DC ~ 100MHz
	Input Resistance	10M Ω when used with 1M Ω input
	Input Capacitance	14.5~17.5pF approx.
	Maximum Input Voltage	\leq 600Vpk, Derating with frequency
Position x 1	Attenuation Ratio	1:1
	Bandwidth	DC ~ 6MHz
	Input Resistance	1M Ω when used with 1M Ω input
	Input Capacitance	85~115pF approx.
	Maximum Input Voltage	\leq 200Vpk, Derating with frequency
Operating Cond.	Temperature	-10°C ~ 50°C
	Relative Humidity	\leq 85% @35°C
Safety Standard		EN 61010-031 CAT II

GTP-250A-2

Applicable to: GBS-1204

Position X10	Attenuation Ratio	10:1
	Bandwidth	DC to 250MHz
	Rise Time	1.4nS
	Input Resistance	10M Ω when used with oscilloscopes with 1M Ω input.
	Input Capacitance	Approximately 17pF
	Compensation Range	10 to 35pF
	Max. Input Voltage	500V CAT I, 300Vrms CAT II derating with frequency.
Position X1	Attenuation Ratio	1:1
	Bandwidth	DC to 6MHz
	Rise Time	58nS
	Input Resistance	1M Ω (Oscilloscope Input)
	Input Capacitance	47pF plus oscilloscope capacitance
	Max. Input Voltage	300V CAT I, 150V CAT II (DC + peak AC) derating with frequency.
Safety	EN61010-031 CAT II	

Declaration of Conformity

We

GOOD WILL INSTRUMENT CO., LTD.

No. 7-1, Jhongsing Rd, Tucheng City, Taipei County 236. Taiwan.

GOOD WILL INSTRUMENT (SUZHOU) CO., LTD.

No. 69 Lushan Road, Suzhou New District Jiangsu, China.

declare that the below mentioned product

Type of Product: Digital Storage Oscilloscope

Model Number: GBS-1074, GBS-1104, GBS-1204

are herewith confirmed to comply with the requirements set out in the Council Directive on the Approximation of the Law of Member States relating to Electromagnetic Compatibility (2004/108/EC) and Low Voltage Equipment Directive (73/23/EEC & 93/68/EEC).

For the evaluation regarding the Electromagnetic Compatibility and Low Voltage Equipment Directive, the following standards were applied:

© EMC	
EN 61326-1 :	Electrical equipment for measurement, control and laboratory use –
EN 61326-2-1:	
EN 61326-2-2:	EMC requirements (2006)
Conducted & Radiated Emission CISPR 11: 2003+A1: 2004 +A2: 2006	Electrostatic Discharge IEC 1000-4-2: 2001
Current Harmonics EN 61000-3-2: 2006	Radiated Immunity IEC 1000-4-3: 2006+A1: 2007
Voltage Fluctuations EN 61000-3-3:1995+A1:2001+A2:2005	Electrical Fast Transients IEC 1000-4-4: 2004+Corr.1: 2006+Corr.2: 2007
=====	Surge Immunity IEC 1000-4-5: 2005
=====	Conducted Susceptibility IEC 61000-4-6: 2003+A1: 2004+A2: 2006
=====	Power Frequency Magnetic field IEC 61000-4-8: 1993+A1: 2000
=====	Voltage Dip/Interruption IEC 61000-4-11: 2004

Low Voltage Equipment Directive 73/23/EEC & amended by 93/68/EEC	
Safety Requirements	IEC/EN 61010-1: 2001

INDEX

AC coupling.....	119	cursor.....	67
acquisition	99	menu tree	29
menu tree	28	shortcut	29
addition.....	74	specification.....	179
menu tree	31	toggle on or off.....	72
auto level	127	cycle time measure	61
auto set.....	54	Data logging	
effect on channel.....	53	overview	92
exception	54	run.....	95
faq.....	175	setup	93
specification.....	179	source	93
auto template	84	date setting	133
auto trigger.....	124	faq	176
automatic measurement		indicator	20
display all.....	64	menu tree	47, 48
faq.....	175	DC coupling	119
gated measurements	65	default setup.....	155
individual mode	62	contents	49
menu tree	33	effect on channel.....	53
overview	60	menu tree	35
shortcut	33	delay measure	61
specification.....	179	display.....	106
average acquisition.....	99	contrast setting.....	106
average voltage measure	61	diagram	20
bandwidth limitation	120	grid setting.....	107
blackman window	74	menu tree	30
buzzer	79	save image	149
menu tree	43	shortcut	30
calibration, vertical resolution	171	specification.....	180
caution symbol.....	5	Disposal instructions.....	8
channel.....	53	dot waveform.....	104
faq.....	174	download information	13
menu tree	29	duty cycle measure.....	61
shortcut	29	edge trigger	127
status indicator.....	21	menu tree	41
cleaning the instrument.....	7	EN 61010-031	181
coupling mode.....	119	EN61010	183
menu tree	29	measurement category	6
		pollution degree	8

environment	180	specification.....	179
safety instruction	7	horizontal scale	
equivalent time sampling	103	expansion mode.....	110
falling time measure	61	initialization.....	24
FFT	76	ink saver	
horizontal cursor	68	in display save	150
menu tree	32	in hardcopy	64, 69, 144
overview	73	in save all	152
vertical cursor	71	input frequency indicator	21
XY cursor	69	interface.....	167
FFT rms	76	menu tree	44
file format	136	specification.....	180
firmware version.....	132	invert waveform.....	120
flattop window.....	74	language selection.....	132
FM example.....	102	list of features	11
frequency measure	61	long memory	102
front panel diagram.....	14	low voltage measure.....	60
fuse replacement.....	177	math.....	73
safety instruction	7	faq	175
generic purpose signal	58	menu tree	31
go-nogo	78	shortcut	31
how to configure.....	79	memory length.....	101
how to run	85	menu on/off	107
menu tree	45	menu on_off	
output specification.....	180	cursors.....	72
output terminal.....	86	min/max template.....	82
template menu tree	45	model difference	11
ground		normal acquisition	99
coupling	119	normal trigger.....	124
symbol	5	NTSC	125
terminal	17	overshoot voltage measure.....	61
hanning window.....	73	package contents	13
hardcopy	143	PAL	125
menu tree	44	pc software download.....	13
shortcut	44	peak detect acquisition.....	99
help	50	peak voltage measure.....	60
faq	175	power on/off	23
high voltage measure	60	faq	174
holdoff.....	126	safety instruction.....	7
horizontal.....	108	switch overview.....	18
basic operation.....	56	preshoot voltage measure.....	61
cursor menu tree.....	29	printout	
cursor operation.....	67	faq	176
menu tree	31	probe.....	172
position.....	108	attenuation level	121
scale	109	attenuation menu tree.....	29
shortcut	31		

compensation menu tree	46	service operation	
compensation signal overview... 58		about disassembly	6
faq.....	175	contact	176
package list	13	setup	
peak detect demonstration.....	100	default contents	49
program	87	file format	138
how to edit.....	88	how to recall.....	158
how to run	90	how to save.....	146
menu tree.....	34	menu tree	36, 37
shortcut	34	recall menu tree	38
program manual download	13	short memory	102
pulse time measure	61	single trigger mode.....	125
pulse width trigger.....	130	faq	175
menu tree.....	41	with run/stop	55
real time sampling.....	103	spike noise example	102
rear panel diagram	18	stop icon.....	55
recall.....	155	subtraction	74
default setup.....	155	menu tree	31
menu tree	35	system information.....	132
reference waveform	157	template for go-nogo.....	81
setup	158	tilt stand	22
shortcut	35	time setting	133
waveform.....	160	faq	176
rectangular window	74	indicator	20
reference waveform		menu tree	47, 48
how to recall	157	trigger	124
menu tree	35	edge.....	127
remote control.....	166	menu tree	40
interface configuration	167	parameter.....	124
rising time measure.....	61	pulse width.....	130
roll mode	112	shortcut	40
RS-232C interface.....	168	single trigger with run/stop.....	55
run/stop	55	specification.....	179
faq.....	175	status indicator	21
horizontal position	108	video	128
horizontal scale	109	UK power cord.....	9
save.....	145	USB	
display image.....	149	driver download.....	13
menu tree.....	35	faq	176
save all.....	151	file menu tree	39
setup	146	file operation	140
shortcut	35	PC software download.....	170
specification.....	179	remote control interface	167
waveform.....	147	utility	
scan mode.....	111	key overview.....	15
SECAM	125	menu tree	43
serial number	132	shortcut	43
		vector waveform.....	104

vertical.....	118	waveform	
basic operation.....	57	accumulation.....	105
cursor menu tree.....	29	file contents	136
cursor operation.....	70	how to recall.....	160
position.....	118	how to save.....	147
resolution calibration.....	171	invert waveform	120
scale	118	recall menu tree	38
specification.....	178	roll mode.....	112
Vertical expansion mode	122	scan mode.....	111
vertical scale		x-y mode	116
expansion mode.....	122	zoom mode	114
video line	125	waveform color	20
video trigger.....	128	x-y mode	116
menu tree	40	specification.....	179
warning symbol	5	zoom waveform	114