

Multi-Channel Function Generator

MFG-2220HM

User Manual

GW INSTEK PART NO. 82MF3222HMEA1



ISO-9001 CERTIFIED MANUFACTURER

GW INSTEK

This manual contains proprietary information, which is protected by copyright. All rights are reserved. No part of this manual may be photocopied, reproduced or translated to another language without prior written consent of Good Will Corporation.

The information in this manual was correct at the time of printing. However, Good Will continues to improve its products and therefore reserves the right to change the specifications, equipment, and maintenance procedures at any time without notice.

Good Will Instrument Co., Ltd.
No. 7-1, Jhongsing Rd., Tucheng Dist., New Taipei City 236, Taiwan.

Table of Contents

SAFETY INSTRUCTIONS.....	6
GETTING STARTED	11
Main Features.....	12
Panel Overview	14
Setting Up the function Generator.....	20
QUICK REFERENCE	22
How to use the Digital Inputs.....	24
How to use the Help Menu	25
Selecting a Waveform	28
Modulation.....	31
Sweep.....	41
Burst	43
ARB	45
Utility Menu	48
Menu Tree	49
Default Settings.....	66
OPERATION	68
CH1/CH2 Channel.....	69
Pulse Channel.....	88
MODULATION.....	101
Amplitude Modulation(AM).....	104
Amplitude Shift Keying(ASK)	111
Frequency Modulation(FM)	118
Frequency Shift Keying(FSK)	125
Phase Modulation(PM).....	132
Phase Shift Keying(PSK)	139
Pulse Width Modulation	145

SUM modulation	153
Frequency Sweep	162
Burst Mode.....	173

SECONDARY SYSTEM FUNCTION

SETTINGS185

Save and Recall.....	186
Selecting the Remote Interface	189
System and Settings	194

CHANNEL SETTINGS201

DUAL CHANNEL OPERATION206

ARBITRARY WAVEFORMS.....212

Inserting Built-In Waveforms	213
Display an Arbitrary Waveform.....	215
Editing an Arbitrary Waveform	223
Output an Arbitrary Waveform	233
Saving/Recalling an Arbitrary Waveform	235

REMOTE INTERFACE.....243

Establishing a Remote Connection.....	244
Web Browser Control Interface	249
Command List	258
System Commands	262
Status Register Commands.....	265
System Remote Commands	268
Apply Commands.....	269
Output Commands	277
Pulse Configuration Commands.....	287
Harmonic Commands.....	290
Amplitude Modulation (AM) Commands	293
Amplitude Shift Keying (ASK) Commands.....	298

Frequency Modulation (FM) Commands	301
Frequency-Shift Keying (FSK) Commands	306
Phase Modulation (PM) Commands	309
Phase Shift Keying (PSK) Commands	313
SUM Modulation (SUM) Commands	316
Pulse Width Modulation (PWM) Commands	321
Frequency Sweep Commands	325
Burst Mode Commands	336
Arbitrary Waveform Commands	347
COUNTER Commands	355
PHASE Commands	357
COUPLE Commands	358
Reference Command	361
Save and Recall Commands	362
Error Messages	364
SCPI Status Register	378
APPENDIX	384
MFG-2220HM Series Specifications	384
EC Declaration of Conformity	391
GLOBL HEADQUARTERS	392
ARB Built-In Waveforms	393
INDEX	401

S SAFETY INSTRUCTIONS

This chapter contains important safety instructions that should be followed when operating and storing the function generator. Read the following before any operation to ensure your safety and to keep the function generator in the best condition.

Safety Symbols

These safety symbols may appear in this manual or on the instrument.



WARNING

Warning: Identifies conditions or practices that could result in injury or loss of life.



CAUTION

Caution: Identifies conditions or practices that could result in damage to the function generator or to other objects or property.



DANGER High Voltage



Attention: Refer to the Manual



Protective Conductor Terminal



Earth (Ground) Terminal



DANGER Hot Surface



Double Insulated



Do not dispose electronic equipment as unsorted municipal waste. Please use a separate collection facility or contact the supplier from which this instrument was purchased.

Safety Guidelines

General Guideline • Do not place heavy objects on the instrument.



CAUTION

- Do not place flammable objects on the instrument.
- Avoid severe impact or rough handling that may damage the function generator.
- Avoid discharges of static electricity on or near the function generator.
- Use only mating connectors, not bare wires, for the terminals.
- The instrument should only be disassembled by a qualified technician.

(Measurement categories) EN 61010-1:2010 (Third Edition) specifies the measurement categories and their requirements as follows. The MFG-2220HM falls under category II.

- Measurement category IV is for measurement performed at the source of a low-voltage installation.
- Measurement category III is for measurement performed in a building installation.
- Measurement category II is for measurement performed on circuits directly connected to a low voltage installation.
- Measurement category I is for measurements performed on circuits not directly connected to Mains.

Power Supply



WARNING

- AC Input voltage: 100 ~ 240V AC, 50 ~ 60Hz.
 - Connect the protective grounding conductor of the AC power cord to an earth ground to prevent electric shock.
-

Fuse  WARNING	Fuse type: T0.5A/250V <ul style="list-style-type: none"> • Only qualified technicians should replace the fuse. • To ensure fire protection, replace the fuse only with the specified type and rating. • Disconnect the power cord and all test leads before replacing the fuse. • Make sure the cause of fuse blowout is fixed before replacing the fuse.
Cleaning the function generator	<ul style="list-style-type: none"> • Disconnect the power cord before cleaning the function generator. • Use a soft cloth dampened in a solution of mild detergent and water. Do not spray any liquid into the function generator. • Do not use chemicals containing harsh products such as benzene, toluene, xylene, and acetone.
Operation Environment	<ul style="list-style-type: none"> • Location: Indoor, no direct sunlight, dust free, almost non-conductive pollution (Note below) and avoid strong magnetic fields. • Relative Humidity: < 80% • Altitude: < 2000m • Temperature: 0°C to 40°C

(Pollution Degree) EN 61010-1:2010(Third Edition) specifies pollution degrees and their requirements as follows. The function generator falls under degree 2.

Pollution refers to “addition of foreign matter, solid, liquid, or gaseous (ionized gases), that may produce a reduction of dielectric strength or surface resistivity”.

- Pollution degree 1: No pollution or only dry, non-conductive pollution occurs. The pollution has no influence.
- Pollution degree 2: Normally only non-conductive pollution occurs. Occasionally, however, a temporary conductivity caused by condensation must be expected.
- Pollution degree 3: Conductive pollution occurs, or dry, non-conductive pollution occurs which becomes conductive due to condensation which is expected. In such conditions, equipment is normally protected against exposure to direct sunlight, precipitation, and full wind pressure, but neither temperature nor humidity is controlled.

Storage environment

- Location: Indoor
- Relative Humidity: < 70%
- Temperature: -10°C to 70°C

Disposal



Do not dispose this instrument as unsorted municipal waste. Please use a separate collection facility or contact the supplier from which this instrument was purchased. Please make sure discarded electrical waste is properly recycled to reduce environmental impact.

Power cord for the United Kingdom

When using the function generator in the United Kingdom, make sure the power cord meets the following safety instructions.

NOTE: This lead/appliance must only be wired by competent persons



WARNING: THIS APPLIANCE MUST BE EARTHED

IMPORTANT: The wires in this lead are coloured in accordance with the following code:

Green/ Yellow:	Earth
Blue:	Neutral
Brown:	Live (Phase)



As the colours of the wires in main leads may not correspond with the coloured marking identified in your plug/appliance, proceed as follows:

The wire which is coloured Green & Yellow must be connected to the Earth terminal marked with either the letter E, the earth symbol \oplus or coloured Green/Green & Yellow.

The wire which is coloured Blue must be connected to the terminal which is marked with the letter N or coloured Blue or Black.

The wire which is coloured Brown must be connected to the terminal marked with the letter L or P or coloured Brown or Red.

If in doubt, consult the instructions provided with the equipment or contact the supplier.

This cable/appliance should be protected by a suitably rated and approved HBC mains fuse: refer to the rating information on the equipment and/or user instructions for details. As a guide, a cable of 0.75mm² should be protected by a 3A or 5A fuse. Larger conductors would normally require 13A types, depending on the connection method used.

Any exposed wiring from a cable, plug or connection that is engaged in a live socket is extremely hazardous. If a cable or plug is deemed hazardous, turn off the mains power and remove the cable, any fuses and fuse assemblies. All hazardous wiring must be immediately destroyed and replaced in accordance to the above standard.

G ETTING STARTED

The Getting started chapter introduces the function generator's main features, appearance, set up procedure and power-up.

Main Features	12
Panel Overview	14
MFG-2220HM Front Panel.....	14
MFG-2220HM Rear Panel	17
Display	19
Setting Up the function Generator.....	20

Main Features

- Performance
- DDS Function Generator series
 - 1 μ Hz high frequency resolution maintained at full range
 - 20ppm frequency stability
 - Arbitrary Waveform Capability
 - 250 MSa/s sample rate
 - 125 MSa/s repetition rate
 - 16k-point waveform length
 - 10 groups of 16k waveform memories
 - True waveform output to display
 - User-defined output section
 - DWR (Direct Waveform Reconstruction) capability
 - Ability to edit waveforms without a PC
 - -60dBc low distortion sine wave
-
- Features
- Sine, Square, Ramp, Pulse, Noise, Harmonic, DC waveforms
 - Internal and external LIN/LOG sweep with marker output
 - Int/Ext AM, ASK, FM, FSK, PM, PSK, SUM, PWM modulation
 - Burst function with internal and external triggers
 - Pulse waveform with configurable rise times & fall times
 - Store/recall 10 groups of setting memories
 - Output overload protection
-



- Interface
- USB interface as standard, LAN interface
 - 4.3 inch Color TFT LCD (480 X 272) graphical user interface
 - AWES (Arbitrary Waveform Editing Software) PC software

Panel Overview

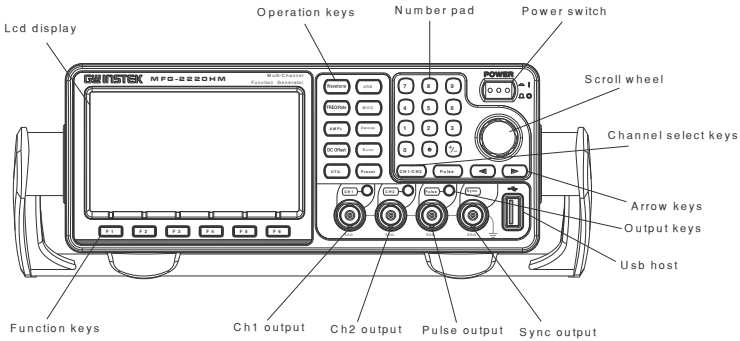
MFG-2220HM Front Panel

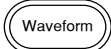
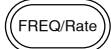

LCD Display TFT color display, 480 x 272 resolution.

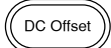
Function Keys F1~F6		Activates functions that appear on the bottom of the LCD screen.
Operation Keys		The waveform key is used to select a type of waveform.
		The FREQ/Rate key is used to set the frequency or sample rate.
		AMPL sets the waveform amplitude.
		Sets the DC offset.



The UTIL key is used to access the save and recall options, update and view the firmware version, access the calibration options, system setting, Dual channel functions and frequency meter.



ARB is used to set the arbitrary waveform parameters.



The MOD, Sweep and Burst keys are used to set the modulation, sweep and burst settings and parameters.

Preset Key

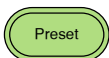

The preset key is used to recall a preset state.

Output Key



The Output key is used to turn on or off the waveform output.

Channel Select Keys



The channel select key is used to switch between the three output channels.

Output ports

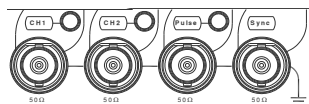

CH1: Channel 1 output port
 CH2: Channel 2 output port
 Pulse: Pulse output port
 SYNC: SYNC output port

Power Button



Turns the power on or off.

USB Host



USB type-A host port.

Arrow Keys



Used to select digits when editing parameters.

Scroll Wheel

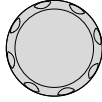

The scroll wheel is used to edit values and parameters.

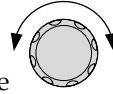

Decrease

Increase

Keypad

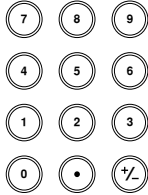

The digital keypad is used to enter values and parameters. The keypad is often used in conjunction with the arrow keys and variable knob.

MFG-2220HM Rear Panel

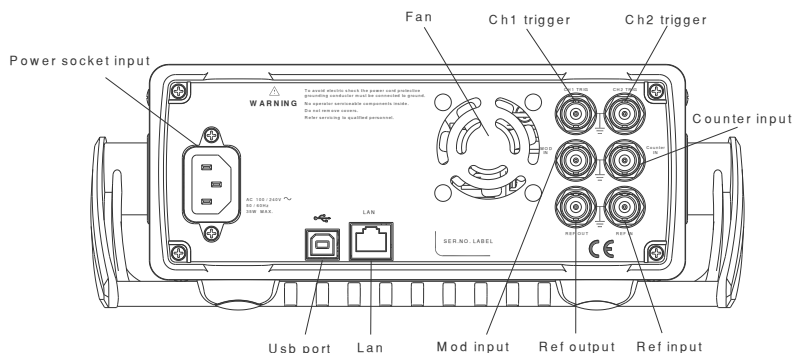

Fan

Fan.

Power Input Socket

Power input:
100~240V AC
50~60Hz.
35W MAX.

LAN Port

LAN

The LAN port is used for remote control over a network

USB Device Port

USB type-B device port is used to connect the function generator to a PC for remote control.

CH1/CH2 Trigger

External trigger input. Used to receive external trigger signals..

Counter Input

COUNTER IN

Frequency counter input.

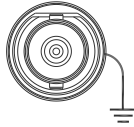

MOD Input

MOD IN

Modulation input terminal.

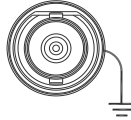

REF OUT

26.8436 MHz reference output.

REF IN

26.8436 MHz reference input.

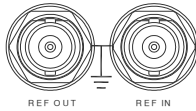

Display

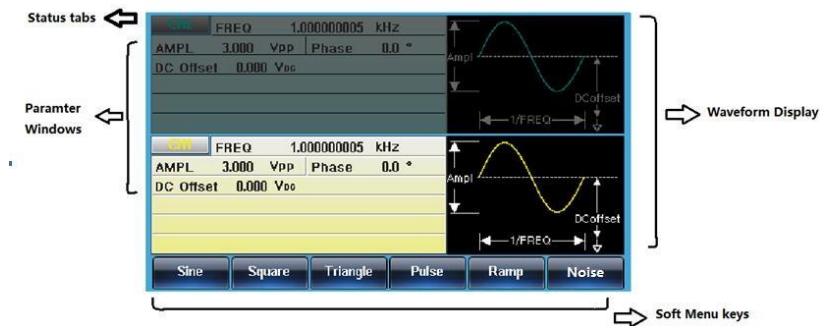

Parameter Windows The Parameter display and edit window.

Status Tabs Displays the current channel and setting status.

Waveform Display Used to display the waveform

Soft Menu Keys The function keys (F1~F6) under the LCD display correspond directly to the soft menu keys.

Setting Up the function Generator

Background This section describes how to adjust the handle and power up the function generator.

Adjusting the Handle Pull out the handle sideways and rotate it.

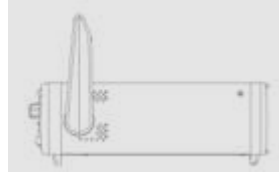

Place the MFG-2220HM horizontally,



Or tilt the stand.

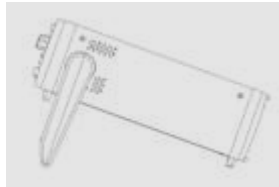

Place the handle vertically to hand carry.



Power Up 1. Connect the power cord to the socket on the rear panel.

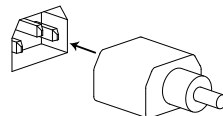

2. Turn on the power switch on the front panel.

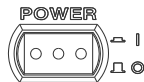

3. When the power switch is turned on the screen displays the loading screen.



The function generator is now ready to be used.

QUICK REFERENCE

This chapter describes the operation shortcuts, built-in help and factory default settings. This chapter is to be used as a quick reference, for detailed explanations on parameters, settings and limitations, please see the operation chapters.

How to use the Digital Inputs	24
How to use the Help Menu	25
Selecting a Waveform	28
Square Wave	28
Ramp Wave	28
Sine Wave	29
Harmonic Wave	29
MOdulation	31
AM Modulation	31
ASK Modulation	33
FM Modulation	34
FSK Modulation	35
PM Modulation	36
PSK Modulation	37
PWM Modulation	38
SUM Modulation	39
Sweep	41
Burst	43
ARB	45
ARB-Add Built-In Waveform	45
ARB- Add Point	45
ARB- Add Line	46
ARB- Output Section	46
Utility Menu	48
Save	48
Recall	48
Menu Tree	49

Waveform	50
Waveform_More.....	51
ARB-Display	52
ARB-Edit.....	53
ARB- Built In	54
ARB-Save.....	55
ARB-Load	56
ARB-Output	56
MOD_(CH1/CH2).....	57
MOD_More(CH1/CH2)	58
SWEEP	59
Burst- N Cycle.....	60
Burst – Gate.....	61
UTIL	62
CH1/CH2.....	65
Pulse	65
Default Settings	66

How to use the Digital Inputs

Background

The MFG-2220HM has three main types of digital inputs: the number pad, arrow keys and scroll wheel. The following instructions will show you how to use the digital inputs to edit parameters.

1. To select a menu item, press the corresponding function keys below (F1~F6). For example the function key F1 corresponds to the Soft key "Sine".



2. To edit a digital value, use the arrow keys to move the cursor to the digit that needs to be edited.

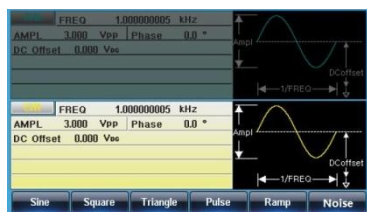

3. Use the scroll wheel to edit the parameter. Clockwise increases the value, counter clockwise decreases the value.
4. Alternatively, the number pad can be used to set the value of a highlighted parameter.

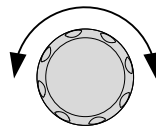

How to use the Help Menu

Background Every key and function has a detailed description in the help menu.

1. Press UTIL



2. Press System (F4)



3. Press Help (F3)



4. Use the scroll wheel to navigate to a help item. Press Select to choose the item.

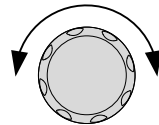

Keypad	Provides help on any front panel key that is pressed.
Create Arbitrary Waveform	Provides help on creating arbitrary waveforms.
Modulation Function	Explains how to create Modulated waveforms.

- Sweep Function Provides help on the Sweep function.
- Burst Function Provides help on the Burst function.
- DSO Link Provides help on DSO link.
- Hardcopy Explains how to use the Hardcopy function.

5. For example, select item 5 to see help on the sweep functions.



6. Use the scroll wheel to navigate the help information.

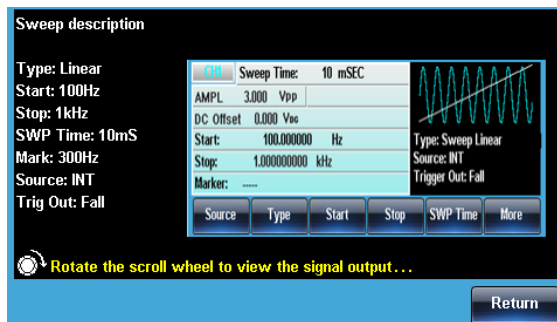

7. Press Return to return to the previous menu.

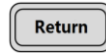

Selecting a Waveform

Square Wave

Example: Square wave, 3Vpp, 75% duty cycle, 1kHz.

Output:

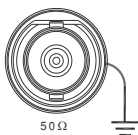

1. Press Waveform and select Square (F2).



2. Press Duty (F1), 7 + 5 + % (F5).



Input: N/A

3. Press Freq/Rate, 1 + kHz (F5).



4. Press AMPL followed by, 3 + VPP (F6).



5. Press the Output key.



Ramp Wave

Example: Ramp Wave, 5Vpp, 10kHz, 50% Symmetry.

Output:

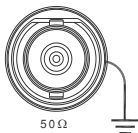

1. Press the Waveform key, and select Ramp (F5).







2. Press SYM(F1), 5 + 0 + % (F5).



Input: N/A

3. Press the Freq/Rate key then 1 + 0 + kHz (F5).



4. Press the AMPL key  5  Vpp 
5. Press the Output key. 







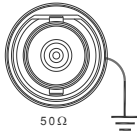





Sine Wave

Example: Sine Wave, 10Vpp,100kHz

Output:





Input: N/A

1. Press the Waveform key and select Sine  
2. Press the Freq/Rate key, followed by 1 + 0 + 0 + kHz (F5).     
3. Press the AMPL key, followed by 1 + 0 + VPP (F6).    
4. Press the output key. 

Harmonic Wave

Example: 10kHz harmonic sine wave, odd & even (all) harmonics, up to the 3rd order (2nd(5Vpp), 3rd(2Vpp), 0° phase).

- Output
1. Press the Waveform key and select More    Harmonic (F3).

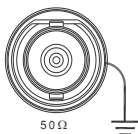

Input: N/A

2. Press Total (F1), followed by 3 + Enter (F1).



3. Press Type (F2), ALL (F3).



4. Press Order (F3).



5. Press Order (F1), followed by 2 + Enter (F5).



Press Amp(F2), followed by 5 + VPP (F5).



Press Phase(F3), followed by 0 + Degree (F5).



6. Press the Order (F1), followed by 3 + Enter (F5).



Press Amp(F2), followed by 2 + VPP (F5).



Press Phase(F3), followed by 0 + Degree (F5).



7. Press the output key.



Modulation

AM Modulation

Example: AM modulation. 100Hz modulating square wave. 1kHz Sine wave carrier. 80% modulation depth.

Output:

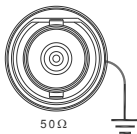

Press the MOD key and select AM (F1).



1. Press Waveform and select Sine (F1).



Input: N/A

2. Press the Freq/Rate key, followed by 1 + kHz (F5).



3. Press the MOD key, select AM (F1), Shape (F4), Square (F2).



4. Press the MOD key, select AM (F1), AM Freq (F3).



5. Press 1 + 0 + 0 + Hz (F2).



6. Press the MOD key, select AM (F1), Depth (F2).



7. Press 8 + 0 + % (F1).



8. Press MOD, AM (F1),
Source (F1), INT (F1).



9. Press the Output key.



ASK Modulation

Example: ASK modulation. 50% duty cycle. 1kHz sine carrier wave. 10Hz rate . Internal source.

Output:

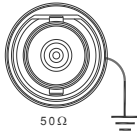

1. Press MOD and then select More(F6) and then press F2(ASK).



2. Press Waveform and select Sine(F1).



Input: N/A

3. Press the Freq/Rate key, followed by 1 + kHz (F5).



4. Press the MOD key, select More(F6) first then ASK(F2), ASK Rate (F3).



5. Press 1+ 0 + Hz (F2)



6. Press the MOD key, select More(F6) first then ASK(F2), ASK Ampl(F2).



7. Press 5+0+0+mVpp(F1).

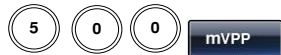

8. Press MOD, More(F6),ASK(F2), Source (F1), INT (F1).



9. Press the Output key. 





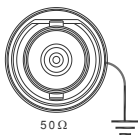

FM Modulation



Example: FM modulation. 100Hz modulating square wave. 1kHz Sine wave carrier. 100 Hz frequency deviation. Internal Source.

Output:

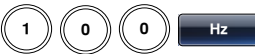

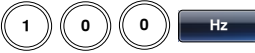
Input: N/A

1. Press the MOD key and select FM (F2). 
2. Press Waveform and select Sine (F1). 
3. Press the Freq/Rate key, followed by 1 + kHz (F5). 
4. Press the MOD key, select FM (F2), Shape (F4), Square (F2). 
5. Press the MOD key, select FM (F2), FM Freq (F3). 
6. Press 1 + 0 + 0 + Hz (F2). 
7. Press the MOD key, select FM (F2), Freq Dev (F2). 
8. Press 1 + 0 + 0 + Hz (F3). 

9. Press MOD, FM (F2), Source (F1), INT (F1).
 
10. Press the Output key.
 





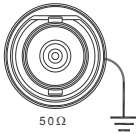

FSK Modulation



Example: FSK modulation. 100Hz Hop frequency. 1kHz Carrier wave. Sine wave. 10 Hz Rate. Internal Source.

Output:



Input: N/A

1. Press the MOD key and select FSK (F3).
 
2. Press Waveform and select Sine (F1).
 
3. Press the Freq/Rate key, followed by 1 + kHz (F5).
 
4. Press the MOD key, select FSK (F3), FSK Rate (F3).
 
5. Press 1 + 0 + Hz (F2).
 
6. Press the MOD key, select FSK (F3), Hop Freq (F2).
 
7. Press 1 + 0 + 0 + Hz (F3).
 



8. Press MOD, FSK (F3), Source (F1), INT (F1).
 
9. Press the output key.
 

PM Modulation



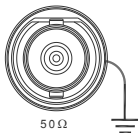



Example: PM modulation. 800Hz sinusoidal carrier wave. 15 kHz modulating sine wave. 180° phase deviation. Internal Source.

Output:

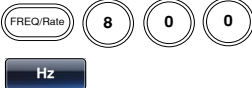

1. Press Waveform and select Sine (F1).
 
2. Press the MOD key and select PM (F4).
 

Input: N/A

3. Press the Freq/Rate key, followed by 8 + 0 + 0 + Hz (F4).
 
4. Press the MOD key, select PM (F4), Shape (F4), Sine (F1).
 
5. Press MOD, then PM (F4), PM Freq (F3).
 
6. Press 1 + 5 + kHz (F3).
 
7. Press MOD, PM (F4), Phase Dev (F2).
 
8. Press 5 + 0 + Degree (F1).
 

9. Press MOD, PM (F4), Source (F1), INT (F1).

MOD
PM
Source

INT

10. Press the Output key.



PSK Modulation

Example: PSK modulation. 50° phase deviation. 1kHz sine carrier wave. 10Hz PSK rate. Internal source.

Output

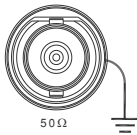

1. Press MOD and select More (F6) first then PSK (F3).

MOD
More
PSK

2. Press Waveform and select Sine(F1).

Waveform
Sine

Input: N/A

3. Press the Freq/Rate key, followed by 1 + kHz (F5).

FREQ/Rate
1
kHz

4. Press the MOD key, select More (F6) first then PSK(F3), PSK Rate (F3).

MOD
More
PSK

PSK Rate



5. Press 1 + 0 + Hz (F2)

1
0
Hz

6. Press the MOD key, select More (F6) first then PSK(F3), PSK Phase (F2).

MOD
More
PSK

PSK Phase





7. Press 5+ 0 + Degree(F1)
 
8. Press MOD, More (F6) first then PSK(F3), Source (F1), INT (F1)
 
9. Press the Output key
 

PWM Modulation

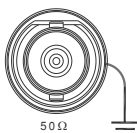

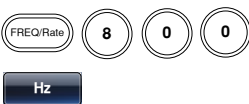

Example: PWM modulation. 800Hz carrier, 15kHz modulated sine wave. 50% duty cycle. Internal source.

Output:



1. Press Waveform and select Square (F2)
 
2. Press MOD and select More(F6) first then select PWM(F1)
 
3. Press the Freq/Rate key, followed by 8+0+0 Hz (F4).
 
4. Press the MOD key, select More (F6) first then PWM (F1), Shape (F4), Sine(F1).
 
5. Press MOD, select More (F6) first then PWM(F1), PWM Freq(F3)
 

Input: N/A



6. Press 1 + 5+ kHz (F3). 
7. Press MOD, select More (F6) first then PWM(F1),Duty(F2) 
8. Press 5 + 0 + % (F1) 
9. Press MOD, More(F6), PWM(F1) Source(F1),INT(F1) 
10. Press the Output key. 

SUM Modulation

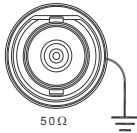

Example: SUM modulation. 100Hz modulating square wave, 1kHz sinusoidal carrier wave, 50% SUM amplitude, internal source.

Output:





1. Press the MOD key, then SUM (F5). 
2. Press Waveform, and select Sine (F1). 

Input: N/A

3. Press Freq/Rate followed by 1 + kHz (F5). 
4. Press the MOD key, SUM (F5), Shape (F4), Square (F2). 

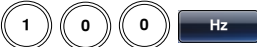
5. Press the MOD key and select SUM (F5), SUM Freq (F3).
 

6. Press 1 + 0 + 0 + Hz (F2).
 

7. Press the MOD key and select SUM (F5), SUM Ampl (F2).
 

8. Press 5 + 0 + % (F1).
 

9. Press MOD, SUM (F5), Source (F1), INT (F1).
 

10. Press the Output key.
 

Sweep

Example: Frequency Sweep. Start Frequency 10mHz, Stop frequency 1MHz. Log sweep, 1 second sweep, Marker Frequency 550 Hz, Manual Trigger.

Output:

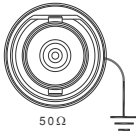

1. Press Sweep, Start (F3).



2. Press 1 + 0 + mHz (F2).



3. Press Sweep, Stop (F4).



Input: N/A

4. Press 1 + MHz (F5).



5. Press Sweep, Type (F2), Log (F2).



6. Press Sweep, SWP Time (F5).



7. Press 1 + SEC (F2).



8. Press Sweep, More (F6), Marker (F3), ON/OFF (F2), Freq (F1).



9. Press 5 + 5 + 0 + Hz (F3).



10. Press the Output key.



11. Press Sweep, Source
(F1), Manual (F3),
Trigger (F1).



Burst

Example: Burst Mode, N-Cycle (Internally triggered), 1kHz burst frequency, Burst count = 5, 10 ms Burst period, 0° burst phase, Internal trigger, 10 us delay, rising edge trigger out

Output:

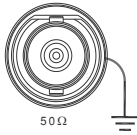

1. Press **FREQ/Rate** 1 kHz (F5).



2. Press **Burst**, **N Cycle** (F1), **Cycles** (F1).



Input: N/A

3. Press **5** + **Cyc** (F5).



4. Press **Burst**, **N Cycle** (F1), **Period** (F4).



5. Press **1** + **0** + **mSEC** (F2).

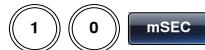

6. Press **Burst**, **N Cycle** (F1), **Phase** (F3).



7. Press **0** + **Degree** (F5).



8. Press **Burst**, **N Cycle** (F1), **TRIG** set (F5), **INT** (F1).



9. Press **Burst**, **N Cycle** (F1), **TRIG** set (F5), **Delay** (F4).



10. Press **1** + **0** + **uSEC** (F5).



11. Press Burst, N Cycle (F1), TRIG setup (F5), TRIG out (F5), ON/OFF (F3), Rise (F1).



12. Press the Output key.



ARB

ARB—Add Built-In Waveform

Example: ARB Mode, Exponential Rise. Start 0, Length 100, Scale 327.

Output:

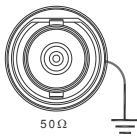

1. Press ARB, Built in (F3), Wave (F4), Math(F2), use the scroll wheel to select Exporise and then press Select(F5).



2. Press Start (F1), 0 + Enter (F2), Return.

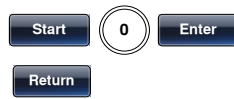

3. Press Length (F2), 100, Enter (F2), Return.



4. Press Scale (F3), 327, Enter (F2), Return, Done (F5).



ARB- Add Point

Example: ARB Mode, Add point, Address 40, data 300.

Output:

1. Press ARB, Edit (F2), Point (F1), Address (F1).



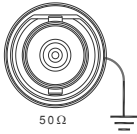

2. Press 4 + 0 + Enter (F5), Return.



3. Press Data (F2), 3+0+0, Enter (F5).

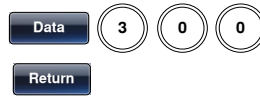

ARB- Add Line

Example: ARB Mode, Add line, Address:Data (10:30, 50:100)

Output:

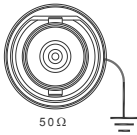

1. Press ARB, Edit (F2), Line (F2), Start ADD (F1).



2. Press 1 + 0 + Enter (F5), Return.



3. Press Start Data (F2), 3 + 0, Enter (F5), Return.



4. Press Stop ADD (F3), 5 + 0, Enter (F5), Return.



5. Press Stop Data (F4), 1 + 0 + 0, Enter (F5), Return, Done (F5).



ARB– Output Section

Example: ARB Mode, Output ARB Waveform, Start 0, Length 1000.

Output:

1. Press ARB, Output (F6).



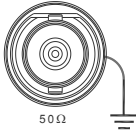

2. Press Start (F1), 0 + Enter (F5), Return.

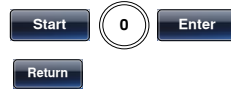



3. Press Length (F2), 1 + 0 + 0, Enter (F5), Return.



Utility Menu



Save

Example: Save to Memory file #5.

1. Press UTIL, Memory (F1), Store (F1).

2. Choose a setting using the scroll wheel and press Done (F5).

Recall

Example: Recall Memory file #5.

1. Press UTIL, Memory (F1), Recall (F2).

2. Choose a setting using the scroll wheel and press Done (F5).

Menu Tree

Conventions Use the menu trees as a handy reference for the function generator functions and properties. The MFG-2220HM menu system is arranged in a hierarchical tree. Each hierarchical level can be navigated with the operation or soft menu keys. Pressing the Return key will return you to the previous menu level.

For example: To set the interface to USB;

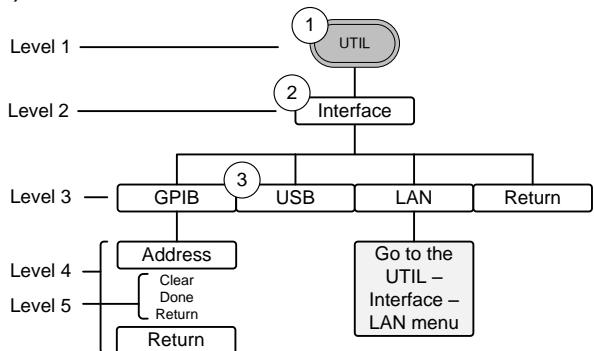
- (1) Press the UTIL key.
- (2) The Interface soft-key.
- (3) USB.



Waveform

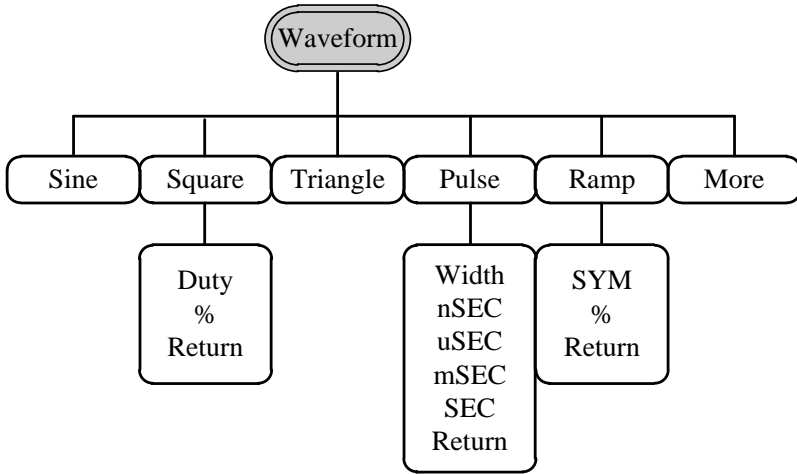

Waveform_More

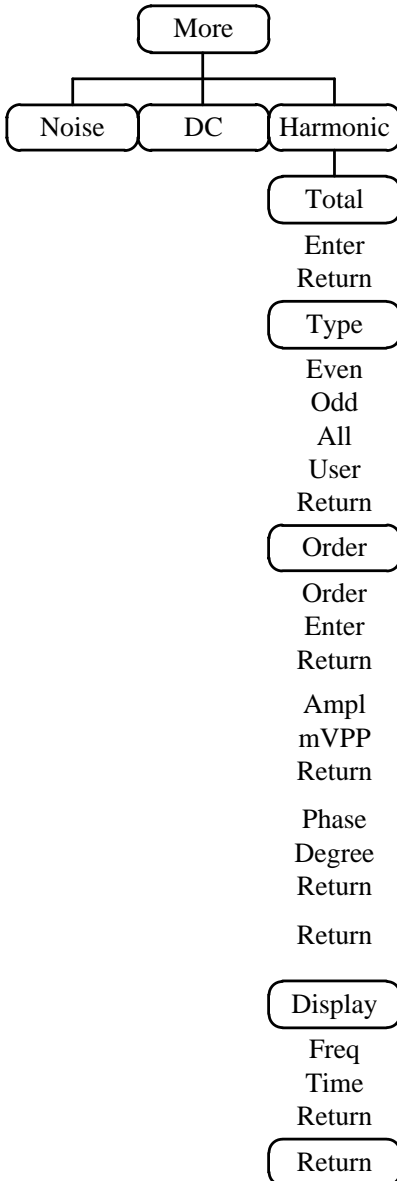

ARB-Display

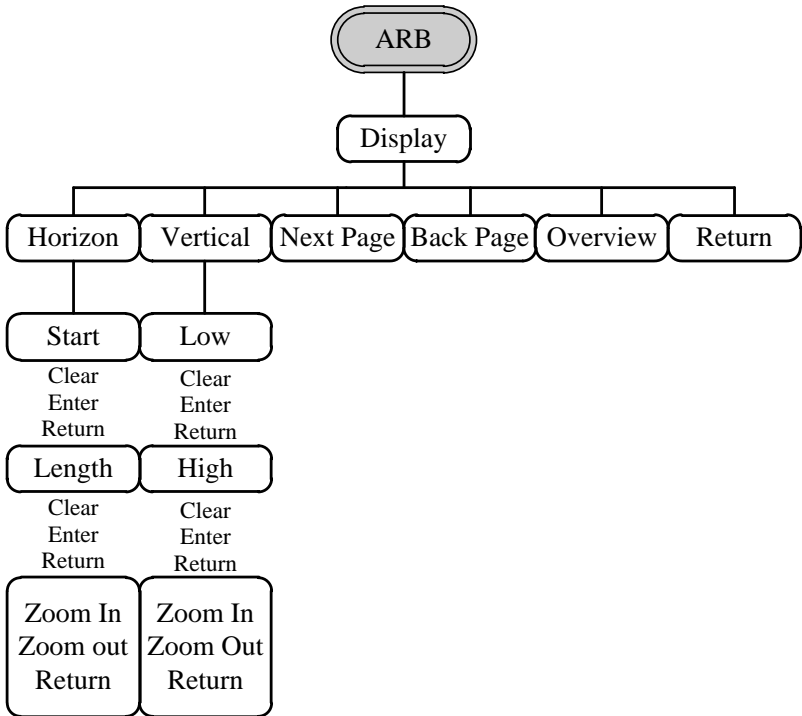

ARB-Edit

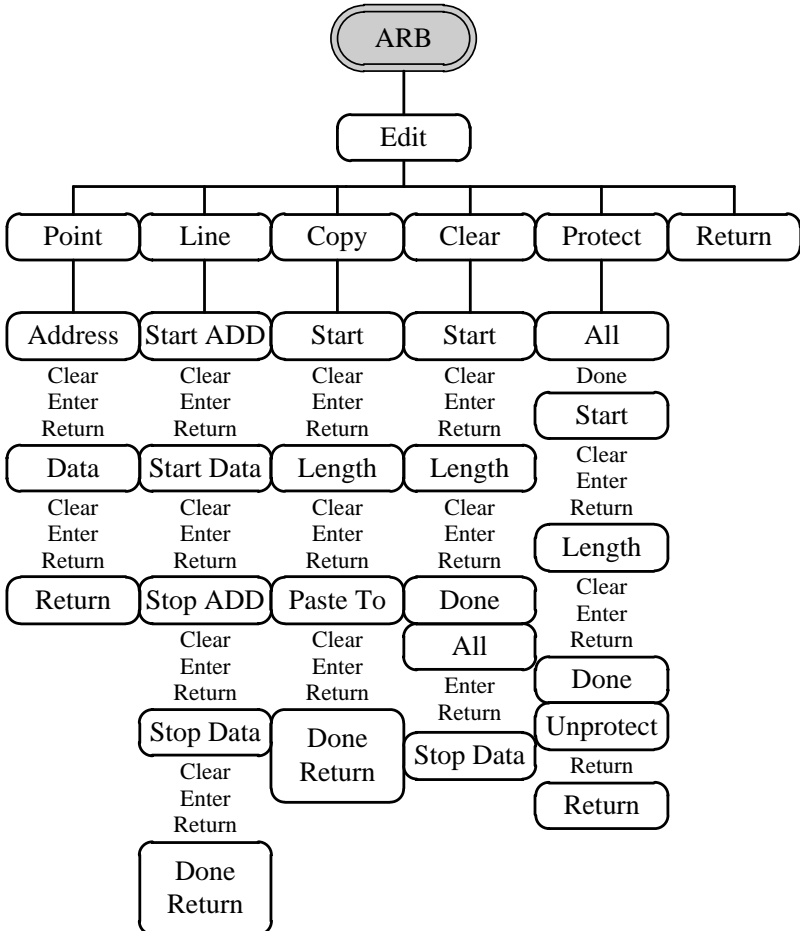

ARB- Built In

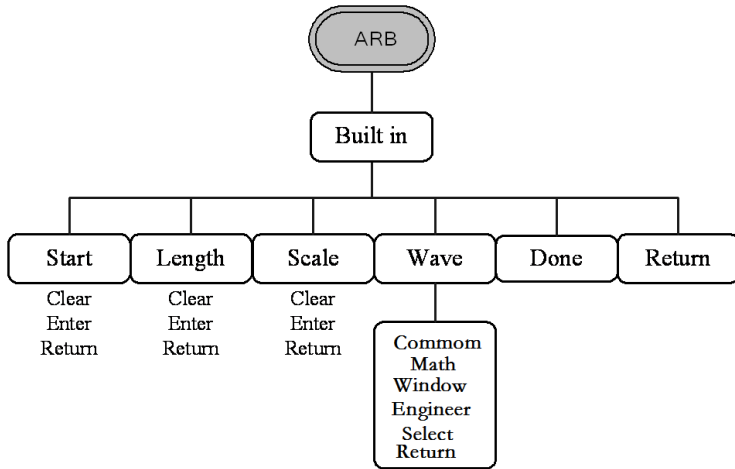

ARB-Save

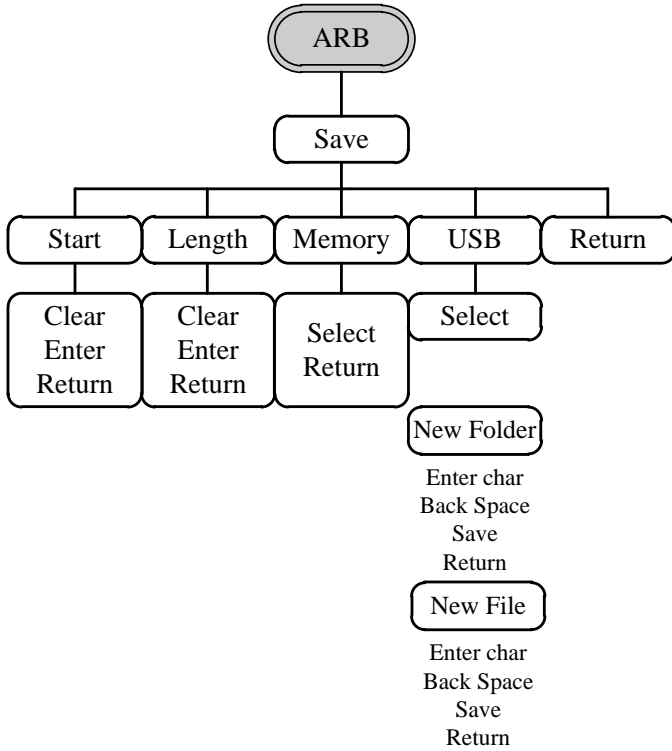

ARB-Load

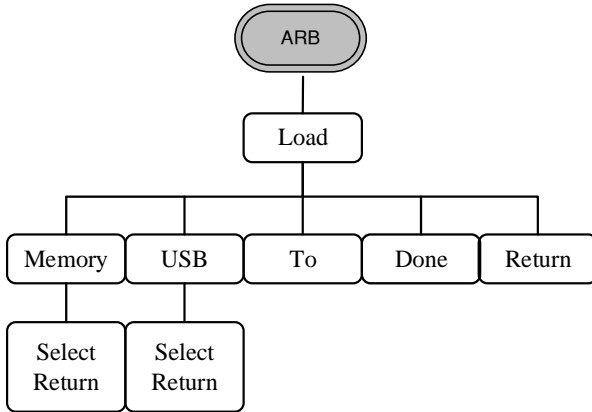

ARB-Output

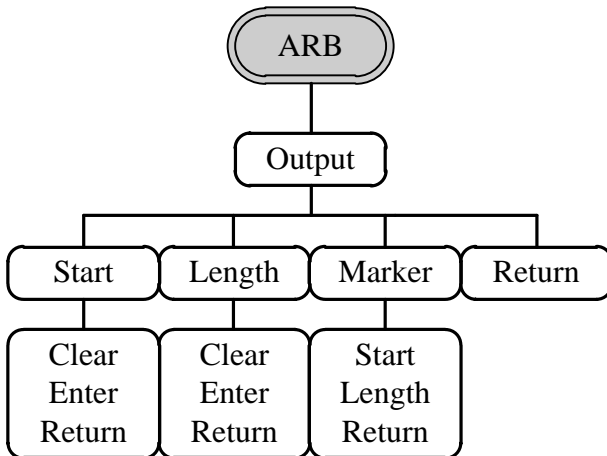

MOD_(CH1/CH2)

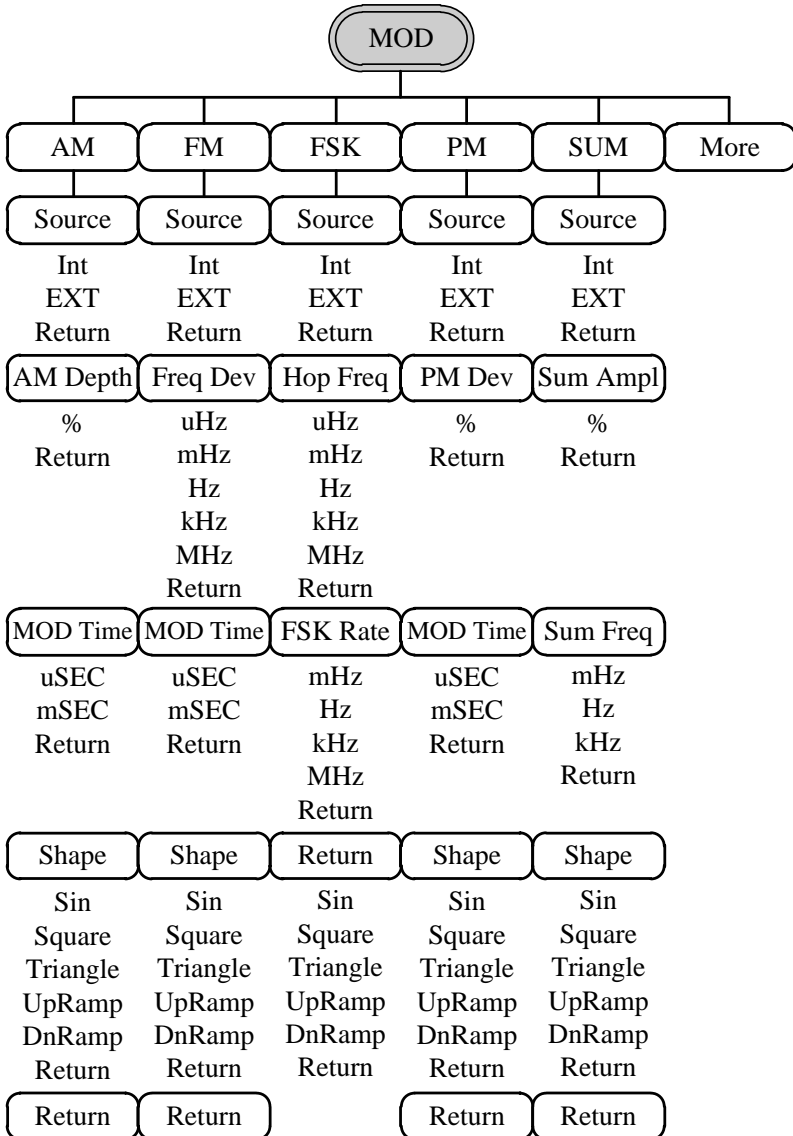

MOD_More(CH1/CH2)

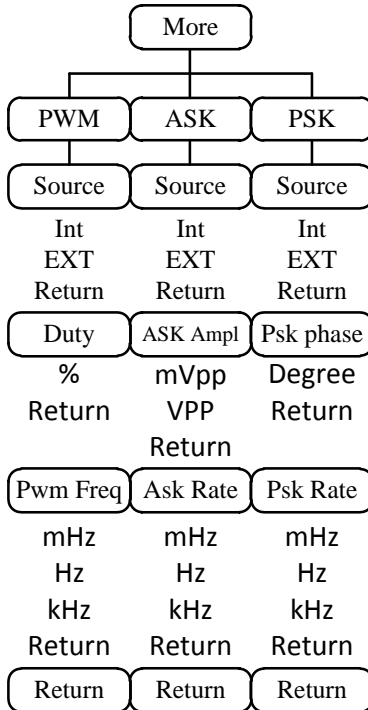

SWEEP

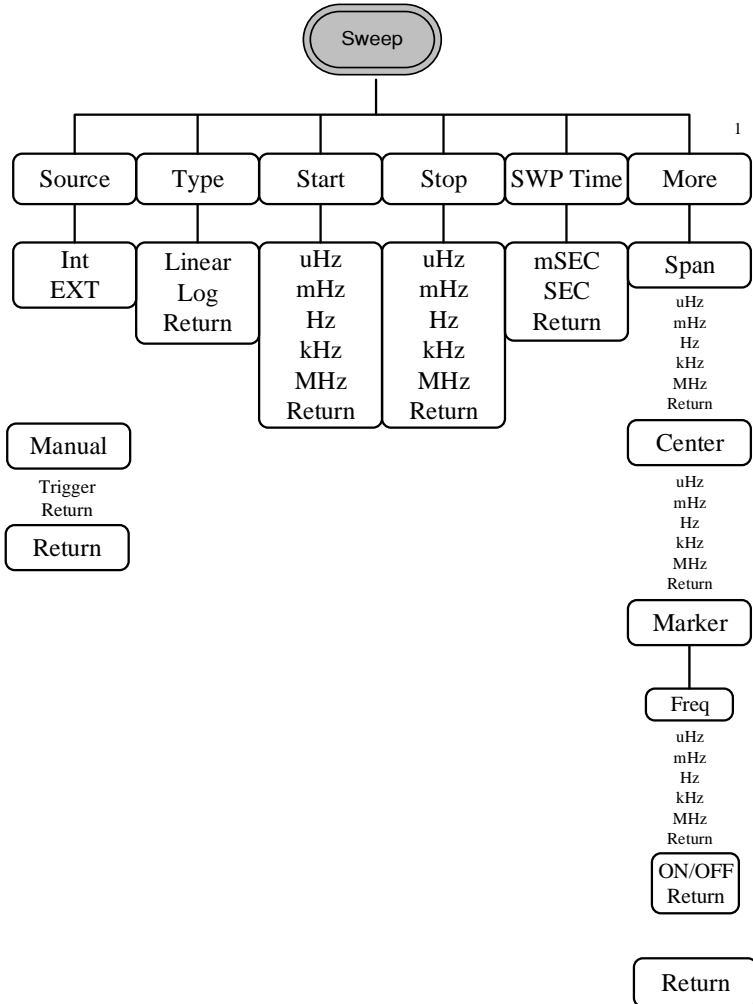

Burst- N Cycle

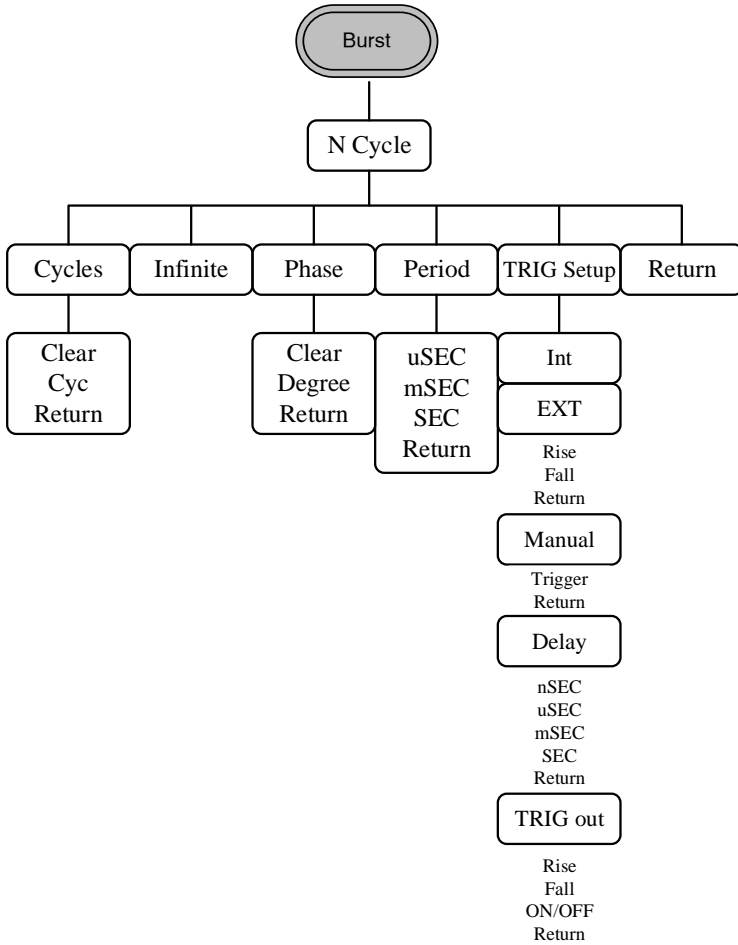

Burst – Gate

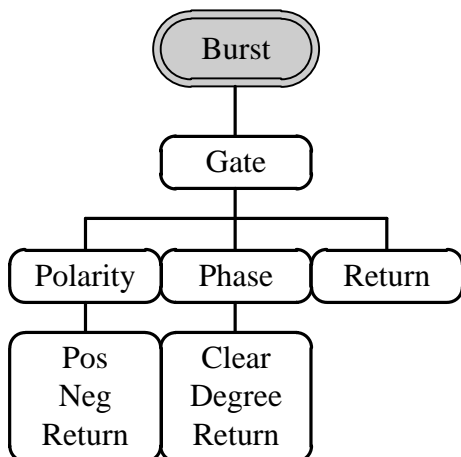

UTIL

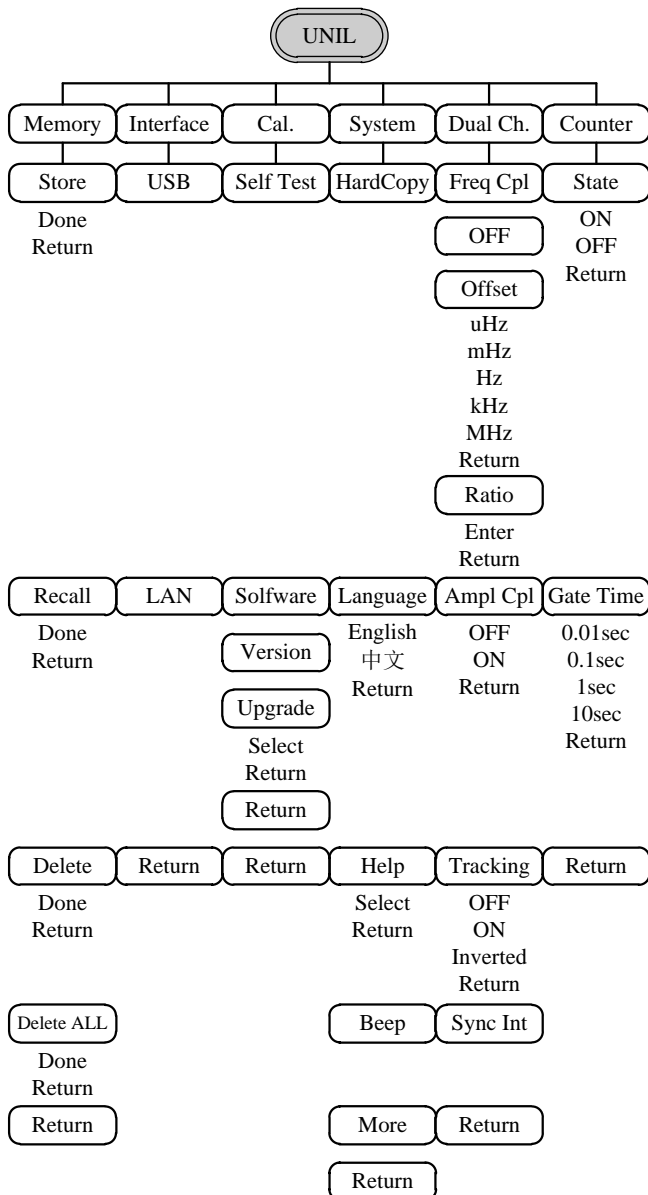

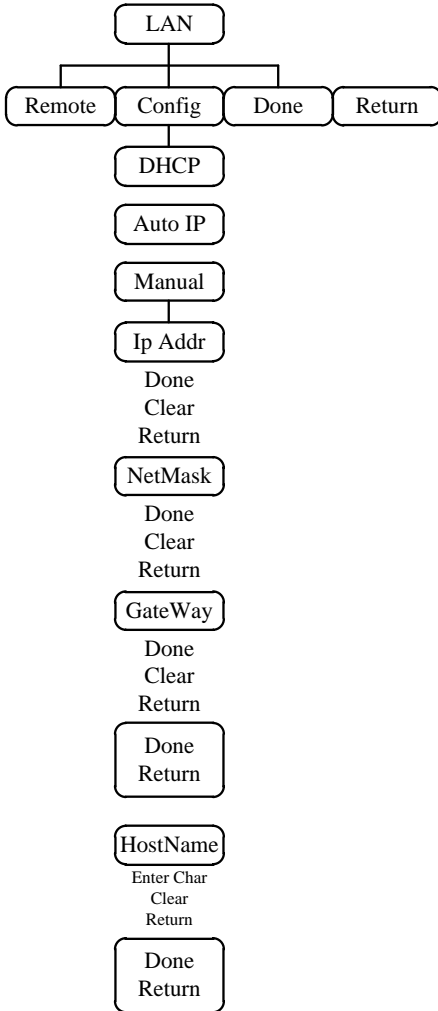

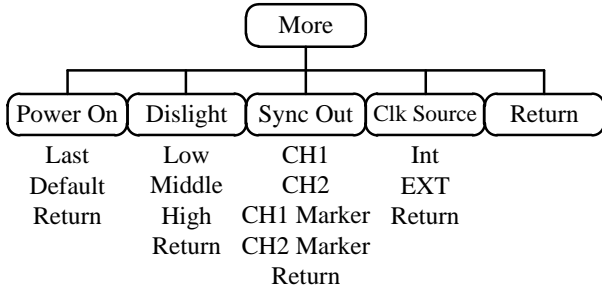

CH1/CH2

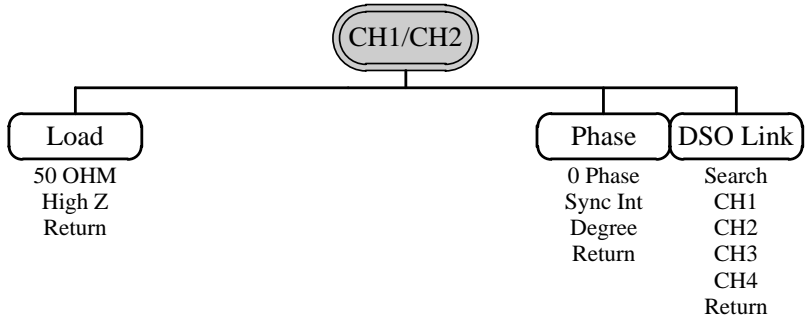

Pulse

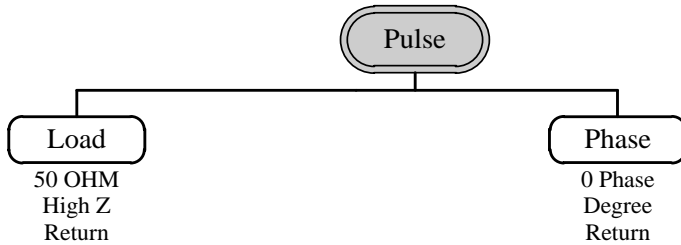

Default Settings

The Preset key is used to restore the default panel settings.



Output Settings	Function	Sine Wave
	Frequency	1kHz
	Amplitude	3.000 V _{pp}
	Offset	0.00V dc
	Output units	V _{pp}
	Output terminal	50Ω
Modulation		
(AM/ASK/FM/FSK/PM/PSK/SUM)		
	Carrier wave	1kHz sine wave
	Modulation wave	100Hz sine wave
	AM depth	100%
	ASK amplitude	500mV _{pp}
	ASK frequency	10Hz
	FM deviation	100Hz
	FSK hop frequency	100Hz
	FSK frequency	10Hz
	PM phase deviation	180°
	PSK phase	180°
	PSK frequency	10Hz
	SUM amplitude	50%
	Modem status	Off
PWM Modulation		
	Carrier wave	1kHz Square wave
	Modulation wave	50kHz sine wave
	PWM duty cycle	50%

	Modem status	Off
Sweep	Start/Stop frequency	100Hz/1kHz
	Sweep time	1ms
	Sweep type	Linear
	Sweep status	Off
Burst	Burst frequency	1kHz
	Ncycle	1
	Burst period	10ms
	Burst starting phase	0°
	Burst status	Off
System Settings	Power off signal	On
	Display mode	On
	Error queue	Cleared
	Memory settings	No change
	Output	Off
Trigger	Trigger source	Internal (immediate)
Calibration	Calibration Menu	Restricted

OPERATION

The Operation chapter shows how to output basic waveform functions. For details on modulation, sweep, burst and arbitrary waveforms, please see the Modulation and Arbitrary waveform chapters on pages 10101 and 212.

CH1/CH2 Channel.....	69
Select Channel.....	69
Setup a Waveform.....	69
Sine Waveform.....	69
Square Waveform.....	70
Triangle Waveform.....	72
Pulse Waveform.....	72
Ramp Waveform.....	74
Noise Waveform.....	75
Harmonic Wave.....	76
DC Wave.....	80
Setting the Load.....	81
Setting the Frequency.....	83
Setting the Amplitude.....	84
Setting the DC Offset.....	85
Setting the Phase.....	86
Pulse Channel.....	88
Setup Pulse waveform.....	88
Setting the Pulse Duty Time.....	89
Setting the Pulse Width.....	90
Setting the Pulse Leading Edge Time.....	92
Setting the Pulse Trailing Edge Time.....	93
Setting the Load.....	95
Setting the Frequency.....	96
Setting the Amplitude.....	97
Setting the DC Offset.....	98
Setting the Phase.....	99

CH1/CH2 Channel

As the MFG-2220HM Serie are multi channel models, the desired output channel must first be selected before assigning the operation for that channel.

Select Channel

Panel Operation 1. Press the CH1/CH2 key.



2. The selected channel will be visible while the deselected channel will be dimmed.

In the screen shot below, CH1 is selected.

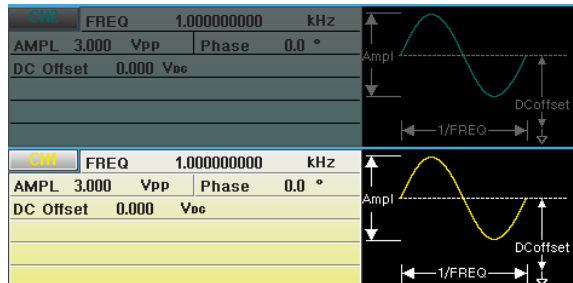

Setup a Waveform

The MFG-2220HM series can output 6 standard waveforms: sine, square, triangle, pulse, ramp and noise.

Sine Waveform

Panel Operation 1. Press the Waveform key.



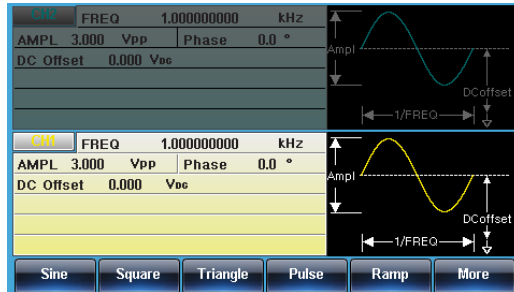

2. Press F1 (Sine) to create a sine waveform. Sine F 1

Parameter settings

3. To set the parameter Load/Frequency/Amplitude/DC Offset/Phase, please refer to page 76 - 87.

Square Waveform

- Panel Operation
1. Press the Waveform key. Waveform

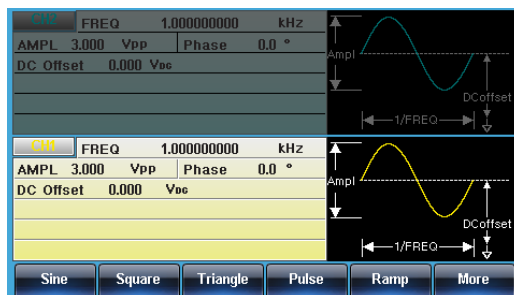

2. Press F2 (Square) to create a square waveform. Square F 2

Parameter settings

3. Press F1 (Duty). The Duty parameter will be highlighted in the parameter window.

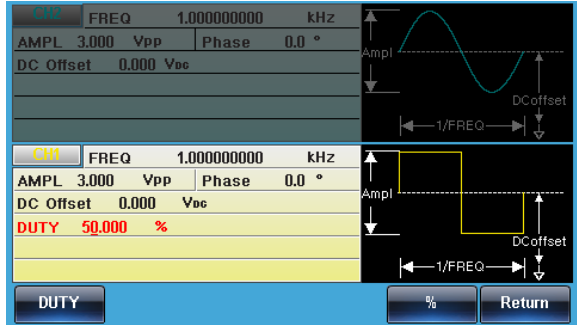

4. There are two ways to set its value :
 - a, Use the arrow keys and scroll wheel
 - b, number pad to enter the Duty range.

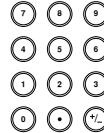

Press F5 (%) to select % units.



Note

Range Duty 0.01%~99.99%(limited by the current frequency setting)

Parameter settings

5. To set the parameter Load/Frequency/Amplitude/DC Offset/Phase, please refer to page 76 - 87.

Triangle Waveform

Panel Operation 1. Press the Waveform key.

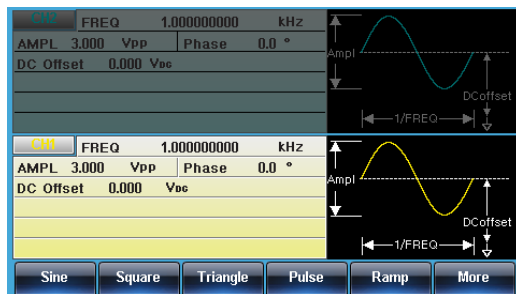

2. Press F3 (Triangle) to create a triangle waveform.

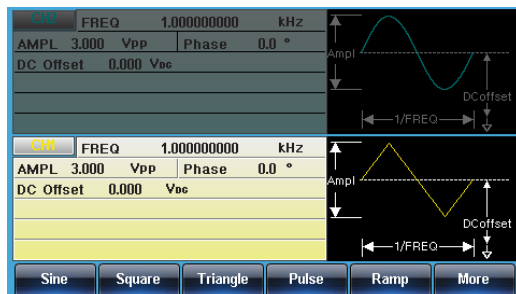

Parameter settings

3. To set the parameter Load/Frequency/Amplitude/DC Offset/Phase, please refer to page 76 - 87.

Pulse Waveform

Panel Operation 1. Press the Waveform key.



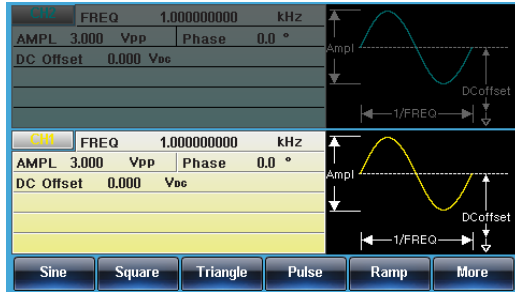

2. Press F4 (Pulse) to create a pulse waveform.



Parameter settings

3. Press F1 (Width). The Width parameter will be highlighted in the parameter window.

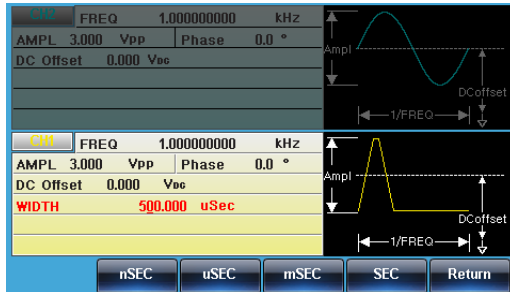

4. There are two ways to set its value :

a, Use the arrow keys and scroll wheel



b, number pad to enter the Duty range.

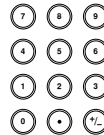

Press F2~F5 choose the unit range.



Range Pulse Width $\geq 20\text{ns}$ (limited by the current frequency setting)

- To set parameter Load/Frequency/Amplitude/DC Offset/Phase, please refer to page 76 - 87.

Ramp Waveform

Panel Operation 1. Press the Waveform key.

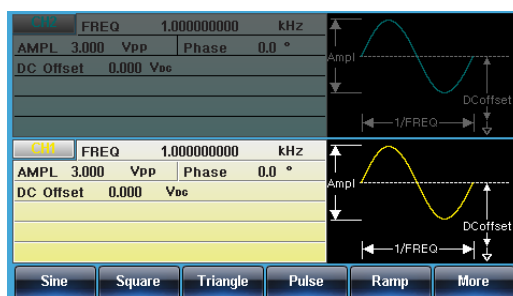

- Press F5 (Ramp) to create a ramp waveform.



Parameter settings

- Press F1 (SYM). The SYM parameter will be highlighted in the parameter window.



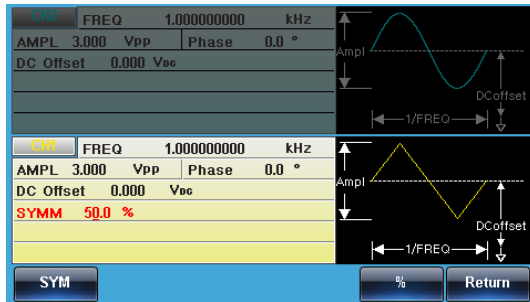

4. There are two ways to set its value :
- a, Use the arrow keys and scroll wheel



- b, number pad to enter the Duty range.



Press F5 (%) to choose % units.



Range Symmetry 0%~100%

5. To set parameter Load/Frequency/Amplitude/DC Offset/Phase, please refer to page 76 - 87.

Noise Waveform

- Panel Operation 1. Press the Waveform key.



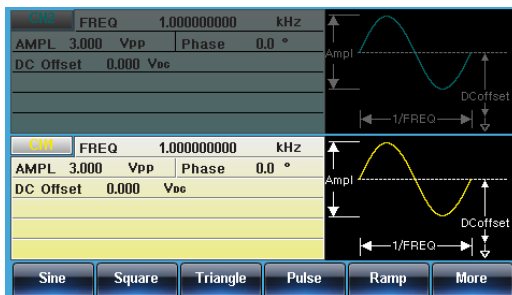

2. Press F6 (Noise) to create a noise waveform.

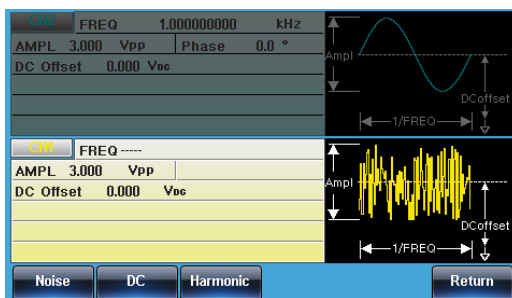

Parameter settings

3. To set parameter Load/Amplitude/DC Offset, please see page 76 - 87.

Harmonic Wave

The harmonic wave function creates a harmonic sine wave with a designated number of harmonics.

Panel Operation

4. Press the Waveform key.

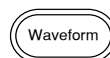

5. Press F6 (More).



6. Press F2 (Harmonic).



7. Press F1 (Total) to choose the total number of harmonics. This includes the fundamental harmonic.



8. Use the selector keys and scroll wheel or number pad to enter the number of harmonics.

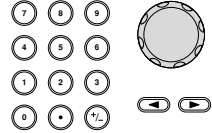

Range Number of harmonics 2 ~ 8

9. Press F1 (Enter).

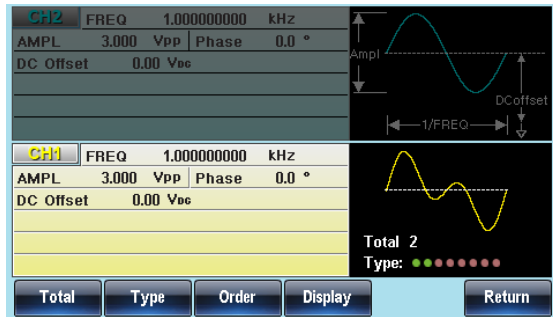

Harmonic Order

After the total number of harmonics has been selected(above), you can also select which harmonic orders are used: odd, even, all or a user-defined set.

- Panel Operation 10. Press the Waveform key.



11. Press F6 (More).



12. Press F2 (Harmonic).



13. Press F2 (Type).



14. Press F1 ~ F4 to chose which harmonic orders to include in the resultant harmonic waveform.



Note: You may have to wait a short while for the meter to process the waveform.

Range	Harmonic	Even, Odd, ALL, User
-------	----------	----------------------

Selecting User-Defined Orders

15. If User was chosen, each order can be individually selected or deselected.

16. Turn the User defined orders on or off:

Turn the scroll wheel to move the cursor to the desired order in the “Type” parameter on the waveform display screen.



- Selected orders are shown as green dots.
- Deselected orders are shown as grey dots.
- The cursor is shown as a yellow dot.
- Orders are shown from 1st (left side) to 8th (right side).

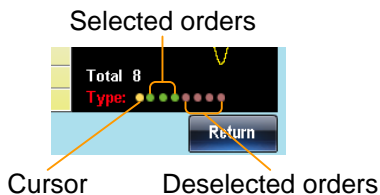

17. Turn the selected order on or off using the F1 or F2 soft-keys.



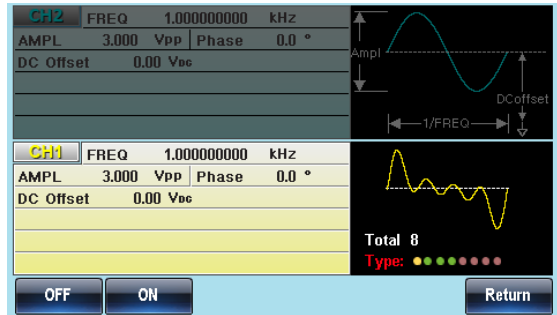

Harmonic Characteristics

The amplitude and phase of each harmonic order can individually set. By default the amplitude is the same as the fundamental frequency and the phase is set to 0°.

Panel Operation 18. Press the Waveform key.



19. Press F6 (More).



20. Press F2 (Harmonic).



21. Press F3 (Order).



22. Press F1 (Order).



23. The Order parameter will become highlighted in red.

24. Use the selector keys and scroll wheel or number pad to select an order.

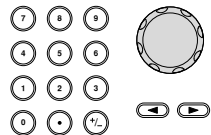

25. Press F5 (Enter).



26. Press F2 (Amplitude).



27. Use the selector keys and scroll wheel or number pad to set the amplitude of previously selected order.

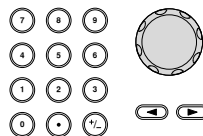

28. Choose the amplitude unit by pressing F4~F5.



29. Press F3 (Phase).



30. Use the selector keys and scroll wheel or number pad to set the phase of the previously selected order.

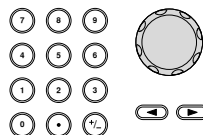

31. Press F5 (Degree).



DC Wave

Panel Operation 32. Press the Waveform key.



33. Press F6 (More).



34. Press F3 (DC).



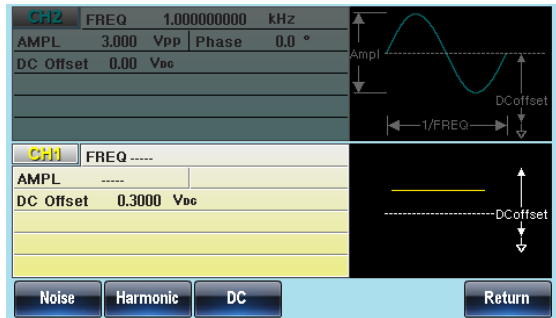

Setting the Load

Panel Operation 1. Press the CH1/CH2 key.

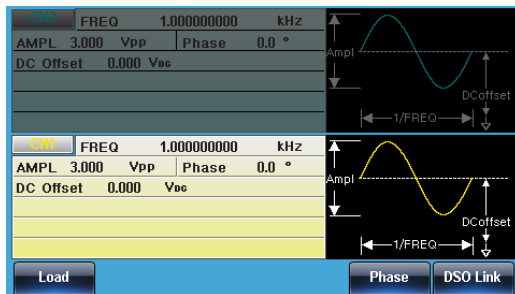

Parameter settings

2. Load setting. Select the corresponding channel and then press F1(Load) to enter the following interface.



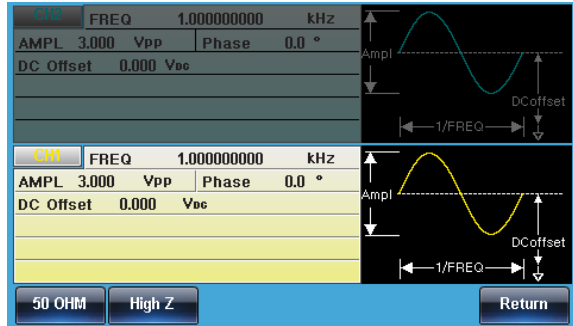

3. Press the F1(50OHM) or F2(High Z) to set the Load value.



Note

AMPL is twice under High Z loading than that at 50 ohm. Users can check load setting state for each channel in UTIL.

Setting the Frequency

Panel Operation 1. Press the **FREQ/Rate** key.



2. The **FREQ** parameter will become highlighted in the parameter window.

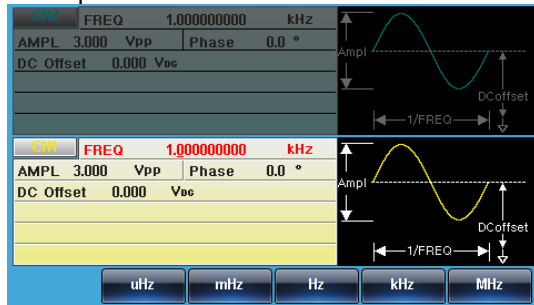

Parameter settings

3. There are two ways to set its value :

a, Use the arrow keys and scroll wheel



b, number pad to enter the Duty range.

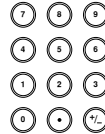

Choose a frequency unit by pressing **F2 ~F6**.



Note

- Range Sine wave 1μHz~200MHz(max)
- Square wave 1μHz~60MHz(max)
- Pulse wave 1μHz~50MHz(max)
- Ramp wave 1μHz~1MHz

Setting the Amplitude

Panel Operation 1. Press the AMPL key.



2. The AMPL parameter will become highlighted in the parameter window.

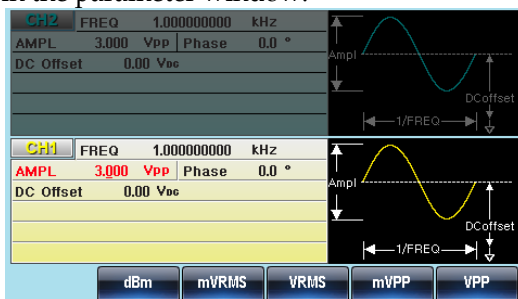

Parameter settings

3. There are two ways to set its value :

a, Use the arrow keys and scroll wheel



b, number pad to enter the Duty range.

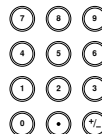

Choose a unit type by pressing F2~F6.



Note

	50Ω load	High Z
Range	1mVpp~10Vpp	2mVpp~20Vpp
Unit	Vpp, Vrms, dBm	

Setting the DC Offset

Panel Operation 1. Press the DC Offset key.



2. The DC Offset parameter will become highlighted in the parameter window.



Parameter settings

3. There are two ways to set its value :

a, Use the arrow keys and scroll wheel



b, number pad to enter the Duty range.

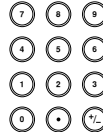

Press F5 (mVDC) or F6 (VDC) to choose a voltage range.



Note

	50Ω load	High Z
Range	±5Vpk	±10Vpk

Setting the Phase

Panel Operation 1. Press the CH1/CH2 key.

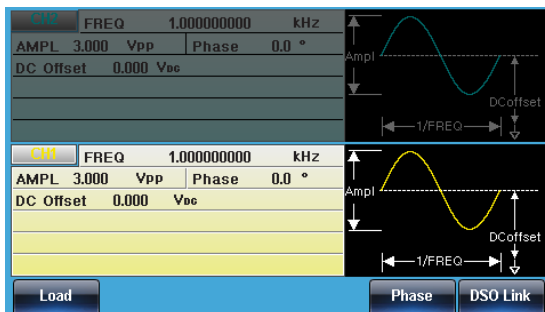

Parameter settings

2. Phase setting. Select the corresponding channel and then press F5(Phase).

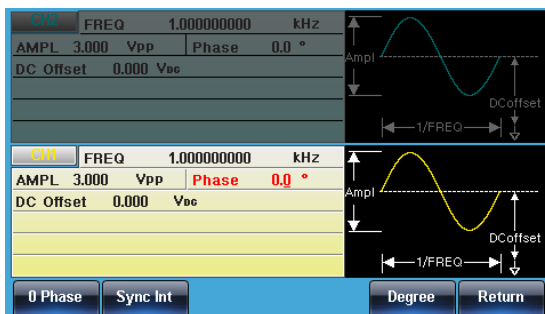

3.

4. There are two ways to set its value :

a, Use the arrow keys and scroll wheel



b, number pad to enter the Duty range.

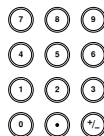

Press F5 (Degree) to choose the units.



There are two quick operations to enter the phase setting interface:

The current channel phase is set to zero
Set the phase of CH1/CH2 to zero



Pulse Channel

As the MFG-2220HM Series are multi channel models, the desired output channel must first be selected before assigning the operation for that channel.

Setup Pulse waveform

Panel Operation 1. Press the Pulse or Pulse key to Select Pulse.



2. The selected channel will be visible while the deselected channel will be dimmed.

In the screen shot below, Pulse is selected.

Pulse	FREQ	1.000000000	kHz
AMPL	2.000	Vpp	Phase 0.0 °
DC Offset	0.000	Voc	
WIDTH	500.000	uSec	
Lead Edge		10	nSec
Trail Edge		10	nSec

Setting the Pulse Duty Time

Instead of setting the pulse width of the pulse, the duty of the pulse can be set. The settable duty times depend on the leading & trailing edge time settings, as defined below:

$$\text{Pulse Duty Cycle} \geq 100 \times \text{Minimum Pulse Width} \div \text{Pulse Period}$$

$$\text{Pulse Duty Cycle} < 100 \times (1 - \text{Minimum Pulse Width} \div \text{Pulse Period})$$

Panel Operation 1. Press the Waveform key.

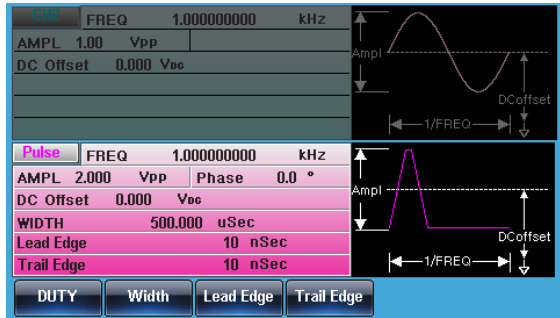

2. Press F1 (DUTY). The DUTY parameter will be highlighted in the parameter window.

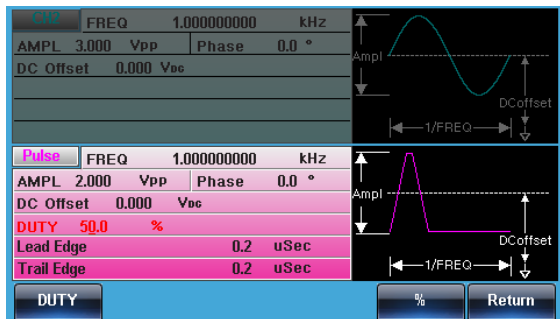

1. There are two ways to set its value :

a, Use the arrow keys and scroll wheel



b, number pad to enter the Duty range.

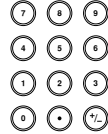

Press F5 to choose the % unit.



Duty Range 0.01%~99.99% (limited by the current frequency setting)

2. To set parameter Load/Frequency/Amplitude/DC Offset/Phase, please see page 95 - 99.

Setting the Pulse Width

The pulse width settings depend on the rise & fall time settings or the edge time setting and the period settings, as defined below:

Pulse Width \geq Minimum Pulse Width

Pulse Width $<$ Pulse Period - Minimum Pulse Width

Pulse width is defined as the time from the 50% rising edge threshold to the 50% falling edge threshold of one full period.

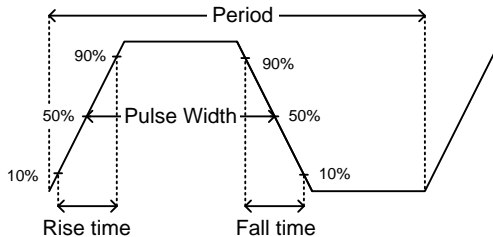

Panel Operation 1. Press the Waveform key.



2. Press F2 (Width). The Width parameter will be highlighted in the parameter window.

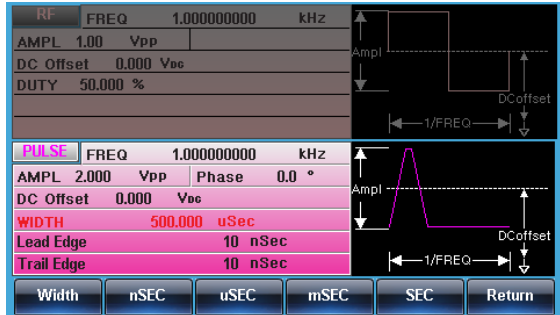

3. There are two ways to set its value :
 - a, Use the arrow keys and scroll wheel



- b, number pad to enter the Duty range.

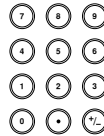

Press F2~F5 choose the unit



Note

Pulse Width Range $\geq 20\text{ns}$ (limited by the current frequency setting)

4. To set parameter Load/Frequency/ Amplitude/DC Offset/Phase, please see page 95 - 99.

Setting the Pulse Leading Edge Time

Panel Operation 1. Press the Waveform key.



2. Press F3 (Lead Edge). The Lead Edge parameter will be highlighted in the parameter window.



3. There are two ways to set its value :

a, Use the arrow keys and scroll wheel



b, number pad to enter the Duty range.

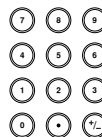

4. Press F1~F3 to choose the unit range.



5. Repeat the above steps for the opposite edge time.



Note

Minimum Leading Range $\geq 10\text{nS}$ (limited by the current frequency and pulse width settings)

Edge time Considerations Leading Edge Time $\leq 0.625 \times$ Pulse Width

- To set parameter Load/Frequency/ Amplitude/DC Offset/Phase, please see page 95 - 99.

Setting the Pulse Trailing Edge Time

Panel Operation 1. Press the Waveform key.



- Press F4 (Trail Edge). The Trail Edge parameter will be highlighted in the parameter window.

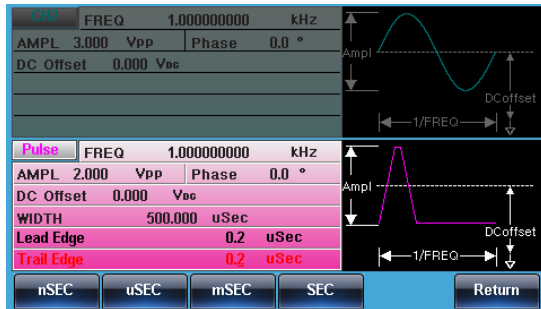

3. There are two ways to set its value :

a, Use the arrow keys and scroll wheel



b, number pad to enter the Duty range.

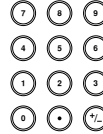

Press F1~F3 to choose the unit range.



4. Repeat the above steps for the opposite edge time.



Minimum	$\geq 10\text{nS}$ (limited by the current
Trailing Edge	frequency and pulse width
time Range	settings)
Edge time	Trailing Edge Time $\leq 0.625 \times$ Pulse
Considerations	Width

5. To set parameter Load/Frequency/Amplitude/DC Offset/Phase, please see page 95 - 99.

Setting the Load

Panel Operation 1. Press the Pulse

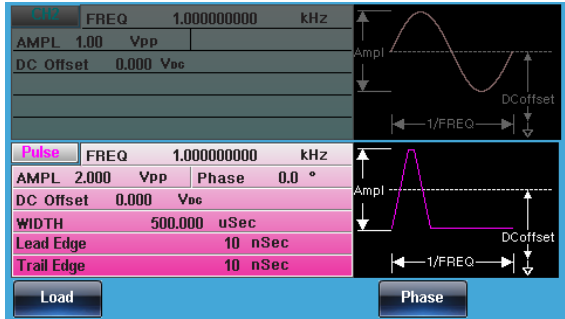

Parameter settings

2. Load setting. Select the corresponding channel and then press the F1(Load) .

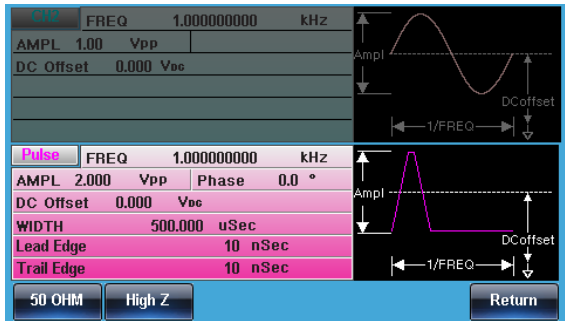

3. Press the F1(50OHM) or F2(High Z) to set Load value.



Note

AMPL is twice under High Z loading than that at 50 ohm. Users can check load setting state for each channel in UTIL.

Setting the Frequency

Panel Operation 1. Press the **FREQ/Rate** key.



2. The **FREQ** parameter will become highlighted in the parameter window.

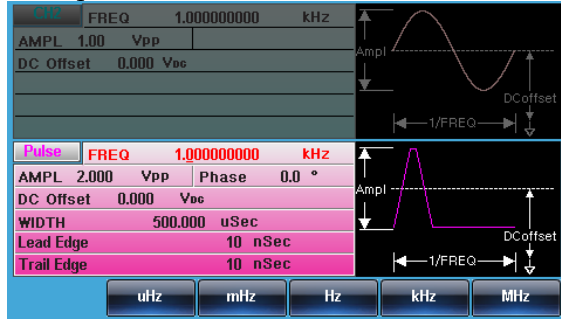

3. There are two ways to set its value :

a, Use the arrow keys and scroll wheel



b, number pad to enter the Duty range.

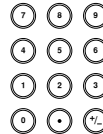

Choose a frequency unit by pressing **F2~F6**.



Range Pulse wave 1 μ Hz~50MHz(max)

Setting the Amplitude

Panel Operation 1. Press the AMPL key.



2. The AMPL parameter will become highlighted in the parameter window.

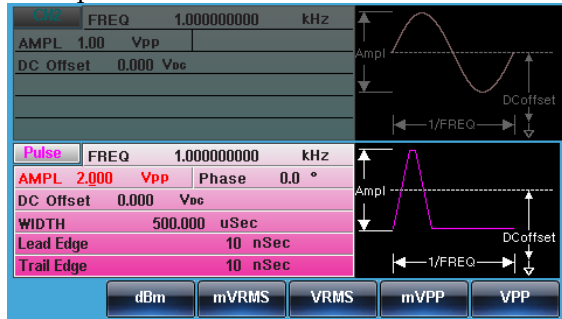

3. There are two ways to set its value :

a, Use the arrow keys and scroll wheel



b, number pad to enter the Duty range.

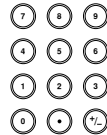

Choose a unit type by pressing F2~F6.



	50Ω load	High Z
Range	1mVpp~2.5Vpp	2mVpp~5Vpp
Unit	Vpp, Vrms, dBm	

Setting the DC Offset

Panel Operation 1. Press the DC Offset key.

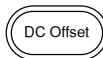

2. The DC Offset parameter will become highlighted in the parameter window.

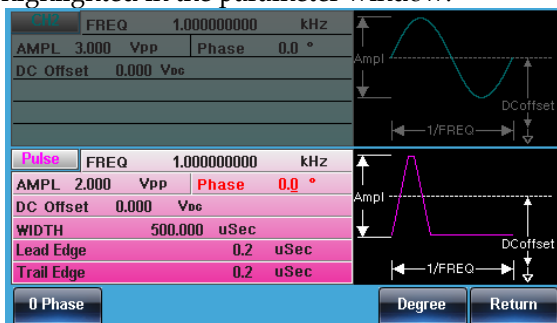

3. There are two ways to set its value :

a, Use the arrow keys and scroll wheel



b, number pad to enter the Duty range.

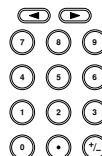

Press F5 (mVDC) or F6 (VDC) to choose a voltage range.



	50Ω load	High Z
Range	±1.25Vpk	±2.5Vpk

Setting the Phase

Panel Operation 1. Press the Pulse key.



2. Phase setting. Select the corresponding channel and then press F5(Phase).

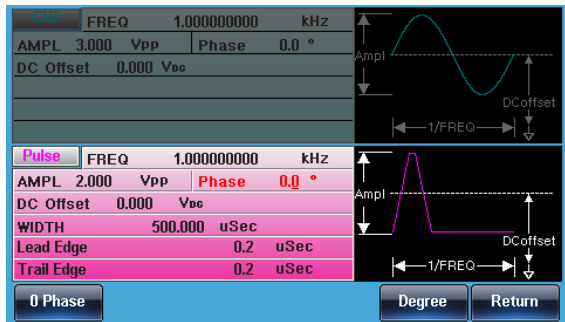

3. There are two ways to set its value :

- Use the arrow keys and scroll wheel
- number pad to enter the Duty range.

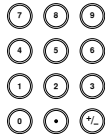

Press F5 (Degree) to choose the units.



Note

There are two quick operations to enter the phase setting interface:

The current channel phase is set to zero
Set the phase of CH1/CH2 to set zero
Synchronously

A small, dark blue rectangular button with the text "0 Phase" in white, located to the right of the main text block.

M MODULATION

The MFG-2220HM Series Multi Channel Function Generators are able to produce AM, ASK, FM, FSK, PM, PSK, PWM and SUM modulated waveforms. In addition the MFG-2220HM can also produce swept and burst mode waveforms. Depending on the type of waveform produced, different modulation parameters can be set. Only one modulation mode can be active at any one time. The function generator also will not allow sweep or burst mode to be used with AM/FM. Activating a modulation mode will turn the previous modulation mode off.

Amplitude Modulation (AM)	104
Selecting AM Modulation.....	104
AM Carrier Shape	105
Carrier Frequency	105
Modulating Wave Shape	106
AM Frequency.....	107
Modulation Depth.....	108
Selecting the (AM) Modulation Source	109
Amplitude Shift Keying (ASK)	111
Selecting ASK Modulation.....	111
ASK Carrier Shape	111
ASK Carrier Frequency.....	112
ASK Amplitude	114
ASK Rate	115
ASK Source	117
Frequency Modulation (FM)	118
Selecting Frequency Modulation (FM)	118
FM Carrier Shape.....	119
FM Carrier Frequency.....	119
FM Wave Shape.....	120
FM Frequency.....	121

Frequency Deviation	122
Selecting (FM) Modulation Source	123
Frequency Shift Keying(FSK)	125
Selecting FSK Modulation.....	125
FSK Carrier Shape	126
FSK Carrier Frequency.....	127
FSK Hop Frequency	128
FSK Rate	129
FSK Source	130
Phase Modulation (PM)	132
Selecting Phase Modulation (PM).....	132
PM Carrier Waveform	133
PM Carrier Frequency	133
PM Wave Shape	134
PM Frequency.....	135
Phase Deviation	136
Select the PM Source	137
Phase Shift Keying(PSK)	139
Select PSK Modulation.....	139
PSK Carrier Wave Shape	140
PSK Carrier Frequency.....	140
PSK Modulation Phase.....	141
PSK Rate	143
PSK Source	144
Pulse Width Modulation	145
Selecting Pulse Width Modulation	145
PWM Carrier Shape.....	146
PWM Carrier Frequency	146
PMW Modulating Wave Shape.....	147
Modulating Waveform Frequency	149
Modulation Duty Cycle.....	150
PWM Source.....	151
SUM modulation	153
Selecting SUM modulation.....	153
SUM Carrier Waveform	155
SUM Carrier Frequency.....	155
SUM Waveform	156
Modulating Waveform Frequency	158
SUM Amplitude.....	159
Select the SUM Source	160
Frequency Sweep	162
Selecting Sweep Mode.....	162
Setting Start and Stop Frequency	163
Center Frequency and Span.....	166

Sweep Mode	168
Sweep Time	169
Marker Frequency	170
Sweep Trigger Source	171
Burst Mode	173
Selecting Burst Mode	173
Burst Modes	173
Burst Frequency	174
Burst Cycle/Burst Count	175
Infinite Burst Count	176
Burst Period	177
Burst Phase	178
Burst Trigger Source	181
Burst Delay	182
Burst Trigger Output	184

Amplitude Modulation(AM)

An AM waveform is produced from a carrier waveform and a modulating waveform. The amplitude of the modulated carrier waveform depends on the amplitude of the modulating waveform. The MFG-2220HM function generator can set the carrier frequency, amplitude and offset as well as internal or external modulation sources.

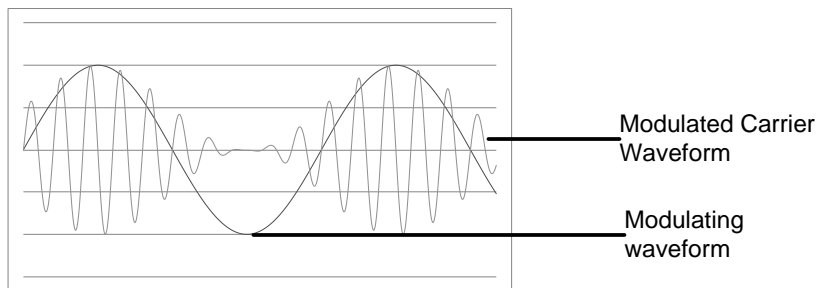

Selecting AM Modulation

Panel Operation 1. Press the MOD key.



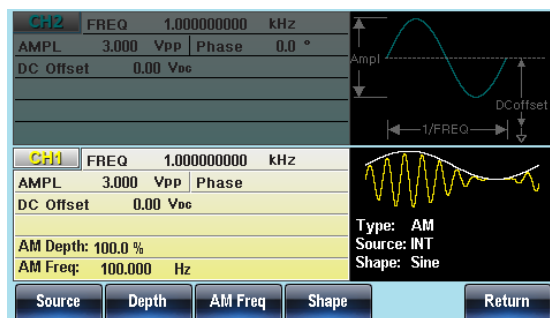

2. Press F1 (AM).



AM Carrier Shape

Background Sine, square, ramp, pulse or arbitrary waveforms can be used as the carrier shape. The default waveform shape is set to sine. Noise is not available as a carrier shape. Before the carrier shape can be selected, choose AM modulation mode, see above.



- Select a Standard Carrier Shape**
1. Press the Waveform key. 
 2. Press F1~F5 to choose the carrier wave shape. 
 3. See the Arbitrary waveform quick reference or chapter to use an arbitrary waveform. Page 45
Page 206
- Select an Arbitrary Waveform Carrier Shape.**

Range AM Carrier Shape Sine, Square, Ramp, Pulse, Arbitrary waveform

Carrier Frequency

The maximum carrier frequency depends on the carrier shape selected. The default carrier frequency for all carrier shapes is 1kHz.

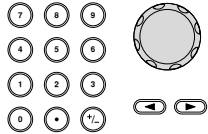



- Panel Operation**
4. With a carrier waveform selected, press the  key.
 5. The FREQ parameter will become highlighted in the parameter window.

6. Use the arrow keys and scroll wheel or number pad to enter the carrier frequency. 
7. Press F2~F6 to select the frequency range. 

Range	Carrier Shape	Carrier Frequency
	Sine wave	1μHz~ 200MHz(max)
	Square wave	1μHz~60MHz(max)
	Triangle wave	1μHz~5MHz
	Ramp wave	1μHz~5MHz
	Default frequency	1 kHz

Modulating Wave Shape

The function generator can accept internal as well as external sources. The MFG-2220HM has sine, square, triangle, up ramp and down ramp modulating waveform shapes. Sine waves are the default wave shape.

- Panel Operation
1. Press the MOD key. 
 2. Press F1 (AM). 
 3. Press F4 (Shape). 
 4. Press F1 ~ F5 to select the waveform shape. 
 5. Press F6 (Return) to return to the previous menu. 

Note	Square wave	50% Duty cycle
	UpRamp	100% Symmetry
	Triangle	50% Symmetry
	DnRamp	0% Symmetry

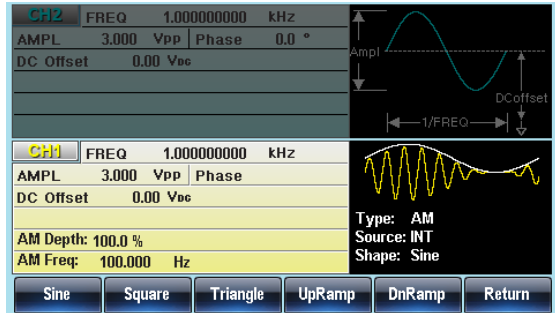

AM Frequency

The frequency of the modulation waveform (AM Frequency) can be set from 2mHz to 50kHz.

Panel Operation 1. Press the MOD key.



2. Press F1 (AM).





3. Press F3 (AM Freq)

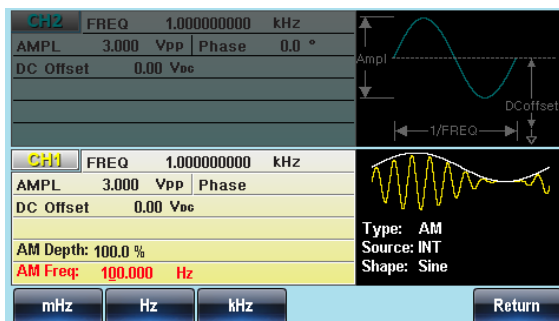

4. The AM Freq parameter will become highlighted in the Waveform display area.

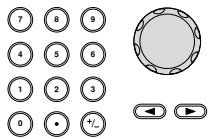



5. Use the arrow keys and scroll wheel or number pad to enter the AM frequency.
 
6. Press F1~F3 to select the frequency range.
 

Range	Modulation frequency	2mHz~50kHz
	Default frequency	100Hz

Modulation Depth

Modulation depth is the ratio (as a percentage) of the unmodulated carrier amplitude and the minimum amplitude deviation of the modulated waveform. In other words, modulation depth is the maximum amplitude of the modulated waveform compared to the carrier waveform as a percentage.

- Panel Operation
1. Press the MOD key.
 
 2. Press F1 (AM).
 
 3. Press F2 (Depth).
 

- The AM Depth parameter will become highlighted in the waveform display area.

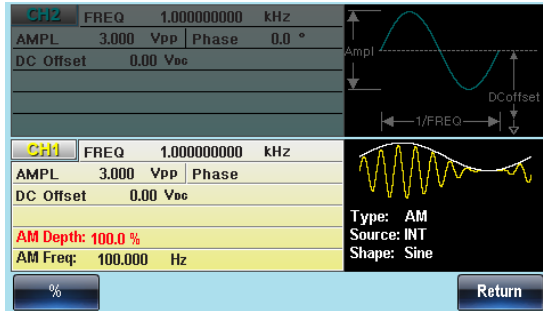

- Use the arrow keys and scroll wheel or number pad to enter the AM depth.

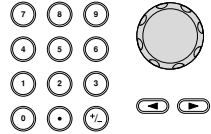

- Press F1 (%) to choose % units.



Range	Depth	0%~120%
	Default depth	100%







Note

When the modulation depth is greater than 100%, the output cannot exceed $\pm 5V_{Peak}$ (10k Ω load).

If an external modulation source is selected, modulation depth is limited to $\pm 5V$ from the MOD INPUT terminal on the rear panel. For example, if the modulation depth is set to 100%, then the maximum amplitude is +5V, and the minimum amplitude is -5V.

Selecting the (AM) Modulation Source

The function generator will accept an internal or external source for AM modulation. The default source is internal.

- Panel Operation
1. Press the MOD key. 
 2. Press F1 (AM). 
 3. Press F1 (Source). 
 4. Press F1 (INT) or F2 (EXT) to select the modulation source. 
 5. Press Return to go back to the previous menu. 

External Source Use the MOD INPUT terminal on the rear panel when using an external source. 

 **Note**

If an external modulation source is selected, modulation depth is determined by a $\pm 5V$ signal input into the MOD INPUT terminal on the rear panel. For example, if the modulation depth is set to 100%, then when the voltage level of the modulation source is at +5V, then the deviation is at the maximum and when the source is at -5V then the deviation is at the minimum.

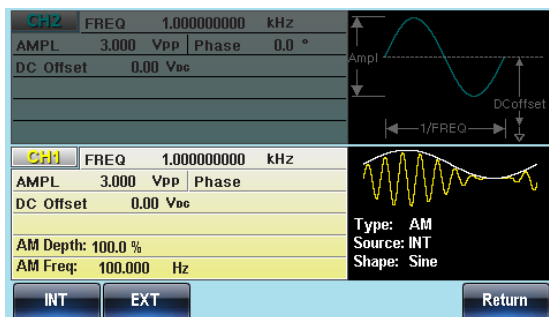

Amplitude Shift Keying(ASK)

ASK modulation is used to switch the output amplitude between two preset amplitude values (carrier amplitude and modulation amplitude). Only one modulation mode can be used at one time. Sweep and burst mode also cannot be used with ASK. Enabling ASK will disable Sweep or Burst mode.

Selecting ASK Modulation

When using the ASK mode, the output waveform uses the default settings for carrier frequency, amplitude and offset voltage.

Panel Operation 1. Press the MOD key.



2. Press F6 (More) first then F2.

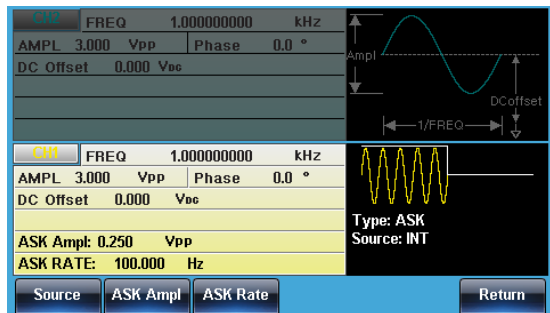

ASK Carrier Shape

Background The default waveform shape is set to sine. Other waveforms cannot be used as carrier waves.

Panel Operation 1. Press the Waveform key.



2. Press F1 ~ F5 to select the carrier waveform.



Range Carrier Waveforms Sine, Square, Pulse, Ramp

ASK Carrier Frequency

The maximum carrier frequency depends on the carrier shape. The default carrier frequency is 1kHz.

Panel Operation 1. Press the FREQ key to set the carrier frequency.



2. The FREQ parameter will become highlighted in the parameter window.

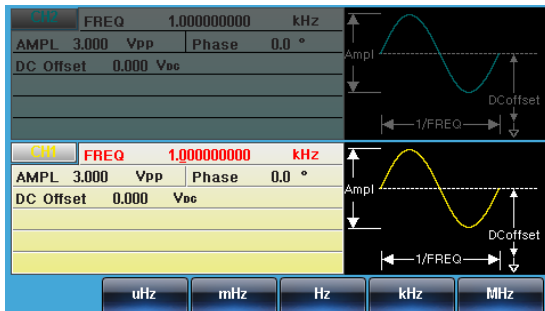

3. Use the selector keys and scroll wheel or number pad to enter the carrier frequency.

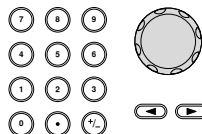

4. Press F2~F6 to select the FSK frequency units.



Range Carrier Shape Carrier Frequency

Sine wave	1 μ Hz~200MHz(max)
Default frequency	1kHz

ASK Amplitude

The default ASK amplitude is 0.5V. Internally modulated waveforms use a square wave with a 50% duty cycle.

Panel Operation 1. Press the MOD key.



2. Press F6 (More) first then F2(ASK).



3. Press F2 (ASK Ampl).



4. The ASK Ampl parameter will become highlighted in the Waveform Display area.

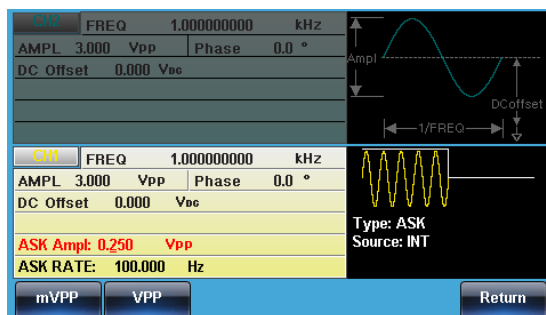

5. Use the selector keys and scroll wheel or number pad to enter the modulation amplitude.

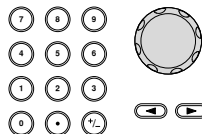

6. Choose a unit type by pressing F2~F6.



Range	ASK Amplitude	0V~max
	Default	0.5V

ASK Rate

The ASK rate setting determines the rate at which the amplitude will switch from the carrier amplitude and the modulation amplitude.

Panel Operation 1. Select MOD.



2. Press F6 (More) First then F2(ASK).



3. Press F3 (ASK Rate).



4. The ASK Rate parameter will become highlighted in the Waveform Display area.

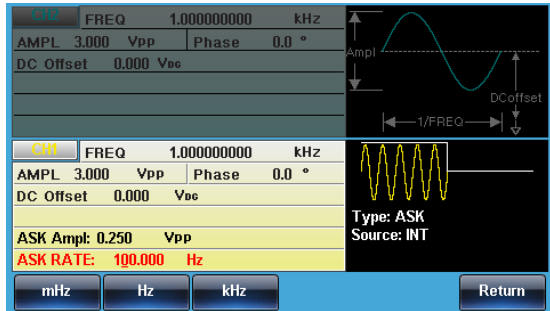

5. Use the selector keys and scroll wheel or number pad to enter the ASK frequency rate.

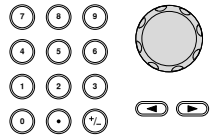

6. Press F1 ~ F4 to select the frequency unit.



Range ASK frequency rate 2mHz~1MHz

Default

100Hz

ASK Source

The function generator will accept an internal or external source for ASK modulation. The default source is internal. When Internal Source is selected, the ASK Rate setting will set the frequency rate.

Panel Operation

1. Press the MOD key.



2. Press F6 (More) first then F2(ASK).



3. Press F1 (Source).



4. Press F1 (Internal) or F2 (External) to select the ASK source.



5. Press Return to return the previous menu.

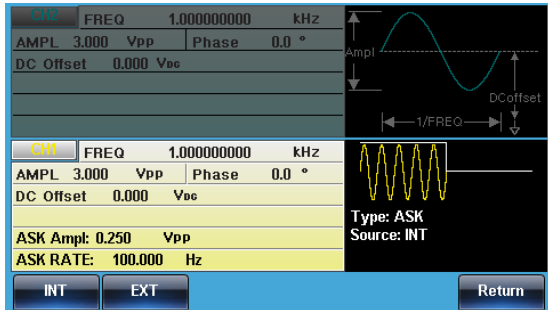

Frequency Modulation(FM)

A FM waveform is produced from a carrier waveform and a modulating waveform. The instantaneous frequency of the carrier waveform varies with the magnitude of the modulating waveform. When using the MFG-2220HM function generator, only one type of modulated waveform can be created at any one time.

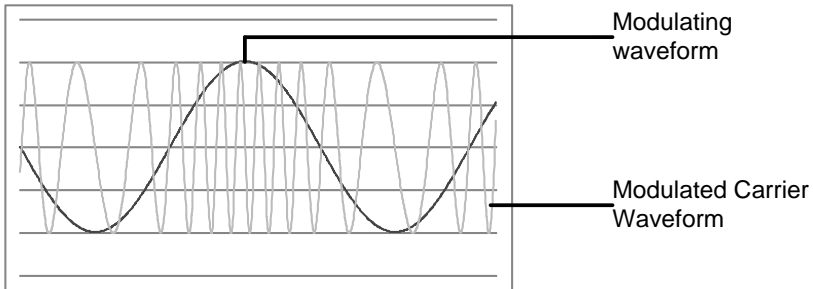

Selecting Frequency Modulation (FM)

When FM is selected, the modulated waveform depends on the carrier frequency, the output amplitude and offset voltage.

Panel Operation 1. Press the MOD key.



2. Press F2 (FM).



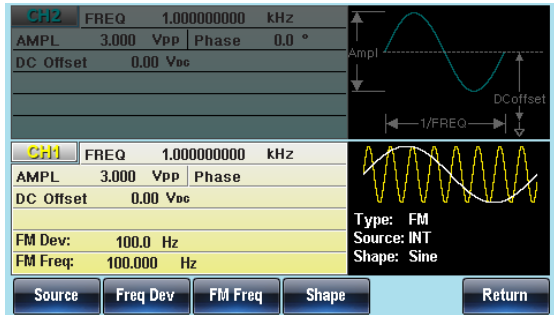

FM Carrier Shape

Background The default waveform shape is set to sine. Noise waveforms cannot be used as a carrier wave.

Panel Operation 1. Press the Waveform key.



2. Press F1~F5 to select the carrier shape.



Range Carrier Shape Sine, square, pulse, ramp.

FM Carrier Frequency

When using the MFG-2220HM function generator, the carrier frequency must be equal to or greater than the frequency deviation. If the frequency deviation is set to value greater than the carrier frequency, the deviation is set to the maximum allowed. The maximum frequency of the carrier wave depends on the waveform shape chosen.

Panel Operation 1. To select the carrier frequency, press the FREQ/Rate key.



2. The **FREQ** parameter will become highlighted in the parameter window.

3. Use the arrow keys and scroll wheel or number pad to enter the carrier frequency.

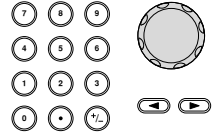

4. Press **F2~F6** to select the frequency unit.



Range	Carrier Shape	Carrier Frequency
	Sine	1μHz~200MH(max)
	Square	1μHz~60MHz(max)
	Pulse	1μHz~50MHz(max)
	Ramp	1μHz~5MHz
	Default frequency	1kHz

FM Wave Shape

The function generator can accept internal as well as external sources. The MFG-2220HM has sine, square, pulse, positive and negative ramps (UpRamp, DnRamp) as the internal modulating waveform shapes. Sine is the default wave shape.

Background

1. Select **MOD**.



2. Press **F2 (FM)**.



3. Press **F4 (Shape)**.



4. Press **F1 ~ F5** to select the waveform shape.



5. Press Return to return to the previous menu. **Return**

Range	Square wave	50% Duty cycle
	UpRamp	100% Symmetry
	Triangle	50% Symmetry
	DnRamp	0% Symmetry

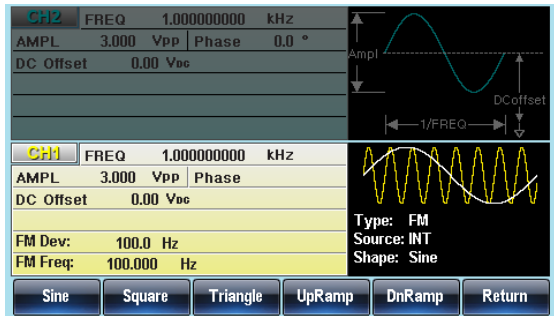

FM Frequency

The frequency of the modulation waveform (FM frequency) can be set from 2mHz to 50kHz. For frequency modulation, the function generator will accept internal or external sources.

- Panel Operation 1. Press the MOD key.



2. Press F2 (FM).



3. Press F3 (FM Freq).



4. The FM Freq parameter will become highlighted in waveform display panel.

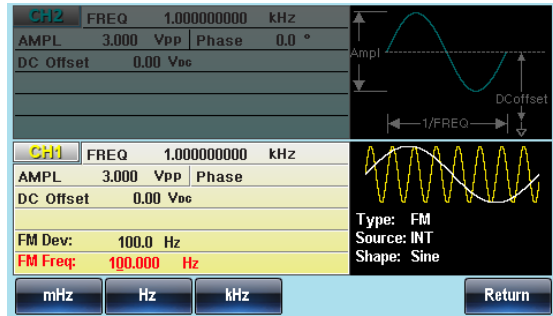

5. Use the arrow keys and scroll wheel or number pad to enter the FM frequency.

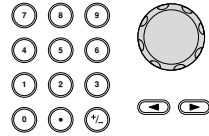

6. Press F1~F3 to select the frequency unit.



Range	Modulation frequency	2mHz~50kHz
	Default frequency	100Hz

Frequency Deviation

The frequency deviation is the peak frequency deviation from the carrier wave and the modulated wave.

- Panel Operation
1. Press the MOD key.



2. Press F2 (FM).





3. Press F2 (Freq Dev).

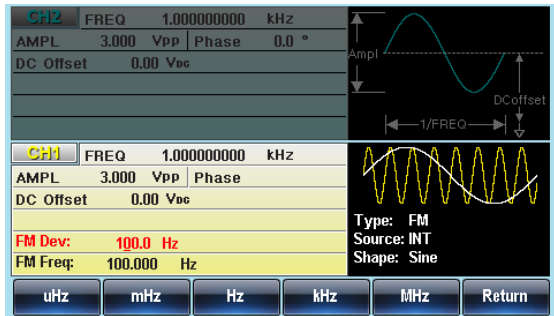

4. The Freq Dev parameter will become highlighted in the waveform display panel.

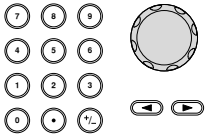





5. Use the arrow keys and scroll wheel or number pad to enter the frequency deviation.
 
6. Press F1~ F5 to choose the frequency units.
 

Range	Frequency Deviation	DC~Max Frequency
	Default depth	100Hz

Selecting (FM) Modulation Source

The function generator will accept an internal or external source for FM modulation. The default source is internal.

- Panel Operation
1. Press the MOD key.
 
 2. Press F2 (FM).
 
 3. Press F1 (Source).
 
 4. To select the source, press F1 (Internal) or F2 (External).
 

5. Press Return to return to the previous menu. **Return**

External Source

Use the MOD INPUT terminal on the rear panel when using an external source.

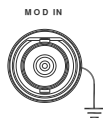

Note

If an external modulating source is selected, the frequency deviation is determined by a $\pm 5V$ signal input into the MOD INPUT terminal on the rear panel. The frequency deviation is proportional to the voltage of the modulation source. For example, if the voltage of the modulation source is +5V, then the frequency deviation would be equal to the set frequency deviation. Lower voltages levels reduce the frequency deviation while negative voltage levels produce frequency deviations with frequencies below the carrier waveform.

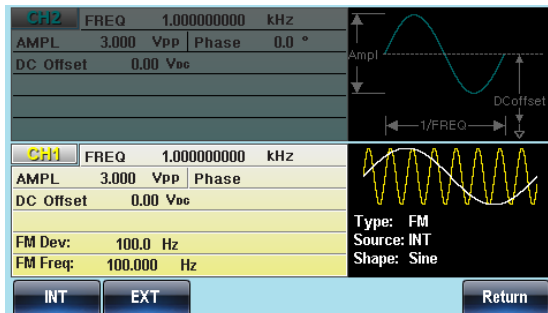

Frequency Shift Keying(FSK)

Frequency Shift Keying Modulation is used to shift the frequency output of the function generator between two preset frequencies (carrier frequency, hop frequency). The frequency at which the carrier and hop frequency shift is determined by the internal rate generator or the voltage level from the Trigger INPUT terminal on the rear panel.

Only one modulation mode can be used at once. When FSK modulation is enabled, any other modulation modes will be disabled. Sweep and Burst also cannot be used with FSK modulation. Enabling FSK will disable Sweep or Burst mode.

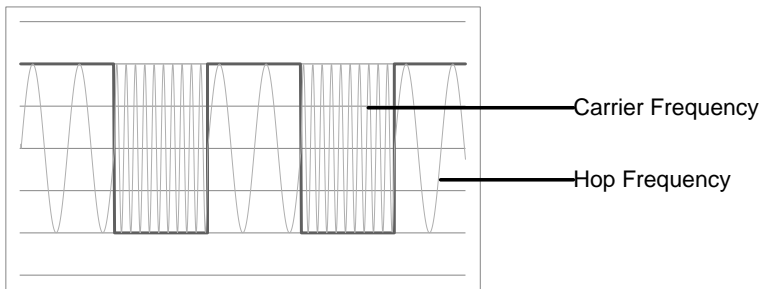

Selecting FSK Modulation

When using FSK mode, the output waveform uses the default settings for carrier frequency, amplitude and offset voltage.

Panel Operation 1. Press the MOD key.



2. Press F3 (FSK).



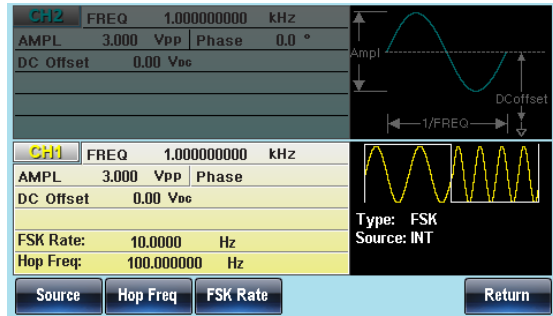

FSK Carrier Shape

Background The default waveform shape is set to sine. Noise waveforms cannot be used as carrier waves.

Panel Operation 1. Press the Waveform key.



2. Press F1~F5 to choose the carrier wave shape.



Range Carrier Shape Sine, Square, Pulse, Ramp

FSK Carrier Frequency

The maximum carrier frequency depends on the carrier shape. The default carrier frequency for all carrier shapes is 1kHz. The voltage level of the Trigger INPUT signal controls the output frequency when EXT is selected. When the Trigger INPUT signal is logically low the carrier frequency is output and when the signal is logically high, the hop frequency is output.

Panel Operation

1. Press the **FREQ/Rate** key to select the carrier frequency.



2. The **FREQ** parameter will become highlighted in the parameter window.

3. Use the arrow keys and scroll wheel or number pad to enter the carrier frequency.

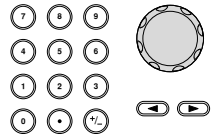

4. Press **F2~F6** to select the FSK frequency units.



Range	Carrier Shape	Carrier Frequency
	Sine wave	1μHz~200MHz(max)
	Square wave	1μHz~60MHz(max)
	Ramp wave	1μHz~5MHz
	Pulse wave	1μHz~50MHz(max)
	Default frequency	1kHz

FSK Hop Frequency

The default Hop frequency for all waveform shapes is 100 Hz. A square wave with a duty cycle of 50% is used for the internal modulation waveform. The voltage level of the Trigger INPUT signal controls the output frequency when EXT is selected. When the Trigger INPUT signal is logically low the carrier frequency is output and when the signal is logically high, the hop frequency is output.

Panel Operation 1. Press the MOD key.



2. Press F3 (FSK).



3. Press F2 (Hop Freq).



4. The Hop Freq parameter will become highlighted in the Waveform Display area.

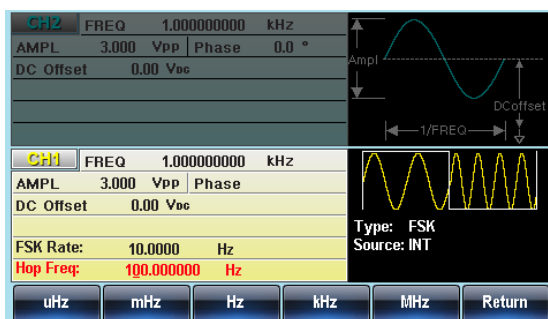

5. Use the arrow keys and scroll wheel or number pad to enter the hop frequency.

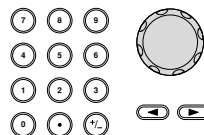





6. Press F1~F5 to select the frequency range.



Range	Waveform	Carrier Frequency
	Sine wave	1μHz~200MHz(max)
	Square wave	1μHz~60MHz(max)
	Ramp wave	1μHz~5MHz
	Pulse wave	1μHz~50MHz(max)
	Default frequency	100Hz

FSK Rate

FSK Rate function is used to determine rate at which the output frequency changes between the carrier and hop frequencies. The FSK Rate function only applies to internal FSK sources.

- Panel Operation
1. Select the MOD key. 
 2. Press F3 (FSK).  
 3. Press F3 (FSK Rate).  
 4. The FSK Rate parameter will become highlighted in the waveform display area.

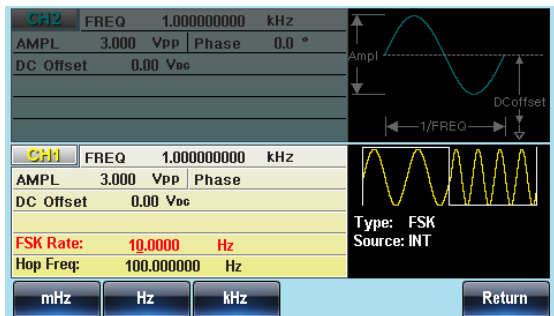

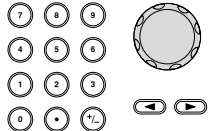
5. The arrow keys and scroll wheel or number pad to enter the FSK rate.
- 

6. Press F1~F4 to select the frequency unit.
- 

Range	FSK Rate	2mHz~1MHz
	Default	10Hz







Note

If an external source is selected, FSK Rate settings are ignored.

FSK Source

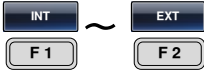
The MFG-2220HM accepts internal and external FSK sources, with internal as the default source. When the FSK source is set to internal, the FSK rate is configured using the FSK Rate setting. When an external source is selected the FSK rate is equal to the frequency of the Trigger INPUT signal on the rear panel.

- Panel Operation
1. Press the MOD key.
 
 2. Press F3 (FSK).
 
 3. Press F1 (Source).
 
 4. Press F1 (Internal) or F2 (External) to select the FSK source.
 
 5. Press Return to return to the previous menu.
 



Note

Note that the Trigger INPUT terminal cannot configure edge polarity.

CH2	FREQ	1.000000000	kHz
AMPL	3.000	Vpp	Phase 0.0 °
DC Offset	0.00	V _{DC}	
CH1	FREQ	1.000000000	kHz
AMPL	3.000	Vpp	Phase
DC Offset	0.00	V _{DC}	
FSK Rate:	10.0000	Hz	
Hop Freq:	100.000000	Hz	
INT		EXT	
			Return

Phase Modulation (PM)

A PM waveform is produced from a carrier waveform and a modulating waveform. The phase of the carrier waveform is modulated by the magnitude of the modulating waveform. When using the function generator, only one type of modulated waveform can be created at any one time for the selected channel.

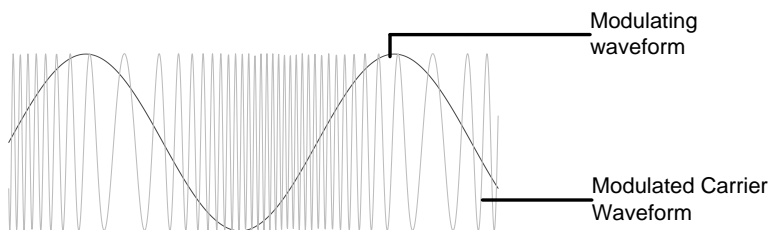

Selecting Phase Modulation (PM)

When selecting PM, the current setting of the carrier frequency, the amplitude modulation frequency, output, and offset voltage must be considered.

Panel Operation 1. Press the MOD key.





2. Press F4 (PM).



CH2	FREQ	1.000000000	kHz		
AMPL	3.000	Vpp	Phase		0.0 °
DC Offset	0.00	Vdc			
<hr/>					
CH1	FREQ	1.000000000	kHz		
AMPL	3.000	Vpp			
DC Offset	0.00	Vdc			
PM Dev:	180.0	°	Type: PM		
PM Freq:	100.000	Hz	Source: INT		
				Shape: Sine	
Phase Dev		PM Freq		Shape	
				Return	

PM Carrier Waveform



Background PM uses a sine wave as default. Noise cannot be used with phase modulation.

- Panel Operation**
1. Press the Waveform key. 
 2. Press F1 ~ F5 to select the waveform. 

Range Carrier Waveforms Sine, square, pulse, ramp .

PM Carrier Frequency

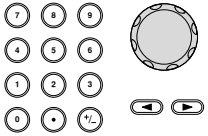
Selects the maximum carrier frequency for the carrier waveform. The default carrier frequency is 1kHz.

- Panel Operation**
1. Press the **FREQ/Rate** key to select the carrier frequency. 
 2. The **FREQ** parameter will become highlighted in the parameter window.
 3. Use the arrow keys and scroll wheel or number pad to enter the carrier frequency. 
 4. Press F2~F6 to select the frequency unit. 

Range	Carrier Wave	Carrier Frequency
	Sine wave	1μHz~200MH(max)
	Square wave	1μHz~60MHz(max)

Pulse wave	1μHz~50MHz(max)
Ramp wave	1μHz~5MHz
Default frequency	1 kHz

PM Wave Shape

The function generator can accept internal or external sources. The internal sources can include sine, square, triangle, up ramp and down ramp. The default wave shape is sine.

Panel Operation 1. Select the MOD key.



2. Press F4 (PM).



3. Press F4 (Shape).



4. Press F1~F5 to select a waveform shape.



5. Press Return to return to the previous menu.



Range

Waveform



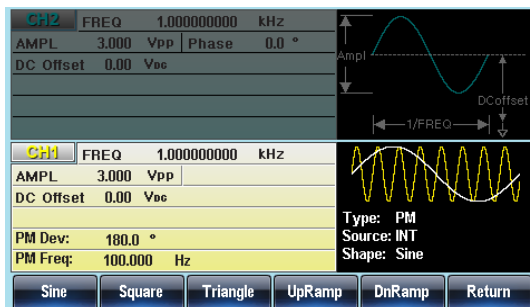

Square wave	50% Duty Cycle
Up Ramp	100% Symmetry
Triangle	50% Symmetry
Dn Ramp	0% Symmetry







PM Frequency

The frequency of the modulation waveform (PM Frequency) can be set from 2mHz to 50kHz. The function generator can accept internal or external sources.

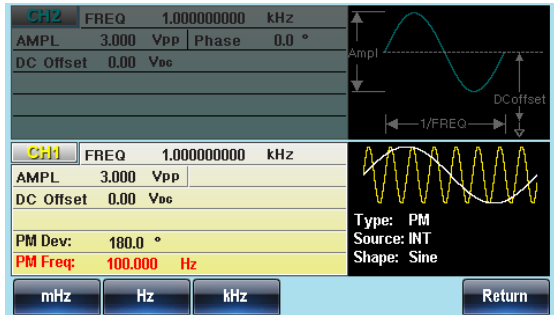
Panel Operation

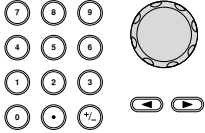
1. Press the MOD key. 
2. Press F4 (PM).  
3. Press F3 (PM Freq).  
4. The PM Freq parameter will become highlighted in the Waveform Display area.



5. Use the arrow keys and scroll wheel or number pad to enter the PM frequency. 
6. Press F1~F3 to select the frequency unit range.    

Range	Modulation frequency	2mHz~50kHz
	Default frequency	100Hz

Phase Deviation

The maximum phase deviation depends on the the carrier wave frequency and the modulated waveform.

Panel operation 1. Press the MOD key.



2. Press F4 (PM).



3. Press F2 (Phase Dev).



4. The Phase Dev parameter will become highlighted in the waveform display area.

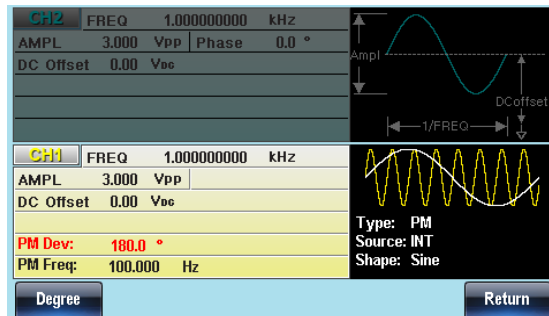

5. Use the arrow keys and scroll wheel or number pad to enter the phase deviation.

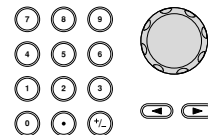





6. Press F1 to select the phase units.



Range	Phase deviation/shift	0~360°
	Default phase	180°

Select the PM Source

The function generator accepts internal or external sources for phase modulation. The default source is internal.

- Panel Operation
1. Press the MOD key. 
 2. Press F4 (PM). 
 3. Press F1 (Source). 
 4. Press F1 (INT) or F2 (EXT) to select the source. 
 5. Press return to return to the previous menu. 

External Source Use the MOD INPUT terminal on the rear panel when using an external source. 



Note

If the modulation source is set to external, the phase deviation is controlled by the $\pm 5V$ MOD INPUT terminal on the rear panel. For example, if the modulation voltage is +5V, then the phase deviation is equal to the phase deviation setting. If the modulation voltage is less than +5V, then the phase deviation will be less than the phase deviation setting.

CH2	FREQ	1.000000000	kHz
AMPL	3.000	Vpp	Phase 0.0 °
DC Offset	0.00	Vdc	

CH1	FREQ	1.000000000	kHz
AMPL	3.000	Vpp	
DC Offset	0.00	Vdc	
PM Dev:	180.0	°	
PM Freq:	100.000	Hz	

Type: PM
Source: INT
Shape: Sine

Phase Dev	PM Freq	Shape	Return
-----------	---------	-------	--------

Phase Shift Keying(PSK)

PSK modulation alternates the output between two preset phase values (carrier phase and modulation phase)

Only one mode of modulation can be enabled at any one time. If PSK is enabled, any other modulation mode will be disabled.

Likewise, burst and sweep modes cannot be used with PSK and will be disabled when PSK is enabled.

Select PSK Modulation

When using the PSK modulation mode, the output waveform uses the default carrier frequency, amplitude and offset voltage.

Panel Operation 1. Press the MOD key.



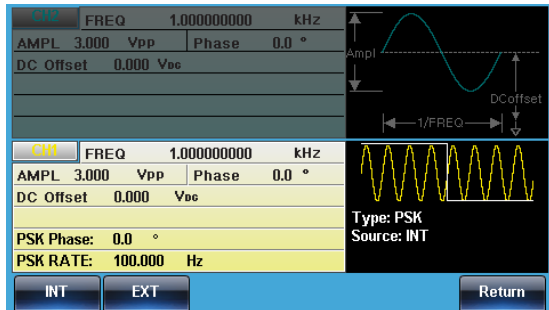

2. Press F6 (More) first then F3.



PSK Carrier Wave Shape

Background Sine is the default waveform. Other waveforms cannot be used as a carrier wave.

- Panel Operation**
1. Press the Waveform key. 
 2. Press F1 ~ F5 to select the carrier shape. 

Range Carrier Waveforms Sine

PSK Carrier Frequency

The maximum carrier frequency depends on the carrier shape. The default carrier frequency is 1kHz.

- Panel Operation**
1. Press the **FREQ/Rate** key to select the carrier frequency. 
 2. The **FREQ** parameter will become highlighted in the parameter window.

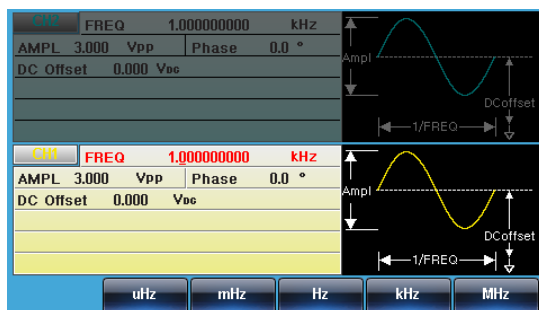

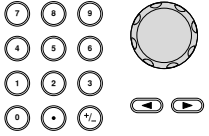



3. Use the arrow keys and scroll wheel or number pad to enter the carrier frequency.
- 

4. Press F2~F6 to select the PSK frequency unit.
- 

Range	Carrier Waveforms	Carrier Frequency
	Sine wave	1μHz~200MHz(max)
	Default frequency	1kHz

PSK Modulation Phase

The default PSK phase is 180°. The internal modulation source is a square wave with a 50% duty cycle.

- Panel Operation
1. Press the MOD key.
 
 2. Press F6 (More) first then F3.
 

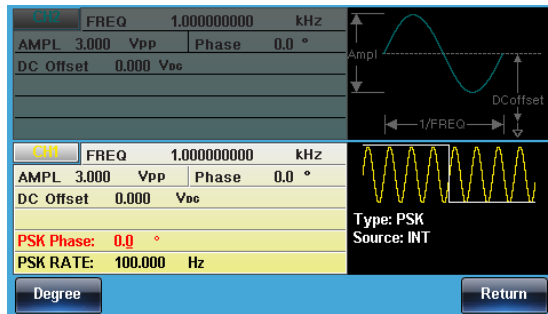
 3. Press F2 (PSK Phase).
 
 4. The PSK phase parameter will become highlighted in the parameter window.

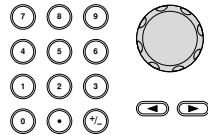

5. Use the arrow keys and scroll wheel or number pad to enter the PSK phase.



6. Press F1 to select the phase units.



Range	PSK modulation phase	0~360°
	Default phase	180°

PSK Rate

The PSK modulation time determines whether the carrier phase or modulation phase is output.

Panel Operation 1. Select MOD.



2. Press F6 (More) first then F3(PSK).



3. Press F3 (PSK Rate).



4. The PSK rate parameter will become highlighted in the parameter window.

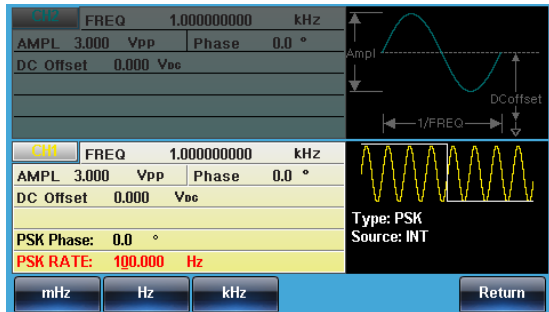

5. Use the arrow keys and scroll wheel or number pad to enter the PSK rate.

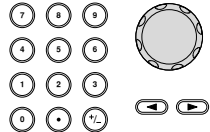

6. Press F1~F4 to select the frequency units.



Range	PSK modulation time	2mHz~1MHz
	Default	10Hz

PSK Source

The MFG-2220HM accepts internal and external PSK sources, with internal as the default source. When the PSK source is set to internal, the PSK rate is configured using the PSK modulation frequency setting.

Panel Operation 1. Press the MOD key.



2. Press F6 (More) first then F3(PSK).



3. Press F1 (Source).



4. Press F1 (Internal) or F2 (External) to set the PSK source.



5. Press Return to return to the previous menu.

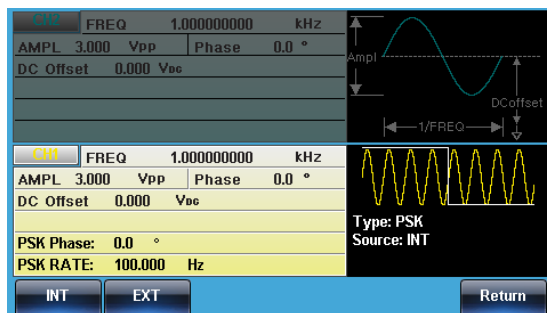

Pulse Width Modulation

For pulse width modulation the instantaneous voltage of the modulating waveform determines the width of the pulse waveform.

Only one mode of modulation can be enabled at any one time for the selected channel. If PWM is enabled, any other modulation mode will be disabled. Likewise, burst and sweep modes cannot be used with PWM and will be disabled when PWM is enabled.

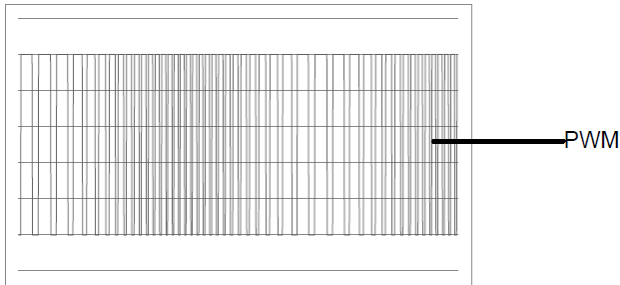

Selecting Pulse Width Modulation

When selecting PWM, the current setting of the carrier frequency, the amplitude modulation frequency, output, and offset voltage must be considered.

Panel Operation 1. Press the MOD key.



2. Press F6 (More) first then F1(PWM).



3. Press F1 (Source).



4. Press F1 (INT) or F2 (EXT) to select the source.



- Press Return to return to the previous menu. 

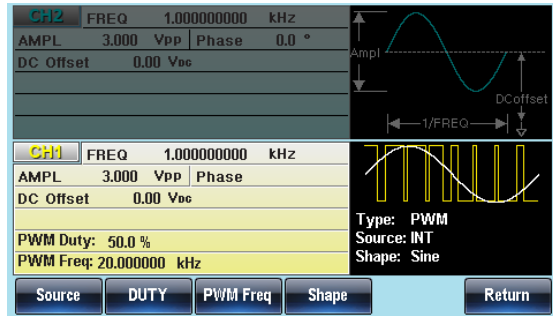

PWM Carrier Shape

PWM uses a square wave as the carrier shape. Other wave shapes cannot be used with PWM. If a carrier shape other than square is used with PWM, an error message will appear.

PWM Carrier Frequency

The carrier frequency depends on the square wave. The default carrier frequency is 1kHz.

- Panel Operation
- To select the carrier frequency, press the  key.

- The FREQ parameter will become highlighted in the parameter window.

- Use the selector keys and scroll wheel or number pad to enter the carrier frequency.

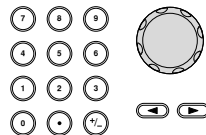

4. Press F2~F6 to select the PWM frequency unit.



PMW Modulating Wave Shape

The modulating wave shapes for internal sources include sine, square, triangle, up ramp and down ramp. The default wave shape is sine.

- Panel Operation 1. Press the MOD key.



2. Press F6 (More) first then F1(PWM).



3. Press F4 (Shape).



4. Press F1~F5 to select a waveform shape.



5. Press Return to return to the previous menu.



Range	Waveform	
	Square wave	50% duty cycle
	UpRamp	100% symmetry
	Triangle ramp	50% symmetry
	DnRamp	0% symmetry

CH2	FREQ	1.000000000	kHz				
AMPL	3.000	Vpp	Phase 0.0 °				
DC Offset	0.00	Vdc					
CH1	FREQ	1.000000000	kHz				
AMPL	3.000	Vpp	Phase				
DC Offset	0.00	Vdc					
	PWM Duty:	50.0 %		Type: PWM			
	PWM Freq:	20.000000	kHz	Source: INT			
				Shape: Sine			
Sine		Square		Triangle	UpRamp	DnRamp	Return

Modulating Waveform Frequency

Panel Operation 1. Press the MOD key.



2. Press F6 (More) first then F1(PWM).



3. Press F3 (PWM Freq).



4. The PMW Freq parameter will become highlighted in the parameter window.

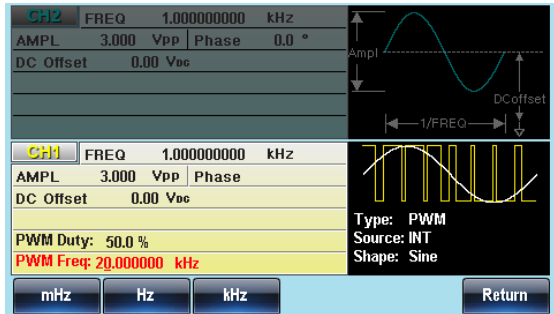

5. Use the selector keys and scroll wheel or number pad to enter the PWM frequency.

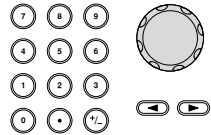

6. Press F1~F3 to select the frequency unit range.



Range	PWMFrequency	2mHz~50kHz
	Default	50kHz

Modulation Duty Cycle

Duty function is used to set the duty cycle as percentage (%).

Panel Operation 1. Press the MOD key.



2. Press F6 (More) first then F1(PWM).



3. Press F2 (Duty).



4. The PMW Duty parameter will become highlighted in the parameter window.

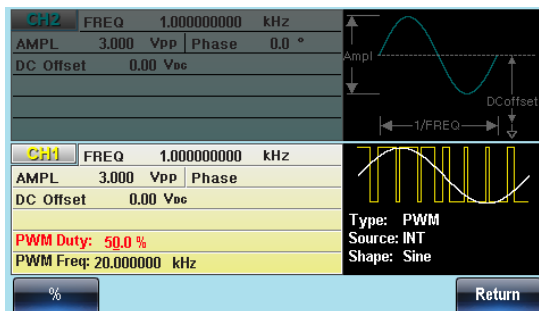

5. Use the selector keys and scroll wheel or number pad to enter the duty cycle

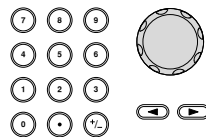

6. Press F1(%) to select percentage units.







Range	Duty Cycle	0%~100%
	Default	50%

Note Pulse waveforms can be modulated with an external source using the external source function. When using

an external source, the pulse width is controlled by the $\pm 5V$ MOD INPUT terminal.

PWM Source

The MFG-2220HM accepts internal and external PWM sources. Internal is the default source for PWM sources

- Panel Operation
1. Press the MOD key. 
 2. Press F6 (More) first then F1(PWM). 
 3. Press F1 (Source). 
 4. To select the source, press F1 (Internal) or F2 (External). 
 5. Press Return to return to the previous menu. 

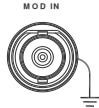
External Source	Use the MOD INPUT terminal on the rear panel when using an external source.	
-----------------	---	--



Note

If an external modulation source is selected, pulse width modulation is controlled by the $\pm 5V$ from the MOD INPUT terminal on the rear panel. For example, if duty is set to 100%, then the maximum duty occurs at +5V, and the minimum duty at -5V.

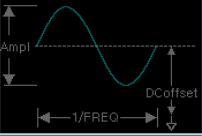
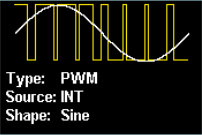
CH2	FREQ	1.000000000	kHz
AMPL	3.000	Vpp	Phase 0.0 °
DC Offset	0.00	Vdc	
			
CH1	FREQ	1.000000000	kHz
AMPL	3.000	Vpp	Phase
DC Offset	0.00	Vdc	
			
PWM Duty: 50.0 % PWM Freq: 20.000000 kHz			
INT		EXT	
			Return

SUM modulation

SUM modulation adds the modulating waveform to the carrier waveform. The amplitude of the modulating waveform is set as a percentage of the carrier amplitude.

Only one mode of modulation can be enabled at any one time for the selected channel. If SUM is enabled, any other modulation mode will be disabled. Likewise, burst and sweep modes cannot be used with SUM modulation and will be disabled when SUM is enabled.

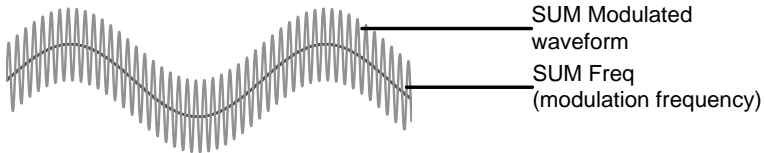

Selecting SUM modulation

For SUM modulation, the modulated waveform amplitude and offset is determined by the carrier wave.

Panel Operation 1. Press the MOD key.



2. Press F5 (SUM).



CH2	FREQ	1.000000000	kHz	<p>Ampl</p> <p>DCoffset</p> <p>1/FREQ</p>	
AMPL	3.000	Vpp	Phase 0.0 °		
DC Offset	0.00	Vdc			
CH1	FREQ	1.000000000	kHz	<p>Type: SUM</p> <p>Source: INT</p> <p>Shape: Sine</p>	
AMPL	3.000	Vpp			
DC Offset	0.00	Vdc			
	SUM Ampl:	50.00 %			
	SUM Freq:	100.000	Hz		
Source		SUM Ampl		SUM Freq	
Shape		Return			

SUM Carrier Waveform

Background The SUM carrier waveform is a sinewave by default.

Panel Operation

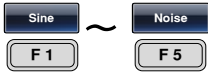

1. Press the Waveform key. 
2. Press F1~F5 to select the carrier waveform. 

Range Carrier Waveform Sine, square, pulse, ramp and noise wave.

SUM Carrier Frequency

The maximum carrier frequency depends on the selected carrier waveform. The default carrier frequency is 1kHz.

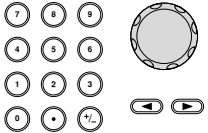
Panel Operation





1. Press the FREQ/Rate key to select the carrier frequency. 
2. The FREQ parameter will become highlighted in the parameter window.
3. Use the arrow keys and scroll wheel or number pad to enter the frequency. 
4. Press F2 ~ F6 to select the frequency units. 

Range Carrier Waveform Sine wave Carrier Frequency 1μHz~200MH(max)

Square wave	1μHz~60MHz(max)
Pulse wave	1μHz~50MHz(max)
Ramp wave	1μHz~5MHz
Default frequency	1 kHz

SUM Waveform

The function generator can accept internal and external sources. The MFG-2220HM includes sine, square, pulse, UpRamp and DnRamp as internal sources. The default waveform is sine.

- Panel Operation
1. Press the MOD key. 
 2. Press F5 (SUM). 
 3. Press F4 (Shape). 
 4. Press F1~F5 to select the source waveform. 
 5. Press Return to return to the previous menu. 

Range	Square wave	50% Duty cycle
	Up ramp	100% Symmetry
	Triangle	50% Symmetry
	Down ramp	0% Symmetry

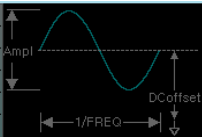
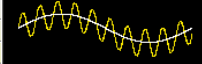
CH2	FREQ	1.000000000	kHz						
	AMPL	3.000	Vpp Phase 0.0 °						
	DC Offset	0.00	V _{DC}						
									
CH1	FREQ	1.000000000	kHz						
	AMPL	3.000	Vpp						
	DC Offset	0.00	V _{DC}						
	SUM Ampl:	50.00	%						
	SUM Freq:	100.000	Hz						
									
Type: SUM Source: INT Shape: Sine									
<table border="1"> <tr> <td>Sine</td> <td>Square</td> <td>Triangle</td> <td>UpRamp</td> <td>DnRamp</td> <td>Return</td> </tr> </table>				Sine	Square	Triangle	UpRamp	DnRamp	Return
Sine	Square	Triangle	UpRamp	DnRamp	Return				

Modulating Waveform Frequency

The frequency of the modulating waveform (SUM Frequency) can be set from 2mHz to 50kHz. The function generator accepts internal and external SUM sources.

Panel Operation 1. Press the MOD key.



2. Press F5 (SUM).



3. Press F3 (SUM Freq).



4. The SUM Freq parameter will become highlighted in the parameter window.

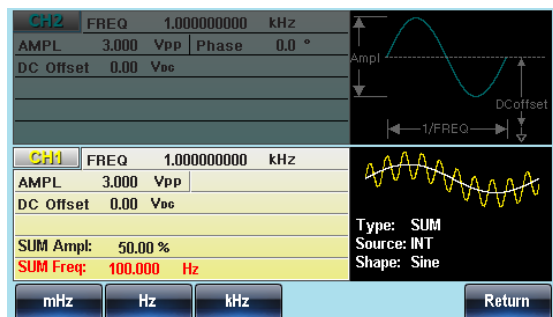

5. Use the arrow keys and scroll wheel or number pad to enter the SUM frequency.

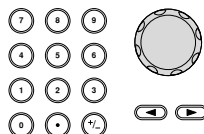

6. Press F1~F3 to select the frequency units.



Range	Modulating range	2mHz~50kHz
	Default frequency	100Hz

SUM Amplitude

The SUM depth is the offset (in percent relative to the carrier) of the signal that is added to the carrier.

Panel Operation 1. Press the MOD key.



2. Press F5 (SUM).



3. Press F5 (SUM Ampl).



4. SUM Depth will be highlighted in the parameter window.

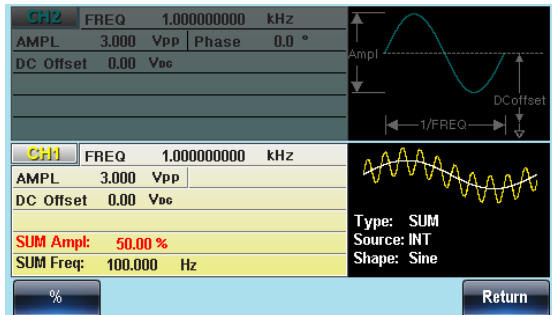

5. Use the arrow keys and scroll wheel or number pad to enter the SUM depth.

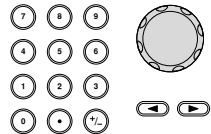

6. Press F1 to select the percentage unit.





Range	Sum depth	0~100%
	Default depth	50%

Select the SUM Source

The signal generator can accept internal or external sources for the SUM modulation.

- | | | |
|-----------------|--|---|
| Panel Operation | <ol style="list-style-type: none"> 1. Press the MOD key. 2. Press F5 (SUM). 3. Press F1 (Source). 4. Press F1 (INT) or F5 (EXT) to select the source. 5. Press Return to return to the previous menu. | 







 |
|-----------------|--|---|

External Source	<p>Use the MOD INPUT terminal on the rear panel when using an external source.</p>	
-----------------	--	---



Note

If an external modulation source is selected, the SUM depth is controlled by the $\pm 5V$ from the MOD INPUT terminal on the rear panel. For example, if the SUM depth is set to 0%, then the maximum depth (100% of the carrier) will be at +5V, and the minimum depth (0% of the carrier) will be at -5V.

CH2	FREQ	1.000000000	kHz
	AMPL	3.000	Vpp
	Phase	0.0	°
	DC Offset	0.00	Vdc

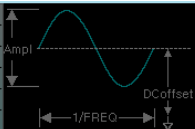

CH1	FREQ	1.000000000	kHz
	AMPL	3.000	Vpp
	DC Offset	0.00	Vdc

SUM Ampl:	50.00	%
SUM Freq:	100.000	Hz

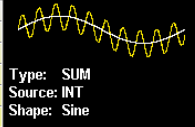

Type: SUM
Source: INT
Shape: Sine

INT EXT Return

Frequency Sweep

The function generator can perform a sweep for sine, square or ramp waveforms, but not noise, and pulse. When Sweep mode is enabled, Burst or any other modulation modes will be disabled.

In Sweep mode the function generator will sweep from a start frequency to a stop frequency over a number of designated steps. The step spacing of the sweep can be linear or logarithmic. The function generator can also sweep up or sweep down in frequency. If manual or external sources are used, the function generator can be used to output a single sweep.

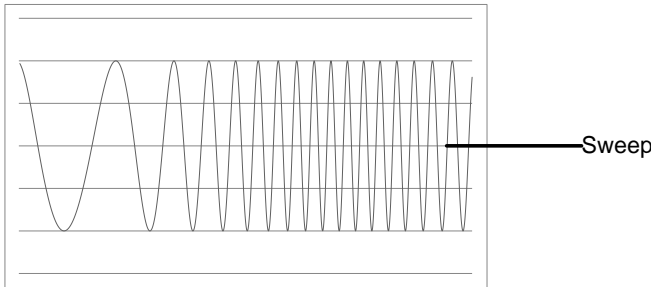

Selecting Sweep Mode

The Sweep button is used to output a sweep. If no settings have been configured, the default settings for output amplitude, offset and frequency are used.



Setting Start and Stop Frequency

The start and stop frequencies define the upper and lower sweep limits. The function generator will sweep from the start through to the stop frequency and cycle back to the start frequency. The sweep is phase continuous over the full sweep range (1μHz-max Frequency).

Panel Operation 1. Press the SWEEP key.



2. Press F3 (Start) or F4 (Stop) to select the start or stop frequency.

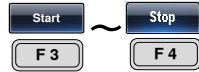

3. The Start or Stop parameter will become highlighted in the parameter window.

Start

GEN	FREQ	1.000000000 kHz							
AMPL	3.000 Vpp	Phase 0.0 °							
DC Offset	0.000 Vdc								
CH1	Sweep Time:	1.000 SEC	<p>Type: Sweep Linear Source: INT Trigger Out: Rise</p>						
AMPL	3.000 Vpp								
DC Offset	0.000 Vdc								
Start:	100.000000 Hz								
Stop:	1.000000000 kHz								
Marker:	----								
<table border="1"> <tr> <td>uHz</td> <td>mHz</td> <td>Hz</td> <td>kHz</td> <td>MHz</td> <td>Return</td> </tr> </table>			uHz	mHz	Hz	kHz	MHz	Return	
uHz	mHz	Hz	kHz	MHz	Return				

Stop

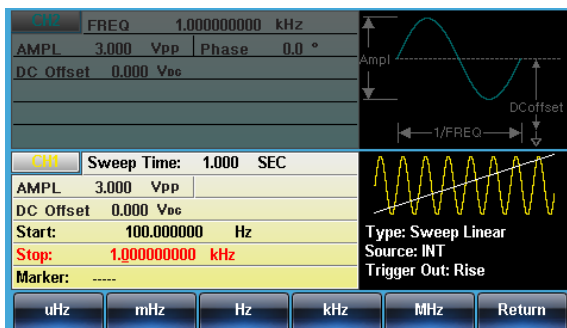

4. Use the arrow keys and scroll wheel or number pad to enter the Stop/Start frequency.

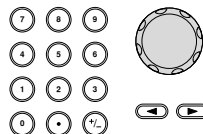

5. Press F1~F5 to select the Start/Stop frequency units.



Range

Sweep Range

Sine wave	1μHz~200MH(max)
Square wave	1μHz~60MHz(max)
Pulse wave	1μHz~50MHz(max)
Ramp wave	1μHz~1MHz
Start - Default	100Hz
Stop - Default	1kHz

Note

To sweep from low to high frequencies, set the start frequency less than the stop frequency.
To sweep from high to low frequencies, set the start frequency greater than the stop frequency.

When Marker is off, the sync signal is a square wave with a 50% duty cycle. When the sweep starts, the sync signal will be at a TTL low and will transition to a TTL high level at the center frequency. The SYNC signal frequency is equal to the specified sweep time.

When marker is on, the SYNC signal is at a TTL high level at the start of the sweep and drops to a TTL low level at the marker frequency.

The SYNC signal is output from the TRIG output terminal.

Center Frequency and Span

A center frequency and span can be set to determine the upper and lower sweep limits (start/stop).

Panel Operation 1. Press the SWEEP key.



2. Press F6 (More).



3. Press F1 (Span) or F2 (Center) to select the span or center.



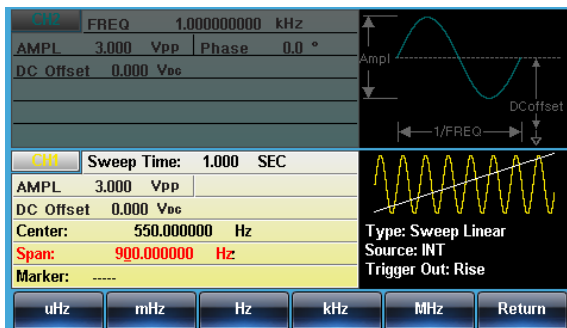

4. The Span or Center parameters will become highlighted in the waveform display area.

Span

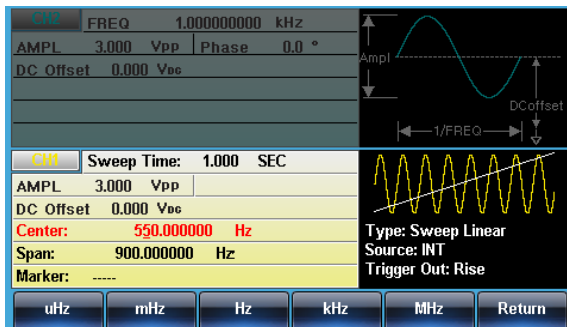

Center

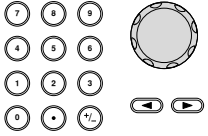

5. Use the arrow keys and scroll wheel or number pad to enter the Span/Center frequency.
 
6. Press F1~F5 to select the Start/Stop frequency units.
 

Range	Center frequency
	Sine wave 1μHz~200MH(max)
	Square wave 1μHz~60MHz(max)
	Pulse wave 1μHz~50MHz(max)
	Ramp wave 1μHz~1MHz
	Span frequency
	Sine wave 1μHz~200MH(max)
	Square wave 1μHz~60MHz(max)
	Pulse wave 1μHz~250MHz(max)
	Ramp wave 1μHz~1MHz
	Default center 550Hz
	Default span 900Hz



Note

To sweep from low to high frequencies, set a positive span. To sweep from high to low frequencies, set a negative span.

When Marker is off, the sync signal is a square wave with a 50% duty cycle. When the sweep starts, the sync signal will be at a TTL low and will transition to a TTL high level at the center frequency. The SYNC signal frequency is equal to the specified sweep time.

When Marker is on, the SYNC signal is at a TTL high level that drops to a TTL low level at the marker frequency.

The SYNC signal is output from the TRIG output terminal.

Sweep Mode

Sweep mode is used to select between linear or logarithmic sweeping. Linear sweeping is the default setting.

Panel Operation 1. Press the SWEEP key.

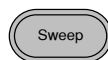

2. Press F2 (Type).



3. To select linear or logarithmic sweep, press F1 (Linear) or F2 (Log).



4. Press Return to return to the previous menu.

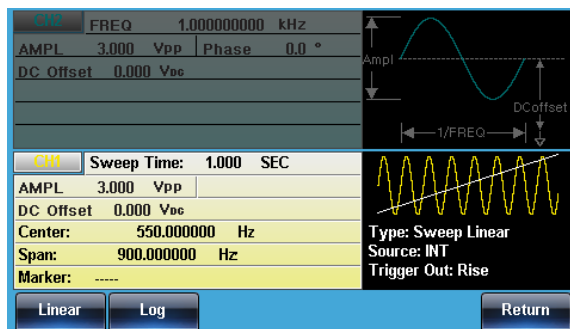

Sweep Time

The sweep time is used to determine how long it takes to perform a sweep from the start to stop frequencies. The function generator automatically determines the number of discrete frequencies used in the scan depending on the length of the scan.

Panel Operation 1. Press the SWEEP key.



2. Press F5 (SWP Time).



3. The Time parameter will become highlighted in the waveform display area.

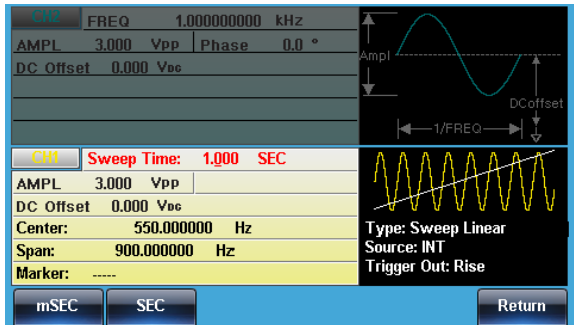

4. Use the selector keys and scroll wheel or number pad to enter the Sweep time.

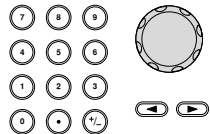

5. Press F1~F2 to select the time unit.



Range	Sweep time	1 ms ~ 500s
	Default time	1s

Marker Frequency

The marker frequency is the frequency at which the marker signal goes low (The marker signal is high at the start of each sweep). The marker signal is output from the TRIG output terminal on the rear panel. The default is 550 Hz.

Panel Operation 1. Press the SWEEP key.



2. Press F6 (More).



3. Press F3 (Marker)



4. Press F2 (ON/OFF) to toggle the marker on or off.





5. Press F1 (Freq) to select the marker frequency.

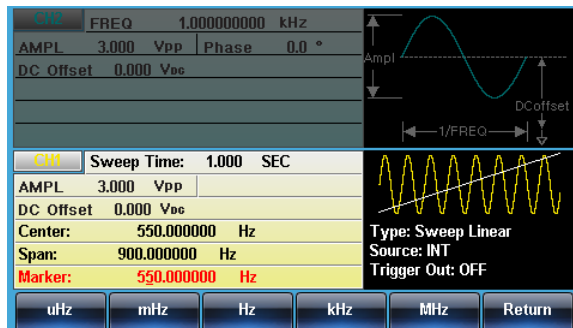

6. The Marker parameter will become highlighted in the parameter window.

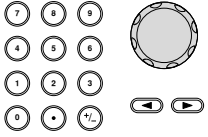

7. Use the arrow keys and scroll wheel or number pad to enter the frequency. 
8. Press F1~F5 to select the frequency unit. 



Range	Frequency
	Sine wave 1μHz~200MH(max)
	Square wave 1μHz~60MHz(max)
	Pulse wave 1μHz~50MHz(max)
	Ramp wave 1μHz~5MHz
	Default 550Hz

 **Note** The marker frequency must be set to a value between the start and stop frequencies. If no value is set, the marker frequency is set to the average of the start and stop frequencies.

Marker mode will override SYNC mode settings when sweep mode is active.

Sweep Trigger Source

In sweep mode the function generator will sweep each time a trigger signal is received. After a sweep output has completed, the function generator outputs the start frequency and waits for a trigger signal before completing the sweep. The default trigger source is internal.

- Panel Operation
1. Press the SWEEP key. 
 2. Press F1 (Source). 

3. To select the trigger source, press F1 (Internal), F2 (External) or F3 (Manual).

INT

F1

~

Manual

F3

4. Press Return to return to the previous menu.

Return

Note Using the Internal source will produce a continuous sweep using the sweep time settings. With an external source, a sweep is output each time a trigger pulse (TTL) is received from the TRIG input terminal on the rear panel. The trigger period must be equal to or greater than the sweep time plus 1ms.

5. If manual is selected, press F1 (Trigger) to manually start each sweep.

Trigger

F1

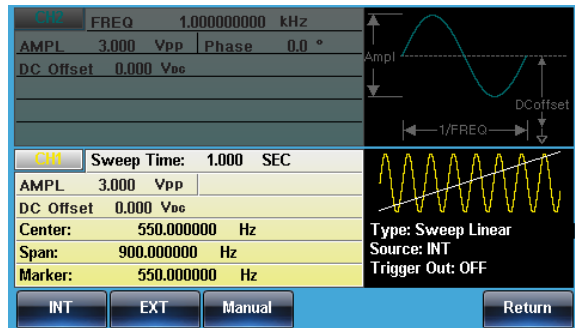

Burst Mode

The function generator can create a waveform burst with a designated number of cycles. Burst mode supports sine, square, triangle and ramp waveforms.

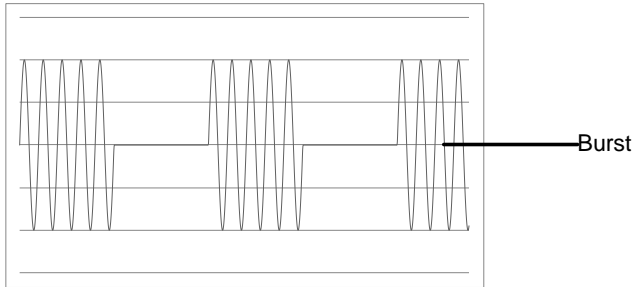

Selecting Burst Mode

When burst mode is selected, any modulation or sweep modes will be automatically disabled. If no settings have been configured, the default settings for output amplitude, offset and frequency are used.



Burst Modes

Burst mode can be configured using Triggered (N Cycle mode) or Gated mode. Using N Cycle/Triggered mode, each time the function generator receives a trigger, the function generator will output a specified number of waveform cycles (burst). After the burst, the function generator will wait for the next trigger before outputting another burst. N Cycle is the default Burst mode. Triggered mode can use internal or external triggers.

The alternative to using a specified number of cycles, Gated mode uses the external trigger to turn on or off the output. When the Trigger INPUT signal is high, waveforms are continuously output. When the Trigger INPUT signal goes low, the waveforms will stop being output after the last waveform completes its period. The

voltage level of the output will remain equal to the starting phase of the burst waveforms, ready for the signal to go high again.

Burst Mode	Burst Count	Burst Period	Phase	Trigger Source
Triggered (Int)	Available	Available	Available	Immediate
Triggered (Ext)	Available	Not used	Available	EXT, Bus
Gated pulse (Ext)	Not used	Not used	Available	Unused

In Gated mode, burst count, burst cycle and trigger source are ignored. If a trigger is input, then the trigger will be ignored and will not generate any errors.

Panel Operation 1. Press the Burst key.



2. To select either N Cycle (F1) or Gate (F2).



Burst Frequency

In the N Cycle and Gated modes, the waveform frequency sets the repetition rate of the burst waveforms. In N-Cycle mode, the burst is output at the waveform frequency for the number of cycles set. In Gated mode the waveform frequency is output while the trigger is high. Burst mode supports sine, square, triangle or ramp waveforms.

Panel Operation 1. Press the **FREQ/Rate** key.



2. The **FREQ** parameter will become highlighted in the parameter window.

3. Use the arrow keys and scroll wheel or number pad to enter the frequency.

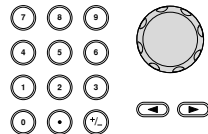

4. Press F2~F6 to select the frequency unit.



Range	Frequency– Sine	1uHz~200MHz(max)
	Frequency– Square	1uHz~60MHz(max)
	Frequency – Ramp	1uHz~5MHz
	Default	1kHz



Note

Waveform frequency and burst period are not the same. The burst period is the time between the bursts in N-Cycle mode.

Burst Cycle/Burst Count

The burst cycle (burst count) is used to define the number of cycles that are output for a burst waveform. Burst cycle is only used with N-cycle mode (internal, external or manual source). The default burst cycle is 1.

- Panel Operation
1. Press the Burst key.



2. Press F1 (N Cycle).



3. Press F1 (Cycles).



4. The Cycles parameter will become highlighted in the Waveform Display area.



- Use the arrow keys and scroll wheel or number pad to enter the number of cycles.

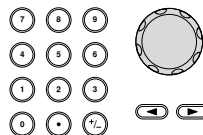

- Press F5 to select the Cyc unit.



Range	Cycles	1~1,000,000
-------	--------	-------------



Note

Burst cycles are continuously output when the internal trigger is selected. The burst period determines the rate of bursts and the time between bursts.





Burst cycle must be less than the product of the burst period and wave frequency.

$$\text{Burst Cycle} < (\text{Burst Period} \times \text{Wave Frequency})$$

If the burst cycle exceeds the above conditions, the burst period will be automatically increased to satisfy the above conditions.

If gated burst mode is selected, burst cycle is ignored. Though, if the burst cycle is changed remotely whilst in gated mode, the new burst cycle is remembered when used next.

Infinite Burst Count



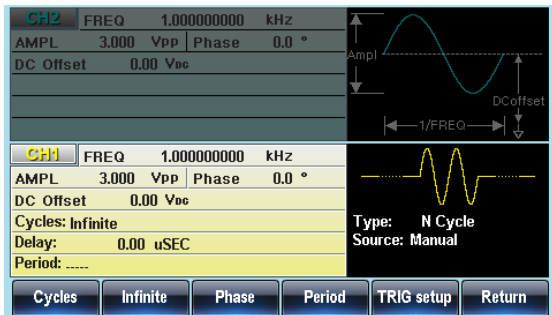

- Panel Operation
1. Press the Burst key. 
 2. Press F1 (N Cycle).  
 3. Press F2 (Infinite).  

Note Infinite burst is only available when using manual triggering.



Burst Period

The burst period is used to determine the time between the start of one burst and the start of the next burst. It is only used for internally triggered bursts.

- Panel Operation
1. Press the Burst key. 
 2. Press F1 (N Cycle).  
 3. Press F4 (Period).  
 4. The Period parameter will become highlighted in the Waveform Display area.

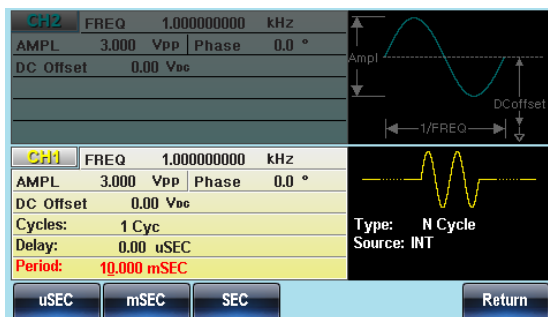

5. Use the arrow keys and scroll wheel or number pad to enter period time.

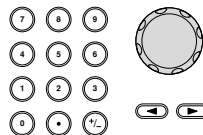

6. Press F1~F3 to choose the period time unit.



Range	Period time	1ms~500s
	Default	10ms

Note

Burst period is only applicable for internal triggers. Burst period settings are ignored when using gated burst mode or for external and manual triggers.

The burst period must be large enough to satisfied the condition below:

$$\text{Burst Period} > \text{Burst Count} / \text{Wave frequency} + 200\text{ns.}$$

Burst Phase

Burst Phase defines the starting phase of the burst waveform. The default is 0°.

Panel Operation 1. Press the Burst key.



2. Press F1 (N Cycle).



3. Press F3 (Phase).



4. The Phase parameter will become highlighted in the Waveform Display area.

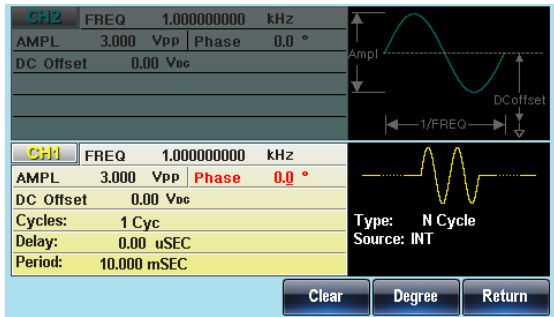

5. Use the arrow keys and scroll wheel or number pad to enter the phase.

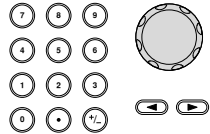

6. Press F5 (Degree) to select the phase unit.



Range	Phase	-360° ~+360°
	Default	0°

**Note**

When using sine, square, triangle or ramp waveforms, 0° is the point where the waveforms are at zero volts.

0° is the starting point of a waveform. For sine, square or Triangle, Ramp waveforms, 0° is at 0 volts (assuming there is no DC offset).

Burst Phase is used for both N cycle and Gated burst modes. In gated burst mode, when the Trigger INPUT signal goes low the output is stopped after the current waveform is finished. The voltage output level will remain equal to the voltage at the starting burst phase.

Burst Trigger Source

Each time the function generator receives a trigger in triggered burst (N-Cycle) mode, a waveform burst is output. The number of waveforms in each burst is designated by the burst cycle (burst count). When a burst has completed, the function generator waits for the next trigger. Internal source is the default triggered burst (N-cycle) mode on power up.

Panel Operation

1. Press the Burst key.



2. Press F1 (N Cycle).



3. Press F5 (TRIG setup).



4. Choose a trigger type by pressing F1 (INT), F2 (EXT) or F3 (Manual).



Manual Triggering

If a manual source is selected, the Trigger softkey (F1) must be pressed each time to output a burst.

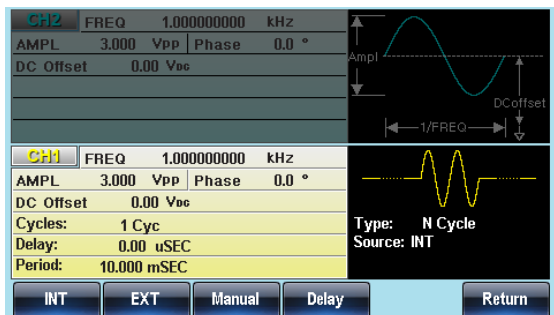



Note

When the internal trigger source is chosen, the burst is output continuously at a rate defined by the burst period setting. The interval between bursts is defined by the burst period.

When the external trigger is selected the function generator will receive a trigger signal (TTL) from the Trigger INPUT terminal on the rear panel. Each time the trigger is received, a burst is output (with the defined number of cycles). If a trigger signal is received during a burst, it is ignored.

When using the manual or external trigger only the burst phase and burst cycle/count are applicable, the burst period is not used.

A time delay can be inserted after each trigger, before the start of a burst.

Burst Delay

Panel Operation

1. Press the Burst key.



2. Press F1 (N Cycle).



3. Press F5 (TRIG setup).



4. Press F4 (Delay).



5. The Delay parameter will become highlighted in the Waveform Display area.

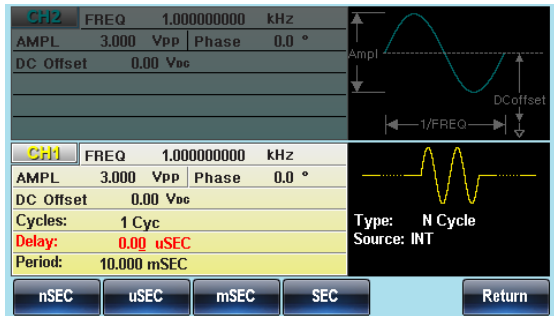

- 6. Use the selector keys and scroll wheel or number pad to enter period time.

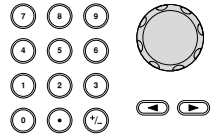













- 7. Press F1~F4 to choose the delay time unit.



Range	Delay time	0ns~100s
	Default	0s

Burst Trigger Output

The Trig Out terminal on the rear panel can be used for burst or sweep modes to output a rising edge TTL compatible trigger signal. By default the trigger signal is rising edge. The trigger signal is output at the start of each burst.

- | | | |
|-----------------|--|--|
| Panel Operation | 1. Press the Burst key. |  |
| | 2. Press F1 (N Cycle). |   |
| | 3. Press F5 (TRIG setup). |   |
| | 4. Press F5 (TRIG out). |   |
| | 5. Press F3 (ON/OFF) to toggle Trigger out ON/OFF. |   |
| | 6. Select F1 (Rise) or F2 (Fall) edge trigger. |   
  |

 **Note**

When the internal or external trigger is selected, the trigger output signal will be at either a TTL low/high level and will toggle when the specified number of waveform cycles completed.

When the manual trigger is selected, the trigger output turns on at the trigger soft-key is pressed.

When the manual trigger is selected, the function generator automatically disables the trigger output. When using a manual trigger, the function generator outputs a pulse wave (>1us) from the Trig Out terminal.

S SECONDARY SYSTEM FUNCTION SETTINGS

The secondary system functions are used to store and recall settings, view help files, view the software version, update the firmware, set the buzzer.

Save and Recall	186
Selecting the Remote Interface	189
LAN Interface.....	189
LAN Host Name.....	191
USB Interface.....	192
System and Settings	194
Viewing and Updating the Firmware	194
Language Selection	195
Setting the Buzzer Sound.....	195
Display Brightness.....	196
Reference Clock Sources	197
Frequency Counter	198
Screen Capture	199

Save and Recall

The MFG-2220HM has non-volatile memory to store instrument state and ARB data. There are 10 memory files numbered 0~9. Each memory file can either store arbitrary waveform data (ARB), settings or both. When data (ARB or Setting data) is stored in a memory file, the data will be shown in red. If a file has no data, it will be shown in blue.

Save/Recall Properties	ARB	
	<ul style="list-style-type: none"> • Rate • Frequency • Length • Display horizontal 	<ul style="list-style-type: none"> • Display vertical • Output Start • Output length
	Setting	
	<ul style="list-style-type: none"> • Functions <ul style="list-style-type: none"> • Waveform • Frequency • Pulse Width • Edge time • Square wave Duty • Ramp Symmetry • Amplitude • Amplitude unit • Offset • Modulation type • Beep setting • Impedance • Main output • Sweep <ul style="list-style-type: none"> • Source • Type 	<ul style="list-style-type: none"> • AM <ul style="list-style-type: none"> • Source • Shape • Depth • AM frequency • ASK <ul style="list-style-type: none"> • Source • Rate • ASK amplitude • FM <ul style="list-style-type: none"> • Source • Shape • Deviation • FM frequency • FSK <ul style="list-style-type: none"> • Source • Rate

- Marker
- Time
- Start frequency
- Stop frequency
- Center frequency
- Span frequency
- Marker frequency
- Burst Type
- Source
- Trigger out
- Type
- Cycles
- Phase
- Period
- Delay
- Hop frequency
- PM
- Source
- Shape
- Phase
- PM Frequency
- PSK
- Source
- Rate
- PSK phase
- SUM
- Source
- Shape
- SUM amplitude
- SUM Frequency

Panel Operation 1. Press the UTIL key.



2. Press F1 (Memory).



Path: Memory:\Memory0:

Memory0:	ARB	Setting	ARB+Setting
Memory1:	ARB	Setting	ARB+Setting
Memory2:	ARB	Setting	ARB+Setting
Memory3:	ARB	Setting	ARB+Setting
Memory4:	ARB	Setting	ARB+Setting
Memory5:	ARB	Setting	ARB+Setting
Memory6:	ARB	Setting	ARB+Setting
Memory7:	ARB	Setting	ARB+Setting
Memory8:	ARB	Setting	ARB+Setting
Memory9:	ARB	Setting	ARB+Setting

Store Recall Delete Delete All

- Choose a file operation:

Press F1 to store a file, press F2 to recall a file, or press F3 to delete a file.



- Use the scroll wheel to select a memory file.

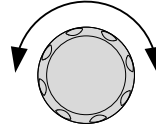

- Use the scroll wheel to choose the data type.

Range	Memory file	Memory0 ~ Memory9
	Data type	ARB, Setting, ARB+Setting

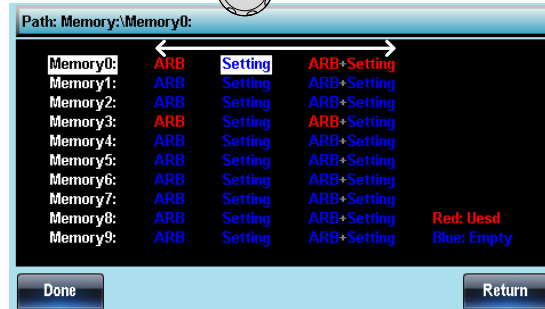

- Press F5 (Done) to confirm the operation.



Delete All

- To delete all the files for Memory0~Memory9, press F4.



- Press F1 (Done) to confirm the deletion of all files.













Selecting the Remote Interface

The MFG-2220HM has LAN and USB interfaces for remote control. Only one remote interface can be used at any one time.

LAN Interface

Background When using the LAN interface, an IP must be specified (DHCP, Auto IP or manually configured).

- Panel Operation**
1. Press the UTIL key. 
 2. Press F2 (Interface). 

 3. Press F3 (LAN). 

 4. Press F2 (Config). 

 5. Choose how to configure the IP address. Press F1 (DHCP), F2 (Auto IP) or F3 (Manual). 
 ~ 



Range	DHCP	Use DHCP to automatically configure the IP address of the unit for networks with a DHCP server.
	Auto IP	Use Auto IP to automatically configure the IP address of the unit when it is directly connected to a host PC via an Ethernet cable.

Manual

Manually configure the IP address.

6. If Manual was selected, set F1 (IP Addr), F2 (NetMask) and F3 (Gateway) in turn.









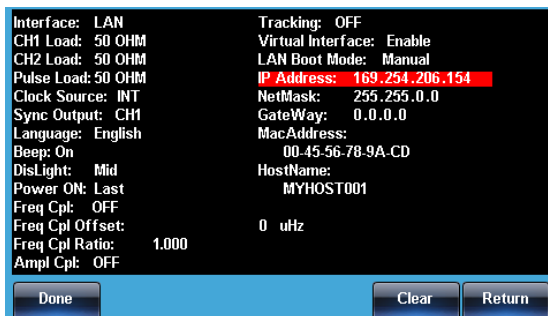

7. The IP address, net mask or gateway settings become highlighted in the parameter window.

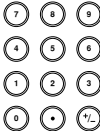



8. Use the number pad to enter the IP address, Net mask or gateway. Use the decimal point as a field separator.

9. Press F5 (Done) to confirm the settings.













10. Finally, press F5 (Done) to confirm all the IP configuration settings.







LAN Host Name

Background The following describes how to set the host name for the unit when used in the LAN interface.

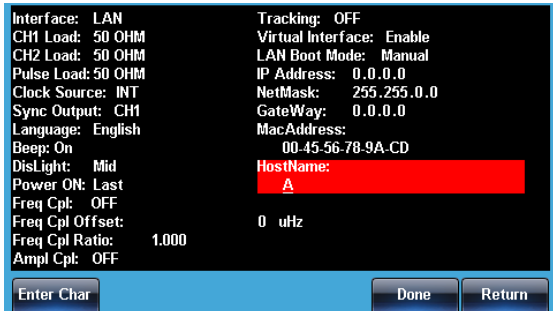
- Panel Operation**
1. Press the UTIL key. 
 2. Press F2 (Interface). 

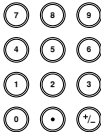
 3. Press F3 (LAN). 

 4. Press F2 (Config). 

 5. Press F4 (HostName) to set the host name for the unit. 

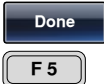
 6. The Host Name settings become highlighted in the parameter window.



- 7. Use the scroll wheel to scroll through each character.
 

- 8. Press F1 (Enter Char) to select a character and continue to the next character.
 

- 9. Press F5 (Done) to confirm the host name.
 

USB Interface

Background The following shows how to configure the meter for remote control via the USB interface.

- Panel Operation**
- 1. Press the UTIL key.
 

 - 2. Press F2 (Interface).
 

 - 3. Press F2 (USB).
 





Interface: USB	Tracking: OFF
CH1 Load: 50 OHM	Virtual Interface: Enable
CH2 Load: 50 OHM	LAN Boot Mode: AutoIP
Pulse Load: 50 OHM	IP Address: 169.254.206.154
Clock Source: INT	NetMask: 255.255.0.0
Sync Output: CH1	GateWay: 0.0.0.0
Language: English	MacAddress:
Beep: On	00.45.56.78.9A.CD
DisLight: Mid	HostName:
Power ON: Last	MYHOST001
Freq Cpl: OFF	
Freq Cpl Offset:	0 uHz
Freq Cpl Ratio: 1.000	
Ampl Cpl: OFF	



USB LAN Return

System and Settings

There are a number of miscellaneous settings and firmware settings that can be configured.





Viewing and Updating the Firmware

- Panel Opearon
1. Press the UTIL key. 
 2. Press F3 (Cal.).  
 3. Press F2 (Software).  
-

- View Version
4. Press F1 (Version) to view the firmware version.  

The version information will be shown on screen:

Instrument, Version, FPGA Version, Bootloader Version

- Update Firmware
5. To update the firmware, insert a USB flash drive with a firmware file in the USB host drive. Press F2 (Upgrade).  
 6. Press F1 (Select) to select the corresponding CPU file.  
-







Note

FPGA file must be located in the USB root directory. To update, do select the the CPU file rather than the FPGA file.



Language Selection

Background The MFG-2220HM can be operated in English or Simplified Chinese. By default, the language is set to English.

- Panel Operation**
1. Press the UTIL key. 
 2. Press F4 (System). 
 3. Press F2 (Language). 
 4. The Language parameter will become highlighted.
 5. Press F2 (English) to select the language. 

Setting the Buzzer Sound

Background Turns the beeper on or off.





- Panel Operation**
1. Press the UTIL key. 
 2. Press F4 (System). 
 3. Press F4 (Beep) to toggle the buzzer sound on or off. 
 4. The Beep parameter will become highlighted.



Display Brightness

Background The brightness of the display can be set from the utility-system menu.

- Panel Operation**
1. Press the UTIL key. 



 2. Press F4 (System). 

 3. Press F5 (DisLight) 

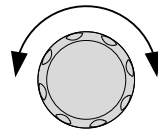

 4. Press F2 (Brightness).  

Use the scroll wheel to set the brightness of the display.



- | Range | Brightness | Low ,mid,high |
|-------|---|---|
| | 5. Press F1 (Enter) to finish setting the brightness. |   |

Reference Clock Sources

Background An external 26.8436MHz reference signal can be used to replace the internal 26.8436MHz clock signal. An external reference clock can be used to increase the accuracy or stability of the clock signal. It can also be used to sync different units together so that they operate on a synchronized clock.





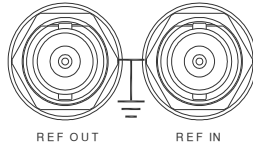





The REF OUT port provides a sync signal of the internal reference clock. This port can be used to synchronize other equipment to the internal reference clock of the function generator.

Connection





Reference Output Specifications	Item	Specification
	Output Voltage	1Vp-p/50Ω square wave
	Output Impedance	50Ω, AC coupled
	Output Frequency	26.8436MHz

Reference Input Specifications	Item	Specification
	Input Voltage	0.5Vp-p to 5Vp-p
	Input Impedance	1kΩ, unbalanced, AC coupled
	Max. Allowed Input	± 10Vdc
	Input Frequency	26.8436MHz ±10Hz
	Waveform	Sine or square (50±5% duty)



- Panel Operation
1. Press the UTIL key. 
 2. Press F4 (System) 

 3. Press F3 (Clk Source). 

 4. Select F1(INT) or F2(EXT) to choose the clock source. 

Range	INT	Sets the internal clock as the reference clock.
	EXT	Sets an external 26.8436MHz signal as the reference clock.



5. If F2(EXT) was selected as the clock source, Press F3(EXT Sync) to synchronize the unit to the external reference signal. 

Frequency Counter

Example: Turn on the frequency counter. Gate time: 1 second.

- Output: N/A
1. Press UTIL, F6 (Counter). 

Input:

2. Press F2 (Gate Time), and press F3 (1 Sec) to choose a gate time of 1 second. 

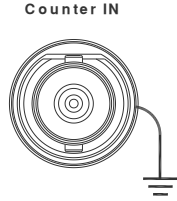

3. Connect the signal of interest to the Frequency counter input on the rear panel.

4. Input a 1kHz square wave signal into the Counter input on the rear panel. Set the gate time to 1S.

Screen Capture

Background The function generator is able to capture screenshots and save them to a USB flash drive.

Connection 1. Insert a USB key into the USB port on the rear panel. 

Panel Operation 2. Press the UTIL key. 

3. Press F4 (System). 

4. Press F1 (Hardcopy). 

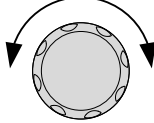
5. Use the scroll wheel to scroll through the different screen shots. A screen shot is captured each time a function is used. 

Function: Waveform, ARB, MOD (AM, ASK, FM, FSK, PM, PSK, SUM, PWM), Sweep, Burst, UTIL

6. When a screen is selected, press F1 to save the screen shot. The utility menu will reappear after 2 seconds. This indicates that the screen shot was saved.



C CHANNEL SETTINGS

The channel settings chapter shows how to set the output impedance, output phase and DSO connection settings.

Output Impedance	202
Selecting the Output Phase.....	203
Synchronizing the Phase.....	204
DSO Link	204

Output Impedance





Background The MFG-2220HM has selectable output impedances: 50Ω or high impedance. The default output impedance is 50Ω. The output impedances are to be used as a reference only. If the actual load impedance is different to that specified, then the actual amplitude and offset will vary accordingly.

Panel Operation 1. Press the CH1/CH2 key. 

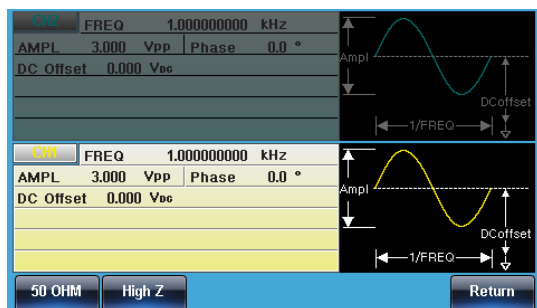
Note The load function can only be used if the ARB, MOD, SWEEP or BURST functions are not active.

2. Press F1 (Load).  



3. Select F1 (50 OHM) or F2(High Z) to select the output impedance.    

Selecting the Output Phase

Panel operation 1. Press the CH1/CH2 key.



2. Press F5 (Phase).



3. The Phase parameter in the parameter window will become highlighted.

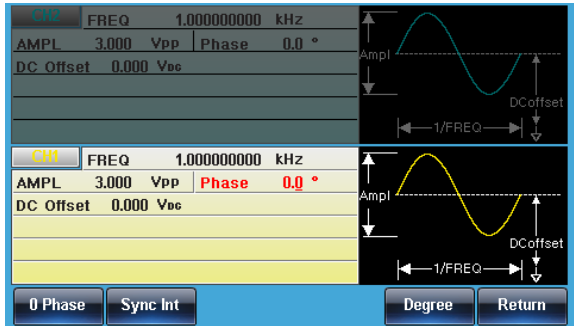

4. Use the arrow keys and scroll wheel or number pad to enter the output phase.

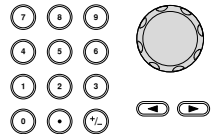



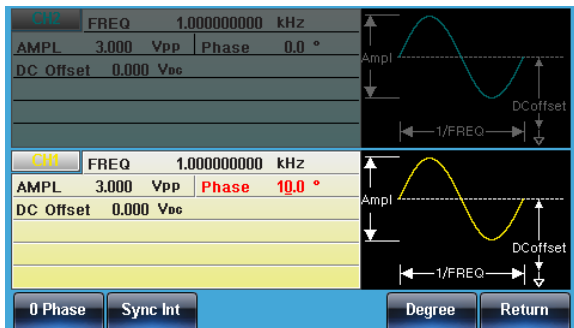

5. Press F5 (Degree).



Synchronizing the Phase





Background Synchronizes both the outputs on the MFG-2220HM.

- Panel Operation**
1. Press the CH1/CH2 key. 
 2. Press F5 (Phase).  
 3. Press F2 (S_Phase) to synchronize the phase of the channels.  

DSO Link

Background DSO Link enables the MFG-2220HM to receive lossless data from a GDS-2000 Series DSO.

1. Connect the MFG-2220HM USB host port to the GDS-2000's USB B device port. 

- Panel Operation**
2. Press the CH1/CH2 key. 
 3. Press F6 (DSO Link).  
 4. Press F1 (Search).  

5. To select a DSO channel, Press F2 (CH1), F3 (CH2), F4 (CH3) or F5 (CH4). The acquired data can then be displayed.



DUAL CHANNEL OPERATION

The dual channel section details how to operate the unit in dual channel mode (MFG-2220HM Series) and how to set any channel-specific settings.

Frequency Coupling	207
Amplitude Coupling	209
Channel Tracking	210
Sync Int.....	211

Frequency Coupling

Background Frequency coupling sets the frequency of the unselected channel as a frequency offset from the selected channel or as a ratio of the frequency of the selected channel.

- Panel Operation**
1. Press the UTIL key. 

 2. Press F5 (Dual Ch). 

 3. Press F1 (Freq Cpl). 

 4. To set the unselected channel's frequency as an offset from the selected channel's frequency, press F2 (Offset). 

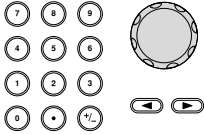
 - Use the selector keys and scroll wheel or number pad to enter the frequency offset. 

 - Press F2~F6 to select the offset frequency units. 

 5. To set the unselected channel's frequency as a ratio of the selected channel's frequency, press F3 (Ratio). 

Use the selector keys and scroll wheel or number pad to enter the ratio.

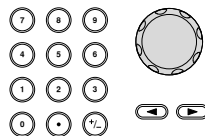

Press F5 (Enter) to confirm.







6. Alternatively, press F1 (OFF) to disable frequency coupling.



Range	Offset Range	-200MHz ~ 200MHz (max)
	Offset Resolution	1uHz. Unselected channel's frequency = selected channel's frequency + offset. Selected channel's frequency is fixed.
	Ratio Range	1000.000 ~ 0.001
	Ratio Resolution	0.001. Ratio = Unselected channel's frequency/selected channel's frequency. Selected channel's frequency is fixed.

Amplitude Coupling



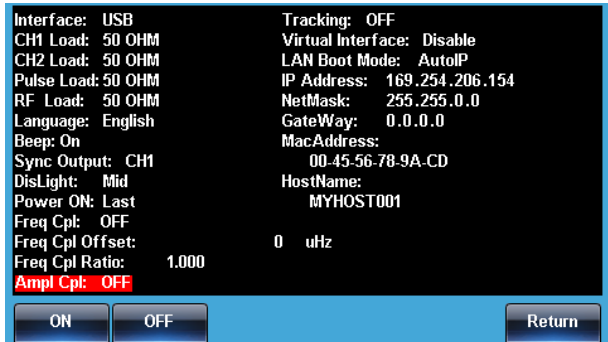

Background Amplitude coupling couples the amplitude of one channel to the other channel. When the amplitude settings for one channel are changed, those same settings are automatically reflected in the other channel.

- Panel Operation**
1. Press the UTIL key. 
 2. Press F5 (Dual Ch). 
 3. Press F2 (Ampl Cpl). 
 4. Press F1 to turn amplitude coupling ON or F2 to turn amplitude coupling OFF. 



Channel Tracking

Background Channel tracking will set the waveform output of one channel to be the same as the other channel. When the settings of one channel are changed, those changes are tracked on the other channel. This function also has the ability to perform inverted tracking, where the output on one channel is inverted in relation to the other channel.

- Panel Operation**
1. Press the UTIL key. 
 2. Press F5 (Dual Ch). 
 3. Press F3 (Tracking). 
 4. To select the tracking function, press F1 (OFF), F2 (ON) or F3 (Inverted). 

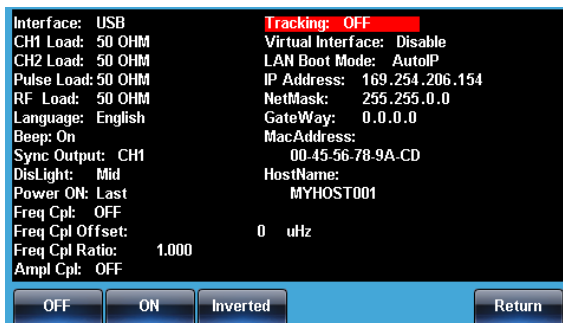

Sync Int

Background Synchronizes the phase of both channels and sets the phase to 0°.

Panel Operation 1. Press the UTIL key.



2. Press F5 (Dual Ch).



3. Press F4 (Sync Int).

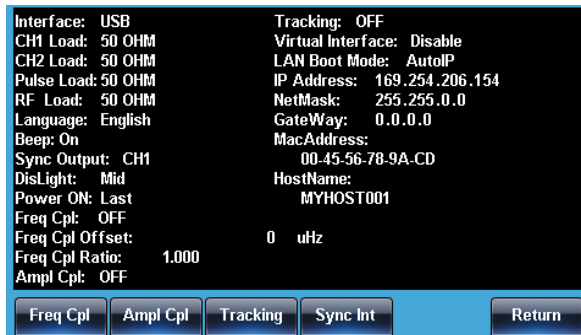

A

ARBITRARY WAVEFORMS

The MFG-2220HM can create user-defined arbitrary waveforms with a sample rate of 500MHz. Each waveform can include up to 16k of data points with a vertical range of $\pm 8192(16384)$.

Inserting Built-In Waveforms	213
Create an AbsAtan Waveform	213
Display an Arbitrary Waveform	215
Set the Horizontal Display Range	215
Set the Vertical Display Properties	217
Page Navigation (Back Page)	219
Page Navigation (Next Page)	221
Display	222
Editing an Arbitrary Waveform	223
Adding a Point to an Arbitrary Waveform	223
Adding a Line to an Arbitrary Waveform	225
Copy a Waveform	226
Clear the Waveform	228
ARB Protection	230
Output an Arbitrary Waveform	233
Output Arbitrary Waveform	233
Saving/Recalling an Arbitrary Waveform	235
Saving a Waveform to Internal Memory	235
Saving a Waveform to USB Memory	236
Load a Waveform from Internal Memory	239
Load a Waveform from USB	241

Inserting Built-In Waveforms

The MFG-2220HM includes 66 common waveforms, such as comon, math waveforms, windowing functions and engineering waveforms.

Create an AbsAtan Waveform

Panel Operation 1. Press the ARB key.



2. Press F3(Built in).



3. Press F4(Wave).



4. Press F5(Select)



5. Press F6(Return)



6. Press F1(Start).



7. The Start parameter will become highlighted.

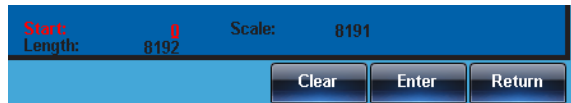



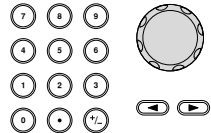

8. Use the arrow keys and scroll wheel or number pad to enter the output phase.



9. Press F2 (Enter) to confirm the Start point.



10. Press Return to return to the previous menu. 

11. Repeat steps 4~8 for completing setting of Length (F2) and Scale (F3).  ~ 
 

12. Press F5 (Done) to complete the operation  

13. Press Return to return to the previous menu. 



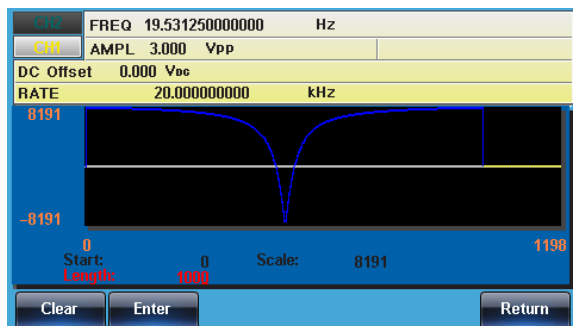

Below an Absatan wave created at start:0, Length: 1000, Scale: 8191





Display an Arbitrary Waveform





Set the Horizontal Display Range

The horizontal window bounds can be set in one of two ways: Using a start point and length, or a center point and length.

- Panel Operation
1. Press the ARB key. 
 2. Press F1 (Display) to enter the display menu.  
 3. Press F1 (Horizon) to enter the horizontal menu.  

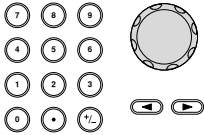
- Using a Start Point
4. Press F1 (Start)  
 5. The H_From parameter will become highlighted.



6. Use the arrow keys and scroll wheel or number pad to enter the H_From value. 
7. Press Clear (F4) to cancel.  
8. Press F5 (Enter) to save the settings.  

9. Press Return to return to the previous menu. **Return**

Setting the Length 10. Repeat steps 4~9 for Length (F2). **Length** **F 2**

Using a Center Point 11. Repeat steps 4~9 for Center (F3). **Center** **F 3**

Zoom in 12. To zoom into the arbitrary waveform, press F4 (Zoom In). The Zoom In function will reduce the length by half each time the function is used. The minimum allowable length is 3. **Zoom In** **F 4**

Zoom out 13. To zoom out from the center point of the waveform, press F5 (Zoom out). The Zoom out function will increase the length by 2. The maximum allowable length is 16384. **Zoom Out** **F 5**

Below, an arbitrary waveform has a start of 0, length of 500 and is centered at 250.

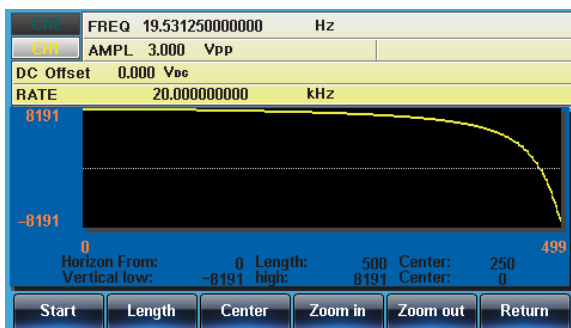

Set the Vertical Display Properties

Like the horizontal properties, the vertical display properties of the waveform display can be created in two ways: Setting high and low values, or setting the center point.

Panel Operation 1. Press the ARB key.



2. Press F1 (Display).



3. Press F2 (Vertical).



Setting the Low Point 4. Press F1 (Low).



5. The Vertical Low parameter will become highlighted.



6. Use the arrow keys and scroll wheel or number pad to enter the Vertical Low value.

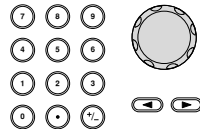

7. Press Clear (F4) to cancel.



8. Press F5 (Enter) to save the settings.



9. Press Return to return to the previous menu.



Setting the High Point 10. Repeat steps 4~9 for High (F2). High F 2

Setting the Center Point 11. Repeat steps 4~9 for Center (F3). Center F 3

Zoom 12. To zoom in from the center of the arbitrary waveform, press F4 (Zoom in). The Zoom in function will reduce the length by half each time the function is used. The minimum allowable vertical low is -2, and the minimum vertical high is 2. Zoom in F 4



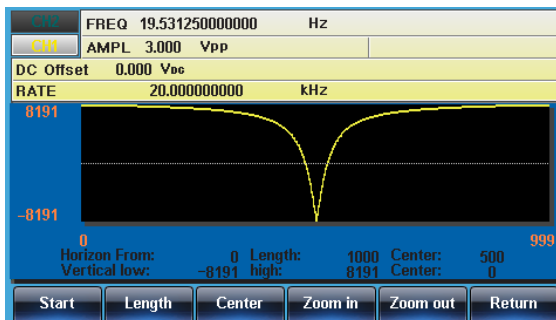

13. To zoom out of the waveform, press F5 (Zoom out). The Zoom out function will increase the length by 2. The Vertical low maximum can be set to -8191 and the vertical high maximum can be set to +8191. Zoom out F 5

Below, the AbsAtan wave is with a vertical low of -8191, a vertical high 8191 and a center of 0.



Page Navigation (Back Page)

Background When viewing the waveform, the display window can be moved forward and backward using the Next/Back Page functions.

- Panel Operation**
1. Press the ARB key. 
 2. Press F1 (Display).  
 3. Press F4 (Back Page) to move the display window one view length backward.  

Horizontal From* = Horizontal From - Length
 Center* = Center - Length
 *Length is not less than 2



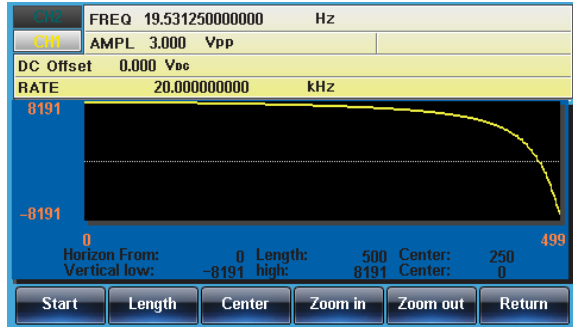

Below, shows the display after Back Page has been pressed.

Horizon From: 200 → 0
 Length: 500
 Center: 450 → 250



Page Navigation (Next Page)

Background When viewing the waveform, the display window can be moved forward and backward using the Next/Back Page functions.

- Panel Operation**
1. Press the ARB key. 
 2. Press F1 (Display).  
 3. Press F3 (Next Page) to move the display window one view length forward.  

Horizon From* = Horizon From + Length
 Center = Center + Length
 *Horizon From + Length ≤ 16384

Below, shows the display after Next Page has been pressed.

Horizon From: 0 → 500
 Length: 500
 Center: 250 → 750

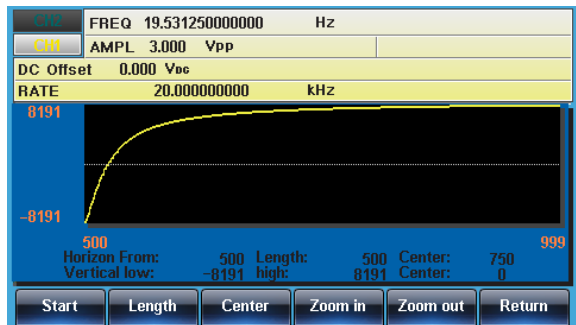

Display

Panel Operation 1. Press the ARB key.



2. Press F1 (Display).



3. To make the display window cover the whole waveform, press F5 (Overview).



Horizontal: 0~1000

Vertical: -8191~8191

Below shows the display after Overview has been selected.

Horizon From: 200 → 0

Length: 1199 → 16384

Center: 799 → 8192

Vertical low/high: ±8191

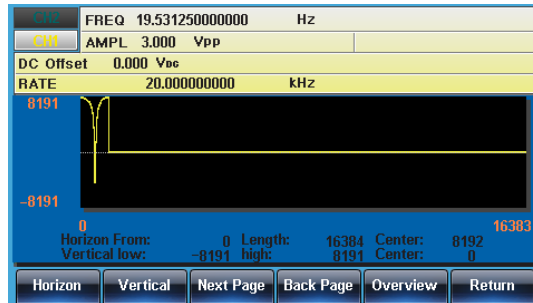

Editing an Arbitrary Waveform

Adding a Point to an Arbitrary Waveform

Background The MFG-2220HM has a powerful editing function that allows you to create points or lines anywhere on the waveform.

Panel Operation 1. Press the ARB key.



2. Press F2 (Edit).



3. Press F1 (Point).



4. Press F1 (Address).



5. The Address parameter becomes red.



6. Use the arrow keys and scroll wheel or number pad to enter the Address value.

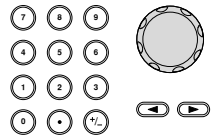

7. Press F5 (Enter) to save the settings.



8. Press Return to return to the previous menu.



9. Press F2 (Data).



10. The Value parameter will become Red.



11. Use the selector keys and scroll wheel or number pad to enter a Data value.

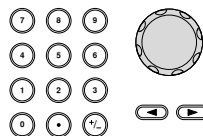

12. Press F5 (Enter) to save the settings.



13. Press Return to return to the previous menu.



14. Press F6 (Return) again to go back to the ARB menu.



In the following figure the edited address is shown in red.

Address 100, Data 1000

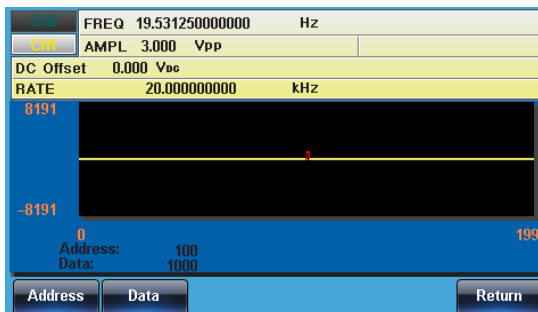

Adding a Line to an Arbitrary Waveform

Background The MFG-2220HM has a powerful editing function that allows you to create points or lines anywhere on the waveform.

Panel Operation 1. Press the ARB key.



2. Press F2 (Edit).



3. Press F2 (Line).



4. Press F1 (Start ADD).



5. The Start Address parameter will be highlighted in red.

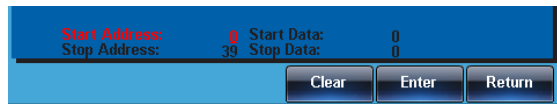

6. Use the arrowkeys keys and scroll wheel or number pad to enter the start address.

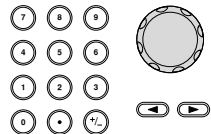

7. Press F5 (Enter) to save the settings.



8. Press Return to return to the previous menu.



9. Repeat steps 4~8 for Start Data (F2), Stop Address (F3) and Stop Data (F4).

10. Press F5 (Done) to confirm the line edit. Done F 5

11. Press Return to return to the previous menu. Return Return

The red line was created below with the following properties:

Start Address: 0, Start Data: 0

Stop Address: 500, Stop Data: 0

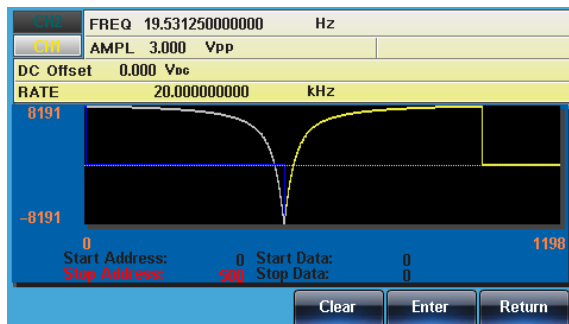

Copy a Waveform

- Panel Operation
1. Press the ARB key. ARB ARB
 2. Press F2 (Edit). Edit F 2
 3. Press F3 (Copy). Copy F 3
 4. Press F1 (Start). Start F 1
 5. The Copy From properties will become highlighted in Red

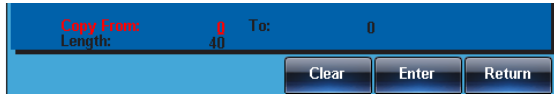

6. Use the arrow keys and scroll wheel or number pad to enter the Copy From address.

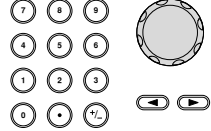

7. Press F5 (Enter) to save the settings.



8. Press Return to return to the previous menu.



9. Repeat steps 4~8 for Length (F2) and Paste To (F3).

10. Press F5 (Done) to confirm the selection.



11. Press Return to return to the previous menu.



A section of the waveform from points 150~250 was copied to points 300~400:

Copy From: 0
 Length: 500
 To: 100

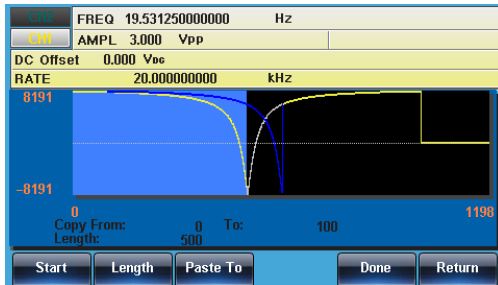

Clear the Waveform

Panel Operation 1. Press the ARB key.



2. Press F2 (Edit).



3. Press F4 (Clear).



4. Press F1 (Start).



5. The Clear From properties will become highlighted in red.



6. Use the arrow keys and scroll wheel or number pad to enter the Clear From address.

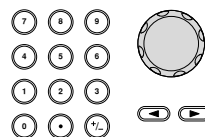

7. Press F5 (Enter) to save the settings.



8. Press Return to return to the previous menu.



9. Repeat steps 4~8 for Length (F2).



10. Press F3 (Done) to clear the selected section of the arbitrary waveform.



11. Press Return to return to the previous menu. **Return**

Delete All

12. Press F5 (ALL) to delete the whole waveform. **All** **F 5**

13. Press F5 (Done) again to confirm the deletion. **Done** **F 5**

14. Press Return return to the previous menu. **Return**

Clear From: 100, Length: 500.

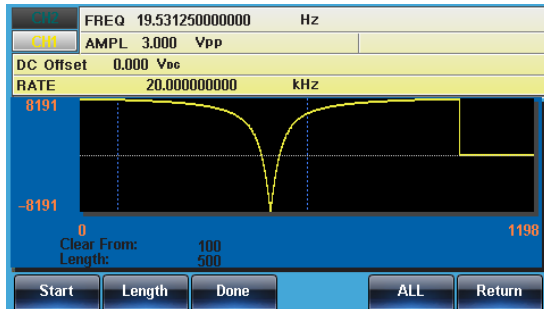

The same area after being cleared:

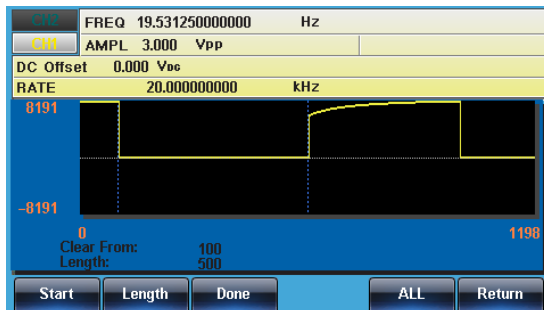

The result after the whole waveform is deleted:



ARB Protection

The protection function designates an area of the arbitrary waveform that cannot be altered.

Panel Operation 1. Press the ARB key.



2. Press F2 (Edit).



3. Press F5 (Protect).



4. Press F2 (Start).



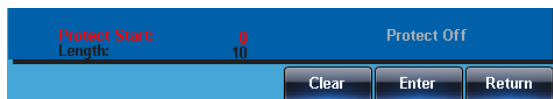

5. The Protect Start properties will become highlighted in red.



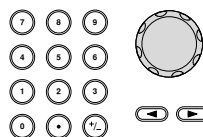

6. Use the arrow keys and scroll wheel or number pad to enter the Protect Start address.





7. Press F5 (Enter) to save the settings.  



8. Press Return to return to the previous menu. 

9. Repeat steps 4~8 for Length (F3).  

10. Press F4 (Done) to confirm the protected area.  



11. Press Return to return to the previous menu. 

12. Press F4(Done) to protect the selected areas of the waveform.  

Protect All 13. Press F1 (ALL) to protect the whole waveform.  

14. Press F1 (Done) to confirm.  

15. Press Return to return to the previous menu. 

Unprotect All 16. Press F5 (Unprotect) to unprotect the whole waveform.  

17. Press F6 (Done) to confirm.  

18. Press Return to return to the previous menu. 

19. The waveform background will return back to black. The property “Unprotected” be will grayed out.

Below, the protected areas of the waveform are shown with an blue background:

Start:100, Length: 500.

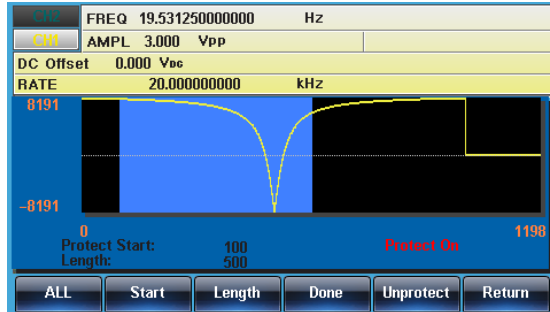

Ouput an Arbitrary Waveform

The arbitrary waveform generator can output up to 16k points (2~16384).

Ouput Arbitrary Waveform

Panel Operation 1. Press the ARB key.



2. Press F6 (Output).



3. Press F1 (Start).



4. The Start property will become highlighted in red.



5. Use the arrow keys and scroll wheel or number pad to enter the Start address.

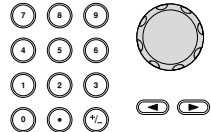

6. Press F5 (Enter) to confirm the start point.



7. Press Return to return to the previous menu.



8. Repeat steps 4~7 for Length (F2).



9. Press Return to return to the previous menu.

The front panel terminal will output the following waveform.

Start 100, Length 500

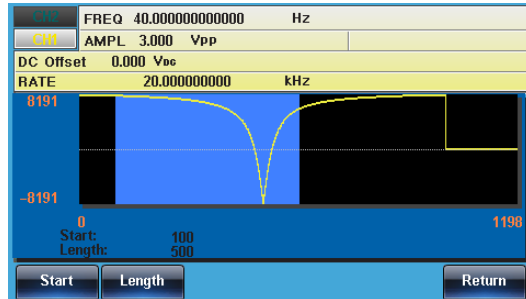

Saving/Recalling an Arbitrary Waveform

The MFG-2220HM can save and load arbitrary waveforms from 10 internal memory slots. Arbitrary waveforms can also be saved and loaded from a USB memory stick.

Saving a Waveform to Internal Memory

Panel Operation 1. Press the ARB key.



2. Press F4 (Save).



3. Press F1 (Start).



4. The Start property will become highlighted in red.



5. Use the arrow keys and scroll wheel or number pad to enter the Start address.

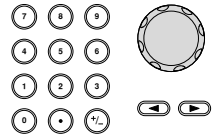

6. Press F5 (Enter) to confirm the start point.



7. Press F6 (Return) to return to the previous menu.



8. Repeat steps 4~8 for Length (F2).



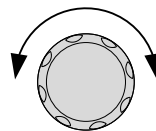

9. Press F3 (Memory).  

10. Select a memory file using the scroll wheel.



ARB0~ARB9

11. Press F1 (Select) to save the selected memory file.  

12. Press Return to return to the previous menu. 

Below the file ARB1 is selected using the scroll wheel.

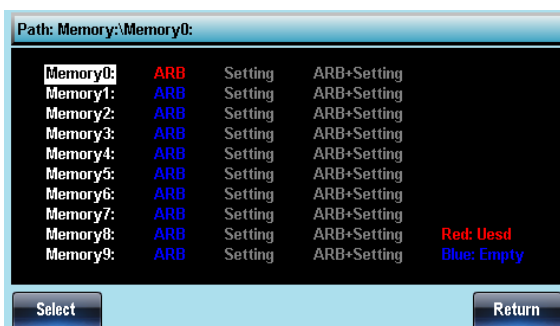

Saving a Waveform to USB Memory

Panel Operation 1. Press the ARB key. 

2. Press F4 (Save).  

3. Press F1 (Start).  

- The Start property will become highlighted in red.



- Use the arrow keys and scroll wheel or number pad to enter the Start address.

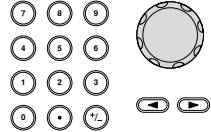

- Press F5 (Enter) to confirm the start point.



- Press F6 (Return) to return to the previous menu.



- Repeat steps 4~8 for Length (F2).



- Press F4 (USB).



- Use the scroll wheel to navigate the file system.

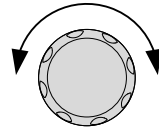

- Press Select to select directories or files.



- Create a Folder
- Press F2 (New Folder).



- The text editor will appear with a default folder name of "NEW_FOL".

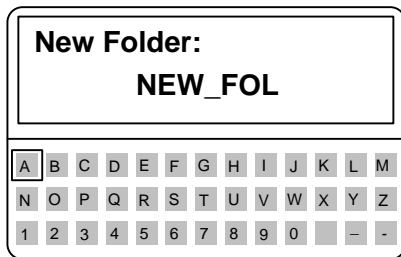

14. Use the scroll wheel to move the cursor.

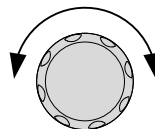

15. Use F1 (Enter Char) or F2 (Backspace) to create a folder name.



16. Press F5 (Save) to save the folder name.



Create a New File 17. Press F3 (New File).



18. The text editor will appear with a default file name of "NEW_FIL".

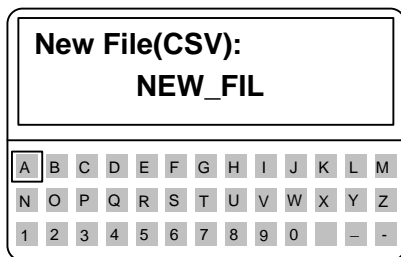

19. Use the scroll wheel to move the cursor.

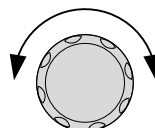

20. Use F1 (Enter Char) or F2 (Backspace) to create a file name.



21. Press F5 (Save) to save the file name.



Below the folder, ABC, and the file, MFG.CSV, have been created in the root directory.

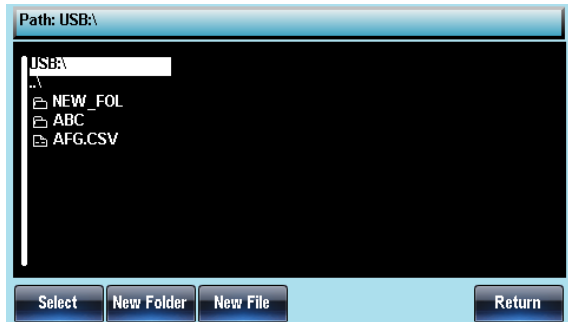

Load a Waveform from Internal Memory

- Panel Operation 1. Press the ARBkey.



2. Press F5 (Load).



3. Press F1 (Memory).



4. Use the scroll wheel to choose a memory file.

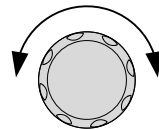

5. Press Select to load the selected memory file.



6. Press F3 (To) to choose the starting point for the loaded waveform.



7. The Load To parameter will become highlighted in red.



8. Use the selector keys and scroll wheel or number pad to enter the starting point.

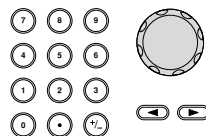

9. Press F5(Enter) to confirm the start point.



10. Press F6 (Return) to return to the previous menu.



11. Press F5(Done).



Below the file ARB1 is selected using the scroll wheel loaded to position 0.

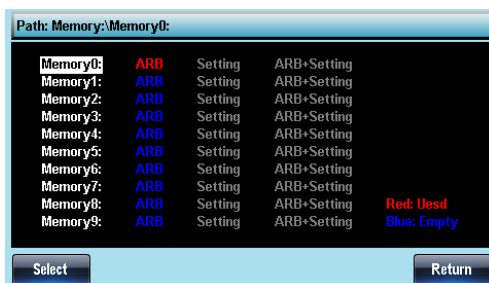

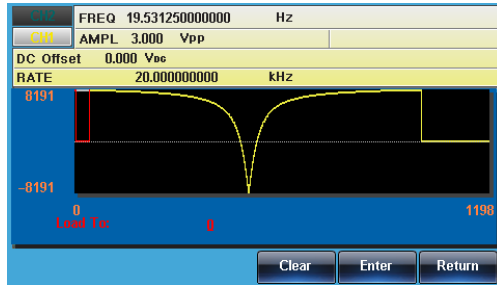

Load a Waveform from USB

Panel Operation 1. Press the ARB key.



2. Press F5 (Load).



3. Press F2 (USB).



4. Use the scroll wheel to choose a file name.

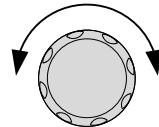

5. Press F1 (Select) to select the file to load.



6. Press F3 (To) to choose the starting point for the loaded waveform.



7. The Load To property will become highlighted in red.



8. Use the arrow keys and scroll wheel or number pad to enter the starting point.

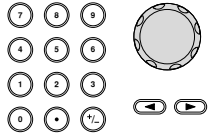

9. Press F5(Enter) to confirm the Start point.



10. Press F5(Done).



Below the file AFG.CSV is selected using the scroll wheel loaded to position 0.

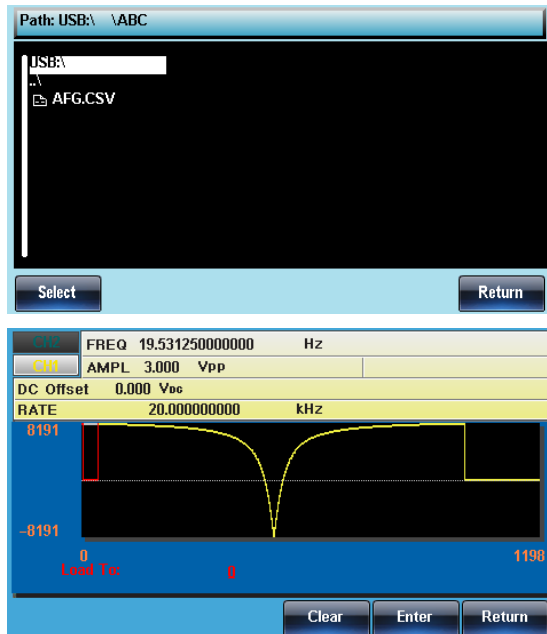

REMOTE INTERFACE

Establishing a Remote Connection	244
Configure USB interface	244
Configure LAN interface	244
Remote control terminal connection	247
Web Browser Control Interface	249
Overview	249
Command Syntax	253
Command List	258

Establishing a Remote Connection

The MFG-2220HM supports USB remote connections.

Configure USB interface

USB configuration	PC side connector	Type A, host
	MFG-2220HM side connector	Type B, slave
	Speed	1.1/2.0 (full speed)

- Panel Operation
1. Download and install the USB driver from the GW Instek website, www.gwinstek.com. Go to the Product > Signal Sources > Arbitrary Function Generators > MFG-2220HM product page to find the USB driver setup file.

Double click the driver file and follow the instructions in the setup wizard to install the driver.

2. Press the Utility key followed by Interface (F2) and USB (F2).



3. Connect the USB cable to the rear panel USB B (slave) port.



Configure LAN interface

LAN configuration	MAC Address	Domain Name
	Instrument Name	DNS IP Address
	User Password	Gateway IP Address
	Instrument IP Address	Subnet Mask

HTTP Port 80 (fixed)

Panel Operation

1. Connect the LAN cable to the rear panel LAN port.



2. Press the Utility key followed by Interface (F2) and LAN (F3).



DHCP Connections

Use DHCP to automatically configure the IP address of the unit for networks with a DHCP server.

3. Press Config (F2) followed by DHCP (F1), Done(F5). Press Done(F5) again.



Auto IP Connections

Use Auto IP to automatically configure the IP address of the unit when it is directly connected to a host PC via the Ethernet cable.

4. Press Config (F2) followed by Auto IP (F2), Done(F5). Press Done(F5) again.



Manual IP Connections

Manually configure the IP address.

5. Press Config (F2) followed by Manual (F3).



6. Press IP Addr (F1) and set the IP address using the number pad. Press Done (F1) to complete setting the IP Address.



7. Press NetMask (F2) and set the mask address using the number pad. Press Done (F1) to complete setting the net mask.



8. Press Gateway (F3) and set the gateway address using the number pad. Press Done (F1) to complete setting the gateway.



9. Press Done (F5) to complete setting the manual IP address and to return to LAN interface menu. Press Done(F5) again.



Setting the Host Name

10. Press Host Name (F4).



11. Enter the host name using the scroll wheel, arrow keys and soft-keys. Use the scroll wheel to highlight a character, and press Enter Char (F1) to select the highlighted character.

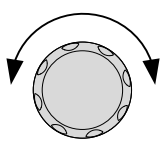

12. Press Done (F5) to finish setting the Host Name. Press Done(F5) again.



Remote control terminal connection

Terminal application Invoke the terminal application such as MTTY (Multi-Threaded TTY). For USB, set the COM port, baud rate, stop bit, data bit, and parity accordingly.

To check the COM port No, see the Device Manager in the PC. For WinXP, Control panel → System → Hardware tab.

Functionality check

Run this query command via the terminal.
*idn?

This should return the Manufacturer, Model number, Serial number, and Firmware version in the following format.

GW INSTEK, MFG-2220HM,
SN:XXXXXXXX,Vm.mm

Note: ^j or ^m can be used as the terminal character when using a terminal program.

PC Software

The proprietary PC software, downloadable from GWInstek website, can be used for remote control.

Display

When a remote connection is established all panel keys are locked bar F5.

1. Press REM/LOCK (F6) to return the function generator to local mode.



CH2	FREQ	1.000000000	kHz
	AMPL	3.000	Vpp Phase 0.0 °
	DC Offset	0.00	Vdc
CH1	FREQ	1.000000000	kHz
	AMPL	3.000	Vpp Phase
	DC Offset	0.00	Vdc
	AM Depth:	100.0	%
	AM Freq:	100.000	Hz

Labels: Ampl, DCOffset, 1/FREQ

Labels: Type: AM, Source: INT, Shape: Sine

REM/LOC

Web Browser Control Interface

The MFG-2220HM also has a browser-based interface to remotely control the unit over a network.

Overview

Welcome Page

The Welcome Page is the home page for the browser control interface. This page lists instrument information and the LAN configuration. It also has links to the Browser Web Control and the View & Modify Configuration pages.

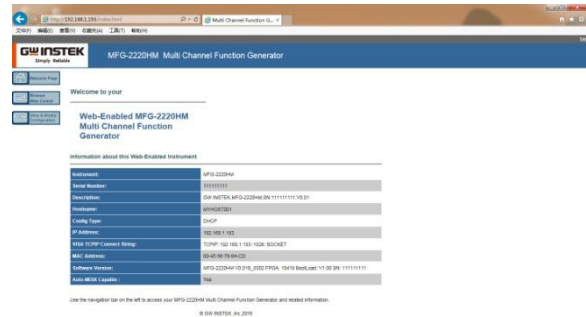

Browser Web Control

The Browser Web Control allows you to remotely control and view the unit over a LAN. The unit can be controlled via a virtual control panel using a mouse, with SCPI controls via an SCPI input box or by running SCPI commands in a file.



View & Modify Configuration

The View & Modify Configuration page displays all the LAN configuration settings and allows you to edit the configuration.



Operation

1. Configure the MFG-2220HM interface to LAN and connect it to the LAN or directly to the PC (if the LAN interface is set to Auto IP).

See Page 244 for the LAN configuration details.

2. Next enable the virtual interface on the MFG-2220HM. Press the Utility key followed by Interface (F2), LAN (F3) and Remote (F1) to enable/disable the Virtual interface.



3. Enter the IP address of the unit into the address bar of your web browser as follows:

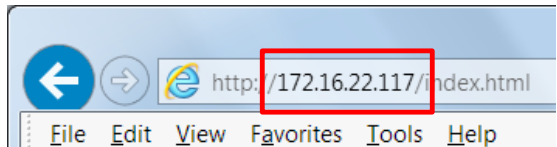

- The Welcome page will appear in the browser.

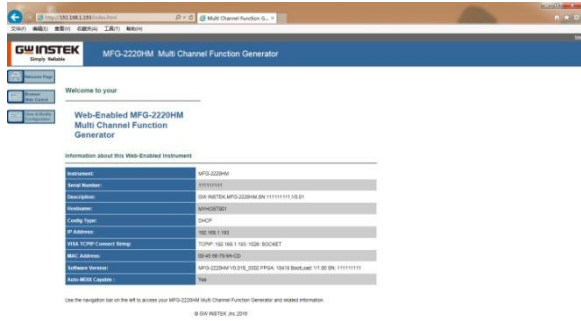

Command Syntax

Compatible standard	<ul style="list-style-type: none"> • IEEE488.2, 1992 (fully compatible) • SCPI, 1994 (partially compatible)
---------------------	---

Command Tree The SCPI standard is an ASCII based standard that defines the command syntax and structure for programmable instruments.

Commands are based on a hierarchical tree structure. Each command keyword is a node on the command tree with the first keyword as the root node. Each sub node is separated with a colon.

Shown below is a section of the SOURce[1 | 2 | 4] root node and the :PM and :PULSe sub nodes.

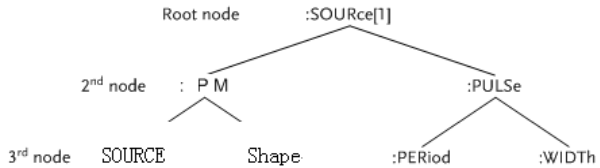

Command types Commands can be separated in to three distinct types, simple commands, compound commands and queries.

Simple	A single command with/without a parameter
Example	*OPC
Compound	Two or more commands separated by a colon (:) with/without a parameter
Example	SOURce1:PULSe:WIDTh

Query	A query is a simple or compound command followed by a question mark (?). A parameter (data) is returned. The maximum or minimum value for a parameter can also be queried where applicable.
Example	SOURce1:FREQuency? SOURce1:FREQuency? MIN

Command forms Commands and queries have two different forms, long and short. The command syntax is written with the short form of the command in capitals and the remainder (long form) in lower case.

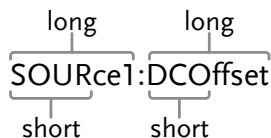

The commands can be written in capitals or lower-case, just so long as the short or long forms are complete. An incomplete command will not be recognized.

Below are examples of correctly written commands:

LONG SOURce1:DCOffset
 SOURCE1:DCOFFSET
 source1:dcoffset

SHORT SOUR1:DCO
 sour1:dco

Command Format	$\text{SOURCE1:DCOffset} \langle \text{offset} \rangle \text{LF}$	1: command header
	$\begin{array}{cccc} & & & \\ 1 & 2 & 3 & 4 \end{array}$	2: single space 3: parameter 4: message terminator

Square Brackets [] Commands that contain squares brackets indicate that the contents are optional. The function of the command is the same with or without the square bracketed items. Brackets are not sent with the command.

For example, the frequency query below can use any of the following 3 forms:

`SOURCE1:FREQUENCY? [MINimum|MAXimum]`

`SOURCE1:FREQUENCY? MAXimum`

`SOURCE1:FREQUENCY? MINimum`

`SOURCE1:FREQUENCY?`

Braces {} Commands that contain braces indicate one item within the braces must be chosen. Braces are not sent with the command.

Angled Brackets <> Angle brackets are used to indicate that a value must be specified for the parameter. See the parameter description below for details. Angled brackets are not sent with the command.

Bars | Bars are used to separate multiple parameter choices in the command format.

Parameters	Type	Description	Example
	<Boolean>	Boolean logic	0, 1/ON,OFF
	<NR1>	integers	0, 1, 2, 3
	<NR2>	decimal numbers	0.1, 3.14, 8.5
	<NR3>	floating point	4.5e-1, 8.25e+1
	<NRF>	any of NR1, 2, 3	1, 1.5, 4.5e-1

<NRf+> <Numeric>	NRf type with a suffix including MINimum, MAXimum or DEFault parameters.	1, 1.5, 4.5e-1 MAX, MIN,
<aard>	Arbitrary ASCII characters.	
<discrete>	Discrete ASCII character parameters	IMM, EXT, MAN
<frequency> <peak deviation in Hz> <rate in Hz>	NRf+ type including frequency unit suffixes.	1 KHZ, 1.0 HZ, MHZ
<amplitude>	NRf+ type including voltage peak to peak.	VPP
<offset>	NRf+ type including volt unit suffixes.	V
<seconds>	NRf+ type including time unit suffixes.	NS, S MS US
<percent> <depth in percent>	NRf type	N/A

Message terminators

LF CR	line feed code (new line) and carriage return.
LF	line feed code (new line)
EOI	IEEE-488 EOI (End-Or-Identify)



Note

^j or ^m should be used when using a terminal program.

Command Separators

Space
A space is used to separate a parameter from a keyword/command header.

Colon (:)
A colon is used to separate keywords on each node.

Semicolon (;)
A semi colon is used to separate subcommands that have the same node level.

For example:
SOURce[1|2]:DCOffset?
SOURce[1|2]:OUTPut?
→SOURce1:DCOffset?;OUTPut?

Colon + Semicolon (;:)
A colon and semicolon can be used to combine commands from different node levels.

For example:
SOURce1:PM:SOURce?
SOURce1:PULSe:WIDTh?
→SOURce1:PM:SOURce?::SOURce:PULSe:WIDTh?

Comma (,)
When a command uses multiple parameters, a comma is used to separate the parameters.

For example:
SOURce:APPLy:SQUare 10KHZ, 2.0 VPP, -1V

Command List

System	SYSTem:ERRor?.....	262
Commands	*IDN?.....	262
	*RST.....	263
	*TST?.....	263
	SYSTem:VERSion?.....	263
	*OPC.....	264
	*OPC?.....	264
Status Register	*CLS.....	265
Commands	*ESE.....	265
	*ESR?.....	266
	*STB?.....	266
	*SRE.....	267
System Remote	SYSTem:LOCal.....	268
Commands	SYSTem:REMote.....	268
Apply Commands	SOURce[1 2]:APPLY:SINusoid.....	271
	SOURce[1 2]:APPLY:SQUare.....	271
	SOURce[1 2]:APPLY:RAMP.....	272
	SOURce[1 2]:APPLY:PULSe.....	272
	SOURce[1 2]:APPLY:NOISe.....	273
	SOURce[1 2]:APPLY:TRLangle.....	273
	SOURce[1 2]:APPLY:DC.....	274
	SOURce[1 2]:APPLY:HARMonic.....	274
	SOURce[1 2]:APPLY:USER.....	275
	SOURCE[1 2]pulse:APPLY?.....	276
Output	SOURce[1 2]:FUNCTion.....	277
	SOURCE[1 2]pulse:FREQuency.....	278
	SOURCE[1 2]pulse:AMPlitude.....	280
	SOURCE[1 2]pulse:DCOffset.....	281
	SOURce[1 2]:SQUare:DCYCLE.....	282
	SOURce[1 2]:RAMP:SYMMetry.....	283
	OUTPut.....	283
	OUTPUT[1 2]pulse:LOAD.....	284
	SOURCE[1 2]:VOLTage:UNIT.....	285
OUTPUTPULSE:VOLTage:UNIT.....	286	
Pulse	SOURCEPULSE:PULSe:WIDTh.....	287
Configuration	SOURCEPULSE:PULSe:DCYCLE.....	288
	SOURCEPULSE:PULSe:TRANsition:LEADing.....	288
	SOURCEPULSE:PULSe:TRANsition:TRAlLing.....	289

Harmonic	SOURce[1 2]:HARMonic:TOTAL	290
Commands	SOURce[1 2]:HARMonic:TYPE	290
	SOURce[1 2]:HARMonic:ORDER	291
	SOURce[1 2]:HARMonic:DISPlay	292
	<hr/>	
Amplitude	AM Overview	293
Modulation (AM) Commands	SOURce[1 2]:AM:STATe	294
	SOURce[1 2]:AM:SOURce	294
	SOURce[1 2]:AM:INTernal:FUNction	295
	SOURce[1 2]:AM:INTernal:FREQuency.....	296
	SOURce[1 2]:AM:DEPTH.....	296
<hr/>		
Amplitude Shift	ASK Overview.....	298
Keying (ASK) Commands	SOURce[1 2]:ASKey:STATe	298
	SOURce[1 2]:ASKey:SOURce.....	299
	SOURce[1 2]:ASK:AMPlitude.....	299
	SOURce[1 2]:ASKey:INTernal RATE	300
<hr/>		
Frequency	FM Overview.....	301
Modulation (FM) Commands	SOURce[1 2]:FM:STATe.....	302
	SOURce[1 2]:FM:SOURce	302
	SOURce[1 2]:FM:INTernal:FUNction	303
	SOURce[1 2]:FM:INTernal:FREQuency.....	304
	SOURce[1 2]:FM:DEVIation	304
<hr/>		
Frequency-Shift	FSK Overview.....	306
Keying (FSK) Commands	SOURce[1 2]:FSKey:STATe	306
	SOURce[1 2]:FSKey:SOURce	307
	SOURce[1 2]:FSKey:FREQuency.....	307
	SOURce[1 2]:FSKey:INTernal:RATE.....	308
<hr/>		
Phase	PM Overview.....	309
Modulation (PM)Commands	SOURce[1 2]:PM:STATe.....	310
	SOURce[1 2]:PM:SOURce	310
	SOURce[1 2]:PM:INTernal:FUNction.....	311
	SOURce[1 2]:PM:INTernal:FREQuency.....	311
	SOURce[1 2]:PM:DEVIation.....	312
<hr/>		
Phase Shift	PSK Overview.....	313
Keying (PSK)Commands	SOURce[1 2]:PSKey:STATe	313
	SOURce[1 2]:PSKey:SOURce.....	314
	SOURce[1 2]:PSKey:PHASE	314
	SOURce[1 2]:PSKey:INTernal RATE	315

SUM Modulation (SUM)	SUM Overview.....	316
Commands	SOURce[1 2]:SUM:STATe.....	317
	SOURce[1 2]:SUM:SOURce	317
	SOURce[1 2]:SUM:INTernal:FUNction.....	318
	SOURce[1 2]:SUM:INTernal:FREQuency.....	318
	SOURce[1 2]:SUM:AMPL	319
Pulse Width Modulation (PWM)	PWM Overview.....	321
Commands	SOURce[1 2]:PWM:STATe.....	321
	SOURce[1 2]:PWM:SOURce.....	322
	SOURce[1 2]:PWM:INTernal:FUNction	323
	SOURce[1 2]:PWM:INTernal:FREQuency	323
	SOURce[1 2]:PWM:DUTY.....	324
Frequency Sweep	Sweep Overview	325
Commands	SOURce[1 2]:SWEep:STATe	326
	SOURce[1 2]:FREQuency:START	327
	SOURce[1 2]:FREQuency:STOP	327
	SOURce[1 2]:FREQuency:CENTer.....	328
	SOURce[1 2]:FREQuency:SPAN	329
	SOURce[1 2]:SWEep:SPACing.....	329
	SOURce[1 2]:SWEep:TIME	330
	SOURce[1 2]:SWEep:SOURce	331
	OUTPut[1 2]:TRIGger:SLOPe	332
	OUTPut[1 2]:TRIGger	332
	SOURce[1 2]:MARKer:FREQuency	333
	SOURce[1 2]:MARKer.....	335
	Burst Mode	Burst Mode Overview.....
Commands	SOURce[1 2]:BURSt:STATe	338
	SOURce[1 2]:BURSt:MODE	338
	SOURce[1 2]:BURSt:NCYCles	339
	SOURce[1 2]:BURSt:INTernal:PERiod	340
	SOURce[1 2]:BURSt:PHASe	341
	SOURce[1 2]:BURSt:TRIGger:SOURce	341
	SOURce[1 2]:BURSt:TRIGger:DELay.....	343
	SOURce[1 2]:BURSt:TRIGger:SLOPe	343
	SOURce[1 2]:BURSt:GATE:POLarity	344
	SOURce[1 2]:BURSt:OUTPut:TRIGger:SLOPe.....	345
	SOURce[1 2]:BURSt:OUTPut:TRIGger.....	346

Arbitrary Waveform Commands	Arbitrary Waveform Overview	347
	SOURce[1 2]:FUNctIon USER.....	348
	DATA:DAC	348
	SOURce[1 2]:ARB:EDIT:COpy.....	349
	SOURce[1 2]:ARB:EDIT:DELeTe.....	350
	SOURce[1 2]:ARB:EDIT:DELeTe:ALL.....	350
	SOURce[1 2]:ARB:EDIT:POINt.....	350
	SOURce[1 2]:ARB:EDIT:LINE	351
	SOURce[1 2]:ARB:EDIT:PROTeCt.....	351
	SOURce[1 2]:ARB:EDIT:PROTeCt:ALL.....	352
	SOURce[1 2]:ARB:EDIT:UNProTeCt.....	352
	SOURce[1 2]:ARB:OUTPut:MARKer.....	352
	SOURce[1 2]:ARB:OUTPut.....	354
COUNTER Commands	COUNTER:STATE	355
	COUNTer:GATe.....	355
	COUNTer:VALue?.....	356
PHASE Commands	SOURCE[1 2 pulse]:PHASe.....	357
	SOURCE[1 2 pulse]:PHASe:SYNChronize	357
COUPLE Commands	SOURce[1 2]:FREQuency:COUPlE:MODE	358
	SOURce[1 2]:FREQuency:COUPlE:OFFSet	358
	SOURce[1 2]:FREQuency:COUPlE:RATio.....	359
	SOURce[1 2]:AMPlitude:COUPlE:STATe.....	359
	SOURce[1 2]:TRACk.....	360
Save and Recall Command	SYSTem:ROSCillator:SOURce.....	361
Save and Recall Commands	*SAV.....	362
	*RCL.....	362
	MEMory:STATe:DELeTe	362
	MEMory:STATe:DELeTe ALL.....	363

System Commands

SYSTEM:ERRor?

System Query

Description	Reads an error from the error queue. See page 383 for details regarding the error queue.
-------------	--

Query Syntax	SYSTEM:ERRor?
--------------	----------------------

Return parameter	<string>	Returns an error string, <256 ASCII characters.
------------------	----------	---

Example	SYSTEM:ERRor? -138 Suffix not allowed Returns an error string.
---------	--

*IDN?

System Query

Description	Returns the function generator manufacturer, model number, serial number and firmware version number in the following format: GW INSTEK,MFG- 2220HM,SN:XXXXXXXX,Vm.mm
-------------	---

Query Syntax	*IDN?
--------------	--------------

Return parameter	<string>
------------------	----------

Example	*IDN? GW INSTEK,MFG- 2220HM,SN:XXXXXXXX,Vm.mm Returns the identification of the function generator.
---------	---

***RST** System Command

Description Reset the function generator to its factory default state.

Note Note the *RST command will not delete instrument save states in memory.

Syntax ***RST**

***TST?** System Query

Description Performs a system self-test and returns a pass or fail judgment. An error message will be generated if the self test fails.

Note The error message can be read with the SYST:ERR? query.

Query Syntax ***TST?**

Return parameter +0 Pass judgment
 +1 Fail judgment

Example ***TST?**
 +0
 The function generator passed the self-test.

SYSTem:VERSion? System Query

Description Performs a system version query. Returns a string with the instrument, firmware version, FPGA revision and bootloader.

Query Syntax **SYSTem:VERSion?**

Return parameter <string>

Example **SYST:VERS?**
 MFG-2220HM VX.XXX_XXXX

Returns the year (2010) and version for that year (1).

***OPC** System Command

Description This command sets the Operation Complete Bit (bit 0) of the Standard Event Status Register after the function generator has completed all pending operations. For the MFG-2220HM, the *OPC command is used to indicate when a sweep or burst has completed.

Note Before the OPC bit is set, other commands may be executed.

Syntax ***OPC**

***OPC?** System Query

Description Returns the OPC bit to the output buffer when all pending operations have completed. I.e. when the OPC bit is set.

Note Commands cannot be executed until the *OPC? query has completed.

Query Syntax ***OPC?**

Return parameter 1

Example ***OPC?1**
Returns a "1" when all pending operations are complete.

Status Register Commands

***CLS** System Command

Description The *CLS command clears all the event registers, the error queue and cancels an *OPC command.

Syntax ***CLS**

***ESE** System Command

Description The Standard Event Status Enable command determines which events in the Standard Event Status Event register can set the Event Summary Bit (ESB) of the Status Byte register. Any bit positions set to 1 enable the corresponding event. Any enabled events set bit 5 (ESB) of the Status Byte register.

Note The *CLS command clears the event register, but not the enable register.

Syntax ***ESE <enable value>**

Parameter <enable value> 0~255

Example ***ESE 20**

Sets a bit weight of 20 (bits 2 and 4).

Query Syntax ***ESE?**

Return Parameter	Bit	Register	Bit	Register
	0	Not used	4	Message Available
	1	Not used	5	Standard Event
	2	Error Queue	6	Master Summary
	3	Questionable Data	7	Not used

Example ***ESE?**
 4
 Bit 2 is set.

***ESR?** System Command

Description Reads and clears the Standard Event Status Register. The bit weight of the standard event status register is returned.

Note The *CLS will also clear the standard event status register.

Query Syntax ***ESR?**

Return Parameter	Bit	Register	Bit	Register
	0	Operation Complete	4	Execution Error
	1	Not Used	5	Command Error
	2	Query Error	6	Not Used
	3	Device Error	7	Power On

Query Example ***ESR?**
 5
 Returns the bit weight of the standard event status register (bit 0 and 2).

***STB?** System Command

Description Reads the Status byte condition register.

Note Bit 6, the master summary bit, is not cleared.

Syntax ***STB?**

***SRE** System Command

Description The Service Request Enable Command determines which events in the Status Byte Register are allowed to set the MSS (Master summary bit). Any bit that is set to "1" can cause the MSS bit to be set.

Note The *CLS command clears the status byte event register, but not the enable register.

Syntax ***SRE <enable value>**

Parameter <enable value> 0~255

Example ***SRE 12**
 Sets a bit weight of 12 (bits 2 and 3) for the service request enable register.

Query Syntax ***SRE?**

Return Parameter	Bit	Register	Bit	Register
	0	Not used	4	Message Available
	1	Not used	5	Standard Event
	2	Error Queue	6	Master Summary
	3	Questionable Data	7	Not used

Query Example ***SRE? 12**
 Returns the bit weight of the status byte enable register.

System Remote Commands

SYSTem:LOCal System Command

Description	Sets the function generator to local mode. In local mode, all front panel keys are operational.
-------------	---

Syntax	SYSTem:LOCal
--------	---------------------

Example	SYST:LOC
---------	-----------------

SYSTem:REMote System Command

Description	Disables the front panel keys and puts the function generator into remote mode
-------------	--

Syntax	SYSTem:REMote
--------	----------------------

Example	SYST:REM
---------	-----------------

Apply Commands

The APPLy command has 5 different types of outputs (Sine, Square, Ramp, Pulse, Noise,). The command is the quickest, easiest way to output waveforms remotely. Frequency, amplitude and offset can be specified for each function.

As only basic parameters can be set with the Apply command, other parameters use the instrument default values.

The Apply command will set the trigger source to immediate and disable burst, modulation and sweep modes. Turns on the output commandOUTPut[1 | 2 | pulse] ON. The termination setting will not be changed.

As the frequency, amplitude and offset parameters are in nested square brackets, amplitude can only be specified if the frequency has been specified and offset can only be specified if amplitude has been set. For the example:

```
SOURce[1 | 2]:APPLy:SINusoid [<frequency> [,<amplitude>
[,<offset>] ]]
```

Output Frequency For the output frequency, MINimum, MAXimum and DEFault can be used. The default frequency for all functions is set to 1 kHz. The maximum and minimum frequency depends on the function used. If a frequency output that is out of range is specified, the max/min frequency will be used instead. A "Data out range error will be generated" from the remote terminal.

**Output
Amplitude**

When setting the amplitude, MINimum, MAXimum and DEFault can be used. The range depends on the function being used and the output termination (50Ω or high impedance). The default amplitude for all functions is 100 mVpp (50Ω).

If the amplitude has been set and the output termination is changed from 50Ω to high impedance, the amplitude will double. Changing the output termination from high impedance to 50Ω will half the amplitude.

Vrms, dBm or Vpp units can be used to specify the output unit to use with the current command. The VOLT:UNIT command can be used to set the units when no unit is specified with the Apply command. If the output termination is set to high impedance, dBm units cannot be used. The units will default to Vpp.

The output amplitude can be affected by the function and unit chosen. Vpp and Vrms or dBm values may have different maximum values due to differences such as crest factor. For example, a 5Vrms square wave must be adjusted to 3.536 Vrms for a sine wave.

DC Offset voltage The offset parameter can be set to MINimum, MAXimum or DEFault. The default offset is 0 volts. The offset is limited by the output amplitude as shown below.

$$|V_{offset}| < V_{max} - V_{pp}/2$$

If the output specified is out of range, the maximum offset will be set.

The offset is also determined by the output termination (50Ω or high impedance). If the offset has been set and the output termination has changed from 50Ω to high impedance, the offset will double. Changing the output termination from high impedance to 50Ω will half the offset.

SOURce[1|2]:APPLY:SINusoid Source Specific Command

Description	Outputs a sine wave from the selected channel when the command has executed. Frequency, amplitude and offset can also be set.	
Syntax	SOURce[1 2]:APPLY:SINusoid [<frequency> [,<amplitude> [,<offset>]]]	
Parameter	<frequency>	1μHz~200MHz
	<amplitude>	1mVpp~10Vpp (50 Ω)
	<offset>	-4.99V~4.99V (50 Ω)
Example	SOUR1:APPL:SIN 2KHZ,MAX,MAX Sets frequency to 2kHz and sets the amplitude and offset to the maximum.	

SOURce[1|2]:APPLY:SQUare Source Specific Command

Description	Outputs a square wave from the selected channel when the command has executed. Frequency, amplitude and offset can also be set. The duty cycle is set to 50%.	
Syntax	SOURce[1 2]:APPLY:SQUare [<frequency> [,<amplitude> [,<offset>]]]	
Parameter	<frequency>	1μHz~25MHz
	<amplitude>	1mVpp~10Vpp (50Ω)
	<offset>	±5 Vpk ac +dc (50Ω)
Example	SOUR1:APPL:SQU 2KHZ,MAX,MAX	

Sets frequency to 2kHz and sets the amplitude and offset to the maximum.

SOURce[1 2]:APPLy:RAMP		Source Specific Command
Description	Outputs a ramp wave from the selected channel when the command has executed. Frequency, amplitude and offset can also be set. The symmetry is set to 100%.	
Syntax	SOURce[1 2]:APPLy:RAMP [<frequency> [,<amplitude> [,<offset>]]]	
Parameter	<frequency>	1μHz~5MHz
	<amplitude>	1mVpp~10Vpp (50Ω)
	<offset>	±5 Vpk ac +dc (50Ω)
Example	SOUR1:APPL:RAMP 2KHZ,MAX,MAX Sets frequency to 2kHz and sets the amplitude and offset to the maximum.	

SOURce[1 2]:APPLy:PULSe		Source Specific Command
Description	Outputs a pulse waveform from the selected channel when the command has executed. Frequency, amplitude and offset can also be set.	
Note	<p>The PW settings from the SOURce[1 2]:PULS:WIDT command are preserved. Edge and pulse width may be adjusted to supported levels.</p> <p>Repetition rates will be approximated from the frequency. For accurate repetition rates, the period should be adjusted using the SOURce[1 2]:PULS:PER command</p>	
Syntax	SOUR[1 2]pulse:APPLy:PULSe [<frequency> [,<amplitude> [,<offset>]]]	
Parameter	<frequency>	500μHz~25MHz
	<amplitude>	1mV~2.5 (50Ω)

	<offset>	±5 Vpk ac +dc (50Ω)
Example	SOUR1:APPL:PULS 1KHZ,MIN,MAX	
	Sets frequency to 1kHz and sets the amplitude to minimum and the and offset to the maximum.	
SOURce[1 2]:APPLY:NOISe		Source Specific Command
Description	Outputs Gaussian noise with a 50 MHz bandwidth. Amplitude and offset can also be set.	
Note	Frequency cannot be used with the noise function; however a value (or DEFault) must be specified. The frequency is remembered for the next function used.	
Syntax	SOURce[1 2]:APPLY:NOISe [<frequency> DEFault> [,<amplitude> [,<offset>]]]	
Parameter	<frequency>	Not applicable
	<amplitude>	1mV~10V (50Ω)
	<offset>	±5 Vpk ac +dc (50Ω)
Example	SOUR1:APPL:NOIS DEF, 3.0, 1.0	
	Sets the amplitude to 3 volts with an offset of 1 volt.	

SOURce[1 2]:APPLY:TRiangle		Source Specific Command
Description	Outputs a triangle wave from the selected channel when the command has executed. Frequency, amplitude and offset can also be set.	
Syntax	SOURce[1 2]:APPLY:TRiangle [<frequency> [,<amplitude> [,<offset>]]]	
Parameter	<frequency>	1μHz~5MHz
	<amplitude>	1mV~10V (50Ω)
	<offset>	-4.99V~4.99V (50Ω)

Example **SOUR1:APPL:TRI 2kHz,3.0,1.0**
 Sets the frequency to 1 MHz with an amplitude of 3 volts and with an offset of 1 volt.

SOURce[1|2]:APPLy:DC Source Specific Command

Description Outputs a DC signal from the selected channel when the command has executed. Amplitude and offset can also be set.

Note Frequency cannot be used with the DC function; however a value (or DEFault) must be specified.

Syntax **SOURce[1|2]::APPLy:DC**
[<frequency>|DEFault[,<amplitude> [,<offset>]]]

Parameter	<frequency DEFault>	DEF
	<amplitude>	1mV~10V (50Ω)
	<offset>	-4.99V~4.99V (50Ω)

Example **SOUR1:APPL:DC DEF,3.0,1.0**
 Sets the DC voltage to 1 volts (amplitude setting is ignored).

SOURce[1|2]:APPLy:HARMonic Source Specific Command

Description Outputs a sine wave with harmonic components from the selected channel when the command has executed. Frequency, amplitude and offset can also be set. The maximum frequency is limited by the highest order. Highest order n: maximum frequency is 30MHz/n or 20MHz/n for AFG-3021/3022).

Syntax **SOURce[1|2]:APPLy:HARMonic** [<frequency>
[,<amplitude> [,<offset>]]]

Parameter	<frequency>	1μHz~30MHz (20MHz AFG-3021/3022)
------------------	-------------	-------------------------------------

<amplitude>	1mV~10V (50Ω) (3.536 Vrms)
<offset>	-4.99V~4.99V (50Ω)

Example **SOUR1:APPL:HARM 2KHZ,MAX,MAX**
 Sets the frequency to 2kHz and sets the amplitude and offset to the maximum.

SOURce[1|2]:APPLY:USER Source Specific Command

Description Outputs an arbitrary waveform from the selected channel. The output is that specified from the FUNC:USER command.

Note Frequency and amplitude cannot be used with the DC function; however a value (or DEFault) must be specified. The values are remembered for the next function used.

Syntax **SOURce[1|2]:APPLY:USER [<frequency> [,<amplitude> [,<offset>]]]**

Parameter	<frequency>	1μHz~125MHz
	<amplitude>	0~10V (50Ω)
	<offset>	±5 Vpk ac +dc (50Ω)

Example **SOUR1:APPL:USER 1KHZ,5.0,1.0**

SOURCE[1 2 pulse]:APPLY?		Source Specific Command
Description	Outputs a string with the current settings.	
Note	The string can be passed back appended to the Apply Command.	
Syntax	SOURCE[1 2 pulse]:APPLY?	
Return Parameter	<string>	Function, frequency, amplitude, offset
Example	<p>SOURCE1:APPL?</p> <p>SIN +5.000000000000E+03,+3.0000E+00,-2.50E+00</p> <p>Returns a string with the current function and parameters, Sine, 5kHz, 3 Vpp, -2.5V offset.</p>	

Output Commands

Unlike the Apply commands, the Output commands are low level commands to program the function generator.

This section describes the low-level commands used to program the function generator. Although the APPLY command provides the most straightforward method to program the function generator, the low-level commands give you more flexibility to change individual parameters.

	Source Specific Command
	SOURce[1 2]:FUNCTion
Description	The FUNCTion command selects and outputs the selected output. The User parameter outputs an arbitrary waveform previously set by the SOURce[1 2]:FUNC:USER command.
Note	<p>If the function mode is changed and the current frequency setting is not supported by the new mode, the frequency setting will be altered to next highest value.</p> <p>V_{pp} and V_{rms} or dBm amplitude values may have different maximum values due to differences such as crest factor. For example, if a 5V_{rms} square wave is changed to a sinewave, then the V_{rms} is automatically adjusted to 3.536.</p> <p>The modulation, burst and sweep modes can only be used with some of the basic waveforms. If a mode is not supported, the conflicting mode will be disabled. See the table below.</p>

	Sine	Squ	Tria	Ramp	Pulse	Noise	ARB
AM	✓	✓	✓	✓	✓	×	✓
FM	✓	✓	✓	✓	×	×	×
PM	✓	✓	✓	✓	×	×	×
ASK	✓	×	×	×	×	×	×
FSK	✓	✓	✓	✓	✓	×	×
PSK	✓	×	×	×	×	×	×
SWEEP	✓	✓	✓	✓	×	×	×
BURST	✓	✓	✓	✓	×	×	×

Syntax **SOURce[1|2]:FUNCTION {SINusoid|SQUare|RAMP|PULSe|NOISe| USER|HARMonic}**

Example **SOUR1:FUNC SIN**
Sets the output as a sine function.

Query Syntax **SOURce[1|2]:FUNCTION?**

Return Parameter SIN, SQU, RAMP, PULS, NOIS, USER Returns the current output type.

Example **SOUR1:FUNC?**
ARB
Current output is sine.

SOURCE[1|2|pulse]:FREQUENCY Source Specific Command

Description Sets the output frequency for the the SOURce[1 | 2 | pulse] :FUNCTION command. The query command returns the current frequency setting.

Note The maximum and minimum frequency depends on the function mode.

Sine, Square	1μHz~200MHz/60MHz
Ramp	1μHz~1MHz
Pulse	1μHz~50MHz
Noise	Not applicable
User	1μHz~125MHz

If the function mode is changed and the current frequency setting is not supported by the new mode, the frequency setting will be altered to next highest value.

The duty cycle of square waveforms depends on the frequency settings.

0.01% to 99.99%

If the frequency is changed and the set duty cycle cannot support the new frequency, the highest duty cycle available at that frequency will be used. A “settings conflict” error will result from the above scenario.

Syntax	SOURCE[1 2 pulse]:FREQuency {<frequency> MINimum MAXimum}	
Example	SOURCE1:FREQ MAX Sets the frequency to the maximum for the current mode.	
Query Syntax	SOURCE[1 2 pulse]:FREQuency?	
Return Parameter	<NR3>	Returns the frequency for the current mode.
Example	SOURCE1:FREQ? MAX +5.0000000000000E+07+1.000000000000E+03 The maximum frequency that can be set for the current function is 50MHz.	

SOURCE[1 2 pulse]:AMPLitude	Source Specific Command
Description	The SOURce[1 2 pulse]:AMPLitude command sets the output amplitude for the selected channel. The query command returns the current amplitude settings.
Note	<p>The maximum and minimum amplitude depends on the output termination. The default amplitude for all functions is 100 mVpp (50Ω). If the amplitude has been set and the output termination is changed from 50Ω to high impedance, the amplitude will double. Changing the output termination from high impedance to 50Ω will half the amplitude.</p> <p>The offset and amplitude are related by the following equation.</p> $ V_{offset} < V_{max} - V_{pp}/2$ <p>If the output termination is set to high impedance, dBm units cannot be used. The units will default to Vpp.</p> <p>The output amplitude can be affected by the function and unit chosen. Vpp and Vrms or dBm values may have different maximum values due to differences such as crest factor. For example, a 5Vrms square wave must be adjusted to 3.536 Vrms for a sine wave.</p> <p>The amplitude units can be explicitly used each time the SOURce[1 2 pulse]:AMPLitude command is used. Alternatively, the VOLT:UNIT command can be used to set the amplitude units for all commands.</p>
Syntax	SOURCE[1 2 pulse]:AMPLitude {< amplitude> MINimum MAXimum}

Example **SOURCE1:AMP MAX**
 Sets the amplitude to the maximum for the current mode.

Query Syntax **SOURCE[1|2|pulse]:AMPlitude?
 {MINimum|MAXimum}**

Return Parameter <NR3> Returns the amplitude for the current mode.

Example **SOURCE1:AMP? MAX**
 +8.000E+00
 The maximum amplitude that can be set for the current function is 8 volts.

SOURCE[1|2|pulse]:DCOffset Source Specific Command

Description Sets or queries the DC offset for the current mode.

Note
 The offset parameter can be set to MINimum, MAXimum or DEFault. The default offset is 0 volts. The offset is limited by the output amplitude as shown below.

$$|V_{offset}| < V_{max} - V_{pp}/2$$

If the output specified is out of range, the maximum offset will be set.

The offset is also determined by the output termination (50Ω or high impedance). If the offset has been set and the output termination has changed from 50Ω to high impedance, the offset will double. Changing the output termination from high impedance to 50Ω will half the offset.

Syntax **SOURCE[1|2|pulse]:DCOffset {< offset>
 |MINimum|MAXimum}**

Example **SOURCE1:DCO MAX**

Sets the offset to the maximum for the current mode.

Query Syntax **SOURCE[1|2]pulse:DCOffset? {MINimum|MAXimum}**

Return Parameter **<NR3>** Returns the offset for the current mode.

Example **SOURCE1:DCO?**
 +1.00E+00
 The offset for the current mode is set to +1volts.

SOURCE[1|2]:SQUare:DCYcle Source Specific Command

Description Sets or queries the duty cycle for square waves only. The setting is remembered if the function mode is changed. The default duty cycle is 50%.

Note The duty cycle of square waveforms depend on the frequency settings.
 0.01% to 99.99%

If the frequency is changed and the set duty cycle cannot support the new frequency, the highest duty cycle available at that frequency will be used. A "settings conflict" error will result from the above scenario.

For square waveforms, the Apply command and AM/FM modulation modes ignore the duty cycle settings.

Syntax **SOURCE[1|2]:SQUare:DCYcle {< percent> |MINimum|MAXimum}**

Example **SOUR1:SQU:DCYC MAX**
 Sets the duty cycle to the highest possible for the current frequency.

Query Syntax **SOURCE[1|2]:SQUare:DCYcle? {MINimum|MAXimum}**

Return Parameter	<code><NR3></code>	Returns the duty cycle as a percentage.
------------------	--------------------------	---

Example **SOUR1:SQU:DCYC?**
 +9.90E+01
 The duty cycle is set 99%.

SOURce[1 2]:RAMP:SYMMetry	Source Specific Command
----------------------------------	----------------------------

Description	Sets or queries the symmetry for ramp waves only. The setting is remembered if the function mode is changed. The default symmetry is 50%.
-------------	---

Note	For ramp waveforms, the Apply command and AM/FM modulation modes ignore the current symmetry settings.
------	--

Syntax	SOURce[1 2]:RAMP:SYMMetry {< percent> MINimum MAXimum}
--------	--

Example	SOUR1:RAMP:SYMM +5.00E+01 Sets the symmetry to the 50%.
---------	---

Query Syntax	SOURce[1 2]:RAMP:SYMMetry? {MINimum MAXimum}
--------------	---

Return Parameter	<code><NR3></code>	Returns the symmetry as a percentage.
------------------	--------------------------	---------------------------------------

Example	SOUR1:RAMP:SYMMetry? +5.00E+01 Sets the symmetry to the 50%.
---------	---

OUTPut	Source Specific Command
---------------	----------------------------

Description	Enables/Disables or queries the front panel output. The default is set to off.
-------------	--

Note	If the output is overloaded by an external voltage, the output will turn off and an error message will
------	--

be displayed. The overload must first be removed before the output can be turned on again with output command.

Using the Apply command automatically sets the front panel output to on.

Syntax	OUTPut[1 2 pulse] {OFF ON}
Example	OUTP1 ON Turns the output on.
Query Syntax	OUTPut[1 2 pulse]?
Return Parameter	1 ON 0 OFF
Example	OUTP1? 1 The channel 1 output is currently on.

OUTPUT[1|2|pulse]:LOAD Source Specific Command

Description Sets or queries the output termination. Two impedance settings can be chosen, DEFault (50Ω) and INFinity (high impedance >10 kΩ).
The output termination is to be used as a reference only. If the output termination is set 50Ω but the actual load impedance is not 50Ω, then the amplitude and offset will not be correct.

Note If the amplitude has been set and the output termination is changed from 50Ω to high impedance, the amplitude will double. Changing the output termination from high impedance to 50Ω will half the amplitude.
If the output termination is set to high impedance, dBm units cannot be used. The units will default to Vpp.

Syntax **OUTPUT[1|2|pulse]:LOAD {DEFault|INFinity}**

Example	OUTPUT1:LOAD DEF Sets the output termination to 50Ω.
Query Syntax	OUTPUT[1 2 PULSE]:LOAD?
Return Parameter	DEF Default INF INFinity
Example	OUTPUT1:LOAD? DEF The output is set to the default of 50Ω.

SOURCE[1|2]:VOLTage:UNIT Source Specific Command

Description	Sets or queries the output amplitude units. There are three types of units: VPP, VRMS and DBM.
Note	The units set with the VOLTage:UNIT command will be used as the default unit for all amplitude units unless a different unit is specifically used for a command. If the output termination is set to high impedance, dBm units cannot be used. The Units will automatically default to Vpp.
Syntax	SOURCE1:VOLTage:UNIT {VPP VRMS DBM}
Example	SOURCE1:VOLT:UNIT VPP Sets the amplitude units to Vpp.
Query Syntax	SOURCE1:VOLTage:UNIT?
Return Parameter	VPP Vpp VRMS Vrms DBM dBm
Example	SOURCE1:VOLT:UNIT? VPP

The amplitude units are set to Vpp.

OUTPUTPULSE:VOLTage:UNIT		Source Specific Command
Description	Sets or queries the output amplitude units. There are three types of units: VPP, VRMS and DBM.	
Note	<p>The units set with the VOLTage:UNIT command will be used as the default unit for all amplitude units unless a different unit is specifically used for a command.</p> <p>If the output termination is set to high impedance, dBm units cannot be used. The Units will automatically default to Vpp.</p>	
Syntax	OUTPUTPULSE:VOLTage:UNIT {VPP VRMS DBM}	
Example	<p>OUTPUTPULSE:VOLT:UNIT VPP</p> <p>Sets the amplitude units to Vpp.</p>	
Query Syntax	OUTPUTPULSE:VOLTage:UNIT?	
Return Parameter	VPP	Vpp
	VRMS	Vrms
	DBM	dBm
Example	<p>OUTPUTPULSE:VOLT:UNIT?</p> <p>VPP</p> <p>The amplitude units are set to Vpp.</p>	

Pulse Configuration Commands

The pulse chapter is used to control and output pulse waveforms. Unlike the APPLY command, low level control is possible including setting the leading edge time, trailing edge time, period and pulse width.

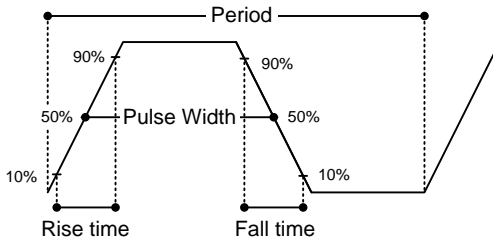

		Source Specific Command
<hr/>		
SOURCEPULSE:PULSE:WIDTH		
Description	Sets or queries the pulse width. The default pulse width is 50us. Pulse width is defined as the time from the rising to falling edges (at a threshold of 50%).	
Note	The pulse width is restricted to the following limitations: Pulse Width ≥ Minimum Pulse Width Pulse Width < Pulse Period - Minimum Pulse Width	
Syntax	SOURCEPULSE:PULSE:WIDTH {<seconds> MINimum MAXimum}	
Example	SOURCEPULSE:PULS:WIDT MAX Sets the pulse width to the maximum allowed.	
Query Syntax	SOURCEPULSE:PULSE:WIDTH? [MINimum MAXimum]	
Return Parameter	<seconds>	≥ 20 ns (limited by the current frequency setting)

Example **SOURCEPULSE:PULS:WIDT?**
 +2.000000000000E-08

The pulse width is set to 20 nanoseconds.

SOURCEPULSE:PULSe:DCYCLE **Source Specific Command**

Description Sets or queries the pulse duty cycle.

Note The duty cycle is restricted to the following limitations:
 Pulse Duty Cycle $\geq 100 \times$ Minimum Pulse Width \div Pulse Period
 Pulse Duty Cycle $< 100 \times (1 - \text{Minimum Pulse Width} \div \text{Pulse Period})$

Syntax **SOURCEPULSE:PULSe:DCYCLe{<percent>|MINimum|MAXimum}**

Example **SOURCEPULSE:PULS:DCYC MAX**
 Sets the duty to the maximum allowed.

Query Syntax **SOURCEPULSE:PULSe:DCYCLe?**
 [MINimum|MAXimum]

Return Parameter **<NR3>** 0.01%–99.99% (limited by the current frequency setting)

Example **SOURCEPULSE: PULS:DCYC?**
 +1.0000E+01
 The duty cycle is set to 10%

SOURCEPULSE:PULSe:TRANsition :LEADing **Source Specific Command**

Description Sets or queries the pulse leading edge time. The default rise time is 10ns. The leading and trailing edge time can be different.

Note The leading edge time is limited by the pulse

	width as noted below: Leading/Trailing Edge Time $\leq 0.625 \times$ Pulse Width
Syntax	SOURCEPULSE:PULSE:TRANSition:LEADing {<seconds> MINimum MAXimum}
Example	SOURCEPULSE:PULS:TRANSition:LEADing MAX Sets the pulse transition trailing to the maximum allowed.
Query Syntax	SOURCEPULSE:PULSE:TRANSition:LEADing? [MINimum MAXimum]
Return Parameter	<seconds> \cong 10ns (limited by the current frequency and pulse width settings)
Example	SOURCEPULSE:PULS:TRANSition:LEADing? +8.0000E-08 The pulse transition trailing is set to 80 nanoseconds.

SOURCEPULSE:PULSE:TRANSition:TRAILing Source Specific Command

Description	Sets or queries the pulse trailing edge time. The default rise time is 10ns. The leading and trailing edge time can be different.
Note	The trailing edge time is limited by the pulse width as noted below: Leading/Trailing Edge Time $\leq 0.625 \times$ Pulse Width
Syntax	SOURCEPULSE:PULSE:TRANSition:TRAILing {<seconds> MINimum MAXimum}
Example	SOURCEPULSE:PULS:TRANSition:TRAILing MAX Sets the pulse transition trailing to the maximum allowed.

Query Syntax	SOURCEPULSE:PULSe:TRANSition:TRAILing? [MINimum MAXimum]	
Return Parameter	<seconds>	≥ 10ns (limited by the current frequency and pulse width settings)
Example	SOURCEPULSE:PULS:TRANSition:TRAILing? +8.0000E-08 The pulse transition trailing is set to 80 nanoseconds.	

Harmonic Commands

SOURce[1 2]:HARMonic:TOTAL		Source Specific Command
Description	Sets the highest order harmonic for the harmonic output. By default this is set to 2.	
Syntax	SOURce[1 2]:HARMonic:TOTAL{<id> MINimum MAXimum}	
Example	SOUR1:HARMonic:TOTAL MAX Sets the highest order harmonic to the maximum allowed.	
Query Syntax	SOURce[1 2]:HARMonic:TOTAL? [MINimum MAXimum]	
Return Parameter	<NR1>	2 ~ 8
Example	SOUR1:HARM:? MIN 2 Returns the minimum harmonic.	
SOURce[1 2]:HARMonic:TYPE		Source Specific Command
Description	Specifies which harmonics are output; odd, even, all or user specified.	

Syntax	SOURce[1 2]:HARMonic:TYPE {EVEN ODD ALL USER,10000001}	
Parameter/ Return Parameter	<EVEN>	Output all even orders
	<ODD>	Output all odd orders
	<ALL>	Output all orders, subject to the number specified in “SOURce[1 2]:HARMonic:TOTAL” command.
	<USER, X ¹ X ² X ³ X ⁴ X ⁵ X ⁶ X ⁷ X ⁸ >	Outputs only the specified orders, where X = Boolean (0, 1) X ^X = order number.

Example **SOURce1:HARMonic:TYPE USER,11000001**
 Outputs only the 2nd and 8th harmonic. (1st harmonic is the fundamental frequency)

Query Syntax **SOURce[1|2]:HARMonic:TYPE?**

Example **SOUR1:HARM:TYPE?**
 EVEN 11000000
 Returns EVEN harmonic (Limited to the 2nd harmonic).

SOURce[1|2]:HARMonic:ORDER Source Specific Command

Description Sets or queries the amplitude and phase of each order. By default, each order is set to 3Vpp, with a phase of 0°.

Syntax **SOURce[1|2]:HARMonic:ORDER {<id>,<amplitude>,<phase>}**

Parameter/ Return Parameter	<id>	<NR1> Order number: 2 ~8
	<amplitude>	<NR3> Amplitude of the selected order: 1mV ~ 10V (50ohm impedance)

	<phase>	<NR3> Phase: -360 ~ -360°
Example	SOURce1:HARMonic:ORDER 2,3,0,180	Sets the 2 nd harmonic to 3.0Vpp and a phase of 180°.
Query Syntax	SOURce[1 2]:HARMonic:ORDER? <id>	Returns the <id>,<amplitude>,<phase>.
Example	SOUR1:HARM:ORDE? 2	
	2;,3.000E+00,1.800E+02	Returns the 2 nd harmonic settings as 3Vpp with a phase of 180°.

SOURce[1|2]:HARMonic:DISPlay Source Specific Command

Description	Sets or queries whether the screen shows the harmonics in the frequency or time domain. The default setting is time domain.	
Syntax	SOURce[1 2]:HARMonic:DISPlay {FREQuency TIME}	
Parameter/ Return Parameter	FREQuency	Sets the display to frequency
	TIME	Sets the display to time
Example	SOURce1:HARMonic:DISPlay TIME	Sets the display to TIME.
Query Syntax	SOURce[1 2]:HARMonic:DISPlay?	Returns TIME or FREQ.
Example	SOUR1:HARM:DISP?	
	TIME	Returns the display format as TIME.

Amplitude Modulation (AM) Commands

AM Overview

To successfully create an AM waveform, the following commands must be executed in order.

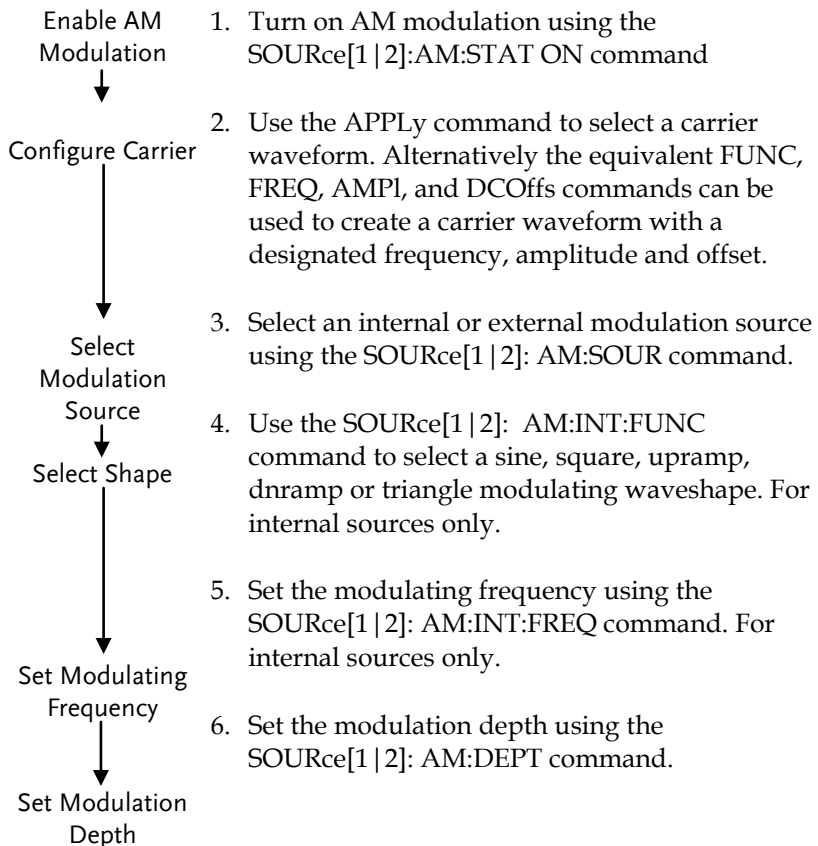

SOURce[1 2]:AM:STATe		Source Specific Command
Description	Sets or disables AM modulation. By default AM modulation is disabled. AM modulation must be enabled before setting other parameters.	
Note	Burst or sweep mode will be disabled if AM modulation is enabled. As only one modulation is allowed at any one time, other modulation modes will be disabled when AM modulation is enabled.	
Syntax	SOURce[1 2]:AM:STATe {OFF ON}	
Example	SOUR1:AM:STAT ON Enables AM modulation.	
Query Syntax	SOURce[1 2]:AM:STATe?	
Return Parameter	0	Disabled (OFF)
	1	Enabled (ON)
Example	SOUR1:AM:STAT? 1 AM modulation mode is currently enabled.	

SOURce[1 2]:AM:SOURce		Source Specific Command
Description	Sets or queries the modulation source as internal or external. Internal is the default modulation source.	
Note	If an external modulation source is selected, modulation depth is limited to $\pm 5V$ from the MOD INPUT terminal on the rear panel. For example, if modulation depth is set to 100%, then the maximum amplitude is +5V, and the minimum amplitude is -5V.	
Syntax	SOURce[1 2]:AM:SOURce {INTernal EXTernal}	
Example	SOUR1:AM:SOUR EXT	

Sets the modulation source to external.

Query Syntax	SOURce[1 2]:AM:SOURce?		
Return Parameter	INT		Internal
	EXT		External
Example	SOUR1:AM:SOUR? INT The modulation source is set to internal.		

SOURce[1 2]:AM:INTernal:FUNctIon	Source Specific Command
---	-------------------------

Description	Sets the shape of the modulating waveform from sine, square, triangle, upramp and dn ramp. The default shape is sine.
-------------	---

Note	Square and triangle waveforms have a 50% duty cycle. Upramp and dn ramp have a symmetry of 100% and 0%, respectively.
------	---

Syntax	SOURce[1 2]:AM:INTernal:FUNctIon {SINusoid SQUare TRIangle UPRamp DNRamp}
--------	--

Example	SOUR1:AM:INT:FUNC SIN Sets the AM modulating wave shape to sine.
---------	--

Query Syntax	SOURce[1 2]:AM:INTernal:FUNctIon?		
--------------	--	--	--

Return Parameter	SIN	Sine	UPRAMP	Upramp
	SQU	Square	DNRAMP	Dn ramp
	TRI	Triangle		

Example	SOUR1:AM:INT:FUNC? SIN The shape for the modulating waveform is Sine.		
---------	---	--	--

SOURce[1 2]:AM:INTernal:FREQuency		Source Specific Command
Description	Sets the frequency of the internal modulating waveform only. The default frequency is 100Hz.	
Syntax	SOURce[1 2]:AM:INTernal:FREQuency {<frequency> MINimum MAXimum}	
Parameter	<frequency>	2 mHz~ 50 kHz
Example	SOUR1:AM:INT:FREQ +1.0000E+02 Sets the modulating frequency to 100Hz.	
Query Syntax	SOURce[1 2]:AM:INTernal:FREQuency? [MINimum MAXimum]	
Return Parameter	<NR3>	Returns the frequency in Hz.
Example	SOUR1:AM:INT:FREQ? +1.0000000E+02 Returns the frequency to 100Hz.	

SOURce[1 2]:AM:DEPTh		Source Specific Command
Description	Sets or queries the modulation depth for internal sources only. The default is 100%.	
Note	The function generator will not output more than $\pm 5V$, regardless of the modulation depth. The modulation depth of an external source is controlled using the $\pm 5V$ MOD INPUT terminal on the rear panel, and not the SOURce[1 2]:AM:DEPTh command.	
Syntax	SOURce[1 2]:AM:DEPTh {<depth in percent> MINimum MAXimum}	
Parameter	<depth in percent>	0~120%
Example	SOUR1:AM:DEPT 50 Sets the modulation depth to 50%.	

Query Syntax	SOURce[1 2]:AM:DEPT? [MINimum MAXimum]
--------------	---

Return Parameter	<NR3>	Return the modulation depth as a percentage.
------------------	-------	--

Example	SOUR1:AM:DEPT? +5.0000E+01 The modulation depth is 50%.
---------	---

Amplitude Shift Keying (ASK) Commands

ASK Overview

The following is an overview of the steps required to generate an ASK modulated waveform.

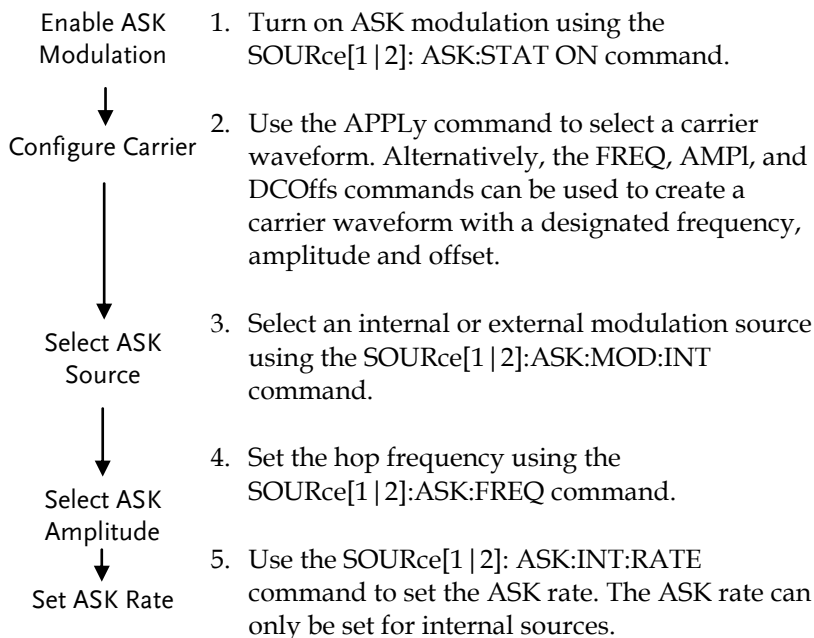

<code>SOURce[1 2]:ASKey:STATe</code>	Source Specific Command
Description	Turn on or off the ASK modulation function of the specified channel. Query the on/off status of the ASK modulation function of the specified channel.
Note	Burst or sweep mode will be disabled if ASK modulation is enabled. As only one modulation is allowed at any one time, other modulation modes will be disabled when ASK modulation is enabled.

Syntax	SOUR[1 2]:ASK:STATe {OFF ON}	
Example	SOURce1 2:ASK:STAT ON Enables ASK modulation.	
Query Syntax	SOURce[1 2]:ASK:STATe?	
Return Parameter	0	Disabled (OFF)
	1	Enabled (ON)
Example	SOURce1:ASK:STAT? 1 ASK modulation mode is currently enabled.	

SOURce[1|2]:ASKey:SOURce Source Specific Command

Description	Sets or queries the ASK source as internal or external. Internal is the default source.	
Note	External ASK source can not be supported.	
Syntax	SOURce[1 2]:ASKey:SOURce {INTernal EXTernal}	
Example	SOURce1 2:ASK:SOUR EXT Sets the ASK source to external.	
Query Syntax	SOURce[1 2]:ASKey:SOURce?	
Return Parameter	INT	Internal
	EXT	External
Example	SOURce1:ASK:SOUR? EXT The ASK source is set to external.	

SOURce[1|2]:ASK:AMPlitude Source Specific Command

Description	Sets the ASK amplitude. The default modulation amplitude is set to 0.5V.	
-------------	--	--

Note	For ASK, the modulating waveform is a square wave with a duty cycle of 50%.
Syntax	SOURce[1 2]:ASKey:AMPlitude {<voltage> MINimum MAXimum}
Parameter	<amplitude> 0V~max
Example	SOURce1:ASK:AMPlitude 0.5V Sets the ASK amplitude to 0.5V.
Query Syntax	SOURce[1 2]:ASKey: AMPlitude? [MINimum MAXimum]
Return Parameter	<NR3> Returns the depth.
Example	SOURce1:ASK:AMPlitude? 5.000E-01 Returns depth to 0.5V.

SOURce[1|2]:ASKey:INTernal RATE Source Specific Command

Description	Sets or queries the ASK rate for internal sources only.
Note	External sources will ignore this command.
Syntax	SOURce[1 2]:ASKey:INTernal:RATE {<rate in Hz> MINimum MAXimum}
Parameter	<rate in Hz> 2 mHz~1MHz
Example	SOURce1:ASK:INT:RATE MAX Sets the rate to the maximum (1MHz).
Query Syntax	SOURce[1 2]:ASKey:INTernal:RATE? [MINimum MAXimum]
Return Parameter	<NR3> Returns the ASK rate in Hz.
Example	SOURce1:ASK:INT:RATE? +1.0000E+06 Returns the maximum ASK rate allowed.

Frequency Modulation (FM) Commands

FM Overview

The following is an overview of the steps required to generate an FM waveform.

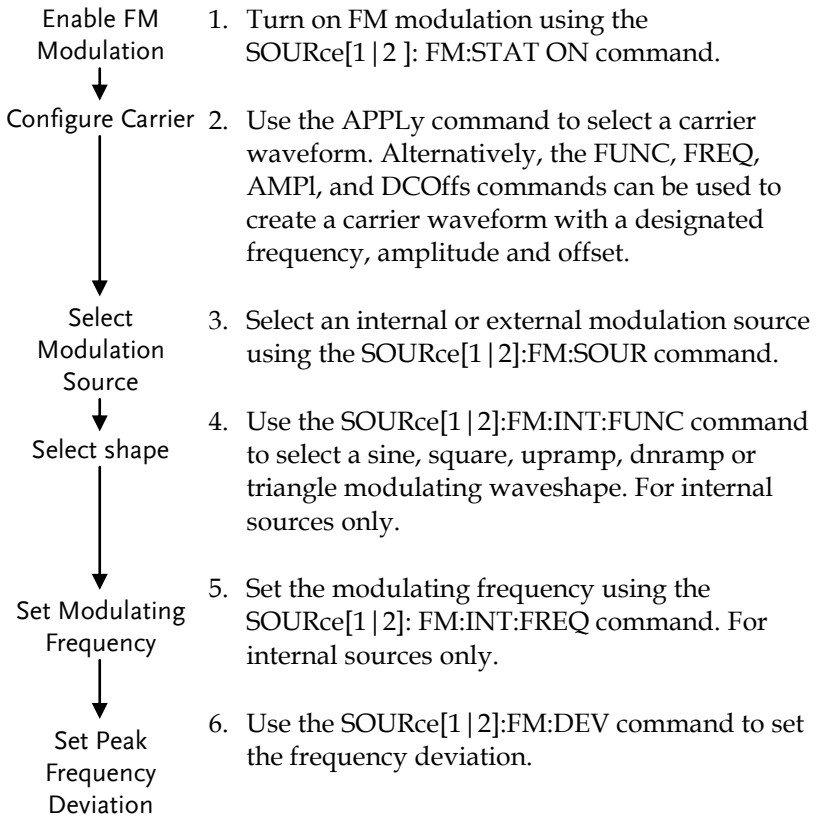

SOURce[1 2]:FM:STATe		Source Specific Command
Description	Sets or disables FM modulation. By default FM modulation is disabled. FM modulation must be enabled before setting other parameters.	
Note	Burst or sweep mode will be disabled if FM modulation is enabled. As only one modulation is allowed at any one time, other modulation modes will be disabled when FM modulation is enabled.	
Syntax	SOUR[1 2]:FM:STATe {OFF ON}	
Example	SOUR1:FM:STAT ON Enables FM modulation.	
Query Syntax	SOURce[1 2]:FM:STATe?	
Return Parameter	0	Disabled (OFF)
	1	Enabled (ON)
Example	SOUR1:FM:STAT? 1 FM modulation mode is currently enabled.	

SOURce[1 2]:FM:SOURce		Source Specific Command
Description	Sets or queries the modulation source as internal or external. Internal is the default modulation source.	
Note	If an external modulation source is selected, modulation depth is limited to $\pm 5V$ from the MOD INPUT terminal on the rear panel. For example, if modulation depth is set to 100%, then the maximum amplitude is +5V, and the minimum amplitude is -5V.	
Syntax	SOURce[1 2]:FM:SOURce {INTernal EXTernal}	

Example	SOUR1:FM:SOUR EXT Sets the modulation source to external.				
Query Syntax	SOURce[1 2]:FM:SOURce?				
Return Parameter	<table border="1"> <tr> <td>INT</td> <td>Internal</td> </tr> <tr> <td>EXT</td> <td>External</td> </tr> </table>	INT	Internal	EXT	External
INT	Internal				
EXT	External				
Example	SOUR1:FM:SOUR? INT The modulation source is set to internal.				

SOURce[1|2]:FM:INTernal:FUNCtion Source Specific Command

Description	Sets the shape of the modulating waveform from sine, square, triangle, upramp and dn ramp. The default shape is sine.			
Note	Square and triangle waveforms have a 50% duty cycle. Upramp and dn ramp have a symmetry of 100% and 0%, respectively.			
Syntax	SOURce[1 2]:FM:INTernal:FUNCtion {SINusoid SQUare TRIangle UPRamp DNRamp}			
Example	SOUR1:FM:INT:FUNC SIN Sets the FM modulating wave shape to sine.			
Query Syntax	SOURce[1 2]:FM:INTernal:FUNCtion?			
Return Parameter	SIN	Sine	UPRAMP	Upramp
	SQU	Square	DNRAMP	Dn ramp
	TRI	Triangle		
Example	SOUR1:FM:INT:FUNC? SIN The shape for the modulating waveform is Sine.			

SOURce[1 2]:FM:INTernal:FREQUENCY		Source Specific Command
Description	Sets the frequency of the internal modulating waveform only. The default frequency is 10Hz.	
Syntax	SOURce[1 2]:FM:INTernal:FREQUENCY {<frequency> MINimum MAXimum}	
Parameter	<frequency>	2 mHz~ 50 kHz
Example	SOUR1:FM:INT:FREQ 100 Sets the modulating frequency to 100Hz.	
Query Syntax	SOURce[1 2]:FM:INTernal:FREQUENCY? [MINimum MAXimum]	
Return Parameter	<NR3>	Returns the frequency in Hz.
Example	SOUR1:FM:INT:FREQ? +1.0000E+02 Returns the frequency to 100Hz.	
SOURce[1 2]:FM:DEVIation		Source Specific Command
Description	Sets or queries the peak frequency deviation of the modulating waveform from the carrier waveform. The default peak deviation is 100Hz. The frequency deviation of external sources is controlled using the ±5V MOD INPUT terminal on the rear panel. A positive signal (>0~+5V) will increase the deviation (up to the set frequency deviation), whilst a negative voltage will reduce the deviation.	
Note	The relationship of peak deviation to modulating frequency and carrier frequency is shown below. Peak deviation = modulating frequency – carrier frequency. The carrier frequency must be greater than or	

equal to the peak deviation frequency. The sum of the deviation and carrier frequency must not exceed the maximum frequency for a specific carrier shape. If an out of range deviation is set for any of the above conditions, the deviation will be automatically adjusted to the maximum value allowed and an “out of range” error will be generated.

For square wave carrier waveforms, the deviation may cause the duty cycle frequency boundary to be exceeded. In these conditions the duty cycle will be adjusted to the maximum allowed and a “settings conflict” error will be generated.

Syntax	SOURce[1 2]:FM:DEVIation {<peak deviation in Hz> MINimum MAXimum}	
Parameter	<peak deviation in Hz>	DC to Max Frequency
Example	SOUR1:FM:DEV MAX Sets the frequency deviation to the maximum value allowed.	
Query Syntax	SOURce[1 2]:FM:DEVIation? [MINimum MAXimum]	
Return Parameter	<NR3>	Returns the frequency deviation in Hz.
Example	SOURce[1 2]:FM:DEVIation? MAX +1.0000E+01 Returns the maximum frequency deviation allowed.	

Frequency-Shift Keying (FSK) Commands

FSK Overview

The following is an overview of the steps required to generate an FSK modulated waveform.

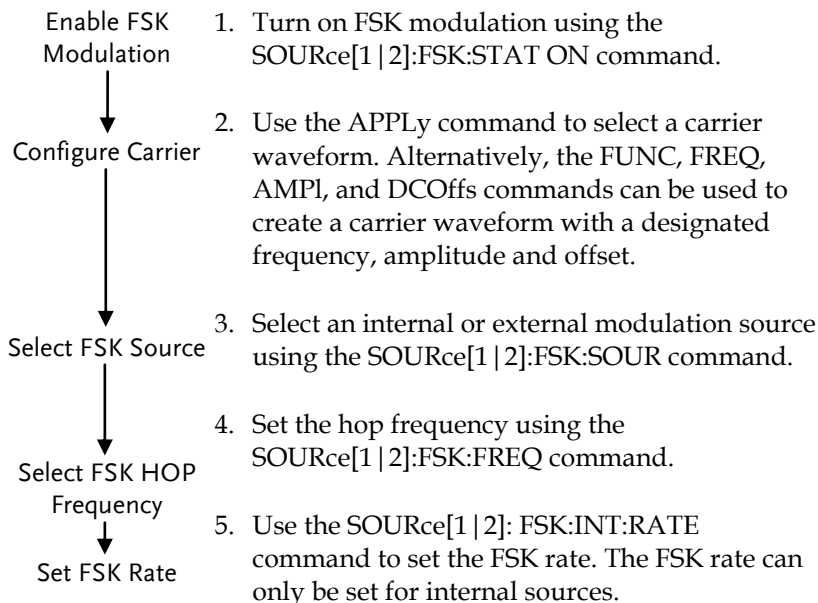

	Source Specific Command
SOURce[1 2]:FSKey:STATe	
Description	Turns FSK Modulation on or off. By default FSK modulation is off.
Note	Burst or sweep mode will be disabled if FSK modulation is enabled. As only one modulation is allowed at any one time, other modulation modes will be disabled when FSK modulation is enabled.
Syntax	SOURce[1 2]:FSKey:STATe {OFF ON}
Example	SOUR1:FSK:STAT ON

Enables FSK modulation

Query Syntax	SOURce[1 2]:FSKey:STATe?	
Return Parameter	0	Disabled (OFF)
	1	Enabled (ON)

Example **SOUR1:FSK:STAT?**
1
 FSK modulation is currently enabled.

SOURce[1|2]:FSKey:SOURce Source Specific Command

Description Sets or queries the FSK source as internal or external. Internal is the default source.

Note If an external FSK source is selected, FSK rate is controlled by the Trigger INPUT terminal on the rear panel.

Syntax **SOURce[1|2]:FSKey:SOURce {INTernal|EXTernal}**

Example **SOUR1:FSK:SOUR INT**
 Sets the FSK source to internal.

Query Syntax **SOURce[1|2]:FSKey:SOURce?**

Return Parameter	INT	Internal
	EXT	External

Example **SOUR1:FSK:SOUR?**
INT
 The FSK source is set to internal.

SOURce[1|2]:FSKey:FREQuency Source Specific Command

Description Sets the FSK hop frequency. The default hop frequency is set to 100Hz.

Note For FSK, the modulating waveform is a square wave with a duty cycle of 50%.

Syntax	SOURce[1 2]:FSKey:FREQuency {<frequency> MINimum MAXimum}	
Parameter	<frequency>	1 μHz to Max Frequency
Example	SOUR1:FSK:FREQ +1.0000E+02 Sets the FSK hop frequency to to 100Hz.	
Query Syntax	SOURce[1 2]:FSKey:FREQuency? [MINimum MAXimum]	
Return Parameter	<NR3>	Returns the frequency in Hz.
Example	SOUR1:FSK:FREQ? +1.000000000000E+02 Returns the frequency to 100Hz.	

SOURce[1 2]:FSKey:INTernal:RATE		Source Specific Command
Description	Sets or queries the FSK rate for internal sources only.	
Note	External sources will ignore this command.	
Syntax	SOURce[1 2]:FSKey:INTernal:RATE {<rate in Hz> [MINimum MAXimum]	
Parameter	<rate in Hz>	2 mHz~1 MHz
Example	SOUR1:FSK:INT:RATE MAX Sets the rate to the maximum (1MHz).	
Query Syntax	SOURce[1 2]:FSKey:INTernal:RATE? [MINimum MAXimum]	
Return Parameter	<NR3>	Returns the FSK rate in Hz.
Example	SOUR1:FSK:INT:RATE? MAX +1.000000000E+05 Returns the maximum FSK rate allowed.	

Phase Modulation (PM) Commands

PM Overview

The following is an overview of the steps required to generate a PM modulated waveform.

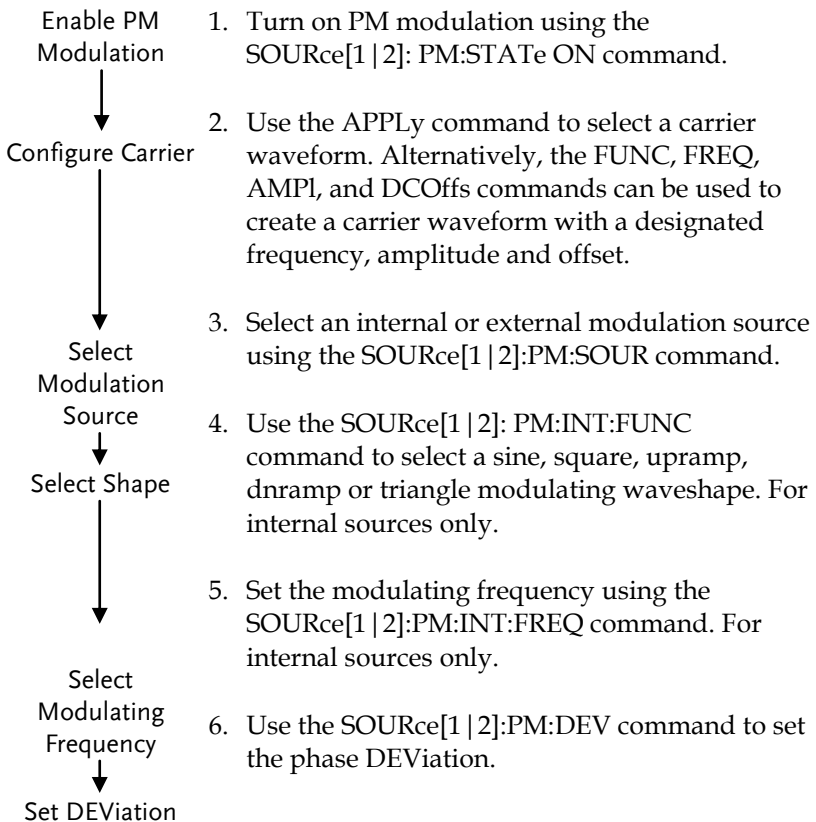

SOURce[1 2]:PM:STATe		Source Specific Command
Description	Turns PM Modulation on or off. By default PM modulation is off.	
Note	Burst or sweep mode will be disabled if PM modulation is enabled. As only one modulation is allowed at any one time, other modulation modes will be disabled when PM modulation is enabled.	
Syntax	SOURce[1 2]:PM:STATe {OFF ON}	
Example	SOUR1:PM:STAT ON Enables PM modulation	
Query Syntax	SOURce[1 2]:PM:STATe?	
Return Parameter	0	Disabled (OFF)
	1	Enabled (ON)
Example	SOUR1:PM:STAT? 1 PM modulation is currently enabled.	
SOURce[1 2]:PM:SOURce		Source Specific Command
Description	Sets or queries the PM source as internal or external. Internal is the default source.	
Note	If an external PM source is selected, the phase modulation is controlled by the MOD INPUT terminal on the rear panel.	
Syntax	SOURce[1 2]:PM:SOURce {INTernal EXTernal}	
Example	SOUR1:PM:SOUR INT Sets the PM source to internal.	
Query Syntax	SOURce[1 2]:PM:SOURce?	

Return Parameter	INT	Internal
	EXT	External

Example **SOUR1:PM:SOUR?**
INT
 The PM source is set to internal.

SOURce[1|2]:PM:INTernal:FUNction Source Specific Command

Description Sets the shape of the modulating waveform from sine, square, triangle, upramp and dn ramp. The default shape is sine.

Note Square and triangle waveforms have a 50% duty cycle. Upramp and dn ramp have a symmetry to 100% and 0%, respectively. .

Syntax **SOURce[1|2]:PM:INTernal:FUNction**
{SINusoid|SQUare|TRIangle|UPRamp|DNRamp}

Example **SOUR1:PM:INT:FUN SIN**
 Sets the PM modulating wave shape to sine. .

Query Syntax **SOURce[1|2]:PM:INTernal:FUNction?**

Return Parameter	SIN	Sine	UPRAMP	Upramp
	SQU	Square	DNRAMP	Dn ramp
	TRI	Triangle		

Example **SOUR1:PM:INT:FUNC?**
SIN
 The shape for the modulating waveform is Sine.

SOURce[1|2]:PM:INTernal:FREQuency Source Specific Command

Description Sets the modulating waveform frequency for internal sources. The default frequency is set to 50kHz.

Syntax	SOURce[1 2]:PM:INTernal:FREQUency {<frequency> MINimum MAXimum}	
Parameter	<frequency>	2 mHz~ 50 kHz
Example	SOUR1:PM:INT:FREQ MAX Sets the frequency to the maximum value.	
Query Syntax	SOURce[1 2]:PM:INTernal:FREQUency?	
Return Parameter	<NR3>	Returns the frequency in Hz.
Example	SOUR1:PM:INT:FREQ? +2.0000000E+04 Returns the modulating frequency. (50kHz)	

SOURce[1|2]:PM:DEVIation Source Specific Command

Description	Sets or queries the phase deviation of the modulating waveform from the carrier waveform. The default phase deviation is 180°.	
Note	For external sources, the phase deviation is controlled by the ±5V MOD Input terminal on the rear panel. If the phase deviation is set to 180 degrees, then +5V represents a deviation of 180 degrees. A lower input voltage will decrease the set phase deviation.	
Syntax	SOURce[1 2]:PM:DEVIation {< phase> minimum maximum}	
Parameter	<percent>	0°~360°
Example	SOUR1:PM:DEVIation +3.0000E+01 Sets the deviation to 30°.	
Query Syntax	SOURce[1 2]:PM:DEVIation?	
Return Parameter	<NR3>	Returns the deviation .
Example	SOUR1:PM:DEVIation? +3.0000E+01 The current deviation is 30°.	

Phase Shift Keying (PSK) Commands

PSK Overview

The following is an overview of the steps required to generate an PSK modulated waveform.

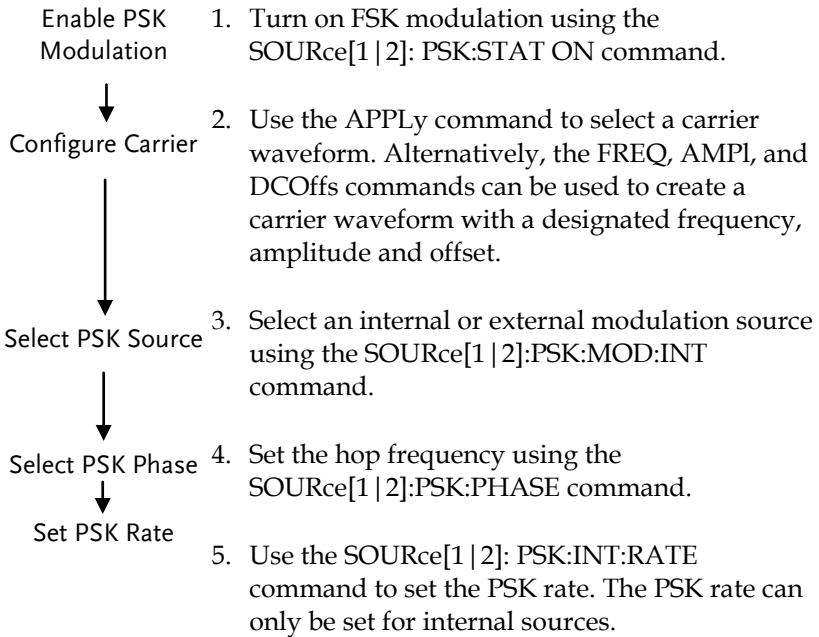

<code>SOURce[1 2]:PSKey:STATe</code>	Source Specific Command
--	-------------------------

Description	Turns PSK Modulation on or off. By default PSK modulation is off.
-------------	---

Note	Burst or sweep mode will be disabled if PSK modulation is enabled. As only one modulation is allowed at any one time, other modulation modes will be disabled when PSK modulation is enabled.
------	---

Syntax	SOURce[1 2]:PSKey:STATe {OFF ON}	
Example	SOURce1 2:PSK:STAT ON Enables PSK modulation	
Query Syntax	SOURce[1 2]:PSKey:STATe?	
Return Parameter	0	Disabled (OFF)
	1	Enabled (ON)
Example	SOURce1:PSK:STAT? ON PSK modulation is currently enabled.	

SOURce[1|2]:PSKey:SOURce Source Specific Command

Description	Sets or queries the PSK source as internal or external. Internal is the default source.	
Note	If an external PSK source is selected, PSK rate is controlled by the Trigger INPUT terminal on the rear panel.	
Syntax	SOURce[1 2]:PSKey:SOURce {INTernal EXTernal}	
Example	SOUR1:PSK:SOUR EXT Sets the PSK source to external.	
Query Syntax	SOURce[1 2]:PSKey:SOURce?	
Return Parameter	INT	Internal
	EXT	External
Example	SOURce1:PSK:SOUR? INT The PSK source is set to internal.	

SOURce[1|2]:PSKey:PHASE Source Specific Command

Description	Sets the PSK hop frequency. The default hop frequency is set to 180°.	
-------------	---	--

Note	For PSK, the modulating waveform is a square wave with a duty cycle of 50%.	
Syntax	SOURce[1 2]:PSKey:PHASE {<phase> MINimum MAXimum}	
Parameter	<phase>	0~360°.
Example	SOUR1:PSK:PHASE 180 Sets the PSK hop deviation to to 180°.	
Query Syntax	SOURce[1 2]:PSKey:PHASE? [MINimum MAXimum]	
Return Parameter	<percent>	0~360°.
Example	SOUR1:PSK:PHASE? MAX 360° Returns the maximum hop deviation allowed.	

SOURce[1|2]:PSKey:INTernal RATE Source Specific Command

Description	Sets or queries the PSK rate for internal sources only.	
Note	External sources will ignore this command.	
Syntax	SOURce[1 2]:PSKey:INTernal:RATE {<rate in Hz> MINimum MAXimum}	
Parameter	<rate in Hz>	2 mHz~1MHz
Example	SOURce1:PSK:INT:RATE MAX Sets the rate to the maximum (1MHz).	
Query Syntax	SOURce[1 2]:PSKey:INTernal:RATE? [MINimum MAXimum]	
Return Parameter	<NR3>	Returns the PSK rate in Hz.
Example	SOURce1:PSK:INT:RATE? MAX +1.0000E+06 Returns the maximum PSK rate allowed.	

SUM Modulation (SUM) Commands

SUM Overview

The following is an overview of the steps required to generate a SUM modulated waveform.

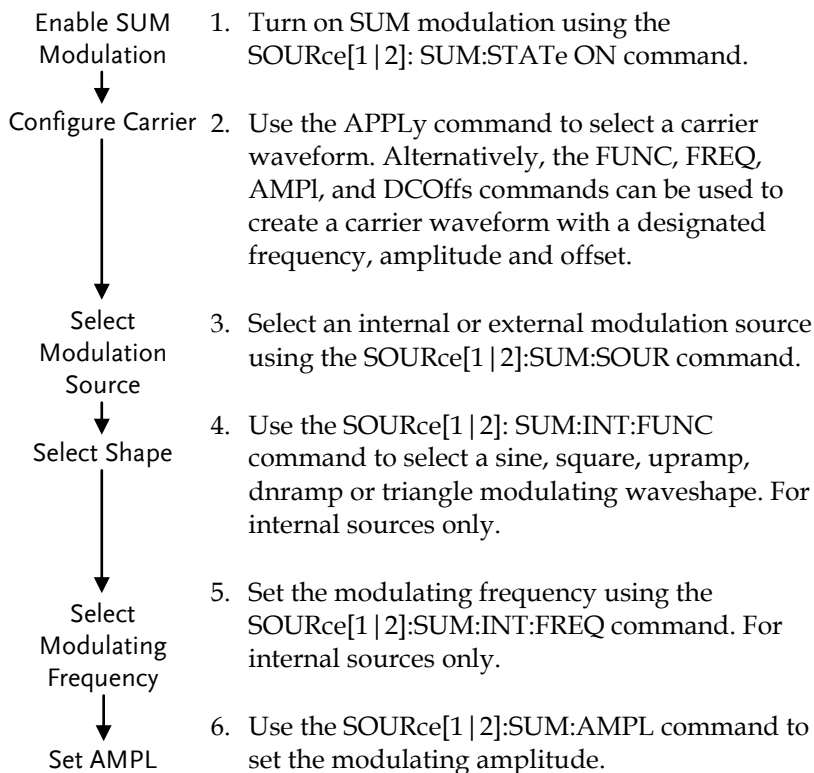

SOURce[1 2]:SUM:STATe		Source Specific Command
Description	Turns SUM Modulation on or off. By default SUM modulation is off.	
Note	Burst or sweep mode will be disabled if SUM modulation is enabled. As only one modulation is allowed at any one time, other modulation modes will be disabled when SUM modulation is enabled.	
Syntax	SOURce[1 2]:SUM:STATe {OFF ON}	
Example	SOUR1:SUM:STAT ON Enables SUM modulation	
Query Syntax	SOURce[1 2]:SUM:STATe?	
Return Parameter	0	Disabled (OFF)
	1	Enabled (ON)
Example	SOUR1:SUM:STAT? 1 SUM modulation is currently enabled.	
SOURce[1 2]:SUM:SOURce		Source Specific Command
Description	Sets or queries the SUM source as internal or external. Internal is the default source.	
Note	If an external SUM source is selected, the duty cycle/pulse width is controlled by the MOD INPUT terminal on the rear panel.	
Syntax	SOURce[1 2]:SUM:SOURce {INTernal EXTernal}	
Example	SOUR1:SUM:SOUR INT Sets the SUM source to internal.	
Query Syntax	SOURce[1 2]:SUM:SOURce?	

Return Parameter	INT	Internal
	EXT	External

Example **SOUR1:SUM:SOUR?**
INT
 The SUM source is set to internal.

SOURce[1|2]:SUM:INTernal:FUNction Source Specific Command

Description Sets the shape of the modulating waveform from sine, square, triangle, upramp and dn ramp. The default shape is sine.

Note Square and triangle waveforms have a 50% duty cycle. Upramp and dn ramp have a symmetry to 100% and 0%, respectively.

Syntax **SOURce[1|2]:SUM:INTernal:FUNction**
{SINusoid|SQUare|TRIangle|UPRamp|DNRamp}

Example **SOUR1:SUM:INT:FUN SIN**
 Sets the SUM modulating wave shape to sine.

Query Syntax **SOURce[1|2]:SUM:INTernal:FUNction?**

Return Parameter	SIN	Sine	UPRAMP	Upramp
	SQU	Square	DNRAMP	Dn ramp
	TRI	Triangle		

Example **SOUR1:SUM:INT:FUNC?**
SIN
 The shape for the modulating waveform is Sine.

SOURce[1|2]:SUM:INTernal:FREQuency Source Specific Command

Description Sets the modulating waveform frequency for internal sources. The default frequency is set to 50kHz.

Syntax	SOURce[1 2]:SUM:INTernal:FREQuency {<frequency> MINimum MAXimum}	
Parameter	<frequency>	2 mHz~ 50 kHz
Example	SOUR1:SUM:INT:FREQ MAX Sets the frequency to the maximum value.	
Query Syntax	SOURce[1 2]:SUM:INTernal:FREQuency?	
Return Parameter	<NR3>	Returns the frequency in Hz.
Example	SOUR1:SUM:INT:FREQ? +2.000000E+04 Returns the modulating frequency (50kHz).	

SOURce[1|2]:SUM:AMPL Source Specific Command

Description	Sets or queries the amplitude of the modulating waveform from the carrier waveform. The default phase amplitude is 100%.	
Note	If an external SUM source is selected, the amplitude of the modulated waveform is controlled using the ±5V MOD INPUT terminal on the rear panel. A positive signal (>0~+5V) will increase the AMPLitude (up to the set amplitude), whilst a negative voltage will reduce the amplitude.	
Syntax	SOURce[1 2]:SUM:AMPL{< percent> minimum maximum}	
Parameter	<percent>	0%~100%
Example	SOUR1:SUM:AMPLitude +3.0000E+01 Sets the amplitude to 30%.	
Query Syntax	SOURce[1 2]:SUM:AMPLitude?	
Return Parameter	<NR3>	Returns the amplitude .

Example

SOUR1:SUM:AMPLitude?**+3.000E+01**

The current amplitude is 30%.

Pulse Width Modulation (PWM) Commands

PWM Overview

The following is an overview of the steps required to generate a PWM modulated waveform.

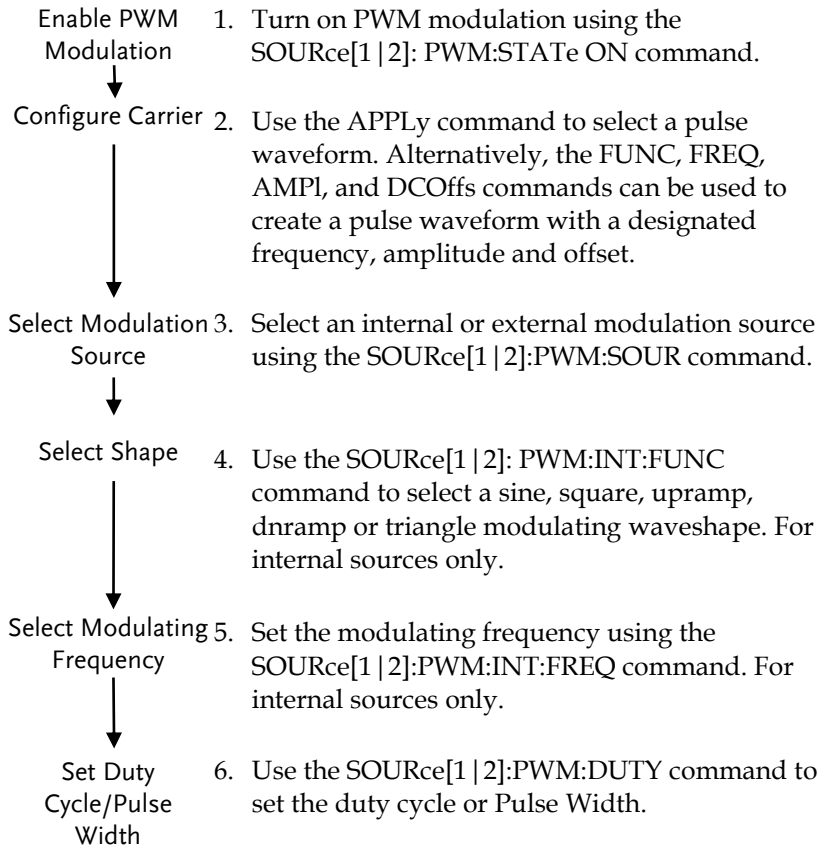

SOURce[1 2]:PWM:STATE	Source Specific Command
------------------------------	-------------------------

Description	Turns pulse width modulation on or off. By default
-------------	--

PWM is off.

Note Burst or sweep mode will be disabled if PWM modulation is enabled. As only one modulation is allowed at any one time, other modulation modes will be disabled when PWM modulation is enabled.

Syntax **SOURce[1|2]:PWM:STATe {OFF|ON}**

Example **SOUR1:PWM:STAT ON**
Enables PWM modulation

Query Syntax **SOURce[1|2]:PWM:STATe?**

Return Parameter	0	Disabled (OFF)
	1	Enabled (ON)

Example **SOUR1:PWM:STAT?**
ON
PWM modulation is currently enabled.

SOURce[1|2]:PWM:SOURce Source Specific Command

Description Sets or queries the PWM source as internal or external. Internal is the default source.

Note If an external PWM source is selected, the duty cycle/pulse width is controlled by the MOD INPUT terminal on the rear panel.

Syntax **SOURce[1|2]:PWM:SOURce {INTERNAL|EXTERNAL}**

Example **SOUR1:PWM:SOUR EXT**
Sets the PWM source to external.

Query Syntax **SOURce[1|2]:PWM:SOURce?**

Return Parameter	INT	Internal
	EXT	External

Example **SOUR1:PWM:SOUR? INT**
The PWM source is set to internal.

SOURce[1 2]:PWM:INTernal:FUNction		Source Specific Command												
<hr/>														
Description	Sets the shape of the modulating waveform from sine, square, triangle, upramp and dn ramp. The default shape is sine.													
Note	Square and triangle waveforms have a 50% duty cycle. Upramp and dn ramp have a symmetry to 100% and 0%, respectively. Carrier must be a pulse or PWM waveform.													
Syntax	SOURce[1 2]:PWM:INTernal:FUNction {SINusoid SQUare TRIangle UPRamp DNRamp}													
Example	SOUR1:PWM:INT:FUN SIN Sets the PWM modulating wave shape to sine.													
Query Syntax	SOURce[1 2]:PWM:INTernal:FUNction?													
Return Parameter	<table border="0" style="width: 100%;"> <tr> <td>SIN</td> <td>Sine</td> <td>UPRAMP</td> <td>Upramp</td> </tr> <tr> <td>SQU</td> <td>Square</td> <td>DNRAMP</td> <td>Dn ramp</td> </tr> <tr> <td>TRI</td> <td></td> <td>Triangle</td> <td></td> </tr> </table>		SIN	Sine	UPRAMP	Upramp	SQU	Square	DNRAMP	Dn ramp	TRI		Triangle	
SIN	Sine	UPRAMP	Upramp											
SQU	Square	DNRAMP	Dn ramp											
TRI		Triangle												
Example	SOUR1:PWM:INT:FUNC? SIN The shape for the modulating waveform is Sine.													

SOURce[1 2]:PWM:INTernal:FREQuency		Source Specific Command
<hr/>		
Description	Sets the modulating waveform frequency for internal sources. The default frequency is set to 10Hz.	
Syntax	SOURce[1 2]:PWM:INTernal:FREQuency {<frequency> MINimum MAXimum}	
Parameter	<frequency> 2 mHz~ 50 kHz	
Example	SOUR1:PWM:INT:FREQ MAX Sets the frequency to the maximum value.	

Query Syntax	SOURce[1 2]:PWM:INTernal:FREQuency?	
Return Parameter	<NR3>	Returns the frequency in Hz.
Example	SOUR1:PWM:INT:FREQ? MAX +2.0000E+04 Returns the modulating frequency. (50kHz)	

SOURce[1 2]:PWM:DUTY	Source Specific Command
-----------------------------	-------------------------

Description	Sets or queries the duty cycle deviation. The default duty cycle is 50%.	
Note	<p>The duty cycle is limited by period, edge time and minimum pulse width.</p> <p>The duty cycle deviation of an external source is controlled using the $\pm 5V$ MOD INPUT terminal on the rear panel. A positive signal ($>0\sim+5V$) will increase the deviation (up to the set duty cycle deviation), whilst a negative voltage will reduce the deviation.</p>	
Syntax	SOURce[1 2]:PWM:DUTY {< percent> minimum maximum}	
Parameter	<percent>	0%~100% (limited, see above)
Example	SOUR1:PWM:DUTY +3.0000E+01 Sets the duty cycle to 30%.	
Query Syntax	SOURce[1 2]:PWM:DUTY?	
Return Parameter	<NR3>	Returns the deviation in %.
Example	SOUR1:PWM:DUTY? +3.0000E+01 The current duty cycle is 30%.	

Frequency Sweep Commands

Sweep Overview

Below shows the order in which commands must be executed to perform a sweep.

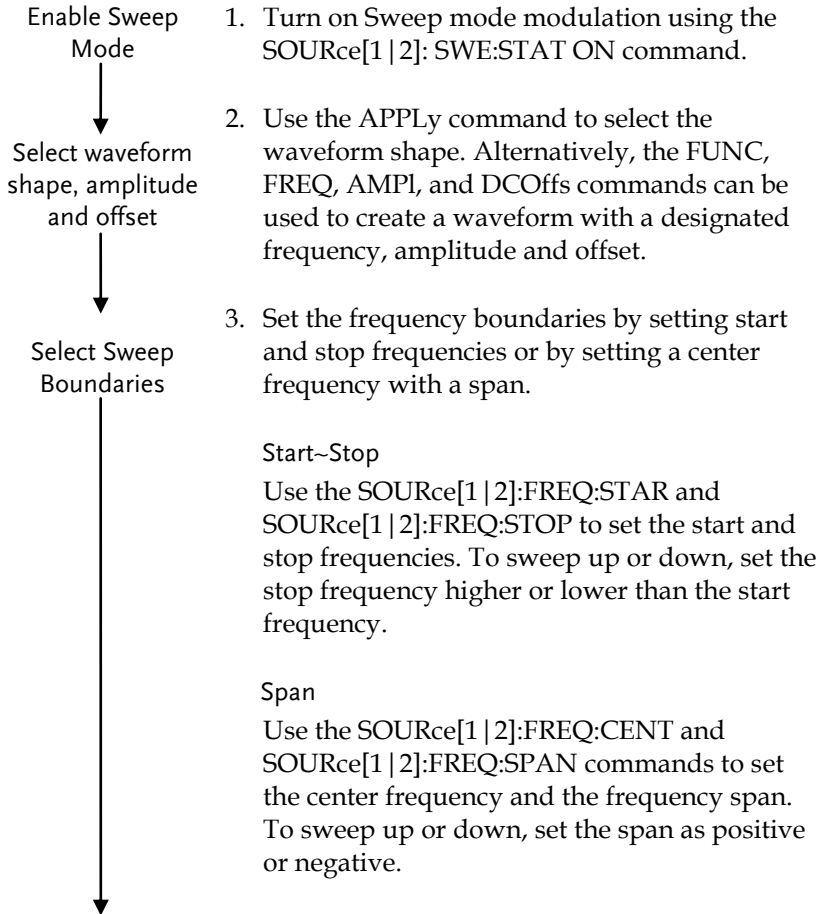

- | | |
|--------------------------------------|--|
| Select Sweep Mode | 4. Choose Linear or Logarithmic spacing using the <code>SOURce[1 2]:SWE:SPAC</code> command. |
| Select Sweep Time
↓ | 5. Choose the sweep time using the <code>SOURce[1 2]:SWE:TIME</code> command. |
| Select the sweep trigger source
↓ | 6. Select an internal or external sweep trigger source using the <code>SOURce[1 2]:SOUR</code> command. |
| Select the marker frequency | 7. To output a marker frequency from the trigger out, use The <code>SOURce[1 2]:MARK:FREQ</code> command. To enable marker frequency output, use the <code>SOURce[1 2]:MARK ON</code> command. |

The marker frequency can be set to a value within the sweep span.

<code>SOURce[1 2]:SWEep:STATe</code>		Source Specific Command
Description	Sets or disables Sweep mode. By default Sweep is disabled. Sweep modulation must be enabled before setting other parameters.	
Note	Any modulation modes or Burst mode will be disabled if sweep mode is enabled.	
Syntax	<code>SOURce[1 2]:SWEep:STATe {OFF ON}</code>	
Example	<code>SOUR1:SWE:STAT ON</code> Enables sweep mode.	
Query Syntax	<code>SOURce[1 2]:SWEep:STATe?</code>	
Return Parameter	0	Disabled (OFF)
	1	Enabled (ON)
Example	<code>SOUR1:SWE:STAT?</code> 1	

Sweep mode is currently enabled.

SOURce[1 2]:FREQuency:STARt		Source Specific Command
Description	Sets the start frequency of the sweep. 100Hz is the default start frequency.	
Note	To sweep up or down, set the stop frequency higher or lower than the start frequency.	
Syntax	SOURce[1 2]:FREQuency:STARt {<frequency> MINimum MAXimum}	
Parameter	<frequency>	1uHz to Max Frequency
Example	SOUR1:FREQ:STAR +2.0000E+03 Sets the start frequency to 2kHz.	
Query Syntax	SOURce[1 2]:FREQuency:STARt? [MINimum MAXimum]	
Return Parameter	<NR3>	Returns the start frequency in Hz.
Example	SOUR1:FREQ:STAR? +2.000000000000E+03 Returns the maximum start frequency allowed.	

SOURce[1 2]:FREQuency:STOP		Source Specific Command
Description	Sets the stop frequency of the sweep. 1 kHz is the default start frequency.	
Note	To sweep up or down, set the stop frequency higher or lower than the start frequency.	
Syntax	SOURce[1 2]:FREQuency:STOP {<frequency> MINimum MAXimum}	
Parameter	<frequency>	1uHz to Max Frequency
Example	SOUR1:FREQ:STOP +2.0000E+03	

Sets the stop frequency to 2kHz.

Query Syntax	SOURce[1 2]:FREQuency:STOP? [MINimum MAXimum]	
Return Parameter	<NR3>	Returns the stop frequency in Hz.
Example	SOUR1:FREQ:STOP? MAX +2.0000000000000E+03 Returns the maximum stop frequency allowed.	

SOURce[1|2]:FREQuency:CENTer Source Specific Command

Description	Sets and queries the center frequency of the sweep. 550 Hz is the default center frequency.	
Note	The maximum center frequency depends on the sweep span and maximum frequency: $max\ center\ freq = max\ freq - span/2$	
Syntax	SOURce[1 2]:FREQuency:CENTer {<frequency> MINimum MAXimum}	
Parameter	<frequency>	1uHz~ Max Frequency 1uHz~ 5MHz (Ramp)
Example	SOUR1:FREQ:CENT +2.0000E+03 Sets the center frequency to 2kHz.	
Query Syntax	SOURce[1 2]:FREQuency:CENTer? [MINimum MAXimum]	
Return Parameter	<NR3>	Returns the stop frequency in Hz.
Example	SOUR1:FREQ:CENT? +2.0000000000000E+03 Returns the maximum center frequency allowed, depending on the span.	

SOURce[1 2]:FREQuency:SPAN		Source Specific Command
Description	Sets and queries the frequency span of the sweep. 900 Hz is the default frequency span. The span frequency is equal to the stop-start frequencies.	
Note	<p>To sweep up or down, set the span as positive or negative.</p> <p>The maximum span frequency has a relationship to the center frequency and maximum frequency: $\text{max freq span} = 2(\text{max freq} - \text{center freq})$</p>	
Syntax	SOURce[1 2]:FREQuency:SPAN {<frequency> MINimum MAXimum}	
Parameter	<frequency>	1 μHz ~ Max Frequency 1 μHz~ 1MHz (Ramp)
Example	SOUR1:FREQ:SPAN +2.0000E+03 Sets the frequency span to 2kHz.	
Query Syntax	SOURce[1 2]:FREQuency:SPAN? [MINimum MAXimum]	
Return Parameter	<NR3>	Returns the frequency span in Hz.
Example	SOUR1:FREQ:SPAN? +2.0000000000000E+03 Returns the frequency span for the current sweep.	
SOURce[1 2]:SWEep:SPACing		Source Specific Command
Description	Sets linear or logarithmic sweep spacing. The default spacing is linear.	
Syntax	SOURce[1 2]:SWEep:SPACing {LINear LOGarithmic}	
Example	SOUR1:SWE:SPAC LIN Sets the spacing to linear.	

Query Syntax	SOURce[1 2]:SWEep:SPACing?	
Return Parameter	LIN	Linear spacing
	LOG	Logarithmic spacing

Example **SOUR1:SWE:SPAC?**
LIN
The spacing is currently set as linear.

SOURce[1|2]:SWEep:TIME Source Specific Command

Description Sets or queries the sweep time. The default sweep time is 1 second.

Note The function generator automatically determines the number of frequency points that are used for the sweep based on the sweep time.

Syntax **SOURce[1|2]:SWEep:TIME**
{<seconds>|MINimum|MAXimum}

Parameter <seconds> 1 ms ~ 500 s

Example **SOUR1:SWE:TIME +1.0000E+00**
Sets the sweep time to 1 second.

Query Syntax **SOURce[1|2]:SWEep:TIME? {<seconds>|**
MINimum|MAXimum}

Return Parameter <NR3> Returns sweep time in seconds.

Example **SOUR1:SWE:TIME?**
+1.00000E+00
Returns the sweep time (1 seconds).

SOURce[1 2]:SWEep:SOURce		Source Specific Command
Description	Sets or queries the trigger source as immediate (internal), external or manual. IMMEDIATE will constantly output a swept waveform. EXTERNAL will output a swept waveform after each external trigger pulse. Manual will output a swept waveform after the trigger softkey is pressed.	
Note	<p>If the APPLY command was used to create the waveform shape, the source is automatically set to IMMEDIATE.</p> <p>The *OPC/*OPC? command/query can be used to signal the end of the sweep.</p> <p>If the trigger source is set to manual, the function generator starts sweeping each time a trigger command is received. To trigger the function generate from remote interface, it is necessary to send a * TRG trigger command.</p>	
Syntax	SOURce[1 2]: SWEep:SOURce {IMMEDIATE EXTERNAL MANUAL}	
Example	SOUR1: SWE:SOUR INT Sets the sweep source to internal.	
Query Syntax	SOURce[1 2]: SWEep:SOURce?	
Return Parameter	IMM	Immediate
	EXT	External
	MANual	Manual
Example	SOUR1:SWE:SOUR? IMM The sweep source is set to internal.	

OUTPut[1 2]:TRIGger:SLOPe		Source Specific Command
Description	Configures the trigger output signal (TTL) as a positive or negative slope. A positive slope will output a pulse with a rising edge and a negative slope will output a pulse with a falling edge.	
Note	The Trig out signal depends on the selected trigger source.	
	Trigger Source	Description
	Immediate	A square wave is output from the Trig out terminal with a 50% duty cycle at the start of every sweep.
	External	Trigger Output is disconnected.
	Manual	A pulse (>1 us) is output from the Trig out terminal at the start of each sweep.
Syntax	OUTPut[1 2]:TRIGger:SLOPe {POSitive NEGative}	
Example	OUTP1:TRIG:SLOP NEG Sets the Trig out signal as negative edge.	
Query Syntax	OUTPut[1 2]:TRIGger:SLOPe?	
Return Parameter	POS	Positive edge
	NEG	Negative edge
Example	OUTP1:TRIG:SLOP? NEG The Trig out signal is set to negative edge.	

OUTPut[1 2]:TRIGger		Source Specific Command
Description	Turns the trigger out signal on or off from the Trig out terminal on the rear panel. When set to on, a trigger signal (TTL) is output at the start of each pulse. The default is setting is off.	
Syntax	OUTPut[1 2]:TRIGger {OFF ON}	

Example	OUTP1:TRIG ON
	Enables the Trig out signal.
Query Syntax	OUTPut[1 2]:TRIGger?
Return Parameter	0 Disabled 1 Enable
Example	OUTP1:TRIG? 1 The Trig out signal is enabled.

	SOURce[1 2]:MARKer:FREQuency	Source Specific Command
<hr/>		
Description	Sets or queries the marker frequency. The default marker frequency is 500 Hz. The marker frequency is used to output a trigger out signal from the trigger terminal on the rear panel.	
Note	The marker frequency must be between the start and stop frequencies. If the marker frequency is set to a value that is out of the range, the marker frequency will be set to the center frequency and a "settings conflict" error will be generated.	
Syntax	SOURce[1 2]:MARKer:FREQuency {<frequency> MINimum MAXimum}	
Parameter	<frequency>	1 μHz ~ 25 MHz 1 μHz ~ 5 MHz (Ramp)
Example	SOUR1:MARK:FREQ +1.0000E+03 Sets the marker frequency to 1 kHz.	
Query Syntax	SOURce[1 2]:MARKer:FREQuency? [MINimum MAXimum]	
Return Parameter	<NR3>	Returns the marker frequency in Hz.
Example	SOUR1:MARK:FREQ? +1.0000000000000E+03	

Returns the marker frequency (1 kHz).

SOURce[1 2]:MARKer		Source Specific Command
Description	Turns the marker frequency on or off. The default is off.	
Note	MARKer ON	The SYNC signal goes logically high at the start of each sweep and goes low at the marker frequency.
	MARKer OFF	The SYNC terminal outputs a square wave with a 50% duty cycle at the start of each sweep.
Syntax	SOURce[1 2]:MARKer {OFF ON}	
Example	SOUR1:MARK ON	
	Enables the marker frequency.	
Query Syntax	SOURce[1 2]:MARKer?	
Return Parameter	0	Disabled
	1	Enabled
Example	SOUR1:MARK?	
	1	The marker frequency is enabled.

Burst Mode Commands

Burst Mode Overview

Burst mode can be configured to use an internal trigger (N Cycle mode) or an external trigger (Gate mode) using the Trigger INPUT terminal on the rear panel. Using N Cycle mode, each time the function generator receives a trigger, the function generator will output a specified number of waveform cycles (burst). After the burst, the function generator will wait for the next trigger before outputting another burst. N Cycle is the default Burst mode.

The alternative to using a specified number of cycles, Gate mode uses the external trigger to turn on or off the output. When the Trigger INPUT signal is high*, waveforms are continuously output (creating a burst). When the Trigger INPUT signal goes low*, the waveforms will stop being output after the last waveform completes its period. The voltage level of the output will remain equal to the starting phase of the burst waveforms, ready for the signal to go high* again.

*assuming the Trigger polarity is not inverted.

Only one burst mode can be used at any one time. The burst mode depends on the source of the trigger (internal, external, manual) and the source of the burst.

Burst Mode & Source	Function		
	N Cycle*	Cycle	Phase
Triggered – IMMEDIATE, BUS	Available	Available	Available
Triggered - EXTERNAL, MANUAL	Available	Unused	Available
Gated pulse - IMMEDIATE	Unused	Unused	Available

*burst count

The following is an overview of the steps required to generate a burst waveform.

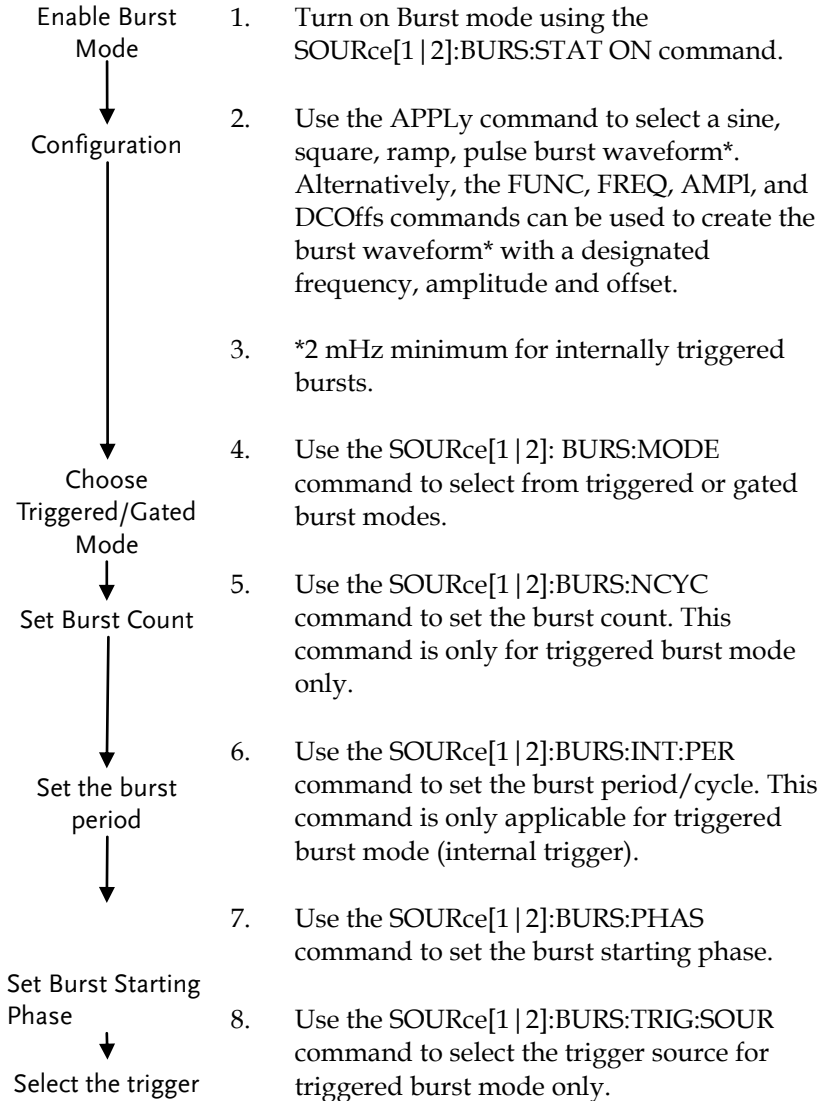

		Source Specific Command
SOURce[1 2]:BURSt:STATe		
Description	Turns burst mode on or off. By default burst mode is turned off.	
Note	When burst mode is turned on, sweep and any modulation modes are disabled.	
Syntax	SOURce[1 2]:BURSt:STATe {OFF ON}	
Example	SOUR1:BURS:STAT ON Turns burst mode on.	
Query Syntax	SOURce[1 2]:BURSt:STATe?	
Return Parameter	0	Disabled
	1	Enabled
Example	SOUR1:BURS:STAT? 0 Burst mode is off.	

		Source Specific Command
SOURce[1 2]:BURSt:MODE		
Description	Sets or queries the burst mode as gated or triggered. The default burst mode is triggered.	
Note	The burst count, period, trigger source and any manual trigger commands are ignored in gated burst mode.	
Syntax	SOURce[1 2]:BURSt:MODE {TRIGgered GATed}	
Example	SOUR1:BURS:MODE TRIG Sets the burst mode to triggered.	
Query Syntax	SOURce[1 2]:BURSt:MODE?	
Return Parameter	TRIG	Triggered mode
	GAT	Gated mode

Example **SOUR1:BURS:MODE?**
 TRIG

The current burst mode is triggered.

SOURce[1|2]:BURSt:NCYCles

Source Specific
 Command

Description Sets or queries the number of cycles (burst count) in triggered burst mode. The default number of cycles is 1. The burst count is ignored in gated mode.

Note If the trigger source is set to immediate, the product of the burst period and waveform frequency must be greater than the burst count:
 Burst Period X Waveform frequency > burst count
 If the burst count is too large, the burst period will automatically be increased and a “Settings conflict” error will be generated.
 Only sine and square waves are allowed infinite burst above 25 MHz.

Syntax **SOURce[1|2]:BURSt:NCYCles{< # cycles> |INFinity|MINimum |MAXimum}**

Parameter	<# cycles>	1~1,000,000 cycles.
	INFinity	Sets the number to continuous.
	MINimum	Sets the number to minimum allowed.
	MAXimum	Sets the number to maximum allowed.

Example **SOUR1:BURS:NCYCI INF**
 Sets the number of burst cycles to continuous (infinite).

Query Syntax **SOURce[1|2]:BURSt:NCYCles? [MINimum|MAXimum]**

Return Parameter	<NR3>	Returns the number of cycles.
	INF	INF is returned if the number of cycles is continuous.

Example	SOUR1:BURS:NCYC? +1.000000E+00 The burst cycles are set to 1.
	Source Specific Command
SOURce[1 2]:BURSt:INTernal:PERiod	
Description	Sets or queries the burst period. Burst period settings are only applicable when the trigger is set to immediate. The default burst period is 10 ms. During manual triggering, external triggering or Gate burst mode, the burst period settings are ignored.
Note	The burst period must be long enough to output the designated number of cycles for a selected frequency. Burst period > burst count / (waveform frequency + 200 ns) If the period is too short, it is automatically increased so that a burst can be continuously output. A "data out of range" error will also be generated.
Syntax	SOURce[1 2]:BURSt:INTernal:PERiod {<seconds> MINimum MAXimum}
Parameter	<seconds> 1 ms ~ 500 seconds
Example	SOUR1:BURS:INT:PER +1.0000E+01 Sets the period to 10 seconds.
Query Syntax	SOURce[1 2]:BURSt:INTernal:PERiod? [MINimum MAXimum]
Return Parameter	<NR3> Returns the burst period in seconds.
Example	SOUR1:BURS:INT:PER? +1.00000000E+01 The burst period is 10 seconds.

SOURce[1 2]:BURSt:PHASe		Source Specific Command
Description	<p>Sets or queries the starting phase for the burst. The default phase is 0 degrees. At 0 degrees, sine square and ramp waveforms are at 0 volts.</p> <p>In gated burst mode, waveforms are continuously output (burst) when the Trig signal is true. The voltage level at the starting phase is used to determine the voltage level of the signal in-between bursts.</p>	
Note	The phase command is not used with pulse waveforms.	
Syntax	SOURce[1 2]:BURSt:PHASe {<angle> MINimum MAXimum}	
Parameter	<angle>	-360 ~ 360 degrees
Example	SOUR1:BURSt:PHAS MAX Sets the phase to 360 degrees.	
Query Syntax	SOURce[1 2]:BURSt:PHASe? [MINimum MAXimum]	
Return Parameter	<NR3>	Returns the phase angle in degrees.
Example	SOUR1:BURSt:PHAS? +3.600E+02 The burst phase is 360 degrees.	
SOURce[1 2]:BURSt:TRIGger:SOURce		Source Specific Command
Description	<p>Sets or queries the trigger source for triggered burst mode. In triggered burst mode, a waveform burst is output each time a trigger signal is received and the number of cycles is determined by the burst count.</p> <p>There are three trigger sources for triggered burst mode:</p>	

	Immediate	A burst is output at a set frequency determined by the burst period.
	External	EXTernal will output a burst waveform after each external trigger pulse. Any additional trigger pulse signals before the end of the burst are ignored.
	Manual	Manual triggering will output a burst waveform after the trigger softkey is pressed.
Note	<p>If the APPLy command was used, the source is automatically set to IMMEDIATE.</p> <p>The *OPC/*OPC? command/query can be used to signal the end of the burst.</p> <p>If the trigger source is set to manual, the function generator outputs a burst count waveform with the specified number of cycles each time the trigger signal * TRG is received. The function generator stops and waits for the next trigger after the specified number of cycles has been output. You can configure the function generator to use an internal trigger to start a burst or send a trigger signal from the rear panel port connector by pressing the front panel key and you can also send a trigger command * TRG through the remote interface to provide an external trigger source.</p>	
Syntax	SOURce[1 2]:BURSt:TRIGger:SOURce {IMMEDIATE EXTernal MANual}	
Example	SOUR1:BURSt:TRIG:SOUR INT Sets the burst trigger source to internal.	
Query Syntax	SOURce[1 2]:BURSt:TRIGger:SOURce?	
Return Parameter	IMM	Immediate
	EXT	External
	MANual	Manual

Example **SOUR1:BURS:TRIG:SOUR?**
IMM
 The burst trigger source is set to immediate.

SOURce[1|2]:BURSt:TRIGger:DElay Source Specific Command

Description The DELay command is used to insert a delay (in seconds) before a burst is output. The delay starts after a trigger is received. The default delay is 0 seconds.

Syntax **SOURce[1|2]: BURSt:TRIGger:DElay**
{<seconds>|MINimum|MAXimum}

Parameter <seconds> 0~85 seconds

Example **SOUR1:BURS:TRIG:DEL +1.000E+01**
 Sets the trigger delay to 1 second.

Query Syntax **SOURce[1|2]:BURSt:TRIGger:DElay?**
[MINimum|MAXimum]

Return Parameter <Nrf> Delay in seconds

Example **SOUR1:BURS:TRIG:DEL ?**
+1.000E+01
 The trigger delay is 1 second.

SOURce[1|2]:BURSt:TRIGger:SLOPe Source Specific Command

Description Sets or queries the trigger edge for externally triggered bursts from the Trigger INPUT terminal on the rear panel. By default the trigger is rising edge (Positive).

Syntax **SOURce[1|2]:BURSt:TRIGger:SLOPe**
{POSitive|NEGative}

Parameter POSitive rising edge
 NEGative falling edge

Example **SOUR1:BURS:TRIG:SLOP NEG**
 Sets the trigger slope to negative.

Query Syntax **SOURce[1|2]:BURSt:TRIGger:SLOPe?**

Return Parameter	POS	rising edge
	NEG	falling edge

Example **SOUR1:BURS:TRIG:SLOP ?**
NEG
 The trigger slope is negative.

SOURce[1|2]:BURSt:GATE:POLarity Source Specific Command

Description In gated mode, the function generator will output a waveform continuously while the external trigger receives logically true signal from the Trigger INPUT terminal. Normally a signal is logically true when it is high. The logical level can be inverted so that a low signal is considered true.

Syntax **SOURce[1|2]:BURSt:GATE:POLarity**
{NORMal|INVertes}

Parameter	NORMal	Logically high
	INVertes	Logically low

Example **SOUR1:BURS:GATE:POL INV**
 Sets the state to logically low (inverted).

Query Syntax **SOURce[1|2]:BURSt:GATE:POLarity?**

Return Parameter	NORM	Normal(High) logical level
	INV	Inverted (low) logical level

Example **SOUR1:BURS:GATE:POL?**
INV
 The true state is inverted(logically low).

Source Specific

SOURce[1|2]:BURSt:OUTPut:TRIGger:SLOPe Command

Description Sets or queries the trigger edge of the trigger output signal. The signal is output from the trigger out terminal on the rear panel. The default trigger output slope is positive.

Note The trigger output signal on the rear panel depends on the burst trigger source or mode:

Immediate	50% duty cycle square wave is output at the start of each burst.
External	Trigger output disabled.
Gated mode	Trigger output disabled.
Manual	A >1 ms pulse is output at the start of each burst.

Syntax **SOURce[1|2]:BURSt:OUTPut:TRIGger:SLOPe {POSitive|NEGative}**

Parameter	POSitive	Rising edge.
	NEGative	Falling edge.

Example **SOUR1:BURSt:OUTPut:TRIG:SLOP POS**
Sets the trigger output signal slope to positive (rising edge).

Query Syntax **SOURce[1|2]:BURSt:OUTPut:TRIGger:SLOPe?**

Return Parameter	POS	Rising edge.
	NEG	Falling edge.

Example **SOUR1:BURSt:OUTPut:TRIG:SLOP?**
POS
The trigger output signal slope to positive.

		Source Specific Command
SOURce[1 2]:BURSt:OUTPut:TRIGger		
Description	Sets or queries the trigger output signal on or off. By default the signal is disabled. When enabled, a TTL compatible square wave is output. This function applies to sweep as well as burst mode.	
Syntax	SOURce[1 2]:BURSt:OUTPut:TRIGger {OFF ON}	
Parameter	OFF	Turns the output off.
	ON	Turns the output on.
Example	SOURce1:BURSt:OUTPut:TRIGger ON	
	Turns the output on.	
Query Syntax	SOURce[1 2]:BURSt:OUTPut:TRIGger?	
Return Parameter	0	Disabled
	1	Enabled
Query Example	SOURce1:BURSt:OUTPut:TRIG? 1	
	The trigger output is enabled.	

Arbitrary Waveform Commands

Arbitrary Waveform Overview

Use the steps below to output an arbitrary waveform over the remote interface.

- | | |
|---|---|
| <p>Output Arbitrary Waveform</p> <p>↓</p> <p>Select Waveform Frequency, amplitude and offset</p> <p>↓</p> <p>Load Waveform Data</p> <p>↓</p> <p>Set Waveform Rate</p> | <ol style="list-style-type: none"> 1. Use the SOURce[1 2]:FUNctIon USER command to output the arbitrary waveform currently selected in memory.
 2. Use the APPLy command to select frequency, amplitude and DC offset. Alternatively, the FUNC, FREQ, AMPL, and DCOffs commands can be used.
 3. Waveform data (1 to 16384 points per waveform) can be downloaded into volatile memory using the DATA:DAC command. Binary integer or decimal integer values in the range of ± 8191 can be used.
 4. The waveform rate is the product of the number of points in the waveform and the waveform frequency. |
|---|---|

$$\text{Rate} = \text{Hz} \times \# \text{ points}$$

Range:	Rate:	1μHz ~ 200MHz
	Frequency:	1μHz ~ 100MHz
	# points:	1~16384

SOURce[1 2]:FUNCTION USER		Source Specific Command
Description	Use the SOURce[1 2]:FUNCTION USER command to output the arbitrary waveform currently selected in memory. The waveform is output with the current frequency, amplitude and offset settings.	
Syntax	SOURce[1 2]:FUNCTION USER	
Example	SOUR1:FUNC USER Selects and outputs the current waveform in memory.	

DATA:DAC		Source Specific Command
Description	The DATA:DAC command is used to download binary or decimal integer values into memory using the IEEE-488.2 binary block format or as an ordered list of values.	
Note	<p>The integer values (± 8192) correspond to the maximum and minimum peak amplitudes of the waveform. For instance, for a waveform with an amplitude of 5V_{pp} (0 offset), the value 8192 is the equivalent of 2.5 Volts. If the integer values do not span the full output range, the peak amplitude will be limited.</p>	

The IEEE-488.2 binary block format is comprised of three parts:

# 7 2097152 	<ol style="list-style-type: none"> 1. Initialization character (#) 2. Digit length (in ASCII) of the number of bytes 3. Number of bytes
------------------------	--

IEEE 488.2 uses two bytes to represent waveform

data (14 bit integer). Therefore the number of bytes is always twice the number of data points.

Syntax	DATA:DAC VOLATILE, <start>, {<binary block> <value>, <value>, . . . }	
Parameter	<start>	Start address of the arbitrary waveform
	<binary block>	
	<value>	Decimal or integer values ±8192

Example **DATA:DAC VOLATILE, #216 Binary Data**

The command above downloads 5 data values (stored in 14 bytes) using the binary block format.

DATA:DAC VOLATILE,1000,511,1024,0,-1024,-511

Downloads the data values (511, 1024, 0, -1024, -511) to address 1000.

SOURce[1|2]:ARB:EDIT:COPY Source Specific Command

Description	Copies a segment of a waveform to a specific starting address.	
Syntax	SOURce[1 2]:ARB:EDIT:COPY [<start>[,<length>[,<paste>]]]	
Parameter	<start>	Start address: 0~16384
	<length>	0 ~ 16384
	<paste>	Paste address: 0~16384

Example **SOUR1:ARB:EDIT:COPY 1000, 256, 1257**

Copies 256 data values starting at address 1000 and copies them to address 1257.

SOURce[1 2]:ARB:EDIT:DELeTe		Source Specific Command
Description	Deletes a segment of a waveform from memory. The segment is defined by a starting address and length.	
Note	A waveform/ waveform segment cannot be deleted when output.	
Syntax	SOURce[1 2]:ARB:EDIT:DELeTe [<START>[,<LENGTh>]]	
Parameter	<START>	Start address: 0~16384
	<LENGTh>	0 ~ 16384
Example	SOURce1:ARB:EDIT:DEL 1000, 256 Deletes a section of 256 data points from the waveform starting at address 1000.	

SOURce[1 2]:ARB:EDIT:DELeTe:ALL		Source Specific Command
Description	Deletes all user-defined waveforms from non-volatile memory and the current waveform in volatile memory.	
Note	A waveform cannot be deleted when output.	
Syntax	SOURce[1 2]:ARB:EDIT:DELeTe:ALL	
Example	SOUR1:ARB:EDIT:DEL:ALL Deletes all user waveforms from memory.	

SOURce[1 2]:ARB:EDIT:POINt		Source Specific Command
Description	Edit a point on the arbitrary waveform.	
Note	A waveform/ waveform segment cannot be deleted when output.	
Syntax	SOURce[1 2]:ARB:EDIT:POINt [<address> [, <data>]]	
Parameter	<address>	Address of data point: 0~16384

	<code><data></code>	Value data: ± 8192
--	---------------------------	--------------------

Example **SOUR1:ARB:EDIT:POIN 1000, 511**

Creates a point on the arbitrary waveform at address 1000 with the highest amplitude.

SOURce[1 2]:ARB:EDIT:LINE	Source Specific Command
----------------------------------	-------------------------

Description Edit a line on the arbitrary waveform. The line is created with a starting address and data point and a finishing address and data point.

Note A waveform/waveform segment cannot be deleted when output.

Syntax **SOURce[1|2]:ARB:EDIT:LINE**
[<address1>,<data>,<address2>,<data2>]]]]

Parameter	<code><address1></code>	Address of data point1: 0~16384
	<code><data1></code>	Value data2: ±8192
	<code><address2></code>	Address of data point2: 0~16384
	<code><data2></code>	Value data2: ± 8192

Example **SOUR1:ARB:EDIT:LINE 40, 50, 100, 50**

Creates a line on the arbitrary waveform at 40,50 to 100,50.

SOURce[1 2]:ARB:EDIT:PROTECT	Source Specific Command
-------------------------------------	-------------------------

Description Protects a segment of the arbitrary waveform from deletion or editing.

Syntax **SOURce[1|2]:ARB:EDIT:PROTECT**
[<START>,<LENGTH>]

Parameter	<START>	Start address: 0~16384
	<LENGth>	0 ~ 16384

Example **SOUR1:ARB:EDIT:PROT 40, 50**
 Protects a segment of the waveform from address 40 for 50 data points.

SOURce[1|2]:ARB:EDIT:PROTect:ALL Source Specific Command

Description Protects the arbitrary waveform currently in non-volatile memory/currently being output.

Syntax **SOURce[1|2]:ARB:EDIT:PROTect:ALL**

Example **SOUR1:ARB:EDIT:PROT:ALL**

SOURce[1|2]:ARB:EDIT:UNProtect Source Specific Command

Description Uprotects the arbitrary waveform currently in non-volatile memory/currently being output.

Syntax **SOURce[1|2]:ARB:EDIT:UNProtect**

Example **SOUR1:ARB:EDIT:UNP**

SOURce[1|2]:ARB:OUTPut:MARKer Source Specific Command

Description Define a section of the arbitrary waveform for marker output. The marker is output from the trigger terminal on the rear panel.

Syntax **SOURce[1|2]:ARB:OUTPut:MARKer**
[<START>[,<LENGth>]]

Parameter <START> Start address*: 0~16384
 <LENGth> Length*: 0 ~ 16384

* Start + Length ≤ currently output arbitrary waveform

Example **SOUR1:ARB:OUTP:MARK 1000,1000**

The marker output is for a start address of 1000 with a length of 1000.

SOURce[1 2]:ARB:OUTPut		Source Specific Command
Description	Output the current arbitrary waveform in volatile memory. A specified start and length can also be designated.	
Syntax	SOURce[1 2]:ARB:OUTPut [<STARt>[,<LENGth>]]	
Parameter	<STARt>	Start address*: 0~16384
	<LENGth>	Length*: 0 ~ 16384
	* Start + Length ≤ currently output arbitrary waveform	
Example	SOUR1:ARB:OUTP 20,200 Outputs the current arbitrary waveform in memory.	

COUNTER Commands

The frequency counter function can be turned on remotely to control the frequency counter.

COUNTER:STATE		Instrument Command
Description	Turns the frequency counter function on or off.	
Syntax	COUNTER:STATE {ON OFF}	
Parameter/ Return Parameter	1	ON
	0	OFF
Example	COUNTER:STATE ON Turns the frequency counter on	
Query Syntax	COUNTER:STATE?	
Example	COUNTER:STATE? 1 Turns on the frequency counter.	

COUNTER:GATE		Instrument Command
Description	Sets the gate time for the frequency counter.	
Syntax	COUNTER:GATE {0.01 0.1 1 10}	
Return Parameter	0.01	Gate time of 0.01 seconds
	0.1	Gate time of 0.1 seconds
	1	Gate time of 1 seconds
	10	Gate time of 10 seconds
Example	COUNTER:GATE 1 Sets the gate time to 1s.	
Syntax	COUNTER:GATE? {max min}	

Example **COUNter:GATe?**
 +1.000E+00
 Returns the gate time: 1s.

COUNter:VALue? Instrument
Command

Description Returns the current value from the frequency
 counter.

Syntax COUNter:VALue?

Example **COUNter:VALue?**
 +5.00E+02
 Returns the frequency as 500Hz.

PHASE Commands

The phase command remotely controls the phase and channel synchronization.

SOURCE[1|2|pulse]:PHASe Instrument Command

Description Sets the phase.

Syntax **SOURCE[1|2|pulse]:PHASe {<phase>|<MIN>|<MAX>}**

Parameter	phase	-180~180
	min	Sets the phase to the minimum value.
	max	Sets the phase to the maximum value.

Example **SOURCE1:PHASe 25**
Sets the phase of channel 1 to 25°.

Query Syntax **SOURCE[1|2|pulse]:PHASe? {MAX|MIN}**

Return Parameter <NRf> Returns the current phase in degrees.

Example **SOURCE1:PHASe?**
+2.500E+01
Returns the phase of channel 1 as 25°.

SOURCE[1|2|pulse]:PHASe:SYNChronize Instrument Command

Description Synchronizes the phase of channel 1 and channel 2.

Syntax **SOURCE[1|2|pulse]:PHASe:SYNChronize**

Example SOURCE1:PHASe:SYNChronize
Synchronizes the phase of channel 1

COUPLE Commands

The Couple commands can be used to remotely set the frequency coupling and amplitude coupling.

SOURce[1|2]:FREQUENCY:COUPLE:MODE Instrument Command

Description Set the frequency coupling mode.

Syntax **SOURce[1|2]:FREQUENCY:COUPLE:MODE {Off|Offset|Ratio}**

Return/ Return parameter	Off	Disables frequency coupling.
	Offset	Set frequency coupling to offset mode.
	Ratio	Sets frequency coupling to ratio mode.

Example **SOURce1:FREQUENCY:COUPLE:MODE Offset**
Sets the frequency coupling mode to offset.

Query Syntax **SOURce[1|2]:FREQUENCY:COUPLE:MODE?**

Example **SOURce1:FREQUENCY:COUPLE:MODE?**
Off
Frequency coupling is turned off.

SOURce[1|2]:FREQUENCY:COUPLE:OFFSet Instrument Command

Description Sets the offset frequency when the frequency coupling mode is set to offset.

Syntax **SOURce[1|2]:FREQUENCY:COUPLE:OFFSet {frequency}**

Example **SOURce1:FREQUENCY:COUPLE:OFFSet 2kHz**
Sets the offset frequency to 2kHz (the frequency of CH2 minus CH1 is 2kHz).

Syntax **SOURce[1|2]:FREQUENCY:COUPLE:OFFSet?**

Example **SOURce1:FREQUENCY:COUPLE:OFFSet?**

+2.0000000000000E+03

The offset of channel 2 from channel 1 is 2kHz.

SOURce[1 2]:FREQUency:COUPlE:RATio		Instrument Command
Description	Sets the frequency coupling ratio when frequency coupling is set to ratio mode.	
Syntax	SOURce[1 2]:FREQUency:COUPlE:RATio {ratio}	
Example	SOURce1:FREQUency:COUPlE:RATio 2 Set the frequency ratio of CH2:CH1 as 2:1.	
Query Syntax	SOURce[1 2]:FREQUency:COUPlE:RATio?	
Example	SOURce1:FREQUency:COUPlE:RATio? +1.666000E+00 Returns the CH2 to CH1 frequency ratio as 2.	

SOURce[1 2]:AMPlitude:COUPlE:STATe		Instrument Command
Description	Enables or disables the amplitude coupling.	
Syntax	SOURce[1 2]:AMPlitude:COUPlE:STATe {ON Off}	
Example	SOURce1:AMPlitude:COUPlE:STATe on	
Description	Turns amplitude coupling on.	
Query Syntax	SOURce[1 2]:AMPlitude:COUPlE:STATe?	
Return Parameter	1	ON
	0	Off
Example	SOURce1:AMPlitude:COUPlE:STATe? 1 Amplitude coupling has been enabled.	

SOURce[1 2]:TRACk		Instrument Command
Description	Turns tracking on or off.	
Syntax	SOURce[1 2]:TRACk {ON OFF INVerted}	
Parameter/ Return Parameter	ON	ON
	OFF	OFF
	INVerted	INVerted
Example	SOURce1:TRACk ON Turns tracking on. Channel 2 will “track” the changes of channel 1.	
Query Syntax	SOURce[1 2]:TRACk?	
Example	SOURce1:TRACk? ON Channel tracking is turned on.	

Reference Command

SYSTEM:ROSCillator:SOURce		Source Specific Command
Description	Sets or queries the 26.8436MHz reference source as internal or external.	
Syntax	SYSTEM:ROSCillator:SOURce {INTernal EXTernal}	
Parameter	INTernal	Sets the reference to the internal source.
	EXTernal	Sets the reference to the external source.
Example	SYSTEM:ROSCILLATOR:SOURCE INT Sets the reference to the internal source.	
Query Syntax	SYSTEM:ROSCillator:SOURce?	
Parameter	INT	The reference is the internal source.
	EXT	The reference is the external source.
Example	SYSTEM:ROSCILLATOR:SOURCE? INT Indicates that reference is set to internal.	

Save and Recall Commands

Up to 10 different instrument states can be stored to non-volatile memory (memory locations 0~9).

*SAV	Instrument Command
Description	Saves the current instrument state to a specified save slot. When a state is saved, all the current instrument settings, functions and waveforms are also saved.
Note	The *SAV command doesn't save waveforms in non-volatile memory, only the instrument state. The *RST command will not delete saved instrument states from memory.
Syntax	*SAV {0 1 2 4 5 6 7 8 9}
Example	*SAV 0 Save the instrument state to memory location 0.
*RCL	Instrument Command
Description	Recall previously saved instrument states from memory locations 0~9.
Syntax	*RCL {0 1 2 4 5 6 7 8 9}
Example	*RCL 0 Recall instrument state from memory location 0.
MEMory:STATe:DELeTe	Instrument Command
Description	Delete memory from a specified memory location.
Syntax	MEMory:STATe:DELeTe {0 1 2 4 5 6 7 8 9}
Example	MEM:STAT:DEL 0 Delete instrument state from memory location 0.

MEMory:STATe:DELeTe ALL		Instrument Command
Description	Delete memory from all memory locations, 0~9.	
Syntax	MEMory:STATe:DELeTe ALL	
Example	MEM:STAT:DEL ALL Deletes all the instrument states from memory locations 0~9.	

Error Messages

The MFG-2220HM has a number of specific error codes. Use the `SYSTem:ERRor` command to recall the error codes. For more information regarding the error queue.

Command Error Codes

-101 Invalid character

An invalid character was used in the command string. Example: #, \$, %.

```
SOURce1:AM:DEPTH MIN%
```

-102 Syntax error

Invalid syntax was used in the command string. Example: An unexpected character may have been encountered, like an unexpected space.

```
SOURce1:APPL:SQUare , 1
```

-103 Invalid separator

An invalid separator was used in the command string. Example: a space, comma or colon was incorrectly used.

```
APPL:SIN 1 1000 OR SOURce1:APPL:SQUare
```

-108 Parameter not allowed

The command received more parameters than were expected. Example: An extra (not needed) parameter was added to a command

```
SOURce1:APPL? 10
```

-109 Missing parameter

The command received less parameters than expected. Example: A required parameter was omitted.

```
SOURce1:APPL:SQUare
```

- 112 Program mnemonic too long
A command header contains more than 12 characters:
OUTP:SYNCHRONIZATION ON
- 113 Undefined header
An undefined header was encountered. The header is syntactically correct. Example: the header contains a character mistake.
SOUR1:AMM:DEPT MIN
- 123 Exponent too large
Numeric exponent exceeds 32,000. Example:
SOURce[1 | 2]:BURSt:NCYCles 1E34000
- 124 Too many digits
The mantissa (excluding leading 0's) contains more than 255 digits.
- 128 Numeric data not allowed
An unexpected numeric character was received in the command. Example: a numeric parameter is used instead of a character string.
SOURce1:BURSt:MODE 123
- 131 Invalid suffix
An invalid suffix was used. Example: An unknown or incorrect suffix may have been used with a parameter.
SOURce1:SWEep:TIME 0.5 SECS
- 138 Suffix not allowed
A suffix was used where none were expected. Example: Using a suffix when not allowed.
SOURce1:BURSt: NCYCles 12 CYC
- 148 Character data not allowed
A parameter was used in the command where not allowed. Example: A discrete parameter was used where a numeric parameter was expected.
SOUR1:MARK:FREQ ON

-158 String data not allowed

An unexpected character string was used where none were expected. Example: A character string is used instead of a valid parameter.

SOURce1:SWEep:SPACing 'TEN'

-161 Invalid block data

Invalid block data was received. Example: The number of bytes sent with the DATA:DAC command doesn't correlate to the number of bytes specified in the block header.

-168 Block data not allowed

Block data was received where block data is not allowed. Example:

SOURce1:BURSt: NCYCles #10

-170~178 expression errors

Example: The mathematical expression used was not valid.

Execution Errors

-211 Trigger ignored

A trigger was received but ignored. Example: Triggers will be ignored until the function that can use a trigger is enabled (burst, sweep, etc.).

-223 Too much data

Data was received that contained too much data. Example: An arbitrary waveform with over 16384 points cannot be used.

-221 Settings conflict; turned off infinite burst to allow immediate trigger source

Example: Infinite burst is disabled when an immediate trigger source is selected. Burst count set to 1,000,000 cycles.

-221 Settings conflict; infinite burst changed trigger source to MANual

Example: The trigger source is changed to immediate from manual when infinite burst mode is selected.

-221 Settings conflict; burst period increased to fit entire burst

Example: The function generator automatically increases the burst period to allow for the burst count or frequency.

-221 Settings conflict; burst count reduced

Example: The burst count is reduced to allow for the waveform frequency if the burst period is at it's maximum.

-221 Settings conflict; trigger delay reduced to fit entire burst

Example: The trigger delay is reduced to allow the current period and burst count.

-221 Settings conflict; triggered burst not available for noise

Example: Triggered burst cannot be used with noise.

-221 Settings conflict; amplitude units changed to Vpp due to high-Z load

Example: If a high impedance load is used, dBm units cannot be used. The units are automatically set to Vpp.

-221 Settings conflict; trigger output disabled by trigger external

Example: The trigger output terminal is disabled when an external trigger source is selected.

-221 Settings conflict; trigger output connector used by FSK

Example: The trigger output terminal cannot be used in FSK mode.

-221 Settings conflict; trigger output connector used by burst gate

Example: The trigger output terminal cannot be used in gated burst mode.

-221 Settings conflict;trigger output connector used by trigger external

Example: The trigger output connector is disabled when the trigger source is set to external.

-221 Settings conflict;frequency reduced for pulse function

Example: When the function is changed to pulse, the output frequency is automatically reduced if over range.

-221 Settings conflict;frequency reduced for ramp function

Example: When the function is changed to ramp, the output frequency is automatically reduced if over range.

-221 Settings conflict;frequency made compatible with burst mode

Example: When the function is changed to burst, the output frequency is automatically adjusted if over range.

-221 Settings conflict;frequency made compatible with FM

Example: When the function is changed to FM, the frequency is automatically adjusted to suit the FM settings.

-221 Settings conflict;burst turned off by selection of other mode or modulation

Example: Burst mode is disabled when sweep or a modulation mode is enabled.

-221 Settings conflict;FSK turned off by selection of other mode or modulation

Example: FSK mode is disabled when burst, sweep or a modulation mode is enabled.

-221 Settings conflict;FM turned off by selection of other mode or modulation

Example: FM mode is disabled when burst, sweep or a modulation mode is enabled.

-221 Settings conflict;AM turned off by selection of other mode or modulation

Example: AM mode is disabled when burst, sweep or a modulation mode is enabled.

-221 Settings conflict; sweep turned off by selection of other mode or modulation

Example: Sweep mode is disabled when burst or a modulation mode is enabled.

-221 Settings conflict;not able to modulate this function

Example: A modulated waveform cannot be generated with dc voltage, noise or pulse waveforms.

-221 Settings conflict;not able to sweep this function

Example: A swept waveform cannot be generated with dc voltage, noise or pulse waveforms.

-221 Settings conflict;not able to burst this function

Example: A burst waveform cannot be generated with the dc voltage function.

-221 Settings conflict;not able to modulate noise, modulation turned off

Example: A waveform cannot be modulated using the noise function.

-221 Settings conflict;not able to sweep pulse, sweep turned off

Example: A waveform cannot be swept using the pulse function.

-221 Settings conflict;not able to modulate dc, modulation turned off

Example: A waveform cannot be modulated using the dc voltage function.

-221 Settings conflict;not able to sweep dc, modulation turned off

Example: A waveform cannot be swept using the dc voltage function.

-221 Settings conflict;not able to burst dc, burst turned off

Example: The burst function cannot be used with the dc voltage function.

-221 Settings conflict;not able to sweep noise, sweep turned off

Example: A waveform cannot be swept using the noise function.

-221 Settings conflict;pulse width decreased due to period

Example: The pulse width has been adjusted to suit the period settings.

-221 Settings conflict;amplitude changed due to function

Example: The amplitude (VRM / dBm) has been adjusted to suit the selected function. For the MFG-2220HM, a typical square wave has a much higher amplitude (5V Vrms) compared to a sine wave (~3.54) due to crest factor.

-221 Settings conflict;offset changed on exit from dc function

Example: The offset level is adjusted on exit from a DC function.

-221 Settings conflict;FM deviation cannot exceed carrier

Example: The deviation cannot be set higher than the carrier frequency

-221 Settings conflict;FM deviation exceeds max frequency

Example: If the FM deviation and carrier frequency combined exceeds the maximum frequency plus 100 kHz, the deviation is automatically adjusted.

-221 Settings conflict;frequency forced duty cycle change

Example: If the frequency is changed and the current duty cannot be supported at the new frequency, the duty will be automatically adjusted.

-221 Settings conflict;offset changed due to amplitude

Example: The offset is not a valid offset value, it is automatically adjusted, considering the amplitude.

$$|\text{offset}| \leq \text{max amplitude} - V_{pp}/2$$

-221 Settings conflict;amplitude changed due to offset

Example: The amplitude is not a valid value, it is automatically adjusted, considering the offset.

$$V_{pp} \leq 2X (\text{max amplitude} - |\text{offset}|)$$

-221 Settings conflict;low level changed due to high level

Example: The low level value was set too high. The low level is set 1 mV less than the high level.

-221 Settings conflict;high level changed due to low level

Example: The high level value was set too low. The high level is set 1 mV greater than the low level.

-222 Data out of range;value clipped to upper limit

Example: The parameter was set out of range. The parameter is automatically set to the maximum value allowed.

SOURce1:FREQuency 60.1MHz.

-222 Data out of range;value clipped to lower limit

Example: The parameter was set out of range. The parameter is automatically set to the minimum value allowed.

SOURce1:FREQuency 0.1μHz.

-222 Data out of range;period; value clipped to ...

Example: If the period was set to a value out of range, it is automatically set to an upper or lower limit.

-222 Data out of range;frequency; value clipped to ...

Example: If the frequency was set to a value out of range, it is automatically set to an upper or lower limit.

-222 Data out of range;user frequency; value clipped to upper limit

Example: If the frequency is set to a value out of range for an arbitrary waveform using, SOURce[1 | 2]: APPL: USER or SOURce[1 | 2]: FUNC:USER, it is automatically set to the upper limit.

-222 Data out of range;ramp frequency; value clipped to upper limit

Example: If the frequency is set to a value out of range for a ramp waveform using, SOURce[1 | 2]: APPL: RAMP or SOURce[1 | 2]: FUNC:RAMP, it is automatically set to the upper limit.

-222 Data out of range;pulse frequency; value clipped to upper limit

Example: If the frequency is set to a value out of range for a pulse waveform using, SOURce[1 | 2]: APPL:PULS or SOURce[1 | 2]: FUNC:PULS, it is automatically set to the upper limit.

-222 Data out of range;burst period; value clipped to ...

Example: If the burst period was set to a value out of range, it is automatically set to an upper or lower limit.

222 Data out of range;burst count; value clipped to ...

Example: If the burst count was set to a value out of range, it is automatically set to an upper or lower limit.

-222 Data out of range; burst period limited by length of burst; value clipped to upper limit

Example: The burst period must be greater than burst count divided by the frequency + 200 ns. The burst period is adjusted to satisfy these conditions.

$\text{burst period} > 200 \text{ ns} + (\text{burst count} / \text{burst frequency})$.

-222 Data out of range; burst count limited by length of burst; value clipped to lower limit

Example: The burst count must be less than burst period * the waveform frequency when the the trigger source is set to immediate (SOURCE[1 | 2]: TRIG:SOUR IMM). The burst count is automatically set to the lower limit.

-222 Data out of range; amplitude; value clipped to ...

Example: If the amplitude was set to a value out of range, it is automatically set to an upper or lower limit.

-222 Data out of range; offset; value clipped to ...

Example: If the offset was set to a value out of range, it is automatically set to an upper or lower limit.

-222 Data out of range; frequency in burst mode; value clipped to ...

Example: If the frequency was set to a value out of range in burst mode. The burst frequency is automatically set to an upper or lower limit, taking the burst period into account.

-222 Data out of range; frequency in FM; value clipped to ...

Example: The carrier frequency is limited by the frequency deviation (SOURCE[1 | 2]: FM:DEV). The carrier frequency is automatically adjusted to be less than or equal to the frequency deviation.

-222 Data out of range;marker confined to sweep span; value clipped to ...

Example: The marker frequency is set to a value outside the start or stop frequencies. The marker frequency is automatically adjusted to either the start or stop frequency (whichever is closer to the set value).

-222 Data out of range;FM deviation; value clipped to ...

Example: The frequency deviation is outside of range. The deviation is automatically adjusted to an upper or lower limit, depending on the frequency.

-222 Data out of range;trigger delay; value clipped to upper limit

Example: The trigger delay was set to a value out of range. The trigger delay has been adjusted to the maximum (100 seconds).

-222 Data out of range; trigger delay limited by length of burst; value clipped to upper limit

Example: The trigger delay and the burst cycle time combined must be less than the burst period.

-222 Data out of range;duty cycle; value clipped to ...

Example: The duty cycle is limited depending on the frequency.

Duty Cycle	Frequency
0.01%~99.99%(>20nS)	Full range

-222 Data out of range; duty cycle limited by frequency; value clipped to upper limit

Example: The duty cycle is limited depending on the frequency. When the frequency is greater than 50 MHz, the duty cycle is automatically limited to 50%.

-313 Calibration memory lost;memory corruption detected

Indicates that a fault (check sum error) has occurred with the non-volatile memory that stores the calibration data.

-314 Save/recall memory lost;memory corruption detected

Indicates that a fault (check sum error) has occurred with the non-volatile memory that stores the save/recall files.

-315 Configuration memory lost;memory corruption detected

Indicates that a fault (check sum error) has occurred with the non-volatile memory that stores the configuration settings.

-350 Queue overflow

Indicates that the error queue is full (over 20 messages generated, and not yet read). No more messages will be stored until the queue is empty. The queue can be cleared by reading each message, using the *CLS command or restarting the function generator.

-361 Parity error in program message

Indicates that there is a RS232 parity setting mismatch between the host PC and the function generator.

-362 Framing error in program message

Indicates that there is a RS232 stop bit setting mismatch between the host PC and the function generator.

-363 Input buffer overrun

Indicates that too many characters have been sent to the function generator via RS232. Ensure handshaking is used.

Query Errors

-410 Query INTERRUPTED

Indicates that a command was received but the data in the output buffer from a previous command was lost.

-420 Query UNTERMINATED

The function generator is ready to return data, however there was no data in the output buffer. For example: Using the APPLY command.

-430 Query DEADLOCKED

Indicates that a command generates more data than the output buffer can receive and the input buffer is full. The command will finish execution, though all the data won't be kept.

Arbitrary Waveform Errors

-770 Nonvolatile arb waveform memory corruption detected

Indicates that a fault (check sum error) has occurred with the non-volatile memory that stores the arbitrary waveform data.

-781 Not enough memory to store new arb waveform; bad sectors

Indicates that a fault (bad sectors) has occurred with the non-volatile memory that stores the arbitrary waveform data. Resulting in not enough memory to store arbitrary data.

-787 Not able to delete the currently selected active arb waveform

Example: The currently selected waveform is being output and cannot be deleted.

800 Block length must be even

Example: As block data (DATA:DAC VOLATILE) uses two bytes to store each data point, there must be an even number of bytes for a data block.

SCPI Status Register

The status registers are used to record and determine the status of the function generator.

The function generator has a number of register groups:

Questionable Status Registers

Standard Event Status Registers

Status Byte Register

As well as the output and error queues.

Each register group is divided into three types of registers: condition registers, event registers and enable registers.

Register types

Condition Register	The condition registers indicate the state of the function generator in real time. The condition registers are not triggered. I.e., the bits in the condition register change in real time with the instrument status. Reading a condition register will not clear it. The condition registers cannot be cleared or set.
Event Register	The Event Registers indicate if an event has been triggered in the condition registers. The event registers are latched and will remain set unless the *CLS command is used. Reading an event register will not clear it.
Enable Register	The Enable register determines which status event(s) are enabled. Any status events that are not enabled are ignored. Enabled events are used to summarize the status of that register group.

MFG-2220HM Status System

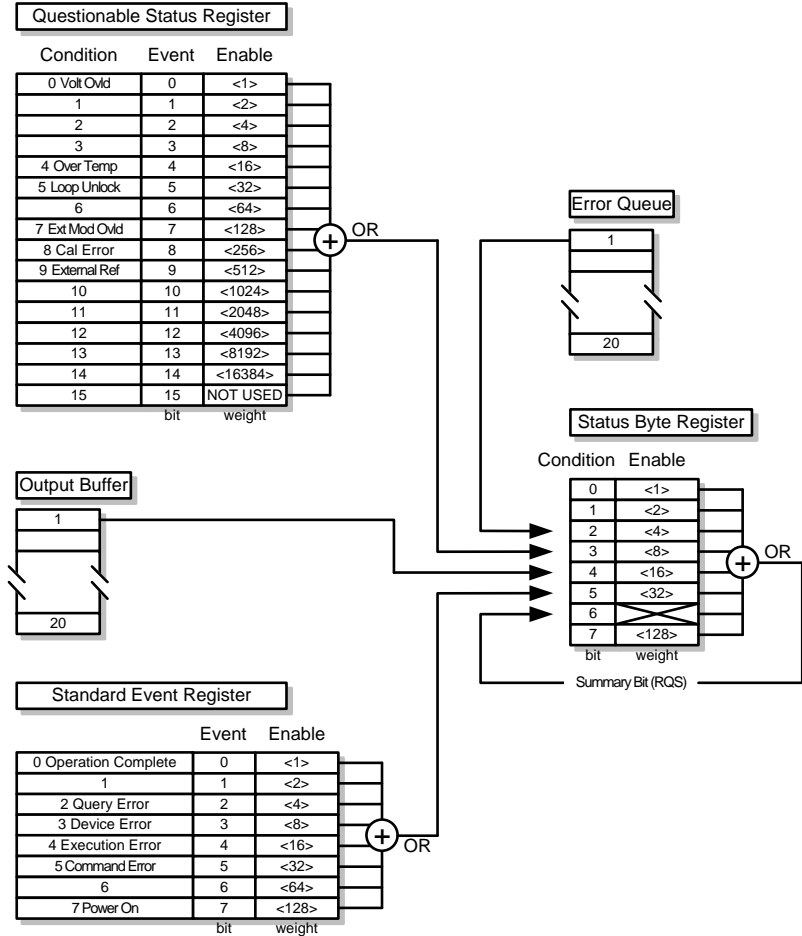

Questionable Status Register

Description The Questionable Status Registers will show if any faults or errors have occurred.

Bit Summary	Register	Bit	Bit Weight
	Voltage overload	0	1
	Over temperature	4	16
	Loop unlock	5	32
	Ext Mod Overload	7	128
	Cal Error	8	256
	External Reference	9	512

Standard Event Status Registers

Description The Standard Event Status Registers indicate when the *OPC command has been executed or whether any programming errors have occurred.

Notes The Standard Event Status Enable register is cleared when the *ESE 0 command is used.

 The Standard Event Status Event register is cleared when the *CLS command or the *ESR? command is used.

Bit Summary	Register	Bit	Bit Weight
	Operation complete bit	0	1
	Query Error	2	4
	Device Error	3	8
	Execution Error	4	16
	Command Error	5	32
	Power On	7	128

Error Bits	Operation complete	The operation complete bit is set when all selected pending operations are complete. This bit is set in response to the *OPC command.
	Query Error	The Query Error bit is set when there is an error reading the Output Queue. This can be caused by trying to read the Output Queue when there is no data present.
	Device Error	The Device Dependent Error indicates a failure of the self-test, calibration, memory or other device dependent error.
	Execution Error	The Execution bit indicates an execution error has occurred.
	Command Error	The Command Error bit is set when a syntax error has occurred.
	Power On	Power has been reset.

The Status Byte Register

Description	<p>The Status Byte register consolidates the status events of all the status registers. The Status Byte register can be read with the *STB? query or a serial poll and can be cleared with the *CLS command.</p> <p>Clearing the events in any of the status registers will clear the corresponding bit in the Status Byte register.</p>		
Notes	<p>The Status byte enable register is cleared when the *SRE 0 command is used.</p> <p>The Status Byte Condition register is cleared when the *CLS command is used.</p>		
Bit Summary	Register	Bit	Bit Weight
	Error Queue	2	4
	Questionable Data	3	8
	Message Available	4	16
	Standard Event	5	32
	Master Summary / Request Service	6	64
Status Bits	Error Queue	There are error message(s) waiting in the error queue.	
	Questionable data	The Questionable bit is set when an “enabled” questionable event has occurred.	
	Message Available	The Message Available bit is set when there is outstanding data in the Output Queue. Reading all messages in the output queue will clear the message available bit.	

Standard Event	The Event Status bit is set if an “enabled” event in the Standard Event Status Event Register has occurred.
Master Summary/Service Request bit	<p>The Master Summary Status is used with the *STB? query. When the *STB? query is read the MSS bit is not cleared.</p> <p>The Request Service bit is cleared when it is polled during a serial poll.</p>

Output Queue

Description	The Output queue stores output messages in a FIFO buffer until read. If the Output Queue has data, the MAV bit in the Status Byte Register is set.
-------------	--

Error Queue

Description	<p>The error queue is queried using the SYSTem:ERRor? command. The Error queue will set the “Error Queue” bit in the status byte register if there are any error messages in the error queue. If the error queue is full the last message will generate a “Queue overflow” error and additional errors will not be stored. If the error queue is empty, “No error” will be returned.</p>
-------------	--

Error messages are stored in the error queue in a first-in-first-out order. The errors messages are character strings that can contain up to 255 characters.

APPENDIX

MFG-2220HM Series Specifications

The specifications apply when the function generator is powered on for at least 30 minutes under +18°C~+28°C.

CH1/ CH2			
Arbitrary Functions	ARB function	Built-in	
	Sample Rate	250MHz	
	Repetition Rate	125MHz	
	Waveform Length	16k points	
	Amplitude Resolution	14 bits	
	Non-Volatile Memory	10sets 16k points(1)	
	User-defined output section	From point 2~16384 (optional)	
Frequency Characteristics	Range	Sine	200MHz(max)
		Square	60MHz(max)
		Triangle, Ramp	5MHz
	Resolution	1μHz	
	Accuracy Stability	±20 ppm	
	Aging	±1 ppm, per 1 year	
	Tolerance	≤1μHz	
	Output Characteristics(2)	Amplitude Range	1mVpp to 10 Vpp
1 mVpp to 5 Vpp			≅ 70MHz
1 mVpp to 2 Vpp			≅ 120MHz
1 mVpp to 1 Vpp			≅ 200MHz
(into 50Ω)			
Accuracy	±2% of setting ±1 mVpp (at 1 kHz/into 50Ω without DC offset)		

	Resolution	0.1mV or 4 digits
	Flatness	± 1% (0.1dB) ≦ 10MHz ± 2% (0.2dB) ≦ 60 MHz ± 10% (1dB) ≦ 100 MHz ± 15% (1.5dB) ≦ 160 MHz ± 30% (3dB) ≦ 200MHz (sinewave relative to 100 kHz, 0dBm,into 50Ω)
	Units	Vpp, Vrms, dBm
Offset	Range	±5 Vpk ac +dc (into 50Ω) ±10Vpk ac +dc (Open circuit)
	Accuracy	1% of setting + 5mV+ 0.5% of amplitude
Waveform Output		
	Impedance	50Ω typical (fixed) >10MΩ (output disabled)
	Protection	Short-circuit protected Overload relay automatically disables main output
Sync Output	Range	TTL-compatible into>1kΩ
	Impedance	50Ω standard
Sine wave Characteristics(3)		
	Harmonic distortion	<-60 dBc <200kHz, <-55 dBc 200kHz~1 MHz, <-45 dBc 1MHz~10 MHz, <-35 dBc 10MHz~30 MHz, <-30 dBc 30MHz~200MHz, (at 0dBm/into 50Ω without DC offset)
	Total harmonic distortion	< 0.1% (Ampl>1Vpp) 10Hz~100 kHz
Square wave Characteristics		
	Rise/Fall Time	<8ns
	Overshoot	<5%
	Asymmetry	1% of period +5 ns
	Variable duty Cycle	0.01% to 99.99%(limited by the current frequency setting)

	Jitter	20ppm+500ps
Ramp Characteristics		
	Linearity	< 0.1% of peak output
	Variable Symmetry	0% to 100%
Pulse Characteristics		
	Frequency	1uHz~50MHz
	Pulse Width	≧ 10nS (limited by the current frequency setting)
	Variable duty Cycle	0.01%~99.99% (limited by the current frequency setting)
	Overshoot	<5%
	Jitter	20ppm+500ps
AM Modulation		
	Carrier Waveforms	Sine, Square, Triangle, Ramp, Pulse, Arb
	Modulating Waveforms	Sine, Square, Triangle, Upramp, Dnramp
	Modulating Frequency	2mHz to 50kHz (Int) DC to 50kHz (Ext)
	Depth	0% to 120.0%
	Source	Internal / External
FM Modulation		
	Carrier Waveforms	Sine, Square, Triangle, Ramp
	Modulating Waveforms	Sine, Square, Triangle, Upramp, Dnramp
	Modulating Frequency	2mHz to 50kHz (Int) DC to 50kHz (Ext)
	Deviation	DC to 0.5*max frequency
	Source	Internal / External
PM Modulation		
	Carrier Waveforms	Sine, Square, Triangle, Ramp
	Modulating Waveforms	Sine, Square, Triangle, Upramp, Dnramp
	Modulation Frequency	2mHz to 50kHz (Int) DC to 50kHz (Ext)
	Phase deviation	0° ~360.0°
	Source	Internal / External
SUM		

Modulation	Carrier Waveforms	Sine, Square, Triangle, Pulse, Ramp, Noise
	Modulating Waveforms	Sine, Square, Triangle, Upramp, Dnramp
	Modulation Frequency	2mHz to 50kHz (Int) DC to 50kHz (Ext)
	SUM depth	0%~100.0%
	Source	Internal / External
PWM Modulation	Carrier Waveforms	Pulse
	Modulating Waveforms	Sine, Square, Triangle, Upramp, Dnramp
	Modulation Frequency	2mHz to 50kHz (Int) DC to 50kHz (Ext)
	Width Depth	0%~100.0%
	Source	Internal / External
ASK	Carrier Waveforms	Sine, Square, Triangle, Ramp, Pulse
	Modulating Waveforms	50% duty cycle square
	Internal Frequency	2mHz to 1 MHz
	Ampl Range	1mVpp to 10Vpp
	Source	Internal / External
FSK	Carrier Waveforms	Sine, Square, Triangle, Ramp, Pulse
	Modulating Waveforms	50% duty cycle square
	Internal Frequency	2mHz to 1 MHz
	Frequency Range	1 μ Hz to max frequency
	Source	Internal / External
PSK	Carrier Waveforms	Sine, Square, Triangle, Ramp, Pulse
	Modulating Waveforms	50% duty cycle square
	Internal Frequency	2mHz to 1 MHz
	Phase Range	0° ~360.0°
	Source	Internal / External

Sweep	Waveforms	Sine, Square, Triangle, Ramp
	Type	Linear or Logarithmic
	Sweep direction	Sweep up or sweep down
	Start/Stop Freq	1uHz to max frquency
	Sweep Time	1ms to 500s
	Source	Internal / External
	Trigger	Single, External, Internal.
	Marker	Marker signal on falling edge(programmable)
Burst	Waveforms	Sine, Square, Triangle,Ramp,Arb
	Frequency	1uHz~MaxFrequency
	Pulse count	1~1000000 Cycles or infinite
	Start/ Stop Phase	-360.0° ~+360.0°
	Internal Frequency	1 us~500 s
	Gate source	External Trigger
	Trigger Source	Single, External, Internal.
	Trigger Delay	NCycle, Infinite : 0s~100 s
External Trigger Input	Type	For FSK, Burst, Sweep
	Input Level	TTL Compatibility
	Slope	Rising or Falling(Selectable)
	Pulse Width	>100ns
	Input Rate	DC to 1MHz
External Modulation Input	Type	For AM,FM, PM,SUM,PWM
	Voltage Range	±5V full scale
	Input Impedance	10kΩ
	Frequency	DC to 50kHz
Trigger Output	Type	For Burst,Sweep
	Level	TTL Compatible into 50Ω
	Pulse Width	>100ns
	Maximum Rate	1MHz
	Fan-out	≥4 TTL Load

Reference Input	Impedance	50Ω Typical
	Input Voltage	0.5Vp-p to 5Vp-p
	Output Impedance	1kΩ, unbalanced, AC coupled
	Input Frequency	26.8436MHz ± 500Hz
	Waveform	Sine or square (50±5% duty)
Reference Output	Output Voltage	3.3 Vp-p square wave
	Output Impedance	50Ω, AC coupled
	Output Frequency	26.8436MHz
Frequency Counter	Range	5Hz to 150MHz
	Accuracy	Time Base accuracy±1count
	Time Base	±20ppm (23 °C ±5 °C)
	Resolution	The maximum resolution is: 100nHz for 1Hz, 0.1Hz for 100MHz.
	Input Impedance	1kΩ/1pf
	Sensitivity	35mVrms ~ 30Vrms (5Hz to 150MHz)
Pulse Generator	Amplitude	1mVpp to 2.5 Vpp (into 50Ω) 2mVpp to 5 Vpp (open-circuit)
	Offset	±1 Vpk ac +dc (into 50Ω) ±2Vpk ac +dc (Open circuit)
	Frequency	1uHz~25MHz
	Pulse Width	20nS~999.6ks (limited by the current frequency setting)
	Variable duty Cycle	0.01%~99.99% (limited by the current frequency setting)
	Leading and Trailing Edge Time(5)	10nS~20S(1ns resolution) (limited by the current frequency and pulse width settings)
	Overshoot	<5%
	Jitter	100ppm+500ps
Dual Channel		

Function (CH1/CH2)	
Phase	-180° ~180°
	Synchronize phase
Track	CH2=CH1
Coupling	Frequency(Ratio or Difference)
	Amplitude & DC Offset
Dsolink	√
Save/Recall	10 Groups of Setting Memories
Interface	LAN, USB
Display	4.3" TFT LCD 480 × 3 (RGB) × 272
General Specifications	
Power Source	AC100~240V, 50~60Hz
Power Consumption	35W Max
Operating Environment	Temperature to satisfy the specification : 18 ~ 28 °C Operating temperature : 0 ~ 40 °C Relative Humidity: ≤ 80%, 0 ~ 40 °C ≤70%, 35 ~ 40 °C Installation category : CAT II
Operating Altitude	2000 Meters
Storage Temperature	-10~70 °C, Humidity: ≤70%
Dimensions (WxHxD)	266(W) x 107(H) x293(D)mm
Weight	Approx. 2.8kg
Safety designed to	EN61010-1
Accessories	GTL-110× 2 Quick Start Guide ×1 CD (user manual + software) ×1 Power cord×1

- (1). A total of ten waveforms can be stored. (Every waveform can be composed of a maximum of 16k points.)
- (2). Add 1/10th of output amplitude and offset specification per °C for operation outside of 0°C to 28°C range (1-year specification).
- (3). DC offset set to zero.

EC Declaration of Conformity

We

GOOD WILL INSTRUMENT CO., LTD.

No.7-1, Jhongsing Rd., Tucheng Dist., New Taipei City 236, Taiwan

GOOD WILL INSTRUMENT (SUZHOU) CO., LTD.

No. 69, Lushan Road, Suzhou New District Jiangsu, China

declares that the below mentioned product

MFG-2220HM

Are here with confirmed to comply with the requirements set out in the Council Directive on the Approximation of the Law of Member States relating to Electromagnetic Compatibility (2004/108/EC&2014/30/EU) and Low Voltage Equipment Directive EMC: 2014/30/EU, LVD: 2014/35/EU, WEEE: 2012/19/EU and RoHS: 2011/65/EU. For the evaluation regarding the Electromagnetic Compatibility and Low Voltage Equipment Directive, the following standards were applied:

◎ **EMC**

EN 61326-1:	Electrical equipment for measurement, control and laboratory use — EMC requirements (2013)	
EN 61326-2-2:		
Conducted and Radiated Emissions EN 55011: 2016(Class A)	Electrical Fast Transients IEC 61000-4-4: 2012	
Current Harmonic EN 61000-3-2: 2014	Surge Immunity EN 61000-4-5: 2014+A1:2017	
Voltage Fluctuation EN 61000-3-3: 2013	Conducted Susceptibility EN 61000-4-6: 2014	
Electrostatic Discharge EN 61000-4-2: 2009	Power Frequency Magnetic Field EN 61000-4-8: 2010	
Radiated Immunity EN 61000-4-3: 2006+A1 : 2008+A2:2010	Voltage Dips/ Interruptions IEC 61000-4-11: 2004+A1:2017	

◎ **Safety**

Low Voltage Equipment Directive 2014/35/EU	
Safety Requirements	EN 61010-1: 2010(Third Edition)

GLOBAL HEADQUARTERS

GOOD WILL INSTRUMENT CO., LTD.

No. 7-1, Jhongsing Road, Tucheng Dist., New Taipei City 236,
Taiwan

Tel: +886-2-2268-0389

Fax: +866-2-2268-0639

Web: www.gwinstek.com

Email: marketing@goodwill.com.tw

GOOD WILL INSTRUMENT (SUZHOU) CO., LTD.

No. 521, Zhujiang Road, Snd, Suzhou Jiangsu 215011, China

Tel: +86-512-6661-7177

Fax: +86-512-6661-7277

Web: www.instek.com.cn

Email: marketing@instek.com.cn

Europe Subsidiary

GOOD WILL INSTRUMENT EURO B.V.







De Run 5427A, 5504DG Veldhoven, The Netherlands





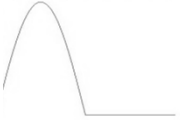
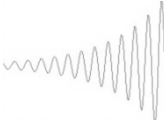
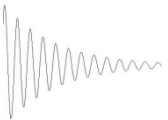



Tel: [+31\(0\)40-2557790](tel:+31(0)40-2557790)



Fax: [+31\(0\)40-2541194](tel:+31(0)40-2541194)



Email: sales@gw-instek.eu



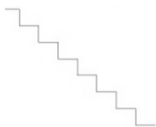
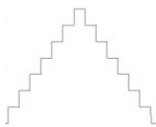

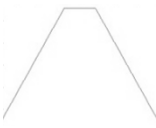
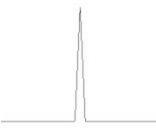



ARB Built-In Waveforms









Common		
Absatan	$y = \text{atan}(x) $ The absolute of atan(x)	
Abssin	$y = \sin(x) $ The absolute of sin(x)	
Abssinehalf	$y = \sin(x), 0 < x < \pi$ $y = 0, \pi < x < 2\pi$ Half_wave function	
Ampalt	$y = e(x) \cdot \sin(x)$ Oscillation rise	
Attalt	$y = e(-x) \cdot \sin(x)$ Oscillation down	
Diric	Even $f(x) = -1^{(x^*(n-1)/2*\pi)}$ $x = 0, \pm 2*\pi, \pm 4*\pi, \dots$	
Diric	Odd $f(x) = \sin(nx/2) / n * \sin(x/2)$ $x = \pm \pi, \pm 3\pi, \dots$	
Gauspuls	$f(x) = a * e^{-(x-b)^2/c^2}$ Gaussian-modulated sinusoidal pulse	





Havercosine	$y=(1-\sin(x))/2$ Havercosine function	
Haversin	$y=(1-\cos(x))/2$ Haversine function	
N_pulse	Negative pulse	
Negramp	$y=-x$ Line segment	
Rectpuls	Sampled aperiodic rectangle	
Roundhalf	$y=\sqrt{1-x^2}$ The half roud	
Sawtoot	Sawtooth or triangle wave	
Sinetra	Piecewise function	
Sinever	Piecewise sine function	

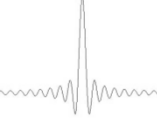

Stair_down	Step down	
Stair_ud	Step up and step down	
Stair_up	Step up	
Stepresp	Heaviside step function	
Trapezia	Piecewise function	
Tripuls	Sampled aperiodic triangle	



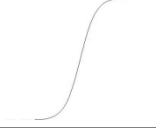





Math		
Arccos	Arc cosine	
Arccot	Arc cotangent	



Arccsc	Arc cosecant	
Arcsec	Arc secant	
Arcsin	Arc sine	
Arcsinh	Hyperbolic arc sine	
Arctan	Arc tangent	
Arctanh	Hyperbolic arc tangent	
Cosh	Hyperbolic cosine	
Cot	Cotangent	
Csc	Cosecant	

Dlorentz	The derivative of the lorentz function $y = -\frac{2x}{(k^2x^2+1)}$	
Exp Fall	Exponential fall	
Exp Rise	Exponential rise	
Gauss	A waveform representing a gaussian bell curve	
Ln	Logarithm function	
Lorentz	Lorentz function $y = 1/(k^2x^2+1)$	
Sec	Secant	
Sech	Hyperbolic secant	
Sinec	$y = \sin(x)/x$	

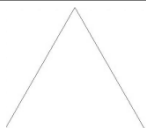
Sinh	Hyperbolic sine	
Sqrt	$y=\sqrt{x}$	
Tan	Tangent	
Tanh	Hyperbolic tangent	
Xsquare	Parabola	

Window		
Barthannwin	Modified Bartlett-Hann window	
Bartlett	The Bartlett window is very similar to a triangular window as returned by the triang function.	
Blackman	The Blackman window function	

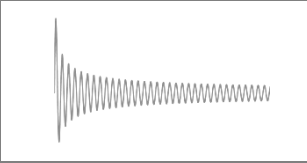
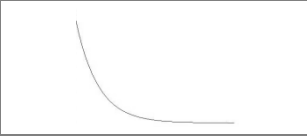
Bohmanwin	The Bohman window function	
Chebwin	The Chebyshev window function	
Flattopwin	The Flattopwin window function	
Hamming	The Hamming window function	
Hann	The Hann window function	
Hanning	The Hanning window function	
Kaiser	The Kaiser window function	
Triang	The Triang window function	
Tukeywin	The Tukey window function	

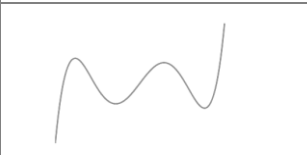
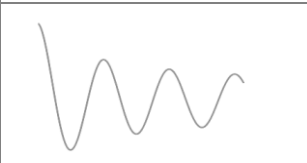
Engineer		
Airy	The airy function	
Bessel	The Bessel function	
Beta	The beta function	
Gamm	The gamma function	
Legendre	Associated Legendre function	
Neumann	The Neumann function	

INDEX

AM commands.....	293	pollution degree	9
Amplitude coupling	209	Environment	
Apply commands	269	safety instructions	8
ARB commands	347	Error messages	364
ARB error messages	376	Ethernet interface.....	244
Arbitrary waveforms.....	212	FM commands.....	301
display	215	Frequency counter	198
edit.....	223	Frequency counter commands	355
output.....	233	Frequency coupling	207
protection.....	230	Front panel diagram	14
save and load	235	FSK commands.....	306
Beeper.....	195	Function keys	
Built-in ARB waveforms.....	393	key overview	14
Burst commands	336	Fuse replacement	364
Caution symbol.....	6	safety instruction.....	8
Channel Settings	201	Ground	
Channel tracking.....	210, 211	symbol.....	6
Cleaning the instrument	8	Help menu	25
Command error codes	364	LAN interface	244
Coupling commands	358	Language selection	195
Declaration of conformity	391	lin sweep	168
Default settings	66	List of features	12
Digital inputs		log sweep	168
how to use	24	Menu Tree.....	49
Display		Modulation	101
diagram.....	19	AM.....	104
Display brightness.....	196	carrier frequency	105
Disposal		carrier shape	105
symbol.....	7	depth.....	108
Disposal instructions.....	9	frequency	107
DSO link.....	204	shape.....	106
Dual channel		source	110
amplitude coupling	209	amplitude.....	159
channel tracking	210, 211	Burst.....	173
frequency coupling.....	207	count.....	175
EN61010		delay	182
measurement category.....	7	frequency	174
		modes	173

output	184	Square.....	70
period.....	177	Operation keys	
phase.....	178	key overview	14
trigger	181	Output commands.....	277
carrier frequency	155	Output phase.....	203
carrier wave	155	Phase commands	357
FM.....	118	PM commands	309
carrier frequency	119	Power on/off	
carrier shape.....	119	safety instruction	7
deviation.....	122	Power up.....	20
frequency.....	121	Pulse configuration commands	
shape.....	120	287
source.....	123	Query Errors.....	376
frequency.....	158	Quick reference	22
FSK.....	111, 125	ARB	45
carrier frequency	127	burst.....	43
carrier shape.....	126	selecting a waveform.....	28
hop frequency.....	128	sweep	41
rate	129	utility.....	48
source.....	130	Rear panel diagram	17
PM.....	132	Reference clock.....	197
carrier frequency	133	remote control	
carrier shape.....	133	interface configuration	249
deviation.....	136	Remote control.....	243
frequency.....	135	interface configuration	244
shape.....	134	Remote interface	
source.....	137	Error messages	364
source.....	160	functionality check	247
Sweep.....	162	LAN.....	189
marker	170	LAN host name	191
mode	168	SCPI registers	378
span.....	166	screen lock	247
start	163	Syntax.....	253
stop.....	163	terminal connection.....	247
trigger	171	USB.....	192
wave.....	156	Save and recall	186
Operation.....	68	Save and Recall commands ...	362
Amplitude.....	84, 97	SCPI registers	378
Channel selection	69, 88	Screen capture	199
DC Wave	80	Screen lock	247
Frequency.....	83, 96	Secondary System Settings	185
Harmonic Characteristics.....	79	Remote interface	193
Harmonic Order.....	77	System and Settings.....	194
Harmonic Wave.....	76	Service operation	
Noise Wave	76	about disassembly	7
Offset	85, 98	Set output impedance	202
Pulse width.....	72, 73	Setting up the instrument	20
Ramp.....	74		
select waveform.....	69		
Sine.....	70		

software download.....	247	UK power cord.....	10
Status register commands.....	265	Updating Firmware	194
SUM commands.....	316	USB	
Sweep commands.....	325	remote control interface	244
System commands.....	262	Warning symbol.....	6
Tracking	210, 211		