

Application Note

## LED Test and Measurement System Source Measure Unit Application

### TEST YOUR LEDS FASTER AND EASIER!

This document has provided users with the knowledge background of LEDs, as well as the method to test LEDs through spectrometers, integrating spheres, and source measure units.



Cooper Liu  
GW Instek 3<sup>rd</sup> R&D Business Unit

## TABLE OF CONTENTS

1. INTRODUCTION.....	3
2. BACKGROUND OF LED TESTING.....	3
3. LED TEST CONTENT.....	4
4. CONCLUSION.....	6
REFERENCE.....	8
SOURCE MEASURE UNIT GSM-20H10 FEATURES.....	8

## 1. INTRODUCTION

LED is the abbreviation of Light Emitting Diode, which is widely used in lighting, LCD display backlight, mobile phones, information display, status indicators, and other applications, including information transmission (such as IrDA infrared transmission, Li-Fi optical communications technology Light Fidelity), signal conversion (such as infrared thermal imaging, optocoupler), and more applications in biomedical applications, such as UV sterilization.



LED Light Strip



LED Flashlight

## 2. BACKGROUND OF LED TESTING

The characteristics tests of LEDs, the same as that of conventional light sources, need to determine LED characteristics through standard measurement methods, such as measuring luminous flux, luminous intensity, luminance, illuminance, etc. These tests must follow the regulations formulated by the International Commission on Illumination (CIE). Standards formulated afterwards such as CIE1931 and CIE1976 became the foundation of colorimetry.

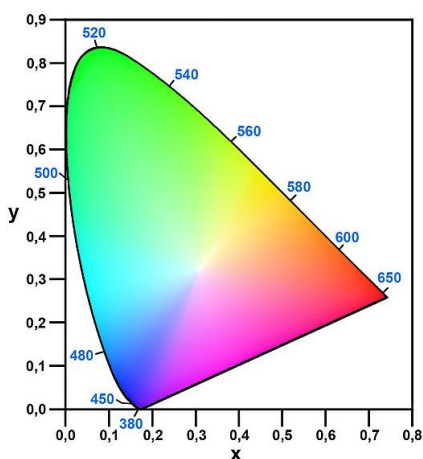

CIE1931 Chromaticity Diagram

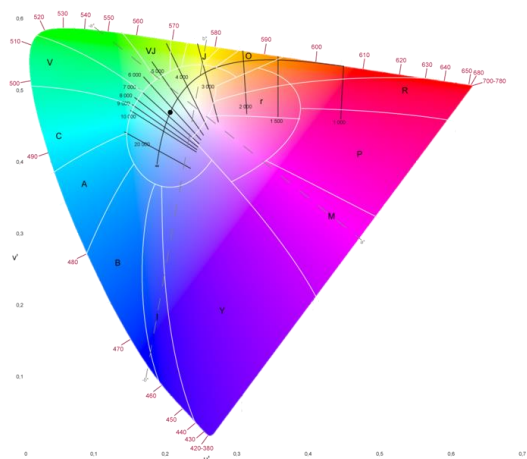

CIE1976 Color Space

When testing the characteristics of LEDs, equipment such as spectrometers, integrating spheres, and source measure units are required. The connection method involves using a computer to control the output of the power source (such as a source measure unit) and the light source receiving measurement end (such as a spectrometer) to control and measure the LED.

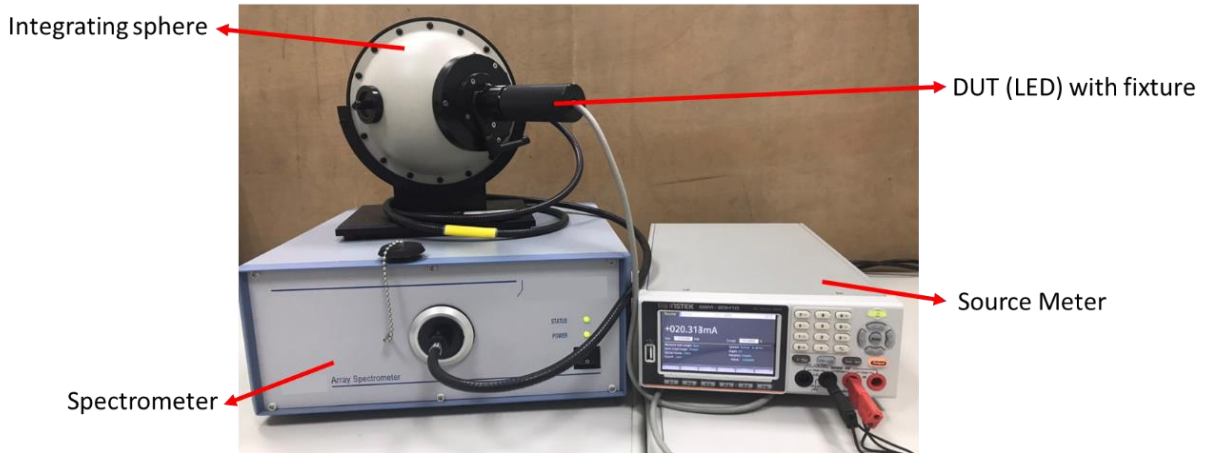

LED Test System Using GW Instek GSM-20H10 Source Measure Unit

### 3. LED TEST CONTENT

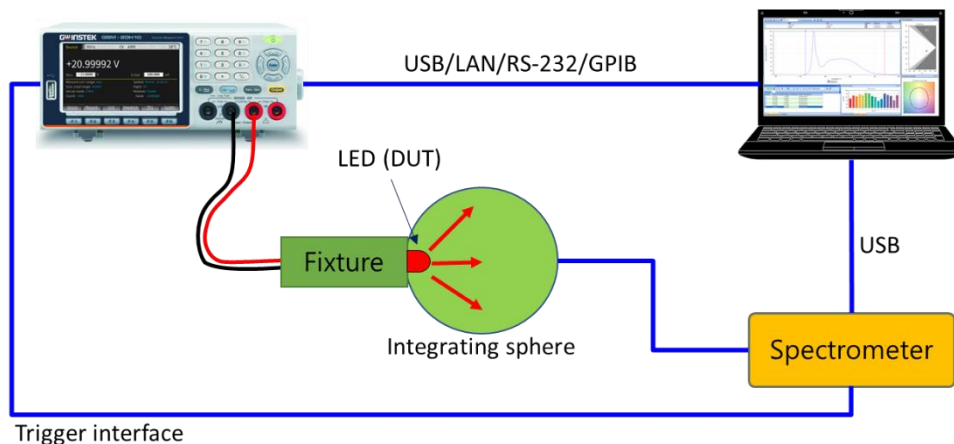

Connection method of LED test

**For testing light source**, the LED device needs to be placed at the entrance of the integrating sphere to illuminate the inside of the sphere. The integrating sphere is then connected to a spectrometer using an optical fiber. Next, set the spectrometer parameters, including integration time, resolution, and measurement range. These parameters will be adjusted according to the conditions of different LEDs. The test content will refer to the CIE standard regulations. Normally, the test content consists of several key elements, including spectrum graph, illuminance, color temperature, and color.

**With respect to power supplier**, since the energy consumption of LEDs is extremely low, a stable and high-resolution power supply is required for testing. Therefore, a source measure unit is usually selected for testing. As a stable power source, when it is set to constant current mode, the source measure unit can ensure a constant current under different loads. The constant voltage mode can ensure a constant voltage under different loads.

To test an LED using a source measure unit, the following steps should be followed:

1. Set the output voltage and current of the source measure unit according to the LED's rated voltage and current. Typically, the operating current of an LED is in the range of  $\mu\text{A}$  to mA, while the rated voltage is within 20V.
2. Connect the positive and negative terminals of the source measure unit to the positive and negative terminals of the LED, and set the corresponding current and voltage.
3. Set the desired power supply mode, either constant current (CC) or constant voltage (CV) mode.
4. Set the output parameters of the source, such as current, voltage, and measurement time.
5. Start the output of the source and begin the measurement.
6. Determine the characteristics of the LED, such as forward current and operating voltage, based on the reading of the meter.

In addition, sometimes during testing, testing for dark current and negative voltage is also carried out. Dark current refers to the current caused by noise and thermal energy in the absence of external light sources. The negative voltage test is to determine the range of the LED's reverse voltage and reverse leakage current. When the set voltage exceeds the reverse voltage, the LED may burn out. The reverse leakage current can be used to determine the quality of the LED. The smaller the leakage current, the better the quality of the LED.

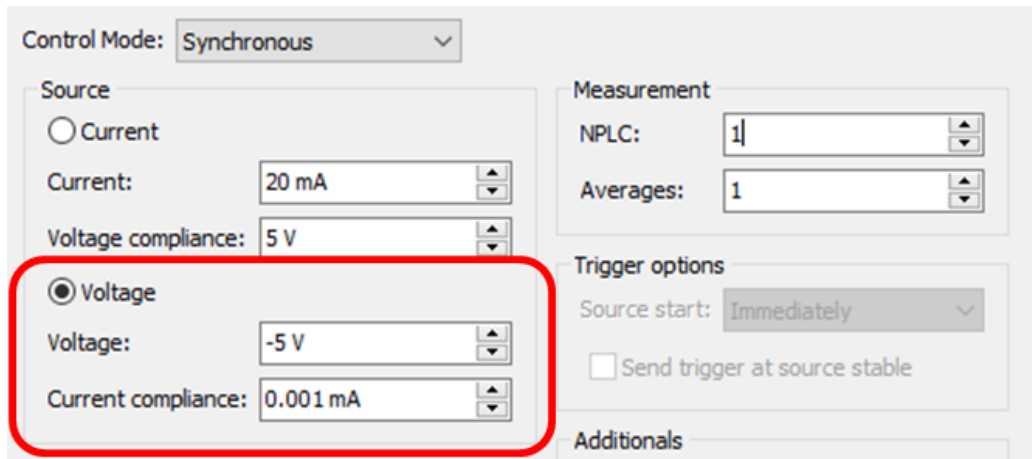

**Negative Voltage Test Example**

In LED testing, it is important to note that if the LED is lit for a long period of time during testing, there is a high probability of causing LED light decay and heat generation. This not only causes errors in the test results but also affects the LED's lifecycle. Therefore, during testing, the LED is usually only lit for a few milliseconds, and the power output must be immediately turned off after testing.

#### 4. CONCLUSION

A complete LED test not only includes data such as spectral graph, illuminance, and color temperature, but also records the parameters and values of each measurement. As shown in the figure below, the test in this article was conducted in accordance with the color quality TM30 regulations for LED testing. In addition to the parameters required for the LED, the voltage changes under CC mode were also recorded one by one in the parameter settings, allowing engineers to perform more characteristic analysis.

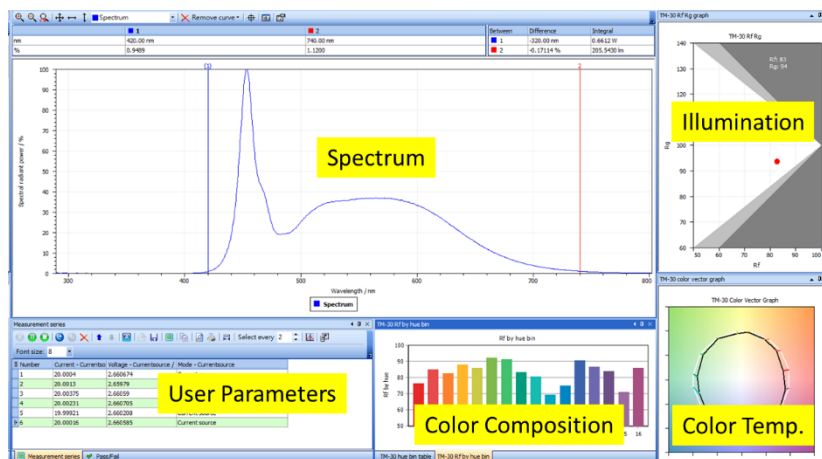

**LED Testing for Color Quality TM30 Regulations**

In this application, the role of GSM-20H10 is a high-precision and high-stability DC power supply, providing stable constant voltage (CV) and constant current (CC) outputs. It can also measure LED parameters such as voltage and current consumption with a resolution as low as 1  $\mu$ V/10pA during measurement. In terms of remote control, it provides communication interfaces such as RS-232/USB/LAN/GPIB (optional), supports the standard SCPI commands, and provides a LabVIEW driver suitable for LabVIEW development to allow users or system integrators (SIs) to easily develop automated measurement programs.

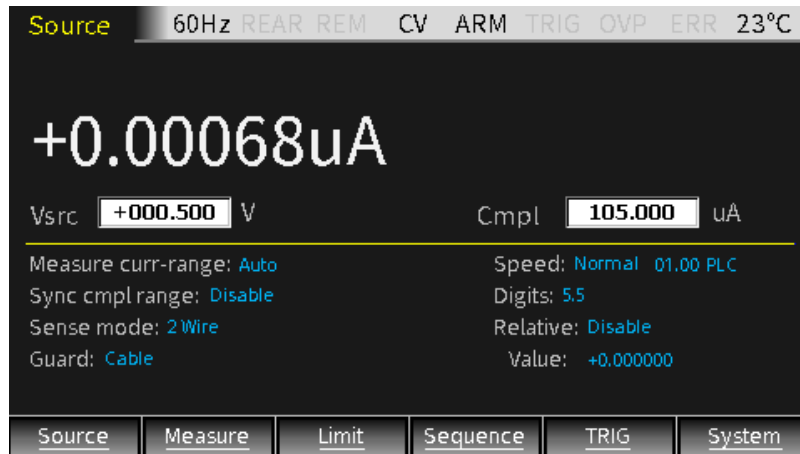

GSM-20H10 with preset 10pA current resolution

## Reference:

1. CIE1931 Wiki, [https://en.wikipedia.org/wiki/CIE\\_1931\\_color\\_space](https://en.wikipedia.org/wiki/CIE_1931_color_space)
2. CIELUV Wiki, <https://en.wikipedia.org/wiki/CIELUV>
3. Instrument Systems, <https://www.instrumentsystems.com/>
4. Labsphere, <https://www.labsphere.com/>
5. Rapitech, <http://www.rapi-tech.com.tw/>
6. Tempoint, <https://www.tempoint.com.tw/>

## Appendix – Source Measure Unit GSM-20H10 Features



### Source:

- Maximum output:  $\pm 210V$ ,  $\pm 1.05A$ , 22W
- Built-in 4 sequence output modes, up to 2500 points
- OVP /OTP Protection Function

### Meter:

- 0.012% basic measure accuracy with  $6\frac{1}{2}$ -digit resolution
- Variable Sampling Speed
- SDM (Source Delay Measure) Cycle
- 2-, 4-, and 6-wire remote V-source and measure sensing
- Variable Display Digits
- Built-in Limit function
- Built-in 5 calculation functions

### Others:

- Standard SCPI command, Provide Interface: RS-232, USBTMC, LAN, GPIB (Optional)
- 4.3" TFT LCD, Digital Number Keyboard
- Built-in RTC Clock



Should you have any questions on this application, please don't hesitate to contact us.

Global Headquarters

**GOOD WILL INSTRUMENT CO., LTD.**

No.7-1, Jhongsing Road, Tucheng Dist., New Taipei City 236, Taiwan  
T +886-2-2268-0389 F +886-2-2268-0639  
E-mail: marketing@goodwill.com.tw

China Subsidiary

**GOOD WILL INSTRUMENT (SUZHOU) CO., LTD.**

No. 521, Zhujiang Road, Snd, Suzhou Jiangsu 215011 China  
T +86-512-6661-7177 F +86-512-6661-7277  
E-mail: marketing@instek.com.cn

Malaysia Subsidiary

**GOOD WILL INSTRUMENT (SEA) SDN. BHD.**

No. 1-3-18, Elit Avenue, Jalan Mayang Pasir 3,  
11950 Bayan Baru, Penang, Malaysia  
T +604-6111122 F +604-6115225  
E-mail: sales@goodwill.com.my

Europe Subsidiary

**GOOD WILL INSTRUMENT EURO B.V.**

De Run 5427A, 5504DG Veldhoven, THE NETHERLANDS  
T +31(0)40-2557790 F +31(0)40-2541194

U.S.A. Subsidiary

**INSTEK AMERICA CORP.**

5198 Brooks Street Montclair, CA 91763, U.S.A.  
T +1-909-399-3535 F +1-909-399-0819  
E-mail: sales@instekamerica.com

Japan Subsidiary

**TEXIO TECHNOLOGY CORPORATION.**

7F Towa Fudosan Shin Yokohama Bldg., 2-18-13 Shin  
Yokohama, Kohoku-ku, Yokohama, Kanagawa,  
222-0033 Japan  
T +81-45-620-2305 F +81-45-534-7181  
E-mail: info@texio.co.jp

Korea Subsidiary

**GOOD WILL INSTRUMENT KOREA CO., LTD.**

Room No.503, Gyeonginro 775 (Mullae-Dong 3Ga,  
Ace Hightech-City B/D 1Dong), Yeongduengpo-Gu,  
Seoul 150093, Korea.  
T +82-2-3439-2205 F +82-2-3439-2207  
E-mail : gwinstek@gwinstek.co.kr

**GW INSTEK**  
Simply Reliable



[www.gwinstek.com](http://www.gwinstek.com)



[www.facebook.com/GWInstek](https://www.facebook.com/GWInstek)