

Spectrum Analyzer

GSP-9330

PROGRAMMING MANUAL



ISO-9001 CERTIFIED MANUFACTURER

GW INSTEK

This manual contains proprietary information, which is protected by copyright. All rights are reserved. No part of this manual may be photocopied, reproduced or translated to another language without prior written consent of Good Will company.

The information in this manual was correct at the time of printing. However, Good Will continues to improve products and reserves the rights to change specification, equipment, and maintenance procedures at any time without notice.

Good Will Instrument Co., Ltd.
No. 7-1, Jhongsing Rd., Tucheng Dist., New Taipei City 236, Taiwan.

Table of Contents

SAFETY INSTRUCTIONS	2
GETTING STARTED.....	7
GSP-9330 Introduction	8
Accessories.....	10
Appearance.....	12
REMOTE CONTROL.....	25
Interface Configuration	26
Command Syntax	49
Status Registers	55
Command List	65
APPENDIX.....	256
ASCII to Binary Coded Decimal Table.	256

S SAFETY INSTRUCTIONS

This chapter contains important safety instructions that you must follow during operation and storage. Read the following before any operation to ensure your safety and to keep the instrument in the best possible condition.

Safety Symbols

These safety symbols may appear in this manual or on the instrument.



Warning: Identifies conditions or practices that could result in injury or loss of life.



Caution: Identifies conditions or practices that could result in damage to the instrument or to other properties.



DANGER High Voltage



Attention Refer to the Manual



Earth (ground) Terminal



Frame or Chassis Terminal



Do not dispose electronic equipment as unsorted municipal waste. Please use a separate collection facility or contact the supplier from which this instrument was purchased.

Safety Guidelines

General Guideline



CAUTION

- Do not place any heavy object on the instrument.
- Avoid severe impact or rough handling that leads to damaging the instrument.
- Do not discharge static electricity to the instrument.
- Use only mating connectors, not bare wires, for the terminals.
- Ensure signals to the RF input do not exceed +30dBm.
- Ensure reverse power to the TG output terminal does not exceed +30dBm.
- Do not supply any input signals to the TG output.
- Do not block the cooling fan opening.
- Do not disassemble the instrument unless you are qualified.

(Measurement categories) EN 61010-1:2010 specifies the measurement categories and their requirements as follows. The instrument falls under category II.

- Measurement category IV is for measurement performed at the source of low-voltage installation.
- Measurement category III is for measurement performed in the building installation.
- Measurement category II is for measurement performed on the circuits directly connected to the low voltage installation.
- Measurement category I is for measurements performed on circuits not directly connected to Mains.

Power Supply



WARNING

- AC Input voltage range: 100V~240V
 - Frequency: 50/60Hz
 - To avoid electrical shock connect the protective grounding conductor of the AC power cord to an earth ground.
-

Battery



CAUTION

- Rating: 10.8V, 6 cell Li-ion battery
- Turn off the power and remove the power cord before installing or removing the battery.

Cleaning

- Disconnect the power cord before cleaning.
- Use a soft cloth dampened in a solution of mild detergent and water. Do not spray any liquid.
- Do not use chemicals containing harsh material such as benzene, toluene, xylene, and acetone.

Operation Environment

- Location: Indoor, no direct sunlight, dust free, almost non-conductive pollution (Note below)
- Temperature: 5°C to 45°C
- Humidity: <90%

(Pollution Degree) EN 61010-1:2010 specifies the pollution degrees and their requirements as follows. The instrument falls under degree 2.

Pollution refers to “addition of foreign matter, solid, liquid, or gaseous (ionized gases), that may produce a reduction of dielectric strength or surface resistivity”.

- Pollution degree 1: No pollution or only dry, non-conductive pollution occurs. The pollution has no influence.
- Pollution degree 2: Normally only non-conductive pollution occurs. Occasionally, however, a temporary conductivity caused by condensation must be expected.
- Pollution degree 3: Conductive pollution occurs, or dry, non-conductive pollution occurs which becomes conductive due to condensation which is expected. In such conditions, equipment is normally protected against exposure to direct sunlight, precipitation, and full wind pressure, but neither temperature nor humidity is controlled.

Storage environment

- Location: Indoor
- Temperature: -20°C to 70°C
- Humidity: <90%

Disposal

Do not dispose this instrument as unsorted municipal waste. Please use a separate collection facility or contact the supplier from which this instrument was purchased. Please make sure discarded electrical waste is properly recycled to reduce environmental impact.

Power cord for the United Kingdom

When using the instrument in the United Kingdom, make sure the power cord meets the following safety instructions.

NOTE: This lead/appliance must only be wired by competent persons



WARNING: THIS APPLIANCE MUST BE EARTHED

IMPORTANT: The wires in this lead are coloured in accordance with the following code:

Green/ Yellow:	Earth
Blue:	Neutral
Brown:	Live (Phase)



As the colours of the wires in main leads may not correspond with the coloured marking identified in your plug/appliance, proceed as follows:

The wire which is coloured Green & Yellow must be connected to the Earth terminal marked with either the letter E, the earth symbol \oplus or coloured Green/Green & Yellow.

The wire which is coloured Blue must be connected to the terminal which is marked with the letter N or coloured Blue or Black.

The wire which is coloured Brown must be connected to the terminal marked with the letter L or P or coloured Brown or Red.

If in doubt, consult the instructions provided with the equipment or contact the supplier.

This cable/appliance should be protected by a suitably rated and approved HBC mains fuse: refer to the rating information on the equipment and/or user instructions for details. As a guide, a cable of 0.75mm² should be protected by a 3A or 5A fuse. Larger conductors would normally require 13A types, depending on the connection method used.

Any exposed wiring from a cable, plug or connection that is engaged in a live socket is extremely hazardous. If a cable or plug is deemed hazardous, turn off the mains power and remove the cable, any fuses and fuse assemblies. All hazardous wiring must be immediately destroyed and replaced in accordance to the above standard.

G E T T I N G S T A R T E D

This chapter provides a brief overview of the GSP-9330, the package contents and an introduction to the front panel, rear panel and GUI.



GSP-9330 Introduction	8
Main Features	8
Accessories	10
Appearance	12
GSP-9330 Front Panel	12
Rear Panel	17
Display	20
Status Icon Overview	22

GSP-9330 Introduction

The GSP-9330 builds on the strong feature set of the GSP-9300 and significantly increases performance in almost every aspect; making this the most comprehensive and feature-rich spectrum analyzer GW Instek has released.

Like the GSP-9300, the GSP-9330 features a split window display to view data in spectrum, topographic or spectrographic views. There are also a number of additional test functions such as 2FSK, P1DB and new dedicated EMC pretest functions for EMI and EMS testing. Lastly, the GSP-9330 significantly reduces the sweep time.

Main Features

- | | |
|-------------|---|
| Performance | <ul style="list-style-type: none">• 9kHz~3.25GHz bandwidth• 1Hz resolution• Nominal RBW accuracy of $\pm 5\%$ <1MHz, $\pm 8\%$ =1MHz• Video bandwidth 1Hz~1MHz (1-3-10 steps)• Amplitude measurement range: DANL~30dBm (frequency dependent)• Input attenuation: 0 ~ 50dB, 1dB steps• Phase noise: < -88dBc/Hz@1GHz, 10kHz, typical |
|-------------|---|
-

- | | |
|----------|---|
| Features | <ul style="list-style-type: none">• 1-3-10 step increments for RBW bandwidth• Three display modes: Spectrum, Topographic and Spectrographic• Split window display• Built-in EMI filter• Auto Wake-up• Built-in preamplifier• Gate sweep |
|----------|---|
-

- Marker Frequency counter
 - Two operating modes: Spectrum and Power Meter mode
 - EMI Pretest functions
 - SEM measurement
 - ACPR measurement
 - OCBW measurement
 - 2FSK measurement
 - Phase jitter measurement
 - Harmonics measurement
 - P1dB measurement
 - Channel power measurement
 - Demodulation analyzer
 - Diverse marker functions and features with Peak Table
 - Sequence function to automatically perform pre-programmed sequential operations
 - EMI quasi-peak and average detector
 - Optional battery operation
-

Interface

- 8.4 color LCD (800×600)
- On-screen menu icons
- DVI-I video output
- RS-232 with RTS/CTS hardware flow control
- USB 2.0 with support for USB TMC
- LAN TCP/IP with LXI support
- Optional GPIB/IEEE488 interface
- Optional 3G USB adapter for WLAN
- Optional power meter adapter
- IF output @ 886MHz
- Headphone output

- REF (reference clock) input/output BNC ports
- Alarm/Open collector output BNC port
- Trigger/Gate input BNC ports
- RF N-type input port
- Tracking generator output
- DC +7V/500mA output SMB port

Accessories

Standard Accessories	Part number	Description
	Region dependant	User manual
	Region dependant	Power cord
	N/A	Certificate of calibration
	N/A	Quick Start Manual
	N/A	User Manual CD
Options	Option number	Description
	Opt1.	Tracking generator
	Opt2.	Battery (11.1V/5200mAH Li-ion battery)
	Opt3.	GPIB interface (IEEE 488 bus)
Optional Accessories	Part number	Description
	GSC-009	Soft Carrying Case
	PWS-06	USB Average Power Sensor (up to 6200 MHz; -32 to 20 dBm)
	GRA-415	6U Rack mount kit
Software Downloads		
		PC Software for Windows System

IVI Driver Supports LabView & LabWindows/CVI
Programming



Android System (“GSP-9330 Remote Control”, available
on Google Play.)

Appearance

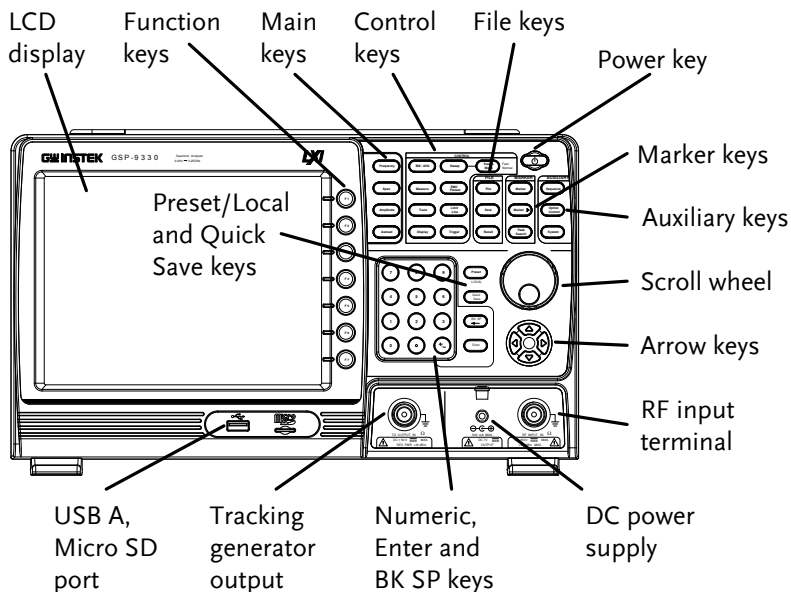
GSP-9330 Front Panel





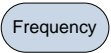

LCD display 800×600 color LCD display. The display shows the soft keys for the current function, frequency, amplitude and marker information.

Function keys  ~  The F1 to F7 function keys directly correspond to the soft keys on the right-hand side of display.

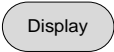
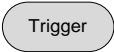
Main keys  Sets the center frequency, start frequency, stop frequency, center frequency step and frequency offset values.

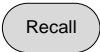
	Span	Sets the span, with options for full span, zero span and last span.
	Amplitude	Sets the amplitude reference level, attenuation, pre-amplifier controls, scale and other options for attenuation and scale.
	Autoset	Automatically searches the peak signal with maximum amplitude and displays it with appropriate horizontal and vertical scales.
<hr/>		
Control keys	BW/Avg	Sets the resolution bandwidth, video bandwidth, average type and turns the EMI filter on/off.
	Sweep	Sets the sweep time and gate time.
	Sweep Mode	Toggles the Sweep Control between <i>Fast</i> and <i>Normal</i> mode.
	Measure	Accesses measurement options such as ACPR, OCBW, demodulation measurements, SEM, TOI, 2FSK, phase jitter and other advanced measurements.
	EMC Pretest	Dedicated EMI testing and setup menu.
	Trace	Sets traces and trace related functions.
	Limit Line	Sets and tests Pass/Fail limit lines.

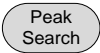
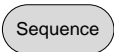
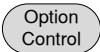
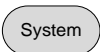
		The Display key configures the windowing mode and basic display properties.
		Sets the triggering modes.
<hr/>		
File		File utilities options
		Save the trace, state etc., and save options.
		Recall the trace, state etc., and recall options.
<hr/>		
Marker		Turns the Markers on/off and configures the markers.
		The <i>Marker</i> ► key positions the markers on the trace.
		Finds each maximum and minimum peak. Used with the Marker function.
<hr/>		
Auxiliary		Access, set and edit program sequences.
		The <i>Option Control</i> key allows you to setup optional accessories such as the Tracking Generator, Power Meter or Demo Kit.
		The System key shows system information, settings and other system related functions.
<hr/>		

Preset / Local key



The *Preset* key will restore the spectrum analyzer to the Factory or User Preset settings.

The Preset key will also return the instrument back to local control after it has been in remote control mode.



The Quick Save utility allows you to save either the state, trace, display screen, limit line, correction or sequence with only a single press.

Power key

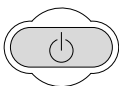

Turns the instrument on/off. On = yellow, off = blue.

Scroll wheel

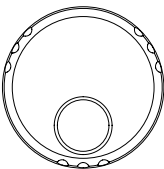

Edit values, select listed items.

Arrow keys

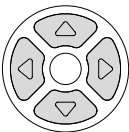

Increment/decrement values (in steps), select listed items.

RF input terminal

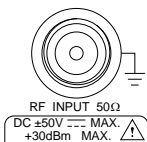

RF input port. Accepts RF inputs.

- Maximum input: +30dBm
- Input impedance: 50Ω
- Maximum DC voltage: ±50V
- N-type: female

DC power supply

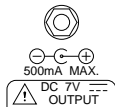

SMB port supplies power for optional accessories.

- DC +7V
- 500mA Max.

Numeric keypad

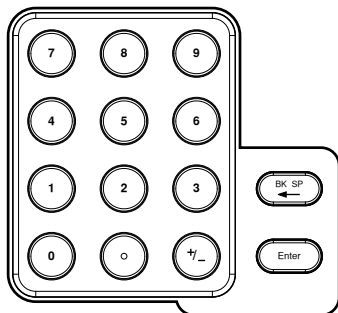

The numeric keypad is used to enter values and parameters. It is often used in conjunction with the arrow keys and scroll wheel.

TG output port

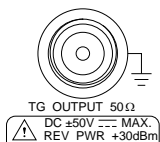

The Tracking Generator (TG) output source.

- N-type: female
- Input impedance: 50Ω
- Output power: -50dBm to 0dBm
- Maximum reversed power: +30dBm

USB A, Micro SD



USB A port, Micro SD port for saving/recalling settings/files.

Rear Panel

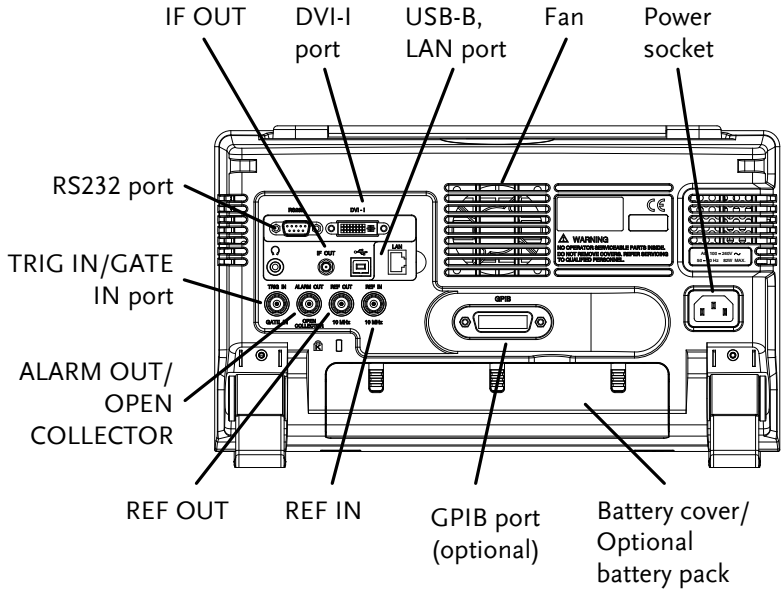

RS232

RS232

RS232 9 pin DSUB port.

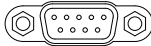

IF OUT

IF OUT

SMA IF Out port.



DVI-I

DVI - I

DVI video out port. Supports SVGA (800X600) @ 60Hz.



Fan

Power Socket

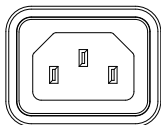

Power Socket:
100~240V, 50/60Hz.

Battery pack

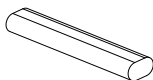

Voltage: 10.8V
Capacity: 5200mAH

REF IN

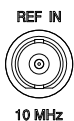

BNC female reference input.

REF OUT



BNC female reference output:
10MHz, 50Ω impedance

Security Lock



ALARM OUT



BNC female open collector Alarm
output.

TRIG IN/GATE IN



BNC female 3.3V CMOS trigger
input/gated sweep input.

Phone



3.5mm stereo headphone jack
(wired for mono operation)

USB B



USB B Device port. USB 1.1/2.0

LAN







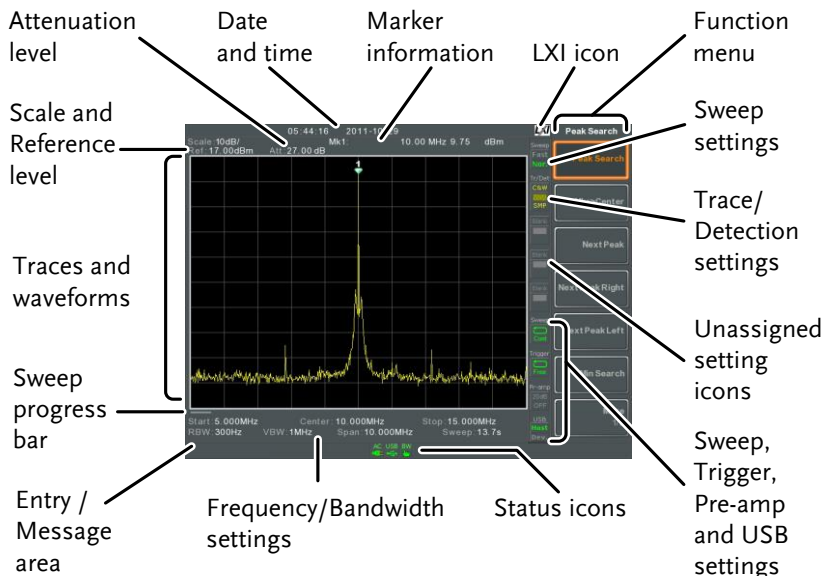

RJ-45 10Base-T/100Base-Tx

Display























- Scale Displays the vertical scale of the vertical grid.
- Reference level Displays the reference level.
- Attenuation Displays the vertical scale (attenuation) of the input signal.
- Date/Time Displays the date and time.
- Marker information Displays marker information.
- LXI icon This icon indicates the status of the LXI connection. For details, see page 27.

Function menu		Soft menu keys associated with the F1 to F7 function keys to the right of the display.
Sweep Mode		This icon displays the sweep mode, as set by the Sweep Mode key.
Sweep settings		Sweep icon that shows the sweep status.
Trace and detection settings		Trace icon that shows the trace type and the detection mode used for each trace.
Blank		Unassigned setting icons.
Trigger settings		Trigger icon that shows the trigger status.
Pre-amp settings		Pre-amplifier icon that shows the Pre-amplifier status.
USB settings		Displays the status of the USB A port.
Status Icons		Displays the interface status, power source status and alarm status, etc. See the Status Icon Overview on page 22 for a list of the status icons.
Frequency/ Bandwidth settings		Displays the Start, Center and Stop frequencies, RBW, VBW, Span and Sweep settings.
Entry/Message area		This area is used to show system messages, errors and input values/parameters.

Trace and waveforms	Main display showing the input signals, traces, limit lines and marker positions.
Sweep progress bar	The sweep progress bar shows the progress of slow sweeps (greater than 2 seconds).

Status Icon Overview

3G Adapter		Indicates that the 3G adapter is installed and turned on.
Demo Kit		Indicates that the demo kit is installed and turned on.
PreAmp		Indicates that the pre amplifier is on.
AC		Shown when running on AC power.
AC Charge		Shown when the AC power is charging the battery.
Alarm Off		Alarm buzzer output is currently off.
Alarm On		Alarm buzzer output is currently on.
Amplitude Offset		Indicates that the amplitude-shift is active. This icon appears when amplitude-related functions are used: Reference level offset Amplitude Correction Input Z = 75Ω & Input Z cal >0

Battery indicator		Indicates the battery charge.
Bandwidth Indicator		Indicates that the RBW or VBW settings are in manual mode.
Average		Indicates that the Average function is active.
External Lock		Indicates that the system is now locked and refers to the external reference input signal
External Trigger		External trigger signal is being used.
Math		Trace math is being used.
Sequence Indicator		Shown when a sequence is running.
Sweep Indicator		Indicates that the sweep time is manually set.
Tracking generator		Indicates that the tracking generator is turned on.
TG Normalization		Indicates that the tracking generator has been normalized.
Wake-up clock		Indicates that the wake-up clock is turned on.
USB		Indicates that a USB flash drive is inserted into the front panel and is recognized.

Micro SD



Indicates that a micro SD card is inserted into the front panel and is recognized.

REMOTE CONTROL

This chapter describes the basic configuration of IEEE488.2 based remote control. This chapter includes interface configuration, a remote control overview as well as the control syntax and commands.

Interface Configuration	26
Configure to USB Remote Interface	26
Configure GPIB Interface	26
Configure the LAN and LXI Interface	27
Configure the WLAN Interface	30
Configure RS232C	35
RS232C Remote Control Function Check	35
LXI Browser Interface and Function Check	37
GPIB Function Check	40
USB Function Check	44
Command Syntax	49
Status Registers	55
Status Registers Overview	55
Status Byte Register (STB)	58
Standard Event Status Register (ESR)	59
Operation Status Register	60
Questionable Status Register	60
Questionable Status Frequency Register	62
Questionable Status ACP Limit Register	62
Questionable Status SEM Limit Register	63
Questionable Status TOI Limit Register	64
Questionable Status Demod Fail Register	64
Command List	65

Interface Configuration

Configure to USB Remote Interface

USB configuration	PC side connector	Type A, host
	GSP side connector	Rear panel Type B, slave
	Speed	1.1/2.0 (full speed/high speed)
	USB Class	USB TMC (USB T&M class)

- Panel operation
1. Connect the USB cable to the rear panel USB B port. 
 2. Press **System** > *More*[F7]>*RmtInterface Config*[F1]>*USB Mode* and toggle the USB mode to *Device*.



It may take a few moments to switch USB modes.

Configure GPIB Interface

To use GPIB, the optional GPIB port must be installed.

- Configure GPIB
1. Ensure the spectrum analyzer is off before proceeding.
 2. Connect a GPIB cable from a GPIB controller to the GPIB port on the spectrum analyzer. 
 3. Turn the spectrum analyzer on.

4. Press System > More[F7] > RmtInterface Config[F1] > GPIB Addr[F1] and set the GPIB address.

GPIB address 0~30

- GPIB constraints
- *Maximum 15 devices altogether, 20m cable length, 2m between each device*
 - *Unique address assigned to each device*
 - *At least 2/3 of the devices turned On*
 - *No loop or parallel connection*

Configure the LAN and LXI Interface

The GSP-9330 is a class C LXI compliant instrument. The LXI specification allows instrumentation to be configured for remote control or monitoring over a LAN or WLAN. The GSP-9330 also supports HiSlip. HiSlip (High-Speed LAN Instrument Protocol) is an advanced LAN based standard for 488.2 communications.

For details on the LXI specification and compliance classes, please see the LXI website @ <http://www.lxistandard.org>.

Background The LAN interface is used for remote control over a network. The spectrum analyzer supports DHCP connections so the instrument can be automatically connected to an existing network. Alternatively, network settings can also be manually configured.

LAN configuration Settings	IP Address	Default Gateway
	Subnet Mask	DNS Server
	DHCP on/off	

Connection Connect an Ethernet cable from the network to the rear panel LAN port.



Settings

1. Press  >More[F7]>RmtInterface[F1]>LAN[F2]>LAN Config[F1] to set the LAN settings:

IP Address[F1] Sets the IP address.
Subnet Mask[F2] Sets the subnet mask.
Default Gateway[F3] Sets the default gateway.
DNS Server[F4] Sets the DNS server address
LAN Config[F5] Toggles the LAN configuration between DHCP and manual settings.
Hint: Use dotted decimal notation when entering IP addresses, ie., 172.16.20.8

2. Press *Apply[F6]* to confirm the LAN configuration settings.

Display Icon



The LXI icon turns green when connected to a LAN and will flash if the “Identification” setting is on, see page 37.

Set Password

The password on the LXI webpage can be set from the spectrum analyzer. The password is shown in the system information.

By default the password is set to: lxiWNpwd

3. Press  >More[F7]>RmtInterface Config[F1]>LAN[F2]>LXIPassword[F3] to set the password.
4. Enter the password using the F1~F7 keys, as shown below, or use the numeric keypad to enter numbers:

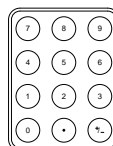

Limitations:

- No spaces
- Only 1~9, A~Z, a~z characters allowed

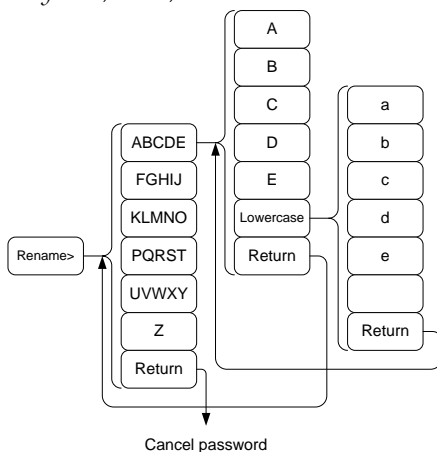

Menu tree to enter the password

5. The password appears on the bottom of the screen as it is created.



6. Press **Enter** to confirm setting the password.

Hi SLIP Port

7. Press **System** > More[F7] > RmtInterface Config[F1] > LAN[F2] > HiSLIPPort to see the Hi Slip Port number.
HiSlip port 4880

Reset LAN It may be necessary to reset the LAN configuration settings before the LAN can be used.

8. Press  >More[F7]>RmtInterface Config[F1]>LAN Reset[F3] to reset the LAN.
9. It may take a few moments before the LAN is reset.



Each time the LAN is reset, the default password is restored.

Default password: lxiWNpwd

Configure the WLAN Interface

The WLAN settings operate using any standard 3G USB modem. For remote locations, using a 3G modem allows you to access the GSP-9330 web server or to control the GSP-9330 via remote control commands.



Background To use the GSP-9330 as a server using a 3G modem, you must first obtain a fixed IP address from a network provider. Each provider will assign different fixed IP addresses.

WLAN configuration Settings	IP Address	Default Gateway
	Subnet Mask	DNS Server

Connection Connect the 3G USB modem to the front panel USB A port.

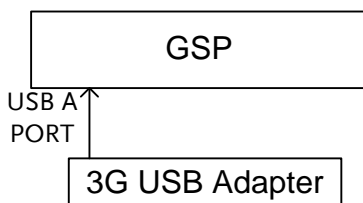
The 3G status icon  will appear when the 3G USB adapter is connected. When it is first connected it will be grayed-out to indicate that it is connected but not activated.



- Settings**
1. Insert the 3G USB modem into the front panel USB A port and wait for the 3G USB  icon to appear.
 2. Press  > More[F7] > RmtInterface[F1] > LAN[F2] > WLAN Config[F2] > Apply[F6] and wait for the 3G USB modem to establish the WLAN settings.

"Finish!!", is shown when the configuration is complete.
 3. The network settings will be displayed in the System menu icons.

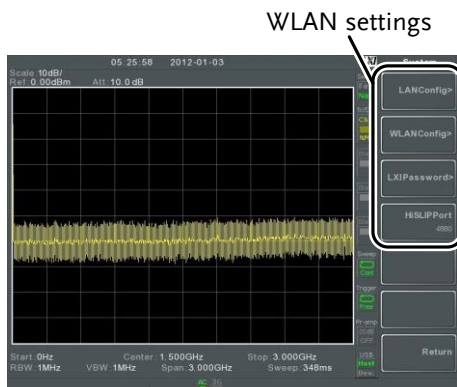

Display Icon



The 3G USB icon turns green when a successful connection has been made.

Set Password

The password on the LXI webpage can be set from the spectrum analyzer. The password is shown in the system information.

By default the password is set to: lxiWNpwd

4. Press **System** > More[F7] > RmtInterface Config[F1] > LAN[F2] > LXIPassword[F3] to set the password.
5. Enter the password using the F1~F7 keys, as shown below, or use the numeric keypad to enter numbers:

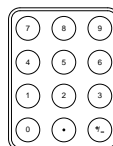

Limitations:

- No spaces
- Only 1~9, A~Z, a~z characters allowed

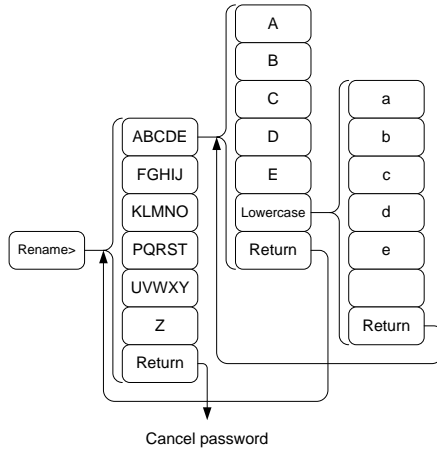

Menu tree to enter the password

- The password appears on the bottom of the screen as it is created.

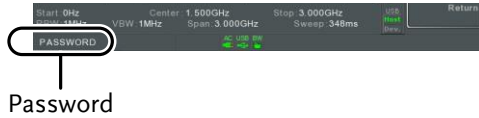

- Press **Enter** to confirm setting the password.

Hi SLIP Port

- Press **System** > More[F7] > RmtInterface Config[F1] > LAN[F2] > HiSLIPPort to see the Hi Slip Port number.
HiSlip port 4880

Reset LAN

It may be necessary to reset the LAN configuration settings before the LAN can be used.

9. Press  >More[F7]>RmtInterface Config[F1]>LAN Reset[F3] to reset the LAN.
 10. It may take a few moments before the LAN is reset.
-



Note

Each time the LAN is reset, the default password is restored.

Default password: lxiWNpwd

Configure RS232C

Background The RS232C interface is used for remote control with a PC.

RS232C Configuration settings	Baud Rate	Stop bit: 1 (fixed)
	Parity: none (fixed)	Data bit: 8 (fixed)

Connection Connect an RS232C cable from the PC to the rear panel RS232 port.

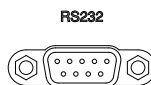

- Press **System** > *More*[F7] > *RmtInterface Config*[F1] > *RS232 BaudRate*[F4] to set the baud rate.

300	600	1200
2400	4800	9600
19200	38400	57600
115200		

RS232C Remote Control Function Check

Functionality check Invoke a terminal application such as Realterm.

To check the COM port No, see the Device Manager in the PC. For WinXP; Control panel → System → Hardware tab.

Run this query command via the terminal after the instrument has been configured for RS232 remote control (page 35).

*idn?

This should return the Manufacturer, Model

number, Serial number, and Firmware version in the following format.

- *GWINSTEK,GSP9330,XXXXXXXXX,V3.X.X.X*

Manufacturer: GWINSTEK

Model number : GSP9330

Serial number : XXXXXXXXX

Firmware version : V3.X.X.X



Note

For further details, please see the programming manual, available on the GW Instek web site @ www.gwinstek.com.

LXI Browser Interface and Function Check

Functionality check

Enter the IP address of the spectrum analyzer in a web browser after the instrument has been configured and connected to the LAN (page 27) or WLAN (page 30).

http:// XXX.XXX.XXX.XXX

The web browser interface appears:

Welcome Page

The Welcome Page lists all the LXI and LAN/WLAN configuration settings as well as the instrument identification. The instrument identification can be disabled from this page.

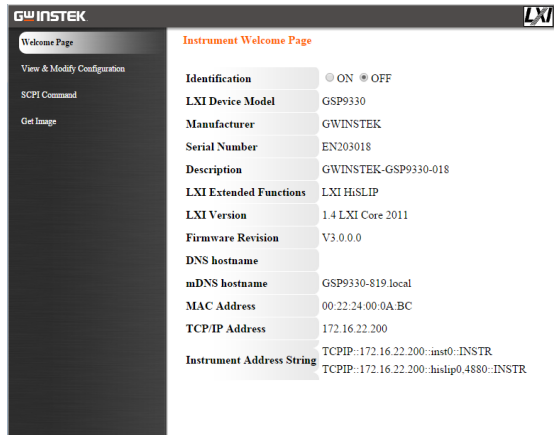

Note



The LXI icon on the GSP-9330 display will flash when the Identification setting is turned on.

View & Modify Configuration

The View & Modify Configuration allows you to modify the LAN settings from the browser.

Press the *Modify Configuration* button to modify any of the configuration files.

A password must be entered to alter the settings.

Default password: lxiWNpwd
 [Note: password is case sensitive.]

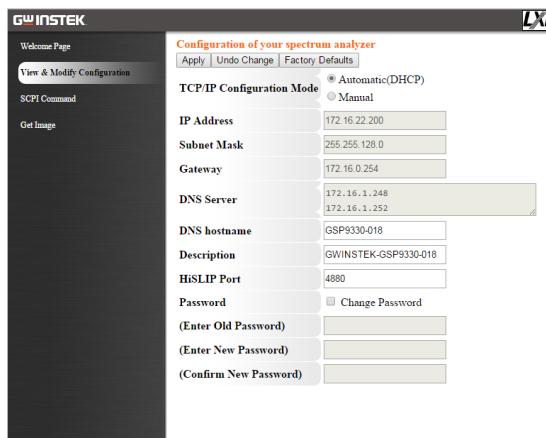

Note

If the “Factory Defaults” option is chosen, the password will be reset back to the default password.

It will also be necessary to manually reset the spectrum analyzer when a message prompts you to do so on the web browser.

SCPI Command

The SCPI Command page allows you to enter SCPI commands directly from the browser for full remote control. Please see the programming manual for details. A password must be entered before remote commands can be used.

Default password: lxiWNpwd
 [Note: password is case sensitive.]

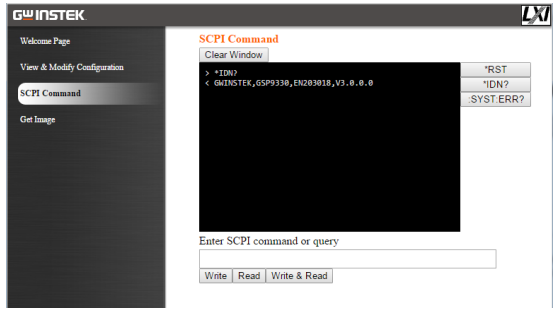

Get Image

The Get Image page allows the browser to remotely capture a screenshot of the GSP-9330 display.

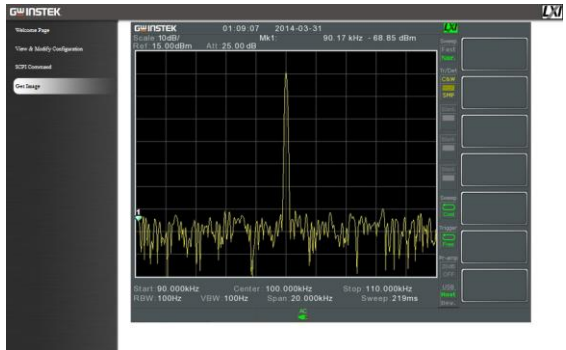

 **Note**

For further details, please see the programming manual, available on the GW Instek web site @ www.gwinstek.com.

GPIB Function Check

Background To test the GPIB functionality, National Instruments Measurement and Automation Explorer can be used. This program is available on the NI website, www.ni.com, via a search for the VISA Run-time Engine page, or “downloads” at the following URL, <http://www.ni.com/visa/>

Requirements Operating System: Windows XP, 7, 8

Functionality check

1. Start the NI Measurement and Automation Explorer (MAX) program. Using Windows, press:

Start>All Programs>National Instruments>Measurement & Automation

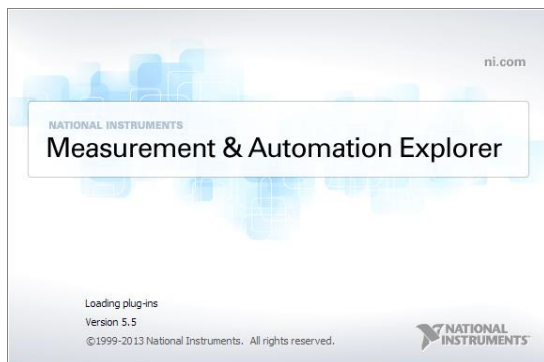

2. From the Configuration panel access;

My System>Devices and Interfaces>GPIBX>
3. Press *Scan for Instruments*.

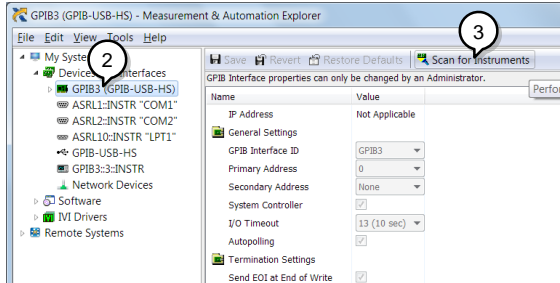

4. Select the device (GPIB address of GSP-9330) that now appears in the *System>Devices and Interfaces > "GPIBX" >"Instrument X"* node.
5. Click on the *VISA Properties* tab on the bottom.
6. Click *Open VISA Test Panel*.

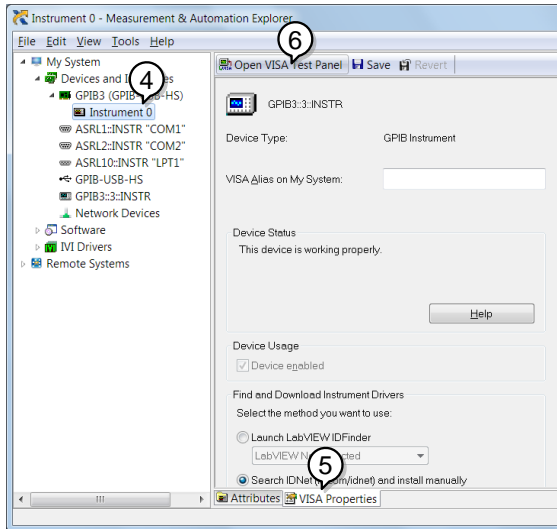

7. Click on *Configuration*.
8. Click on the *GPIB Settings* tab and confirm that the GPIB settings are correct.

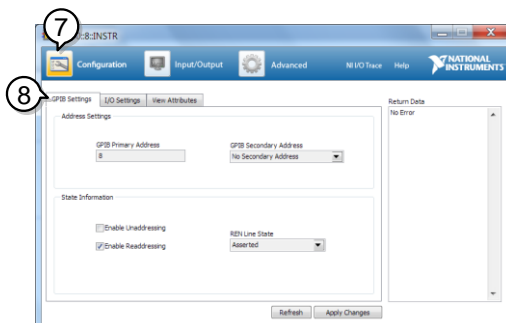

9. Click on the *I/O Settings* tab.
10. Make sure the *Enable Termination Character* check box is checked, and the terminal character is \n (Value: xA).
11. Click *Apply Changes*.

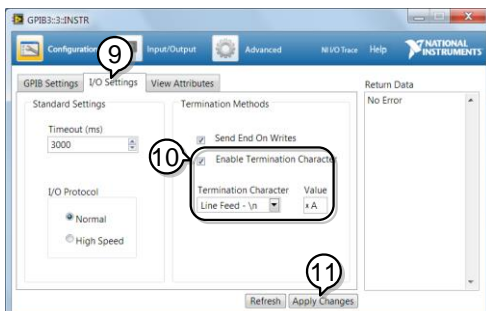

12. Click on *Input/Output*.
13. Click on the *Basic/IO* tab.

14. Enter *IDN? in the *Select or Enter Command* drop down box.
15. Click *Query*.
16. The *IDN? query will return the Manufacturer, model name, serial number and firmware version in the dialog box.

GWINSTEK,GSP9330,ENXXXXXX,V3.X.X.X

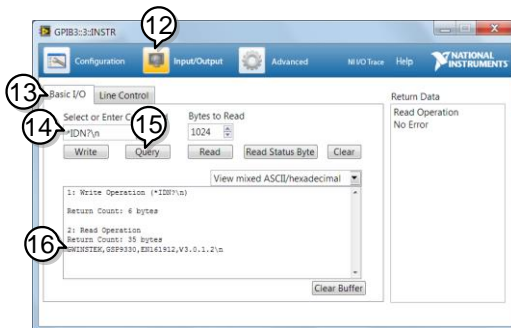

USB Function Check

Background To test the USB functionality, National Instruments Measurement and Automation Explorer can be used. This program is available on the NI website, www.ni.com, via a search for the VISA Run-time Engine page, or “downloads” at the following URL, <http://www.ni.com/visa/>

In addition the IVI driver for the GSP-9330 must also be downloaded. The IVI driver can also be downloaded from the NI website with a search for the GSP-9330 in the thirdparty drivers section.

<http://www.ni.com/downloads/instrument-drivers/>

Requirements Operating System: Windows XP, 7, 8

Functionality
check

1. Set the Remote interface to USB, see page 26.
2. From the Windows Device Manager sure the IVI driver recognizes the USB connection. The GSP-9330 will be recognized as a USB Test and Measurement device (IVI) when the connection is successful.

If the connection is not recognized, reinstall the IVI driver and set the interface to USB again.

To access the Device Manager in Windows 7:
Start>Control Panel>Hardware and Sound>Device Manager

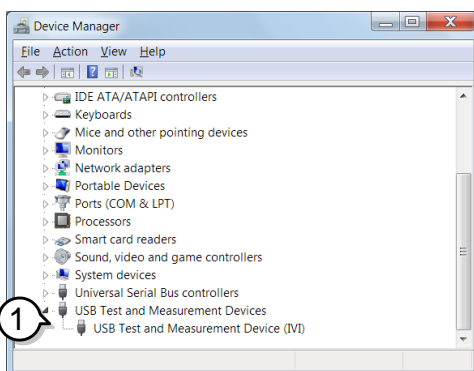

3. Start the NI Measurement and Automation Explorer (MAX) program. Using Windows, press:

Start>All Programs>National Instruments>Measurement & Automation

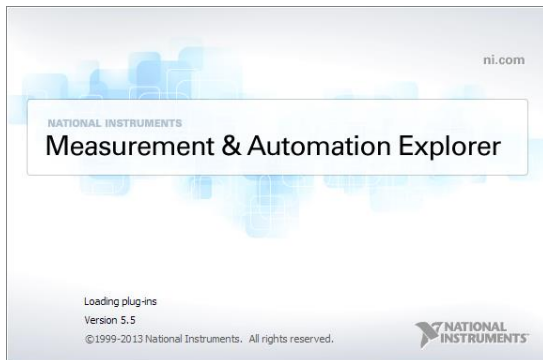

4. Select the GSP-9330 device that now appears in the *System>Devices and Interfaces > GSP9330"USBX..."* node.
5. Click on the *VISA Properties* tab on the bottom.
6. Click *Open Visa Test Panel*.

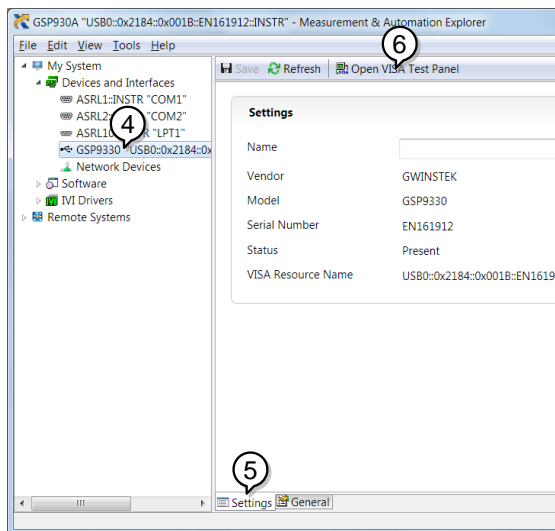

7. Click on the *I/O Settings* tab.
8. Make sure the *Enable Termination Character* check box is checked, and the terminal character is `\n` (Value: xA).
9. Click *Apply Changes*.

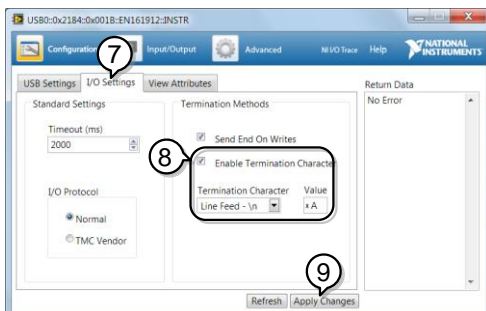

10. Click on *Input/Output*.
11. Click on the *Basic/IO* tab.
12. Enter `*IDN?` in the *Select or Enter Command* drop down box.
13. Click *Query*.
14. The `*IDN?` query will return the Manufacturer, model name, serial number and firmware version in the dialog box.

GWINSTEK,GSP9330,ENXXXXXX,V3.X.X.X

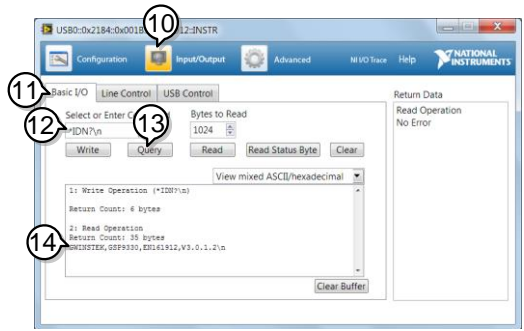

Command Syntax

Compatible Standard	IEEE488.2	Full compatibility
	SCPI, 1999	Full compatibility

Command Structure

SCPI (Standard Commands for Programmable Instruments) commands follow a tree-like structure, organized into nodes. Each level of the command tree is a node. Each keyword in a SCPI command represents each node in the command tree. Each keyword (node) of a SCPI command is separated by a colon (:).

For example, the diagram below shows an SCPI sub-structure and a command example.

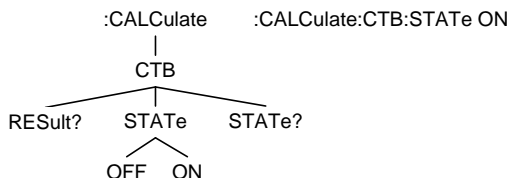

Command types

There are a number of different instrument commands and queries. A command sends instructions or data to the unit and a query receives data or status information from the unit.

Command types

Simple A single command with/without a parameter

Example *RST

Query A query is a simple or compound command followed by a question mark (?). A parameter (data) is returned.

Example :CALCulate:CSO:STATe?

Compound Two or more commands on the same command line. Compound commands are separated with either a semi-colon (;) or a semi-colon and a colon (;:).

A semi-colon is used to join two related commands, with the caveat that the last command must begin at the last node of the first command.

A semi-colon and colon are used to combine two commands from different nodes.

Example :calc:ctb:stat on,result?

Command Forms Commands and queries have two different forms, long and short. The command syntax is written with the short form of the command in capitals and the remainder (long form) in lower case.

The commands can be written in capitals or lower-case, just so long as the short or long forms are complete. An incomplete command will not be recognized.

Below are examples of correctly written commands.

Long form	:CALCulate:ACPR:STATE? :calculate:acpr:state? :CALCULATE:ACPR:STATE?
Short form	:CALC:ACPR:STAT? :calc:acpr:stat?

Square Brackets Commands that contain square brackets indicate that the contents are optional. The function of the command is the same with or without the square bracketed items, as shown below.

Both “:OUTPut[:STATe]?” and “:OUTPut?” are both valid forms.

Command Format

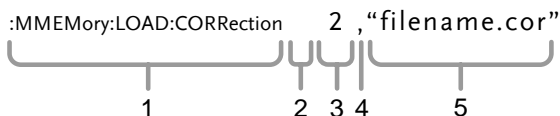

- | | |
|-------------------|--|
| 1. Command header | 4. Comma (no space before/after comma) |
| 2. Space | 5. Parameter 2 |
| 3. Parameter 1 | |

Common Input Parameters	Type	Description	Example
	<Boolean>	Boolean logic	0, 1
	<Binary>	Binary data	#B0101010001
	<Hexadecimal>	Hexadecimal data	#H2345ACDF
	<NR1>	integers	0, 1, 2, 3
	<NR2>	decimal numbers	0.1, 3.14, 8.5
	<NR3>	floating point	4.5e-1, 8.25e+1
	<NRf>	any of NR1, 2, 3	1, 1.5, 4.5e-1
	<freq>	Input: <NRf> + unit Unit = kHz, MHz, GHz. Note: The unit can be omitted (unit defaults to Hz). Return: <NR3> 2.5e+5 Note: Units = Hz.	2.5 mhz
	<limit num>	<NR1>	
	<point>	<NR1>	
	<offset>	Input: <NRf> + unit Note: The unit can be omitted (unit defaults to dB). Return: <NR3> 3.0e+1 Note: Units = dB.	30 db
	<rel_ampl>	Input: <NRf> + unit Note: The unit can be omitted (unit defaults to dB).	20 db

	Return:	
	<NR3>	2.0e+1
	Note:	Units = dB.
<ampl>	Input:	30 mv
		NR3 +unit type
	Note:	The unit can be omitted. (Unit defaults to current y-axis unit).
	Return:	
	<NR3>	3.0e-2
	Note:	Units = current y axis unit.
<trace name>	<NR1>	trace1
<time>	Input:	
	<NR3> + unit	2.3e-6 ms
	Unit =	ms, ns, ps, ks
	Note:	The unit can be omitted (unit defaults to seconds).
	Return:	
	<NR3>	3.0e-2
	Note:	Units = seconds.
<character data>	<Character data>	ON
<file name>	<Data string>	"QuickJpg2.jpg"
<pixel data>	<arbitrary block data>	#<nonzero digit><digits><8 bit data bytes>

Note:

<digits> represents the data block length descriptor. Expressed as an integer number equal to the total number of <8 bit data bytes> that follows.

<nonzero digit> represents the number of digits that are part of the data block length descriptor.

Example:

#41202<8 bit data bytes>

4 digits will be part of the data block length descriptor and therefore 1202 <8 bit data bytes> will follow.

Message
Terminator

LF

Line feed code (0x0A)

Status Registers

Status Registers Overview

Description

The status registers are used to determine the status of the spectrum analyzer. The status registers maintain the status of the pass/fail limits, trigger status and other operation statuses.

The status registers are arranged in a number of groups:

- *Questionable Status Registers*
- *Standard Event Status Registers*
- *Operation Status Registers*
- *Status Byte Register*
- *Service Request Enable Register*
- *Error/Event Queue*
- *Output Buffer*

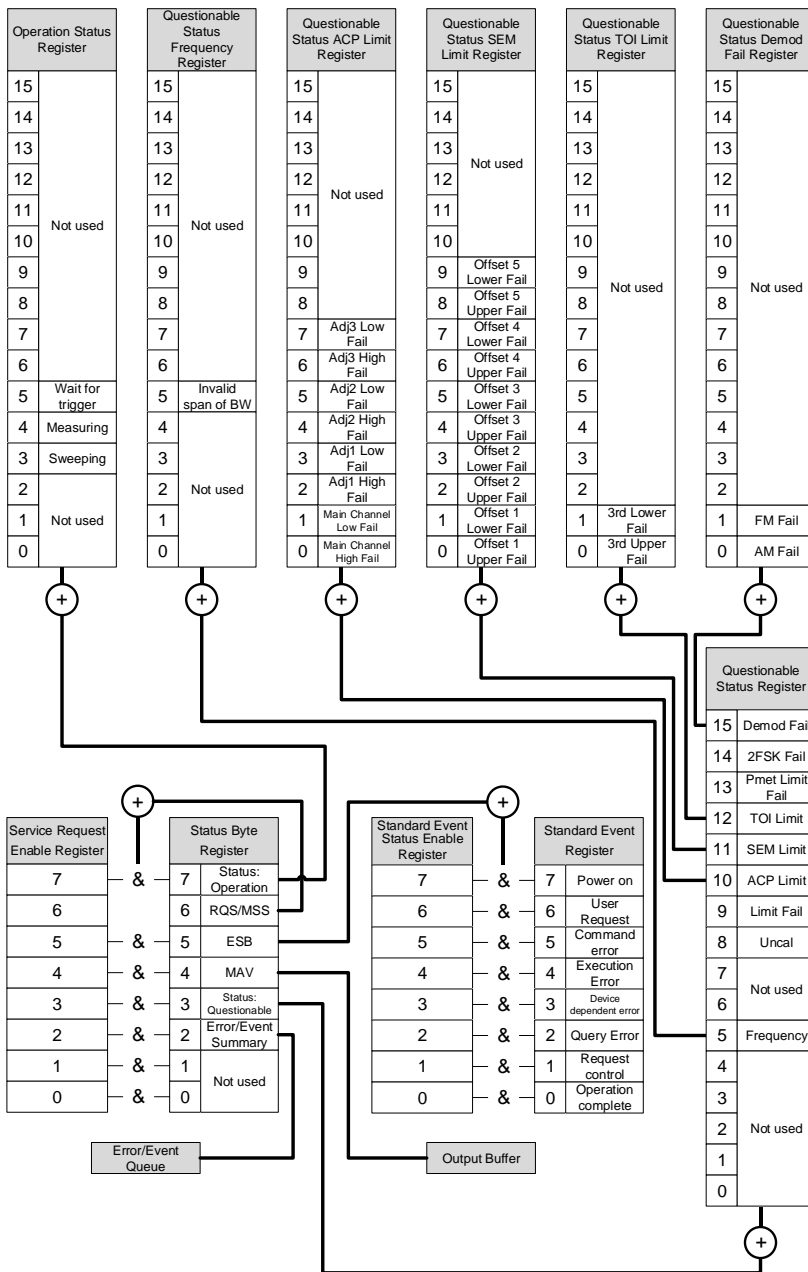

Status Register Structure	<p>Each status register (excluding the status byte register) is divided into a number of register structures:</p> <ul style="list-style-type: none">• <i>Condition register</i>• <i>Positive transition register</i>• <i>Negative transition register</i>• <i>Event Register</i>• <i>Event Enable Register</i>
Condition Registers	<p>The condition registers report the state of the GSP-9330. Condition registers can only be read.</p>
PTR Registers	<p>The positive transition registers are used to filter for events that occur from a negative to a positive transition.</p>
NTR Registers	<p>The negative transition registers are used to filter for events that occur from a positive to negative transition.</p>
Event Registers	<p>The PTR/NTP registers dictate the type transition conditions that will set the corresponding bits in the event registers. The event registers can only be read. Reading an event register will clear it.</p>
Event Enable Registers	<p>The event enable registers determine which events in the corresponding event registers will set the summary bits in a higher-order register.</p>

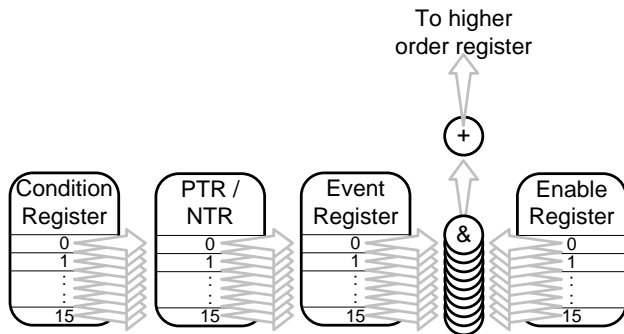

Status Byte Register (STB)

Overview

The Status Byte register consolidates the status events of all the status registers. The Status Byte register can be cleared with the *CLS command.

Any bits set in the Status byte register acts as a summary register for all the other status registers and indicates if there is a service request, an error in the Error Queue or data in the Output Queue. Reading the Status Byte register will reset the register to 0.

The Service Request Enable Register controls which bits in the Status Byte Register are able to generate service requests.

Bit Summary

Bit	Weight	Description
2	4	Error/Event Queue Summary bit: This bit is set when there is a message in the error queue.
3	8	Questionable Status Summary Bit: This is the summary bit for the Questionable Status Register.
4	16	MAV: This bit is set when there is a message in the output queue.

5	32	ESB: This is the summary bit for the Standard Event Register.
6	64	MSS/RQS: The MSS bit is the summary bit for the Service Request Enable Register. The RQS bit is set to 1 when the MSS bit is set to 1.
7	128	Operation Status Summary Bit: This is the summary bit for the Operation Status Register.

Standard Event Status Register (ESR)

Overview The Standard Event Status Register Group indicates if any errors have occurred or fail limits tripped. Reading this register will clear the register.

Bit Summary	Bit	Weight	Description
	2	4	Query Error: When a query error has occurred, this bit is set to 1.
	3	8	Device-Specific Error: When a device dependent error has occurred, this bit is set to 1.
	4	16	Execution Error: When an execution error has occurred, this bit is set to 1.
	5	32	Command Error: When a command error has occurred, this bit is set to 1.
	6	64	User Request: When a panel key is pressed, this bit is set to 1.
	7	128	Power On: When the instrument is turned off → on, this bit is set to 1.

Operation Status Register

Overview The Operation Status Register Group indicates the operating status of the GSP-9330.

Bit Summary	Bit	Weight	Description
	3	8	Sweeping: Indicates that a sweep is in progress.
	4	16	Measuring: The instrument is currently performing a measurement.
	5	32	Waiting for Trigger: The instrument is in a “wait for trigger” state.

Questionable Status Register

Overview The Questionable Status Register Group indicates if any limits have been tripped.

Bit Summary	Bit	Weight	Description
	5	32	Frequency Status Summary Bit: This is the summary bit of the Frequency Status Register.
	8	256	Uncal: This bit is set when a signal level occurs because the sweep is too fast.
	9	512	Limit fail: This bit is set to 1 when the limit line has been violated.
	10	1024	ACP Limit Status Summary Bit: This is the summary bit for the ACP Limit Status Register.
	11	2048	SEM Limit Status Summary Bit: This is the summary bit for the SEM Limit Status Register.
	12	4096	TOI Limit Status Summary Bit: This is the summary bit for the TOI Limit Status Register.
	13	8192	Pmet Limit Fail: This bit is set to 1 when the power meter limit has been violated.

- 14 16384 2FSK Fail: This bit is set to 1 when the 2FSK fail conditions are met.
- 15 32768 Demod Fail: This is the summary bit for the Demod Fail Register.

Questionable Status Frequency Register

Overview The Questionable Status Frequency Register indicates if the span or BW settings are invalid.

Bit Summary	Bit	Weight	Description
	5	32	Invalid Span or BW: This bit is set to 1 when there is an invalid span or bandwidth (setting) during the frequency count.

Questionable Status ACP Limit Register

Overview The Questionable Status ACP Limit Register Group indicates if any adjacent channel limits have been tripped.

Bit Summary	Bit	Weight	Description
	0	1	Main Channel High Fail: This bit is set to 1 when the Main CH HLimit has been violated.
	1	2	Main Channel Low Fail: This bit is set to 1 when the Main CH LLimit has been violated.
	2	4	Adj1 High Fail: This bit is set to 1 when the ADJCH 1 HLimit has been violated.
	3	8	Adj1 Low Fail: This bit is set to 1 when the ADJCH 1 LLimit has been violated.
	4	16	Adj2 High Fail: This bit is set to 1 when the ADJCH 2 HLimit has been violated.
	5	32	Adj2 Low Fail: This bit is set to 1 when the ADJCH 2 LLimit has been violated.
	6	64	Adj3 High Fail: This bit is set to 1 when the ADJCH 3 HLimit has been violated.
	7	128	Adj3 Low Fail: This bit is set to 1 when the ADJCH 3 LLimit has been violated.

Questionable Status SEM Limit Register

Overview The Questionable Status SEM Limit Register Group indicates if any of the SEM offset limits have been tripped.

Bit Summary	Bit	Weight	Description
	0	1	Offset 1 Upper Fail: This bit is set to 1 when the SEM Offset 1 upper limit has been violated.
	1	2	Offset 1 Lower Fail: This bit is set to 1 when the SEM Offset 1 lower limit has been violated.
	2	4	Offset 2 Upper Fail: This bit is set to 1 when the SEM Offset 2 upper limit has been violated.
	3	8	Offset 2 Lower Fail: This bit is set to 1 when the SEM Offset 2 lower limit has been violated.
	4	16	Offset 3 Upper Fail: This bit is set to 1 when the SEM Offset 3 upper limit has been violated.
	5	32	Offset 3 Lower Fail: This bit is set to 1 when the SEM Offset 3 lower limit has been violated.
	6	64	Offset 4 Upper Fail: This bit is set to 1 when the SEM Offset 4 upper limit has been violated.
	7	128	Offset 4 Lower Fail: This bit is set to 1 when the SEM Offset 4 lower limit has been violated.
	8	256	Offset 5 Upper Fail: This bit is set to 1 when the SEM Offset 5 upper limit has been violated.
	9	512	Offset 5 Lower Fail: This bit is set to 1 when the SEM Offset 5 lower limit has been violated.

Questionable Status TOI Limit Register

Overview The Questionable Status TOI Limit Register Group indicates if the 3rd Order Upper or Lower limit has been tripped.

Bit Summary	Bit	Weight	Description
	0	1	3rd Upper Fail: This bit is set to 1 when the 3rd Order Upper limit has been tripped.
	1	2	3rd Lower Fail: This bit is set to 1 when the 3rd Order Lower limit has been tripped.

Questionable Status Demod Fail Register

Overview The Questionable Status Demod Fail Register Group indicates if pass/fail limit has been tripped for either AM or FM analysis.

Bit Summary	Bit	Weight	Description
	0	1	AM Fail: This bit is set to 1 when the limit has been tripped for AM depth, carrier offset or carrier power.
	1	2	FM Fail: This bit is set to 1 when the limit has been tripped for FM frequency deviation, carrier offset or carrier power.

Command List

SCPI Commands	*CLS	77
	*IDN?	77
	*ESE	78
	*ESR?	78
	*OPC	78
	*RST	79
	*SRE	79
	*STB?	79
	*TST?	79
	*WAI	80

CALCulate Commands	:CALCulate:ACPR:ACHannel<n>:HLIMit:FAIL?	83
	:CALCulate:ACPR:ACHannel<n>:LLIMit:FAIL?	83
	:CALCulate:ACPR:ACHannel<n>:LOWer?	84
	:CALCulate:ACPR:ACHannel<n>:UPPer?	84
	:CALCulate:ACPR:ACHannel<n>:STATe	84
	:CALCulate:ACPR:CHANnel:HLIMit:FAIL?	85
	:CALCulate:ACPR:CHANnel:LLIMit:FAIL?	85
	:CALCulate:ACPR:CHPower?	85
	:CALCulate:ACPR:STATe	86
	:CALCulate:BFSK:LIMit:STATe	86
	:CALCulate:BFSK:LIMit:FAIL?	87
	:CALCulate:BFSK:LIMit:FDEVIation	87
	:CALCulate:BFSK:LIMit:CARRier:OFFSet	87
	:CALCulate:BFSK:LIMit:HIGH	88
	:CALCulate:BFSK:LIMit:LOW	88
	:CALCulate:BFSK:REStart	88
	:CALCulate:BFSK:RESult?	89
	:CALCulate:BFSK:STATe	89
	:CALCulate:CNR:RESult?	89
	:CALCulate:CNR:STATe	90
	:CALCulate:CSO:RESult?	90
	:CALCulate:CSO:STATe	90
	:CALCulate:CTB:RESult?	91
	:CALCulate:CTB:STATe	91
	:CALCulate:CTB:REStart	91
	:CALCulate:DELTamarker<n>:PAIR:SPAN	92
	:CALCulate:DELTamarker<n>:PAIR:CENTer	92

:CALCulate:DELTamarker<n>:X.....	92
:CALCulate:DELTamarker<n>:Y?	93
:CALCulate:DEMod:AM:RESult:CURRent?	93
:CALCulate:DEMod:AM:RESult:MINimum?	93
:CALCulate:DEMod:AM:RESult:MAXimum?	94
:CALCulate:DEMod:AM:STATe	94
:CALCulate:DEMod:EARPhone:STATe	95
:CALCulate:DEMod:FM:RESult:CURRent?	95
:CALCulate:DEMod:FM:RESult:MINimum?	95
:CALCulate:DEMod:FM:RESult:MAXimum?	96
:CALCulate:DEMod:FM:STATe	96
:CALCulate:DEMod:LIMit:AMDepth.....	97
:CALCulate:DEMod:LIMit:FDEVIation.....	97
:CALCulate:DEMod:LIMit:CARRier:OFFSet	97
:CALCulate:DEMod:LIMit:CARRier:POWer	98
:CALCulate:DEMod:LIMit:FAIL?	98
:CALCulate:DEMod:LIMit:STATe	99
:CALCulate:DEMod:ASK:STATe	99
:CALCulate:DEMod:FSK:STATe.....	100
:CALCulate:DEMod:ASK:RESult:CURRent?	100
:CALCulate:DEMod:ASK:RESult:MINimum?	100
:CALCulate:DEMod:ASK:RESult:MAXimum?	101
:CALCulate:DEMod:FSK:RESult:CURRent?	101
:CALCulate:DEMod:FSK:RESult:MINimum?.....	101
:CALCulate:DEMod:FSK:RESult:MAXimum?	102
:CALCulate:DEMod:RESet	102
:CALCulate:HARMonic:DISToRtion?	102
:CALCulate:HARMonic:RESult?	103
:CALCulate:HARMonic:STATe.....	103
:CALCulate:IQ:IFBW.....	103
:CALCulate:IQ:RECORDing:TIME.....	104
:CALCulate:IQ:STATe.....	104
:CALCulate:JITTer:STATe.....	104
:CALCulate:JITTer:CARRier:POWer?.....	105
:CALCulate:JITTer:PHASe?.....	105
:CALCulate:JITTer:TIME?.....	105
:CALCulate:LIMit<n>:CLEar.....	106
:CALCulate:LIMit<n>:DATA	106
:CALCulate:LIMit:FAIL?	106
:CALCulate:LIMit:LOW	107
:CALCulate:LIMit:HIGH	107
:CALCulate:LIMit<n>:MARKer	107
:CALCulate:LIMit:MODE	107
:CALCulate:LIMit:STATe	108

:CALCulate:LIMit<n>:TRACe	108
:CALCulate:LIMit:TYPE.....	109
:CALCulate:MARKer:AOff	109
:CALCulate:MARKer<n>:FCOunt:RESolution	109
:CALCulate:MARKer<n>:FCOunt:RESolution	
:AUTO	110
:CALCulate:MARKer<n>:FCOunt:STATe	110
:CALCulate:MARKer<n>:FCOunt:X?	111
:CALCulate:MARKer<n>:NOISe:STATe	111
:CALCulate:MARKer<n>:NOISe:Y?	111
:CALCulate:MARKer<n>:VSWR:STATe	112
:CALCulate:MARKer<n>:VSWR:Y?	112
:CALCulate:MARKer<n>:PEAK	112
:CALCulate:MARKer:PEAK:CTRack:STATe	113
:CALCulate:MARKer:PEAK:DATA?	113
:CALCulate:MARKer:PEAK:EXCursion	114
:CALCulate:MARKer:PEAK:SORT:TYPE.....	114
:CALCulate:MARKer:PEAK:TABLE:STATe	114
:CALCulate:MARKer:PEAK:THReshold.....	115
:CALCulate:MARKer:PEAK:THReshold:STATe.....	115
:CALCulate:MARKer<n>:SET	116
:CALCulate:MARKer<n>:STATe	116
:CALCulate:MARKer:TABLE:STATe.....	116
:CALCulate:MARKer<n>:TRACe.....	117
:CALCulate:MARKer<n>:TRACe:AUTO.....	117
:CALCulate:MARKer<n>:TYPE	118
:CALCulate:MARKer<n>:X	118
:CALCulate:MARKer<n>:Y?	118
:CALCulate:MATH:PDIF	119
:CALCulate:MATH:LDIF	119
:CALCulate:MATH:LOFF	119
:CALCulate:NDB:STATe.....	120
:CALCulate:NDB:BANDwidth BWIDth?.....	120
:CALCulate:NORMalize:STATe.....	121
:CALCulate:OCBW:STATe	121
:CALCulate:OCBW:BANDwidth BWIDth?	121
:CALCulate:OCBW:CHPoweR?.....	122
:CALCulate:OCBW:POWeR?.....	122
:CALCulate:OCBW:PSDeNsity?.....	122
:CALCulate:P1DB:STATe.....	123
:CALCulate:P1DB:NORMalize:STATe.....	123
:CALCulate:P1DB:GAIN:AVErAge?	123
:CALCulate:P1DB:GAIN:RESult?	124
:CALCulate:P1DB:RESult?	124

	:CALCulate:PMETer:POWER?.....	124
	:CALCulate:PMETer:LIMit:STATe.....	125
	:CALCulate:PMETer:LIMit:FAIL?	125
	:CALCulate:SEM:STATe	125
	:CALCulate:SEM:OFFSet<n>:RESult?	126
	:CALCulate:TOI:DIFFerential?	126
	:CALCulate:TOI:FREQuency:DIFFerential?	127
	:CALCulate:TOI:LIMit:STATe	127
	:CALCulate:TOI:RESult?	127
	:CALCulate:TOI:STATe	128
CONFigure	:CONFigure:MODE	129
Commands		
DISPlay	:DISPlay:BRIGhtness	132
Commands	:DISPlay:ENABle.....	132
	:DISPlay:DEMod[:WINDow]:SYMBol:DATA?	132
	:DISPlay:DEMod[:WINDow]:TRACe:X[:SCALe]	
	:AUTO	133
	:DISPlay:DEMod[:WINDow]:TRACe:X[:SCALe]	
	:PDIVision.....	133
	:DISPlay:DEMod[:WINDow]:TRACe:X[:SCALe]	
	:RPOSition.....	134
	:DISPlay:DEMod[:WINDow]:TRACe:X[:SCALe]	
	:RVALue	134
	:DISPlay:DEMod[:WINDow]:TRACe:Y [:SCALe]	
	:AUTO	134
	:DISPlay:DEMod[:WINDow]:TRACe:Y[:SCALe]	
	:PDIVision.....	135
	:DISPlay:DEMod[:WINDow]:TRACe:Y[:SCALe]	
	:RPOSition.....	135
	:DISPlay:DEMod[:WINDow]:TRACe:Y[:SCALe]	
	:RVALue	135
	:DISPlay:DEMod[:WINDow]:VIEW	136
	:DISPlay:IQ[:WINDow]:TRACe:Y[:SCALe]	
	:PDIVision.....	136
	:DISPlay:IQ[:WINDow]:TRACe:Y[:SCALe]:RLEVel ..	136
	:DISPlay:IQ[:WINDow]:TRACe:Y[:SCALe]	
	:RPOSition.....	137
	:DISPlay:P1DB[:WINDow]:TRACe:Y[:SCALe]	
	:LEVel?.....	137
	:DISPlay[:WINDow]:NORMal	137

:DISPlay[:WINDow]:SPECtrogram	138
:DISPlay[:WINDow]:SPECtrogram:DELTaMarker:X ..	138
:DISPlay[:WINDow]:SPECtrogram:DELTaMarker:Y ..	138
:DISPlay[:WINDow]:SPECtrogram	
:DELTaMarker:FREQuency?	139
:DISPlay[:WINDow]:SPECtrogram	
:DELTaMarker:AMPLitude?	139
:DISPlay[:WINDow]:SPECtrogram	
:DELTaMarker:INVerse:TIME?	139
:DISPlay[:WINDow]:SPECtrogram	
:DELTaMarker:TIME?	140
:DISPlay[:WINDow]:SPECtrogram:MARKer:STATe ..	140
:DISPlay[:WINDow]:SPECtrogram:MARKer:X	140
:DISPlay[:WINDow]:SPECtrogram:MARKer:Y	141
:DISPlay[:WINDow]:SPECtrogram:MARKer	
:FREQuency?	141
:DISPlay[:WINDow]:SPECtrogram:MARKer	
:AMPLitude?	141
:DISPlay[:WINDow]:SPECtrogram:MARKer:TIME? ..	142
:DISPlay[:WINDow]:SPLit:NORMal:ALTeRnate	142
:DISPlay[:WINDow]:SPLit:NORMal:ACTive	142
:DISPlay[:WINDow]:SPLit:SPECtrogram	143
:DISPlay[:WINDow]:SPLit:TOPO	143
:DISPlay[:WINDow]:TOPO	143
:DISPlay[:WINDow]:TOPO:MARKer:PERCent?	143
:DISPlay[:WINDow]:TOPO:MARKer:X	144
:DISPlay[:WINDow]:TOPO:MARKer:Y	144
:DISPlay[:WINDow]:TOPO:MARKer: FREQuency? ..	144
:DISPlay[:WINDow]:TOPO:MARKer: AMPLitude? ..	145
:DISPlay[:WINDow]:TOPO:MARKer:STATe	145
:DISPlay[:WINDow]:TOPO:DELTaMarker:X	145
:DISPlay[:WINDow]:TOPO:DELTaMarker:Y	146
:DISPlay[:WINDow]:TOPO:DELTaMarker	
:FREQuency?	146
:DISPlay[:WINDow]:TOPO:DELTaMarker	
:AMPLitude?	146
:DISPlay[:WINDow]:TOPO:DELTaMarker	
:PERCent?	147
:DISPlay[:WINDow]:TRACe<n>:MODE	147
:DISPlay[:WINDow]:TRACe<n>:MODE:MAXHold? ..	147
:DISPlay[:WINDow]:TRACe:Y:DLINe	148
:DISPlay[:WINDow]:TRACe:Y:DLINe:STATe	148
:DISPlay[:WINDow]:TRACe:Y[:SCALe]:AUTO	148
:DISPlay[:WINDow]:TRACe:Y[:SCALe]:NRLevel	149

	:DISPlay[:WINDow]:TRACe:Y[:SCALe]:NRPosition..	149
	:DISPlay[:WINDow]:TRACe:Y[:SCALe]: PDIVision:..	149
	:DISPlay[:WINDow]:TRACe:Y[:SCALe]:POSition.....	150
	:DISPlay[:WINDow]:TRACe:Y[:SCALe]:RLEVel	150
	:DISPlay[:WINDow]:TRACe:Y[:SCALe]	
	:RLEVel:OFFSet	151
	:DISPlay[:WINDow]:TRACe:Y[:SCALe]:SPACing.....	151
	:DISPlay[:WINDow]:TRACe:Y[:SCALe]:STATe	151
INITiate	:INITiate:CONTinuous	153
Commands	:INITiate[:IMMEdiate]	153
INPut	:INPut:ATTenuation	154
Commands	:INPut:ATTenuation:AUTO	154
	:INPut:IMPedance	155
	:INPut:OFFSet	155
MMEMory	:MMEMory:CATalog?	156
commands	:MMEMory:CDIRectory.....	157
	:MMEMory:COpy	157
	:MMEMory:DELete	158
	:MMEMory:DESTination.....	158
	:MMEMory:LOAD:CORRection	159
	:MMEMory:LOAD:LIMit	159
	:MMEMory:LOAD:PMETer	159
	:MMEMory:LOAD:SEQuence	159
	:MMEMory:LOAD:STATe.....	160
	:MMEMory:LOAD:TRACe	160
	:MMEMory:MOVE	160
	:MMEMory:REName.....	161
	:MMEMory:STORe:ASK	161
	:MMEMory:STORe:CORRection.....	161
	:MMEMory:STORe:FSK	162
	:MMEMory:STORe:IQ	162
	:MMEMory:STORe:LIMit.....	162
	:MMEMory:STORe:PMETer	163
	:MMEMory:STORe:SCReen	163
	:MMEMory:STORe:SEQuence	163
	:MMEMory:STORe:STATe	163
	:MMEMory:STORe:TRACe	164

OUTPut	:OUTPut[:STATe]	165
commands		
SENSe	[:SENSe]:ACPR:ACHannel<n>:BANDwidth	
commands	BWIDth	169
	[:SENSe]:ACPR:ACHannel<n>:HLIMit	169
	[:SENSe]:ACPR:ACHannel<n>:LLIMit	170
	[:SENSe]:ACPR:ACHannel<n>:OFFSet	170
	[:SENSe]:ACPR:BANDwidth BWIDth	170
	[:SENSe]:ACPR:HLIMit	171
	[:SENSe]:ACPR:LLIMit	171
	[:SENSe]:ACPR:HELP:STATe	171
	[:SENSe]:ACPR:SPACe	172
	[:SENSe]:ASET:AMPLitude	172
	[:SENSe]:ASET:AMPLitude:AUTO	172
	[:SENSe]:ASET:RUN	173
	[:SENSe]:ASET:SPAN	173
	[:SENSe]:ASET:SPAN:AUTO	173
	[:SENSe]:AVERage:COUNT	174
	[:SENSe]:AVERage:STATe	174
	[:SENSe]:AVERage:TYPE	174
	[:SENSe]:BANDwidth BWIDth[:RESolution]	175
	[:SENSe]:BANDwidth BWIDth[:RESolution]:AUTO	175
	[:SENSe]:BANDwidth BWIDth:VIDeo	175
	[:SENSe]:BANDwidth BWIDth:VIDeo:AUTO	176
	[:SENSe]:CHANnel:SPACe:DOWN	176
	[:SENSe]:CHANnel:SPACe:UP	176
	[:SENSe]:CNR:CHANnel:SPACe	177
	[:SENSe]:CNR:DELTaMarker:MODE	177
	[:SENSe]:CORRection:CSET<n>:DATA	177
	[:SENSe]:CORRection:CSET<n>:STATe	178
	[:SENSe]:CORRection:CSET<n>:DELeTe	178
	[:SENSe]:CSO:CHANnel:SPACe	178
	[:SENSe]:CTB:CHANnel:SPACe	179
	[:SENSe]:DEMod:DECode	179
	[:SENSe]:DEMod:DECode:FORMat	180
	[:SENSe]:DEMod:DECode:INVert:STATe	180
	[:SENSe]:DEMod:DEFine:CODE	180
	[:SENSe]:DEMod:DEFine:MCOunt	181
	[:SENSe]:DEMod:EARPhone:TYPE	181
	[:SENSe]:DEMod:EARPhone:VOLume	181
	[:SENSe]:DEMod:EARPhone:GAIN	182

[SENSe]:DEMod:FILTer:LPASs	182
[SENSe]:DEMod:IFBW	183
[SENSe]:DEMod:PREamble:BITS.....	183
[SENSe]:DEMod:PREamble:SYNChronous: STATe .	183
[SENSe]:DEMod:SQUelch:LEVel	184
[SENSe]:DEMod:BRATe.....	184
[SENSe]:DEMod:SYNChronous:BITS	184
[SENSe]:DEMod:SYNChronous:WORDs.....	185
[SENSe]:DETEctor[:FUNCTion]	185
[SENSe]:DETEctor[:FUNCTion]:AUTO	186
[SENSe]:EMIFilter:STATe.....	186
[SENSe]:EMIFilter:BANDwidth BWIDth [:RESolution].....	187
[SENSe]:FREQuency:CENTer	187
[SENSe]:FREQuency:CENTer:STEP	187
[SENSe]:FREQuency:CENTer:STEP:AUTO.....	188
[SENSe]:FREQuency:OFFSet.....	188
[SENSe]:FREQuency:SPAN.....	188
[SENSe]:FREQuency:SPAN:FULL	189
[SENSe]:FREQuency:SPAN:PREVious.....	189
[SENSe]:FREQuency:STARt.....	189
[SENSe]:FREQuency:STOP.....	189
[SENSe]:HARMonic:FUNDamental:FREQuency	190
[SENSe]:HARMonic:NUMBER	190
[SENSe]:LIMit<n>:DELeTe	190
[SENSe]:JITTer:OFFSet:STARt.....	190
[SENSe]:JITTer:OFFSet:STOP.....	191
[SENSe]:NDB:BANDwidth BWIDth	191
[SENSe]:OCBW:BANDwidth BWIDth.....	191
[SENSe]:OCBW:PERCent.....	192
[SENSe]:OCBW:SPACe	192
[SENSe]:P1DB:AVERAge:COUNT.....	192
[SENSe]:P1DB:GAIN:OFFSet	193
[SENSe]:PMETer:FREQuency	193
[SENSe]:PMETer:HLIMit.....	193
[SENSe]:PMETer:HOLD:STATe	194
[SENSe]:PMETer:LLIMit.....	194
[SENSe]:PMETer:PSENSor:MODE.....	194
[SENSe]:PMETer:RECORDing:TIME.....	195
[SENSe]:PMETer:RECORDing:TIME:STEP	195
[SENSe]:POWer[:RF]:GAIN	195
[SENSe]:SEMAsk:BANDwidth BWIDth :INTegration.....	196
[SENSe]:SEMAsk:BANDwidth BWIDth	

[:RESolution]	196
[:SENSe]:SEMAsk:BANDwidth BWIDth	
[:RESolution]:AUTO	196
[:SENSe]:SEMAsk:CARRier:AUTO	197
[:SENSe]:SEMAsk:CARRier:CPsD	197
[:SENSe]:SEMAsk:CARRier:POWEr	198
[:SENSe]:SEMAsk:FREQuency:SPAN	198
[:SENSe]:SEMAsk:GWLan:MODulation	198
[:SENSe]:SEMAsk:HELp:STATe	199
[:SENSe]:SEMAsk:NWLan:CHANnel: BANDwidth BWIDth	199
[:SENSe]:SEMAsk:OFFSet<n>:ADDition: BANDwidth BWIDth[:RESolution]?	200
[:SENSe]:SEMAsk:OFFSet<n>:ADDition: FREQuency:STARt?	201
[:SENSe]:SEMAsk:OFFSet<n>:ADDition: FREQuency:STOP?	202
[:SENSe]:SEMAsk:OFFSet<n>:ADDition: STARt:ABSolute?	202
[:SENSe]:SEMAsk:OFFSet<n>:ADDition: STOP:ABSolute?	202
[:SENSe]:SEMAsk:OFFSet<n>:BANDwidth BWIDth[:RESolution]	203
[:SENSe]:SEMAsk:OFFSet<n>:BANDwidth BWIDth[:RESolution]:AUTO	203
[:SENSe]:SEMAsk:OFFSet<n>:FREQuency:STARt	204
[:SENSe]:SEMAsk:OFFSet<n>:FREQuency:STOP	204
[:SENSe]:SEMAsk:OFFSet<n>:STARt:ABSolute	204
[:SENSe]:SEMAsk:OFFSet<n>:STARt:RELative	205
[:SENSe]:SEMAsk:OFFSet<n>:STATe	205
[:SENSe]:SEMAsk:OFFSet<n>:STOP:ABSolute	206
[:SENSe]:SEMAsk:OFFSet<n>:STOP:ABSolute :COUple	206
[:SENSe]:SEMAsk:OFFSet<n>:STOP:RELative	206
[:SENSe]:SEMAsk:OFFSet<n>:STOP:RELative :COUple	207
[:SENSe]:SEMAsk:OFFSet<n>:TEST	207
[:SENSe]:SEMAsk:SELect	208
[:SENSe]:SEMAsk:TYPE	208
[:SENSe]:SEMAsk:W3GPP:DUPLex:TYPE	208
[:SENSe]:SEMAsk:W3GPP:FDD:ADDition:LIMit	209
[:SENSe]:SEMAsk:W3GPP:FDD:ADDition :MOPower	209
[:SENSe]:SEMAsk:W3GPP:FDD:MOPower	210

	[:SENSe]:SEMAsk:W3GPP:FDD:TRANsmit:MODE..	210
	[:SENSe]:SEMAsk:W3GPP:TDD:CHIP:RATE	210
	[:SENSe]:SEMAsk:W3GPP:TDD:MOPower.....	211
	[:SENSe]:SEMAsk:W3GPP:TDD:TRANsmit:MODE..	211
	[:SENSe]:SEMAsk:WIMax:CHANnel:	
	BANDwidth BWIDth.....	212
	[:SENSe]:SEQuence<n>:DELEte	212
	[:SENSe]:SWEep:EGATe:DELay	212
	[:SENSe]:SWEep:EGATe:LENGth.....	213
	[:SENSe]:SWEep:EGATe:STATe	213
	[:SENSe]:SWEep:MODE.....	213
	[:SENSe]:SWEep:TIME.....	214
	[:SENSe]:SWEep:TIME:AUTO.....	214
	[:SENSe]:TOI:REFerence	214
	[:SENSe]:TOI:LIMit.....	215
SOURce	:SOURce:P1DB:TYPE.....	216
commands	:SOURce:POWer[:LEVel][:IMMediate][:AMPLitude] ..	216
	:SOURce:POWer[:LEVel][:IMMediate][:AMPLitude]	
	:OFFSet.....	217
	:SOURce:POWer[:LEVel][:IMMediate][:AMPLitude]	
	:STEP	217
	:SOURce:POWer[:LEVel][:IMMediate][:AMPLitude]:	
	STEP:AUTO.....	217
	:SOURce:POWer:MODE	218
	:SOURce:POWer:SWEep.....	218
SYSTEM	:SYSTem:ALARm:STATe.....	219
commands	:SYSTem:CLOCK<n>:DATE.....	220
	:SYSTem:CLOCK<n>:MODE	220
	:SYSTem:CLOCK<n>:STATe	221
	:SYSTem:CLOCK<n>:TIME	221
	:SYSTem:COMMunicate:GPIB[:SELF]:ADDRes	221
	:SYSTem:COMMunicate:LANReset	222
	:SYSTem:COMMunicate:SERial[:RECeive]:BAUD.....	222
	:SYSTem:COMMunicate:USB:MODE.....	222
	:SYSTem:DATE.....	222
	:SYSTem:ERRor:CLEar	223
	:SYSTem:ERRor[:NEXT]?.....	223
	:SYSTem:KLOCK	223
	:SYSTem:POWer:TYPE.....	223
	:SYSTem:PRESet	224

	:SYSTem:PRESet:TYPE	224
	:SYSTem:PRESet:USER:SAVE	224
	:SYSTem:REBoot	224
	:SYSTem:SHUTdown	224
	:SYSTem:TIME.....	225
	:SYSTem:UPDate	225
	:SYSTem:VERSion:HARDware?.....	225
	:SYSTem:VERSion:SOFTware?.....	226
STATus	:STATus:OPERation:CONDition?	227
commands	:STATus:OPERation:ENABLE	228
	:STATus:OPERation[:EVENTt]?	228
	:STATus:OPERation:NTRansition	229
	:STATus:OPERation:PTRansition	229
	:STATus:QUESTionable:CONDition?	230
	:STATus:QUESTionable:ENABLE	230
	:STATus:QUESTionable[:EVENTt]?	231
	:STATus:QUESTionable:NTRansition	231
	:STATus:QUESTionable:PTRansition	232
	:STATus:QUESTionable:FREQuency:CONDition?	232
	:STATus:QUESTionable:FREQuency:ENABLE	232
	:STATus:QUESTionable:FREQuency[:EVENTt]?.....	233
	:STATus:QUESTionable:FREQuency:NTRansition	233
	:STATus:QUESTionable:FREQuency:PTRansition	233
	:STATus:QUESTionable:ACPLimit:CONDition?	234
	:STATus:QUESTionable:ACPLimit:ENABLE	234
	:STATus:QUESTionable:ACPLimit[:EVENTt]?.....	235
	:STATus:QUESTionable:ACPLimit:NTRansition.....	235
	:STATus:QUESTionable:ACPLimit:PTRansition.....	236
	:STATus:QUESTionable:SEMLimit :CONDition?	236
	:STATus:QUESTionable:SEMLimit:ENABLE?	237
	:STATus:QUESTionable:SEMLimit[:EVENTt]?	237
	:STATus:QUESTionable:SEMLimit :NTRansition	238
	:STATus:QUESTionable:SEMLimit:PTRansition	239
	:STATus:QUESTionable:TOILimit:CONDition?	239
	:STATus:QUESTionable:TOILimit:ENABLE	240
	:STATus:QUESTionable:TOILimit[:EVENTt]?	240
	:STATus:QUESTionable:TOILimit:NTRansition	240
	:STATus:QUESTionable:TOILimit:PTRansition	241
	:STATus:PRESet.....	241

TRACe	:TRACe[:DATA]?	242
commands	:PIXel? TRACe<n>	243
TRIGger	:TRIGger[:SEQuence]:DELay	245
commands	:TRIGger[:SEQuence]:DEMod:BIT:STARt	246
	:TRIGger[:SEQuence]:DEMod:BIT:STOP	246
	:TRIGger[:SEQuence]:DEMod:DELay	246
	:TRIGger[:SEQuence]:DEMod:EXTernal:SLOPe	247
	:TRIGger[:SEQuence]:DEMod:INTernal	247
	:LEVel	247
	:TRIGger[:SEQuence]:DEMod:RF:VIDeo	248
	:SLOPe	248
	:TRIGger[:SEQuence]:DEMod:VIDeo:LEVel	248
	:TRIGger[:SEQuence]:DEMod:MODE	249
	:TRIGger[:SEQuence]:DEMod:VIDeo:SLOPe	249
	:TRIGger[:SEQuence]:DEMod:SOURce	249
	:TRIGger[:SEQuence]:DEMod:TIME:STARt	250
	:TRIGger[:SEQuence]:DEMod:TIME:STOP	250
	:TRIGger[:SEQuence]:EXTernal:SLOPe	250
	:TRIGger[:SEQuence]:IQ:DELay	251
	:TRIGger[:SEQuence]:IQ:MODE	251
	:TRIGger[:SEQuence]:IQ:SOURce	251
	:TRIGger[:SEQuence]:IQ:VIDeo	252
	:LEVel	252
	:TRIGger[:SEQuence]:IQ:VIDeo	252
	:SLOPe	252
	:TRIGger[:SEQuence]:MODE	252
	:TRIGger[:SEQuence]:PMETer:SOURce	253
	:TRIGger[:SEQuence]:SOURce	253
	:TRIGger[:SEQuence]:VIDeo:FREQuency	253
	:TRIGger[:SEQuence]:VIDeo:LEVel	254
	:TRIGger[:SEQuence]:VIDeo:SLOPe	254
UNIT commands	:UNIT:PMETer:POWer	255
	:UNIT:POWer	255

SCPI Commands

*CLS	77
*IDN?	77
*ESE	78
*ESR?	78
*OPC	78
*RST	79
*SRE	79
*STB?	79
*TST?	79
*WAI	80

*CLS



Description The *CLS command clears the Standard Event Status, Operation Status and Questionable Status registers. The corresponding Enable registers in each of the above registers are not cleared.

If a <NL> newline code immediately precedes a *CLS command, the Error Que and the MAV bit in the Status Byte Register is also cleared.

Syntax *CLS

*IDN?

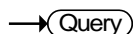

Description Queries the manufacturer, model number, serial number, and firmware version of the instrument.

Query Syntax *IDN?

Return parameter	<character data>	Returns the instrument identification as a character data in the following format: GWINSTEK,GSP-9330,XXXXXXXX,T.X.X.X.X Manufacturer: GWINSTEK Model number : GSP-9330 Serial number : XXXXXXXX Firmware version : V3.X.X.X
------------------	------------------	--

(Set) →

***ESE**

→ (Query)

Description	Sets or queries the Standard Event Status Enable register.	
Syntax	*ESE <NR1>	
Query Syntax	*ESE?	
Parameter	<NR1>	0~255
Return parameter	<NR1>	Returns the bit sum of the Standard Event Status Enable register.

***ESR?**

→ (Query)

Description	Queries the Standard Event Status register. The Event Status register is cleared after it is read.	
Query Syntax	*ESR?	
Return parameter	<NR1>	Returns the bit sum of the Standard Event Status register and clears the register.

(Set) →

***OPC**

→ (Query)

Description	The *OPC command sets the OPC bit (bit0) of the Standard Event Status Register when all current commands have been processed. The *OPC? Query returns 1 when all the outstanding commands have completed.	
-------------	--	--

Syntax	*OPC
--------	------

Query Syntax	*OPC?
--------------	-------

Return parameter 1 Returns 1 when all the outstanding commands have completed.

***RST** (Set) →

Description *RST will perform a factory reset.

Syntax *RST

(Set) →

***SRE** → (Query)

Description Sets or queries the Service Request Enable register. The Service Request Enable register determines which registers of the Status Byte register are able to generate service requests.

Syntax *SRE <NR1>

Query Syntax *SRE?

Parameter <NR1> 0~255

Return parameter <NR1> Returns the bit sum of the Service Request Enable register.

***STB?** → (Query)

Description Queries the bit sum of the Status Byte register with MSS (Master summary Status).

Query Syntax *STB?

Return parameter <NR1> Returns the bit sum of the Status Byte register with the MSS bit (bit 6).

***TST?** → (Query)

Description Returns the result of a self-test. The GSP-9330 does not support performing a selftest and thus will always return "0" for this query.

Query Syntax *TST?

Return parameter 0 Returns "0"

*WAI



Description Prevents any other commands or queries from being executed until all outstanding commands have completed.

Syntax *WAI

CALCulate Commands

:CALCulate:ACPR:ACHannel<n>:HLIMit:FAIL?	83
:CALCulate:ACPR:ACHannel<n>:LLIMit:FAIL?	83
:CALCulate:ACPR:ACHannel<n>:LOWer?	84
:CALCulate:ACPR:ACHannel<n>:UPPer?	84
:CALCulate:ACPR:ACHannel<n>:STATe	84
:CALCulate:ACPR:CHANnel:HLIMit:FAIL?	85
:CALCulate:ACPR:CHANnel:LLIMit:FAIL?	85
:CALCulate:ACPR:CHPower?	85
:CALCulate:ACPR:STATe	86
:CALCulate:BFSK:LIMit:STATe	86
:CALCulate:BFSK:LIMit:FAIL?	87
:CALCulate:BFSK:LIMit:FDEVIation	87
:CALCulate:BFSK:LIMit:CARRier:OFFSet	87
:CALCulate:BFSK:LIMit:HIGH	88
:CALCulate:BFSK:LIMit:LOW	88
:CALCulate:BFSK:REStart	88
:CALCulate:BFSK:RESult?	89
:CALCulate:BFSK:STATe	89
:CALCulate:CNR:RESult?	89
:CALCulate:CNR:STATe	90
:CALCulate:CSO:RESult?	90
:CALCulate:CSO:STATe	90
:CALCulate:CTB:RESult?	91
:CALCulate:CTB:STATe	91
:CALCulate:CTB:REStart	91
:CALCulate:DELTamarker<n>:PAIR:SPAN	92
:CALCulate:DELTamarker<n>:PAIR:CENTer	92
:CALCulate:DELTamarker<n>:X	92
:CALCulate:DELTamarker<n>:Y?	93
:CALCulate:DEMod:AM:RESult:CURRent?	93
:CALCulate:DEMod:AM:RESult:MINimum?	93

:CALCulate:DEMod:AM:RESult:MAXimum?	94
:CALCulate:DEMod:AM:STATe	94
:CALCulate:DEMod:EARPhone:STATe	95
:CALCulate:DEMod:FM:RESult:CURREnt?	95
:CALCulate:DEMod:FM:RESult:MINimum?	95
:CALCulate:DEMod:FM:RESult:MAXimum?	96
:CALCulate:DEMod:FM:STATe	96
:CALCulate:DEMod:LIMit:AMDepth	97
:CALCulate:DEMod:LIMit:FDEVIation	97
:CALCulate:DEMod:LIMit:CARRier:OFFSet	97
:CALCulate:DEMod:LIMit:CARRier:POWer	98
:CALCulate:DEMod:LIMit:FAIL?	98
:CALCulate:DEMod:LIMit:STATe	99
:CALCulate:DEMod:ASK:STATe	99
:CALCulate:DEMod:FSK:STATe	100
:CALCulate:DEMod:ASK:RESult:CURREnt?	100
:CALCulate:DEMod:ASK:RESult:MINimum?	100
:CALCulate:DEMod:ASK:RESult:MAXimum?	101
:CALCulate:DEMod:FSK:RESult:CURREnt?	101
:CALCulate:DEMod:FSK:RESult:MINimum?	101
:CALCulate:DEMod:FSK:RESult:MAXimum?	102
:CALCulate:DEMod:RESet	102
:CALCulate:HARMonic:DISToRtion?	102
:CALCulate:HARMonic:RESult?	103
:CALCulate:HARMonic:STATe	103
:CALCulate:IQ:IFBW	103
:CALCulate:IQ:RECOding:TIME	104
:CALCulate:IQ:STATe	104
:CALCulate:JITTer:STATe	104
:CALCulate:JITTer:CARRier:POWer?	105
:CALCulate:JITTer:PHASe?	105
:CALCulate:JITTer:TIME?	105
:CALCulate:LIMit<n>:CLear	106
:CALCulate:LIMit<n>:DATA	106
:CALCulate:LIMit:FAIL?	106
:CALCulate:LIMit:LOW	107
:CALCulate:LIMit:HIGH	107
:CALCulate:LIMit<n>:MARKer	107
:CALCulate:LIMit:MODE	107
:CALCulate:LIMit:STATe	108
:CALCulate:LIMit<n>:TRACe	108
:CALCulate:LIMit:TYPE	109
:CALCulate:MARKer:AOFF	109
:CALCulate:MARKer<n>:FCOunt:RESolution	109

:CALCulate:MARKer<n>:FCOunt:RESolution	
:AUTO	110
:CALCulate:MARKer<n>:FCOunt:STATe	110
:CALCulate:MARKer<n>:FCOunt:X?	111
:CALCulate:MARKer<n>:NOISe:STATe.....	111
:CALCulate:MARKer<n>:NOISe:Y?	111
:CALCulate:MARKer<n>:VSWR:STATe	112
:CALCulate:MARKer<n>:VSWR:Y?	112
:CALCulate:MARKer<n>:PEAK	112
:CALCulate:MARKer:PEAK:CTRack:STATe	113
:CALCulate:MARKer:PEAK:DATA?	113
:CALCulate:MARKer:PEAK:EXCursion	114
:CALCulate:MARKer:PEAK:SORT:TYPE.....	114
:CALCulate:MARKer:PEAK:TABLE:STATe	114
:CALCulate:MARKer:PEAK:THReshold.....	115
:CALCulate:MARKer:PEAK:THReshold:STATe.....	115
:CALCulate:MARKer<n>:SET	116
:CALCulate:MARKer<n>:STATe.....	116
:CALCulate:MARKer:TABLE:STATe.....	116
:CALCulate:MARKer<n>:TRACe.....	117
:CALCulate:MARKer<n>:TRACe:AUTO	117
:CALCulate:MARKer<n>:TYPE.....	118
:CALCulate:MARKer<n>:X	118
:CALCulate:MARKer<n>:Y?	118
:CALCulate:MATH:PDIF	119
:CALCulate:MATH:LDIF	119
:CALCulate:MATH:LOFF	119
:CALCulate:NDB:STATe.....	120
:CALCulate:NDB:BANDwidth BWIDth?.....	120
:CALCulate:NORMALize:STATe.....	121
:CALCulate:OCBW:STATe	121
:CALCulate:OCBW:BANDwidth BWIDth?	121
:CALCulate:OCBW:CHPower?	122
:CALCulate:OCBW:POWer?	122
:CALCulate:OCBW:PSDeNsity?	122
:CALCulate:P1DB:STATe.....	123
:CALCulate:P1DB:NORMALize:STATe.....	123
:CALCulate:P1DB:GAIN:AVERAge?	123
:CALCulate:P1DB:GAIN:RESult?	124
:CALCulate:P1DB:RESult?	124
:CALCulate:PMETer:POWer?.....	124
:CALCulate:PMETer:LIMit:STATe.....	125
:CALCulate:PMETer:LIMit:FAIL?.....	125
:CALCulate:SEM:STATe.....	125

:CALCulate:SEM:OFFSet<n>:RESult?126
 :CALCulate:TOI:DIFFerential?126
 :CALCulate:TOI:FREQuency:DIFFerential?127
 :CALCulate:TOI:LIMit:STATe127
 :CALCulate:TOI:RESult?127
 :CALCulate:TOI:STATe.....128

**:CALCulate:ACPR:ACHannel<n>:HLIMit:
 FAIL?**



Description	Returns the ACPR upper limit pass/fail judgment for the selected adjacent channel.	
Query Syntax	:CALCulate:ACPR:ACHannel<n>:HLIMit:FAIL?	
Parameter	<n>	<NR1>adjacent channel 1~3
Return parameter	0	<boolean>Pass
	1	<boolean>Fail
Query Example	:CALC:ACPR:ACH1:HLIM:FAIL? >0	

**:CALCulate:ACPR:ACHannel<n>:LLIMit:
 FAIL?**



Description	Returns the ACPR lower limit pass/fail judgment for the selected adjacent channel.	
Query Syntax	:CALCulate:ACPR:ACHannel<n>:LLIMit:FAIL?	
Parameter	<n>	<NR1>adjacent channel 1~3
Return parameter	0	<boolean>Pass
	1	<boolean>Fail
Query Example	:CALC:ACPR:ACH1:LLIM:FAIL? >0	

:CALCulate:ACPR:ACHannel<n>:LOWer? → **Query**

Description Returns the ACPR (adjacent channel power ratio in dB) calculated for the selected lower adjacent channel.

Query Syntax :CALCulate:ACPR:ACHannel<n>:LOWer?

Parameter <n> <NR1>adjacent channel 1~3

Return parameter <NR3> Power ratio in dB

Query Example :CALC:ACPR:ACH1:LOW?
>1.801e+01

:CALCulate:ACPR:ACHannel<n>:UPPer? → **Query**

Description Returns the ACPR (adjacent channel power ratio in dB) calculated for the selected higher adjacent channel.

Query Syntax :CALCulate:ACPR:ACHannel<n>:UPPer?

Parameter <n> <NR1>adjacent channel 1~3

Return parameter <NR3> Power ratio in dB

Query Example :CALC:ACPR:ACH1:UPP?
>1.921e+01

Set →

:CALCulate:ACPR:ACHannel<n>:STATe → **Query**

Description Sets or queries the state of the selected adjacent channel.

Syntax :CALCulate:ACPR:ACHannel<n>:STATe {OFF|ON|0|1}

Query Syntax :CALCulate:ACPR:ACHannel<n>:STATe?

Parameter <n> <NR1>adjacent channel 1~3
0 Disable the selected channel.
1 Enable the selected channel.
OFF Disable the selected channel.

	ON	Enable the selected channel.
Return parameter	0	The selected channel is disabled.
	1	The selected channel is enabled.
Query Example	:CALC:ACPR:ACH1:STAT? >1	

:CALCulate:ACPR:CHANnel:HLIMit:FAIL? → **Query**

Description	Returns the ACPR upper limit pass/fail judgment for the main channel. A pass indicates that every trace point in the main channel is lower than or equal to the upper limit.	
Query Syntax	:CALCulate:ACPR:CHANnel:HLIMit:FAIL?	
Return parameter	0	<boolean>Pass
	1	<boolean>Fail
Query Example	:CALC:ACPR:CHAN:HLIM:FAIL? >0	

:CALCulate:ACPR:CHANnel:LLIMit:FAIL? → **Query**

Description	Returns the ACPR lower limit pass/fail judgment for the main channel. A pass indicates that every trace point in the main channel is higher than or equal to the lower limit.	
Query Syntax	:CALCulate:ACPR:CHANnel:LLIMit:FAIL?	
Return parameter	0	<boolean>Pass
	1	<boolean>Fail
Query Example	:CALC:ACPR:CHAN:LLIM:FAIL? >0	

:CALCulate:ACPR:CHPower? → **Query**

Description	Returns the ACPR main channel power in the current chosen unit.
-------------	---

Query Syntax :CALCulate:ACPR:CHPower?

Return parameter <NR3> Power

Query Example :CALC:ACPR:CHP?
>-1.028e+02

:CALCulate:ACPR:STATe

Set →

→ Query

Description Sets or queries the state of the ACPR measurement function.

Syntax :CALCulate:ACPR:STATe {OFF|ON|0|1}

Query Syntax :CALCulate:ACPR:STATe?

Parameter	0	ACPR is disabled.
	1	ACPR is enabled.
	OFF	ACPR is disabled.
	ON	ACPR is enabled.

Return parameter	0	ACPR is disabled.
	1	ACPR is enabled.

Query Example :CALC:ACPR:STAT?
>1

:CALCulate:BFSK:LIMit:STATe

Set →

→ Query

Description Sets or queries the state of the 2FSK (BFSK) limit function.

Syntax :CALCulate:BFSK:LIMit:STATe {OFF|ON|0|1}

Query Syntax :CALCulate:BFSK:LIMit:STATe?

Parameter	OFF 0	2FSK limit is disabled.
	ON 1	2FSK limit is enabled.

Return parameter	0	2FSK limit is disabled.
	1	2FSK limit is enabled.

Query Example :CALC:BFSK:LIM:STAT?
>1

:CALCulate:BFSK:LIMit:FAIL? → **Query**

Description Returns the 2FSK limit pass/fail judgment. A pass indicates that the trace abides by every limit condition.

Query Syntax :CALCulate:BFSK:LIMit:FAIL?

Return parameter	0	<boolean>Pass
	1	<boolean>Fail

Query Example :CALCulate:BFSK:LIMit:FAIL?
>0

:CALCulate:BFSK:LIMit:FDEVIation → **Set** → **Query**

Description Sets or queries the frequency deviation limit for 2FSK. The frequency limit indicates the maximum frequency deviation for a pass judgement.

Syntax :CALCulate:BFSK:LIMit:FDEVIation <freq>

Query Syntax :CALCulate:BFSK:LIMit:FDEVIation?

Parameter/ Return Parameter	<freq>	<NR3> frequency in Hz.
--	--------	------------------------

Example :CALC:BFSK:LIM:FDEV?
>2.000000000e+05

:CALCulate:BFSK:LIMit:CARRier:OFFSet → **Set** → **Query**

Description Sets or queries the carrier offset frequency. The carrier offset indicates the maximum offset for a pass judgement.

Syntax :CALCulate:BFSK:LIMit:CARRier:OFFSet <freq>

Query Syntax :CALCulate:BFSK:LIMit:CARRier:OFFSet?

Parameter/ Return Parameter	<code><freq></code>	<code><NR3></code> frequency in Hz.
--------------------------------	---------------------------	---

Example :CALC:BFSK:LIM:CARR:OFFS?
 >2.000000000e+05

Set →
 → Query

:CALCulate:BFSK:LIMit:HIGH

Description Sets or queries the 2FSK high limit. If the amplitude of the trace is above the high limit, it will be judged as Fail.

Syntax :CALCulate:BFSK:LIMit:HIGH <ampl>

Query Syntax :CALCulate:BFSK:LIMit:HIGH?

Parameter/ Return Parameter	<code><ampl></code>	<code><NR3></code> amplitude in dBm.
--------------------------------	---------------------------	--

Example :CALC:BFSK:LIM:HIGH?
 >3.000e+01

Set →
 → Query

:CALCulate:BFSK:LIMit:LOW

Description Sets or queries the 2FSK low limit. If the amplitude of the trace is above the low limit, it will be judged as Fail.

Syntax :CALCulate:BFSK:LIMit:LOW <ampl>

Query Syntax :CALCulate:BFSK:LIMit:LOW?

Parameter/ Return Parameter	<code><ampl></code>	<code><NR3></code> amplitude in dBm.
--------------------------------	---------------------------	--

Example :CALC:BFSK:LIM:LOW?
 >-1.200e+02

Set →

:CALCulate:BFSK:REStart

Description Restarts the 2FSK (BFSK) measurement.

Syntax :CALC:BFSK:REST

:CALCulate:BFSK:RESult? → Query

Description Returns the 2FSK (BFSK) measurement result.

Query Syntax :CALCulate:BFSK:RESult?

Return parameter	<freq deviation>,<carrier offset>
	<freq deviation> Frequency deviation in NRf format
	<carrier offset> Carrier offset in NRf format

Query Example :CALC:BFSK:RES?
>4.416666667e+04,4.416666667e+04

Set →

:CALCulate:BFSK:STATe → Query

Description Sets or queries the state of the 2FSK measurement function.

Syntax :CALCulate:BFSK:STATe {OFF|ON|0|1}

Query Syntax :CALCulate:BFSK:STATe?

Parameter	OFF 0	2FSK is off.
	ON 1	2FSK is on.

Return parameter	0	2FSK is off.
	1	2FSK is on.

Query Example :CALC:BFSK:STAT?
>1

:CALCulate:CNR:RESult? → Query

Description Returns the CNR measurement result in dB.

Query Syntax :CALCulate:CNR:RESult?

Return parameter <NR3> CNR measurement in dB

Query Example :CALC:CNR:RES?
>-4.959e+01

:CALCulate:CNR:STATe (Set) →
→ (Query)

Description	Sets or queries the state of the CNR measurement function.	
Syntax	:CALCulate:CNR:STATe {ON OFF 1 0}	
Query Syntax	:CALCulate:CNR:STATe?	
Parameter	0	CNR is off.
	1	CNR is on.
	OFF	CNR is off.
	ON	CNR is on.
Return parameter	0	CNR is off.
	1	CNR is on.
Query Example	:CALC:CNR:STAT? >1	

:CALCulate:CSO:RESult? → (Query)

Description	Returns the CSO measurement result in dB.	
Query Syntax	:CALCulate:CSO:RESult?	
Return parameter	<NR3>	CSO measurement in dB
Query Example	:CALC:CSO:RES? >4.04e+00	

:CALCulate:CSO:STATe (Set) →
→ (Query)

Description	Sets or queries the state of the CSO measurement function.	
Syntax	:CALCulate:CSO:STATe {ON OFF 1 0}	
Query Syntax	:CALCulate:CSO:STATe?	
Parameter	0	CSO is off.
	1	CSO is on.
	OFF	CSO is off.

	ON	CSO is on.
Return parameter	0	CSO is off.
	1	CSO is on.
Query Example	:CALC:CSO:STAT? >1	

:CALCulate:CTB:RESult? → Query

Description	Returns the CTB measurement result in dB.	
Query Syntax	:CALCulate:CTB:RESult?	
Return parameter	<NR3>	CTB measurement in dB
Query Example	:CALC:CTB:RES? >-4.237e+01	

Set →

:CALCulate:CTB:STATe → Query

Description	Sets or queries the state of the CTB measurement function.	
Syntax	:CALCulate:CTB:STATe {ON OFF 1 0}	
Query Syntax	:CALCulate:CTB:STATe?	
Parameter	0	CTB is off.
	1	CTB is on.
	OFF	CTB is off.
	ON	CTB is on.
Return parameter	0	CTB is off.
	1	CTB is on.
Query Example	:CALC:CTB:STAT? >0	

Set →

:CALCulate:CTB:REStart

Description	Restarts the CTB measurement.
Syntax	:CALCulate:CTB:REStart

:CALCulate:DELTamarker<n>:PAIR:SPAN Set →

Description	Sets the span between the chosen marker and the delta marker.	
Syntax	:CALCulate:DELTamarker<n>:PAIR:SPAN <freq>	
Parameter	<n> <freq>	Marker number. <NRf> frequency of span.
Example	:CALC:DELT1:PAIR:SPAN 1e+9	

:CALCulate:DELTamarker<n>:PAIR:CENTer Set →

Description	Takes the current span between the chosen markers and relocates that center frequency to the chosen center frequency.	
Syntax	:CALCulate:DELTamarker<n>:PAIR:CENTer <freq>	
Parameter	<n> <freq>	Marker number. <NRf> center frequency.
Example	:CALC:DELT1:PAIR:CENT 1e+9	

:CALCulate:DELTamarker<n>:X Set → Query

Description	Sets or queries the selected delta marker position.	
Syntax	:CALCulate:DELTamarker<n>:X <freq>	
Query Syntax	:CALCulate:DELTamarker<n>:X?	
Parameter	<n>	Marker number.
Return parameter	<freq>	<NR3> frequency in Hz.
Example	:CALC:DELT1:X? >1e+9	

:CALCulate:DELTamarker<n>:Y? → **Query**

Description Returns the selected delta marker Y axis value.

Query Syntax :CALCulate:DELTamarker<n>:Y?

Parameter <n> Marker number.

Return parameter <rel_amp> <NR3> in dB.

Example :CALC:DELT1:Y?
>-1.032e+1

:CALCulate:DEMod:AM:RESult:CURRent? → **Query**

Description Returns the current measurement results for AM demodulation as a comma separated string.

Query Syntax :CALCulate:DEMod:AM:RESult:CURRent?

Return parameter <depth,rate,power,offset,sinad>

depth	Modulation depth in %.
rate	Modulation rate in Hz.
power	Carrier power in the current Y-axis units.
offset	Carrier frequency offset in Hz.
sinad	Signal to noise and distortion ratio in dB

Query Example :CALC:DEMod:AM:RES:CURR?
>9.840e+1,1.02e+2,-1.12e+1,3.21e+1,1.61e+1

:CALCulate:DEMod:AM:RESult:MINimum? → **Query**

Description Returns the minimum recorded measurement results for AM demodulation as a comma separated string.

Query Syntax :CALCulate:DEMod:AM:RESult:MINimum?

Return parameter <depth,rate,power,offset,sinad>

depth	Modulation depth in %.
rate	Modulation rate in Hz.
power	Carrier power in the current Y-axis units.

offset	Carrier frequency offset in Hz.
sinad	Signal to noise and distortion ratio in dB

Query Example :CALC:DEM:AM:RES:MIN?
>9.840e+1,1.02e+2,-1.12e+1,3.21e+1,1.61e+1

:CALCulate:DEMod:AM:RESult:MAXimum? → **Query**

Description Returns the maximum recorded measurement results for AM demodulation as a comma separated string.

Query Syntax :CALCulate:DEMod:AM:RESult:MAXimum?

Return parameter	<depth,rate,power,offset,sinad>	
	depth	Modulation depth in %.
	rate	Modulation rate in Hz.
	power	Carrier power in the current Y-axis units.
	offset	Carrier frequency offset in Hz.
	sinad	Signal to noise and distortion ratio in dB.

Query Example :CALC:DEM:AM:RES:MAX?
>9.840e+1,1.02e+2,-1.12e+1,3.21e+1,1.61e+1

:CALCulate:DEMod:AM:STATe **Set** → **Query**

Description Sets or queries the state of the AM Analysis function.

Syntax :CALCulate:DEMod:AM:STATe {ON|OFF|1|0}

Query Syntax :CALCulate:DEMod:AM:STATe?

Parameter	0	Turn AM Analysis off.
	1	Turn AM Analysis on.
	OFF	Turn AM Analysis off.
	ON	Turn AM Analysis on.

Return parameter	0	AM Analysis is off.
	1	AM Analysis is on.

Example :CALC:DEM:AM:STAT 1

:CALCulate:DEMod:EARPhone:STATe (Set) →
→ (Query)

Description	Sets or queries the state of the ear phone out port.	
Syntax	:CALCulate:DEMod:EARPhone:STATe {ON OFF 1 0}	
Query Syntax	:CALCulate:DEMod:EARPhone:STATe?	
Parameter	0	Turn the phone output off.
	1	Turn the phone output on.
	OFF	Turn the phone output off.
	ON	Turn the phone output on.
Return parameter	0	Phone output is off.
	1	Phone output is on.
Example	:CALC:DEM:EARP:STAT 1	

:CALCulate:DEMod:FM:RESult:CURRent? → (Query)

Description	Returns the current measurement results for FM demodulation as a comma separated string.	
Query Syntax	:CALCulate:DEMod:FM:RESult:CURRent?	
Return parameter	<deviation,rate,power,offset,sinad>	
	deviation	Frequency deviation in Hz.
	rate	Modulation rate in Hz.
	power	Carrier power in the current Y-axis units.
	offset	Carrier frequency offset in Hz.
	sinad	Signal to noise and distortion ratio in dB.
Query Example	:CALC:DEM:FM:RES:CURR? >9.840e+1,1.02e+2,-1.12e+1,3.21e+1,1.61e+1	

:CALCulate:DEMod:FM:RESult:MINimum? → (Query)

Description	Returns the minimum recorded measurement results for FM demodulation as a comma separated string.	
Query Syntax	:CALCulate:DEMod:FM:RESult:MINimum?	

Return parameter	<deviation,rate,power,offset,sinad>	
	deviation	Frequency deviation in Hz.
	rate	Modulation rate in Hz.
	power	Carrier power in the current Y-axis units.
	offset	Carrier frequency offset in Hz.
	sinad	Signal to noise and distortion ratio in dB.

Query Example :CALC:DEM:FM:RES:MIN?
>9.840e+1,1.02e+2,-1.12e+1,3.21e+1,1.61e+1

:CALCulate:DEMod:FM:RESult:MAXimum? → **Query**

Description Returns the maximum recorded measurement results for FM demodulation as a comma separated string.

Query Syntax :CALCulate:DEMod:FM:RESult:MAXimum?

Return parameter	<deviation,rate,power,offset,sinad>	
	deviation	Frequency deviation in Hz.
	rate	Modulation rate in Hz
	power	Carrier power in the current Y-axis units.
	offset	Carrier frequency offset in Hz.
	sinad	Signal to noise and distortion ratio in dB.

Query Example :CALC:DEM:FM:RES:MAX?
>9.840e+1,1.02e+2,-1.12e+1,3.21e+1,1.61e+1

Set →

:CALCulate:DEMod:FM:STATe → **Query**

Description Sets or queries the state of the FM Analysis function.

Syntax :CALCulate:DEMod:FM:STATe {ON|OFF|1|0}

Query Syntax :CALCulate:DEMod:FM:STATe?

Parameter	0	Turn FM Analysis off.
	1	Turn FM Analysis on.
	OFF	Turn FM Analysis off.
	ON	Turn FM Analysis on.

Return parameter	0	FM Analysis is off.
	1	FM Analysis is on.

Example :CALC:DEM:FM:STAT 1

:CALCulate:DEMod:LIMit:AMDepth (Set) →
→ (Query)

Description Sets or queries the AM depth limit. The AM depth limit indicates the maximum AM depth for a pass judgement.

Syntax :CALCulate:DEMod:LIMit:AMDepth <value>

Query Syntax :CALCulate:DEMod:LIMit:AMDepth?

Parameter/Return Parameter <value> <NR1> depth in %.

Example :CALC:DEM:LIM:AMD?
>100

:CALCulate:DEMod:LIMit:FDEVIation (Set) →
→ (Query)

Description Sets or queries the FM deviation limit. The FM deviation limit indicates the maximum FM deviation for a pass judgement.

Syntax :CALCulate:DEMod:LIMit:FDEVIation <freq>

Query Syntax :CALCulate:DEMod:LIMit:FDEVIation?

Parameter/Return Parameter <freq> <NR3> deviation in Hz.

Example :CALC:DEM:LIM:FDEV?
>1.000000000e+02

:CALCulate:DEMod:LIMit:CARRier:OFFSet (Set) →
→ (Query)

Description Sets or queries the carrier offset frequency limit. The carrier offset indicates the maximum offset for a pass judgement.

Syntax	:CALCulate:DEMod:LIMit:CARRier:OFFSet <freq>	
Query Syntax	:CALCulate:DEMod:LIMit:CARRier:OFFSet?	
Parameter/ Return Parameter	<freq>	<NR3> frequency in Hz.
Example	:CALC:DEM:LIM:CARR:OFFS? >5.000000000e+02	

Set →
 → Query

Description	Sets or queries the carrier power limit. The carrier power indicates the maximum power for a pass judgement.	
Syntax	:CALCulate:DEMod:LIMit:CARRier:POWER <ampl>	
Query Syntax	:CALCulate:DEMod:LIMit:CARRier:POWER?	
Parameter/ Return Parameter	<ampl>	<NR3> power in dBm.
Example	:CALC:DEM:LIM:CARR:POW? >-1.000000000e+01	

→ Query

Description	Returns the demod limit pass/fail judgment. A pass indicates that the trace abides by every limit condition.	
Query Syntax	:CALCulate:DEMod:LIMit:FAIL?	
Return Parameter	For AM Modulation/ASK: <AM Depth>,<Carrier Power>,<Carrier Frequency Offset> For FM Modulation/FSK: <Freq Deviation>,<Carrier Power>,<Carrier Freq Offset> <AM Depth> AM depth result <FM Deviation> Modulation depth result <Carr. Power> Carrier power result <Carr. Freq Offset> Carrier frequency offset result	

0	<boolean>Fail
1	<boolean>Pass

Query Example :CALC:DEM:LIM:FAIL?
>0,0,0.

:CALCulate:DEMod:LIMit:STATe

Set →

→ Query

Description Sets or queries the state of the pass/fail limit function.

Syntax :CALCulate:DEMod:LIMit:STATe {ON|OFF|0|1}

Query Syntax :CALCulate:DEMod:LIMit:STATe?

Parameter	OFF	Pass/fail limit is disabled.
	ON	Pass/fail limit is enabled.

Return parameter	0	Pass/fail limit is disabled.
	1	Pass/fail limit is enabled.

Query Example :CALC:DEM:LIM:STAT?
>1

:CALCulate:DEMod:ASK:STATe

Set →

→ Query

Description Sets or queries whether the ASK function is on or off.

Syntax :CALCulate:DEMod:ASK:STATe {ON|OFF|0|1}

Query Syntax :CALCulate:DEMod:ASK:STATe?

Return parameter	ON 1	<boolean>On
	OFF 0	<boolean>Off

Return parameter	1	<boolean>On
	0	<boolean>Off

Query Example :CALC:DEM:ASK:STAT?
>0

:CALCulate:DEMod:FSK:STATe (Set) →
→ (Query)

Description	Sets or queries whether the FSK function is on or off.	
Syntax	:CALCulate:DEMod:FSK:STATe {ON OFF 0 1}	
Query Syntax	:CALCulate:DEMod:FSK:STATe?	
Return parameter	ON 1	<boolean>On
	OFF 0	<boolean>Off
Return parameter	1	<boolean>On
	0	<boolean>Off
Query Example	:CALC:DEM:FSK:STAT? >0	

:CALCulate:DEMod:ASK:RESult:CURRent? → (Query)

Description	Returns the current ASK measurements.	
Query Syntax	:CALCulate:DEMod:ASK:RESult:CURRent?	
Return Parameter	<AM Depth>,<Carrier Power>,<Carrier Frequency Offset>	
	<AM Depth>	AM depth
	<Carr. Power>	Carrier power
	<Carr. Freq Offset>	Carrier frequency offset
Query Example	:CALC:DEM:ASK:RES:CURR? >9.611e+01, -6.781e+01, 0.000000000e+00	

:CALCulate:DEMod:ASK:RESult:MINimum? → (Query)

Description	Returns the minimum ASK measurements.	
Query Syntax	:CALCulate:DEMod:ASK:RESult:MINimum?	
Return Parameter	<AM Depth>,<Carrier Power>,<Carrier Frequency Offset>	
	<AM Depth>	AM depth
	<Carr. Power>	Carrier power

<Carr. Freq Offset> Carrier frequency offset

Query Example :CALC:DEM:ASK:RES:MIN?
>9.295e+01, -6.843e+01, 0.000000000e+00

:CALCulate:DEMod:ASK:RESult:MAXimum? → **Query**

Description Returns the maximum ASK measurements.

Query Syntax :CALCulate:DEMod:ASK:RESult:MAXimum?

Reutrn Parameter	<AM Depth>,<Carrier Power>,<Carrier Frequency Offset>	
	<AM Depth>	AM depth
	<Carr. Power>	Carrier power
	<Carr. Freq Offset>	Carrier frequency offset

Query Example :CALC:DEM:ASK:RES:MAX?
>9.987e+01, -6.346e+01, 1.076593088e+06

:CALCulate:DEMod:FSK:RESult:CURRent? → **Query**

Description Returns the current FSK measurements.

Query Syntax :CALCulate:DEMod:FSK:RESult:CURRent?

Reutrn Parameter	<Freq Deviation>,<Carrier Power>,<Carrier Frequency Offset>	
	<Freq. Deviation>	FM deviation
	<Carr. Power>	Carrier power
	<Carr. Freq Offset>	Carrier frequency offset

Query Example :CALC:DEM:FSK:RES:CURR?
>8.749949037e+09, -6.023e+01, -8.749322018e+09

:CALCulate:DEMod:FSK:RESult:MINimum? → **Query**

Description Returns the minimum FSK measurements.

Query Syntax :CALCulate:DEMod:FSK:RESult:MINimum?

Reutrn Parameter	<Freq Deviation>,<Carrier Power>,<Carrier Frequency Offset>	
	<Freq. Deviation>	FM deviation

<Carr. Power>	Carrier power
<Carr. Freq Offset>	Carrier frequency offset

Query Example :CALC:DEM:FSK:RES:MIN?
>3.000050000e+09, -6.256e+01,-2.600935311e+10

:CALCulate:DEMod:FSK:RESult:MAXimum? → **Query**

Description Returns the maximum FSK measurements.

Query Syntax :CALCulate:DEMod:FSK:RESult:MAXimum?

Return Parameter <Freq Deviation>,<Carrier Power>,<Carrier Frequency Offset>

<Freq. Deviation>	FM deviation
<Carr. Power>	Carrier power
<Carr. Freq Offset>	Carrier frequency offset

Query Example :CALC:DEM:FSK:RES:MAX?
>3.499878695e+10, -5.837e+01,-3.000050000e+09

:CALCulate:DEMod:RESet → **Set**

Description This command will reset the max and min records for the current demodulation analysis.

Syntax :CALCulate:DEMod:RESet

:CALCulate:HARMonic:DISTortion? → **Query**

Description Returns the harmonic distortion as a percentage of the fundamental and as dBc.

Query Syntax CALCulate:HARMonic:DISTortion?

Return parameter <%>,<dBc>

<%>	THD as %. <NR1> format
<dBc>	THD as dBc. <NRf> format

Query Example :CALC:HARM:DIST?
>32.34,-9.81e+00

:CALCulate:HARMonic:RESult? → Query

Description	Returns the amplitude of each harmonic in dBm.
Query Syntax	:CALCulate:HARMonic:RESult?
	<fundamental>,<harmonic#2>,...<harmonic#n>
	<fundamental> Returns the amplitude of the fundamental harmonic frequency in dBm.
	<harmonic#n> Returns the amplitude of the nth harmonic in dBm.
Query Example	:CALC:HARM:RES? >-7.572e+01,0.00e+00,0.00e+00,0.00e+00,0.00e+00

Set →

:CALCulate:HARMonic:STATe → Query

Description	Sets or queries the state of the Harmonics function.
Syntax	:CALCulate:HARMonic:STATe {ON OFF}
Query Syntax	:CALCulate:HARMonic:STATe?
Parameter	OFF Turn Harmonic measurement off. ON Turn Harmonic measurement on.
Return parameter	0 Harmonic measurement is off. 1 Harmonic measurement is on.
Example	:CALC:HARM:STAT ON

Set →

:CALCulate:IQ:IFBW → Query

Description	Sets or queries the IF bandwidth for the IQ Analysis function.
Syntax	:CALCulate:IQ:IFBW <freq>
Query Syntax	:CALCulate:IQ:IFBW?
parameter	<freq> <NRf>
Return parameter	<NR3> Hz

Query Example :CALC:IQ:IFBW 2.0e+6

Set →

:CALCulate:IQ:RECORDing:TIME

→ Query

Description Sets the length of the recording time in IQ mode

Syntax :CALCulate:IQ:RECORDing:TIME

Query Syntax :CALCulate:IQ:RECORDing:TIME?

parameter <time> <NRf>

Return parameter <NR3> seconds

Query Example :CALC:IQ:REC:TIME?
>0

Set →

:CALCulate:IQ:STATe

→ Query

Description Sets or queries whether the IQ function is on or off.

Syntax :CALCulate:IQ:STATe {ON|OFF|0|1}

Query Syntax :CALCulate:IQ:STATe?

Return parameter ON | 1 <boolean>On
OFF | 0 <boolean>Off

Return parameter 1 <boolean>On
0 <boolean>Off

Query Example :CALC:IQ:STAT?
>0

Set →

:CALCulate:JITTer:STATe

→ Query

Description Sets or queries the state of the Jitter Analysis function.

Syntax :CALCulate:JITTer:STATe {ON|OFF|1|0}

Query Syntax :CALCulate:JITTer:STATe?

Parameter	0	Turn Jitter Analysis off.
	1	Turn Jitter Analysis on.
	OFF	Turn Jitter Analysis off.
	ON	Turn Jitter Analysis on.
Return parameter	0	Jitter Analysis is off.
	1	Jitter Analysis is on.
Example	:CALCulate:JITTer:STATe 1	

:CALCulate:JITTer:CARRier:POWer? → Query

Description	Returns the carrier power in the current Y-axis units.	
Query Syntax	:CALCulate:JITTer:CARRier:POWer?	
Return parameter	<NR3>	In the current Y-axis units.
Query Example	:CALC:JITTer:CARR:POW? >-5.237e+01	

:CALCulate:JITTer:PHASe? → Query

Description	Returns the carrier phase jitter in radians.	
Query Syntax	:CALCulate:JITTer:PHASe?	
Return parameter	<NR3>	Rad
Query Example	:CALC:JITTer:PHAS? >1.5307e+01	

:CALCulate:JITTer:TIME? → Query

Description	Returns the carrier jitter time in seconds.	
Query Syntax	:CALCulate:JITTer:TIME?	
Return parameter	<NR3>	Seconds
Query Example	:CALC:JITTer:TIME? >.5.31e-08	

:CALCulate:LIMit<n>:CLEar Set →

Description	Clears the High Limit, Low Limit and the Pass/Fail state for the selected limit line.	
Syntax	:CALCulate:LIMit<n>:CLEar	
Parameter	<n>	Selected limit line
Example	:CALC:LIM1:CLE	

**:CALCulate:LIMit<n>:DATA Set →
→ Query**

Description	Sets or queries the frequency, amplitude limit of every point in the selected limit line. The data is stored in CSV format. There are total of 10 pairs of data points (20 data entries in total) for the <csv data> data.	
Syntax	:CALCulate:LIMit<n>:DATA <csv data>	
Query Syntax	:CALCulate:LIMit<n>:DATA?	
Parameter/ Return parameter	<csv data>	pt#1 freq, pt#1 limit,pt#10 freq, pt#10 limit.
	<n>	Selected limit line
Example	:CALCulate:LIMit3:DATA? >1e+6,-10,2e+6,-30,3e+6,-40,4e+6.....	

:CALCulate:LIMit:FAIL? → Query

Description	Returns the Pass/Fail judgment.	
Query Syntax	:CALCulate:LIMit:FAIL?	
Return parameter	0	Pass
	1	Fail
Query Example	:CALC:LIM:FAIL? >1	

:CALCulate:LIMit:LOW

Set →

Description	Selects which limit line is used for the low limit.	
Syntax	:CALCulate:LIMit:LOW <limit num>	
Parameter	<limit num>	<NR1> 1~5
Example	:CALC:LIM:LOW 2	

:CALCulate:LIMit:HIGH

Set →

Description	Selects which limit line is used for the high limit.	
Syntax	:CALCulate:LIMit:HIGH <limit num>	
Parameter	<limit num>	<NR1> 1~5
Example	:CALC:LIM:HIGH 2	

:CALCulate:LIMit<n>:MARKer

Set →

Description	Sets the current marker position to a point on a limit line. The vertical position of the point is the marker's vertical position + a user-defined offset.	
Syntax	:CALCulate:LIMit<n>:MARKer <point>,<offset>	
Parameter	<point> <offset> <n>	<NR1> point 1~10 <NR3> dB Selected limit line
Example	:CALC:LIM1:MARK 5, 20	

:CALCulate:LIMit:MODE

Set →

→ **Query**

Description	Sets or queries the Pass/Fail mode for limit line testing.	
Syntax	:CALCulate:LIMit:MODE {SINGLE CONTInue}	

Query Syntax	:CALCulate:LIMit:MODE?	
Parameter	SINGLE	Stops triggering after a pass/fail result.
	CONTinue	Continues triggering after a pass/fail result.
Return Parameter	SINGLE	Stops triggering after a pass/fail result.
	CONTinue	Continues triggering after a pass/fail result.
Example	:CALC:LIM:MODE CONT	

:CALCulate:LIMit:STATe (Set) →
→ (Query)

Description	Turns the limit line Pass/Fail test on/off.	
Syntax	:CALCulate:LIMit:STATe {ON OFF 1 0}	
Query Syntax	:CALCulate:LIMit:STATe?	
Parameter	0	Pass/Fail test is off.
	1	Pass/Fail test is on.
	OFF	Pass/Fail test is off.
	ON	Pass/Fail test is on.
Return parameter	0	Pass/Fail test is off.
	1	Pass/Fail test is on.
Example	:CALC:LIM:STAT 1	

:CALCulate:LIMit<n>:TRACe (Set) →

Description	Creates a limit line from the currently selected trace with a user defined offset.	
Syntax	:CALCulate:LIMit<n>:TRACe <offset>	
Parameter	<n>	<NR1> limit line 1~5
	<offset>	<NR3> in dB
Example	:CALC:LIM2:TRAC 10	

:CALCulate:LIMit:TYPE (Set) →
→ (Query)

Description	Sets or queries the Pass/Fail conditions for the limit line testing.	
Syntax	:CALCulate:LIMit:TYPE {ALL MAX MIN}	
Query Syntax	:CALCulate:LIMit:TYPE?	
Parameter/ Return Parameter	ALL MAX MIN	All-in. Max-In Min-In
Example	:CALC:LIM:TYPE ALL	

:CALCulate:MARKer:AOff (Set) →

Description	Turns all the markers off.	
Syntax	:CALCulate:MARKer:AOff	
Example	:CALC:MARK:AOff	

:CALCulate:MARKer<n>:FCOunt:RESolution (Set) →
→ (Query)

Description	Sets or queries the frequency counter resolution in Hz for the selected marker.	
Syntax	:CALCulate:MARKer<n>:FCOunt:RESolution <freq>	
Query Syntax	:CALCulate:MARKer<n>:FCOunt:RESolution?	
Parameter	<n> <freq>	<NR1>Marker number 1~6*. Frequency resolution in Hz**.
Return parameter	<freq>	Frequency resolution in Hz.

Note

- * Only one marker can be selected at a time to use the marker counter function.
- The selected marker counter will disable the previously selected marker counter.
- ** Only 1000, 100, 10, 1 Hz are meaningful.

Example :CALC:MARK1:FCO:RES?
>1.0e+3

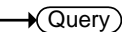
:CALCulate:MARKer<n>:FCOunt: 
RESolution:AUTO 

Description Sets the frequency counter resolution Auto setting on/off.

Syntax :CALCulate:MARKer<n>:FCOunt:RESolution:AUTO {ON|OFF|1|0}

Query Syntax :CALCulate:MARKer<n>:FCOunt:RESolution:AUTO?

Parameter	<n>	<NR1>Marker number 1~6
	0	Auto is off.
	1	Auto is on.
	OFF	Auto is off.
	ON	Auto is on.

Return parameter	0	Auto is off.
	1	Auto is on.

Example :CALC:MARK1:FCO:RES:AUTO?

:CALCulate:MARKer<n>:FCOunt:STATe 

Description Sets or queries the state of the frequency counter function.

Syntax :CALCulate:MARKer<n>:FCOunt:STATe {ON|OFF|1|0}

Query Syntax :CALCulate:MARKer<n>:FCOunt:STATe?

Parameter	<n>	<NR1>Marker number 1~6
	0	Turn frequency counter off.
	1	Turn frequency counter on.
	OFF	Turn frequency counter off.
	ON	Turn frequency counter on.

Return parameter	0	Frequency counter is off.
	1	Frequency counter is on.

Example :CALC:MARKer1:FCO:STAT 1

:CALCulate:MARKer<n>:FCOunt:X? → Query

Description Returns the counter frequency of the selected marker in Hz.

Query Syntax :CALCulate:MARKer<n>:FCOunt:X?

Parameter <n> <NR1> Marker number 1~6.

Return parameter <freq> <NR3> Frequency in Hz.

Example :CALC:MARK1:FCO:X?
>2.0083e+8

:CALCulate:MARKer<n>:NOISe:STATe Set →
→ Query

Description Sets or queries the state of the Marker Noise function.

Syntax :CALCulate:MARKer<n>:NOISe:STATe {ON|OFF|1|0}

Query Syntax :CALCulate:MARKer<n>:NOISe:STATe?

Parameter

<n>	<NR1>Marker number 1~6.
0	Turn marker noise off.
1	Turn marker noise on.
OFF	Turn marker noise off.
ON	Turn marker noise on.

Return parameter

0	Marker noise is off.
1	Marker noise is on.

Example :CALC:MARK2:NOIS:STAT ON

:CALCulate:MARKer<n>:NOISe:Y? → Query

Description Returns the normalized noise level over a BW of 1Hz from the marker position.

Query Syntax :CALCulate:MARKer<n>:NOISe:Y?

Parameter <n> <NR1> Marker number 1~6.

Return parameter <NR3> Normalized noise level in the Y-axis unit.

Example :CALC:MARK1:NOIS:Y?
>1.166e+2

:CALCulate:MARKer<n>:VSWR:STATe

Set →
→ Query

Description Sets or queries the state of the VSWR function.

Syntax :CALCulate:MARKer<n>:VSWR:STATe {ON|OFF|1|0}

Query Syntax :CALCulate:MARKer<n>:VSWR:STATe?

Parameter	<n>	<NR1>Marker number 1~6.
	0	Turn VSWR measurement to off.
	1	Turn VSWR measurement to on.
	OFF	Turn VSWR measurement to off.
	ON	Turn VSWR measurement to on.

Return parameter	0	VSWR is off.
	1	VSWR is on.

Example :CALC:MARK2:VSWR:STAT ON

:CALCulate:MARKer<n>:VSWR:Y?

→ Query

Description Returns the VSWR measurement value.

Query Syntax :CALCulate:MARKer<n>:VSWR:Y?

Parameter	<n>	<NR1> Marker number 1~6.
-----------	-----	--------------------------

Return parameter	<NR2>	VSWR value.
------------------	-------	-------------

Example :CALC:MARK1:VSWR:Y?
>1.35

:CALCulate:MARKer<n>:PEAK

Set →

Description Sets the selected marker to the selected peak.

Query Syntax :CALCulate:MARKer<n>:PEAK {MAXimum|MINimum|NEXT|RIGHT|LEFT}

Parameter	<n>	<NR1> Marker number 1~6
	MAXimum	Highest peak value

MIMimum	Lowest peak value
NEXT	Next peak
RIGHt	Next peak right
LEFT	Next peak left

Example :CALC:MARK1:PEAK NEXT

:CALCulate:MARKer:PEAK:CTRack:STATe
 →
 →

Description Sets or queries the state of the Peak Track function. The Peak Track function only applies to the currently selected marker.

Syntax :CALCulate:MARKer:PEAK:CTRack:STATe {ON|OFF|1|0}

Query Syntax :CALCulate:MARKer:PEAK:CTRack:STATe?

Parameter	0	Turn peak track off.
	1	Turn peak track on.
	OFF	Turn peak track off.
	ON	Turn peak track on.

Return parameter	0	Peak track is off.
	1	Peak track is on.

Example :CALC:MARK:PEAK:CTR:STAT ON

:CALCulate:MARKer:PEAK:DATA? →

Description Returns all the top 10 peak data values in CSV format (returns the contents of the peak table).
 The <csv data> data contains 10 pairs of data from the top 10 peaks. Each pair includes the peak frequency and the peak amplitude. There are a total of 10 pairs of data points (20 data entries in total) for the <csv data> data.

Query syntax :CALCulate:MARKer:PEAK:DATA?

Return parameter	<csv data>	pk#1 freq, pk#1 amp,..... pk#10 freq, pk#10 amp.
------------------	------------	--

Example :CALC:MARK:PEAK:DATA?
>1.250e+08,-5.052e+01,1.065000000e+09,...

:CALCulate:MARKer:PEAK:EXCursion Set →
→ Query

Description Sets or queries the peak excursion value.

Syntax :CALCulate:MARKer:PEAK:EXCursion <rel ampl>

Query Syntax :CALCulate:MARKer:PEAK:EXCursion?

Parameter <rel ampl> Peak excursion dB (offset from threshold)

Return parameter <NR3> Peak excursion in dB.

Example :CALC:MARK:PEAK:EXC 6 db

:CALCulate:MARKer:PEAK:SORT:TYPE Set →
→ Query

Description Sets or queries the peak sort type for the peak table.

Syntax :CALCulate:MARKer:PEAK:SORT:TYPE
{FREQuency|AMPLitude}

Query Syntax :CALCulate:MARKer:PEAK:SORT:TYPE?

Parameter/ Return parameter FREQuency Sort by frequency.
AMPLitude Sort by amplitude.

Example :CALC:MARK:PEAK:SORT:TYPE FREQ

:CALCulate:MARKer:PEAK:TABLE:STATe Set →
→ Query

Description Sets or queries the state of the Peak Table.

Syntax :CALCulate:MARKer:PEAK:TABLE:STATe {ON|OFF|1|0}

Query Syntax :CALCulate:MARKer:PEAK:TABLE:STATe?

Parameter 0 Turn peak table off.
1 Turn peak table on.
OFF Turn peak table off.

	ON	Turn peak table on.
Return parameter	0	peak table is off.
	1	peak table is on.

Example :CALC:MARK:PEAK:TABL:STAT ON

:CALCulate:MARKer:PEAK:THReshold  

Description	Sets or queries the peak threshold value.	
Syntax	:CALCulate:MARKer:PEAK:THReshold < ampl>	
Query Syntax	:CALCulate:MARKer:PEAK:THReshold?	
Parameter	< ampl>	Peak Threshold level
Return parameter	<NR3>	Peak threshold. Note: the unit returned depends on the currently set vertical units.

Example :CALC:MARK:PEAK:THR -3 dBm

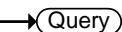
:CALCulate:MARKer:PEAK:THReshold: STATE  

Description	Sets or queries the state of the Peak Threshold.	
Syntax	:CALCulate:MARKer:PEAK:THReshold:STATE {ON OFF 1 0}	
Query Syntax	:CALCulate:MARKer:PEAK:THReshold:STATE?	
Parameter	0	Turn peak threshold off.
	1	Turn peak threshold on.
	OFF	Turn peak threshold off.
	ON	Turn peak threshold on.
Return parameter	0	Peak threshold is off.
	1	Peak threshold is on.

Example :CALC:MARK:PEAK:THR:STAT ON

:CALCulate:MARKer<n>:SET (Set) →

Description	Sets the selected marker to one of five preset positions.	
Query Syntax	:CALCulate:MARKer<n>:SET {CENTer START STOP STEP RLEVel}	
Parameter	<n> CENTer START STOP STEP RLEVel	<NR1> Marker number 1~6 Set to center frequency Set to start frequency Set to stop frequency Set to CF STEP frequency Set to the Reference level
Example	:CALC:MARK1:SET CENT	

:CALCulate:MARKer<n>:STATe (Set) →
→ (Query)

Description	Sets or queries the state of the selected marker.	
Syntax	:CALCulate:MARKer<n>:STATe {ON OFF 1 0}	
Query Syntax	:CALCulate:MARKer<n>:STATe?	
Parameter	<n> 0 1 OFF ON	<NR1> Marker number 1~6 Turn the selected marker off. Turn the selected marker on. Turn the selected marker off. Turn the selected marker on.
Return parameter	0 1	The selected marker is off. The selected marker on.
Example	:CALC:MARK1:STAT ON	

:CALCulate:MARKer:TABLE:STATe (Set) →
→ (Query)

Description	Sets or queries the state of the marker table.	
Syntax	:CALCulate:MARKer:TABLE:STATe {ON OFF 1 0}	
Query Syntax	:CALCulate:MARKer:TABLE:STATe	

Parameter	0	Turn the table off.
	1	Turn the table on.
	OFF	Turn the table off.
	ON	Turn the table on.
Return parameter	0	The table is off.
	1	The table is on.
Example	:CALC:MARK:TABL:STAT ON	

Set →
 → Query

:CALCulate:MARKer<n>:TRACe

Description Assigns the selected marker to a trace. Queries which trace the selected marker is assigned to.

Syntax	:CALCulate:MARKer<n>:TRACe <trace name>	
Query Syntax	:CALCulate:MARKer<n>:TRACe?	
Parameter/	<n>	<NR1> Marker number 1~6
Return parameter	<trace name>	The name of the trace: (1, 2, 3, 4)

Example :CALC:MARK2:TRAC 1

Set →
 → Query

:CALCulate:MARKer<n>:TRACe:AUTO

Description Sets or queries the state of the Marker Trace function. Allows the selected marker to be automatically assigned to a trace (on) or be to manually assigned a trace (off).

Syntax	:CALCulate:MARKer<n>:TRACe:AUTO {ON OFF 1 0}	
Query Syntax	:CALCulate:MARKer<n>:TRACe:AUTO?	
Parameter	<n>	<NR1> Marker number 1~6
	0	Turn the auto function off.
	1	Turn the auto function on.
	OFF	Turn the auto function off.
	ON	Turn the auto function on.

Return parameter	0	The auto function is off.
	1	The auto function is on.

Example :CALC:MARK2:TRAC:AUTO OFF

:CALCulate:MARKer<n>:TYPE

Set →
→ Query

Description Sets or queries the marker type.

Syntax :CALCulate:MARKer<n>:TYPE {NORMAL|DELTA}

Query Syntax :CALCulate:MARKer<n>:TYPE?

Parameter/	<n>	<NR1> Marker number 1~6
Return parameter	<NORMAL>	Normal marker
	<DELTA>	Delta marker

Example :CALC:MARK1:TYPE NORM

:CALCulate:MARKer<n>:X

Set →
→ Query

Description Sets or returns the marker position in Hz.

Syntax :CALCulate:MARKer<n>:X <freq>

Query Syntax :CALCulate:MARKer<n>:X?

Parameter/	<n>	<NR1> Marker number 1~6
Return parameter	<freq>	Hz

Example :CALC:MARK4:X 2.0e+6

:CALCulate:MARKer<n>:Y?

→ Query

Description Returns the marker's vertical position in the current unit.

Query Syntax :CALCulate:MARKer<n>:Y?

Parameter	<n>	<NR1> Marker number 1~6
-----------	-----	-------------------------

Return parameter	<NR3>	Power or voltage
------------------	-------	------------------

Example :CALC:MARK1:Y?
>-5.43e+1

:CALCulate:MATH:PDIF**Set** →

Description	Calculates the power difference between two traces (T1 -the first trace operand- and T2 -the second trace operand-).	
Syntax	:CALCulate:MATH:PDIF <Destination Trace,T1,T2>	
Parameter	< Destination Trace>* < T1> < T2>	TRACe1, TRACe2, TRACe3 or TRACe4
Note	* The destination trace cannot be the same as the T1 or T2 trace.	
Example	:CALC:MATH:PDIF TRAC1,TRAC2,TRAC3	

:CALCulate:MATH:LDIF**Set** →

Description	Calculates the logarithmic difference between two traces (T1 – the first trace operand and T2 – the second trace operand) and assigns the designated reference level to the destination trace.	
Syntax	:CALCulate:MATH:LDIF <Destination Trace,T1,T2, Ref>	
Parameter	< Destination Trace>* < T1> < T2> <Ref>	TRACe1, TRACe2, TRACe3 or TRACe4 <NR1>Reference level
Note	* The destination trace cannot be the same the T1 or T2 traces.	
Example	:CALC:MATH:LDIF TRAC1,TRAC2,TRAC3,20	

:CALCulate:MATH:LOFF**Set** →

Description	Adds an offset to T1 -the source trace- and puts the result into a destination trace.
-------------	---

Syntax	:CALCulate:MATH:LOFF <Destination Trace,T1,offset>	
Parameter	< Destination Trace >* < T1> -source trace- <offset>	TRACe1, TRACe2, TRACe3 or TRACe4 <NRf>Offset in dB
Note	* The destination trace cannot be the same as the source trace.	
Example	:CALC:MATH:LOFF TRAC1,TRAC2,6	

:CALCulate:NDB:STATe (Set) →
→ (Query)

Description	Sets or queries the state of the NdB BW function.	
Syntax	:CALCulate:NDB:STATe {ON OFF 1 0}	
Query Syntax	:CALCulate:NDB:STATe?	
Parameter	0 1 OFF ON	Turn NdB BW off. Turn NdB BW on. Turn NdB BW off. Turn NdB BW on.
Return parameter	0 1	NdB BW is off. NdB BW is on.
Example	:CALC:NDB:STAT ON	

:CALCulate:NDB:BANDwidth|BWIDth? → (Query)

Description	Returns the NdB bandwidth measurement.	
Query Syntax	:CALCulate:NDB:BANDwidth BWIDth?	
Return parameter	<NR3>	NdB bandwidth in Hz.
Example	:CALC:NDB:BAND? >5.5e+04	

:CALCulate:NORMAlize:STATe



Description	Turns the tracking generator normalization on/off or queries its state.	
Syntax	:CALCulate:NORMAlize:STATe{ON OFF 1 0}	
Query Syntax	:CALCulate:NORMAlize:STATe?	
Parameter	0	Turn normalization off.
	1	Turn normalization on.
	OFF	Turn normalization off.
	ON	Turn normalization on.
Return parameter	0	normalization is off.
	1	normalization is on.
Example	:CALC:NORM:STAT ON	

:CALCulate:OCBW:STATe

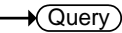

Description	Turns the OCBW measurement on/off or queries its state.	
Syntax	:CALCulate:OCBW:STATe {ON OFF 1 0}	
Query Syntax	:CALCulate:OCBW:STATe?	
Parameter	0	Turn OCBW off.
	1	Turn OCBW on.
	OFF	Turn OCBW off.
	ON	Turn OCBW on.
Return parameter	0	OCBW is off.
	1	OCBW is on.
Example	:CALC:OCBW:STAT ON	

:CALCulate:OCBW:BANDwidth|BWIDth?

Description	Returns the OCBW bandwidth measurement.
Query Syntax	:CALCulate:OCBW:BANDwidth BWIDth?

Return parameter	<NR3>	OCBW bandwidth in Hz.
Example	:CALC:OCBW:BAND? >4.1e+03	

:CALCulate:OCBW:CHPower? → Query

Description	Returns the OCBW channel power measurement.	
Query Syntax	:CALCulate:OCBW:CHPower?	
Return parameter	<NR3>	OCBW channel power in the current Y-axis unit.
Example	:CALC:OCBW:CHP? >9.13e+01	

:CALCulate:OCBW:POWer? → Query

Description	Returns the OCBW total power measurement.	
Query Syntax	:CALCulate:OCBW:POWer?	
Return parameter	<NR3>	OCBW total power in the current Y-axis unit.
Example	:CALC:OCBW:POW? >1.33e+01	

:CALCulate:OCBW:PSDensity? → Query

Description	Returns the OCBW power spectral density.	
Query Syntax	:CALCulate:OCBW:PSDensity?	
Return parameter	<NR3>	PSD in dBm/Hz.
Example	:CALC:OCBW:PSD? >9.933e+01	

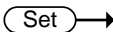
:CALCulate:P1DB:STATe

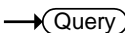

Description	Turns the P1DB function on or off.	
Syntax	:CALCulate:P1DB:STATe {ON OFF 1 0}	
Query Syntax	:CALCulate:P1DB:STATe?	
Parameter	OFF 0	Turns P1DB function off.
	ON 1	Turns P1DB function on.
Return parameter	0	Turns P1DB function off.
	1	Turns P1DB function on.
Example	:CALC:P1DB:STAT? >0	

:CALCulate:P1DB:NORMALize:STATe



Description	Turns the P1DB function on or off.	
Syntax	:CALCulate:P1DB:NORMALize:STATe {ON OFF 1 0}	
Query Syntax	:CALCulate:P1DB:NORMALize:STATe?	
Parameter	OFF 0	Turns the normalize function off.
	ON 1	Turns the normalize function on.
Return parameter	0	Normalize function is off.
	1	Normalize function is on.
Example	:CALC:P1DB:NORM:STAT? >0	

:CALCulate:P1DB:GAIN:AVERAge?

Description	Returns the P1dB average gain.	
Query Syntax	:CALCulate:P1DB:GAIN:AVERAge?	
Return parameter	<NR3>	Return the average gain in dB.
	N/A	Returns N/A if the P1dB value is not found or not applicable.

Return parameter <NR3> Power in the current Y-axis unit.

Example :CALC:PMET:POW?
>-0.83e+01

:CALCulate:PMETer:LIMit:STATe (Set) →
→ (Query)

Description Turns the pass/fail limits on/off in the Power Meter mode or queries its state.

Syntax :CALCulate:PMETer:LIMit:STATe {ON|OFF|1|0}

Query Syntax :CALCulate:PMETer:LIMit:STATe?

Parameter	0	Turns limits off.
	1	Turns limits on.
	OFF	Turns limits off.
	ON	Turns limits on.

Return parameter	0	Turns limits off.
	1	Turns limits on.

Example :CALC:PMET:LIM:STAT?
>1

:CALCulate:PMETer:LIMit:FAIL? → (Query)

Description Returns the pass/fail judgment.

Query Syntax :CALCulate:PMETer:LIMit:FAIL?

Return parameter	0	Pass, or limits are not on.
	1	Fail

Example :CALC:PMET:LIM:FAIL?
>1

:CALCulate:SEM:STATe (Set) →
→ (Query)

Description Turns the SEM measurement on/off or queries its state.

Syntax :CALCulate:SEM:STATe {ON|OFF|1|0}

Query Syntax	:CALCulate:SEM:STATe?	
Parameter	0	Turns SEM off.
	1	Turns SEM on.
	OFF	Turns SEM off.
	ON	Turns SEM on.
Return parameter	0	SEM is off.
	1	SEM is on.
Example	:CALC:SEM:STAT ON	

:CALCulate:SEM:OFFSet<n>:RESult? → **Query**

Description	Returns the start, stop frequencies as well as the pass/fail limits and judgements for the chosen offset.	
Query syntax	:CALCulate:SEM:OFFSet<n>:RESult?	
Parameter	<n>	Offset number 1~5.
Return parameter	<start freq>	Start frequency of the selected channel
	<low dBm>	Lower dBm measurement
	<low p/f>	Lower pass/fail limit judgment. 0 = pass, 1 = fail.
	<stop freq>	Stop frequency of the selected channel
	<upp dBm>	Upper dBm measurement
	<upp p/f>	Upper pass/fail limit judgment 0 = pass, 1 = fail.
Example	:CALC:SEM:OFFS1:RES? >9e+7, -7.9e+1,0,1.7e+7,-6.9e+1,0	

:CALCulate:TOI:DIFFerential? → **Query**

Description	Returns the third order intermodulation distortion.	
Query syntax	:CALCulate:TOI:DIFFerential?	
Return parameter	<base lower>	<NR3> dBc
	<base upper>	<NR3> dBc
	<3 rd order lower>	<NR3> dBc
	<3 rd order upper>	<NR3> dBc

Example :CALC:TOI:DIFF?
>0.0e+0,-1.67e-1,-1.09e+1,-6.61e+0

:CALCulate:TOI:FREQuency:DIFFerential? → **Query**

Description Returns the delta of the base lower frequency and base upper frequency.

Query syntax :CALCulate:TOI:FREQuency:DIFFerential?

Return parameter <NR3> Δf: Hz

Example :CALC:TOI:FREQ:DIFF?
>6.65e+5

Set →

:CALCulate:TOI:LIMit:STATe → **Query**

Description Turns the TOI pass/fail limit on/off or queries its state.

Syntax :CALCulate:TOI:LIMit:STATe {ON|OFF|1|0}

Query Syntax :CALCulate:TOI:LIMit:STATe?

Parameter	0	Turns pass/fail limit off.
	1	Turns pass/fail limit on.
	OFF	Turns pass/fail limit off.
	ON	Turns pass/fail limit on.

Return parameter	0	Turns pass/fail limit off.
	1	Turns pass/fail limit on.

Example :CALC:TOI:LIM:STAT ON

:CALCulate:TOI:RESult? → **Query**

Description Returns the third order intercept and the pass/fail judgments.

Query syntax :CALCulate:TOI:RESult?

Return parameter	<3 rd lower> <lower p/f>	3 rd order lower intercept 3 rd order lower pass/fail judgment. 0=pass, 1=fail
	<3 rd upper> <upper p/f>	3 rd order upper intercept 3 rd order lower pass/fail judgment 0=pass, 1=fail

Example :CALC:TOI:RES?
>-5.5e+1,0, -6.61e+1,0

:CALCulate:TOI:STATe (Set) →
→ (Query)

Description	Turns TOI measurement on/off or queries its state.	
Syntax	:CALCulate:TOI:STATe {ON OFF 1 0}	
Query Syntax	:CALCulate:TOI:STATe?	
Parameter	0 1 OFF ON	Turns TOI measurement off. Turns TOI measurement on. Turns TOI measurement off. Turns TOI measurement on.
Return parameter	0 1	TOI measurement is off. TOI measurement is on.
Example	:CALC:TOI:STAT ON	

CONFigure Commands

:CONFigure:MODE129

:CONFigure:MODE

Set →

→ Query

Description Sets or queries the operating mode, spectrum or power meter.

Syntax :CONFigure:MODE {SA | PMETer}

Query Syntax :CONFigure:MODE?

Parameter/	<SA>	Spectrum analyzer mode
Return parameter	<PMETer>	Power meter mode

Example :CONF:MODE PMET

DISPlay Commands

:DISPlay:BRIGhtness	132
:DISPlay:ENABle.....	132
:DISPlay:DEMod[:WINDow]:SYMBol:DATA?	132
:DISPlay:DEMod[:WINDow]:TRACe:X[:SCALe]	
:AUTO	133
:DISPlay:DEMod[:WINDow]:TRACe:X[:SCALe]	
:PDIVision.....	133
:DISPlay:DEMod[:WINDow]:TRACe:X[:SCALe]	
:RPOsition.....	134
:DISPlay:DEMod[:WINDow]:TRACe:X[:SCALe]	
:RVALue	134
:DISPlay:DEMod[:WINDow]:TRACe:Y[:SCALe]	
:AUTO	134
:DISPlay:DEMod[:WINDow]:TRACe:Y[:SCALe]	
:PDIVision.....	135
:DISPlay:DEMod[:WINDow]:TRACe:Y[:SCALe]	
:RPOsition.....	135
:DISPlay:DEMod[:WINDow]:TRACe:Y[:SCALe]	
:RVALue	135
:DISPlay:DEMod[:WINDow]:VIEW	136
:DISPlay:IQ[:WINDow]:TRACe:Y[:SCALe]	
:PDIVision.....	136
:DISPlay:IQ[:WINDow]:TRACe:Y[:SCALe]:RLEVel..	136
:DISPlay:IQ[:WINDow]:TRACe:Y[:SCALe]	
:RPOsition.....	137
:DISPlay:P1DB[:WINDow]:TRACe:Y[:SCALe]	
:LEVel?.....	137
:DISPlay[:WINDow]:NORMal	137
:DISPlay[:WINDow]:SPECTrogram	138
:DISPlay[:WINDow]:SPECTrogram:DELTamarker:X .	138
:DISPlay[:WINDow]:SPECTrogram:DELTamarker:Y .	138
:DISPlay[:WINDow]:SPECTrogram	
:DELTamarker:FREQuency?	139
:DISPlay[:WINDow]:SPECTrogram	
:DELTamarker:AMPLitude?.....	139
:DISPlay[:WINDow]:SPECTrogram	
:DELTamarker:INVerse:TIME?	139
:DISPlay[:WINDow]:SPECTrogram	
:DELTamarker:TIME?	140
:DISPlay[:WINDow]:SPECTrogram:MARKer:STATe .	140

:DISPlay[:WINDow]:SPECtrogram:MARKer:X	140
:DISPlay[:WINDow]:SPECtrogram:MARKer:Y	141
:DISPlay[:WINDow]:SPECtrogram:MARKer	
:FREQuency?	141
:DISPlay[:WINDow]:SPECtrogram:MARKer	
:AMPLitude?	141
:DISPlay[:WINDow]:SPECtrogram:MARKer:TIME? ..	142
:DISPlay[:WINDow]:SPLit:NORMal:ALTErnate.....	142
:DISPlay[:WINDow]:SPLit:NORMal:ACTive	142
:DISPlay[:WINDow]:SPLit:SPECtrogram	143
:DISPlay[:WINDow]:SPLit:TOPO.....	143
:DISPlay[:WINDow]:TOPO	143
:DISPlay[:WINDow]:TOPO:MARKer:PERCent?	143
:DISPlay[:WINDow]:TOPO:MARKer:X	144
:DISPlay[:WINDow]:TOPO:MARKer:Y.....	144
:DISPlay[:WINDow]:TOPO:MARKer: FREQuency? ..	144
:DISPlay[:WINDow]:TOPO:MARKer: AMPLitude?....	145
:DISPlay[:WINDow]:TOPO:MARKer:STATe.....	145
:DISPlay[:WINDow]:TOPO:DELTAmarker:X.....	145
:DISPlay[:WINDow]:TOPO:DELTAmarker:Y	146
:DISPlay[:WINDow]:TOPO:DELTAmarker	
:FREQuency?	146
:DISPlay[:WINDow]:TOPO:DELTAmarker	
: AMPLitude?	146
:DISPlay[:WINDow]:TOPO:DELTAmarker	
:PERCent?	147
:DISPlay[:WINDow]:TRACe<n>:MODE.....	147
:DISPlay[:WINDow]:TRACe<n>:MODE:MAXHold? ..	147
:DISPlay[:WINDow]:TRACe:Y:DLINe	148
:DISPlay[:WINDow]:TRACe:Y:DLINe:STATe	148
:DISPlay[:WINDow]:TRACe:Y[:SCALE]:AUTO	148
:DISPlay[:WINDow]:TRACe:Y[:SCALE]:NRLevel.....	149
:DISPlay[:WINDow]:TRACe:Y[:SCALE]:NRPosition... ..	149
:DISPlay[:WINDow]:TRACe:Y[:SCALE]: PDIVision: ..	149
:DISPlay[:WINDow]:TRACe:Y[:SCALE]:POSition	150
:DISPlay[:WINDow]:TRACe:Y[:SCALE]:RLEVel	150
:DISPlay[:WINDow]:TRACe:Y[:SCALE]	
:RLEVel:OFFSet.....	151
:DISPlay[:WINDow]:TRACe:Y[:SCALE]:SPACing.....	151
:DISPlay[:WINDow]:TRACe:Y[:SCALE]:STATe	151

Set →
 → Query

:DISPlay:BRIGhtness

Description	Sets or queries the LCD brightness level.	
Syntax	:DISPlay:BRIGhtness {HIGH MIDDLE LOW}	
Query Syntax	:DISPlay:BRIGhtness?	
Parameter/ Return parameter	<HIGH> <MIDDLE> <LOW>	High brightness level Mid brightness level Low brightness level
Example	:DISP:BRIG HIGH	

Set →
 → Query

:DISPlay:ENABle

Description	Turns the LCD backlight on/off.	
Syntax	:DISPlay:ENABle {OFF ON 0 1}	
Query Syntax	:DISPlay:ENABle?	
Parameter	0 1 OFF ON	Turn LCD backlight off. Turn LCD backlight on. Turn LCD backlight off. Turn LCD backlight on.
Return parameter	0 1	LCD backlight is off. LCD backlight is on.
Example	:DISP:ENAB? >1	

:DISPlay:DEMod[:WINDow]:SYMBol:DATA? → Query

Description	Returns symbol data	
Query Syntax	:DISPlay:DEMod:WINDow:SYMBol:DATA?	
Return parameter	<binary> or <hexadecimal>	<4 bit data> ...

Example :DISP:DEM:SYMB:DATA?
>#HEED2124

:DISPlay:DEMod[:WINDow]:TRACe:X Set →
[:SCALE]:AUTO → Query

Description Turns auto scale on/off for AM/FM demodulation or queries its state. When set to ON, the auto scale function will be executed continuously.

Syntax :DISPlay:DEMod[:WINDow]:TRACe:X[:SCALE]:AUTO {OFF|ON|0|1}

Query Syntax :DISPlay:DEMod[:WINDow]:TRACe:X[:SCALE]:AUTO?

Parameter	0	Turn Auto Scale off.
	1	Turn Auto Scale on.
	OFF	Turn Auto Scale off.
	ON	Turn Auto Scale on.

Return parameter	0	Auto Scale is off.
	1	Auto Scale is on.

Example :DISP:DEM:TRAC:X:AUTO ON

:DISPlay:DEMod[:WINDow]:TRACe:X Set →
[:SCALE]:PDIVision → Query

Description Sets or queries the time axis scale/div.

Syntax :DISPlay:DEMod[:WINDow]:TRACe:X[:SCALE]:PDIVision <time>

Query Syntax :DISPlay:DEMod[:WINDow]:TRACe:X[:SCALE]:PDIVision?

Parameter	<time>	<NRf>
-----------	--------	-------

Return parameter	<NR3>	Seconds
------------------	-------	---------

Example :DISP:DEM:TRAC:X:PDIV 2 ms

:DISPlay:DEMod[:WINDow]:TRACe:X (Set) →
 [:SCALe]:RPOSition → (Query)

Description	Sets or queries the Reference Position of the trace for AM/FM demodulation (x-axis grid division).	
Syntax	:DISPlay:DEMod[:WINDow]:TRACe:X[:SCALe]:RPOSition <integer>	
Query Syntax	:DISPlay:DEMod[:WINDow]:TRACe:X[:SCALe]:RPOSition?	
Parameter/ Return parameter	<integer>	<NR1>1~10
Example	:DISP:DEM:TRAC:X:RPOS 2	

:DISPlay:DEMod[:WINDow]:TRACe:X (Set) →
 [:SCALe]:RVALue → (Query)

Description	Sets or queries the Reference value time.	
Syntax	:DISPlay:DEMod[:WINDow]:TRACe:X[:SCALe]:RVALue <time>	
Query Syntax	:DISPlay:DEMod[:WINDow]:TRACe:X[:SCALe]:RVALue?	
Parameter	<time>	<NRf>
Return parameter	<NR3>	Seconds
Example	:DISP:DEM:TRAC:X:RVAL 2 ms	

:DISPlay:DEMod[:WINDow]:TRACe:Y (Set) →
 [:SCALe]:AUTO

Description	Sets the vertical display scale to auto for AM/FM demodulation.	
Syntax	:DISPlay:DEMod[:WINDow]:TRACe:Y[:SCALe]:AUTO	
Example	:DISP:DEM:TRAC:Y:AUTO	

:DISPlay:DEMod[:WINDow]:TRACe:Y (Set) →
[:SCALe]:PDIVision → (Query)

Description	Sets or queries the Y-axis scale per division.	
Syntax	:DISPlay:DEMod[:WINDow]:TRACe:Y[:SCALe]:PDIVision <NRf>	
Query Syntax	:DISPlay:DEMod[:WINDow]:TRACe:Y[:SCALe]:PDIVision?	
Parameter	<NRf>	AM Unit: %, FM Unit: Hz
Return parameter	<NR3>	AM Unit: %, FM Unit: Hz
Example	:DISP:DEM:TRAC:Y:PDIV 2.3e+1	

:DISPlay:DEMod[:WINDow]:TRACe:Y (Set) →
[:SCALe]:RPOStion → (Query)

Description	Sets or queries the Reference Position of the trace for AM/FM demodulation (y-axis grid division).	
Syntax	:DISPlay:DEMod[:WINDow]:TRACe:Y[:SCALe]:RPOStion <integer>	
Query Syntax	:DISPlay:DEMod[:WINDow]:TRACe:Y[:SCALe]:RPOStion?	
Parameter/ Return parameter	<integer>	<NR1>1~10
Example	:DISP:DEM:TRAC:Y:RPOS 2	

:DISPlay:DEMod[:WINDow]:TRACe:Y (Set) →
[:SCALe]:RVALue → (Query)

Description	Sets or queries the Reference value (AM: %, FM: Hz).	
Syntax	:DISPlay:DEMod[:WINDow]:TRACe:Y[:SCALe]:RVALue <NRf>	

Query Syntax	:DISPlay:DEMod[:WINDow]:TRACe:Y[:SCALe]: RVALue?	
Parameter	<NRf>	AM Unit: %, FM Unit: Hz
Return parameter	<NR3>	AM Unit: %, FM Unit: Hz
Example	:DISP:DEM:TRAC:Y:RVAL 2	

:DISPlay:DEMod[:WINDow]:VIEW (Set) →

Description	Sets the demod display mode to symbol or waveform.	
Syntax	:DISPlay:DEMod[:WINDow]:VIEW {SYMBol WAVEform}	
Example	:DISP:DEM:VIEW SYMB	

:DISPlay:IQ[:WINDow]:TRACe:Y[:SCALe]
:PDIVision (Set) →
→ (Query)

Description	Sets or queries the Y-axis scale per division for IQ analysis function.	
Syntax	:DISPlay:IQ[:WINDow]:TRACe:Y[:SCALe]: PDIVision <voltage>	
Query Syntax	:DISPlay:IQ[:WINDow]:TRACe:Y[:SCALe]:PDIVision?	
Parameter	< voltage >	voltage
Return parameter	< NR3>	
Example	:DISP:IQ:TRAC:Y:PDIV 2.3e+1	

:DISPlay:IQ[:WINDow]:TRACe:Y[:SCALe]:
RLEVel (Set) →
→ (Query)

Description	Sets or queries the Y-axis reference level for the IQ analysis function.	
Syntax	:DISPlay:IQ[:WINDow]:TRACe:Y[:SCALe]:RLEVel <voltage >	

Query Syntax :DISPlay:IQ[:WINDow]:TRACe:Y[:SCALe]:RLEVel?

Parameter < voltage > <NRf>

Return parameter <NR3>

Example :DISP:IQ:TRAC:Y:RLEV 1 mV

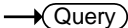
:DISPlay:IQ[:WINDow]:TRACe:Y[:SCALe] 
 :RPOSition 

Description Sets or queries the Reference Position of the trace for IQ analysis function. (y-axis grid division).

Syntax :DISPlay:IQ[:WINDow]:TRACe:Y[:SCALe]
 :RPOSition <integer>

Query Syntax :DISPlay:IQ[:WINDow]:TRACe:Y[:SCALe]
 :RPOSition?

Parameter/
 Return parameter <integer> <NR1>1~10

Example :DISP:IQ:TRAC:Y:RPOS 2

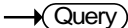
:DISPlay:P1DB[:WINDow]:TRACe:Y[:SCALe]:
 LEVel? 

Description Returns the P1dB normalization value (offset) in dB. Equivalent to the “Execute Norm.” value in the P1dB Normalize function.

Query syntax :DISPlay:P1DB[:WINDow]:TRACe:Y[:SCALe]:LEVel?

Return parameter <NR3> Returns the offset in dB.

Example :DISP:P1DB:TRAC:Y:LEV?
 >0.00e+00.

:DISPlay[:WINDow]:NORMal 

Description Sets the display window to the normal trace mode.

Syntax :DISPlay[:WINDow]:NORMal

Example :DISP:NORM

:DISPlay[:WINDow]:SPECtrogram (Set) →

Description Sets the display window to spectrogram mode.

Syntax :DISPlay[:WINDow]:SPECtrogram

Example :DISP:SPEC

:DISPlay[:WINDow]:SPECtrogram (Set) →
 :DELTamarker:X → (Query)

Description Sets or queries spectrogram delta marker's x-axis.

Syntax :DISPlay[:WINDow]:SPECtrogram:DELTamarker:X
<NR1>

Query Syntax :DISPlay[:WINDow]:SPECtrogram:DELTamarker:X?

Parameter/Return parameter <NR1> X axis value.

Example :DISP:SPEC:DELT:X 200

:DISPlay[:WINDow]:SPECtrogram (Set) →
 :DELTamarker:Y → (Query)

Description Sets or queries spectrogram delta marker's y-axis.

Syntax :DISPlay[:WINDow]:SPECtrogram:DELTamarker:Y
<NR1>

Query Syntax :DISPlay[:WINDow]:SPECtrogram:DELTamarker:Y?

Parameter/Return parameter <NR1> Y axis value.

Example :DISP:SPEC:DELT:Y 30

:DISPlay[:WINDow]:SPECTrogram
:DELTamarker:FREQuency?

→ Query

Description	Returns spectrogram delta marker frequency value
Query syntax	:DISPlay[:WINDow]:SPECTrogram:DELTamarker:FREQuency?
Return parameter	<NR3> Frequency in Hz.
Example	:DISP:SPEC:DELT:FREQ? >-3.000e+04

:DISPlay[:WINDow]:SPECTrogram
:DELTamarker:AMPLitude?

→ Query

Description	Returns spectrogram delta marker amplitude value.
Query syntax	:DISPlay[:WINDow]:SPECTrogram:DELTamarker:AMPLitude?
Return parameter	<NR3> Amplitude in dB.
Example	:DISP:SPEC:DELT:AMPL? >7.347e+00

:DISPlay[:WINDow]:SPECTrogram
:DELTamarker:INVerse:TIME?

→ Query

Description	Returns the frequency delta between the reference and delta marker in the spectrogram display view.
Query syntax	:DISPlay[:WINDow]:SPECTrogram:DELTamarker:INVerse:TIME?
Return parameter	<NR3> Returns the frequency delta in Hz.
Example	:DISP:SPEC:DELT:INV:TIME? >1.233e+06

:DISPlay[:WINDow]:SPECTrogram
 :DELTamarker:TIME? → Query

Description	Returns spectrogram delta marker time value.
Query syntax	:DISPlay[:WINDow]:SPECTrogram:DELTamarker:TIME?
Return parameter	<NR3> Time in seconds
Example	:DISP:SPEC:DELT:TIME? >1.94e-01

:DISPlay[:WINDow]:SPECTrogram:MARKer Set →
 :STATe → Query

Description	Sets or queries the state of the spectrogram marker.
Syntax	:DISPlay[:WINDow]:SPECTrogram:MARKer:STATe {OFF ON 0 1}
Query Syntax	:DISPlay[:WINDow]:SPECTrogram:MARKer:STATe?
Parameter	OFF 0 Turn spectrogram marker off. ON 1 Turn spectrogram marker on.
Return parameter	0 Spectrogram marker is off. 1 Spectrogram marker is on.
Query Example	:DISP:SPEC:MARK:STAT? >1

:DISPlay[:WINDow]:SPECTrogram:MARKer Set →
 :X → Query

Description	Sets or queries spectrogram marker's x-axis.
Syntax	:DISPlay[:WINDow]:SPECTrogram:MARKer:X <NR1>
Query Syntax	:DISPlay[:WINDow]:SPECTrogram:MARKer:X?
Parameter/Return parameter	<NR1> X axis value.
Example	:DISP:SPEC:MARK:X 20

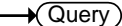
:DISPlay[:WINDow]:SPECtrogram:MARKer 
:Y 

Description	Sets or queries spectrogram marker's y-axis.	
Syntax	:DISPlay[:WINDow]:SPECtrogram:MARKer:Y <NR1>	
Query Syntax	:DISPlay[:WINDow]:SPECtrogram:MARKer:Y?	
Parameter/Return parameter	<NR1>	Y axis value.
Example	:DISP:SPEC:MARK:Y 50	

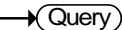
:DISPlay[:WINDow]:SPECtrogram:MARKer
:FREQuency? 

Description	Returns spectrogram marker frequency value.	
Query syntax	:DISPlay[:WINDow]:SPECtrogram:MARKer :FREQuency?	
Return parameter	<NR3>	Frequency in Hz.
Example	:DISP:SPEC:MARK:FREQ? >3.333e+03	

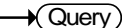
:DISPlay[:WINDow]:SPECtrogram:MARKer
:AMPLitude? 

Description	Returns spectrogram marker amplitude value.	
Query syntax	:DISPlay[:WINDow]:SPECtrogram:MARKer :AMPLitude?	
Return parameter	<NR3>	Amplitude in dBm.
Example	:DISP:SPEC:MARK:AMPL? >-6.969e+01	

**:DISPlay[:WINDow]:SPECtrogram:MARKer
:TIME?** → Query

Description	Returns spectrogram marker time value.
Query syntax	:DISPlay[:WINDow]:SPECtrogram:MARKer:TIME?
Return parameter	<NR3> Time in seconds
Example	:DISP:SPEC:MARK:TIME? >4.92e-01

**:DISPlay[:WINDow]:SPLit:NORMAL:
ALternate** Set →

Description	Turns on the Alternate Sweep function for split window mode, both windows are in the normal trace mode. (we also have Spectrogram and Topographic mode)
Syntax	:DISPlay[:WINDow]:SPLit:NORMAL:ALternate
Example	:DISP:SPL:NORM:ALT

:DISPlay[:WINDow]:SPLit:NORMAL:ACTIVE Set →

Description	Sets which window (upper or lower) to display the normal trace mode in. It also becomes the active window. This command will also put the screen into split-screen mode if it is not already.
Syntax	:DISPlay[:WINDow]:SPLit:NORMAL:ACTIVE {UPPer LOWer}
Example	:DISP:SPL:NORM:ACT UPP

:DISPlay[:WINDow]:SPLit:SPECtrogram Set →

Description Sets the split screen mode to Spectrogram + Spectrum.

Syntax :DISPlay[:WINDow]:SPLit:SPECtrogram

Example :DISP:SPL:SPEC

:DISPlay[:WINDow]:SPLit:TOPO Set →

Description Sets the split screen mode to Topographic + Spectrum.

Syntax :DISPlay[:WINDow]:SPLit:TOPO

Example :DISP:SPL:TOPO

:DISPlay[:WINDow]:TOPO Set →

Description Sets the display window to topographic.

Syntax :DISPlay[:WINDow]:TOPO

Example :DISP:TOPO

:DISPlay[:WINDow]:TOPO:MARKer:PERCent?
t? Query

Description Returns the percentage of traces that cross the reference marker position in the topographic display view.

Query syntax :DISPlay[:WINDow]:TOPO:MARKer:PERCent?

Return parameter <NR3>

Example :DISP:TOPO:MARK:PERC?
>0.000e+00

:DISPlay[:WINDow]:TOPO:MARKer:X (Set) →
→ (Query)

Description	Sets or queries topographic marker's x-axis value.	
Syntax	:DISPlay[:WINDow]:TOPO:MARKer:X <NR1>	
Query Syntax	:DISPlay[:WINDow]:TOPO:MARKer:X?	
Parameter/Return parameter	<NR1>	X axis value.
Example	:DISP:TOPO:MARK:X 50	

:DISPlay[:WINDow]:TOPO:MARKer:Y (Set) →
→ (Query)

Description	Sets or queries topographic marker's y-axis value.	
Syntax	:DISPlay[:WINDow]:TOPO:MARKer:Y <NR1>	
Query Syntax	:DISPlay[:WINDow]:TOPO:MARKer:Y?	
Parameter/Return parameter	<NR1>	Y axis value.
Example	:DISP:TOPO:MARK:Y 75	

:DISPlay[:WINDow]:TOPO:MARKer:FREQuency? → (Query)

Description	Returns topographic marker frequency value.	
Query syntax	:DISPlay[:WINDow]:TOPO:MARKer:FREQuency?	
Return parameter	<NR3>	Frequency in Hz.
Example	:DISP:TOPO:MARK:FREQ? >8.333e+03	

**:DISPlay[:WINDow]:TOPO:MARKer:
AMPLitude?**

→ **Query**

Description	Returns topographic marker amplitude value.
Query syntax	:DISPlay[:WINDow]:TOPO:MARKer:AMPLitude?
Return parameter	<NR3> Amplitude in dBm.
Example	:DISP:TOPO:MARK:AMPL? >-8.333e+01

Set →

:DISPlay[:WINDow]:TOPO:MARKer:STATe

→ **Query**

Description	Sets or queries the state of the topographic marker.
Syntax	:DISPlay[:WINDow]:TOPO:MARKer:STATe {OFF ON 0 1}
Query Syntax	:DISPlay[:WINDow]:TOPO:MARKer:STATe?
Parameter	OFF 0 Turn topographic marker off. ON 1 Turn topographic marker on.
Return parameter	0 Topographic marker is off. 1 Topographic marker is on.
Query Example	:DISP:TOPO:MARK:STAT? >1

Set →

:DISPlay[:WINDow]:TOPO:DELTaMarker:X

→ **Query**

Description	Sets or queries topographic delta marker's x-axis value.
Syntax	:DISPlay[:WINDow]:TOPO:DELTaMarker:X <NR1>
Query Syntax	:DISPlay[:WINDow]:TOPO:DELTaMarker:X?
Parameter/Return parameter	<NR1> X axis value.
Example	:DISP:TOPO:DELT:X 250

:DISPlay[:WINDow]:TOPO:DELTamarker:Y (Set) →
→ (Query)

Description	Sets or queries topographic delta marker's y-axis value.
Syntax	:DISPlay[:WINDow]:TOPO:DELTamarker:Y <NR1>
Query Syntax	:DISPlay[:WINDow]:TOPO:DELTamarker:Y?
Parameter/Return parameter	<NR1> Y axis value.
Example	:DISP:TOPO:DELT:Y 100

:DISPlay[:WINDow]:TOPO:DELTamarker:FREQuency? → (Query)

Description	Returns topographic delta marker frequency value.
Query syntax	:DISPlay[:WINDow]:TOPO:DELTamarker:FREQuency?
Return parameter	<NR3> Frequency in Hz.
Example	:DISP:TOPO:DELT:FREQ? >4.166e+04

:DISPlay[:WINDow]:TOPO:DELTamarker:AMPLitude? → (Query)

Description	Returns topographic delta marker's amplitude value.
Query syntax	:DISPlay[:WINDow]:TOPO:DELTamarker:AMPLitude?
Return parameter	<NR3> Amplitude in dB.
Example	:DISP:TOPO:DELT:AMPL? >7.777e+01

:DISPlay[:WINDow]:TOPO:DELTamarker
:PERCent?

→ Query

Description Returns the percentage of traces that cross the delta marker position in the topographic display view.

Query syntax :DISPlay[:WINDow]:TOPO:DELTamarker:PERCent?

Return parameter <NR3>

Example :DISP:TOPO:DELT:PERC?
>6.667e+01

:DISPlay[:WINDow]:TRACe<n>:MODE

Set →

Description Sets the operation mode of the selected trace.

Syntax :DISPlay[:WINDow]:TRACe<n>:MODE
{WRITe|VIEW|BLANK|MAXHold|MINHold}

Parameter	<n>	<NR1> Trace number 1~4
	WRITe	Clear and Write
	VIEW	Hold the last trace
	BLANK	Clears the trace
	MAXHold	Hold the maximum/minimum points
	MINHold	from each sweep

Example :DISP:TRAC4:MODE VIEW

:DISPlay[:WINDow]:TRACe<n>:MODE
:MAXHold?

→ Query

Description Returns the maxhold threshold level. Any part of the trace below this threshold won't be held when the detector is set to Maxhold.

Query syntax :DISPlay[:WINDow]:TRACe<n>:MODE:MAXHold?

Return parameter <n> <NR1> Trace number.
<NR3>

Example :DISP:TRAC2:MODE:MAXH?
>-2.000e+01

:DISPlay[:WINDow]:TRACe:Y:DLINe Set →
→ Query

Description	Sets or queries the display line amplitude level.	
Syntax	:DISPlay[:WINDow]:TRACe:Y:DLINe <ampl>	
Query Syntax	:DISPlay[:WINDow]:TRACe:Y:DLINe?	
Parameter	<ampl>	<NRf> Power or voltage in the current Y-axis unit.
Return parameter	<NR3>	
Example	:DISP:TRAC:Y:DLIN -5.0e+01	

:DISPlay[:WINDow]:TRACe:Y:DLINe:STATe Set →
→ Query

Description	Turns the display line on/off or queries its state.	
Syntax	:DISPlay[:WINDow]:TRACe:Y:DLINe:STATe {OFF ON 0 1}	
Query Syntax	:DISPlay[:WINDow]:TRACe:Y:DLINe:STATe?	
Parameter	0 1 OFF ON	Turn display line off. Turn display line on. Turn display line off. Turn display line on.
Return parameter	0 1	The display line is off. The display line is on.
Example	:DISP:TRAC:Y:DLIN:STAT ON	

:DISPlay[:WINDow]:TRACe:Y[:SCALe]:AUTO Set →

Description	Equivalent to Amplitude>Autoscale[F4] when operating via the front panel.	
Syntax	:DISPlay[:WINDow]:TRACe:Y[:SCALe]:AUTO {ONCE}	
Parameter	<ONCE>	Compulsory parameter.

Example :DISP:TRAC:Y:AUTO ONCE

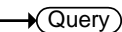
:DISPlay[:WINDow]:TRACe:Y[:SCALe]:
NRLevel  

Description Sets or queries the normalized reference level for the TG option.

Syntax :DISPlay[:WINDow]:TRACe:Y[:SCALe]:NRLevel <ampl>

Query Syntax :DISPlay[:WINDow]:TRACe:Y[:SCALe]:NRLevel?

Parameter <ampl> <NRf> Power or voltage in the current Y-axis unit.

Return parameter <NR3>

Example :DISP:TRAC:Y:NRLevel 5 dB

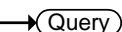
:DISPlay[:WINDow]:TRACe:Y[:SCALe]:
NRPosition  

Description Sets or queries the position of the normalized reference level. The 0~10 Y-axis grid divisions correspond to the bottom~top grid divisions.

Syntax :DISPlay[:WINDow]:TRACe:Y[:SCALe]:NRPosition <integer>

Query Syntax :DISPlay[:WINDow]:TRACe:Y[:SCALe]:NRPosition?

Parameter/
Return parameter <integer> <NR1> 0~10

Example :DISP:TRAC:Y:NRP 5

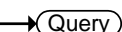
:DISPlay[:WINDow]:TRACe:Y[:SCALe]:
PDIVision:  

Description Sets or queries the Y-axis scale/div when the amplitude scale is logarithmic.

Syntax :DISPlay[:WINDow]:TRACe:Y[:SCALe]:PDIVision{1|2|5|10}

Query Syntax :DISPlay[:WINDow]:TRACe:Y[:SCALe]:PDIVision?

Parameter/	1	1 dB
Return parameter	2	2 dB
	5	5 dB
	10	10 dB

Example :DISP:TRAC:Y:PDIV 10

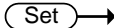
:DISPlay[:WINDow]:TRACe:Y[:SCALe]:
 POSition

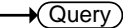

Description Sets or queries the position of the on-screen scale.

Syntax :DISPlay[:WINDow]:TRACe:Y[:SCALe]:POSition {LEFT|CENTer|RIGHT}

Query Syntax :DISPlay[:WINDow]:TRACe:Y[:SCALe]:POSition?

Parameter/	LEFT	Position the scale to left
Return parameter	CENTer	Position the scale to the center
	RIGHT	Position the scale to right

Example :DISP:TRAC:Y:POS LEFT

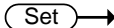
:DISPlay[:WINDow]:TRACe:Y[:SCALe]:
 RLEVel

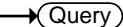



Description Sets or queries the Y-axis reference level. The units depend on the scale type (logarithmic/linear).

Syntax :DISPlay[:WINDow]:TRACe:Y[:SCALe]:RLEVel <ampl>



Query Syntax :DISPlay[:WINDow]:TRACe:Y[:SCALe]:RLEVel?

Parameter	<ampl>	<NRf>
Return parameter	<NR3>	



Example :DISP:TRAC:Y:RLEV 1 mV

:DISPlay[:WINDow]:TRACe:Y[:SCALe]: 
RLEVel:OFFSet 

Description	Sets or queries the Y-axis reference level offset.	
Syntax	:DISPlay[:WINDow]:TRACe:Y[:SCALe]:RLEVel:OFFSet <rel_ampl>	
Query Syntax	:DISPlay[:WINDow]:TRACe:Y[:SCALe]:RLEVel:OFFSet?	
Parameter	<ampl>	<NRf> dB
Return parameter	<NR3>	
Example	:DISP:TRAC:Y:RLEV:OFFS 5.0e+1 dB	

:DISPlay[:WINDow]:TRACe:Y[:SCALe]: 
SPACing 

Description	Sets or queries the type of scale: logarithmic or linear.	
Syntax	:DISPlay[:WINDow]:TRACe:Y[:SCALe]:SPACing {LINear LOGarithmic}	
Query Syntax	:DISPlay[:WINDow]:TRACe:Y[:SCALe]:SPACing?	
Parameter/ Return parameter	LINear	Linear scale
	LOGarithmic	Logarithmic scale
Example	:DISP:TRAC:Y:SPAC LOG	

:DISPlay[:WINDow]:TRACe:Y[:SCALe]: 
STATe 

Description	Turns the on-screen scale on/off or queries its state.	
Syntax	:DISPlay[:WINDow]:TRACe:Y[:SCALe]:STATe {OFF ON 0 1}	
Query Syntax	:DISPlay[:WINDow]:TRACe:Y[:SCALe]:STATe?	

Parameter	0	Turn scale off.
	1	Turn scale on.
	OFF	Turn scale off.
	ON	Turn scale on.

Return parameter	0	Scale is off.
	1	Scale is on.

Example	:DISP:TRAC:Y:STAT ON	
---------	----------------------	--

INITiate Commands

:INITiate:CONTInuous	153
:INITiate[:IMMEDIATE].....	153

:INITiate:CONTInuous

Set →

→ Query

Description	Sets the sweep mode to continuous or single mode or queries its state.	
Syntax	:INITiate:CONTInuous {OFF ON 0 1}	
Query Syntax	:INITiate:CONTInuous?	
Parameter	0	single
	1	continuos
	OFF	single
	ON	continuos
Return parameter	0	single
	1	continuos
Example	:INIT:CONT ON	

:INITiate[:IMMEDIATE]

Set →

Description	Initiates an immediate single sweep then stops the sweep.	
Syntax	:INITiate[:IMMEDIATE]	
Example	:INIT	

INPut Commands

:INPut:ATTenuation	154
:INPut:ATTenuation:AUTO	154
:INPut:IMPedance	155
:INPut:OFFSet	155

:INPut:ATTenuation

Set →

→ Query

Description	Sets or queries the input attenuation.	
Syntax	:INPut:ATTenuation <integer>	
Query Syntax	:INPut:ATTenuation?	
Parameter/ Return parameter	<integer>	<NR1> 0 to 50
Example	:INP:ATT 10 dB	

Set →

→ Query

:INPut:ATTenuation:AUTO

Description	Sets or queries whether the automatic input attenuation is on/off.	
Syntax	:INPut:ATTenuation:AUTO {OFF ON 0 1}	
Query Syntax	:INPut:ATTenuation:AUTO?	
Parameter	0	Turn automatic input attenuation off.
	1	Turn automatic input attenuation on.
	OFF	Turn automatic input attenuation off.
	ON	Turn automatic input attenuation on.
Return parameter	0	Automatic input attenuation is off.
	1	Automatic input attenuation is on.
Example	:INP:ATT:AUTO ON	

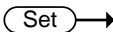
:INPut:IMPedance



Description	Sets or queries the input impedance in Ω .	
Syntax	:INPut:IMPedance {50 75}	
Query Syntax	:INPut:IMPedance?	
Parameter/ Return parameter	50	<NR1> Ω
	75	<NR1> Ω
Example	:INP:IMP 75	

:INPut:OFFSet



Description	Sets or queries the input offset (Input Z Calibration).	
Syntax	:INPut:OFFSet <rel_ampl>	
Query Syntax	:INPut:OFFSet?	
Parameter/ Return parameter	<rel_ampl>	<NR3> dB
Example	:INP:OFFS 10 dB	

MMEMory Commands

:MMEMory:CATalog?	156
:MMEMory:CDIRectory	157
:MMEMory:COpy	157
:MMEMory:DELeTe	158
:MMEMory:DEStination	158
:MMEMory:LOAD:CORRection	159
:MMEMory:LOAD:LIMit	159
:MMEMory:LOAD:PMETer	159
:MMEMory:LOAD:SEQuence	159
:MMEMory:LOAD:STATe	160
:MMEMory:LOAD:TRACe	160
:MMEMory:MOVE	160
:MMEMory:REName	161
:MMEMory:STORe:ASK	161
:MMEMory:STORe:CORRection	161
:MMEMory:STORe:FSK	162
:MMEMory:STORe:IQ	162
:MMEMory:STORe:LIMit	162
:MMEMory:STORe:PMETer	163
:MMEMory:STORe:SCReen	163
:MMEMory:STORe:SEQuence	163
:MMEMory:STORe:STATe	163
:MMEMory:STORe:TRACe	164

:MMEMory:CATalog?

→ Query

Description	Returns a list of all the files that have been saved to the local memory.
Query Syntax	:MMEMory:CATalog?
Example	:MMEM:CAT? >"LocalState1.sta","Quick pg.jpg","Quick pg1.jpg",...

:MMEMory:CDIRectory

Set →

Description	<p>Sets the source directory for memory related commands.</p> <p>When you use a single USB drive/SD card with multiple partitions inside, the system will automatically name these partitions in the numeric order, so you need to specify the partition number.</p> <p>The same situation applies when you use a USB hub to extend the number of USB ports. When a hub is used, <i>all</i> the partitions from <i>all</i> the attached devices are numbered in numerical order from the first port to the last port.</p> <p>If a partition number is not supplied, the system will default to partition #1. For example: :MMEM:CDIR USB0 = :MMEM:CDIR USB)</p>						
Syntax	:MMEMory:CDIRectory {LOCAL USB[<n>] SD[<n>]}						
Parameter	<table border="0"> <tr> <td>LOCAL</td> <td></td> </tr> <tr> <td>USB<n></td> <td><NR1></td> </tr> <tr> <td>SD<n></td> <td><NR1></td> </tr> </table>	LOCAL		USB<n>	<NR1>	SD<n>	<NR1>
LOCAL							
USB<n>	<NR1>						
SD<n>	<NR1>						
Example1	:MMEM:CDIR USB						
Example2	:MMEM:CDIR USB3						

:MMEMory:COPY

Set →

Description	<p>Copies a designated file from the current file directory to the destination directory. The file can be renamed after it is copied.</p>				
Syntax	:MMEMory:COPY <src_file_name>,<dest_file_name>				
Parameter	<table border="0"> <tr> <td><src_file_name></td> <td></td> </tr> <tr> <td><dest_file_name></td> <td></td> </tr> </table>	<src_file_name>		<dest_file_name>	
<src_file_name>					
<dest_file_name>					
Example	:MMEM:COPY "QuickJpg1.jpg","QuickJpg2.jpg"				

:MMEMory:DELeTe

Set →

Description	Deletes the designated file from the current directory.
Syntax	:MMEMory:DELeTe <src_file_name>
Parameter	<src_file_name>
Example	:MMEM:DEL "QuickJpg1.jpg"

:MMEMory:DESTination

Set →

Description	<p>Sets the destination directory for memory related commands.</p> <p>When you use a single USB drive/SD card with multiple partitions inside, the system will automatically name these partitions in the numeric order, so you need to specify the partition number.</p> <p>The same situation applies when you use a USB hub to extend the number of USB ports. When a hub is used, <i>all</i> the partitions from <i>all</i> the attached devices are numbered in numerical order from the first port to the last port.</p> <p>If a partition number is not supplied, the system will default to partition #1. For example: :MMEM:DEST USB0 = :MMEM:DEST USB)</p>						
Syntax	:MMEMory:DESTination {LOCAL USB[<n>] SD[<n>]}						
Parameter	<table border="1"> <tr> <td>LOCAL</td> <td></td> </tr> <tr> <td>USB<n></td> <td><NR1></td> </tr> <tr> <td>SD<n></td> <td><NR1></td> </tr> </table>	LOCAL		USB<n>	<NR1>	SD<n>	<NR1>
LOCAL							
USB<n>	<NR1>						
SD<n>	<NR1>						
Example	:MMEM:DEST SD						

:MMEMory:LOAD:CORRection**Set** →

Description Loads correction data from a file to the internal memory.

Syntax :MMEMory:LOAD:CORRection <corr num>, <src_file_name>

Parameter <corr num> <NR1> correction set 1~5
<src_file_name> XXX.cor

Example :MMEM:LOAD:CORR 2,"test.cor"

:MMEMory:LOAD:LIMit**Set** →

Description Loads limit line data from a file to the internal memory.

Syntax :MMEMory:LOAD:LIMit <lim num>,<src_file_name>

Parameter <lim num> <NR1> limit line 1~5
<src_file_name> XXX.lmt

Example :MMEM:LOAD:LIM 2,"test.lmt"

:MMEMory:LOAD:PMETer**Set** →

Description Loads power meter data from a file to the internal memory.

Syntax :MMEMory:LOAD:PMETer <src_file_name>

Parameter <src_file_name> XXX.pmet

Example :MMEM:LOAD:PMET "test.pmet"

:MMEMory:LOAD:SEQuence**Set** →

Description Loads sequence data from a file to the internal memory.

Syntax	:MMEMory:LOAD:SEQuence <seq num>, <src_file_name>	
Parameter	<seq num> <src_file_name>	<NR1>sequence number 1~5 XXX.seq
Example	:MMEM:LOAD:SEQ 2,"test.seq"	

:MMEMory:LOAD:STATe (Set) →

Description	Loads the instrument state from a file to the internal memory.	
Syntax	:MMEMory:LOAD:STATe <src_file_name>	
Parameter	<src_file_name>	XXX.sta
Example	:MMEM:LOAD:STAT "test.sta"	

:MMEMory:LOAD:TRACe (Set) →

Description	Loads trace data from a file to the internal memory.	
Syntax	:MMEMory:LOAD:TRACe <trace name>, <src_file_name>	
Parameter	<trace name> <src_file_name>	<NR1> 1~4 XXX.tra
Example	:MMEM:LOAD:TRAC 2,"test.tra"	

:MMEMory:MOVE (Set) →

Description	Moves a designated file from the current file directory to the destination directory. The file can be renamed after it is moved.	
Syntax	:MMEMory:MOVE <src_file_name>,<dest_file_name>	
Parameter	<src_file_name> <dest_file_name>	
Example	:MMEM:MOVE "QuickJpg1.jpg","QuickJpg2.jpg"	

:MMEMory:REName

Set →

Description	Renames the designated file from the current file.	
Syntax	:MMEMory:REName <old_file_name>,<new_file_name>	
Parameter	<old_file_name> <new_file_name>	
Example	:MMEM:REN "QuickJpg1.jpg","QuickJpg2.jpg"	

:MMEMory:STORe:ASK

Set →

Description	Store ASK data to a file from the internal memory.	
Syntax	:MMEMory:STORe: ASK <seq num>, <new_dest_file_name>	
Parameter	<seq num> <new_dest_file_name>	<NR1> number 1: Start to record 0: Stop recording XXX.csv
Example	:MMEM:STOR:ASK 1,"test. csv" :MMEM:STOR:ASK 0,"test. csv"	

:MMEMory:STORe:CORRection

Set →

Description	Store correction data to a file from the internal memory.	
Syntax	:MMEMory:STOR:CORRection <corr num>,<new_dest_file_name>	
Parameter	<corr num> <new_dest_file_name>	<NR1> correction set 1~5 XXX.cor
Example	:MMEM:STOR:CORR 2,"test.cor"	

:MMEMory:STORe:FSK

Set →

Description	Store FSK data to a file from the internal memory.	
Syntax	:MMEMory:STORe:FSK <seq num>, <new_dest_file_name>	
Parameter	<seq num>	<NR1> number 1: Start to record 0: Stop recording <new_dest_file_name> XXX.csv
Example	:MMEM:STOR:FSK 1,"test. csv" :MMEM:STOR:FSK 0,"test. csv"	

:MMEMory:STORe:IQ

Set →

Description	Store IQ data to a file from the internal memory.	
Syntax	:MMEMory:STORe:IQ <new_dest_file_name>	
Parameter	<new_dest_file_name>	XXX.csv
Example	:MMEM:STOR:IQ "test. csv"	

:MMEMory:STORe:LIMit

Set →

Description	Store limit line data to a file from the internal memory.	
Syntax	:MMEMory:STOR:LIMit <lim num>,<new_dest_file_name>	
Parameter	<lim num> <new_dest_file_name>	<NR1> limit line 1~5 XXX.lmt
Example	:MMEM:STOR:LIM 2,"test.lmt"	

:MMEMory:STORe:PMETer (Set) →

Description	Store power meter data to a file from the internal memory.
-------------	--

Syntax	:MMEMory:STORe:PMETer <new_dest_file_name>
--------	--

Parameter	<new_dest_file_name> XXX.pmet
-----------	----------------------------------

Example	:MMEM:STOR:PMET "test.pmet"
---------	-----------------------------

:MMEMory:STORe:SCReen (Set) →

Description	Store a screen-shot to the current file directory.
-------------	--

Syntax	:MMEMory:STORe:SCReen <new_dest_file_name>
--------	--

Parameter	<new_dest_file_name> XXX.jpg
-----------	---------------------------------

Example	:MMEM:STOR:SCR "test.jpg"
---------	---------------------------

:MMEMory:STORe:SEQuence (Set) →

Description	Store sequence data to a file from the internal memory.
-------------	---

Syntax	:MMEMory:STORe:SEQuence <seq num>, <new_dest_file_name>
--------	---

Parameter	<seq num> <NR1>sequence number 1~5
	<new_dest_file_name> XXX.seq

Example	:MMEM:STOR:SEQ 2,"test.seq"
---------	-----------------------------

:MMEMory:STORe:STATe (Set) →

Description	Store the instrument state to a file from the internal memory.
-------------	--

Syntax	:MMEMory:STORe:STATe <new_dest_file_name>
--------	---

Parameter	<new_dest_file_name> XXX.sta
-----------	---------------------------------

Example :MMEM:STORe:STAT "test.sta"

:MMEMory:STORe:TRACe

Set →

Description Store trace data to a file from the internal memory.

Syntax :MMEMory:STORe:TRACe <trace name>, <new_dest_file_name>

Parameter <trace name> <NR1> 1~4
<new_dest_file_name> XXX.tra

Example :MMEM:STORe:TRAC 2,"test.tra"

OUTPut Commands

:OUTPut[:STATe]165

:OUTPut[:STATe]

Description Turns the tracking generator output on/off or queries its state.

Syntax :OUTPut[:STATe] {OFF|ON|0|1}

Query Syntax :OUTPut[:STATe]?

Parameter	0	Turn TG output off.
	1	Turn TG output on.
	OFF	Turn TG output off.
	ON	Turn TG output on.

Return parameter	0	TG output is off.
	1	TG output is on.

Example :OUTP ON

SENSe Commands

[SENSe]:ACPR:ACHannel<n>:BANDwidth BWIDth	169
[SENSe]:ACPR:ACHannel<n>:HLIMit	169
[SENSe]:ACPR:ACHannel<n>:LLIMit	170
[SENSe]:ACPR:ACHannel<n>:OFFSet	170
[SENSe]:ACPR:BANDwidth BWIDth	170
[SENSe]:ACPR:HLIMit	171
[SENSe]:ACPR:LLIMit	171
[SENSe]:ACPR:HELP:STATe	171
[SENSe]:ACPR:SPACe	172
[SENSe]:ASET:AMPLitude	172
[SENSe]:ASET:AMPLitude:AUTO	172
[SENSe]:ASET:RUN	173
[SENSe]:ASET:SPAN	173
[SENSe]:ASET:SPAN:AUTO	173
[SENSe]:AVERage:COUNT	174
[SENSe]:AVERage:STATe	174
[SENSe]:AVERage:TYPE	174
[SENSe]:BANDwidth BWIDth[:RESolution]	175
[SENSe]:BANDwidth BWIDth[:RESolution]:AUTO	175
[SENSe]:BANDwidth BWIDth:VIDeo	175
[SENSe]:BANDwidth BWIDth:VIDeo:AUTO	176
[SENSe]:CHANnel:SPACe:DOWN	176
[SENSe]:CHANnel:SPACe:UP	176
[SENSe]:CNR:CHANnel:SPACe	177
[SENSe]:CNR:DELTAmarker:MODE	177
[SENSe]:CORRection:CSET<n>:DATA	177
[SENSe]:CORRection:CSET<n>:STATe	178
[SENSe]:CORRection:CSET<n>:DELeTe	178
[SENSe]:CSO:CHANnel:SPACe	178
[SENSe]:CTB:CHANnel:SPACe	179
[SENSe]:DEMod:DECode	179
[SENSe]:DEMod:DECode:FORMat	180
[SENSe]:DEMod:DECode:INVert:STATe	180
[SENSe]:DEMod:DEFine:CODE	180
[SENSe]:DEMod:DEFine:MCOunt	181
[SENSe]:DEMod:EARPhone:TYPE	181
[SENSe]:DEMod:EARPhone:VOLume	181
[SENSe]:DEMod:EARPhone:GAIN	182
[SENSe]:DEMod:FILTer:LPASs	182

[:SENSe]:DEMod:IFBW	183
[:SENSe]:DEMod:PREamble:BITS	183
[:SENSe]:DEMod:PREamble:SYNChronous: STATe ..	183
[:SENSe]:DEMod:SQUelch:LEVel	184
[:SENSe]:DEMod:BRATe.....	184
[:SENSe]:DEMod:SYNChronous:BITS	184
[:SENSe]:DEMod:SYNChronous:WORDs.....	185
[:SENSe]:DETEctor[:FUNCTion].....	185
[:SENSe]:DETEctor[:FUNCTion]:AUTO	186
[:SENSe]:EMIFilter:STATe	186
[:SENSe]:EMIFilter:BANDwidth BWIDth [:RESolution]	187
[:SENSe]:FREQuency:CENTer	187
[:SENSe]:FREQuency:CENTer:STEP	187
[:SENSe]:FREQuency:CENTer:STEP:AUTO	188
[:SENSe]:FREQuency:OFFSet.....	188
[:SENSe]:FREQuency:SPAN	188
[:SENSe]:FREQuency:SPAN:FULL	189
[:SENSe]:FREQuency:SPAN:PREVious	189
[:SENSe]:FREQuency:STARt	189
[:SENSe]:FREQuency:STOP.....	189
[:SENSe]:HARMonic:FUNDamental:FREQuency.....	190
[:SENSe]:HARMonic:NUMBer	190
[:SENSe]:LIMit<n>:DELete.....	190
[:SENSe]:JITTer:OFFSet:STARt	190
[:SENSe]:JITTer:OFFSet:STOP	191
[:SENSe]:NDB:BANDwidth BWIDth	191
[:SENSe]:OCBW:BANDwidth BWIDth	191
[:SENSe]:OCBW:PERCent.....	192
[:SENSe]:OCBW:SPACe.....	192
[:SENSe]:PIDB:AVERAge:COUNt	192
[:SENSe]:PIDB:GAIN:OFFSet.....	193
[:SENSe]:PMETer:FREQuency	193
[:SENSe]:PMETer:HLIMit	193
[:SENSe]:PMETer:HOLD:STATe	194
[:SENSe]:PMETer:LLIMit	194
[:SENSe]:PMETer:PSEnSor:MODE	194
[:SENSe]:PMETer:RECORDing:TIME.....	195
[:SENSe]:PMETer:RECORDing:TIME:STEP	195
[:SENSe]:POWER[:RF]:GAIN	195
[:SENSe]:SEMAsk:BANDwidth BWIDth :INTegration	196
[:SENSe]:SEMAsk:BANDwidth BWID th[:RESolution].....	196

[;SENSe];SEMAsk:BANDwidth BWIDth	
[;RESolution]:AUTO	196
[;SENSe];SEMAsk:CARRier:AUTO	197
[;SENSe];SEMAsk:CARRier:CPSD	197
[;SENSe];SEMAsk:CARRier:POWer.....	198
[;SENSe];SEMAsk:FREQuency:SPAN.....	198
[;SENSe];SEMAsk:GWLan:MODulation.....	198
[;SENSe];SEMAsk:HELP:STATe	199
[;SENSe];SEMAsk:NWLan:CHANnel: BANDwidth BWIDth.....	199
[;SENSe];SEMAsk:OFFSet<n>:ADDition: BANDwidth BWIDth[;RESolution]?	200
[;SENSe];SEMAsk:OFFSet<n>:ADDition: FREQuency:STARt?	201
[;SENSe];SEMAsk:OFFSet<n>:ADDition: FREQuency:STOP?.....	202
[;SENSe];SEMAsk:OFFSet<n>:ADDition: STARt:ABSolute?.....	202
[;SENSe];SEMAsk:OFFSet<n>:ADDition: STOP:ABSolute?	202
[;SENSe];SEMAsk:OFFSet<n>:BANDwidth BWIDth[;RESolution].....	203
[;SENSe];SEMAsk:OFFSet<n>:BANDwidth BWIDth[;RESolution]:AUTO.....	203
[;SENSe];SEMAsk:OFFSet<n>:FREQuency:STARt....	204
[;SENSe];SEMAsk:OFFSet<n>:FREQuency:STOP	204
[;SENSe];SEMAsk:OFFSet<n>:STARt:ABSolute	204
[;SENSe];SEMAsk:OFFSet<n>:STARt:RELative	205
[;SENSe];SEMAsk:OFFSet<n>:STATe	205
[;SENSe];SEMAsk:OFFSet<n>:STOP:ABSolute	206
[;SENSe];SEMAsk:OFFSet<n>:STOP:ABSolute :COUple.....	206
[;SENSe];SEMAsk:OFFSet<n>:STOP:RELative.....	206
[;SENSe];SEMAsk:OFFSet<n>:STOP:RELative :COUple.....	207
[;SENSe];SEMAsk:OFFSet<n>:TEST	207
[;SENSe];SEMAsk:SELEct.....	208
[;SENSe];SEMAsk:TYPE	208
[;SENSe];SEMAsk:W3GPP:DUPLex:TYPE	208
[;SENSe];SEMAsk:W3GPP:FDD:ADDition:LIMit	209
[;SENSe];SEMAsk:W3GPP:FDD:ADDition:MOPower209	
[;SENSe];SEMAsk:W3GPP:FDD:MOPower.....	210
[;SENSe];SEMAsk:W3GPP:FDD:TRANsmi:MODE..	210
[;SENSe];SEMAsk:W3GPP:TDD:CHIP:RATE	210

[:SENSe]:SEMAsk:W3GPP:TDD:MOPower211
 [:SENSe]:SEMAsk:W3GPP:TDD:TRANsmit:MODE ..211
 [:SENSe]:SEMAsk:WIMax:CHANnel:
 BANDwidth | BWIDth212
 [:SENSe]:SEQuence<n>:DELete212
 [:SENSe]:SWEep:EGATe:DELay212
 [:SENSe]:SWEep:EGATe:LENGth.....213
 [:SENSe]:SWEep:EGATe:STATe213
 [:SENSe]:SWEep:MODE.....213
 [:SENSe]:SWEep:TIME214
 [:SENSe]:SWEep:TIME:AUTO214
 [:SENSe]:TOI:REFerence214
 [:SENSe]:TOI:LIMit.....215

[:SENSe]:ACPR:ACHannel<n>:BANDwidth| BWIDth (Set) →
→ (Query)

Description Sets or queries the adjacent channel bandwidth for the selected adjacent channel. Used with ACPR measurement.

Syntax [:SENSe]:ACPR:ACHannel<n>:BANDwidth|BWIDth <freq>

Query Syntax [:SENSe]:ACPR:ACHannel<n>:BANDwidth|BWIDth?

Parameter <freq> <NRf>

Return parameter <NR3> Hz

Example :ACPR:ACH1:BAND 2.0e+6

[:SENSe]:ACPR:ACHannel<n>:HLIMit (Set) →
→ (Query)

Description Sets or queries the high limit for the selected adjacent channel. Used with ACPR measurement.

Syntax [:SENSe]:ACPR:ACHannel<n>:HLIMit <ampl>

Query Syntax [:SENSe]:ACPR:ACHannel<n>:HLIMit?

Parameter <ampl> <NRf> power or voltage

Return parameter <NR3>

Example :ACPR:ACH1:HLIM -3.0e+1

[:SENSE]:ACPR:ACHannel<n>:LLIMit (Set) →
→ (Query)

Description Sets or queries the low limit for the selected adjacent channel. Used with ACPR measurement.

Syntax [:SENSE]:ACPR:ACHannel<n>:LLIMit <ampl>

Query Syntax [:SENSE]:ACPR:ACHannel<n>:LLIMit?

Parameter <ampl> <NRf3> power or voltage

Return parameter <NR3>

Example :ACPR:ACH1:LLIM -5.0e+1

[:SENSE]:ACPR:ACHannel<n>:OFFSet (Set) →
→ (Query)

Description Sets or queries the adjacent channel offset for the selected adjacent channel. Used with ACPR measurement.

Syntax [:SENSE]:ACPR:ACHannel<n>:OFFSet <freq>

Query Syntax [:SENSE]:ACPR:ACHannel<n>:OFFSet?

Parameter <freq> <NRf>

Return parameter <NR3> Hz

Example :ACPR:ACH1:OFFSet 2.0e+6

[:SENSE]:ACPR:BANDwidth|BWIDth (Set) →
→ (Query)

Description Sets or queries the main channel bandwidth for ACPR measurements.

Syntax [:SENSE]:ACPR:BANDwidth|BWIDth <freq>

Query Syntax [:SENSE]:ACPR:BANDwidth|BWIDth?

Parameter <freq> <NRf>

Return parameter <NR3> Hz

Example :ACPR:BAND 2.0e+6

[:SENSe]:ACPR:HLIMit (Set) →
→ (Query)

Description Sets or queries the high limit for the main channel. Used with ACPR measurement.

Syntax [:SENSe]:ACPR:HLIMit <ampl>

Query Syntax [:SENSe]:ACPR:HLIMit?

Parameter <ampl> <NRf> power or voltage

Return parameter <NR3>

Example :ACPR:HLIM -3.0e+1

[:SENSe]:ACPR:LLIMit (Set) →
→ (Query)

Description Sets or queries the low limit for the main channel. Used with ACPR measurement.

Syntax [:SENSe]:ACPR:LLIMit <ampl>

Query Syntax [:SENSe]:ACPR:LLIMit?

Parameter <ampl> <NRf> power or voltage

Return parameter <NR3>

Example :ACPR:LLIM -5.0e+1

[:SENSe]:ACPR:HELP:STATe (Set) →

Description Turns the on-screen help on/off.

Syntax [:SENSe]:ACPR:HELP:STATe {OFF|ON|0|1}

Parameter	0	Turn help off.
	1	Turn help on.
	OFF	Turn help off.
	ON	Turn help on.

Example :ACPR:HELP:STAT ON

Set →
→ Query

[[:SENSE]:ACPR:SPACe

Description	Sets or queries the channel spacing between the main channels.	
Syntax	[:SENSE]:ACPR:SPACe <freq>	
Query Syntax	[:SENSE]:ACPR:SPACe?	
Parameter	<freq>	<NRf>
Return parameter	<NR3>	Hz
Example	:ACPR:SPAC 2.0e+6	

Set →
→ Query

[[:SENSE]:ASET:AMPLitude

Description	Sets or queries the autoset amplitude floor level.	
Syntax	[:SENSE]:ASET:AMPLitude <ampl>	
Query Syntax	[:SENSE]:ASET:AMPLitude?	
Parameter	<ampl>	<NRf> power or voltage
Return parameter	<NR3>	
Example	:ASET:AMPL 8.0e+1	

Set →
→ Query

[[:SENSE]:ASET:AMPLitude:AUTO

Description	Sets autoset amplitude floor level to auto or manual or queries its state.	
Syntax	[:SENSE]:ASET:AMPLitude:AUTO {OFF ON 0 1}	
Query Syntax	[:SENSE]:ASET:AMPLitude:AUTO?	
Parameter	0	Turn autoset amplitude floor to manual.
	1	Turn autoset amplitude floor to auto.
	OFF	Turn autoset amplitude floor to manual.
	ON	Turn autoset amplitude floor to auto.
Return parameter	0	Autoset amplitude floor is in manual.
	1	Autoset amplitude floor is in auto.

Example :ASET:AMPL:AUTO 1

[[:SENSE]:ASET:RUN

Set →

Description Activates the Autoset function.

Syntax [[:SENSE]:ASET:RUN

Example :ASET:RUN

[[:SENSE]:ASET:SPAN

Set →

→ Query

Description Sets or queries the Autoset span.

Syntax [[:SENSE]:ASET:SPAN <freq>

Query Syntax [[:SENSE]:ASET:SPAN?

Parameter <freq> <NRf>

Return parameter <NR3> Hz

Example :ASET:SPAN 2.0e+6

[[:SENSE]:ASET:SPAN:AUTO

Set →

→ Query

Description Turns the Autoset span to auto or manual or queries its state.

Syntax [[:SENSE]:ASET:SPAN:AUTO {OFF|ON|0|1}

Query Syntax [[:SENSE]:ASET:SPAN:AUTO?

Parameter	0	Turn Autoset span to manual (off).
	1	Turn Autoset span to automatic (on).
	OFF	Turn Autoset span to manual (off).
	ON	Turn Autoset span to automatic (on).

Return parameter	0	Autoset span is set to manual (off).
	1	Autoset span is set to automatic (on).

Example :ASET:SPAN:AUTO ON

[[:SENSE]:AVERage:COUNT (Set) →
→ (Query)

Description	Sets or queries the number of traces that are used with the average function.	
Syntax	[:SENSE]:AVERage:COUNT <integer>	
Query Syntax	[:SENSE]:AVERage:COUNT?	
Parameter/ Return parameter	<integer>	<NR1>
Example	:AVER:COUN 20	

[[:SENSE]:AVERage:STATe (Set) →
→ (Query)

Description	Turns the Average function on/off or queries its state.	
Syntax	[:SENSE]:AVERage:STATe {OFF ON 0 1}	
Query Syntax	[:SENSE]:AVERage:STATe?	
Parameter	0	Turn the Average function off.
	1	Turn the Average function on.
	OFF	Turn the Average function off.
	ON	Turn the Average function on.
Return parameter	0	The Average function is off.
	1	The Average function is on.
Example	:AVER:STAT ON	

[[:SENSE]:AVERage:TYPE (Set) →

Description	Sets the method that the Average function uses to calculate the average.	
Syntax	[:SENSE]:AVERage:TYPE {VOLTage LOGarithmic POWer}	
Query syntax	[:SENSE]:AVERage:TYPE?	

Parameter/Return parameter	VOLTage	Sets Average to voltage
	LOGarithmic	Sets Average to logarithmic
	POWer	Sets Average to power

Example :AVER:TYPE VOLT

Set →
 → Query

[[:SENSE]:BANDwidth|BWIDth[:RESolution]

Description Sets or queries the resolution bandwidth (RBW).

Syntax [[:SENSE]:BANDwidth|BWIDth[:RESolution] <freq>

Query Syntax [[:SENSE]:BANDwidth|BWIDth[:RESolution]?

Parameter <freq> <NRf>

Return parameter <NR3> Hz

Example :BAND 1.0e+6

**[[:SENSE]:BANDwidth|BWIDth
[:RESolution]:AUTO**

Set →
 → Query

Description Turns the RBW to auto (on) or manual (off) or queries its state.

Syntax [[:SENSE]: BANDwidth|BWIDth[:RESolution]:AUTO {OFF|ON|0|1}

Query Syntax [[:SENSE]: BANDwidth|BWIDth[:RESolution]:AUTO?

Parameter	0	Turn RBW to manual (off).
	1	Turn RBW to automatic (on).
	OFF	Turn RBW to manual (off).
	ON	Turn RBW to automatic (on).

Return parameter	0	RBW is set to manual (off).
	1	RBW is set to automatic (on).

Example :BAND:AUTO ON

Set →
 → Query

[[:SENSE]:BANDwidth|BWIDth:VIDeo

Description Sets or queries the video bandwidth (VBW).

Syntax	[:SENSE]:BANDwidth BWIDth:VIDeo <freq>	
Query Syntax	[:SENSE]:BANDwidth BWIDth:VIDeo?	
Parameter	<freq>	<NRf>
Return parameter	<NR3>	Hz
Example	:BAND:VID 1.0e+6	

(Set) →

[:SENSE]:BANDwidth|BWIDth:VIDeo:AUTO → (Query)

Description	Turns the VBW to auto (on) or manual (off) or queries its state.	
Syntax	[:SENSE]:BANDwidth BWIDth:VIDeo:AUTO {OFF ON 0 1}	
Query Syntax	[:SENSE]:BANDwidth BWIDth:VIDeo:AUTO?	
Parameter	0	Turn VBW to manual (off).
	1	Turn VBW to automatic (on).
	OFF	Turn VBW to manual (off).
	ON	Turn VBW to automatic (on).
Return parameter	0	VBW is set to manual (off).
	1	VBW is set to automatic (on).
Example	:BAND:VID:AUTO OFF	

[:SENSE]:CHANnel:SPACe:DOWN (Set) →

Description	Moves to the previous main channel when using measurements that have a channel space setting.	
Syntax	[:SENSE]:CHANnel:SPACe:DOWN	
Example	:CHAN:SPAC:DOWN	

[:SENSE]:CHANnel:SPACe:UP (Set) →

Description	Moves to the next main channel when using measurements that have a channel space setting.	
Syntax	[:SENSE]:CHANnel:SPACe:UP	

Example :CHAN:SPAC:UP

[[:SENSE]:CNR:CHANnel:SPACe

Set →

→ Query

Description Sets or queries the channel space bandwidth for CNR measurements.

Syntax [[:SENSE]:CNR:CHANnel:SPACe <freq>

Query Syntax [[:SENSE]:CNR:CHANnel:SPACe?

Parameter <freq> <NRf>

Return parameter <NR3> Hz

Example :CNR:CHAN:SPAC 6.0e+6

[[:SENSE]:CNR:DELTamarker:MODE

Set →

Description Turns the CNR Noise Marking function to Min(AUTO) or ΔMarker(MANual).

Syntax [[:SENSE]:CNR:DELTamarker:MODE {AUTO|MANual }

Parameter AUTO Sets the Noise Marking to Min.

ΔMarker Sets the Noise Marking to ΔMarker.

Example :CNR:DELT:MODE AUTO

[[:SENSE]:CORRection:CSET<n>:DATA

Set →

→ Query

Description As a command, sets an offset for a certain frequency for a selected correction set. As a query, returns the data contents for the selected correction set as <csv data>. The data will be arranged as:
pt#1 freq, pt#1 offset, pt#2 freq, pt#2 offset,...

Syntax [[:SENSE]:CORRection:CSET<n>:DATA <freq>,<offset>

Query syntax [[:SENSE]:CORRection:CSET<n>:DATA?

Parameter	<freq> <offset> <n>	<NRf> Hz <NRf> dB <NR1>correction set number
Return parameter	<CSV data>	pt#1 freq, pt#1 offset,..... pt#n freq, pt#n offset
Example	:CORR:CSET1:DATA 2e+6,30	

Set →
 → Query

[[:SENSE]:CORRection:CSET<n>:STATe

Description Turns the selected correction set on/off or queries its state.

Syntax [[:SENSe]:CORRection:CSET<n>:STATe {OFF|ON|0|1}

Query Syntax [[:SENSe]:CORRection:CSET<n>:STATe?

Parameter	0 1 OFF ON <n>	Turn turn the selected correction set off. Turn turn the selected correction set on. Turn turn the selected correction set off. Turn turn the selected correction set on. <NR1>correction set number
-----------	----------------------------	--

Return parameter	0 1	The selected correction set is off. The selected correction set is on.
------------------	--------	---

Example :CORR:CSET1:STAT ON

Set →

[[:SENSE]:CORRection:CSET<n>:DELeTe

Description Deletes the chosen correction set.

Syntax [[:SENSe]:CORRection:CSET<n>:DELeTe

Parameter <n> <NR1>correction set number

Example :CORR:CSET1:DEL 2

Set →
 → Query

[[:SENSE]:CSO:CHANnel:SPACe

Description Sets the channel space bandwidth for CSO measurements.

Syntax	[:SENSe]:CSO:CHANnel:SPACe <freq>	
Query Syntax	[:SENSe]:CSO:CHANnel:SPACe?	
Parameter	<freq>	<NRf>
Return parameter	<NR3>	Hz
Example	:CSO:CHAN:SPAC 6.0e+6	

Set →
 → Query

Description	Sets the channel space bandwidth for CTB measurements.	
Syntax	[:SENSe]:CTB:CHANnel:SPACe <freq>	
Query Syntax	[:SENSe]:CTB:CHANnel:SPACe?	
Parameter	<freq>	<NRf>
Return parameter	<NR3>	Hz
Example	:CTB:CHAN:SPAC 6.0e+6	

Set →

Description	Sets the decoding method.	
Syntax	[:SENSe]:DEMod:DECode {NONE MILLer MANchester DMANchester BPHase}	
Parameter	<NONE>	No decoding
	MILLer	Miller decoding
	MANchester	Manchester encoding
	DMANchester	Differential Manchester encoding
	BPHase	Bi-Phase encoding
Example	:DEM:DEC MAN	

[[:SENSE]:DEMod:DECode:FORMat (Set) →

Description	Sets the decoding format to Hexadecimal or Binary for the ASK/FSK Analysis function.	
Syntax	[:SENSE]:DEMod:DECode:FORMat {BINary HEXadecimal}	
Parameter	BINary	Decoding in binary
	HEXadecimal	Decoding in hexadecimal
Example	:DEM:DEC:FORM BIN	

[[:SENSE]:DEMod:DECode:INVert:STATe (Set) →
→ (Query)

Description	Sets or queries the invert decoding state of the ASK/FSK Analysis function.	
Syntax	[:SENSE]:DEMod:DECode:INVert:STATe {OFF ON 0 1}	
Query Syntax	[:SENSE]:DEMod:DECode:INVert:STATe?	
Parameter	0 & OFF	Set Invert Decoding to Off.
	1 & ON	Set Invert Decoding to On.
Return parameter	0	Invert Decoding is set to Off.
	1	Invert Decoding is set to On.
Example	:DEM:DEC:INV:STAT? >1	

[[:SENSE]:DEMod:DEFine:CODE (Set) →
→ (Query)

Description	Sets or queries compare of value.	
Syntax	[:SENSE]:DEMod:DEFine:CODE <hexadecimal>	
Query Syntax	[:SENSE]:DEMod:DEFine:CODE?	
Parameter/Return parameter	<hexadecimal>	<4 bite data> ...

Example :SENS:DEM:DEF:CODE #HEED2124

[[:SENSe]:DEMod:DEFine:MCOunt

Set →

→ Query

Description Sets or queries compare of number.

Syntax [[:SENSe]:DEMod:DEFine:MCOunt <integer>

Query Syntax [[:SENSe]:DEMod:DEFine:MCOunt?

Parameter/Return parameter <Integer> <NR1>

Example :SENS:DEM:DEF:MCO 5

[[:SENSe]:DEMod:EARPhone:TYPE

Set →

→ Query

Description Sets or queries the demodulation type for the Ear Phone Out demodulation function.

Syntax [[:SENSe]:DEMod:EARPhone:TYPE {AM|FM}

Query Syntax [[:SENSe]:DEMod:EARPhone:TYPE?

Parameter AM AM demodulation
FM FM demodulation

Example :DEM:EARP:TYPE AM

[[:SENSe]:DEMod:EARPhone:VOLume

Set →

→ Query

Description Sets or queries the volume setting for the demodulation function.

Syntax [[:SENSe]:DEMod:EARPhone:VOLume <integer>

Query Syntax [[:SENSe]:DEMod:EARPhone:VOLume?

Parameter/Return parameter <integer> <NR1> 0~15

Example :DEM:EARP:VOL 7

Set →
 → Query

[[:SENSE]:DEMod:EARPhone:GAIN

Description	Sets or queries the gain setting for the demodulation function.	
Syntax	[:SENSE]:DEMod:EARPhone:GAIN <rel_amp>	
Query Syntax	[:SENSE]:DEMod:EARPhone:GAIN?	
Parameter/ Return parameter	<rel_amp>	<NR1> 0~18, 6dB steps
Example	:DEM:EARP:GAIN 6	

Set →
 → Query

[[:SENSE]:DEMod:FILTer:LPASs

Description	Sets or queries the low pass filter settings for the AM/FM Analysis function.	
Syntax	[:SENSE]:DEMod:FILTer:LPASs {LEVEL<n> Bypass}	
Query Syntax	[:SENSE]:DEMod:FILTer:LPASs?	
Parameter/ Return parameter	Bypass LEVEL<n>	Sets the low pass filter to bypass. n=1~5

The filters 1 to 5 are shown in the table below. The GSP-9330 will automatically detect the signal frequency.

AM/FM Signal Frequency (Hz)	Selectable bandwidth of LPF (Hz)				
	<n>=1	<n>=2	<n>=3	<n>=4	<n>=5
≥78,125	156,250	78,125	52,083	39,063	31,250
≥39,063	78,125	39,063	26,042	19,531	15,625
≥19,531	39,063	19,531	13,021	9,766	7,813
≥7,813	15,625	7,813	5,208	3,906	3,125
≥3,906	7,813	3,906	2,604	1,953	1,563
≥1,953	3,906	1,953	1,302	977	781
≥781	1,563	781	521	391	313
≥391	781	391	260	195	156
≥195	391	195	130	98	78
≥78	156	78	52	39	31
≥39	78	39	26	20	16
≥20	39	20	13	10	8
≥8	16	8	5	4	3

Example :DEM:FILT:LPAS Bypass
Sets the low pass filter to bypass.

[[:SENSe]:DEMod:IFBW Set →
→ Query

Description Sets or queries the IF bandwidth for the AM/FM/ASK/FSK Analysis function.

Syntax [[:SENSe]:DEMod:IFBW <freq>

Query Syntax [[:SENSe]:DEMod:IFBW?

Parameter <freq> <NRf>

Return parameter <NR3> Hz

Example :DEM:IFBW 3.0e+5

[[:SENSe]:DEMod:PREamble:BITS Set →
→ Query

Description Sets or queries the number of preamble bits for the ASK/FSK Analysis function.

Syntax [[:SENSe]:DEMod:PREamble:BITS <integer>

Query Syntax [[:SENSe]:DEMod:PREamble:BITS?

Parameter / Return parameter <integer> <NR1> 0~16

Example :DEM:PRE:BITS?
>16

[[:SENSe]:DEMod:PREamble:SYNChronous:STATE Set →
→ Query

Description Sets or queries the state of the Preamble/Sync mode for the ASK/FSK Analysis function.

Syntax [[:SENSe]:DEMod:PREamble:SYNChronous:STATE {OFF|ON|0|1}

Query Syntax [[:SENSe]:DEMod:PREamble:SYNChronous:STATE?

Parameter	0 & OFF	Set the Preamble/Sync mode to Off.
	1 & ON	Set the Preamble/Sync mode to On.
Return parameter	0	Preamble/Sync mode is Off.
	1	Preamble/Sync mode is On.
Example	:DEM:PRE:SYNC:STAT? >1	

Set →
 → Query

[[:SENSE]:DEMod:SQUelch:LEVel

Description	Sets or queries the carrier squelch level.	
Syntax	[:SENSE]:DEMod:SQUelch:LEVel <dBm level>	
Query Syntax	[:SENSE]:DEMod:SQUelch:LEVel?	
Parameter	<dBm level>	<NRf>
Return parameter	<NR3>	Squelch level in dBm
Example	:DEM:SQU:LEV 1.30e+2	

Set →
 → Query

[[:SENSE]:DEMod:BRATe

Description	Sets or queries the bit rate.	
Syntax	[:SENSE]:DEMod:BRATe <value>	
Query Syntax	[:SENSE]:DEMod:BRATe?	
Parameter	<value>	<NRf> Bit rate in bit/s
Return parameter	<NR3>	Bit rate in bit/s.
Example	:DEM:BRAT? >1.000000000e+02	

Set →
 → Query

[[:SENSE]:DEMod:SYNChronous:BITS

Description	Sets or queries the number of sync bits for the ASK/FSK Analysis function.	
-------------	--	--

Syntax `[:SENSe]:DEMod:SYNChronous:BITS <integer>`

Query Syntax `[:SENSe]:DEMod:SYNChronous:BITS?`

Parameter / Return parameter `<integer>` `<NR1> 0~16`

Example `:DEM:SYNC:BITS?`
`>16`

`[:SENSe]:DEMod:SYNChronous:WORDs`  

Description Sets or queries the sync word for the ASK/FSK Analysis function.

Syntax `[:SENSe]:DEMod:SYNChronous:WORDs`
`<hexadecimal>`

Query Syntax `[:SENSe]:DEMod:SYNChronous:WORDs?`

Parameter / Return parameter `<hexadecimal>` `0000~FFFF`

Example `:DEM:SYNC:WORD?`
`>#H2E3B`

`[:SENSe]:DETEctor[:FUNction]`  

Description Sets or queries the trace detection mode when in manual mode.

Syntax `[:SENSe]:DETEctor[:FUNction] {AVERage | SAMPlE | POSitive | NEGative | NORMal | RAVerage | EAVerage | QPEak}`

Query Syntax `[:SENSe]:DETEctor[:FUNction]?`

Parameter/ Return parameter

SAMPlE	Sets the detector mode to Sample.
POSitive	Sets the detector mode to Peak+.
NEGative	Sets the detector mode to Peak-.
NORMal	Sets the detector mode to Normal.
RAVerage	Sets the detector mode to RMS average.

	EAVerage	Sets the detector mode to EMI Average.
	QPEak	Sets the detector mode to Quasi-peak

Example :DET NORM

Set →
 → Query

[[:SENSE]:DETECTOR[:FUNCTION]:AUTO

Description Turns the trace detection mode to auto (on) or manual (off) or queries its state.

Syntax [[:SENSE]:DETECTOR[:FUNCTION]:AUTO {OFF|ON|0|1}

Query Syntax [[:SENSE]:DETECTOR[:FUNCTION]:AUTO?

Parameter	0	Turn the detection mode to manual (off).
	1	Turn the detection mode to auto (on).
	OFF	Turn the detection mode to manual (off).
	ON	Turn the detection mode to auto (on).

Return parameter	0	The detection mode is set to manual.
	1	The detection mode is set to automatic.

Example :DET:AUTO ON

Set →
 → Query

[[:SENSE]:EMIFILTER:STATE

Description Turns the EMI filter on/off or queries its state.

Syntax [[:SENSE]:EMIFILTER:STATE {OFF|ON|0|1}

Query Syntax [[:SENSE]:EMIFILTER:STATE?

Parameter	0	Turn the EMI filter off.
	1	Turn the EMI filter on.
	OFF	Turn the EMI filter off.
	ON	Turn the EMI filter on.

Return parameter	0	The EMI filter is off.
	1	The EMI filter is on.

Example :EMIF:STAT 0

[[:SENSE]:EMIFilter:BANDwidth|BWIDth[:RESolution]

Set →

Description	Sets the EMI filter bandwidth (must be set to the exact bandwidth).	
Syntax	[:SENSE]:EMIFilter:BANDwidth BWIDth[:RESolution] <freq>	
Parameter	<freq>	<NRf> (Only 200Hz, 9kHz, 120kHz and 1MHz are valid settings)
Example	:EMIF:BAND 2.0e+2	

Set →

[[:SENSE]:FREQUENCY:CENTer

→ **Query**

Description	Sets or queries the center frequency.	
Syntax	[:SENSE]:FREQUENCY:CENTer <freq>	
Query Syntax	[:SENSE]:FREQUENCY:CENTer?	
Parameter	<freq>	<NRf>
Return parameter	<NR3>	Hz
Example	:FREQ:CENT 1.0e+9	

Set →

[[:SENSE]:FREQUENCY:CENTer:STEP

→ **Query**

Description	Sets or queries the CF Step frequency.	
Syntax	[:SENSE]:FREQUENCY:CENTer:STEP <freq>	
Query Syntax	[:SENSE]:FREQUENCY:CENTer:STEP?	
Parameter	<freq>	<NRf>
Return parameter	<NR3>	Hz
Example	:FREQ:CENT:STEP 1.0e+3	

`[[:SENSe]:FREQuency:CENTer:STEP:AUTO` (Set) →
→ (Query)

Description	Turns the CF Step frequency setting to auto (on) or manual (off) or queries its state.	
Syntax	[:SENSe]:FREQuency:CENTer:STEP:AUTO {OFF ON 0 1}	
Query Syntax	[:SENSe]:FREQuency:CENTer:STEP:AUTO?	
Parameter	0	Turn CF Step to manual (off).
	1	Turn CF Step to auto (on).
	OFF	Turn CF Step to manual (off).
	ON	Turn CF Step to auto (on).
Return parameter	0	CF Step is set to manual.
	1	CF Step is set to automatic.
Example	:FREQ:CENT:STEP:AUTO OFF	

`[[:SENSe]:FREQuency:OFFSet` (Set) →
→ (Query)

Description	Sets or queries the frequency offset settings.	
Syntax	[:SENSe]:FREQuency:OFFSet <freq>	
Query Syntax	[:SENSe]:FREQuency:OFFSet?	
Parameter	<freq>	<NRf>
Return parameter	<NR3>	
Example	:FREQ:OFFS 1.0e+6	

`[[:SENSe]:FREQuency:SPAN` (Set) →
→ (Query)

Description	Sets or queries the span settings.	
Syntax	[:SENSe]:FREQuency:SPAN <freq>	
Query Syntax	[:SENSe]:FREQuency:SPAN?	
Parameter	<freq>	<NRf>
Return parameter	<NR3>	Hz

Example :FREQ:SPAN 2.0e+9

[[:SENSE]:FREQUENCY:SPAN:FULL

Set →

Description Set the span to Full Span.

Syntax [[:SENSE]:FREQUENCY:SPAN:FULL

Example :FREQ:SPAN:FULL

[[:SENSE]:FREQUENCY:SPAN:PREVIOUS

Set →

Description Set the span to the previous span setting.

Syntax [[:SENSE]:FREQUENCY:SPAN:PREVIOUS

Example :FREQ:SPAN:PREV

[[:SENSE]:FREQUENCY:START

Set →

→ Query

Description Sets or queries the start frequency.

Syntax [[:SENSE]:FREQUENCY:START <freq>

Query Syntax [[:SENSE]:FREQUENCY:START?

Parameter <freq> <NRf>

Return parameter <NR3> Hz

Example :FREQ:STAR 0

[[:SENSE]:FREQUENCY:STOP

Set →

→ Query

Description Sets or queries the stop frequency.

Syntax [[:SENSE]:FREQUENCY:STOP <freq>

Query Syntax [[:SENSE]:FREQUENCY:STOP?

Parameter <freq> <NRf>

Return parameter <NR3> Hz

Example :FREQ:STOP 1.0e+6

**[[:SENSE]:HARMonic:FUNDamental
:FREQUENCY** (Set) →
→ (Query)

Description	Sets or queries the harmonic frequency.	
Syntax	:SENSE:HARMonic:FUNDamental:FREQUENCY <freq>	
Query Syntax	:SENSE:HARMonic:FUNDamental:FREQUENCY?	
Parameter	<freq>	<NRf>
Return parameter	<NR3>	Hz
Example	:SENS:HARM:FUND:FREQ 1.0e+6	

[[:SENSE]:HARMonic:NUMBER (Set) →
→ (Query)

Description	Sets or queries the harmonic number.	
Syntax	:SENSE:HARMonic:NUMBER <NR1>	
Query Syntax	:SENSE:HARMonic:NUMBER?	
Parameter	<NR1>	Harmonic number
Return parameter	<NR1>	Returns the harmonic number
Example	:SENS:HARM:NUMB 3	

[[:SENSE]:LIMit<n>:DELete (Set) →

Description	Deletes the chosen limit line.	
Syntax	[:SENSE]:LIMit<n>:DELete	
Parameter	<n>	<NR1> limit line number
Example	:LIM3:DEL	

[[:SENSE]:JITTer:OFFSet:STARt (Set) →
→ (Query)

Description	Sets or queries the start offset for phase jitter measurements.	
-------------	---	--

Syntax	[:SENSe]:JITTer:OFFSet:STARt <freq>	
Query Syntax	[:SENSe]:JITTer:OFFSet:STARt?	
Parameter	<freq>	<NRf>
Return parameter	<NR3>	Hz
Example	:JITt:OFFS:STAR 1.0e+7	

Set →

→ Query

[:SENSe]:JITTer:OFFSet:STOP

Description Sets or queries the stop offset for phase jitter measurements.

Syntax	[:SENSe]:JITTer:OFFSet:STOP <freq>	
Query Syntax	[:SENSe]:JITTer:OFFSet:STOP?	
Parameter	<freq>	<NRf>
Return parameter	<NR3>	Hz
Example	:JITt:OFFS:STOP 1.5e+7	

Set →

→ Query

[:SENSe]:NDB:BANDwidth|BWIDth

Description Sets or queries the NdB amplitude for NdB bandwidth measurements.

Syntax	[:SENSe]:NDB:BANDwidth BWIDth <rel_amp>	
Query Syntax	[:SENSe]:NDB:BANDwidth BWIDth?	
Parameter	<rel_amp>	<NRf>
Return parameter	<NR3>	dB
Example	:NDB:BAND 3 dB	

Set →

→ Query

[:SENSe]:OCBW:BANDwidth|BWIDth

Description Sets or queries the OCBW bandwidth for OCBW measurements.

Syntax	[:SENSe]:OCBW:BANDwidth BWIDth <freq>	
--------	---------------------------------------	--

Query Syntax	[:SENSe]:OCBW:BANDwidth BWIDth?	
Parameter	<freq>	<NRf>
Return parameter	<NR3>	Hz
Example	:OCBW:BAND 4.5+6	

Set →
 → Query

Description	Sets or queries the OCBW percentage (OCBW %) parameter.	
Syntax	[:SENSe]:OCBW:PERCent <integer>	
Query Syntax	[:SENSe]:OCBW:PERCent?	
Parameter/ Return parameter	<integer>	<NR1>0~100
Example	:OCBW:PERC 90	

Set →
 → Query

Description	Sets or queries the OCBW channel space for OCBW measurements.	
Syntax	[:SENSe]:OCBW:SPACe <freq>	
Query Syntax	[:SENSe]:OCBW:SPACe?	
Parameter	<freq>	<NRf>
Return parameter	<NR3>	
Example	:OCBW:SPAC 6e+7	

Set →
 → Query

Description	Sets or queries the number of samples used for the average function in the P1dB function.	
Syntax	:SENSe:P1DB:AVERAge:COUnT <NR1>	
Query Syntax	:SENSe:P1DB:AVERAge:COUnT?	

Parameter	<NR1>	The average number.
Return parameter	<NR1>	Returns the average number.
Example	:P1DB:AVER:COUN 10	

Set →
 → Query

Description	Sets or queries the gain offset in dB.	
Syntax	:SENSe:P1DB:GAIN:OFFSet <rel_amp >	
Query Syntax	:SENSe:P1DB:GAIN:OFFSet?	
Parameter	<rel_amp >	<NRf>
Return parameter	<NR3>	Returns the gain offset value in dB.
Example	:P1DB:GAIN:OFFS 10.00e+00	

Set →
 → Query

Description	Sets or queries the power meter measurement frequency.	
Syntax	[:SENSe]:PMETer:FREQuency <freq>	
Query Syntax	[:SENSe]:PMETer:FREQuency?	
Parameter	<freq>	<NRf>
Return parameter	<NR3>	Hz
Example	:PMET:FREQ 2e+7	

Set →
 → Query

Description	Sets or queries the power meter high limit for pass/fail tests.	
Syntax	[:SENSe]:PMETer:HLIMit <amp >	
Query Syntax	[:SENSe]:PMETer:HLIMit?	
Parameter	<amp >	<NRf> power unit, default = dBm
Return parameter	<NR3>	Unit = current unit.

Example :PMET:HLIM 10

[[:SENSE]:PMETer:HOLD:STATe

Set →

→ Query

Description Turns the power meter Max/Min Hold function on/off or queries its state.

Syntax [[:SENSE]:PMETer:HOLD:STATe {OFF|ON|0|1}

Query Syntax [[:SENSE]:PMETer:HOLD:STATe?

Parameter	0	Turn the Max/Min Hold function off.
	1	Turn the Max/Min Hold function on.
	OFF	Turn the Max/Min Hold function off.
	ON	Turn the Max/Min Hold function on.

Return parameter	0	The Max/Min Hold function is off.
	1	The Max/Min Hold function is on.

Example :PEMT:HOLD:STAT 0

[[:SENSE]:PMETer:LLIMit

Set →

→ Query

Description Sets or queries the power meter low limit for pass/fail tests.

Syntax [[:SENSE]:PMETer:LLIMit <ampl>

Query Syntax [[:SENSE]:PMETer:LLIMit?

Parameter <ampl> <NRf> power unit, default = dBm

Return parameter <NR3> Unit = current unit.

Example :PMET:LLIM 0

[[:SENSE]:PMETer:PSEnSor:MODE

Set →

→ Query

Description Sets or queries the power meter sensor mode.

Syntax [[:SENSE]:PMETer:PSEnSor:MODE
{LOWNoise|FASTer}

Query Syntax [[:SENSE]:PMETer:PSEnSor:MODE?

Parameter/	LOWNoise	Sets the power meter mode to low noise.
Return parameter	FASTer	Set the power meter mode to fast.
Example	:PMET:PSEN:MODE	

Set →
 → Query

Description	Sets or queries the power meter recording time.	
Syntax	[:SENSe]:PMETer:RECORDing:TIME <hour>,<minute>,<second>	
Query Syntax	[:SENSe]:PMETer:RECORDing:TIME?	
Parameter/	<hour>	<NR1>Recording time: hours.
Return parameter	<minute>	<NR1>Recording time: minutes.
	<second>	<NR1>Recording time: seconds.
Example	:PMET:REC:TIME 1,10,30	

Set →
 → Query

Description	Sets or queries the power meter recording interval in seconds.	
Syntax	[:SENSe]:PMETer:RECORDing:TIME:STEP <time>	
Query Syntax	[:SENSe]:PMETer:RECORDing:TIME:STEP?	
Parameter	<time>	<NRf>
Return parameter	<NR3>	seconds
Example	:PMET:REC:TIME:STEP 10s	

Set →
 → Query

Description	Sets the preamplifier to Auto or Bypass mode or queries its state.	
Syntax	[:SENSe]:POWER[:RF]:GAIN {AUTO BYPASS}	
Query Syntax	[:SENSe]:POWER[:RF]:GAIN?	

Parameter/	AUTO	Sets the preamplifier to auto mode.
Return parameter	BYPASS	Sets the preamplifier to bypass mode.
Example	:POW:GAIN AUTO	

[[:SENSe]:SEMAsk:BANDwidth|BWIDth: INTegration (Set) →
→ (Query)

Description	Sets or queries the channel integration bandwidth for SEM measurements (user defined only).	
Syntax	[:SENSe]:SEMAsk:BANDwidth BWIDth:INTegration <freq>	
Query Syntax	[:SENSe]:SEMAsk:BANDwidth BWIDth:INTegration?	
Parameter	<freq>	<NRf>
Return parameter	<NR3>	Hz
Example	:SEM:BAND:INT 3.84e+6	

[[:SENSe]:SEMAsk:BANDwidth|BWIDth [:RESolution] (Set) →
→ (Query)

Description	Sets or queries the RBW for SEM measurements.	
Syntax	[:SENSe]:SEMAsk:BANDwidth BWIDth[:RESolution] <freq>	
Query Syntax	[:SENSe]:SEMAsk:BANDwidth BWIDth[:RESolution]?	
Parameter	<freq>	<NRf>
Return parameter	<NR3>	Hz
Example	:SEM:BAND 2.2e+4	

[[:SENSe]:SEMAsk:BANDwidth|BWIDth [:RESolution]:AUTO (Set) →
→ (Query)

Description	Turns the RBW setting to auto (on) or manual (off) for SEM measurements or queries its state.	
-------------	---	--

Syntax [:SENSe]:SEMAsk:BANDwidth|BWIDth[:RESolution]:
AUTO {OFF|ON|0|1}

Query Syntax [:SENSe]:SEMAsk:BANDwidth|BWIDth[:RESolution]:
AUTO?

Parameter	0	Turn RBW to manual (off).
	1	Turn RBW to auto (on).
	OFF	Turn RBW to manual (off).
	ON	Turn RBW to auto (on).

Return parameter	0	RBW is set to manual.
	1	RBW is set to automatic.

Example :SEM:BAND:AUTO OFF

Set →
 → Query

[:SENSe]:SEMAsk:CARRier:AUTO

Description Turns the PSDRef or TotalPwrRef modes to auto (on) or manual (off) for SEM measurements or queries their state.

Syntax [:SENSe]:SEMAsk:CARRier:AUTO {OFF|ON|0|1}

Query Syntax [:SENSe]:SEMAsk:CARRier:AUTO?

Parameter	0	Turn PSDRef/TotalPwrRef to manual (off).
	1	Turn PSDRef/TotalPwrRef to auto (on).
	OFF	Turn PSDRef/TotalPwrRef to manual (off).
	ON	Turn PSDRef/TotalPwrRef to auto (on).

Return parameter	0	PSDRef/TotalPwrRef is set to manual.
	1	PSDRef/TotalPwrRef is set to automatic.

Example :SEM:CARR:AUTO OFF

Set →
 → Query

[:SENSe]:SEMAsk:CARRier:CPSD

Description Sets or queries the value of the PSDRef for SEM measurements.

Syntax [:SENSe]:SEMAsk:CARRier:CPSD <NR3>

Query Syntax	[:SENSe]:SEMAsk:CARRier:CPsD?	
Parameter/ Return parameter	<NR3>	PSD ref unit = dBm/Hz
Example	:SEM:CARR:CPsD 20	

Set →
 → Query

Description	Sets or queries the value of the TotalPwrRef amplitude for SEM measurements.	
Syntax	[:SENSe]:SEMAsk:CARRier: POWer <ampl>	
Query Syntax	[:SENSe]:SEMAsk:CARRier: POWer?	
Parameter	<ampl>	<NRf>
Return parameter	<NR3>	dBm
Example	:SEM:CARR:POW 2 dbm	

Set →
 → Query

Description	Sets or queries the channel span for SEM measurements (user-defined only).	
Syntax	[:SENSe]:SEMAsk:FREQUency:SPAN<freq>	
Query Syntax	[:SENSe]:SEMAsk:FREQUency:SPAN?	
Parameter	<freq>	<NR3>
Return parameter	<NR3>	Hz
Example	:SEM:FREQ:SPAN 2.2e+7	

Set →
 → Query

Description	Sets or queries the modulation type for the 802.11g SEM measurement.	
Syntax	[:SENSe]:SEMAsk:GWLan:MODulation {GROup<n>}	
Query Syntax	[:SENSe]:SEMAsk:GWLan:MODulation?	

Parameter/	<n>=1	ERP-DSSS/ERP-PBCC/ERP-CCK
Return parameter	<n>=2	ERP-OFDM/DSSS-OFDM

Example :SEM:GWL:MOD GRO1

[[:SENSe]:SEMAsk:HELP:STATe (Set) →
→ (Query)

Description Turns the on-screen help window on/off or queries its state.

Syntax [[:SENSe]:SEMAsk:HELP:STATe {OFF|ON|0|1}

Query Syntax [[:SENSe]:SEMAsk:HELP:STATe?

Parameter	0	Turns the help window off.
	1	Turns the help window on.
	OFF	Turns the help window off.
	ON	Turns the help window on.

Return parameter	0	Help window is off.
	1	Help window is on.

Example :SEM:HELP:STATE 1

[[:SENSe]:SEMAsk:NWLan:CHANnel: (Set) →
 BANDwidth|BWIDth → (Query)

Description Sets the channel bandwidth for the 802.11n SEM measurement. Only 20MHz or 40MHz can be used.

Syntax [[:SENSe]:SEMAsk:NWLan:CHANnel: BANDwidth|BWIDth <freq>

Parameter	<freq>	<NRf> (20 MHz or 40MHz)
-----------	--------	-------------------------

Return parameter	<NR3>
------------------	-------

Example :SEM:NWL:CHAN:BAND 20 MHZ

[[:SENSE]:SEMASK:OFFSet<n>:ADDITION:
BANDwidth|BWIDth[:RESolution]?

→ Query

Description Returns the RBW of the selected offset for the additional requirements of the selected 3GPP SEM test.

Query syntax [[:SENSE]:SEMASK:OFFSet<n>:ADDITION:
BANDwidth|BWIDth[:RESolution]?

3GPP-FDD BS Additional Requirements For operation in bands II, IV, V, X, XII, XIII, XIV and XXV, additional requirements (listed below) apply in addition to the minimum requirements listed above.

For 3GPP-FDD UE
A means <1>
B means <2>
(UM P138)

	Unit: MHz	Additional ^[3]	RBW
Bands: II, IV, X	$2.5 \leq A < 3.5$	-15dBm	30kHz
	$3.5 \leq B < \Delta f_{max}$	-13dBm	1 MHz
Bands: V	Unit: MHz	Additional ^[3]	RBW
	$2.5 \leq A < 3.5$	-15dBm	30kHz
	$3.5 \leq B < \Delta f_{max}$	-13dBm	100kHz
Bands: XII, XIII, XIV	Unit: MHz	Additional ^[3]	RBW
	$2.5 \leq A < 3.5$	-13dBm	30kHz
	$3.5 \leq B < \Delta f_{max}$	-13dBm	100kHz

3GPP-FDD UE Additional Requirements	Additional requirements for 3GPP-FDD UE. For 3GPP-FDD BS: A means <1> B means <2> (UM P137)		
Bands II, IV, X	Unit: MHz	Additional ^[3]	RBW
	$2.5 \leq A < 3.5$	-15dBm	30kHz
Band V	Unit: MHz	Additional ^[3]	RBW
	$3.5 \leq B < 12.5$	-15dBm	1MHz
Bands XII, XIII, XIV	Unit: MHz	Additional ^[3]	RBW
	$2.5 \leq A < 3.5$	-13dBm	30kHz
Parameter/Return parameter	<n>	Offset 1 to 5	
	<NR3>	RBW in Hz	
Example	:SEM:OFFS1:ADD:BAND? > 3.000000000e+04		

[[:SENSe]:SEMAsk:OFFSet<n>:ADDition:
FREQuency:STARt?

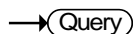

Description	Returns the start frequency (referred to the center) of the selected offset for the additional requirements of the selected 3GPP SEM test.		
Query syntax	[:SENSe]:SEMAsk:OFFSet<n>:ADDition: FREQuency:STARt?		
Parameter/Return parameter	<n>	Offset 1 to 5	
	<NR3>	Start frequency in Hz	
Example	:SEM:OFFS1:ADD:FREQ:STAR? >2.5e+6		

`[:SENSe]:SEMask:OFFSet<n>:ADDition:
FREQuency:STOP?` → Query

Description	Returns the stop frequency (referred to the center) of the selected offset for the additional requirements of the selected 3GPP SEM test.	
Query syntax	[:SENSe]:SEMask:OFFSet<n>:ADDition: FREQuency:STOP?	
Parameter/ Return parameter	<n> <NR3>	Offset 1 to 5 Stop frequency in Hz
Example	:SEM:OFFS1:ADD:FREQ:STOP? >3.5e+6	

`[:SENSe]:SEMask:OFFSet<n>:ADDition:
STARt:ABSolute?` → Query

Description	Returns the “start” amplitude (dBm) of the Absolute Mask for the selected offset for the additional requirements of the selected 3GPP SEM test.	
Query syntax	[:SENSe]:SEMask:OFFSet<n>:ADDition:STARt: ABSolute?	
Parameter/ Return parameter	<n> <NR3>	Offset 1 to 5 Amplitude at start frequency
Example	:SEM:OFFS1:ADD:STAR:ABS? >-1.5e+1	

`[:SENSe]:SEMask:OFFSet<n>:ADDition:
STOP:ABSolute?` → Query

Description	Returns the “Stop” amplitude (dBm) of the Absolute Mask for the selected offset for the additional requirements of the selected 3GPP SEM test.	
-------------	--	--

Query syntax	[:SENSe]:SEMAsk:OFFSet<n>:ADDition:STOP:ABSolute?	
Parameter/	<n>	Offset 1 to 5
Return parameter	<NR3>	Amplitude at stop frequency
Example	:SEM:OFFS1:ADD:STOP:ABS?>-1.5e+1	

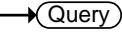
[:SENSe]:SEMAsk:OFFSet<n>:BANDwidth| 
 BWIDth[:RESolution] 

Description	Sets or queries the resolution bandwidth of the selected offset.	
Syntax	[:SENSe]:SEMAsk:OFFSet<n>:BANDwidth BWIDth[:RESolution] <freq>	
Query Syntax	[:SENSe]:SEMAsk:OFFSet<n>:BANDwidth BWIDth[:RESolution]?	
Parameter/	<freq>	<NR3> Hz
Return parameter	<n>	<NR1>offset 1~5
Example	:SEM:OFFS1:BAND 3.0e+3	

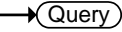
[:SENSe]:SEMAsk:OFFSet<n>:BANDwidth|B 
 WIDth[:RESolution]:AUTO 

Description	Turns the resolution bandwidth for the selected channel to manual or automatic mode or queries its state.	
Syntax	[:SENSe]:SEMAsk:OFFSet<n>:BANDwidth BWIDth[:RESolution]:AUTO {OFF ON 0 1}	
Query Syntax	[:SENSe]:SEMAsk:OFFSet<n>:BANDwidth BWIDth[:RESolution]:AUTO?	
Parameter	0	Set RBW to manual.
	1	Set RBW to auto.
	OFF	Set RBW to manual.
	ON	Set RBW to auto.

Return parameter	0	RBW is set to manual.
	1	RBW is set to auto.

Example :SEM:OFFS1:BAND:AUTO ON

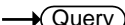
[[:SENSEj]:SEMMask:OFFSet<n>:FREQUENCY:  →
START 

Description Sets or queries the start frequency of the selected offset.

Syntax [[:SENSEj]:SEMMask:OFFSet<n>:FREQUENCY:START <freq>

Query Syntax [[:SENSEj]:SEMMask:OFFSet<n>:FREQUENCY:START?

Parameter/ Return parameter	<freq> <n>	<NR3> Hz <NR1>offset 1~5
--------------------------------	---------------	-----------------------------

Example :SEM:OFFS1:FREQ:STAR 2.5e+3

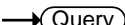
[[:SENSEj]:SEMMask:OFFSet<n>:FREQUENCY:  →
STOP 

Description Sets or queries the stop frequency of the selected offset.

Syntax [[:SENSEj]:SEMMask:OFFSet<n>:FREQUENCY:STOP <freq>

Query Syntax [[:SENSEj]:SEMMask:OFFSet<n>:FREQUENCY:STOP?

Parameter/ Return parameter	<freq> <n>	<NR3> Hz <NR1>offset 1~5
--------------------------------	---------------	-----------------------------

Example :SEM:OFFS1:FREQ:STOP 2.5e+3

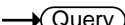
[[:SENSEj]:SEMMask:OFFSet<n>:START:  →
ABSolute 

Description Sets or queries the amplitude of the start frequency of the Absolute Mask for the selected offset.

Syntax	[:SENSe]:SEMAsk:OFFSet<n>:STARt:ABSolute <ampl>	
Query Syntax	[:SENSe]:SEMAsk:OFFSet<n>:STARt:ABSolute?	
Parameter/ Return parameter	<ampl> <n>	<NR3> dBm <NR1> offset 1~5
Example	:SEM:OFFS1:STAR:ABS 1.5e+1	

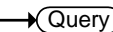
[:SENSe]:SEMAsk:OFFSet<n>:STARt:RELative  

Description	Sets or queries the amplitude of the start frequency of the Relative Mask for the selected offset.	
Syntax	[:SENSe]:SEMAsk:OFFSet<n>:STARt:RELative <ampl>	
Query Syntax	[:SENSe]:SEMAsk:OFFSet<n>:STARt:RELative?	
Parameter/ Return parameter	<ampl> <n>	<NR3> dBc <NR1> offset 1~5
Example	:SEM:OFFS1:STAR:REL 2.5e+1	

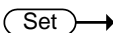
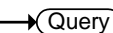
[:SENSe]:SEMAsk:OFFSet<n>:STATe  

Description	Turns the selected offset on/off or queries its state.	
Syntax	[:SENSe]:SEMAsk:OFFSet<n>:STATe {OFF ON 0 1}	
Query Syntax	[:SENSe]:SEMAsk:OFFSet<n>:STATe?	
Parameter	0 1 OFF ON	Turns the selected offset off. Turns the selected offset on. Turns the selected offset off. Turns the selected offset on.
Return parameter	0 1	The selected offset is off. The selected offset is on.
Example	:SEM:OFFS1:STAT 1	

`[[:SENSe]:SEMAsk:OFFSet<n>:STOP` (Set) →
`:ABSolute` → (Query)

Description	Sets or queries the amplitude of the stop frequency of the Absolute Mask for the selected offset.	
Syntax	[:SENSe]:SEMAsk:OFFSet<n>:STOP:ABSolute <ampl>	
Query Syntax	[:SENSe]:SEMAsk:OFFSet<n>:STOP:ABSolute?	
Parameter/ Return parameter	<ampl> <n>	<NR3> dBm <NR1>offset 1~5
Example	:SEM:OFFS1:STOP:ABS 1.5e+1	

`[[:SENSe]:SEMAsk:OFFSet<n>:STOP:` (Set) →
`ABSolute:COUple` → (Query)

Description	Couples the Absolute Stop amplitude to the Absolute Start amplitude for the selected offset.	
Syntax	[:SENSe]:SEMAsk:OFFSet<n>:STOP:ABSolute:COUple {OFF ON 0 1}	
Query Syntax	[:SENSe]:SEMAsk:OFFSet<n>:STOP:ABSolute:COUple?	
Parameter	0 1 OFF ON	Turns coupling off. Turns coupling on. Turns coupling off. Turns coupling on.
Return parameter	0 1	Coupling is off. Coupling is on.
Example	:SEM:OFFS1:STOP:ABS:COUP 0	

`[[:SENSe]:SEMAsk:OFFSet<n>:STOP:` (Set) →
`RELative` → (Query)

Description	Sets or queries the amplitude of the stop frequency of the Relative Mask for the selected offset.	
-------------	---	--

Syntax	[:SENSe]:SEMAsk:OFFSet<n>:STOP:RELative <ampl>	
Query Syntax	[:SENSe]:SEMAsk:OFFSet<n>:STOP:RELative?	
Parameter/ Return parameter	<ampl> <n>	<NR3> dBc <NR1>offset 1~5
Example	:SEM:OFFS1:STOP:REL 1.5e+1	

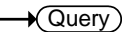
[:SENSe]:SEMAsk:OFFSet<n>:STOP: 
 RELative:COUple 

Description	Couples the Relative Stop amplitude to the Relative Start amplitude for the selected offset.	
Syntax	[:SENSe]:SEMAsk:OFFSet<n>:STOP:RELative:COUple {OFF ON 0 1}	
Query Syntax	[:SENSe]:SEMAsk:OFFSet<n>:STOP:RELative:COUple?	
Parameter	0 1 OFF ON	Turns coupling off. Turns coupling on. Turns coupling off. Turns coupling on.
Return parameter	0 1	Coupling is off. Coupling is on.
Example	:SEM:OFFS1:STOP:REL:COUP ON	

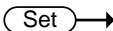
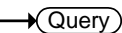
[:SENSe]:SEMAsk:OFFSet<n>:TEST 

Description	Sets or queries the masks to use for the Fail Mask(s).	
Syntax	[:SENSe]:SEMAsk:OFFSet<n>:TEST {ABS REL AND OR}	
Query Syntax	[:SENSe]:SEMAsk:OFFSet<n>:TEST?	
Parameter/ Return parameter	ABS REL AND	Absolute mask Relative mask Absolute and Relative mask

OR Absolute or Relative mask

Example :SEM:OFFS1:TEST ABS

[[:SENSE]:SEMmask:SElect

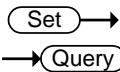

Description Selects or queries the type of spectrum emission mask.

Syntax [[:SENSE]:SEMmask:SElect {MANual|W3GPP|BWLan|GWLan|NWLan|WIMax}

Query Syntax [[:SENSE]:SEMmask:SElect?

Parameter/	MANual	User-defined SEM
Return parameter	W3GPP	3GPP SEM
	BWLan	802.11b SEM
	GWLan	802.11g SEM
	NWLan	802.11n SEM
	WIMax	802.16 SEM

Example :SEM:SEL MAN

[[:SENSE]:SEMmask:TYPE

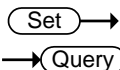

Description Selects or queries the method used as the reference for calculating the offset power: Total power reference or power spectral density reference.

Syntax [[:SENSE]:SEMmask:TYPE {PSDRef|TPRef}

Query Syntax [[:SENSE]:SEMmask:TYPE?

Parameter/	PSDRef	Power Spectral Density Reference
Return parameter	TPRef	Total Power Reference

Example :SEM:TYPE PSDR

[[:SENSE]:SEMmask:W3GPP:DUPLex:TYPE

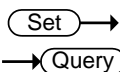

Description Selects or queries the type of duplexing used for 3GPP tests.

Syntax [[:SENSE]:SEMmask:W3GPP:DUPLex:TYPE {FDD|TDD}

Query Syntax	[:SENSe]:SEMAsk:W3GPP:DUPLex:TYPE?	
Parameter/	FDD	Frequency-division duplexing
Return parameter	TDD	Time-division duplexing
Example	:SEM:W3GPP:DUPL:TYPE FDD	

[:SENSe]:SEMAsk:W3GPP:FDD:ADDITION:
LIMit (Set) →
→ (Query)

Description	Selects or queries the operating band used for the 3GPP FDD additional requirements. See the user manual for a list of the 3GPP operation bands.	
Syntax	[:SENSe]:SEMAsk:W3GPP:FDD:ADDITION:LIMit {NONE BAND<n>}	
Query Syntax	[:SENSe]:SEMAsk:W3GPP:FDD:ADDITION:LIMit?	
Parameter/	NONE	
Return parameter	BAND<n>	When n = band number
Example	:SEM:W3GPP:FDD:ADD:LIM BAND4	

[:SENSe]:SEMAsk:W3GPP:FDD:ADDITION:
MOPower (Set) →
→ (Query)

Description	Selects or queries Max Out Power for the 3GPP additional requirements for the selected offset. Please see the user manual for a list of the selectable maximum power output levels.	
Syntax	[:SENSe]:SEMAsk:W3GPP:FDD:ADDITION:MOPower {NONE LEVEL<n>}	
Query Syntax	[:SENSe]:SEMAsk:W3GPP:FDD:ADDITION:MOPower?	
Parameter/	NONE	
Return parameter	LEVEL<n>	n=1 for 6≤P≤20 n=2 for P<6
Example	:SEM:W3GPP:FDD:ADD:MOP LEV1	

[[:SENSE]:SEMask:W3GPP:FDD:MOPower (Set) →
→ (Query)

Description	Selects or queries Max Out Power for the selected offset. Please see the user manual for a list of the selectable maximum power output levels.	
Syntax	[:SENSE]:SEMask:W3GPP:FDD:MOPower {LEVEL<n>}	
Query Syntax	[:SENSE]:SEMask:W3GPP:FDD:MOPower?	
Parameter/ Return parameter	NONE LEVEL<n>	n=1 for P>=43 n=2 for 39<=P<43 n=3 for 31<=P<39 n=4 for P<31
Example	:SEM:W3GPP:FDD:MOP LEV1	

[[:SENSE]:SEMask:W3GPP:FDD:TRANsmi:t:MODE (Set) →
→ (Query)

Description	Selects or queries the transmit mode of the FDD 3GPP test: Base station, or User Equipment.	
Syntax	[:SENSE]:SEMask:W3GPP:FDD:TRANsmi:t:MODE {BS UE}	
Query Syntax	[:SENSE]:SEMask:W3GPP:FDD:TRANsmi:t:MODE?	
Parameter/ Return parameter	BS UE	Base station User Equipment
Example	:SEM:W3GPP:FDD:TRAN:MODE UE	

[[:SENSE]:SEMask:W3GPP:TDD:CHIP:RATE (Set) →
→ (Query)

Description	Selects or queries the chip rate for TDD 3GPP tests.	
Syntax	[:SENSE]:SEMask:W3GPP:TDD:CHIP:RATE {3.84e+6 1.28e+6 7.68e+6}	
Query Syntax	[:SENSE]:SEMask:W3GPP:TDD:CHIP:RATE?	

Parameter/	3.84e+6	<freq>
Return parameter	1.28e+6	<freq>
	7.68e+6	<freq>

Example :SEM:W3GPP:TDD:CHIP:RATE 3.84e+6

[[:SENSe]:SEMAsk:W3GPP:TDD:MOPower (Set) →
→ (Query)

Description Selects or queries Max Out Power for TDD 3GPP tests. See the user manual for a list of the power levels.

Syntax [[:SENSe]:SEMAsk:W3GPP:TDD:MOPower {LEVel<n>}

Query Syntax [[:SENSe]:SEMAsk:W3GPP:TDD:MOPower?

Parameter/ Return parameter	LEVEL<n>	For 3GPP TDD BS 3.84 and 7.68Mcps : n=1 for P>=43 n=2 for 39<=P<43 n=3 for 31<=P<39 n=4 for P<31 for 3GPP TDD BS 1.28Mcps: n=1 for P>=34 n=2 for 26<=P<34 n=3 for P<26
--------------------------------	----------	--

Example :SEM:W3GPP:TDD:MOP LEV1

[[:SENSe]:SEMAsk:W3GPP:TDD:TRANsmit:MODE (Set) →
→ (Query)

Description Selects or queries the transmit mode of the TDD 3GPP test: Base station, or User Equipment.

Syntax [[:SENSe]:SEMAsk:W3GPP:TDD:TRANsmit:MODE {BS|UE}

Query Syntax [[:SENSe]:SEMAsk:W3GPP:TDD:TRANsmit:MODE?

Parameter/	BS	Base station
Return parameter	UE	User Equipment

Example :SEM:W3GPP:TDD:TRAN:MODE UE

[[:SENSe]:SEMAsk:WIMax:CHANnel:
BANDwidth|BWIDth Set →
→ Query

Description Selects or queries the 802.16 channel bandwidth (10M or 20M channelization).

Syntax [:SENSe]:SEMAsk:WIMax:CHANnel:BANDwidth|BWIDth {1e+7|2e+7}

Query Syntax [:SENSe]:SEMAsk:WIMax:CHANnel:BANDwidth|BWIDth?

Parameter/ 1e+7 <freq>

Return parameter 2e+7 <freq>

Example :SEM:WIM:CHAN:BAND 1e+7

[[:SENSe]:SEQuence<n>:DELeTe Set →

Description Deletes the chosen sequence.

Syntax [:SENSe]:SEQuence<n>:DELeTe

Parameter <n> <NR1> sequence 1 to 5.

Example :SEQ1:DEL

[[:SENSe]:SWEep:EGATe:DELay Set →
→ Query

Description Sets or queries the gate delay time.

Syntax [:SENSe]:SWEep:EGATe:DELay <time>

Query Syntax [:SENSe]:SWEep:EGATe:DELay?

Parameter/ <time> Gate delay time in seconds

Return parameter

Example :SWE:EGAT:DEL 10 ms

Set →
 → Query

[[:SENSe]:SWEep:EGATe:LENGth

Description	Sets or queries the gate length time.	
Syntax	[:SENSe]:SWEep:EGATe:LENGth <time>	
Query Syntax	[:SENSe]:SWEep:EGATe:LENGth?	
Parameter/ Return parameter	<time>	Gate length time in seconds
Example	:SWE:EGAT:LENG 10 ms	

Set →
 → Query

[[:SENSe]:SWEep:EGATe:STATe

Description	Turns the gated sweep mode on/off or queries its state.	
Syntax	[:SENSe]:SWEep:EGATe:STATe {OFF ON 0 1}	
Query Syntax	[:SENSe]:SWEep:EGATe:STATe?	
Parameter	0 1 OFF ON	Turns gated sweep mode off. Turns gated sweep mode on. Turns gated sweep mode off. Turns gated sweep mode on.
Return parameter	0 1	Gated sweep mode is off. Gated sweep mode is on.
Example	:SWE:EGAT:STAT 1	

Set →
 → Query

[[:SENSe]:SWEep:MODE

Description	Sets or queries the sweep mode.	
Syntax	:SENSe:SWEep:MODE {FAST NORMAl}	
Query Syntax	:SENSe:SWEep:MODE?	
Parameter	FAST NORMAL	Sets to fast mode Sets to normal mode
Return parameter	FAST NORMAL	Sets to fast mode Sets to normal mode

Example :SENS:SWE:MODE FAST

[[:SENSe]:SWEep:TIME

Set →

→ Query

Description Sets the sweep time.

Syntax [[:SENSe]:SWEep:TIME <time>

Query Syntax [[:SENSe]:SWEep:TIME?

Parameter/ Return parameter	<time>	Sweep time in seconds
--------------------------------	--------	-----------------------

Example :SWE:TIME 60 ms

[[:SENSe]:SWEep:TIME:AUTO

Set →

→ Query

Description Turns the Sweep time setting to auto (on) or manual (off).

Syntax [[:SENSe]:SWEep:TIME:AUTO {OFF|ON|0|1}

Query Syntax [[:SENSe]:SWEep:TIME:AUTO?

Parameter	0	Turn sweep time to manual (off).
	1	Turn sweep time to auto (on).
	OFF	Turn sweep time to manual (off).
	ON	Turn sweep time to auto (on).

Return parameter	0	Sweep time is set to manual.
	1	Sweep time is set to automatic.

Example :SWE:TIME:AUTO 0

[[:SENSe]:TOI:REFeRence

Set →

→ Query

Description Sets or queries the TOI reference to the upper or lower base.

Syntax [[:SENSe]:TOI:REFeRence {UPPer|LOWer}

Query Syntax [[:SENSe]:TOI:REFeRence?

Parameter/ Return parameter	UPPer	Upper base.
	LOWer	Lower base.

Example :TOI:REF UPP

[[:SENSe]:TOI:LIMit

Set →

→ Query

Description Sets the TOI pass/fail limit amplitude.

Syntax [[:SENSe]:TOI:LIMit <ampl>

Query Syntax [[:SENSe]:TOI:LIMit?

Parameter <ampl> <NRf>Power or voltage

Return parameter <NR3>

Example :TOI:LIM 30

SOURce Commands

:SOURce:P1DB:TYPE	216
:SOURce:POWer[:LEVel][:IMMediate][:AMPLitude] ..	216
:SOURce:POWer[:LEVel][:IMMediate][:AMPLitude]	
:OFFSet.....	217
:SOURce:POWer[:LEVel][:IMMediate][:AMPLitude]	
:STEP	217
:SOURce:POWer[:LEVel][:IMMediate][:AMPLitude]: STEP:AUTO	217
:SOURce:POWer:MODE	218
:SOURce:POWer:SWEep.....	218

:SOURce:P1DB:TYPE

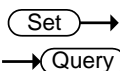

Description	Sets how the P1dB measurement is normalized.	
Syntax	:SOURce:P1DB:TYPE {RF TG}	
Query Syntax	:SOURce:P1DB:TYPE?	
Parameter	RF	Equivalent to using the “Gain Offset” setting.
	TG	Equivalent to using the P1dB Normalize function.
Example	:SOUR:P1DB:TYPE RF	

:SOURce:POWer[:LEVel][:IMMediate]
[:AMPLitude]

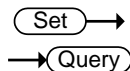

Description	Sets or queries the tracking generator power level.	
Syntax	:SOURce:POWer[:LEVel][:IMMediate][:AMPLitude] <ampl>	
Query Syntax	:SOURce:POWer[:LEVel][:IMMediate][:AMPLitude]?	
Parameter	<ampl>	<NRf>Power or voltage
Return parameter	<NR3>	

Example :SOUR:POW 30 dbm

:SOURce:POWer[:LEVel][:IMMediate] 
 [:AMPLitude]:OFFSet 

Description Sets or queries the tracking generator offset level.

Syntax :SOURce:POWer[:LEVel][:IMMediate][:AMPLitude]:
 :OFFSet <rel_amp>

Query Syntax :SOURce:POWer[:LEVel][:IMMediate][:AMPLitude]:
 :OFFSet?

Parameter <rel_amp> <NRf>

Return parameter <NR3> dB

Example :SOUR:POW:OFFS 10 db

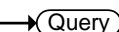
:SOURce:POWer[:LEVel][:IMMediate] 
 [:AMPLitude]:STEP 

Description Sets or queries the tracking generator step level.

Syntax :SOURce:POWer[:LEVel][:IMMediate][:AMPLitude]:
 STEP <rel_amp>

Query Syntax :SOURce:POWer[:LEVel][:IMMediate][:AMPLitude]:
 STEP?

Parameter <rel_amp> <NRf>

Return parameter <NR3> dB

Example :SOUR:POW:STEP 5 db

:SOURce:POWer[:LEVel][:IMMediate] 
 [:AMPLitude]:STEP:AUTO 

Description Turns the tracking generator step level setting to auto (on) or manual (off).

Syntax :SOURce:POWer[:LEVel][:IMMediate][:AMPLitude]:
 STEP:AUTO {OFF|ON|0|1}

Query Syntax	:SOURce:POWer[:LEVel][:IMMediate][:AMPLitude]:STEP:AUTO?	
Parameter	0	Turn TG step level to manual (off).
	1	Turn TG step level to auto (on).
	OFF	Turn TG step level to manual (off).
	ON	Turn TG step level to auto (on).
Return parameter	0	TG step level is set to manual.
	1	TG step level is set to automatic.
Example	:SOUR:POW:STEP:AUTO 1	

Set →
 → Query

Description	Sets the Power Sweep mode.	
Syntax	:SOURce:POWer:MODE {FIXed SWEep}	
Query Syntax	:SOURce:POWer:MODE?	
Parameter/ Return parameter	FIXed	Power sweep off.
	SWEep	Power sweep on.
Example	:SOUR:POW:MODE FIX	

Set →
 → Query

Description	Sets the Power Sweep offset level.	
Syntax	:SOURce:POWer:SWEep <rel_ampl>	
Query Syntax	:SOURce:POWer:SWEep?	
Parameter	<rel_ampl>	<NRf> (-5 to +5 dB)
Return parameter	<NR3>	dB
Example	:SOUR:POW:SWE 5 db	

SYSTEM Commands

:SYSTem:ALARm:STATe.....	219
:SYSTem:CLOCK<n>:DATE.....	220
:SYSTem:CLOCK<n>:MODE	220
:SYSTem:CLOCK<n>:STATe	221
:SYSTem:CLOCK<n>:TIME.....	221
:SYSTem:COMMunicate:GPIB[;SELf]:ADDRes.....	221
:SYSTem:COMMunicate:LANReset.....	222
:SYSTem:COMMunicate:SERial[;RECeive]:BAUD.....	222
:SYSTem:COMMunicate:USB:MODE.....	222
:SYSTem:DATE	222
:SYSTem:ERRor:CLEar	223
:SYSTem:ERRor[:NEXT]?	223
:SYSTem:KLOCK	223
:SYSTem:POWER:TYPE.....	223
:SYSTem:PRESet	224
:SYSTem:PRESet:TYPE	224
:SYSTem:PRESet:USER:SAVE	224
:SYSTem:REBoot	224
:SYSTem:SHUTdown	224
:SYSTem:TIME.....	225
:SYSTem:UPDate	225
:SYSTem:VERSion:HARDware?.....	225
:SYSTem:VERSion:SOFTware?.....	226

:SYSTem:ALARm:STATe

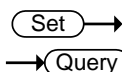

Description	Sets the system alarm output on/off.	
Syntax	:SYSTem:ALARm:STATe {OFF ON 0 1}	
Query Syntax	:SYSTem:ALARm:STATe?	
Parameter	0	Turn the alarm off.
	1	Turn the alarm on.
	OFF	Turn the alarm off.
	ON	Turn the alarm off.
Return parameter	0	The alarm is off.
	1	The alarm is on.

Example :SYST:ALAR:STAT 1

:SYSTem:CLOCK<n>:DATE

Set →

→ Query

Description Sets the day for the selected wake-up clock.

Syntax :SYSTem:CLOCK<n>:DATE
[MONday|TUESday|WEDnesday|THURsday|FRIDay|SATurday|SUNday]

Query Syntax :SYSTem:CLOCK<n>:DATE?

Parameter/	<n>	Wake-up clock number 1 to 7
Return parameter	MONday	Set to Monday
	TUESday	Set to Tuesday
	WEDnesday	Set to Wednesday
	THURsday	Set to Thursday
	FRIDay	Set to Friday
	SATurday	Set to Saturday
	SUNday	Set to Sunday

Example :SYST:CLOC1:DATE MON

:SYSTem:CLOCK<n>:MODE

Set →

→ Query

Description Sets the alarm mode for the selected wake-up clock.

Syntax :SYSTem:CLOCK<n>:MODE {REPeat|SINGle}

Query Syntax :SYSTem:CLOCK<n>:MODE?

Parameter/	<n>	Wake-up clock number 1 to 7
Return parameter	REPeat	Set the wake-up clock to repeat.
	SINGle	Set the wake-up clock to single.

Example :SYST:CLOC1:MODE REP

:SYSTem:CLOCK<n>:STATe (Set) →
→ (Query)

Description	Turns the selected wake-up clock on/off.	
Syntax	:SYSTem:CLOCK<n>:STATe {OFF ON 0 1}	
Query Syntax	:SYSTem:CLOCK<n>:STATe?	
Parameter	<n>	Wake-up clock number 1 to 7
	0	Turn the wake-up clock off.
	1	Turn the wake-up clock on.
	OFF	Turn the wake-up clock off.
	ON	Turn the wake-up clock off.
Return parameter	0	The wake-up clock is off.
	1	The wake-up clock is on.
Example	:SYST:CLOC1:STATE 1	

:SYSTem:CLOCK<n>:TIME (Set) →
→ (Query)

Description	Sets the alarm time for the selected wake-up clock.	
Syntax	:SYSTem:CLOCK<n>:TIME <hour>,<minute>	
Query Syntax	:SYSTem:CLOCK<n>:TIME?	
Parameter/	<hour>	<NR1> Sets the alarm hour.
Return parameter	<minute>	<NR1> Sets the alarm minute.
	<n>	Wake-up clock number 1 to 7
Example	:SYST:CLOC1:TIME 20,50	

**:SYSTem:COMMunicate:GPIB[:SELF]
:ADDRess** (Set) →

Description	Sets the GPIB address.	
Syntax	:SYSTem:COMMunicate:GPIB[:SELF]:ADDRess <integer>	
Parameter	<integer>	0 to 30

Example :SYST:COMM:GPIB:ADDR 10

:SYSTem:COMMunicate:LANReset (Set) →

Description Reset the LAN configuration and reboot.

Syntax :SYSTem:COMMunicate:LANReset

Example :SYST:COMM:LANR

**:SYSTem:COMMunicate:SERial[:RECeive]
:BAUD** (Set) →

Description Sets the RS232 Baud rate.

Syntax :SYSTem: COMMunicate:SERial[:RECeive]:BAUD
<integer>

Parameter	<integer>	300 600 1200 2400 4800 9600 19200 38400 57600 115200
-----------	-----------	--

Example :SYST:COMM:SER:BAUD 9600

:SYSTem:COMMunicate:USB:MODE (Set) →

Description Configures the USB mode.

Syntax :SYSTem:COMMunicate:USB:MODE {HOST|DEvice}

Parameter/ Return parameter	HOST	USB host mode
	DEvice	USB device mode

Example :SYST:COMM:USB:MODE DEV

:SYSTem:DATE (Set) →
→ (Query)

Description Sets the system date.

Syntax :SYSTem:DATE <year>,<month>,<day>

Query Syntax :SYSTem:DATE?

Parameter/	<year>	<NR1>
------------	--------	-------

Return parameter	<month>	<NR1>
	<day>	<NR1>

Example :SYST:DATE 2011,03,27

:SYSTem:ERRor:CLEar (Set) →

Description Clears the error messages from the error queue.

Syntax :SYSTem:ERRor:CLEar

:SYSTem:ERRor[:NEXT]? → (Query)

Description Returns the next message from the error queue. Reading the error from the error queue will clear that error from the queue.

Syntax :SYST:ERR?

:SYSTem:KLOCK (Set) →

Description Locks/unlocks the front panel keys.

Syntax :SYSTem:KLOCK {ON|OFF}

Parameter	ON	Lock the front panel keys
	OFF	Unlock the front panel keys

Example :SYST:KLOCK OFF

:SYSTem:POWer:TYPE (Set) →
→ (Query)

Description Sets or queries power on settings (Refer to the user manual's Power on Preset Settings chapter).

Syntax :SYSTem:POWer:TYPE {LAST | PRESet}

Query Syntax :SYSTem:POWer:TYPE?

Parameter/ Return parameter	LAST	Loads the last settings that were used when the unit is powered up.
	PRESet	Loads the preset (default) settings when the unit is powered up.

Example :SYST:POW:TYPE?
>LAST

:SYSTem:PRESet (Set) →

Description Returns the GSP-9330 to preset settings.

Syntax :SYST:PRES

(Set) →

:SYSTem:PRESet:TYPE → (Query)

Description Sets the preset type between user-defined and factory default.

Syntax :SYSTem:PRESet:TYPE {USER|FACTORY}

Query Syntax :SYSTem:PRESet:TYPE?

Parameter/ Return parameter	USER	User defined preset
	FACTORY	Factory default

Example :SYST:PRES:TYPE USER

:SYSTem:PRESet:USER:SAVE (Set) →

Description Save the current environment as the "User" preset settings.

Syntax :SYST:PRES:USER:SAVE

:SYSTem:REBoot (Set) →

Description Restart/Reboot the GSP-9330.

Syntax :SYSTem:REBoot

:SYSTem:SHUTdown (Set) →

Description Shut down the GSP-9330.

Syntax :SYST:SHUT

:SYSTem:TIME



Description	Sets the system time.	
Syntax	:SYSTem:TIME <hour>,<minute>,<second>	
Query Syntax	:SYSTem:TIME?	
Parameter/ Return parameter	<hour> <minute> <second>	<NR1> <NR1> <NR1>
Example	:SYST:TIME 19,26,30	

:SYSTem:UPDate 

Description	Updates the system with new firmware from files located on an external USB drive. The firmware files must be included in the directory named /gsp932.
Warning	<p>Do not perform this command if the update file is <i>not</i> on the USB drive.</p> <p>If the update file is not on the USB drive, it will cause the instrument to continuously loop until a USB drive with the appropriate update file is inserted into the USB drive.</p>
Syntax	:SYST:UPD

:SYSTem:VERSIon:HARDware? 

Description	Returns the system firmware version.	
Query Syntax	:SYSTem:VERSIon:HARDware?	
Return parameter	<string>	"V.X.X.X"
Example	:SYST:VERS:HARD? >"V.3.0.0.0"	

:SYSTem:VERSion:SOFTware?

→ Query

Description Returns the system software version.

Query Syntax :SYSTem:VERSion:SOFTware?

Return parameter <string> "V3.00"

Example :SYST:VERS:SOFT?
> "V3.00"

STATus Commands

:STATus:OPERation:CONDition?	227
:STATus:OPERation:ENABle	228
:STATus:OPERation[:EVENT]?	228
:STATus:OPERation:NTRansition	229
:STATus:OPERation:PTRansition	229
:STATus:QUESTionable:CONDition?	230
:STATus:QUESTionable:ENABle	230
:STATus:QUESTionable[:EVENT]?	231
:STATus:QUESTionable:NTRansition	231
:STATus:QUESTionable:PTRansition	232
:STATus:QUESTionable:FREQuency:CONDition?	232
:STATus:QUESTionable:FREQuency:ENABle	232
:STATus:QUESTionable:FREQuency[:EVENT]?	233
:STATus:QUESTionable:FREQuency:NTRansition	233
:STATus:QUESTionable:FREQuency:PTRansition	233
:STATus:QUESTionable:ACPLimit:CONDition?	234
:STATus:QUESTionable:ACPLimit:ENABle	234
:STATus:QUESTionable:ACPLimit[:EVENT]?	235
:STATus:QUESTionable:ACPLimit:NTRansition	235
:STATus:QUESTionable:ACPLimit:PTRansition	236
:STATus:QUESTionable:SEMLimit :CONDition?	236
:STATus:QUESTionable:SEMLimit:ENABle?	237
:STATus:QUESTionable:SEMLimit[:EVENT]?	237
:STATus:QUESTionable:SEMLimit :NTRansition	238
:STATus:QUESTionable:SEMLimit:PTRansition	239
:STATus:QUESTionable:TOILimit:CONDition?	239
:STATus:QUESTionable:TOILimit:ENABle	240
:STATus:QUESTionable:TOILimit[:EVENT]?	240
:STATus:QUESTionable:TOILimit:NTRansition	240
:STATus:QUESTionable:TOILimit:PTRansition	241
:STATus:PRESet	241

:STATus:OPERation:CONDition?



Description	Returns the bit weight of the Operation Status Condition register.
-------------	--

Query Syntax	:STATus:OPERation:CONDition?
--------------	------------------------------

Return parameter	Bit	Bit Weight	Description
	0~2	N/A	Not used
	3	8	Sweeping
	4	16	Measuring
	5	32	Wait for Trigger
	6~15	N/A	Not used

Example :STAT:OPER:COND?
>8

:STATus:OPERation:ENABle (Set) →
→ (Query)

Description Sets or queries the Operation Status Event Enable register.

Syntax :STATus:OPERation:ENABle <integer>

Query Syntax :STATus:OPERation:ENABle?

Return parameter	Bit	Bit Weight	Description
	0~2	N/A	Not used
	3	8	Sweeping
	4	16	Measuring
	5	32	Wait for Trigger
	6~15	N/A	Not used

Example :STAT:OPER:ENAB 32

:STATus:OPERation[:EVENT]? → (Query)

Description Returns the bit weight of the Operation Status Event register. Reading this register will clear the event register.

Query Syntax :STATus:OPERation[:EVENT]?

Return parameter	Bit	Bit Weight	Description
	0~2	N/A	Not used
	3	8	Sweeping
	4	16	Measuring
	5	32	Wait for Trigger
	6~15	N/A	Not used

Example :STAT:OPER?
>8

:STATus:OPERation:NTRansition

Set →

→ Query

Description Sets or queries the bit weight of the NTR filter for the Operation Status register.

Syntax :STATus:OPERation:NTRansition <integer>

Query Syntax :STATus:OPERation:NTRansition?

Return parameter	Bit	Bit Weight	Description
	0~2	N/A	Not used
	3	8	Sweeping
	4	16	Measuring
	5	32	Wait for Trigger
	6~15	N/A	Not used

Example :STAT:OPER:NTR 32

Set →

→ Query

:STATus:OPERation:PTRansition

Description Sets or queries the bit weight of the PTR filter for the Operation Status register.

Syntax :STATus:OPERation:PTRansition <integer>

Query Syntax :STATus:OPERation:PTRansition?

Return parameter	Bit	Bit Weight	Description
	0~2	N/A	Not used
	3	8	Sweeping
	4	16	Measuring
	5	32	Wait for Trigger
	6~15	N/A	Not used

Example :STAT:OPER:PTR 32

:STATus:QUEStionable:CONDition? → Query

Description Returns the bit weight of the Questionable Status Condition register.

Query Syntax :STATus:QUEStionable:CONDition?

Return parameter	Bit	Bit Weight	Description
	5	32	Frequency
	8	256	Uncal
	9	512	Limit Fail
	10	1024	ACPLimit
	11	2048	SEM Limit
	12	4096	TOI Limit
	13	8192	Pmet Limit Fail

Example :STAT:QUES:COND?
>16

:STATus:QUEStionable:ENABLE Set →
→ Query

Description Sets or queries the Questionable Status Event Enable register.

Syntax :STATus:QUEStionable:ENABLE <integer>

Query Syntax :STATus:QUEStionable:ENABLE?

Return parameter	Bit	Bit Weight	Description
	5	32	Frequency
	8	256	Uncal
	9	512	Limit Fail
	10	1024	ACPLimit
	11	2048	SEM Limit
	12	4096	TOI Limit
	13	8192	Pmet Limit Fail

Example :STAT:QUES:ENAB 4096

:STATus:QUEStionable[:EVENT]?

→ Query

Description Returns the bit weight of the Questionable Status Event register. Reading this register will clear the event register.

Query Syntax :STATus:QUEStionable[:EVENT]?

Return parameter	Bit	Bit Weight	Description
	5	32	Frequency
	8	256	Uncal
	9	512	Limit Fail
	10	1024	ACPLimit
	11	2048	SEM Limit
	12	4096	TOI Limit
	13	8192	Pmet Limit Fail

Example :STAT:QUES?
>16

:STATus:QUEStionable:NTRansition

Set →

→ Query

Description Sets or queries the bit weight of the NTR filter for the Questionable Status register.

Syntax :STATus:QUEStionable:NTRansition <integer>

Query Syntax :STATus:QUEStionable:NTRansition?

Return parameter	Bit	Bit Weight	Description
	5	32	Frequency
	8	256	Uncal
	9	512	Limit Fail
	10	1024	ACPLimit
	11	2048	SEM Limit
	12	4096	TOI Limit
	13	8192	Pmet Limit Fail

Example :STAT:QUES:NTR 32

:STATus:QUEStionable:PTRansition (Set) →
→ (Query)

Description Sets or queries the bit weight of the PTR filter for the Questionable Status register.

Syntax :STATus:QUEStionable:PTRansition <integer>

Query Syntax :STATus:QUEStionable:PTRansition?

Return parameter	Bit	Bit Weight	Description
	5	32	Frequency
	8	256	Uncal
	9	512	Limit Fail
	10	1024	ACPLimit
	11	2048	SEM Limit
	12	4096	TOI Limit
	13	8192	Pmet Limit Fail

Example :STAT:QUES:PTR 32

:STATus:QUEStionable:FREQuency:CONDition? → (Query)

Description Returns the bit weight of the Questionable Status Frequency Condition register.

Query Syntax :STATus:QUEStionable:FREQuency:CONDition?

Return parameter	Bit	Bit Weight	Description
	5	32	Invalid Span/BW

Example :STAT:QUES:FREQ:COND?
>32

:STATus:QUEStionable:FREQuency:ENABLE (Set) →
→ (Query)

Description Sets or queries the Questionable Status Frequency Event Enable register.

Syntax :STATus:QUEStionable:FREQuency:ENABLE <integer>

Query Syntax :STATus:QUEStionable:FREQuency:ENABLE?

Return parameter	Bit	Bit Weight	Description
	5	32	Invalid Span/BW

Example :STAT:QUES:FREQ:ENAB 32

**:STATus:QUESTIONable:FREQuency
[:EVENT]?**

→ **Query**

Description Returns the bit weight of the Questionable Status Frequency Event register. Reading this register will clear the event register.

Query Syntax :STATus:QUESTIONable:FREQuency[:EVENT]?

Return parameter	Bit	Bit Weight	Description
	5	32	Invalid Span/BW

Example :STAT:QUES:FREQ?
>32

**:STATus:QUESTIONable:FREQuency:
NTRansition**

Set →

→ **Query**

Description Sets or queries the bit weight of the NTR filter for the Questionable Status Frequency register.

Syntax :STATus:QUESTIONable:FREQuency:NTRansition
<integer>

Query Syntax :STATus:QUESTIONable:FREQuency:NTRansition?

Return parameter	Bit	Bit Weight	Description
	5	32	Invalid Span/BW

Example :STAT:QUES:FREQ:NTR 32

**:STATus:QUESTIONable:FREQuency:
PTRansition**

Set →

→ **Query**

Description Sets or queries the bit weight of the PTR filter for the Questionable Status Frequency register.

Syntax :STATus:QUESTionable:FREQuency:PTRansition <integer>

Query Syntax :STATus:QUESTionable:FREQuency:PTRansition?

Return parameter	Bit	Bit Weight	Description
	5	32	Invalid Span/BW

Example :STAT:QUES:FREQ:PTR 32

:STATus:QUESTionable:ACPLimit:CONDition?

→ Query

Description Returns the bit weight of the Questionable Status ACP Limit Condition register.

Query Syntax :STATus:QUESTionable:ACPLimit:CONDition?

Return parameter	Bit	Bit Weight	Description
	0	1	Main channel high fail
	1	2	Main channel low fail
	2	4	Adj1 high fail
	3	8	Adj1 low fail
	4	16	Adj2 high fail
	5	32	Adj2 low fail
	6	64	Adj3 high fail
	7	128	Adj3 low fail

Example :STAT:QUES:ACPL:COND? >1

Set →

:STATus:QUESTionable:ACPLimit:ENABLE

→ Query

Description Sets or queries the Questionable Status ACP Limit Event Enable register.

Syntax :STATus:QUESTionable:ACPLimit:ENABLE <integer>

Query Syntax :STATus:QUESTionable:ACPLimit:ENABLE?

Return parameter	Bit	Bit Weight	Description
	0	1	Main channel high fail
	1	2	Main channel low fail
	2	4	Adj1 high fail

3	8	Adj1 low fail
4	16	Adj2 high fail
5	32	Adj2 low fail
6	64	Adj3 high fail
7	128	Adj3 low fail

Example :STAT:QUES:ACPL:ENAB 3

:STATus:QUESTIONable:ACPLimit[:EVENT]? → Query

Description Returns the bit weight of the Questionable Status ACP Limit Event register. Reading this register will clear the event register.

Query Syntax :STATus:QUESTIONable:ACPLimit[:EVENT]?

Return parameter	Bit	Bit Weight	Description
	0	1	Main channel high fail
	1	2	Main channel low fail
	2	4	Adj1 high fail
	3	8	Adj1 low fail
	4	16	Adj2 high fail
	5	32	Adj2 low fail
	6	64	Adj3 high fail
	7	128	Adj3 low fail

Example :STAT:QUES:ACPL?
>3

:STATus:QUESTIONable:ACPLimit:NTRansition → Set → Query

Description Sets or queries the bit weight of the NTR filter for the Questionable Status ACP Limit register.

Syntax :STATus:QUESTIONable:ACPLimit:NTRansition <integer>

Query Syntax :STATus:QUESTIONable:ACPLimit:NTRansition?

Return parameter	Bit	Bit Weight	Description
	0	1	Main channel high fail
	1	2	Main channel low fail

2	4	Adj1 high fail
3	8	Adj1 low fail
4	16	Adj2 high fail
5	32	Adj2 low fail
6	64	Adj3 high fail
7	128	Adj3 low fail

Example :STAT:QUES:ACPL:NTR 3

:STATus:QUESTionable:ACPLimit:PTRansition Set →
← Query

Description Sets or queries the bit weight of the PTR filter for the Questionable Status ACP Limit register.

Syntax :STATus:QUESTionable:ACPLimit:PTRansition <integer>

Query Syntax :STATus:QUESTionable:ACPLimit:PTRansition?

Return parameter	Bit	Bit Weight	Description
	0	1	Main channel high fail
	1	2	Main channel low fail
	2	4	Adj1 high fail
	3	8	Adj1 low fail
	4	16	Adj2 high fail
	5	32	Adj2 low fail
	6	64	Adj3 high fail
	7	128	Adj3 low fail

Example :STAT:QUES:ACPL:PTR 3

:STATus:QUESTionable:SEMLimit:CONDition? ← Query

Description Returns the bit weight of the Questionable Status SEM Limit Condition register.

Query Syntax :STATus:QUESTionable:SEMLimit:CONDition?

Return parameter	Bit	Bit Weight	Description
	0	1	Offset 1, Upper fail
	1	2	Offset 1, Lower fail

2	4	Offset 2, Upper fail
3	8	Offset 2, Lower fail
4	16	Offset 3, Upper fail
5	32	Offset 3, Lower fail
6	64	Offset 4, Upper fail
7	128	Offset 4, Lower fail
8	256	Offset 5, Upper fail
9	512	Offset 5, Lower fail

Example :STAT:QUES:SEML:COND?
>3

:STATus:QUESTIONable:SEMLimit:ENABLE?  

Description Sets or queries the Questionable Status SEM Limit Enable register.

Syntax :STATus:QUESTIONable:SEMLimit:ENABLE <integer>

Query Syntax :STATus:QUESTIONable:SEMLimit:ENABLE?

Return parameter	Bit	Bit Weight	Description
	0	1	Offset 1, Upper fail
	1	2	Offset 1, Lower fail
	2	4	Offset 2, Upper fail
	3	8	Offset 2, Lower fail
	4	16	Offset 3, Upper fail
	5	32	Offset 3, Lower fail
	6	64	Offset 4, Upper fail
	7	128	Offset 4, Lower fail
	8	256	Offset 5, Upper fail
	9	512	Offset 5, Lower fail

Example :STAT:QUES:SEML:ENAB 3

:STATus:QUESTIONable:SEMLimit[:EVENT]? 

Description Returns the bit weight of the Questionable Status SEM Limit Event register. Reading this register will clear the event register.

Query Syntax :STATus:QUESTIONable:SEMLimit[:EVENT]?

Return parameter	Bit	Bit Weight	Description
	0	1	Offset 1, Upper fail
	1	2	Offset 1, Lower fail
	2	4	Offset 2, Upper fail
	3	8	Offset 2, Lower fail
	4	16	Offset 3, Upper fail
	5	32	Offset 3, Lower fail
	6	64	Offset 4, Upper fail
	7	128	Offset 4, Lower fail
	8	256	Offset 5, Upper fail
	9	512	Offset 5, Lower fail

Example :STAT:QUES:SEML?
>3

:STATus:QUESTionable:SEMLimit 
:NTRansition 

Description Sets or queries the bit weight of the NTR filter for the Questionable Status SEM Limit register.

Syntax :STATus:QUESTionable:SEMLimit:NTRansition <integer>

Query Syntax :STATus:QUESTionable:SEMLimit:NTRansition?

Return parameter	Bit	Bit Weight	Description
	0	1	Offset 1, Upper fail
	1	2	Offset 1, Lower fail
	2	4	Offset 2, Upper fail
	3	8	Offset 2, Lower fail
	4	16	Offset 3, Upper fail
	5	32	Offset 3, Lower fail
	6	64	Offset 4, Upper fail
	7	128	Offset 4, Lower fail
	8	256	Offset 5, Upper fail
	9	512	Offset 5, Lower fail

Example :STAT:QUES:SEML:NTR 3

:STATus:QUEStionable:SEMLimit:
PTRansition

Set →
→ Query

Description Sets or queries the bit weight of the PTR filter for the Questionable Status SEM Limit register.

Syntax :STATus:QUEStionable:SEMLimit:PTRansition
<integer>

Query Syntax :STATus:QUEStionable:SEMLimit:PTRansition?

Return parameter	Bit	Bit Weight	Description
	0	1	Offset 1, Upper fail
	1	2	Offset 1, Lower fail
	2	4	Offset 2, Upper fail
	3	8	Offset 2, Lower fail
	4	16	Offset 3, Upper fail
	5	32	Offset 3, Lower fail
	6	64	Offset 4, Upper fail
	7	128	Offset 4, Lower fail
	8	256	Offset 5, Upper fail
	9	512	Offset 5, Lower fail

Example :STAT:QUES:SEML:PTR 3

:STATus:QUEStionable:TOILimit:
CONDition?

→ Query

Description Returns the bit weight of the Questionable Status TOI Limit Condition register.

Query Syntax :STATus:QUEStionable:TOILimit:CONDition?

Return parameter	Bit	Bit Weight	Description
	0	1	3 rd lower fail
	1	2	3 rd upper fail

Example :STAT:QUES:TOIL:COND?
>1

:STATus:QUEStionable:TOILimit:ENABLE



Description Sets or queries the Questionable Status TOI Limit Event Enable register.

Syntax :STATus:QUEStionable:TOILimit:ENABLE <integer>

Query Syntax :STATus:QUEStionable:TOILimit:ENABLE?

Return parameter	Bit	Bit Weight	Description
	0	1	3 rd lower fail
	1	2	3 rd upper fail

Example :STAT:QUES:TOIL:ENAB 1

:STATus:QUEStionable:TOILimit[:EVENT]? 

Description Returns the bit weight of the Questionable Status TOI Limit Event register. Reading this register will clear the event register.

Query Syntax :STATus:QUEStionable:TOILimit[:EVENT]?

Return parameter	Bit	Bit Weight	Description
	0	1	3 rd lower fail
	1	2	3 rd upper fail

Example :STAT:QUES:TOIL?
>1

:STATus:QUEStionable:TOILimit:NTRansition



Description Sets or queries the bit weight of the NTR filter for the Questionable Status TOI Limit register.

Syntax :STATus:QUEStionable:TOILimit:NTRansition <integer>

Query Syntax :STATus:QUEStionable:TOILimit:NTRansition?

Return parameter	Bit	Bit Weight	Description
	0	1	3 rd lower fail

	1	2	3 rd upper fail
Example	:STAT:QUES:TOIL:NTR 1		

:STATus:QUEStionable:TOILimit:
PTRansition (Set) →
→ (Query)

Description Sets or queries the bit weight of the PTR filter for the Questionable Status TOI Limit register.

Syntax :STATus:QUEStionable:TOILimit:PTRansition <integer>

Query Syntax :STATus:QUEStionable:TOILimit:PTRansition?

Return parameter	Bit	Bit Weight	Description
	0	1	3 rd lower fail
	1	2	3 rd upper fail

Example :STAT:QUES:TOIL:PTR 1

:STATus:PRESet (Set) →

Description Loads the preset settings.

Syntax :STATus:PRESet

TRACe Commands

:TRACe[:DATA]?	242
:PIXel? TRACe<n>	243

:TRACe[:DATA]?

→ **Query**

Description Returns the trace data for the selected trace in CSV format. There are 601 data points in total.

Query Syntax :TRACe[:DATA]? TRACe<n>

Parameter <n> <NR1> 1~4

Return Parameter <csv data> Trace data in CSV format:
point#1, point#2.....point#n

Example :TRAC? TRAC1
>-5.234e+01,-4.593e+01,-5.533e+01,-4.604e+01,-
>5.353e+01,-4.557e+01,-5.280e+0
>1,-4.785e+01,-5.459e+01,-4.578e+01,.....

:PIXel? TRACe<n>

→ **Query**

Description Returns the trace *pixel* data (real pixel value x100) for the selected trace in binary coded decimal format, represented by 2 characters per pixel (Highbyte_Lowbyte). Each trace has 601 pixels. In total, the query will return 1203 characters (601x2 + 1 EOF character). If you wish to determine the real value of a pixel simply divide the binary coded decimal character by 100. A binary coded decimal to ASCII lookup table is included in the Appendix on page 256.

The pixel data that is returned is the y-axis pixel data for each nth pixel. The pixel data is taken from the display image data (450 x 600 pixels total).

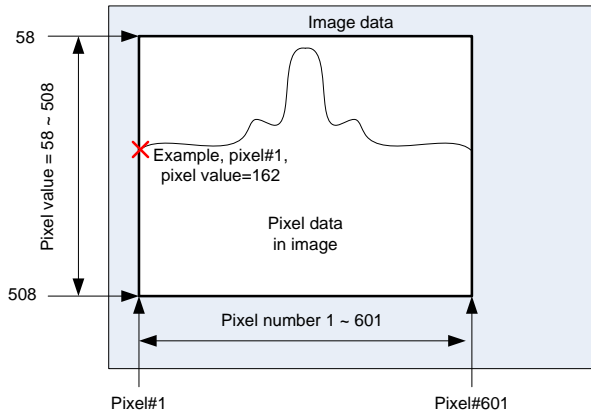

Query Syntax :PIXel? TRACe<n>

Parameter <n> <NR1> trace 1~4

Return Parameter	<code><pixel data></code>	Pixel data. Returned as ASCII code in binary coded decimal format: #41202 pixel1#HbyteLbyte pixel2#HbyteLbyte pixel3#HbyteLbyte.....and so on until the EOF character
------------------	---------------------------------	---

Example :PIXEL? TRACE1
 >
 #41202?H\x16\xA8\x16\xA8\fl\xD4\x1Ex\x1E\xDCF\xB4F\xB4%\x80%\xE4C\xF8E\$)\x04)hB\xCCC0.\x18-\xB4D\xC0E\xEC2d2dD\xC0E\xEC5\xE85\.....EOF

For example, data for the first pixel is returned as “?H”, the second as “\x”, the third as “16” and so on. Using the first pixel data as an example, the high byte is “?” and the low byte as “H”. To convert this data into a pixel value, follow the steps below:

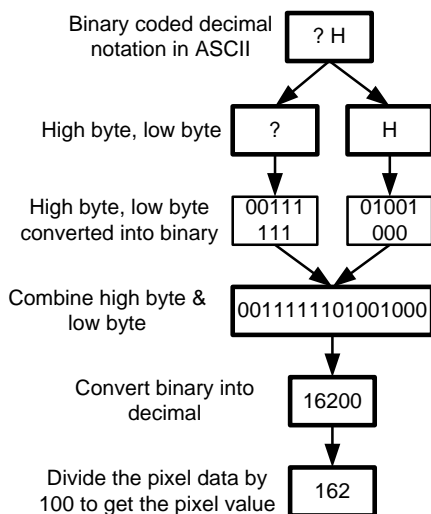

TRIGger Commands

:TRIGger[:SEquence]:DElay.....	245
:TRIGger[:SEquence]:DEMod:BIT:STARt.....	246
:TRIGger[:SEquence]:DEMod:BIT:STOP.....	246
:TRIGger[:SEquence]:DEMod:DElay.....	246
:TRIGger[:SEquence]:DEMod:EXTErnal:SLOPe.....	247
:TRIGger[:SEquence]:DEMod:INTErnal.....	247
:LEVel.....	247
:TRIGger[:SEquence]:DEMod:RF:VIDeo.....	248
:SLOPe.....	248
:TRIGger[:SEquence]:DEMod:VIDeo:LEVel.....	248
:TRIGger[:SEquence]:DEMod:MODE.....	249
:TRIGger[:SEquence]:DEMod:VIDeo:SLOPe.....	249
:TRIGger[:SEquence]:DEMod:SOURce.....	249
:TRIGger[:SEquence]:DEMod:TIME:STARt.....	250
:TRIGger[:SEquence]:DEMod:TIME:STOP.....	250
:TRIGger[:SEquence]:EXTErnal:SLOPe.....	250
:TRIGger[:SEquence]:IQ:DElay.....	251
:TRIGger[:SEquence]:IQ:MODE.....	251
:TRIGger[:SEquence]:IQ:SOURce.....	251
:TRIGger[:SEquence]:IQ:VIDeo.....	252
:LEVel.....	252
:TRIGger[:SEquence]:IQ:VIDeo.....	252
:SLOPe.....	252
:TRIGger[:SEquence]:MODE.....	252
:TRIGger[:SEquence]:PMETer:SOURce.....	253
:TRIGger[:SEquence]:SOURce.....	253
:TRIGger[:SEquence]:VIDeo:FREQuency.....	253
:TRIGger[:SEquence]:VIDeo:LEVel.....	254
:TRIGger[:SEquence]:VIDeo:SLOPe.....	254

:TRIGger[:SEquence]:DElay



Description	Sets the trigger delay time in seconds.
Syntax	:TRIGger[:SEquence]:DElay <time>
Query Syntax	:TRIGger[:SEquence]:DElay?

Parameter/ Return parameter	<code><time></code>	Delay time in seconds
--------------------------------	---------------------------	-----------------------

Example :TRIG:DEL 1.0e-2

Set →
 → Query

Description	Sets or queries the start bit position for the ASK / FSK analysis function.
-------------	---

Syntax :TRIGger[:SEQuence]:DEMod:BIT:STARt <integer>

Query Syntax :TRIGger[:SEQuence]:DEMod:BIT:STARt?

Parameter/ Return parameter	<code><integer></code>	<code><NR1> 0~400</code>
--------------------------------	------------------------------	--------------------------------

Example :TRIG:DEM:BIT:STAR?
 >16

Set →
 → Query

Description	Sets or queries the stop bit position for the ASK / FSK analysis function.
-------------	--

Syntax :TRIGger[:SEQuence]:DEMod:BIT:STOP <integer>

Query Syntax :TRIGger[:SEQuence]:DEMod:BIT:STOP?

Parameter/ Return parameter	<code><integer></code>	<code><NR1> 0~400</code>
--------------------------------	------------------------------	--------------------------------

Example :TRIG:DEM:BIT:STOP?
 >32



Set →
 → Query

Description	Sets the AF trigger delay time in seconds for AM/FM/ASK/FSK demodulation.
-------------	---

Syntax :TRIGger[:SEQuence]:DEMod:DELay <time>

Query Syntax :TRIGger[:SEQuence]:DEMod:DELay?



Parameter/ Return parameter	<time>	Delay time in seconds
Example	:TRIG:DEM:DEL 1.0 ms	

:TRIGger[:SEQuence]:DEMod:EXTernal 
 :SLOPe 

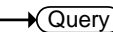
Description	Sets or queries the external source slope for ASK/FSK demodulation.	
Syntax	:TRIGger[:SEQuence]:DEMod:EXTernal:SLOPe {POSitive NEGative}	
Query Syntax	:TRIGger[:SEQuence]:DEMod:EXTernal:SLOPe?	
Parameter	POSitive NEGative	Postive slope Negative slope
Return parameter	POSITIVE NEGATIVE	Postive slope Negative slope
Example	:TRIG:DEM:EXT:SLOP?	

:TRIGger[:SEQuence]:DEMod:INTernal 
 :LEVel 

Description	Sets the internal trigger level for ASK/FSK demodulation.	
Syntax	:TRIGger[:SEQuence]:DEMod:INTernal:LEVel <NRf>	
Query Syntax	:TRIGger[:SEQuence]:DEMod:INTernal:LEVel?	
Parameter	<NRf>	Unit = dBm
Return parameter	<NR3>	
Example	:TRIG:DEM:INT:LEV 10	

:TRIGger[:SEQuence]:DEMod:RF:VIDeo 
 :SLOPe 

Description	Sets or queries the RF Video trigger slope for ASK/FSK demodulation.	
Syntax	:TRIGger[:SEQuence]:DEMod:RF:VIDeo:SLOPe {OFF POSitive NEGative}	
Query Syntax	:TRIGger[:SEQuence]:DEMod:RF:VIDeo:SLOPe?	
Parameter	OFF	The Video trigger edge is not used.
	POSitive	Sets the trigger on a positive slope.
	NEGative	Sets the trigger on a negative slope.
Return parameter	OFF	The Video trigger edge is not used.
	POSitive	The trigger is set on a positive slope.
	NEGative	The trigger is set on a negative slope.
Example	:TRIG:DEM:RF:VID:SLOP? >OFF	

:TRIGger[:SEQuence]:DEMod:VIDeo:LEVel 

Description	Sets the video trigger level for AM/FM demodulation.	
Syntax	:TRIGger[:SEQuence]:DEMod:VIDeo:LEVel <NRf>	
Query Syntax	:TRIGger[:SEQuence]:DEMod:VIDeo:LEVel?	
Parameter	<NRf>	AM unit =% FM unit = Hz
Return parameter	<NR3>	
Example	:TRIG:DEM:VID:LEV 10	

:TRIGger[:SEQuence]:DEMod:MODE (Set) →
→ (Query)

Description	Sets the triggering mode for the AF Trigger in AM/FM/ASK/FSK demodulation.	
Syntax	:TRIGger[:SEQuence]:DEMod:MODE {NORMAl SINGle CONTInuous}	
Query Syntax	:TRIGger[:SEQuence]:DEMod:MODE?	
Parameter/ Return parameter	NORMAl	Normal trigger mode
	SINGle	Single trigger
	CONTInuous	Continuous trigger
Example	:TRIG:DEM:MODE CONT	

:TRIGger[:SEQuence]:DEMod:VIDeo:SLOPe (Set) →
→ (Query)

Description	Sets the trigger slope for the AF Trigger in AM/FM demodulation.	
Syntax	:TRIGger[:SEQuence]:DEMod:VIDeo:SLOPe {POSitive NEGative}	
Query Syntax	:TRIGger[:SEQuence]:DEMod:VIDeo:SLOPe?	
Parameter/ Return parameter	POSitive	Positive slope
	NEGative	Negative slope
Example	:TRIG:DEM:VID:SLOP POS	

:TRIGger[:SEQuence]:DEMod:SOURce (Set) →

Description	Sets the triggering source for AM/FM/ASK/FSK demodulation	
Syntax	:TRIGger[:SEQuence]:DEMod:SOURce {IMMediate VIDeo EXTernal INTernal }	
Parameter	IMMediate	Free run trigger
	VIDeo	Trigger on the video signal level
	EXTernal	External trigger source (ASK/FSK only)
	INTernal	Internal trigger source (ASK/FSK only)

Example :TRIG:DEM:SOUR IMM

:TRIGger[:SEQuence]:DEMod:TIME:STARt (Set) →
→ (Query)

Description Sets the trigger start time of the AF trigger for the AM/FM demodulation function.

Syntax :TRIGger[:SEQuence]:DEMod:TIME:STARt <NRf>

Query Syntax :TRIGger[:SEQuence]:DEMod:TIME:STARt?

Parameter/ Return parameter <NRf> Time value in seconds

Example :TRIG:DEM:TIME:STAR 2.000e-2

:TRIGger[:SEQuence]:DEMod:TIME:STOP (Set) →
→ (Query)

Description Sets the trigger stop time of the AF trigger for the AM/FM demodulation function.

Syntax :TRIGger[:SEQuence]:DEMod:TIME:STOP <NRf>

Query Syntax :TRIGger[:SEQuence]:DEMod:TIME:STOP?

Parameter/ Return parameter <NRf> Time value in seconds

Example :TRIG:DEM:TIME:STOP 4.000e-2

:TRIGger[:SEQuence]:EXTernal:SLOPe (Set) →
→ (Query)

Description Sets the external trigger slope

Syntax :TRIGger[:SEQuence]:EXTernal:SLOPe {POSitive|NEGative}

Query Syntax :TRIGger[:SEQuence]:EXTernal:SLOPe?

Parameter/ Return parameter POSitive Positive slope
 NEGative Negative slope

Example :TRIG:EXT:SLOP POS

:TRIGger[:SEQuence]:IQ:DELAy (Set) →
→ (Query)

Description	Sets the AF trigger delay time in seconds for IQ analysis function.	
Syntax	:TRIGger[:SEQuence]:IQ:DELAy <time>	
Query Syntax	:TRIGger[:SEQuence]:IQ:DELAy?	
Parameter/ Return parameter	<time>	Delay time in seconds
Example	:TRIG:IQ:DEL 1.0 ms	

:TRIGger[:SEQuence]:IQ:MODE (Set) →
→ (Query)

Description	Sets the triggering mode for for IQ analysis function.	
Syntax	:TRIGger[:SEQuence]:IQ:MODE {NORMAl SINGle CONTInuous}	
Query Syntax	:TRIGger[:SEQuence]:IQ:MODE?	
Parameter/ Return parameter	NORMAl	Normal trigger mode
	SINGle	Single trigger
	CONTInuous	Continuous trigger
Example	:TRIG:IQ:MODE SINGLE	

:TRIGger[:SEQuence]:IQ:SOURce (Set) →

Description	Sets the triggering source for IQ analysis function.	
Syntax	:TRIGger[:SEQuence]:IQ:SOURce {IMMEdiate INTernal }	
Parameter	IMMEdiate	Free run trigger
	INTernal	Internal trigger source
Example	:TRIG:IQ:SOUR IMM	

:TRIGger[:SEQuence]:IQ:VIDeo (Set) →
 :LEVel → (Query)

Description	Sets the internal trigger level for IQ analysis function.	
Syntax	:TRIGger[:SEQuence]:IQ:VIDeo:LEVel <NRf>	
Query Syntax	:TRIGger[:SEQuence]:IQ:VIDeo:LEVel?	
Parameter	<NRf>	Unit = dBm
Return parameter	<NR3>	
Example	:TRIG:IQ:VID:LEV 10	

:TRIGger[:SEQuence]:IQ:VIDeo (Set) →
 :SLOPe → (Query)

Description	Sets or queries the RF Video trigger slope for IQ analysis function.	
Syntax	:TRIGger[:SEQuence]:IQ:VIDeo:VIDeo:SLOPe {OFF POSitive NEGative}	
Query Syntax	:TRIGger[:SEQuence]:IQ:VIDeo:VIDeo:SLOPe?	
Parameter	OFF	The Video trigger edge is not used.
	POSitive	Sets the trigger on a positive slope.
	NEGative	Sets the trigger on a negative slope.
Return parameter	OFF	The Video trigger edge is not used.
	POSitive	The trigger is set on a positive slope.
	NEGative	The trigger is set on a negative slope.
Example	:TRIG:IQ:VID:SLOP? >OFF	

:TRIGger[:SEQuence]:MODE (Set) →
→ (Query)

Description	Sets the triggering mode.	
-------------	---------------------------	--

Syntax :TRIGger[:SEQuence]:MODE
{NORMAl|SINGle|CONTInuous}

Query Syntax :TRIGger[:SEQuence]:MODE?

Parameter/	NORMAl	Normal trigger mode
Return parameter	SINGle	Single trigger
	CONTInuous	Continuous trigger

Example :TRIG:MODE CONT

:TRIGger[:SEQuence]:PMETer:SOURce  

Description Sets the triggering source to immediate or external

Syntax :TRIGger[:SEQuence]:PMETer:SOURce
{IMMEdiate|EXTernal}

Query Syntax :TRIGger[:SEQuence]:PMETer:SOURce?

Parameter/	IMMEdiate	Free run trigger
Return parameter	EXTernal	External trigger

Example :TRIG:PMET:SOUR IMM

:TRIGger[:SEQuence]:SOURce  

Description Sets the triggering source to immediate, external or video.

Syntax :TRIGger[:SEQuence]:SOURce
{IMMEdiate|EXTernal|VIDeo}

Query Syntax :TRIGger[:SEQuence]:SOURce?

Parameter/	IMMEdiate	Free run trigger
Return parameter	EXTernal	External trigger
	VIDeo	Video trigger

Example :TRIG:SOUR IMM

:TRIGger[:SEQuence]:VIDeo:FREQuency  

Description Sets the video trigger frequency.

Syntax	:TRIGger[:SEQuence]:VIDeo:FREQuency <freq>	
Query Syntax	:TRIGger[:SEQuence]:VIDeo:FREQuency?	
Parameter	<freq>	<NRf>
Return parameter	<NR3>	Hz
Example	:TRIG:VID:FREQ? >2.5e+6	

Set →
 → Query

:TRIGger[:SEQuence]:VIDeo:LEVel

Description	Sets the video trigger level.	
Syntax	:TRIGger[:SEQuence]:VIDeo:LEVel <ampl>	
Query Syntax	:TRIGger[:SEQuence]:VIDeo:LEVel?	
Parameter	<ampl>	<NRf> power or voltage.
Return parameter	<NR3>	
Example	:TRIG:VID:LEV 10	

Set →
 → Query

:TRIGger[:SEQuence]:VIDeo:SLOPe

Description	Sets the video trigger slope	
Syntax	:TRIGger[:SEQuence]:VIDeo:SLOPe {POSitive NEGative}	
Query Syntax	:TRIGger[:SEQuence]:VIDeo:SLOPe?	
Parameter/ Return parameter	POSitive	Positive slope
	NEGative	Negative slope
Example	:TRIG:VID:SLOP POS	

UNIT Commands

:UNIT:PMETer:POWer.....	255
:UNIT:POWer.....	255

:UNIT:PMETer:POWer (Set) →
→ (Query)

Description Sets the amplitude unit used for the Power Meter mode.

Syntax :UNIT:PMETer:POWer {DBM|MW}

Query Syntax :UNIT:PMETer:POWer?

Parameter/	DBM	Decibels
Return parameter	MW	Milliwatts

Example :UNIT:PMET:POW DBM

:UNIT:POWer (Set) →
→ (Query)

Description Sets the amplitude unit used for the Spectrum mode.

Syntax :UNIT:POWer {DBM|DBMV|DBUV|W|V}

Query Syntax :UNIT:POWer?

Parameter/	DBM	Decibels
Return parameter	DBMV	decibels relative to one millivolt
	DBUV	decibels relative to one microvolt
	W	Watt
	V	Volt

Example :UNIT:POW DBM

APPENDIX

ASCII to Binary Coded Decimal Table

Background

The :PIXel query uses binary coded decimal notation when returning the value of each pixel that is displayed. See page 243 for details.

Decimal	Binary	ASCII	Decimal	Binary	ASCII
0	00000000	NUL	64	01000000	@
1	00000001	SOH	65	01000001	A
2	00000010	STX	66	01000010	B
3	00000011	ETX	67	01000011	C
4	00000100	EOT	68	01000100	D
5	00000101	ENQ	69	01000101	E
6	00000110	ACK	70	01000110	F
7	00000111	BEL	71	01000111	G
8	00001000	BS	72	01001000	H
9	00001001	HT	73	01001001	I
10	00001010	LF	74	01001010	J
11	00001011	VT	75	01001011	K
12	00001100	FF	76	01001100	L
13	00001101	CR	77	01001101	M
14	00001110	SO	78	01001110	N
15	00001111	SI	79	01001111	O
16	00010000	DLE	80	01010000	P
17	00010001	DC1	81	01010001	Q
18	00010010	DC2	82	01010010	R
19	00010011	DC3	83	01010011	S
20	00010100	DC4	84	01010100	T
21	00010101	NAK	85	01010101	U
22	00010110	SYN	86	01010110	V

23	00010111	ETB	87	01010111	W
24	00011000	CAN	88	01011000	X
25	00011001	EM	89	01011001	Y
26	00011010	SUB	90	01011010	Z
27	00011011	ESC	91	01011011	[
28	00011100	FS	92	01011100	\
29	00011101	GS	93	01011101]
30	00011110	RS	94	01011110	^
31	00011111	US	95	01011111	_
32	00100000	Space	96	01100000	`
33	00100001	!	97	01100001	a
34	00100010	"	98	01100010	b
35	00100011	#	99	01100011	c
36	00100100	\$	100	01100100	d
37	00100101	%	101	01100101	e
38	00100110	&	102	01100110	f
39	00100111	'	103	01100111	g
40	00101000	(104	01101000	h
41	00101001)	105	01101001	i
42	00101010	*	106	01101010	j
43	00101011	+	107	01101011	k
44	00101100	,	108	01101100	l
45	00101101	-	109	01101101	m
46	00101110	.	110	01101110	n
47	00101111	/	111	01101111	o
48	00110000	0	112	01110000	p
49	00110001	1	113	01110001	q
50	00110010	2	114	01110010	r
51	00110011	3	115	01110011	s
52	00110100	4	116	01110100	t
53	00110101	5	117	01110101	u
54	00110110	6	118	01110110	v
55	00110111	7	119	01110111	w
56	00111000	8	120	01111000	x
57	00111001	9	121	01111001	y
58	00111010	:	122	01111010	z
59	00111011	;	123	01111011	{
60	00111100	<	124	01111100	

61	00111101	=	125	01111101	}
62	00111110	>	126	01111110	~
63	00111111	?	127	01111111	DEL