

# Multi-Range DC Power Supply

PFR-100 Series

---

## PROGRAMMING MANUAL



ISO-9001 CERTIFIED MANUFACTURER

**GW INSTEK**

This manual contains proprietary information, which is protected by copyright. All rights are reserved. No part of this manual may be photocopied, reproduced or translated to another language without prior written consent of Good Will company.

The information in this manual was correct at the time of printing. However, Good Will continues to improve products and reserves the rights to change specification, equipment, and maintenance procedures at any time without notice.

**Good Will Instrument Co., Ltd.**  
**No. 7-1, Jhongsing Rd., Tucheng Dist., New Taipei City 236, Taiwan.**

# Table of Contents

<b>SAFETY INSTRUCTIONS</b> .....	<b>4</b>
<b>GETTING STARTED</b> .....	<b>8</b>
PFR-100 Series Overview .....	9
Appearance .....	12
Configuration Settings .....	19
<b>REMOTE CONTROL</b> .....	<b>26</b>
Interface Configuration .....	28
Socket Server Examples .....	66
Command Syntax .....	70
Command List .....	73
Status Register Overview .....	125
Error List .....	138
<b>APPENDIX</b> .....	<b>146</b>
PFR-100 Default Settings .....	146
Error Messages & Messages .....	148
LED ASCII Table Character Set .....	149
<b>INDEX</b> .....	<b>150</b>

# S SAFETY INSTRUCTIONS

This chapter contains important safety instructions that you must follow during operation and storage. Read the following before any operation to insure your safety and to keep the instrument in the best possible condition.

## Safety Symbols

These safety symbols may appear in this manual or on the instrument.

---



WARNING

Warning: Identifies conditions or practices that could result in injury or loss of life.



CAUTION

Caution: Identifies conditions or practices that could result in damage to the PFR-100 or to other properties.



DANGER High Voltage



Attention Refer to the Manual



Protective Conductor Terminal



Earth (ground) Terminal



Do not dispose electronic equipment as unsorted municipal waste. Please use a separate collection facility or contact the supplier from which this instrument was purchased.

## Safety Guidelines

---

### General Guideline



#### CAUTION

- Do not place any heavy object on the PFR-100.
- Avoid severe impact or rough handling that leads to damaging the PFR-100.
- Do not discharge static electricity to the PFR-100.
- Use only mating connectors, not bare wires, for the terminals.
- Do not disassemble the PFR-100 unless you are qualified.

### Power Supply



#### WARNING

- AC Input Voltage Rating : 100Vac-240Vac +/- 10%
- Frequency: 47Hz to 63Hz
- Do NOT replace the detachable MAINS supply cord by inadequately RATED cords.
- Suitable supply cord set shall use with the equipment:
  - Mains plug: Shall be national approval;
  - Mains connector: C13 type;
- Cable:
  - Length of power supply cord: less than 3 m;
  - Cross-section of conductors: at least 0.75 mm<sup>2</sup>;
- Cord type:
  - Shall meet the requirements of IEC 60227 or IEC 60245 (e.g.: H05VV-F, H05RN-F) or national approval.
- The power switch that is included in the instrument is not considered a disconnecting

---

device. The mains plug is used as the disconnecting device. Do NOT position the equipment so that it is difficult to disconnect the appliance inlet or power plug.

- To avoid electrical shock connect the protective grounding conductor of the AC power cord to an earth ground.
- 

Cleaning the PFR-100

- Disconnect the power cord before cleaning.
  - Use a soft cloth dampened in a solution of mild detergent and water. Do not spray any liquid.
  - Do not use chemicals containing harsh material such as benzene, toluene, xylene, and acetone.
- 

Operation Environment

- Location: Indoor, no direct sunlight, dust free, almost non-conductive pollution (Note below)
- Relative Humidity: 20%~ 80% (no condensation)
- Altitude: < 2000m
- Temperature: 0°C to 40°C
- Mains supply voltage fluctuations: +/-10 %
- Overvoltage category: OVC II
- If the equipment is used in a manner not specified by the manufacturer, the protection provided by the equipment may be impaired.
- LAN, RS232/RS485, USB, and GPIB ports are only to be connected to the circuits which are separated from mains supply by double / reinforce insulation.

(Pollution Degree) EN61010-1 specifies the pollution degrees and their requirements as follows. The PFR-100 falls under degree 2.

Pollution refers to “addition of foreign matter, solid, liquid, or gaseous (ionized gases), that may produce a reduction of dielectric strength or surface resistivity”.

- Pollution degree 1: No pollution or only dry, non-conductive pollution occurs. The pollution has no influence.
  - Pollution degree 2: Normally only non-conductive pollution occurs. Occasionally, however, a temporary conductivity caused
-

by condensation must be expected.

- Pollution degree 3: Conductive pollution occurs, or dry, non-conductive pollution occurs which becomes conductive due to condensation which is expected. In such conditions, equipment is normally protected against exposure to direct sunlight, precipitation, and full wind pressure, but neither temperature nor humidity is controlled.

---

Storage  
environment

- Location: Indoor
- Temperature: -20°C to 70°C
- Relative Humidity: 20 to 85% (no condensation)

---

Disposal



Do not dispose this instrument as unsorted municipal waste. Please use a separate collection facility or contact the supplier from which this instrument was purchased. Please make sure discarded electrical waste is properly recycled to reduce environmental impact.

# G E T T I N G   S T A R T E D

This chapter describes the power supply in a nutshell, including its main features and front / rear panel introduction. After going through the overview, please read the theory of operation to become familiar with the operating modes, protection modes and other safety considerations.

---

<b>PFR-100 Series Overview</b> .....	<b>9</b>
Series lineup .....	9
Main Features .....	9
Accessories .....	10
<b>Appearance</b> .....	<b>12</b>
Front Panel.....	12
Display Area.....	15
Rear Panel.....	17
<b>Configuration Settings</b> .....	<b>19</b>
Setting Normal Function Settings.....	19
Setting Power On Configuration Settings .....	21
Configuration Table.....	22



## PFR-100 Series Overview

### Series lineup

The PFR-100 series consists of 2 models, covering a number of different current, voltage and power capacities:

Model name	Operation Voltage	Operation Current	Rated Power
PFR-100L	0-50V	0-10A	100W
PFR-100M	0-250V	0-2A	100W

### Main Features

- |             |  |
|-------------|--|
| Performance | <ul style="list-style-type: none"> <li>• Variable voltage and current combinations with 5 times of coverage ratio of its range within the rated power.</li> <li>• Constant voltage/constant current with automatic crossover.</li> <li>• Active Power Factor correction.</li> <li>• Universal Input Voltage 85 - 265Vac, continuous operation.</li> <li>• Natural convection cooling.</li> </ul> |
|-------------|--|

- |          |   |
|----------|---|
| Features | <ul style="list-style-type: none"> <li>• Preset memory function.</li> <li>• Output ON/OFF delay function.</li> <li>• CV, CC priority start function. (prevents overshoot with output ON)</li> <li>• Adjustable voltage and current slew rates.</li> <li>• Bleeder circuit ON/OFF setting. (to prevent over-discharging of batteries)</li> <li>• OVP, OCP, AC FAIL, OPP and OTP protection.</li> <li>• Supports test scripts.</li> </ul> |
|----------|---|

- Web server monitoring and control. (The function is activated when connecting to LAN Interface)
- Analog monitor output.
- Remote sensing to compensate for voltage drop in load leads.
- Built-in front panel and rear panel output terminal.

Interface

- Built-in USB, RS232/485 and LAN interface.
- External analog control function.
- Optional GPIB interface.

### Accessories

Before using the PFR-100 power supply unit, check the package contents to make sure all the standard accessories are included.

Standard Accessories	Part number	Description	Qty.
	CD-ROM	User manual, Programming manual	1
		Power Cord	1
	GTL-134	Test leads for rear panel, 1.2m, 10A, 16AWG	1
	PFR-001	Binding Posts Terminal Accessory Kit (Output terminal cover × 1, Socket × 1, Protection Cover × 2, Short Bar × 1)	1
	GTL-104A	Test leads for PFR-100L (Binding Posts Terminal), 1m, 10A	1
	PFR-002	European Type Jack Terminal Accessory Kit (Output terminal cover × 1, Socket × 1, Protection Cover × 2, Short Wire × 1)	1
	GTL-105A	Test leads for PFR-100M, 1m, 3A	1
	GTL-204A	Test leads for PFR-100L (European Type Jack Terminal), 1m, 10A	1

Optional Accessories	Part number	Description
	GRA-431-J-100	Rack mount adapter (JIS) with AC 100V
	GRA-431-J-200	Rack mount adapter (JIS) with AC 200V
	GRA-431-E-100	Rack mount adapter (EIA) with AC 100V
	GRA-431-E-200	Rack mount adapter (EIA) with AC 200V
	GTL-258	GPIB Cable, 2000mm
	PSU-232	RS-232 Cable with DB9 Connector Kit. It includes RS-232 cable with DB9 connector, RS-485 used master cable (gray plug), slave cable (black plug) and end plug terminal.
	PSU-485	RS-485 Cable with DB9 Connector Kit. It includes RS-485 cable with DB9 connector, RS-485 used master cable (gray plug), slave cable (black plug) and end plug terminal.
	GTL-246	USB Cable (USB 2.0 Type A- Type B Cable, 4P)
Factory Installed Options	Part number	Description
	PFR-GPIB	GPIB interface

# Appearance

## Front Panel

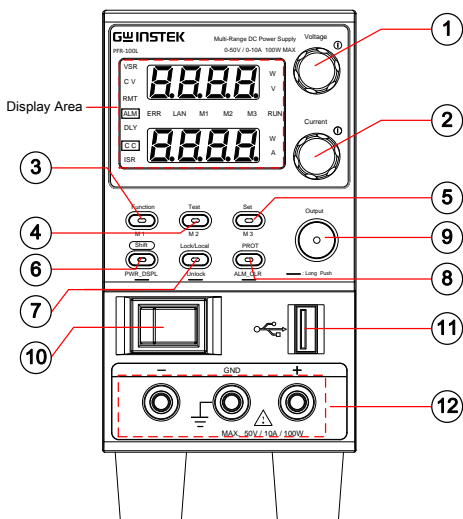

**Display Area** The display area shows setting values, output values and parameter settings. The function LEDs below show the current status and mode of the power supply. See page 15 for details.

1. Voltage Knob

Voltage

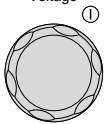





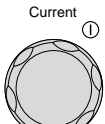



Used to set the voltage value or select a parameter number in the Function settings.
  
2. Current Knob

Current



Used to set the current value or change the value of a Function parameter.

- |    |                   |  |   |
|----|-------------------|--|---|
| 3. | Function Button   | <br>Function<br>M1  | Used to configure the various functions.<br><br>(+Shift) Used to recall the M1 setup.<br>(+Shift and hold) Used to save the current setup to M1.  |
|    | M1 Button         |  |   |
| 4. | Test Button       | <br>TEST<br>M2  | Used to run customized scripts for testing.<br><br>(+Shift) Used to recall the M2 setup.<br>(+Shift and hold) Used to save the current setup to M2.   |
|    | M2 Button         |  |   |
| 5. | Set Button        | <br>SET<br>M3   | Used to set and confirm the output voltage and output current.<br><br>(+Shift) Used to recall the M3 setup.<br>(+Shift and hold) Used to save the current setup to M3.  |
|    | M3 Button         |  |   |
| 6. | Shift Button      | <br><br>PWR_DSPL                 | Used to enable the functions that are written in blue characters below certain buttons.<br><br>(Long push) Displays the output power on the voltage meter or current meter. Press the Voltage knob for V/W, Press the Current knob for A/W. |
|    | PWR_DSPL          |  |   |
| 7. | Lock/Local Button | <br>Lock/Local<br>Unlock<br> | Used to lock all front panel buttons other than the Output Button or it switches to local mode.<br><br>(Long push) Used to unlock the front panel buttons.  |
|    | Unlock Button     |  |   |

8. PROT Button  Used to set and display OVP, OCP and UVL.

ALM\_CLR Button  (Long push) Used to release protection functions that have been activated.

9. Output Button  Used to turn the output on or off.

10. Power Switch  Used to turn the power on/off.

11. USB A Port  USB A port for data transfer, loading test scripts etc.

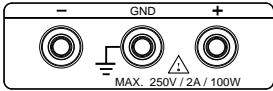
12 Output terminal  DC output terminal for PFR-100M is European Type Jack Terminal.  
The max. output is 250V/2A/100W

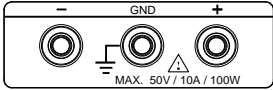
 DC output terminal for PFR-100L is Binding Posts Terminal or European Type Jack Terminal.  
The max. output is 50V/10A/100W

## Display Area

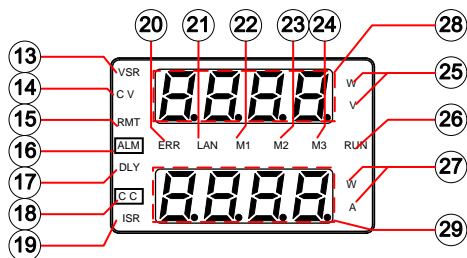

- |             |  |
|-------------|--|
| 13. VSR LED | Lights up when CV Slew Rate Priority is enabled.                   |
| 14. CV LED  | Lights in green during constant voltage mode.                      |
| 15. RMT LED | Lights in green during remote control.                             |
| 16. ALM LED | Lights in red when a protection function has been activated.       |
| 17. DLY LED | The Output On/Off Delay indicator LED.                             |
| 18. CC LED  | Lights in green during constant current mode.                      |
| 19. ISR LED | Lights up when CC Slew Rate Priority is enabled.                   |
| 20. ERR LED | Lights in red when an error has occurred.                          |
| 21. LAN LED | Lights up when the LAN remote connection is established.           |
| 22. M1 LED  | Lights in green when the memory value are being recalled or saved. |

- |                   |   |
|-------------------|---|
| 23. M2 LED        | Lights in green when the memory value are being recalled or saved.    |
| 24. M3 LED        | Lights in green when the memory value are being recalled or saved.    |
| 25. V or W LED    | Display Voltage or Watt unit.   |
| 26. RUN LED       | Lights up when a Test Script has been activated.                      |
| 27. A or W LED    | Display Current or Watt unit.   |
| 28. Voltage Meter | Displays the voltage or the parameter number of a Function parameter. |
| 29. Current Meter | Displays the current or the value of a Function parameter.            |



Rear Panel

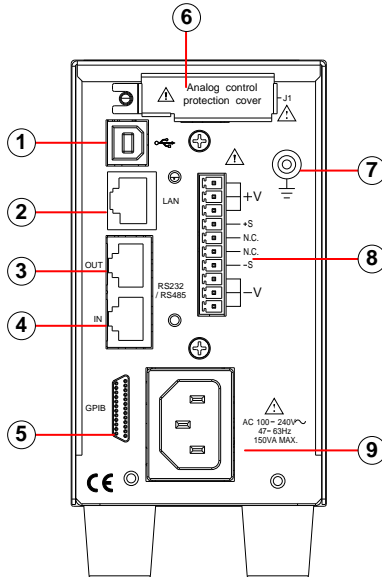

- 1. USB                    USB port for controlling the PFR-100 remotely.
- 2. LAN                    Ethernet port for controlling the PFR-100 remotely.



Note

For the device produced after April 2022, the LAN interface will be changed to a standard interface. But the status of the actual supplied products needs to be confirmed by contacting the business windows of each district.

- 3. Remote-OUT    RJ-45 connector that is used to daisy chain power supplies with the Remote-IN port to form a communication bus.

4. Remote-IN Two different types of cables can be used for RS232 or RS485-based remote control.  
PSU-232: RS232 cable with DB9 connector kit.  
PSU-485: RS485 cable with DB9 connector kit.
5. GPIB GPIB connector for units equipped with IEEE programming option. (Factory Installed Options)
6. J1 External analog remote control connector.
7. Ground Screw Connectors for grounding the output.
8. Output Terminals It uses a 10 pin connector and a plug for the output and sense terminal connections. If operation current is over 8A, please use two or three port and wire to balance the current flow.
9. Line Voltage Input AC inlet.

## Configuration Settings

### Setting Normal Function Settings

The Normal Function settings, F-01~F-61, F-71~F-78 and F-88~F-89 can be easily configured with the Function key.

- Ensure the load is not connected.
- Ensure the output is off.
- Function settings F-90~94 can only be viewed.



Note

Function setting F-89 (Show Version) can only be viewed, not edited.

Configuration settings F-90~ F-94 cannot be edited in the Normal Function settings. Use the Power On Configuration settings. See page 19 for details.

Steps

1. Press the Function key. The function key will light up.

Function



2. The display will show F-01 on the top and the configuration setting for F-01 on the bottom.

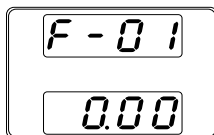

3. Rotate the Voltage knob to change the F setting.

Range F-00~F-61, F-70~F-78,  
F-88~F-94

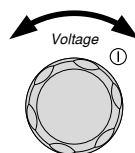

- 4. Use the Current knob to set the parameter for the chosen F setting.

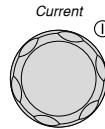

Press the Voltage knob to save the configuration setting. ConF will be displayed when it is configuring.

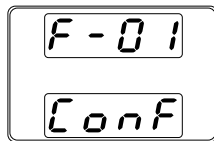
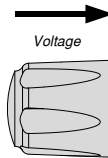

Exit

Press the Function key again to exit the configuration settings. The Function key light will turn off.



## Setting Power On Configuration Settings

**Background** The Power On configuration settings can only be changed during power up to prevent the configuration settings being inadvertently changed.

- Ensure the load is not connected.
- Ensure the power supply is off.

**Steps** 1. Hold the Function key whilst turning the power on.

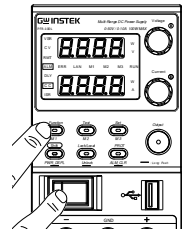

2. The display will show F-90 on the top and the configuration setting for F-90 on the bottom.

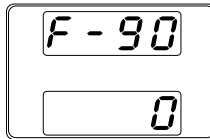

3. Rotate the Voltage knob to change the F setting.

Range F-90~ F-94

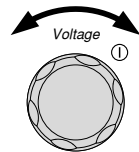

4. Use the Current knob to set the parameter for the chosen F setting.

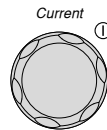

- Press the Voltage knob to save the configuration setting. ConF will be displayed when successful.

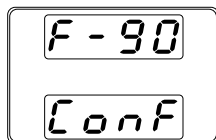
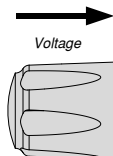

Exit                      Cycle the power to save and exit the configuration settings.

### Configuration Table

Please use the configuration settings listed below when applying the configuration settings.

Normal Function Settings	Setting	Setting Range
Output ON delay time	F-01	0.00s~99.99s
Output OFF delay time	F-02	0.00s~99.99s
V-I mode slew rate select	F-03	0 = CV high speed priority (CVHS) 1 = CC high speed priority (CCHS) 2 = CV slew rate priority (CVLS) 3 = CC slew rate priority (CVLS)
Rising voltage slew rate	F-04	0.1V/s ~ 100.0V/s (PFR-100L) 0.1V/s ~ 500.0V/s (PFR-100M)
Falling voltage slew rate	F-05	0.1V/s ~ 100.0V/s (PFR-100L) 0.1V/s ~ 500.0V/s (PFR-100M)
Rising current slew rate	F-06	0.01A/s ~ 20.00A/s (PFR-100L) 0.001A/s ~ 4.000A/s (PFR-100M)
Falling current slew rate	F-07	0.01A/s ~ 20.00A/s (PFR-100L) 0.001A/s ~ 4.000A/s (PFR-100M)
Bleeder circuit control	F-09	0 = OFF, 1 = ON, 2 = AUTO
Buzzer ON/OFF control	F-10	0 = OFF, 1 = ON
Detection Time of OCP	F-12	0.0 ~ 2.0 sec

Current Setting Limit (I-Limit)	F-13	0 = OFF (The limit function of current setting is disabled.) 1 = ON (The limit function of current setting is enabled.)
Voltage Setting Limit (V-Limit)	F-14	0 = OFF (The limit function of voltage setting is disabled.) 1 = ON (The limit function of voltage setting is enabled.)
Memory Recall Display	F-15	0 = OFF, 1 = ON
Measurement Average Setting	F-17	0 = Low, 1 = Middle, 2 = High
Lock Mode	F-19	0:Lock Panel, Allow Output OFF 1:Lock Panel, Allow Output ON/OFF
<b>USB/GPIB Settings</b>		
Front panel USB status	F-20	0 = None, 1 = Mass Storage
Rear panel USB status	F-21	0 = None, 1 = Linking to PC
GPIB Address	F-23	0 ~ 30
Show GPIB available status	F-25	0 = No GPIB, 1 = GPIB is available
Interface Select	F-29	0 = Disable, 1 = RS232, 2 = RS485, 3 = USB-CDC / NO Mass Storage, 4 = GPIB, 5 = LAN SOCKET, 6 = LAN WEB
<b>LAN Settings</b>		
MAC Address-1	F-30	0x00~0xFF
MAC Address-2	F-31	0x00~0xFF
MAC Address-3	F-32	0x00~0xFF
MAC Address-4	F-33	0x00~0xFF
MAC Address-5	F-34	0x00~0xFF
MAC Address-6	F-35	0x00~0xFF
DHCP	F-37	0 = OFF, 1 = ON
IP Address-1	F-39	0~255
IP Address-2	F-40	0~255
IP Address-3	F-41	0~255
IP Address-4	F-42	0~255
Subnet Mask-1	F-43	0~255
Subnet Mask-2	F-44	0~255
Subnet Mask-3	F-45	0~255
Subnet Mask-4	F-46	0~255

Gateway-1	F-47	0~255
Gateway-2	F-48	0~255
Gateway-3	F-49	0~255
Gateway-4	F-50	0~255
DNS address-1	F-51	0~255
DNS address-2	F-52	0~255
DNS address-3	F-53	0~255
DNS address-4	F-54	0~255
Web Password Enable/Disable	F-60	0 = Disable, 1 = Enable
Web Enter Password	F-61	0000~9999
<b>UART Settings</b>		
UART Baud Rate	F-71	0 = 1200, 1 = 2400, 2 = 4800, 3 = 9600, 4 = 19200, 5 = 38400, 6 = 57600, 7 = 115200
UART Data Bits	F-72	0 = 7 bits, 1 = 8 bits
UART Parity	F-73	0 = None, 1 = Odd, 2 = Even
UART Stop Bit	F-74	0 = 1 bit, 1 = 2 bits
UART TCP	F-75	0 = SCPI
UART Address	F-76	00 ~ 30
UART Multi-Drop control	F-77	0 = Disable, 1 = Master, 2 = Slave, 3 = Display information
UART Multi-Drop status	F-78	Displayed parameter: AA-S AA: 00~30 (Address), S: 0~1 (Off-line/On-line status).
<b>System Settings</b>		
Factory Default Configuration	F-88	0 = None 1 = Return to factory default settings
Show Version	F-89	0, 1 = Version 2, 3, 4, 5 = Build date (YYYYMMDD) 6, 7 = Keyboard CPLD Version 8, 9 = Analog-Control CPLD Version
<b>Power On Configuration Settings*</b>		
CV Control	F-90	0 = Panel control (local) 1 = External Voltage control 2 = External Resistance control- Rising ↙ 3 = External Resistance control- Falling ↘



CC Control	F-91	0 = Panel control (local) 1 = External Voltage control 2 = External Resistance control- Rising ↙ 3 = External Resistance control- Falling ↘
Power ON Output	F-92	0 = Safe Mode (Output OFF at startup) 1 = Force Mode (Output ON at startup) 2 = Auto Mode (Status before last time Power OFF)
External Output Logic Control	F-94	0 = High ON, 1 = Low ON, 2 = Disable
Special Function		
Special Function	F-00	0000 ~ 9999

# REMOTE CONTROL

This chapter describes basic configuration of IEEE488.2 based remote control.

---

Interface Configuration .....	28
USB Remote Interface .....	28
Configuration.....	28
USB CDC Function Check.....	29
GPIB Remote Interface.....	36
Configuration.....	36
GPIB Function Check .....	37
UART Remote Interface .....	41
Configure UART .....	41
UART Function Check.....	44
Multiple Unit Connection.....	45
Legacy Multi-Drop mode .....	45
Multi-Drop mode.....	50
Multiple units Function Check .....	53
Configure Ethernet Connection.....	57
Web Server Configuration.....	57
Web Server Remote Control Function Check.....	58
Sockets Server Configuration .....	60
Socket Server Function Check .....	61
Socket Server Examples .....	66
Visual Basic Example .....	66
C++ Example.....	67
LabVIEW Example .....	69
Command Syntax .....	70
Command List .....	73
Status Register Overview .....	125
Introduction to the Status Registers .....	125
The Status Registers.....	127
Questionable Status Register Group .....	128
Operation Status Register Group.....	132
Standard Event Status Register Group .....	134

Status Byte Register & Service Request Enable Register .....	136
<b>Error List .....</b>	<b>138</b>
Command Errors .....	138
Execution Errors.....	142
Device Specific Errors .....	144
Query Errors.....	145

# Interface Configuration

## USB Remote Interface



Note

When using the USB Remote Interface, The USB port on the front panel will become disabled and fail to be used.

## Configuration

USB Configuration	PC side connector	Type A, host
	PFR-100 side connector	Rear panel Type B, slave
	Speed	1.1 (full speed)
	USB Class	CDC (communications device class)

## Steps

1. Connect the USB cable to the rear panel USB B port.

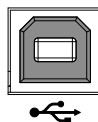

2. Set the Function setting F-29 (Interface port). F-29 = 3 (USB-CDC).

Page 8

3. Check to see that the USB is detected by PFR-100. The F-21 setting indicates the rear USB port

F-21 = 0 Indicates the rear USB port is not detected.

F-21 = 1 Indicates the rear USB port is available.

- The RMT indicator will turn on when a remote connection has been established.



RMT indicator

## USB CDC Function Check

---

**Background** To test the USB CDC functionality, National Instruments Measurement and Automation Explorer can be used. This program is available on the NI website, [www.ni.com](http://www.ni.com), via a search for the VISA Run-time Engine page, or “downloads” at the following URL, <http://www.ni.com/visa/>

**Requirements** Operating System: Windows XP, 7, 8,10

**Functionality check**

- In case of Window 7 64 bits, once the USB Cable was connected to PC correctly for a while (around 1 min). It may show below message at the lower right area of display.

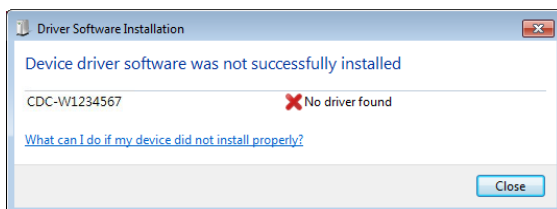

- Open the “Run” dialog box by pressing and holding the Windows key and then press the R key (“Run”).

3. Type devmgmt.msc and click “OK”.

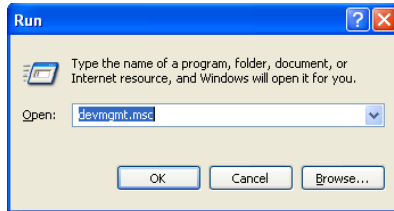

4. The Device Manager will show up CDC-WXXXXXX on “Other Devices”.

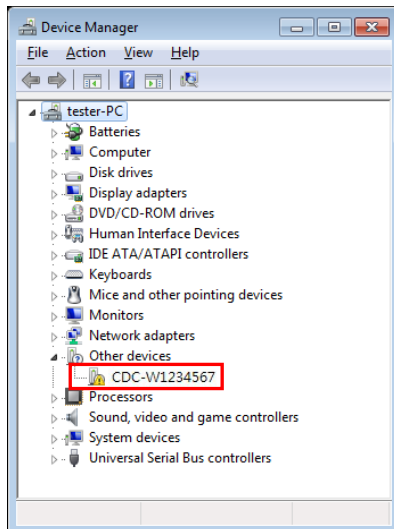

5. Select the CDC-WXXXXXX and click the right button of mouse to “Update Driver Software”.

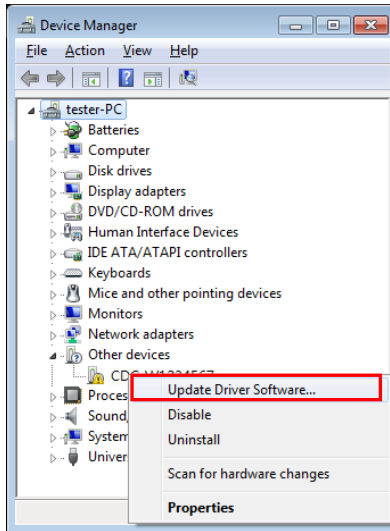

6. Select “Locate and install driver software manually.”

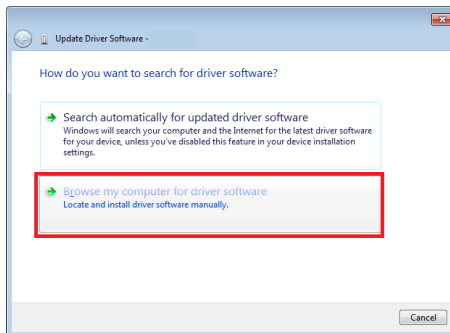

7. Indicate the driver folder to the system and then press “Next”.

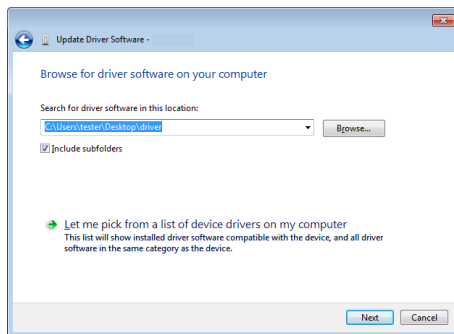

And this folder should consist of below 2 files.

 gw_pfr.cat	04/02/2016 13:32
 gw_pfr.inf	04/02/2016 13:31

---



Note

The USB driver of PFR-100 can be downloaded from download area of PFR-100 on the GW Instek website <http://www.gwinstek.com/en-global/Support/download>

---

8. Windows 7 will install the driver for a while.

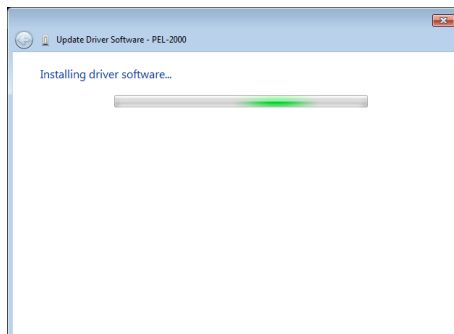



9. If everything works fine, you may get below message. And the COM53 is the USB CDC ACM port of PFR-100.

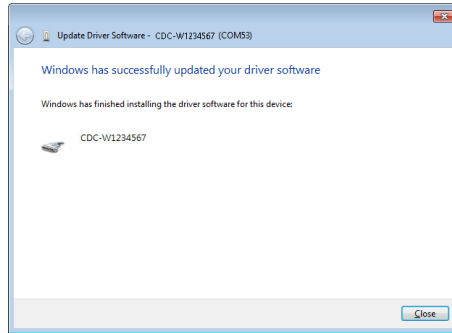

10. Double check the "Device Manager". The port should like below.

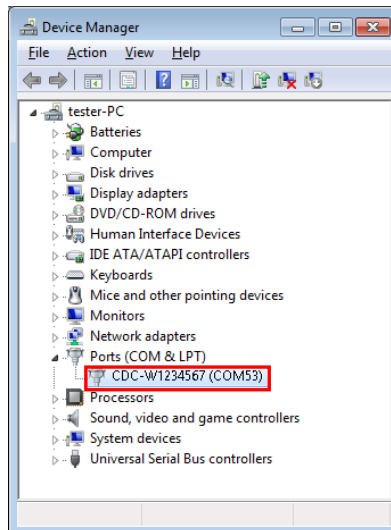

Steps 1~10 are for the USB CDC Driver installation.

11. Start the NI Measurement and Automation Explorer (MAX) program. Using Windows, press:  
*Start>All Programs>National Instruments>Measurement & Automation*



12. From the Configuration panel access;  
*My System>Devices and Interfaces>Network Devices*

13. Click Open VISA Test Panel.



14. Click the Configuration icon,
15. Click on I/O Settings.
16. Make sure the Enable Termination Character check box is checked, and the terminal character is \n (Value: xA).

17. Click Apply Changes.

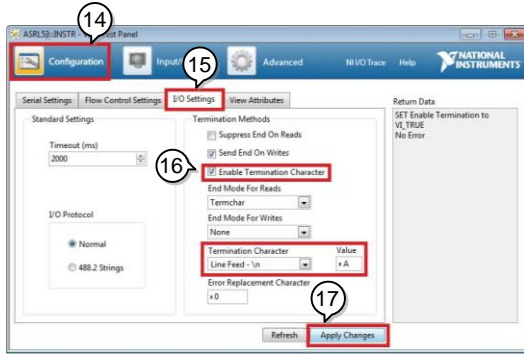

18. Click the Input/Output icon.

19. Enter \*IDN? in the Select or Enter Command dialog box if it is not already.

20. Click the Query button.

21. The \*IDN? query will return the Manufacturer, model name, serial number and firmware version in the dialog box.

GW-INSTEK,PFR-100L,TW1234567,01.01.12345678



## GPIB Remote Interface

### Configuration

To use GPIB, the optional GPIB option (GW Instek part number: PFR-GPIB) must be installed. This is a factory installed option and cannot be installed by the end-user. Only one GPIB address can be used at a time.

---

- Configure GPIB
1. Ensure the PFR-100 is off before proceeding.
  2. Connect the GPIB cable (GW Instek part number: GTL-258) from a GPIB controller to the GPIB port on the PFR-100.
  3. Turn the PFR-100 on.
  4. Press the Function key to enter the Page 8  
Normal configuration settings.
  5. Set the following GPIB settings.

F-29 = 4	Enable the GPIB port
F-23 = 0~30	Set the GPIB address (0~30)
  6. Check to see that the GPIB option is detected by the PFR-100. The F-25 setting indicates the GPIB port status.

F-25 = 0	Indicates that the GPIB port is not detected.
F-25 = 1	Indicates that the GPIB port is available.

- The RMT indicator will turn on when a remote connection has been established.



RMT indicator

- |                  |  |
|------------------|--|
| GPIB constraints | <ul style="list-style-type: none"> <li>• Maximum 15 devices altogether, 20m cable length, 2m between each device</li> <li>• Unique address assigned to each device</li> <li>• At least 2/3 of the devices turned On</li> <li>• No loop or parallel connection</li> </ul> |
|------------------|--|

### GPIB Function Check

---

Background	To test the GPIB functionality, National Instruments Measurement and Automation Explorer can be used. This program is available on the NI website, <a href="http://www.ni.com">www.ni.com</a> , via a search for the VISA Run-time Engine page, or “downloads” at the following URL, <a href="http://www.ni.com/visa/">http://www.ni.com/visa/</a>
------------	--

Requirements	Operating System: Windows XP, 7, 8
--------------	------------------------------------

Functionality check	<ol style="list-style-type: none"> <li>1. Start the NI Measurement and Automation Explorer (MAX) program. Using Windows, press:</li> </ol>
---------------------	--

*Start>All Programs>National Instruments>Measurement & Automation*



2. From the Configuration panel access;  
*My System>Devices and Interfaces>GPIB*
3. Press *Scan for Instruments*.

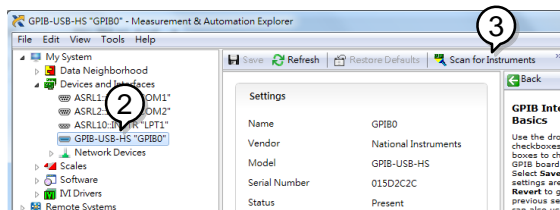

4. Select the device (GPIB address of PFR-100) that now appears in the *System>Devices and Interfaces > GPIB-USB-HS "GPIBX"* node.
5. Click on the *VISA Properties* tab on the bottom.
6. Click *Open Visa Test Panel*.

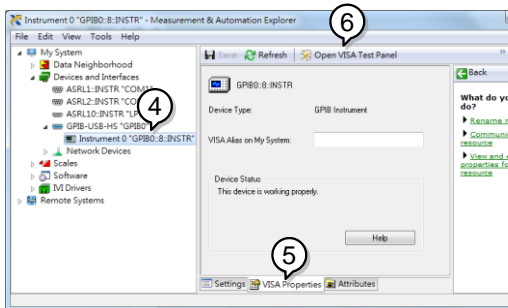

7. Click on *Configuration*.
8. Click on the *GPIB Settings* tab and confirm that the GPIB settings are correct.

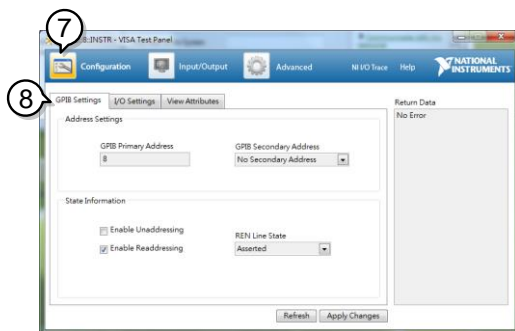

9. Click on the *I/O Settings* tab.
10. Make sure the *Enable Termination Character* check box is checked, and the terminal character is `\n` (Value: xA).
11. Click *Apply Changes*.

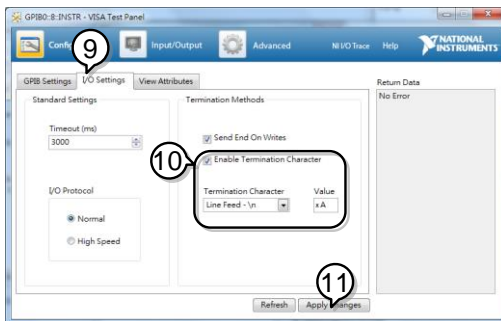

12. Click on *Input/Output*.

13. Click on the *Basic I/O* tab.

14. Enter *\*IDN?* in the *Select or Enter Command* drop down box.

15. Click *Query*.

16. The *\*IDN?* query will return the Manufacturer, model name, serial number and firmware version in the dialog box.

GW-INSTEK,PFR-100L,TW1234567,01.01.12345678

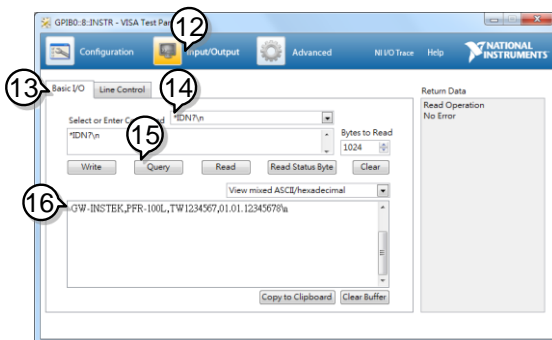





Note

For further details, please see the programming manual, available on the GW Instek web site @ [www.gwinstek.com](http://www.gwinstek.com).

## UART Remote Interface

### Configure UART

#### Overview

The PFR-100 uses the IN & OUT ports for UART communication coupled with RS232 (GW Instek Part number: PSU-232) or RS485 adapters (GW Instek part number: PSU-485).

The pin outs for the adapters are shown below.

RS 232 cable with DB9 & RJ-45 shielded connectors form PSU-232 connection kit

DB-9 Connector			Remote IN Port(RJ-45)		Remark
Pin No.	Name		Pin No.	Name	
Housing	Shield	↔	Housing	Shield	
2	RX	↔	7	TX	Twisted pair
3	TX	↔	8	RX	
5	SG	↔	1	SG	

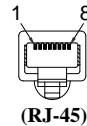
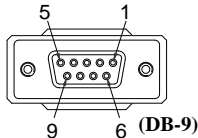

RS 485 cable with DB9 & RJ-45 shielded connectors form PSU-485 connection kit

DB-9 Connector			Remote IN Port(RJ-45)		Remark
Pin No.	Name		Pin No.	Name	
Housing	Shield	↔	Housing	Shield	
9	TXD-	↔	6	RXD-	Twisted pair
8	TXD+	↔	3	RXD+	
1	SG	↔	1	SG	
5	RXD-	↔	5	TXD-	Twisted pair
4	RXD+	↔	4	TXD+	

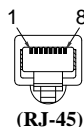
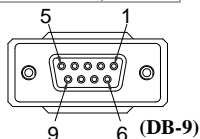

To use RS485-2W, please refer to this wiring

User's RS485-2W		DB-9 Connector (PSU-485 RS485 cable with DB9 connector)	
Name		Pin No.	Name
		Housing	Shield
DATA+	↔	8	TXD+
	↔	4	RXD+
SG	↔	1	SG
DATA-	↔	9	TXD-
	↔	5	RXD-

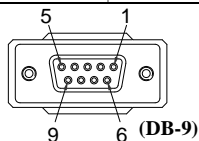

Steps

1. Connect the RS232 serial cable (include in the PSU-232 connection kit) or RS485 serial cable (include in the PSU-485 connection kit) to the Remote IN port on the real panel.

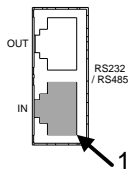

Connect the other end of the cable to the PC.

2. Press the Function key to enter the Page 8 Normal configuration settings.

Set the following UART settings:

F-29 = 1 or 2	Interface port: 1 = RS232 or 2 = RS485
F-71 = 0 ~ 7	Set the baud rate: 0=1200, 1=2400, 2=4800, 3=9600, 4=19200, 5=38400, 6=57600, 7=115200
F-72 = 0 or 1	Data bits: 0=7 or 1=8
F-73 = 0 ~2	Parity: 0 = none, 1 = odd, 2 = even
F-74 = 0 or 1	Stop bits: 0 = 1, 1 = 2
F-75 = 0	TCP: 0 = SCPI
F-76 = 0~30	UART address for multi-unit remote connection.
F-77 = 0~3	Multi-Drop control 0 = Disable, 1 = Master, 2 = Slave, 3 = Display Information
F-78 = 0~30	Multi-Drop status display Displayed parameter: AA-S AA: 0~30 (Address), S: 0~1 (Off-line/On-line status).

- The RMT indicator will turn on when a remote connection has been established.



RMT indicator

## UART Function Check

Functionality check

Invoke a terminal application such as Realterm.

To check the COM port No, see the Device Manager in the PC. For WinXP; Control panel → System → Hardware tab.

Run this query command via the terminal application after the instrument has been configured for either RS232 or RS485 remote control (page 41).

## SCPI commands

Command or response	Status
*IDN?	Typing
GW-INSTEK,PFR-100L, TW1234567, 01.01.12345678	Return
Return the manufacturer, model, serial number, and firmware version in the above format.	Note
Manufacturer: GW-INSTEK	
Model: PFR-100L	
Serial number: TW1234567	
Firmware version: 01.01.12345678	

## Multiple Unit Connection

The PFR-100 power supplies can have up to 31 units daisy-chained together using the 8 pin connectors (IN OUT ports) on the rear panel. The first unit (master) in the chain is remotely connected to a PC using RS232 or RS485 (Legacy Multi-Drop mode), or USB, GPIB or LAN (Multi-Drop mode). Each subsequent unit (slave) is daisy-chained to the next using a RS485 local bus. The OUT port on the last terminal must be terminated by the end terminal connector.

There are two modes for controlling multiple units. In the first mode (Legacy Multi-Drop mode), The PC is only allowed to use RS232 or RS485 to connect to the first device, and all UART parameters must be executed in this mode configuration. The remote command supports teh SCPI commands or TDK legacy commands.

In the second mode (Multi-Drop mode), the PC is allowed to connect to the first unit using USB-CDC/GPIB/LAN. In this mode, you only need to specify the Multi-Drop parameter. Remote commands only supports SCPI commands. For these two modes, each unit is assigned a unique address, which can then be controlled independently of the host PC.

### Legacy Multi-Drop mode

---

- |           |   |
|-----------|---|
| Operation | <ol style="list-style-type: none"><li>1. Connect the first unit's IN port to a PC via RS232 or RS485 serial cable.<ul style="list-style-type: none"><li>• Use the serial cables supplied in the PSU-232 or PSU-485 connection kit.</li></ul></li><li>2. Plug in intermediate connector to the OUT port on the first unit then using the slave serial link cable (black plug) to connect intermediate connector to the IN port of the second unit.</li></ol> |
|-----------|---|

3. Connect all the remaining units in the same fashion until all the units have been daisy-chained together.

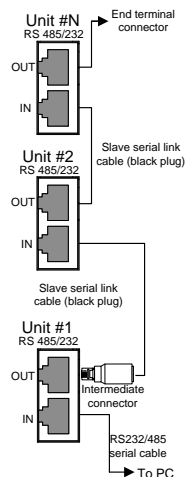

4. Terminate the OUT port of the last unit with the end terminal connector included in the PSU-232 or PSU-485 connection kit.
5. Press the Function key to enter the Page 8 Normal configuration settings for the master unit.

Set the following settings:

F-29 = 1~3	Configure the master unit as you normally would for RS232 or RS485 remote control, see page 41.
F-71 = 0~7	Set the baud rate (set all units the same). See page 41.
F-72 = 1	Set to 8 data bits.
F-73 = 0	Parity to none.
F-74 = 0	1 Stop bit.
F-75 = 0	Set the UART TCP to SCPI.
F-75 = 0 or 1	F-75 = 1 Set the UART TCP to TDK (emulation mode).

---

F-76 = 00~30	Set the address of the master unit. It must be a unique address identifier.
F-77 = 0	Disable Multi-Drop mode.

---

6. Press the Function key to enter the Page 8 Normal configuration settings for the slave(s).

Set the following settings:

F-29 = 2	Set the slave unit to RS485.
F-71 = 0~7	Set the baud rate (make all units, including the master, the same baud). See page 41.
F-72 = 1	Set to 8 data bits.
F-73 = 0	Parity to none.
F-74 = 0	1 Stop bit.
F-75 = 0~1	F-75 = 0 Set the UART TCP to SCPI. F-75 = 1 Set the UART TCP to TDK (emulation mode).
F-76 = 00~30	Set the address of each slave to a unique address identifier
F-77 = 0	Disable Multi-Drop mode.

---

7. Multiple units can now be operated at the same time. See the programming manual or see the function check below for usage details.
-

Slave serial link cable with RJ-45 shielded connectors from PSU-232 or PSU-485 connection kit

RS-485 slave serial link pin assignment					
8 Pin Connector (IN) (RJ-45)			8 Pin Connector (OUT) (RJ-45)		
Pin No.	Name		Pin No.	Name	
Housing	Shield	↔	Housing	Shield	
1	SG	↔	1	SG	
6	TXD -	↔	6	TXD -	
3	TXD +	↔	3	TXD +	
5	RXD -	↔	5	RXD -	
4	RXD +	↔	4	RXD +	

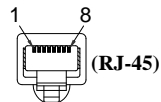
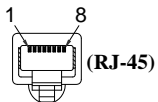
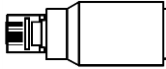



Diagram of Intermediate connector



Intermediate connector from PSU-232 or PSU-485 connection kit.	Intermediate connector					
	8 Pin (Male)			8 Pin (Female)		
	Pin No.	Name		Pin No.	Name	Remarks
	Housing	Shield	↔	Case	Shield	
	1	SG	↔	1	SG	
	6	TXD -	↔	6	TXD -	Internal paralleled by 120 ohm
	3	TXD +	↔	3	TXD +	
5	RXD -	↔	5	RXD -	Internal paralleled by 120 ohm	
4	RXD+	↔	4	RXD +		

Diagram of End terminal connector



End terminal connector from PSU-232 or PSU-485 connection kit.	End terminal connector	
	8 Pin Connector	
	Pin No.	Remarks
	3	Internal shorted
	7	
4	Internal shorted	

## Multi-Drop mode

### Operation

1. All units must be powered down before starting the Multi-Drop mode configuration.
2. Connect the first unit's LAN, USB or GPIB port to a PC.
3. Plug in intermediate connector to the OUT port on the first unit then using the mater serial link cable (gray plug) to connect intermediate connector to the IN port of the second unit.

4. Connect all the remaining units between the OUT port and the IN port with the slave serial link cable (black plug) supplied in the PSU-232 or PSU-485 connection kit until all the desired units have been daisy-chained together.

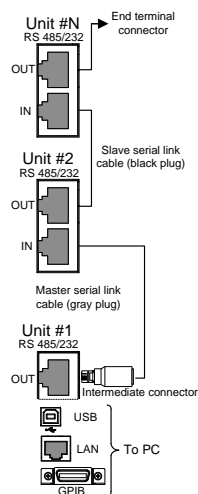

5. Terminate the OUT port of the last unit with the end terminal connector included in the PSU-232 or PSU-485 connection kit.
6. Power up all slave units.
7. Set the addresses of all slave units using the F-76 parameter.

- F-76 = 00~30      Set the address of the master unit. It must be a unique address identifier.
8. Set the Multi-Drop setting parameter (F-77) to Slave for all slave units.
- F-77 = 2      Set the Multi-Drop setting to slave.
9. Power up the master unit.
10. Set the addresses of the master units using the F-76 parameter.
- F-76 = 0 ~ 30      Set the address of the unit. It must be a unique address identifier.
11. You can check the slaves' addresses by using the F-77 parameter on the master unit.
- F-77 = 3      Display on each slave units the configured address. This can show if identical addresses have been assigned individually to each slave units.
12. Set the Multi-Drop setting parameter (F-77) to Master.
- F-77 = 1      Set the Multi-Drop setting to master.
13. You can display the status of each slave unit by using the F-78 parameter.
- F-78 = 0~30      Displayed parameter: AA-S  
AA: 0~30 (Address),  
S: 0~1 (Off-line/On-line status).
14. Multiple units can now be operated using SCPI commands. See the programming manual or see the function check below for usage details.

Slave serial link cable with RJ-45 shielded connectors from PSU-232 or PSU-485 connection kit

RS-485 slave serial link pin assignment				
8 Pin Connector (IN) (RJ-45)			8 Pin Connector (OUT) (RJ-45)	
Pin No.	Name		Pin No.	Name
Housing	Shield	↔	Housing	Shield
1	SG	↔	1	SG
6	TXD -	↔	6	TXD -
3	TXD +	↔	3	TXD +
5	RXD -	↔	5	RXD -
4	RXD +	↔	4	RXD +

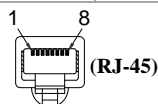
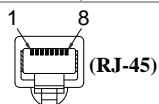

Master serial link cable with RJ-45 shielded connectors from PSU-232 or PSU-485 connection kit

RS-485 master serial link pin assignment				
8 Pin Connector (IN) (RJ-45)			8 Pin Connector (OUT) (RJ-45)	
Pin No.	Name		Pin No.	Name
Housing	Shield	↔	Housing	Shield
1	SG	↔	1	SG
6	TXD -	↔	5	RXD -
3	TXD +	↔	4	RXD +
5	RXD -	↔	6	TXD -
4	RXD +	↔	3	TXD +

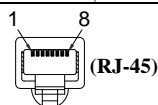
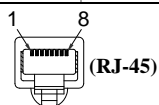
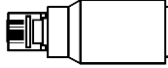

Diagram of Intermediate connector



Intermediate connector from PSU-232 or PSU-485 connection kit.	Intermediate connector					
	8 Pin (Male)			8 Pin (Female)		
	Pin No.	Name		Pin No.	Name	Remarks
		Housing	Shield	↔	Case	Shield
	1	SG	↔	1	SG	
	6	TXD -	↔	6	TXD -	Internal paralleled by 120 ohm
	3	TXD +	↔	3	TXD +	
	5	RXD -	↔	5	RXD -	Internal paralleled by 120 ohm
4	RXD +	↔	4	RXD +		

Diagram of End terminal connector



End terminal connector from PSU-232 or PSU-485 connection kit.	End terminal connector	
	8 Pin Connector	
	Pin No.	Remarks
	3	Internal shorted
	7	
	4	Internal shorted
8		

### Multiple units Function Check

Functionality check

Invoke a terminal application such as Realterm.

To check the COM port No, see the Device Manager in the PC. For WinXP; Control panel → System → Hardware tab.

Below shows examples using the Legacy Multi-Drop mode and the Multi-Drop mode.

Legacy Multi-Drop mode

When using SCPI commands or TDK GENESYS legacy commands, each unit can be individually controlled using the unique address identifiers. For this function check, we will assume that the master unit is assigned to address 8, while a slave is assigned address 11.

Run this query command via the terminal application after the instruments have been configured for multi-unit control with Legacy Multi-Drop mode. See page 45.

SCPI commands

Command or response	Status
INST:SEL 8	Typing
*IDN?	Typing
GW-INSTEK,PFR-100L,TW1234567,01.01.12345678	Return
Selects the unit with address 8 and returns its identity string.	Note
INST:SEL 11	Typing
*IDN?	Typing
GW-INSTEK,PFR-100M,TW1234567,01.01.12345678	Return
Selects the unit with address 11 and returns its identity string.	Note

TDK GENESYS legacy commands

(Because the terminal character used by the TDK GENESYS legacy command is CR instead of LF, the terminal characters are specifically listed below)

Command or response	Status
ADR 8\r	Typing
OK\r	Return

---

IDN? \r	Typing
GW-INSTEK,PFR-100L,TW1234567,01.01.12345678	Return
Selects the unit with address 8 and returns its identity string.	Note

---

ADR 11\r	Typing
OK\r	Return
IDN? \r	Typing
GW-INSTEK,PFR-100M,TW1234567,01.01.12345678	Return
Selects the unit with address 11 and returns its identity string.	Note

---



Note

TDK commands do not use LF (line feed) codes to terminate commands. See the TDK GENESYS user manual for further information.

---

**Multi-Drop mode** When using the Multi-Drop mode, the entire SCPI command list developed for the PFR-100 can be used. Each unit can be individually controlled after a slave unit has been selected. For this function check, we will assume that the master unit is assigned to address 0, while a slave is assigned address 5.

Run this query command via the terminal application after the instruments have been configured for multi-unit control with Multi-Drop mode. See page 44.

---

```
INST:SEL 0
```

```
*IDN?
```

```
GW-INSTEK,PFR-100L,TW1234567,
01.01.12345678
```

Selects the unit with address 0 and returns its identity string.

---

INST:SEL 5

\*IDN?

GW-INSTEK,PFR-100M,TW1234567,  
01.01.12345678

Selects the unit with address 5 and returns its identity string.

---

INST:SEL 6

Selects the unit with address 6 (not configured in our example). An error is displayed on the master front panel.

---

SYST:ERR?

Settings conflict

Query the system errors. "Settings conflict" is returned.

---

INST:STAT?

33,0

Returns the active units and master unit in the bus.

33=0b100001

The units at address 0 and address 5 are on-line.

0

Master device's address is 0.

---



Note

For further details, please see the programming manual, available on the GW Instek web site @ [www.gwinstek.com](http://www.gwinstek.com).

---



## Configure Ethernet Connection

The Ethernet interface can be configured for a number of different applications. Ethernet can be configured for basic remote control or monitoring using a web server or it can be configured as a socket server.

The PFR-100 series supports both DHCP connections so the instrument can be automatically connected to an existing network or alternatively, network settings can be manually configured.

Parameters	DHCP Enable/Disable	MAC Address (display only)
	Subnet Mask	IP Address
	DNS Address	Gateway
	Web Enter Password	Web Password Enable/Disable

## Web Server Configuration

**Configuration** This configuration example will configure the PFR-100 as a web server and use DHCP to automatically assign an IP address to the PFR-100.

1. Connect an Ethernet cable from the network to the rear panel Ethernet port.

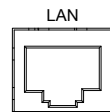

2. Press the Function key to enter the Normal configuration settings. Page 8

Set the following LAN settings:

- |               |  |
|---------------|--|
| F-29 = 6      | Interface port select & Turn LAN (Web) on                          |
| F-37 = 1      | Enable DHCP  |
| F-60 = 0 or 1 | Set to 0 to disable web password, set to 1 to enable web password. |

F-61 = 0000      Set the web password  
 ~9999

- The LAN indicator will turn on when a network cable is plugged in.



Note

It may be necessary to cycle the power or refresh the web browser to connect to a network.

### Web Server Remote Control Function Check

Functionality  
 check

Enter the IP address of the power supply in a web browser after the instrument has been configured as a web server.

The web server allows you to monitor the function settings of the PFR-100.

You can check the IP address by checking F-39 to F-42.

F-39 = AAA      IP Address part 1 of 4  
 F-40 = BBB      IP Address part 2 of 4  
 F-41 = CCC      IP Address part 3 of 4  
 F-42 = DDD      IP Address part 4 of 4

[http:// AAA.BBB.CCC.DDD](http://AAA.BBB.CCC.DDD)

The web browser interface appears.

PFR-100 Series Web Control Pages Visit Our Site   •Support   •Contact Us

• [Welcome Page]	Thanks For Your Using. Use the left menu to select the features you need. More How-to. Please refer to user manual.
	<b>System Information</b>
	Manufacturer : GW-INSTEK
	Serial Number : TW1234567
• [Network Configuration]	Description : GW-INSTEK,PFR-100L
	Firmware Version : 01.01.12345678
	Hostname : P-1234567
• [Measurement]	IP Address : 192.168.0.103
	Subnet Mask : 255.255.255.0
	Gateway : 192.168.0.1
• [Normal Function]	DNS : 0.0.0.0
	MAC Address : 00-11-22-AA-BB-02
	DHCP State : ON
• [Power On Configuration]	VISA TCP/IP Connect String : TCPIP0:192.168.0.103:2268::SOCKET

Copyright 2017 © Good Will Instrument Co., Ltd All Rights Reserved.

The web browser interface allows you to access the following:

- Network configuration settings
- Measurement setting
- Normal Function setting
- Power On Configuration setting

## Sockets Server Configuration

**Configuration** This configuration example will configure the PFR-100 socket server.

The following configuration settings will manually assign the PFR-100 an IP address and enable the socket server. The socket server port number is fixed at 2268.

1. Connect an Ethernet cable from the network to the rear panel Ethernet port.

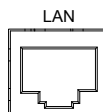

2. Press the Function key to enter the Normal configuration settings. Page 8

Set the following LAN settings:

F-29 = 5	Interface port select & Turn LAN(Socket) on
F-37 = 0	Disable DHCP
F-39 = 172	IP Address part 1 of 4
F-40 = 16	IP Address part 2 of 4
F-41 = 5	IP Address part 3 of 4
F-42 = 133	IP Address part 4 of 4
F-43 = 255	Subnet Mask part 1 of 4
F-44 = 255	Subnet Mask part 2 of 4
F-45 = 128	Subnet Mask part 3 of 4
F-46 = 0	Subnet Mask part 4 of 4
F-47 = 172	Gateway part 1 of 4
F-48 = 16	Gateway part 2 of 4
F-49 = 21	Gateway part 3 of 4
F-50 = 101	Gateway part 4 of 4

## Socket Server Function Check

---

**Background** To test the socket server functionality, National Instruments Measurement and Automation Explorer can be used. This program is available on the NI website, [www.ni.com](http://www.ni.com), via a search for the VISA Run-time Engine page, or “downloads” at the following URL, <http://www.ni.com/visa/>

---

**Requirements** Operating System: Windows XP, 7, 8

---

**Functionality check**

1. Start the NI Measurement and Automation Explorer (MAX) program. Using Windows, press:

*Start>All Programs>National Instruments>Measurement & Automation*



2. From the Configuration panel access;

*My System>Devices and Interfaces>Network Devices*

3. Press *Add New Network Device>Visa TCP/IP Resource...*

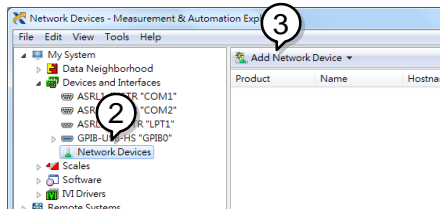

4. Select *Manual Entry of Raw Socket* from the popup window.

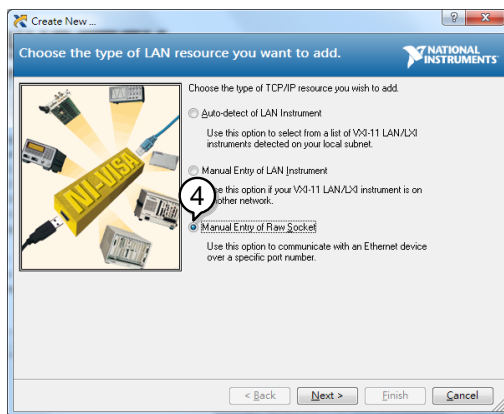

5. Enter the IP address and the port number of the PFR-100. The port number is fixed at 2268.
6. Click the Validate button.
7. A popup will appear if a connection is successfully established.
8. Click Next.

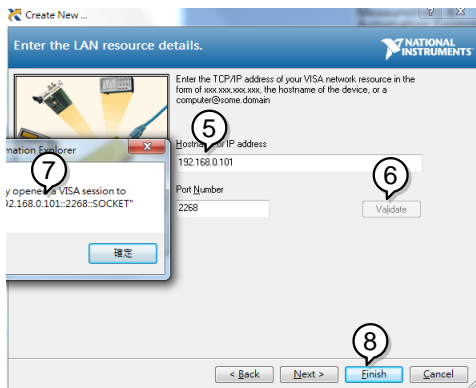

9. Next configure the Alias (name) of the PFR-100 connection. In this example the Alias is: PFR\_DC1

10. Click finish.

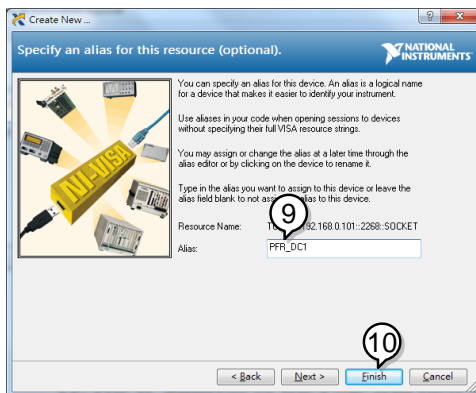

11. The IP address of the PFR-100 will now appear under Network Devices in the configuration panel. Select this icon now.

12. Click *Open VISA Test Panel*.

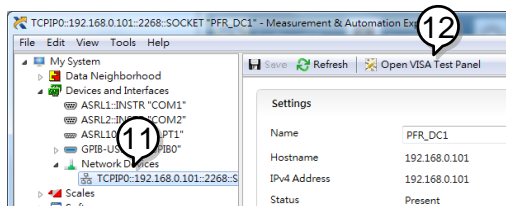

13. Click the *Configuration* icon,
14. Click on *I/O Settings*.
15. Make sure the *Enable Termination Character* check box is checked, and the terminal character is \n (Value: xA).
16. Click *Apply Changes*.

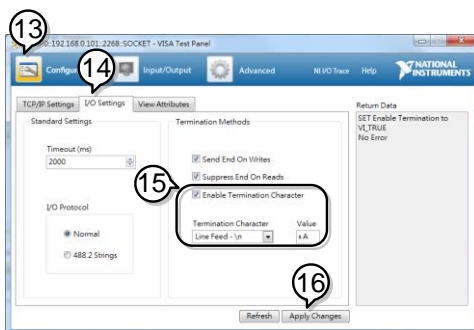

17. Click the *Input/Output* icon.
18. Enter *\*IDN?* in the *Select or Enter Command* dialog box if it is not already.
19. Click the *Query* button.
20. The *\*IDN?* query will return the Manufacturer, model name, serial number and firmware version in the dialog box.



GW-INSTEK,PFR-100L,TW1234567,01.01.12345678

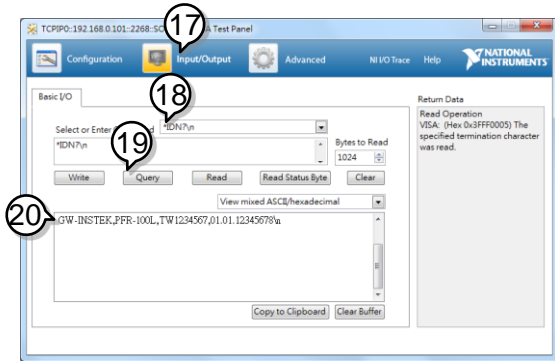

 Note

For further details, please see the programming manual, available on the GW Instek web site @ [www.gwinstek.com](http://www.gwinstek.com).

## Socket Server Examples

Visual Basic Example .....	66
C++ Example .....	67
LabVIEW Example .....	69

### Visual Basic Example

**Background** The following visual basic programming example uses the VISA COM 3.0 Type Library. The example will connect to the PFR-100 using the IP address of 172.15.5.133 over port 2268. The program will send the \*IDN? to the PFR-100, print the return string and then close the connection.

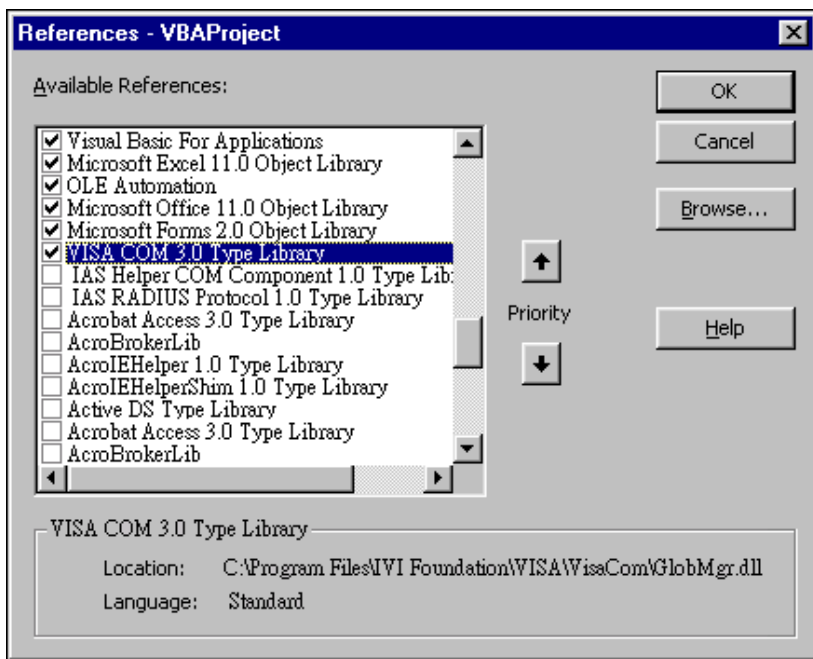

```

'Create VISA ResourceManager object
Dim rm As New VisaComLib.ResourceManager
Dim accessMode As VisaComLib.accessMode
Dim serial As String
Dim timeOut As Integer
Dim optionString As String
Dim psw As VisaComLib.IMessage
Dim pswcom As VisaComLib.FormattedIO488
Dim pswsfc As VisaComLib.IAsyncMessage

Private Sub CommandButton1_Click()
    accessMode = VisaComLib.accessMode.NO_LOCK

    timeOut = 0

    optionString = ""

    'Connect to the PSW

    Set psw = rm.Open("TCPIP0::172.16.5.133::2268::SOCKET", _
        accessMode, _
        timeOut, _
        optionString)
    Set pswsfc = psw
    pswsfc.TerminationCharacterEnabled = True

    'Query the System Identify Name
    psw.WriteString ("*IDN?" & vbCrLf)

    Worksheets("Sheet1").Cells(1, 5) = psw.ReadString(256)

    'Close the communication
    psw.Close

End Sub

```

## C++ Example

**Background**      The following program creates a connection to the PFR-100 and sets the voltage to 3.3 volts and the current 1.5 amps. The voltage and current reading is then read back and the connection is closed.



Note

Add visa32.lib to the project library when building the following sample program.

```
#include "stdio.h"
#include "string.h"
#include "visatype.h"
#include "visa.h"
#define IPAddr "172.16.20.181"
int main(int argc, char* argv[])
{
    ViSession defaultRm, instr;
    // Create VISA ResourceManager object
    ViStatus status = viOpenDefaultRM(&defaultRm);
    if (status < VI_SUCCESS)
    {
        // Initialization error
        return -1;
    }
    ViChar rsc[256];
    sprintf(rsc, "TCPiP0::%s::2268::SOCKET", IPAddr);
    ViAccessMode accessMode = VI_NO_LOCK;
    ViUInt32 timeout = 0;
    // Connect the device
    viOpen(defaultRm, rsc, accessMode, timeout, &instr);
    /* Set the timeout for message-based communication */
    status = viSetAttribute(instr, VI_ATTR_TMO_VALUE, 5000);
    status = viSetAttribute(instr, VI_ATTR_TERMCHAR, 10);
    status = viSetAttribute(instr, VI_ATTR_TERMCHAR_EN, VI_TRUE);
    ViUInt32 count;
    // Set the Voltage to 3.3, Current to 1.5
    ViBuf buf = (ViBuf)":volt 3.3;curr 1.5\n";
    viWrite(instr, buf, (ViUInt32)strlen((ViPChar)buf), &count);

    // Query the Voltage, and Current
    buf = (ViBuf)":apply?\n";
    status = viWrite(instr, buf, (ViUInt32)strlen((ViPChar)buf), &count);
    ViChar result[257];
    status = viRead(instr, (ViPBuf)result, 256, &count);
    if (status=VI_SUCCESS_TERM_CHAR)
    {
        result[count] = 0;
        printf("Voltage(U), Current(A)= %s\n", result);
    }else
        printf("Error\n");

    // Close the device
    viClose(instr);
    viClose(defaultRm);

    return 0;
}
```

## LabVIEW Example

Background The following picture shows a LabView programming example for the PFR-100.

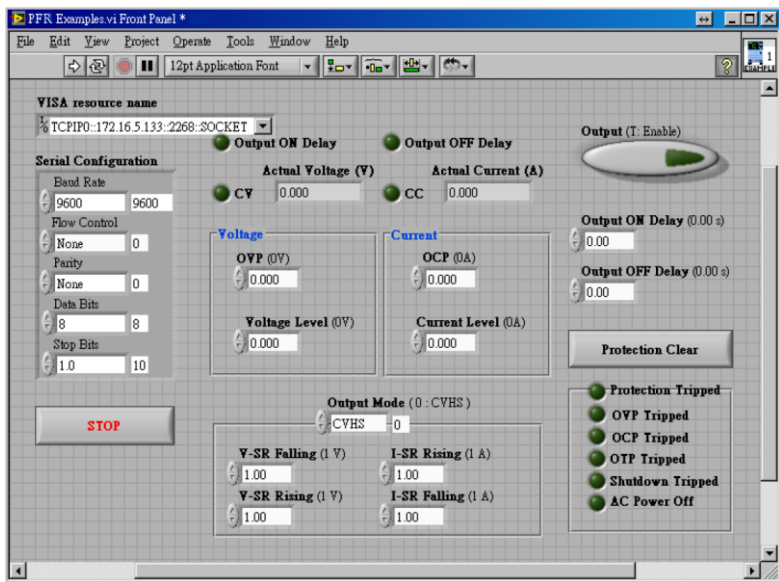

## Command Syntax

Compatible Standard	IEEE488.2 SCPI, 1999	Partial compatibility Partial compatibility
---------------------	-------------------------	--

**Command Structure** SCPI commands follow a tree-like structure, organized into nodes. Each level of the command tree is a node. Each keyword in a SCPI command represents each node in the command tree. Each keyword (node) of a SCPI command is separated by a colon (:).

For example, the diagram below shows an SCPI sub-structure and a command example.

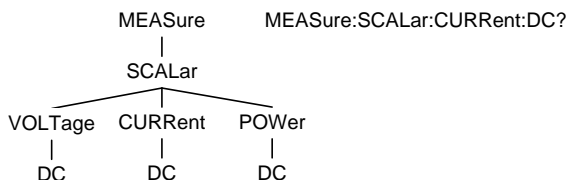

**Command types** There are a number of different instrument commands and queries. A command sends instructions or data to the unit and a query receives data or status information from the unit.

### Command types

**Simple** A single command with/without a parameter

**Example** \*IDN?

---

Query	A query is a simple or compound command followed by a question mark (?). A parameter (data) is returned.
-------	--

Example	meas:curr:dc?
---------	---------------

---

Compound	Two or more commands on the same command line. Compound commands are separated with either a semi-colon (;) or a semi-colon and a colon (;:).
----------	---

A semi-colon is used to join two related commands, with the caveat that the last command must begin at the last node of the first command.

A semi-colon and colon are used to combine two commands from different nodes.

Example	meas:volt:dc?;;meas:curr:dc?
---------	------------------------------

---

**Command Forms** Commands and queries have two different forms, long and short. The command syntax is written with the short form of the command in capitals and the remainder (long form) in lower case.

The commands can be written in capitals or lower-case, just so long as the short or long forms are complete. An incomplete command will not be recognized.

Below are examples of correctly written commands.

Long form STATus:OPERation:NTRansition?  
 STATUS:OPERATION:NTRANSITION?  
 status:operation:ntransition?

Short form STAT:OPER:NTR?  
 stat:oper:ntr?

**Square Brackets** Commands that contain square brackets indicate that the contents are optional. The function of the command is the same with or without the square bracketed items, as shown below.

Both "DISPlay:MENU[:NAME]?" and "DISPlay:MENU?" are both valid forms.

**Command Format**



1. Command header
2. Space
3. Parameter 1
4. Comma (no space before/after comma)
5. Parameter 2

**Parameters**

Type	Description	Example
<Boolean>	Boolean logic	0, 1
<NR1>	integers	0, 1, 2, 3
<NR2>	decimal numbers	0.1, 3.14, 8.5
<NR3>	floating point	4.5e-1, 8.25e+1
<NRf>	any of NR1, 2, 3	1, 1.5, 4.5e-1
<block data>	Definitive length arbitrary block data. A single decimal digit followed by data. The decimal digit specifies how many 8-bit data bytes follow.	

**Message Terminator**

LF Line feed code



## Command List

---

Abort Command	:ABORt .....	77
Apply Commands	:APPLy .....	77
Display Commands	:DISPlay:MENU[:NAME] .....	78
	:DISPlay[:WINDow]:TEXT:CLEAr .....	78
	:DISPlay[:WINDow]:TEXT[:DATA] .....	79
	:DISPlay:BLINK .....	79
Initiate Commands	:INITiate:CONTinuous[:TRANSient] .....	80
	:INITiate[:IMMEDIATE]:NAME .....	80
	:INITiate[:IMMEDIATE][:TRANSient] .....	81
Instrument Commands	:INSTrument:SCAN .....	82
	:INSTrument:SELEct .....	82
	:INSTrument:STATe .....	82
	:INSTrument:DISPlay .....	83
Measure Commands	:MEASure[:SCALAr]:ALL[:DC] .....	84
	:MEASure[:SCALAr]:CURREnt[:DC] .....	84
	:MEASure[:SCALAr]:VOLTage[:DC] .....	84
	:MEASure[:SCALAr]:POWEr[:DC] .....	85
Output Commands	:OUTPut:DELAy:ON .....	86
	:OUTPut:DELAy:OFF .....	86
	:OUTPut:MODE .....	87
	:OUTPut[:STATe][:IMMEDIATE] .....	87
	:OUTPut[:STATe]:TRIGgered .....	87
	:OUTPut:PROTEction:CLEAr .....	88
	:OUTPut:PROTEction:TRIPped .....	88

Sense	:SENSe:AVERAge:COUNT .....	89
Commands		
Status	:STATus:OPERation[:EVENT] .....	90
Commands	:STATus:OPERation:CONDition .....	90
	:STATus:OPERation:ENABle .....	91
	:STATus:OPERation:PTRansition.....	91
	:STATus:OPERation:NTRansition.....	91
	:STATus:QUEStionable[:EVENT] .....	91
	:STATus:QUEStionable:CONDition.....	92
	:STATus:QUEStionable:ENABle .....	92
	:STATus:QUEStionable:PTRansition .....	92
	:STATus:QUEStionable:NTRansition .....	92
	:STATus:QUEStionable:INSTrument:	
	ISUMmary<n>[:EVENT] .....	93
	:STATus:QUEStionable:INSTrument:	
	ISUMmary<n>:CONDition .....	93
	:STATus:QUEStionable:INSTrument:	
	ISUMmary<n>:ENABle .....	93
	:STATus:PRESet .....	94
Source	[:SOURce]:CURRent[:LEVel][:IMMediate]	
Commands	[:AMPLitude].....	96
	[:SOURce]:CURRent[:LEVel]:TRIGgered	
	[:AMPLitude].....	97
	[:SOURce]:CURRent:LIMit:AUTO.....	97
	[:SOURce]:CURRent:PROTection:DELay .....	98
	[:SOURce]:CURRent:PROTection[:LEVel] .....	98
	[:SOURce]:CURRent:PROTection:TRIPped.....	99
	[:SOURce]:CURRent:SLEWrate:RISing .....	99
	[:SOURce]:CURRent:SLEWrate:FALLing.....	99
	[:SOURce]:MODE? .....	100
	[:SOURce]:VOLTagE[:LEVel][:IMMediate]	
	[:AMPLitude].....	100
	[:SOURce]:VOLTagE[:LEVel]:TRIGgered	
	[:AMPLitude].....	101
	[:SOURce]:VOLTagE:LIMit:AUTO .....	101
	[:SOURce]:VOLTagE:LIMit:LOW .....	102
	[:SOURce]:VOLTagE:PROTection[:LEVel] .....	102
	[:SOURce]:VOLTagE:PROTection:TRIPped .....	103
	[:SOURce]:VOLTagE:SLEWrate:RISing.....	103
	[:SOURce]:VOLTagE:SLEWrate:FALLing .....	104

System	:SYSTem:BEEPer[:IMMediate] .....	106
Commands	:SYSTem:CONFigure:BEEPer[:STATe] .....	106
	:SYSTem:CONFigure:BLEeder[:STATe] .....	107
	:SYSTem:CONFigure:CURRent:CONTRol .....	107
	:SYSTem:CONFigure:VOLTagE:CONTRol .....	108
	:SYSTem:CONFigure:OUTPut:PON[:STATe] .....	108
	:SYSTem:CONFigure:OUTPut:EXTernal:MODE.....	109
	:SYSTem:COMMunicate:ENABle.....	109
	:SYSTem:COMMunicate:GPIB[:SELf]:ADDReSS .....	110
	:SYSTem:COMMunicate:LAN:IPADdress.....	110
	:SYSTem:COMMunicate:LAN:GATEWay .....	111
	:SYSTem:COMMunicate:LAN:SMASk .....	111
	:SYSTem:COMMunicate:LAN:MAC.....	111
	:SYSTem:COMMunicate:LAN:DHCP .....	112
	:SYSTem:COMMunicate:LAN:DNS .....	112
	:SYSTem:COMMunicate:RLState .....	112
	:SYSTem:COMMunicate:TCPip:CONTRol .....	113
	:SYSTem:COMMunicate:SERial[:RECeive]	
	:TRANsmit:BAUD .....	113
	:SYSTem:COMMunicate:SERial[:RECeive]	
	:TRANsmit:BITs .....	114
	:SYSTem:COMMunicate:SERial[:RECeive]	
	:TRANsmit:PARity .....	114
	:SYSTem:COMMunicate:SERial[:RECeive]	
	:TRANsmit:SBITs.....	115
	:SYSTem:COMMunicate:MULTidrop:CONTRol.....	115
	:SYSTem:COMMunicate:USB:FRONt:STATe.....	115
	:SYSTem:COMMunicate:USB:REAR:STATe.....	116
	:SYSTem:ERRor .....	116
	:SYSTem:KLOCK .....	116
	:SYSTem:KEYLock:MODE .....	116
:SYSTem:ERRor:ENABle .....	117	
:SYSTem:PRESet .....	117	
:SYSTem:VERSIon .....	117	
:SYSTem:REBoot .....	117	
Trigger Commands	:TRIGger:OUTPut:SOURce.....	118
	:TRIGger:OUTPut[:IMMediate] .....	118
	:TRIGger[:TRANsient]:SOURce .....	118
	:TRIGger[:TRANsient][:IMMediate].....	119
	Trigger Command Examples .....	119

Common Commands	*CLS .....	121
	*ESE .....	121
	*ESR .....	122
	*IDN .....	122
	*OPC .....	122
	*RCL .....	123
	*RST .....	123
	*SAV .....	123
	*SRE .....	123
	*STB .....	124
	*TRG .....	124
	*TST .....	124
	*WAI .....	124

## Abort Command

:ABORt ..... 77

### :ABORt



**Description** The :ABORt command will cancel any triggered actions.

**Syntax** :ABORt

## Apply Commands

:APPLy ..... 77

### :APPLy

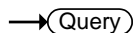
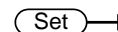

**Description** The apply command sets the voltage and current at the same time.

**Syntax** :APPLy  
{<NRf>(V)|MINimum|MAXimum[,<NRf>(A)|MINimum|MAXimum]}

**Query Syntax** :APPLy?

<b>Parameter/</b>	<NRf>(V)	Voltage setting.
<b>Return parameter</b>	MINimum	Minimum voltage level
	MAXimum	Maximum voltage level
	<NRf>(A)	Current setting.
	MINimum	Minimum voltage level
	MAXimum	Maximum voltage level

**Example** APPL MIN, MIN  
Sets the current and voltage to the minimum settings.

## Display Commands

:DISPlay:MENU[:NAME]	78
:DISPlay[:WINDow]:TEXT:CLEar	78
:DISPlay[:WINDow]:TEXT[:DATA]	79
:DISPlay:BLINK	79

### :DISPlay:MENU[:NAME]

Set →

→ Query

Description	The DISPlay MENU command selects a screen menu or queries the current screen menu.	
Syntax	:DISPlay:MENU[:NAME] <NR1>	
Query Sytax	:DISPlay:MENU[:NAME]?	
Parameter/ Return parameter	<NR1>	Description
	0	Measure voltage & current
	1~2	Not Used
	3	Set Menu
	4	OVP / OCP Menu
	5~99	Not Used.
	100~199	F-00~99 Menu.
	200~229	F100~F129 Menu.
Example	DISP:MENU:NAME 0 Sets the display to the Voltage/Current display screen.	

### :DISPlay[:WINDow]:TEXT:CLEar

Set →

Description	Clears the text on the main screen from the :DISPlay[:WINDow]:TEXT[:DATA] command.	
Syntax	:DISPlay[:WINDow]:TEXT:CLEar	

**:DISPlay[:WINDow]:TEXT[:DATA]**  

Description	Sets or queries the data text that will be written to the display. Writing to the display will overwrite data that is currently on the screen. Overwriting a display area with a shorter string may or may not overwrite the screen. The string must be enclosed in quotes: "STRING". Only ASCII characters 20H to 7EH can be used in the <string>.
Syntax	:DISPlay[:WINDow]:TEXT[:DATA] <string>
Query Syntax	:DISPlay[:WINDow]:TEXT[:DATA]?
Parameter/ Return parameter	<string> ASCII character 20H to 7EH can be used to in the string parameter. The string must be enclosed in quotes: "STRING"
Example	DISP:WIND:TEXT:DATA "STRING" Writes STRING to the display.
Query Example	DISP:WIND:TEXT:DATA? "STRING" Returns the text data string on the screen.

**:DISPlay:BLINK**  

Description	Turns blink on or off for the display. Blink is set to OFF by default.
Syntax	:DISPlay:BLINK {<bool> OFF ON}
Query Syntax	:DISPlay:BLINK?
Parameter	OFF   0 Turns blink OFF ON   1 Turns blink ON
Return parameter	<bool> Returns the blink status.
Example	DISP:BLIN 1 Turns blink ON.

## Initiate Commands

:INITiate:CONTInuous[:TRANsient] .....	80
:INITiate[:IMMEDIATE]:NAME .....	80
:INITiate[:IMMEDIATE][:TRANsient] .....	81

### :INITiate:CONTInuous[:TRANsient]

Set →

→ Query

Description	This command continuously initiates software triggers for the transient or output triggers.
Syntax	:INITiate:CONTInuous[:TRANsient]
Query Syntax	{<bool> OFF ON} :INITiate:CONTInuous[:TRANsient]?
Parameter	OFF   0    OFF ON   1    ON
Return parameter	0        OFF 1        ON
Example	INIT:TRAN 1 Turns on the continuous trigger.

### :INITiate[:IMMEDIATE]:NAME

Set →

Description	The INITiate command starts the TRANsient or OUTPut trigger.
Syntax	:INITiate[:IMMEDIATE]:NAME {TRANsient OUTPut}
Parameter	TRANsient    Starts the TRANsient trigger. OUTPut        Starts the OUTPut trigger.
Example	INITiate:NAME TRANient Starts the TRANsient trigger.



---

:INITiate[:IMMEDIATE][:TRANSient]

---

Set →

Description      This command controls the enabling of output triggers. When a trigger is enabled, a trigger causes the specified action to occur. If the trigger system is not enabled, all triggers are ignored.

---

Syntax            :INITiate[:IMMEDIATE][:TRANSient]

---

Example          INIT

## Instrument Commands

:INSTrument:SCAN .....	82
:INSTrument:SELEct.....	82
:INSTrument:STATe.....	82
:INSTrument:DISPlay.....	83

### :INSTrument:SCAN

Set →

**Description** Links the units which could be scanned from system when using Multi-Drop mode.

**Syntax** :INSTrument:SCAN

Set →

### :INSTrument:SELEct

→ Query

**Description** Specifies the address of the unit to which communication will be established when using the Multi-Drop mode.

**Syntax** :INSTrument :SELEct {<NR1>}

**Query Syntax** :INSTrument :SELEct?

**Parameter** <NR1> The address of the unit to be selected (0~30).

**Return parameter** <NR1> The currently selected address.

**Example** :INST:SEL?  
>30

The currently selected address is 30.

### :INSTrument:STATe

→ Query

**Description** Displays the status (on-line/off-line) of each slave unit and the address of master unit, when using the Multi-Drop mode.

**Query Syntax** :INSTrument:STATe?

Return parameter	$\langle \text{NR1} \rangle, \langle \text{NR1} \rangle$ 0~2147483647, 0~30 (2147483647=2 <sup>31</sup> -1) First value: Each bit of the binary value corresponds to a unit from 0 to 30 (LSB to MSB). The bit will be set to 1 when the corresponding unit is on-line. Second value: This value represents the master address.
------------------	---

Example

```
:INST:STAT?
33,0
33=0b100001
The units at address 0 and address 5 are on-line.
0
Master device's address is 0.
```

**:INSTrument:DISPlay**



Description	Displays information (configured address) for all slave units when using the Multi-Drop mode.
Syntax	:INSTrument:DISPlay
Example	:INST:DISP

## Measure Commands

:MEASure[:SCALar]:ALL[:DC] .....	84
:MEASure[:SCALar]:CURRent[:DC] .....	84
:MEASure[:SCALar]:VOLTage[:DC] .....	84
:MEASure[:SCALar]:POWer[:DC] .....	85

### :MEASure[:SCALar]:ALL[:DC] → Query

**Description** Takes a measurement and returns the average output current and voltage

**Syntax** :MEASure[:SCALar]:ALL[:DC]?

**Return parameter** "+0.0000,+0.0000" <voltage>,<current>  
Returns the voltage (V) and current (A), respectively.

### :MEASure[:SCALar]:CURRent[:DC] → Query

**Description** Takes a measurement and returns the average output current

**Syntax** :MEASure[:SCALar]:CURRent[:DC]?

**Return parameter** "+0.0000" Returns the current in amps.

### :MEASure[:SCALar]:VOLTage[:DC] → Query

**Description** Takes a measurement and returns the average output voltage.

**Syntax** :MEASure[:SCALar]:VOLTage[:DC]?

**Return** "+0.0000" Returns the voltage in volts.

---

:MEASure[:SCALar]:POWer[:DC]

→ Query

---

Description	Takes a measurement and returns the average output power.
Syntax	:MEASure[:SCALar]:POWer[:DC]?
Return	" +0.0000" Returns the power measured in watts.

## Output Commands

:OUTPut:DElay:ON .....	86
:OUTPut:DElay:OFF .....	86
:OUTPut:MODE .....	87
:OUTPut[:STATe][:IMMediate] .....	87
:OUTPut[:STATe]:TRIGgered .....	87
:OUTPut:PROTection:CLear .....	88
:OUTPut:PROTection:TRIPped .....	88

:OUTPut:DElay:ON 



Description	Sets the Delay Time in seconds for turning the output on. The delay is set to 0.00 by default.	
Syntax	:OUTPut:DElay:ON {<NR2> MINimum MAXimum}	
Query Syntax	:OUTPut:DElay:ON?	
Parameter	<NR2>	0.00~99.99 seconds, where 0=no delay.
Return parameter	"0.00"	Returns the delay on time in seconds until the output is turned on.

:OUTPut:DElay:OFF 



Description	Sets the Delay Time in seconds for turning the output off. The delay is set to 0.00 by default.	
Syntax	:OUTPut:DElay:OFF {<NR2>  MINimum MAXimum}	
Return Syntax	:OUTPut:DElay:OFF?	
Parameter	<NR2>	0.00~99.99 seconds, where 0=no delay.
Return parameter	"0.00"	Returns the delay off time in seconds until the output is turned off.

**:OUTPut:MODE** 

Description	Sets the PFR-100 output mode. This is the equivalent to the F-03 (V-I Mode Slew Rate Select) settings.
Syntax	:OUTPut:MODE {<NR1> CVHS CCHS CVLS CCLS}
Return Syntax	:OUTPut:MODE?
Parameter	CVHS   0 CV high speed priority CCHS   1 CC high speed priority CVLS   2 CV slew rate priority CCLS   3 CC slew rate priority
Return parameter	<NR1> Returns the output mode.

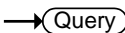
**:OUTPut[:STATe][:IMMediate]** 

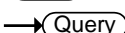

Description	Turns the output on or off.
Syntax	:OUTPut[:STATe][:IMMediate] { <bool>   OFF   ON }
Query Syntax	:OUTPut[:STATe][:IMMediate]?
Parameter	OFF   0 Turns the output off. ON   1 Turns the output on.
Return parameter	<bool> Returns output status of the instrument.

**:OUTPut[:STATe]:TRIGgered** 

  

Description	Turns the output on or off when a software trigger is generated.
Syntax	:OUTPut[:STATe]:TRIGgered { <bool> OFF ON }
Query Syntax	:OUTPut[:STATe]:TRIGgered?
Parameter	OFF   0 Turns the output off when a software trigger is generated (*TRG). ON   1 Turns the output on when a software trigger is generated (*TRG).
Return parameter	<bool> Returns output trigger status of the instrument.

**:OUTPut:PROTection:CLEAr** (Set) →

**Description**      Clears over-voltage, over-current and over-temperature (OVP, OCP, OTP) protection circuits. It also clears the shutdown and sense protection circuit. The AC failure protection cannot be cleared.

**Syntax**            :OUTPut:PROTection:CLEAr

**:OUTPut:PROTection:TRIPped** → (Query)

**Description**      Queries the unit to see if a protection circuit has been tripped.

**Syntax**            :OUTPut:PROTection:TRIPped?

**Return**            <boolean>      0 = No protection error  
    1 = A protection error had occurred



## Sense Commands

:SENSe:AVERAge:COUNT..... 89

:SENSe:AVERAge:COUNT 
 Set →  
 →  Query

Description	Sets or queries the level of smoothing for the average setting.	
Syntax	:SENSe:AVERAge:COUNT	
Return Syntax	{<NR1> LOW MIDDLE HIGH}	
	:SENSe:AVERAge:COUNT?	
Parameter	LOW   0	Low setting
	MIDDLE   1	Middle setting
	HIGH   2	High setting
Return Parameter	<NR1>	Returns the average setting.

## Status Commands

For an overview of all the status registers, their associated register contents and the system diagram, please see the status overview on page 124

---

:STATus:OPERation[:EVENT]	90
:STATus:OPERation:CONDition	90
:STATus:OPERation:ENABle	91
:STATus:OPERation:PTRansition	91
:STATus:OPERation:NTRansition	91
:STATus:QUEStionable[:EVENT]	91
:STATus:QUEStionable:CONDition	92
:STATus:QUEStionable:ENABle	92
:STATus:QUEStionable:PTRansition	92
:STATus:QUEStionable:NTRansition	92
:STATus:QUEStionable:INSTrument:	
ISUMmary<n>[:EVENT]	93
:STATus:QUEStionable:INSTrument:	
ISUMmary<n>:CONDition	93
:STATus:QUEStionable:INSTrument:	
ISUMmary<n>:ENABle	93
:STATus:PRESet	94

### :STATus:OPERation[:EVENT] → Query

---

Description	Queries the Operation Status Event register and clears the contents of the register.
-------------	--

Syntax	:STATus:OPERation[:EVENT]?
--------	----------------------------

Return	<NR1> Returns the bit sum of the Operation Status Event register.
--------	---

### :STATus:OPERation:CONDition → Query

---

Description	Queries the Operation Status register. This query will not clear the register.
-------------	--

Syntax	:STATus:OPERation:CONDition?
--------	------------------------------

Return <NR1> Returns the bit sum of the Operation Condition register.

Set →

:STATus:OPERation:ENABLE

→ Query

Description Sets or queries the bit sum of the Operation Status Enable register.

Syntax :STATus:OPERation:ENABLE <NR1>

Query Syntax :STATus:OPERation:ENABLE?

Parameter <NR1> 0~32767

Return parameter <NR1> 0~32767

Set →

:STATus:OPERation:PTRansition

→ Query

Description Sets or queries the bit sum of the positive transition filter of the Operation Status register.

Syntax :STATus:OPERation:PTRansition <NR1>

:STATus:OPERation:PTRansition?

Parameter <NR1> 0~32767

Return parameter <NR1> 0~32767

Set →

:STATus:OPERation:NTRansition

→ Query

Description Sets or queries the bit sum of the negative transition filter of the Operation Status register.

Syntax :STATus:OPERation:NTRansition <NR1>

Query Syntax :STATus:OPERation:NTRansition?

Parameter <NR1> 0~32767

Return parameter <NR1> 0~32767

:STATus:QUESTionable[:EVENT]

→ Query

Description Queries the bit sum of the Questionable Status Event register. This query will also clear the contents of the register.

Query Syntax :STATus:QUESTionable[:EVENT]?

Return parameter <NR1> 0~32767

**:STATus:QUESTionable:CONDition** → **Query**

Description Queries the status (bit sum) of the Questionable Status register. This query will not clear the register.

Query Syntax :STATus:QUESTionable:CONDition?

Return parameter <NR1> 0~32767

→ **Set** →

**:STATus:QUESTionable:ENABLE** → **Query**

Description Sets or queries the bit sum of the Questionable Status Enable register.

Syntax :STATus:QUESTionable:ENABLE <NR1>

Query Syntax :STATus:QUESTionable:ENABLE?

Parameter <NR1> 0~32767

Return parameter <NR1> 0~32767

→ **Set** →

**:STATus:QUESTionable:PTRansition** → **Query**

Description Sets or queries the bit sum of the positive transition filter of the Questionable Status register.

Syntax :STATus:QUESTionable:PTRansition <NR1>

Return Syntax :STATus:QUESTionable:PTRansition?

Parameter <NR1> 0~32767

Return parameter <NR1> 0~32767

→ **Set** →

**:STATus:QUESTionable:NTRansition** → **Query**

Description Sets or queries the negative transition filter of the Questionable Status register.

Syntax	:STATus:QUESTIONable:NTRansition <NR1>
Query Syntax	:STATus:QUESTIONable:NTRansition?
Parameter	<NR1> 0~32767
Return parameter	<NR1> 0~32767

**:STATus:QUESTIONable:INSTrument:  
ISUMmary<n>[:EVENT]** → Query

Description	Queries the bit sum of the Questionable Instrument Summary Status Event register. This query will also clear the contents of the register (Multi-Drop mode).
Query Syntax	:STATus:QUESTIONable:INSTrument:ISUMmary <n>[:EVENT]?
Parameter	<n> 1,2 or 3
Return parameter	<NR1> 0~32767

**:STATus:QUESTIONable:INSTrument:  
ISUMmary<n>:CONDition** → Query

Description	Queries the status (bit sum) of the Questionable Instrument Summary Status Condition register. This query will not clear the register (Multi-Drop mode).
Query Syntax	:STATus:QUESTIONable:INSTrument:ISUMmary<n>:CONDition?
Parameter	<n> 1, 2 or 3
Return parameter	<NR1> 0~32767

**:STATus:QUESTIONable:INSTrument:  
ISUMmary<n>:ENABle** Set →  
→ Query

Description	Sets or queries the bit sum of the Questionable Instrument Summary Status Enable register. (Multi-Drop mode).
-------------	---

Syntax	:STATus:QUEStionable:INSTRument:ISUMmary <n>:ENABle <NR1>	
Query Syntax	:STATus:QUEStionable:INSTRument:ISUMmary <n>:ENABle?	
Parameter	<n>	1,2 or 3
	<NR1>	0~32767
Return parameter	<NR1>	0~32767

**:STATus:PRESet**



**Description** This command resets the ENABle register, the PTRansition filter and NTRansition filter on the Operation Status and Questionable Status Registers. The registers/filters will be reset to a default value.

Default Register/Filter Values	Setting
QUEStionable Status Enable	0x0000
QUEStionable Status Positive Transition	0x7FFF
QUEStionable Status Negative Transition	0x0000
QUEStionable Instrument Summary1 Status Enable	0x7FFF
QUEStionable Instrument Summary2 Status Enable	0x7FFF
QUEStionable Instrument Summary3 Status Enable	0x7FFF
Operation Status Enable	0x0000
Operation Status Positive Transition	0x7FFF
Operation Status Negative Transition	0x0000

Summary: The Questionable Status Enable registers and the Operation Status Enable registers are both reset to 0.

The Questionable Status and Operation Status Positive Transition filters are all set high (0x7FFF) and the Negative Transition filters are all set low (0x0000). I.e., only positive transitions will be recognized for the Questionable Status and Operation Status registers.

---

Syntax                   :STATus:PRESet

## Source Commands

[:SOURce]:CURRent[:LEVel][:IMMediate]	
[:AMPLitude] .....	96
[:SOURce]:CURRent[:LEVel]:TRIGgered	
[:AMPLitude] .....	97
[:SOURce]:CURRent:LIMit:AUTO.....	97
[:SOURce]:CURRent:PROTection:DELay .....	98
[:SOURce]:CURRent:PROTection[:LEVel] .....	98
[:SOURce]:CURRent:PROTection:TRIPped .....	99
[:SOURce]:CURRent:SLEWrate:RISing.....	99
[:SOURce]:CURRent:SLEWrate:FALLing.....	99
[:SOURce]:MODE? .....	100
[:SOURce]:VOLTag[:LEVel][:IMMediate]	
[:AMPLitude] .....	100
[:SOURce]:VOLTag[:LEVel]:TRIGgered	
[:AMPLitude] .....	101
[:SOURce]:VOLTag:LIMit:AUTO .....	101
[:SOURce]:VOLTag:LIMit:LOW.....	102
[:SOURce]:VOLTag:PROTection[:LEVel] .....	102
[:SOURce]:VOLTag:PROTection:TRIPped .....	103
[:SOURce]:VOLTag:SLEWrate:RISing.....	103
[:SOURce]:VOLTag:SLEWrate:FALLing .....	104

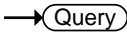
[:SOURce]:CURRent[:LEVel][:IMMediate]        
[:AMPLitude]      

Description	Sets or queries the current level in amps. For externally set current levels (from the analog control connector) the set current level is returned.	
Syntax	[:SOURce]:CURRent[:LEVel][:IMMediate][:AMPLitude] {<NR2>(A) MINimum MAXimum}	
Query Syntax	[:SOURce]:CURRent[:LEVel][:IMMediate][:AMPLitude] ?	
Parameter/Return parameter	<NR2>	0~105% of the rated current output level.
	MIN	Minimum current level.
	MAX	Maximum current level.





`[:SOURce]:CURRent:PROTection:DELay` 

Description	Sets the Delay Time for OCP in seconds for turning the output off. The delay is set to 0.1 by default.	
Syntax	[:SOURce]:CURRent:PROTection:DELay {<NR2> MINimum MAXimum}	
Query Syntax	[:SOURce]:CURRent:PROTection:DELay?	
Parameter	<NR2>	0.1~2.0 seconds, where 0=no delay
	MAX	The maximum allowed delay time
	MIN	The minimum allowed delay time
Return parameter	<NR2>	Returns the delay time in seconds
Example	SOUR:CURR:PROT:DEL MAX Sets the current protection delay to the maximum.	

`[:SOURce]:CURRent:PROTection[:LEVel]` 

Description	Sets or queries the OCP (over-current protection) level in amps.	
Syntax	[:SOURce]:CURRent:PROTection[:LEVel] {<NR2>(A)  MINimum MAXimum}	
Query Syntax	[:SOURce]:CURRent:PROTection[:LEVel]?	
Parameter	<NR2>	Current protection level. Minimum: Depend on the unit type: if Irated * 0.1 > 5A, then minimum = 5A, else minimum = Irated * 0.1 Maximum: Irated * 1.1
	MIN	Minimum current level.
	MAX	Maximum current level.
Return parameter	<NR2>	Returns the current protection level.
Example	SOUR:CURR:PROT:LEV? +5.000 Returns the minimum possible current level in amps.	

`[[:SOURce]:CURRent:PROTection:TRIPped` → 

**Description** Returns the state of the current protection circuits.

**Query Syntax** `[[:SOURce]:CURRent:PROTection:TRIPped?`

**Return parameter** `<bool>` Returns protection status.

**Example** `SOUR:CURR:PROT:TRIP?`  
`>0`  
 The protection circuit has not been tripped.



`[[:SOURce]:CURRent:SLEWrate:RISing` → 

**Description** Sets or queries the rising current slew rate. This is only applicable for CC slew rate priority mode.

**Syntax** `[[:SOURce]:CURRent:SLEWrate:RISing`  
`{<NR2>(A)|MINimum|MAXimum}`

**Query Syntax** `[[:SOURce]:CURRent:SLEWrate:RISing?`

**Parameter**

<code>&lt;NR2&gt;</code>	Per step is between 0.001A/msec and rated current divided by 100 msec.
<code>MIN</code>	Minimum rising current slew rate is 0.001A/msec.
<code>MAX</code>	Maximum rising current slew rate is rated current divided by 100msec.

**Return parameter** `<NR2>` Returns the step current in amps.

**Example** `SOUR:CURR:SLEW:RIS?`  
`0.950`  
 Sets the rising current slew rate to 0.950 A/ms.



`[[:SOURce]:CURRent:SLEWrate:FALLing` → 

**Description** Sets or queries the falling current slew rate. This is only applicable for CC slew rate priority mode.

**Syntax** `[[:SOURce]:CURRent:SLEWrate:FALLing`  
`{<NR2>(A)|MINimum|MAXimum}`

Query Syntax	[:SOURce]:CURRent:SLEWrate:FALLing?	
Parameter	<NR2>	Per step is between 0.001A/msec and rated current divided by 100 msec.
	MIN	Minimum falling current slew rate is 0.001A/msec.
	MAX	Maximum falling current slew rate is rated current divided by 100msec.
Return Parameter	<NR2>	Returns the step current
Example	SOUR:CURR:SLEW:FALL MAX Sets the falling current slew rate to the maximum.	

**[:SOURce]:MODE?** → (Query)

Description	Returns the status of the output mode (CC, CV, Off) of the power supply.  The interface will return "CV" if the supply is in Constant Voltage Mode, "CC" if the supply is in Constant Current Mode or "OFF" if the supply output is off.	
Query Syntax	[:SOURce]:MODE?	
Return parameter	<string>	Returns the output state as a string, "CC", "CV", "OFF"
Example	:SOUR:MODE? >CC The power supply is currently in CC mode.	

**[:SOURce]:VOLTage[:LEVel][:IMMediate] [:AMPLitude]** (Set) →  
→ (Query)

Description	Sets or queries the voltage level in volts.	
Syntax	[:SOURce]:VOLTage[:LEVel][:IMMediate][:AMPLitude] {<NR2>(V) MINimum MAXimum}	
Query Syntax	[:SOURce]:VOLTage[:LEVel][:IMMediate][:AMPLitude]?	
Parameter	<NRf>	0~105% of the rated output voltage in volts.
	MIN	Minimum voltage level
	MAX	Maximum voltage level

Return parameter <NR2> Returns the voltage level in volts

Example SOUR:VOLT:LEV:IMM:AMPL 10  
Sets the voltage level to 10 volts.

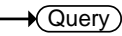
[:SOURce]:VOLTage[:LEVel]:TRIGgered   
[:AMPLitude] 

Description Sets or queries the voltage level in volts when a software trigger has been generated.

Syntax [:SOURce]:VOLTage[:LEVel]:TRIGgered[:AMPLitude] {<NR2>(V)|MINimum|MAXimum}

Query Syntax [:SOURce]:VOLTage[:LEVel]:TRIGgered[:AMPLitude]?

Parameter <NR2> 0%~105% of the rated voltage output in volts.  
MIN Minimum current level.  
MAX Maximum current level.

Return parameter <NR2> Returns the voltage level.

Example SOUR:VOLT:LEV:TRIG:AMPL 10  
Sets the voltage level to 10 volts when a software trigger is generated.

[:SOURce]:VOLTage:LIMit:AUTO   

Description Sets whether to limit the voltage setting so that it does not exceed the OVP setting or become lower than the UVL setting.

If you enable the limit when the OVP setting is lower than the voltage setting, the OVP setting will be set to 105 % of the voltage setting.

If you enable the limit when the UVL setting is higher than the voltage setting, the UVL setting will be set equal to the voltage setting.

Syntax [:SOURce]:VOLTage:LIMit:AUTO {<bool>|OFF|ON}

Query Syntax [:SOURce]:VOLTage:LIMit:AUTO?

Parameter OFF | 0 Disable the limit setting  
ON | 1 Enable the limit setting

Return parameter <bool> Returns the setting in <bool> format.

Example SOUR:VOLT:LIM:AUTO 0  
Disables the limit setting.

Set →

← Query

**[:SOURce]:VOLTage:LIMit:LOW**

Description Sets or queries the under voltage (UVL) trip point.

Syntax [:SOURce]:VOLTage:LIMit:LOW  
<NR2>(V)|MINimum|MAXimum

Query Syntax [:SOURce]:VOLTage:LIMit:LOW?

Parameter/Return <NR2> 0 ~ the present setting voltage  
MIN Minimum allowed voltage level  
MAX Maximum allowed voltage level

Example SOUR:VOLT:LIM:LOW MAX  
Sets the UV> level to its maximum.

Set →

← Query

**[:SOURce]:VOLTage:PROTection[:LEVel]**

Description Sets or queries the overvoltage protection level.

Syntax [:SOURce]:VOLTage:PROTection[:LEVel]  
{<NR2>(V)|MINimum|MAXimum}

Query Syntax [:SOURce]:VOLTage:PROTection[:LEVel]?

Parameter/Return <NR2> Minimum: Depends on the unit type:  
if Vrated \* 0.1 > 5V, then Minimum = 5V,  
else Minimum = Vrated \* 0.1  
Maximum: Vrated \* 1.1  
MIN Minimum OVP level  
MAX Maximum OVP level

Example SOUR:VOLT:PROT:LEV MAX  
Sets the OVP level to its maximum.

**[[:SOURce]:VOLTage:PROTection:TRIPped**      

Description	Sets or queries the overvoltage protection level.	
Query Syntax	[:SOURce]:VOLTage:PROTection:TRIPped?	
Return parameter	<bool>	
	0	Protection not tripped
	1	Protection tripped
Example	SOUR:VOLT:PROT:TRIP? >0 Indicates that the OVP protection has not been tripped.	

**[[:SOURce]:VOLTage:SLEWrate:RISing**       

Description	Sets or queries the rising voltage slew rate. This is only applicable for CV slew rate priority mode.	
Syntax	[:SOURce]:VOLTage:SLEWrate:RISing	
Query Syntax	{<NR2>(V) MINimum MAXimum}	
	[:SOURce]:VOLTage:SLEWrate:RISing?	
Parameter	<NR2>	Per step is between 0.001V/msec and rated voltage divided by 100msec.
	MIN	Minimum rising voltage slew rate is 0.001V/msec.
	MAX	Maximum rising voltage slew rate is rated voltage divided by 100msec.
Return parameter	<NR2>	Returns the slew rate in V/msec.
Example	SOUR:VOLT:SLEW:RIS MAX Sets the rising voltage slew rate to its maximum.	

Set →

→ Query

**[:SOURce]:VOLTage:SLEWrate:FALLing**

**Description**            Sets or queries the falling voltage slew rate. This is only applicable for CV slew rate priority mode.

**Syntax**                    [:SOURce]:VOLTage:SLEWrate:FALLing  
 {<NR2>(V)|MINimum|MAXimum}

**Query Syntax**            [:SOURce]:VOLTage:SLEWrate:FALLing?

<b>Parameter</b>	<NR2>	Per step is between 0.001V/msec and rated voltage divided by 100msec.
	MIN	Minimum falling voltage slew rate is 0.001V/msec.
	MAX	Maximum falling voltage slew rate is rated voltage divided by 100msec.

**Return parameter** <NR2>    Returns the voltage slew rate in V/msec

**Example**                    SOUR:VOLT:SLEW:FALL MIN  
 Sets the falling voltage slew rate to its minimum.



## System Function Command

:SYSTem:BEEPer[:IMMediate] .....	106
:SYSTem:CONFigure:BEEPer[:STATe] .....	106
:SYSTem:CONFigure:BLEeder[:STATe] .....	107
:SYSTem:CONFigure:CURRent:CONTRol .....	107
:SYSTem:CONFigure:VOLTagE:CONTRol .....	108
:SYSTem:CONFigure:OUTPut:PON[:STATe] .....	108
:SYSTem:CONFigure:OUTPut:EXTernal:MODE .....	109
:SYSTem:COMMunicate:ENABle .....	109
:SYSTem:COMMunicate:GPIB[:SELF]:ADDReSS .....	110
:SYSTem:COMMunicate:LAN:IPADdress .....	110
:SYSTem:COMMunicate:LAN:GATEway .....	111
:SYSTem:COMMunicate:LAN:SMASk .....	111
:SYSTem:COMMunicate:LAN:MAC .....	111
:SYSTem:COMMunicate:LAN:DHCP .....	112
:SYSTem:COMMunicate:LAN:DNS .....	112
:SYSTem:COMMunicate:RLState .....	112
:SYSTem:COMMunicate:TCPip:CONTRol .....	113
:SYSTem:COMMunicate:SERial[:RECeive]	
:TRANsmit:BAUD .....	113
:SYSTem:COMMunicate:SERial[:RECeive]	
:TRANsmit:BITS .....	114
:SYSTem:COMMunicate:SERial[:RECeive]	
:TRANsmit:PARity .....	114
:SYSTem:COMMunicate:SERial[:RECeive]	
:TRANsmit:SBITs .....	115
:SYSTem:COMMunicate:MULTidrop:CONTRol .....	115
:SYSTem:COMMunicate:USB:FRONt:STATe .....	115
:SYSTem:COMMunicate:USB:REAR:STATe .....	116
:SYSTem:ERRor .....	116
:SYSTem:KLOCK .....	116
:SYSTem:KEYLOCK:MODE .....	116
:SYSTem:ERRor:ENABle .....	117
:SYSTem:PRESet .....	117
:SYSTem:VERsion .....	117
:SYSTem:REBoot .....	117

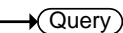
**:SYSTem:BEEPer[:IMMediate]** 

  

Description	This command causes an audible tone to be generated by the instrument. The duration time is specified in seconds.	
Syntax	:SYSTem:BEEPer[:IMMediate] {<NR1> MINimum MAXimum}	
Query Syntax	:SYSTem:BEEPer[:IMMediate]?[MINimum MAXimum]	
Parameter	<NR1>	0 ~ 3600 seconds.
	MINimum	Sets the beeper time to the minimum (0 seconds)
	MAXimum	Sets the beeper time to the maximum (3600 seconds)
Return parameter	<NR1>	Returns the remaining beeper duration time in seconds or returns the maximum or minimum beeper time in seconds (for the [MINimum   MAXimum] query parameters).

**Example 1**

```
:SYST:BEEP 10
**after a 2 second wait**
:SYST:BEEP?
>8
```

The first command turns the beeper on for 10 seconds. After 2 seconds the SYST:BEEP? query returns the remaining beeper time (8 seconds).

**Example 2**

```
:SYST:BEEP? MAX
>3600
```

Returns the maximum settable beeper time in seconds.

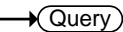
**:SYSTem:CONFigure:BEEPer[:STATe]** 

  

Description	Sets or queries the buzzer state on/off.	
Syntax	:SYSTem:CONFigure:BEEPer[:STATe] {<bool> OFF ON}	
Query Syntax	:SYSTem:CONFigure:BEEPer[:STATe]?	

Parameter	OFF   0 ON   1	Turns the buzzer off. Turns the buzzer on.
Return parameter	<bool>	Returns the buzzer status.

Set →  
 → Query

Description	Sets or queries the status of the bleeder resistor.	
Syntax	:SYSTem:CONFigure:BLEeder[:STATe]	
Query Syntax	{<NR1> OFF ON AUTO} :SYSTem:CONFigure:BLEeder[:STATe]?	
Parameter	OFF   0 ON   1 AUTO   2	Turns the bleeder resistor off. Turns the bleeder resistor on. Turn the AUTO mode on.
Return parameter	<NR1>	Returns bleeder resistor status.

Set →  
 → Query

Description	Sets or queries the CC control mode (local control (panel), external voltage control, external resistance control). This setting is applied only after the unit is reset.	
Syntax	:SYSTem:CONFigure:CURRent:CONTRol { <NR1> NONE VOLTage RRISing RFALLing}	
Query Syntax	:SYSTem:CONFigure:CURRent:CONTRol?	
Parameter	<NR1> 0   NONE 1   VOLTage 2   RRISing 3   RFALLing	Description Local (Panel) control External voltage control External resistance control; 10kΩ = Io max*, 0kΩ = Io min. External resistance control; 10kΩ = Io min*, 0kΩ = Io max.
Return Parameter	<NR1>	Returns the current control configuration.

:SYSTem:CONFIgure:VOLTage:CONTRol (Set) →  
→ (Query)

**Description** Sets or queries the CV control mode (local control (panel), external voltage control, external resistance control). This setting is applied only after the unit is reset.

**Syntax** :SYSTem:CONFIgure:VOLTage:CONTRol  
{ <NR1>|NONE|VOLTage|RRISing|RFALLing}

**Query Syntax** :SYSTem:CONFIgure:VOLTage:CONTRol?

Parameter	<NR1>	Description
	0   NONE	Local (Panel) control
	1   VOLTage	External voltage control
	2   RRISing	External resistance control; 10kΩ or 5kΩ = I <sub>o</sub> max*, 0kΩ = I <sub>o</sub> min.
	3   RFALLing	External resistance control; 10kΩ or 5kΩ = I <sub>o</sub> min*, 0kΩ = I <sub>o</sub> max.

**Return Parameter** <NR1> Returns the current control configuration.

:SYSTem:CONFIgure:OUTPut:PON[:STATe] (Set) →  
→ (Query)

**Description** Sets the output state at power-on. This is the equivalent to the F-92 (Output Status when Power ON) power on configuration settings. These settings only apply after the unit has been reset.

**Syntax** :SYSTem:CONFIgure:OUTPut:PON[:STATe]  
{<NR1>|{SAFE|OFF}}|{FORCe|ON}|AUTO}

**Return Syntax** :SYSTem:CONFIgure:OUTPut:PON[:STATe]?

Parameter	SAFE   OFF   0	The PFR-100 turns on in the same state the unit was in prior to the previous shut down. The output is set to off (default).
	FORCe   ON   1	The PFR-100 turns on in the same state the unit was in prior to the previous shut down. The output is set to on.

	AUTO   2	The PFR-100 turns on in the same state the unit was in prior to the previous shut down, but with the same output on/off setting.
Return parameter	0	The power on output setting is "SAFE" or "OFF".
	1	The power on output setting is "FORCe" or "ON".
	2	The power on output setting is "AUTO".

**:SYSTem:CONFigure:OUTPut:EXTernal:MODE** 
 →  
 →

Description	Sets the logic used to turn the output on or off when using an external contact. This is the equivalent to the F-94 (External Output Logic Control) power on configuration settings.  This setting is only applied after the unit has been reset.	
Syntax	:SYSTem:CONFigure:OUTPut:EXTernal:MODE	
Return Syntax	{<NR1> LOW HIGH DISABLE} :SYSTem:CONFigure:OUTPut:EXTernal:MODE?	
Parameter	HIGH   0	Active high
	LOW   1	Active low
	DISable   2	External control is not performed.
Return Parameter	<NR1>	Returns external mode of the instrument.

**:SYSTem:COMMunicate:ENABLE** 
 →  
 →

Description	Enables/Disables GPIB, USB or other remote interfaces such as Sockets and the Web Server.  This setting is only applied after the unit has been reset. Only one interface can be enabled at the same time.	
Syntax	:SYSTem:COMMunicate:ENABLE{<bool>  OFF ON,RS232 RS485 USBCDC GPIB SOCKets WEB}	



Syntax	:SYSTem:COMMunicate:LAN:IPADdress <string>
Query Syntax	:SYSTem:COMMunicate:LAN:IPADdress?
Parameter/Return	<string> LAN IP address in string format ("address") Applicable ASCII characters: 20H to 7EH
Example	SYST:COMM:LAN:IPAD "172.16.5.111" Sets the IP address to 172.16.5.111.

Set →  
 → Query

**Description** Sets or queries the Gateway address. Note: the setting will only be valid after the power has been cycled.

Syntax	:SYSTem:COMMunicate:LAN:GATEway <string>
Query Syntax	:SYSTem:COMMunicate:LAN:GATEway?
Parameter/Return	<string> Gateway address in string format ("address") Applicable ASCII characters: 20H to 7EH
Example	SYST:COMM:LAN:GATE "172.16.0.254" Sets the LAN gateway to 172.16.0.254.

Set →  
 → Query

**Description** Sets or queries the LAN subnet mask. Note: the setting will only be valid after the power has been cycled.

Syntax	:SYSTem:COMMunicate:LAN:SMASk <string>
Query Syntax	:SYSTem:COMMunicate:LAN:SMASk?
Parameter/Return	<string> Subnet mask in string format ("mask") Applicable ASCII characters: 20H to 7EH
Example	SYST:COMM:LAN:SMASk "255.255.0.0" Sets the LAN mask to 255.255.0.0.

→ Query

**Description** Returns the unit MAC address as a string. The MAC address cannot be changed.

Query Syntax	:SYSTem:COMMunicate:LAN:MAC?
--------------	------------------------------

Return parameter <string> Returns the MAC address in the following format "FF-FF-FF-FF-FF-FF"

Example SYST:COMM:LAN:MAC?  
02-80-AD-20-31-B1  
Returns the MAC address.

Set →

→ Query

**:SYSTem:COMMunicate:LAN:DHCP**

Description Turns DHCP on/off. Queries the DHCP status. Note: the setting will only be valid after the power has been cycled.

Syntax :SYSTem:COMMunicate:LAN:DHCP  
{<bool>|OFF|ON}

Query Syntax :SYSTem:COMMunicate:LAN:DHCP?

Parameter OFF | 0 DHCP off  
ON | 1 DHCP on

Return parameter <bool> Returns the DHCP status.

Set →

→ Query

**:SYSTem:COMMunicate:LAN:DNS**

Description Sets or queries the DNS address. Note: the setting will only be valid after the power has been cycled.

Syntax :SYSTem:COMMunicate:LAN:DNS <string>

Query Syntax :SYSTem:COMMunicate:LAN:DNS?

Parameter/Return <string> DNS in string format ("mask")  
Applicable ASCII characters: 20H to 7EH

Example SYST:COMM:LAN:DNS "172.16.1.252"  
Sets the DNS to 172.16.1.252.

Set →

→ Query

**:SYSTem:COMMunicate:RLState**

Description Enables or disables local/remote state of the instrument.

Syntax :SYSTem:COMMunicate:RLState  
{LOCAL|REMOTE|RWLock}

Query Syntax :SYSTem:COMMunicate:RLState?



Parameter/Return parameter	LOCAL	All keys are valid. This instrument is controlled by the front panel controls.
	REMOte	All keys are invalid, except for the [local] key and the ability to turn the output off.
	RWLock	All keys are invalid. The instrument can only be controlled remotely.

Example :SYST:COMM:RLST LOCAL  
Sets the operating mode to local.

**:SYSTem:COMMunicate:TCPip:CONTRol** → Query

Description Queries the socket port number.

Query Syntax :SYSTem:COMMunicate:TCPip:CONTRol?

Return parameter <NR1> 0000 ~ 9999

Example SYST:COMM:TCP:CONT?  
>2268  
Returns the socket port number.

**:SYSTem:COMMunicate:SERial[:RECEive]** Set →  
**:TRANsmit:BAUD** → Query



Description Sets or queries the UART baud rate. Note: the setting will only be valid after the power has been cycled.

Syntax :SYSTem:COMMunicate:SERial[:RECEive]:TRANsmit

Query Syntax :BAUD <NR1>  
:SYSTem:COMMunicate:SERial[:RECEive]:TRANsmit  
:BAUD?

Parameter/Return <NR1> 2400, 4800, 9600, 19200, 38400, 57600,  
115200

Example SYST:COMM:SER:TRAN:BAUD?  
>2400  
Returns the baud rate settings.

`:SYSTem:COMMunicate:SERial[:RECEive]`    
`:TRANsmit:BITS` 

**Description** Sets or queries the UART number of data bits.  
 Note: the setting will only be valid after the power has been cycled.



**Syntax** `:SYSTem:COMMunicate:SERial[:RECEive]:TRANsmit`  
`:BITS <NR1>`

**Query Syntax** `:SYSTem:COMMunicate:SERial[:RECEive]:TRANsmit`  
`:BITS?`

**Parameter/Return parameter**

<NR1>	
0	7 bits
1	8 bits

**Example** `SYST:COMM:SER:TRAN:BITS?`  
`>1`  
 Indicates that 8 data bits are used for the UART connection.

`:SYSTem:COMMunicate:SERial[:RECEive]`    
`:TRANsmit:PARity` 

**Description** Sets or queries the parity of the UART connection.  
 Note: the setting will only be valid after the power has been cycled.

**Syntax** `:SYSTem:COMMunicate:SERial[:RECEive]:TRANsmit`  
`:PARity <NR1>`

**Query Syntax** `:SYSTem:COMMunicate:SERial[:RECEive]:TRANsmit`  
`:PARity?`

**Parameter/Return parameter**

0	None
1	Odd
2	Even

**Example** `SYST:COMM:SER:TRAN:PARity?`  
`>1`  
 Indicates that odd parity is used for the UART connection.

**:SYSTem:COMMunicate:SERial[:RECeive]**      **Set** →  
**:TRANsmit:SBITs**      → **Query**

Description	Sets or queries the number of stop bits used for the UART connection. Note: the setting will only be valid after the power has been cycled.	
Syntax	:SYSTem:COMMunicate:SERial[:RECeive]:TRANsmit	
Query Syntax	:SBITs<NR1> :SYSTem:COMMunicate:SERial[:RECeive]:TRANsmit :SBITs?	
Parameter/Return parameter	0	1 stop bit
	1	2 stop bits
Example	SYST:COMM:SER:TRAN:SBITs? >1 Indicates that one stop bit is used for the UART connection.	

**:SYSTem:COMMunicate:MULTidrop**  
**:CONTrol**      → **Query**

Description	Queries the Multi-Drop Control state.	
Query Syntax	SYST:COMM:MULT:CONT?	
Return parameter	0	<NR1>Disable
	1	<NR1>Master
	2	<NR1>Slave

**:SYSTem:COMMunicate:USB:FRONT:STATe**      → **Query**

Description	Queries the front panel USB-A port state.	
Query Syntax	:SYSTem:COMMunicate:USB:FRONT:STATe?	
Return parameter	0	<NR1>Absent
	1	<NR1>Mass Storage

**:SYSTem:COMMunicate:USB:REAR:STATe** → **Query**

Description	Queries the rear panel USB-B port state.	
Query Syntax	:SYSTem:COMMunicate:USB:REAR:STATe?	
Return parameter	0	<NR1>Absent
	1	<NR1>Connected to the PC

**:SYSTem:ERRor** → **Query**

Description	Queries the error queue. The last error message is returned. A maximum of 32 errors are stored in the error queue.	
Query Syntax	:SYSTem:ERRor?	
Return parameter	<string>	Returns an error code followed by an error message as a single string.
Example	SYSTem:ERRor? -100, "Command error"	

**Set** →

**:SYSTem:KLOCK** → **Query**

Description	Enables or disables the front panel key lock.	
Syntax	:SYSTem:KLOCK {<bool> OFF ON }	
Query Syntax	:SYSTem:KLOCK?	
Parameter	OFF   0	Panel keys unlocked
	ON   1	Panel keys locked
Return parameter	<bool>	Returns the key lock status.

**Set** →

**:SYSTem:KEYLock:MODE** → **Query**

Description	Sets or queries the keylock mode. This setting is the equivalent to the F-19 function setting.	
Syntax	:SYSTem:KEYLock {<bool> OFF ON}	
Query Syntax	:SYSTem:KEYLock?	

Parameter/Return	0   OFF	Panel lock: allow output off.
parameter	1   ON	Panel lock: allow output on/off.

**:SYSTem:ERRor:ENABle** (Set) →

Description      Clears the Error Queue and enables all error messages to be placed in the System Error Queue.

Syntax              :SYSTem:ERRor:ENABle

**:SYSTem:PRESet** (Set) →

Description      Loads the default settings.

Syntax              :SYSTem:PRESet

**:SYSTem:VERSion** → (Query)

Description      Returns the version of the PFR-100 SCPI version.

Query Syntax      :SYSTem:VERSion?

Return              <string> Returns the SCPI version as a string.

Query Example    SYST:VERS?  
>1999.9

**:SYSTem:REBoot** (Set) →

Description      Reboots the PFR-100 system.

Syntax              :SYSTem:REBoot

## Trigger Commands

:TRIGger:OUTPut:SOURce .....	118
:TRIGger:OUTPut[:IMMediate] .....	118
:TRIGger[:TRANsient]:SOURce .....	118
:TRIGger[:TRANsient][:IMMediate] .....	119
Trigger Command Examples .....	119

### :TRIGger:OUTPut:SOURce

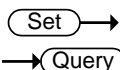

Description	Sets or queries the trigger source of the output trigger.
Syntax	:TRIGger:OUTPut:SOURce {BUS IMMediate EXTernal}
Query Syntax	:TRIGger:OUTPut:SOURce?
Parameter/ Return parameter	BUS Output trigger is generated by the bus. IMMediate Output trigger is immediately generated.
Example	:TRIGger:OUTPut:SOURce? Sets the output trigger source to EXT.

### :TRIGger:OUTPut[:IMMediate]



Description	Generates an immediate trigger for the output trigger system.
Syntax	:TRIGger:OUTPut[:IMMediate]
Example	:TRIG:OUTP

### :TRIGger[:TRANsient]:SOURce

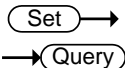

Description	Sets or queries the source of the transient trigger.
Syntax	:TRIGger[:TRANsient]:SOURce {BUS IMMediate EXTernal}
Query Syntax	:TRIGger[:TRANsient]:SOURce?

Parameter/ Return parameter	BUS IMMEDIATE	Transient trigger is generated by the bus. Transient trigger is immediately generated.
Example	:TRIG:SOUR? EXT Sets the transient trigger source to EXT.	

**:TRIGger[:TRANsient][:IMMEDIATE]** Set →

Description	Generates an immediate trigger for the transient trigger system.
Syntax	:TRIGger[:TRANsient][:IMMEDIATE]
Example	:TRIG

**Trigger Command Examples**

1. The transient system for the trigger in immediate mode.

Example 1	TRIG:TRAN:SOUR IMM CURR:TRIG MAX VOLT:TRIG 5 INIT:NAME TRAN	<==The current changes to the maximum, and the voltage changes to 5V.
-----------	--	---

2. The transient system for the trigger in BUS mode.

Example 2	TRIG:TRAN:SOUR BUS CURR:TRIG MAX VOLT:TRIG 5 INIT:NAME TRAN TRIG:TRAN (or *TRG)	<==The current changes to the maximum, and the voltage changes to 5V.
-----------	---	---





## IEEE 488.2 Common Commands

*CLS .....	121
*ESE .....	121
*ESR .....	122
*IDN .....	122
*OPC .....	122
*RCL .....	123
*RST .....	123
*SAV .....	123
*SRE .....	123
*STB .....	124
*TRG .....	124
*TST .....	124
*WAI .....	124

### \*CLS



**Description**      The \*CLS command clears all the event registers, including the status byte, event status and error queue.

**Syntax**            \*CLS



### \*ESE

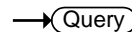

**Description**      Sets or queries the Standard Event Status Enable register.

**Syntax**            \*ESE <NR1>

**Query Syntax**    \*ESE?

**Parameter**       <NR1>    0~255

**Return parameter** <NR1>    Returns the bit sum of the Standard Event Status Enable register.

**\*ESR** → Query

**Description**      Queries the Standard Event Status (Event) register. The Event Status register is cleared after it is read.

**Query Syntax**      \*ESR?

**Return parameter** <NR1> Returns the bit sum of the Standard Event Status (Event) register and clears the register.

**\*IDN** → Query

**Description**      Queries the manufacturer, model name, serial number, and firmware version of the PFR-100.

**Query Syntax**      \*IDN?

**Return parameter** <string> Returns the instrument identification as a string in the following format:  
 GW-INSTEK,PFR-100L,TW123456,01.00.20110101  
 Manufacturer: GW-INSTEK  
 Model number : PFR-100L  
 Serial number : TW123456  
 Firmware version : 01.00.20110101

Set →

**\*OPC** → Query

**Description**      The \*OPC command sets the OPC bit (bit0) of the Standard Event Status Register when all current commands have been processed.  
 The \*OPC? Query returns 1 when all the outstanding commands have completed.

**Syntax**              \*OPC

**Query Syntax**      \*OPC?

**Return parameter** 1 Returns 1 when all the outstanding commands have completed.

**\*RCL**

Set →

**Description** Recalls the contents stored in memory slot M1, M2 or M3.

**Syntax** \*RCL {<NR1>|MAX|MIN}

<b>Parameter</b>	<NR1>	0, 1, 2 (as memory M1 , M2, M3)
	MIN	Recalls the M1 memory contents.
	MAX	Recalls the M3 memory contents.

**\*RST**

Set →

**Description** Performs a device reset. Configures the unit to a known configuration (default settings). This known configuration is independent of the usage history.

**Syntax** \*RST

**\*SAV**

Set →

**Description** Saves the settings into memory slot M1, M2 or M3.

**Syntax** \*SAV {<NR1>|MIN|MAX}

<b>Return parameter</b>	<NR1>	0, 1, 2 (as memory M1 , M2, M3)
	MIN	Saves the M1 memory contents.
	MAX	Saves the M3 memory contents.

**\*SRE**

Set →

→ Query

**Description** Sets or queries the Service Request Enable register. The Service Request Enable register determines which registers of the Status Byte register are able to generate service requests.

**Syntax** \*SRE <NR1>

**Query Syntax** \*SRE?

**Parameter** <NR1> 0~255

Return parameter <NR1> Returns the bit sum of the Service Request Enable register.

**\*STB**

→ Query

Description Queries the bit sum of the Status Byte register with MSS (Master summary Status) replacing the RQS bit (bit 6).

Query Syntax \*STB?

Return parameter <NR1> Returns the bit sum of the Status Byte register with the MSS bit (bit 6).

**\*TRG**

Set →

Description The \*TRG command is able to generate a “get” (Group Execute Trigger). If the PFR-100 cannot accept a trigger at the time of the command, an error message is generated (-211, “Trigger ignored”).

Syntax \*TRG

**\*TST**

→ Query

Description Executes a self test.

Query Syntax \*TST?

Return parameter 0 Returns “0” if there are no errors.

<NR1> Returns an error code <NR1> if there is an error.

**\*WAI**

Set →

Description Prevents any other commands or queries from being executed until all outstanding commands have completed.

Syntax \*WAI

## Status Register Overview

To program the PFR-100 power supply effectively, the Status registers need to be understood. This chapter explains in detail how the Status registers are used and how to configure them.

---

Introduction to the Status Registers .....	125
The Status Registers.....	127
Questionable Status Register Group .....	128
Operation Status Register Group.....	132
Standard Event Status Register Group .....	134
Status Byte Register & Service Request Enable Register.....	136

## Introduction to the Status Registers

---

### Overview

The status registers are used to determine the status of the power supply. The status registers maintain the status of the protection conditions, operation conditions and instrument errors.

The PFR-100 Series have a number of register groups:

Questionable Status Register Group

Standard Event Status Register Group

Operation Status Register Group

Status Byte Register

Service Request Enable Register

Service Request Generation

Error Queue

Output Buffer

The next page shows the structure of the Status registers.

# The Status Registers

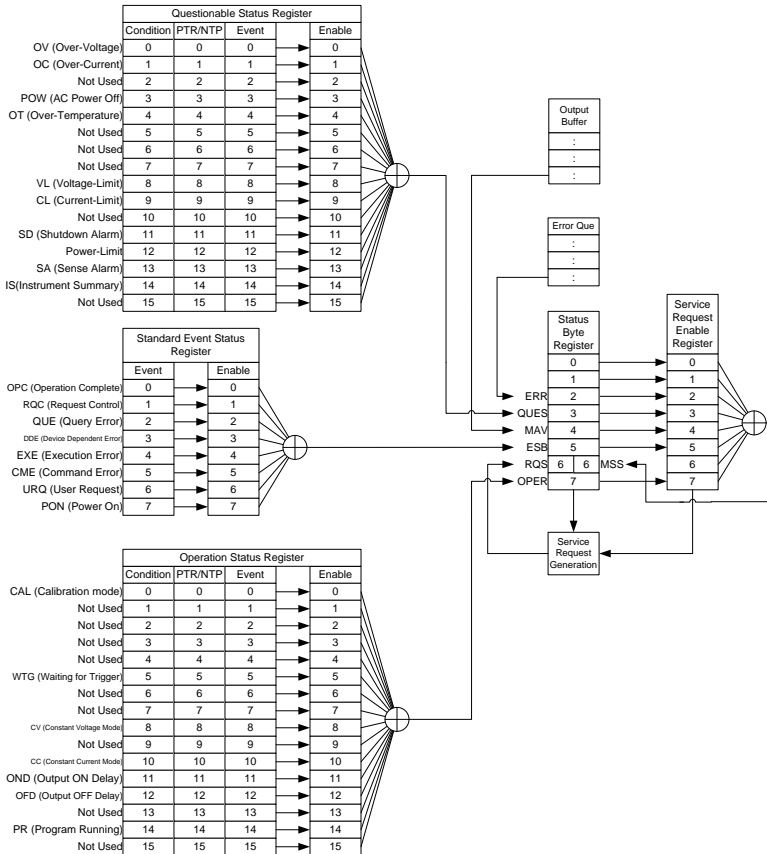

## Questionable Status Register Group

### Overview

The Questionable Status Register Group indicates if any protection modes or limits have been tripped.

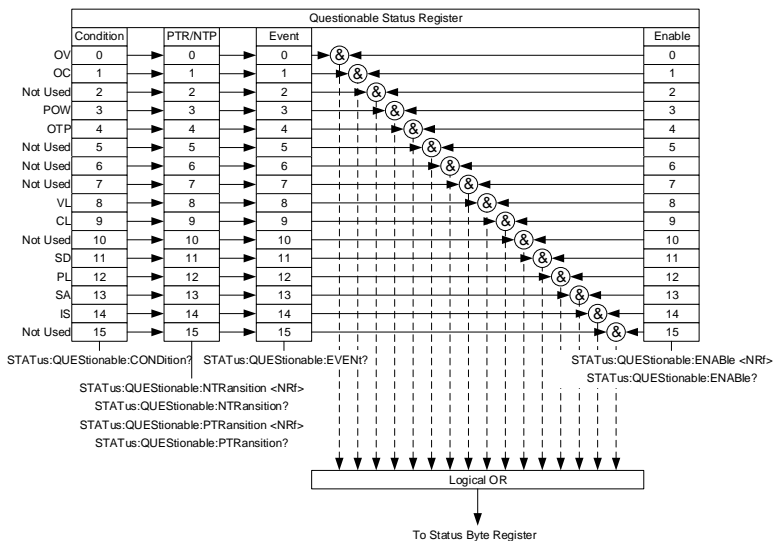

### Bit Summary

Event	Bit #	Bit Weight
OV (Over-Voltage) Over voltage protection has been tripped	0	1
OC (Over-Current) Over current protection has been tripped	1	2
POW (AC Power Off) AC power switch is off	3	8



OTP(Over Temperature Protection)	4	16
Over temperature protection has been tripped		
VL (Voltage Limit)	8	256
Voltage limit has been reached		
CL (Current Limit)	9	512
Current limit has been reached		
SD (Shutdown Alarm)	11	2048
PL (Power-Limit)	12	4096
SA (Sense Alarm)	13	8192
IS (Instrument Summary)	14	16384

**Condition Register**      The Questionable Status Condition Register indicates the status of the power supply. If a bit is set in the Condition register, it indicates that the event is true. Reading the condition register does not change the state of the condition register.

**PTR/NTR Filters**      The PTR/NTR (Positive/Negative transition) register determines the type of transition conditions that will set the corresponding bit in the Event Registers. Use the Positive transition filter to view events that change from false to positive, and use the negative transition filter to view events that change from positive to negative.

Positive Transition	0→1
---------------------	-----

Negative Transition	1→0
---------------------	-----

**Event Register**      The PTR/NTR Register will dictate the type of transition conditions will set the corresponding bits in the Event Register. If the Event Register is read, it will be cleared to 0.

Enable Register    The Enable register determines which Events in the Event Register will be used to set the QUES bit in the Status Byte Register.

---

**Instrument Summary Registers**

The Instrument Summary Registers indicate if the protection mode or limit of any of the instruments connected in Multi-Drop mode has been tripped.

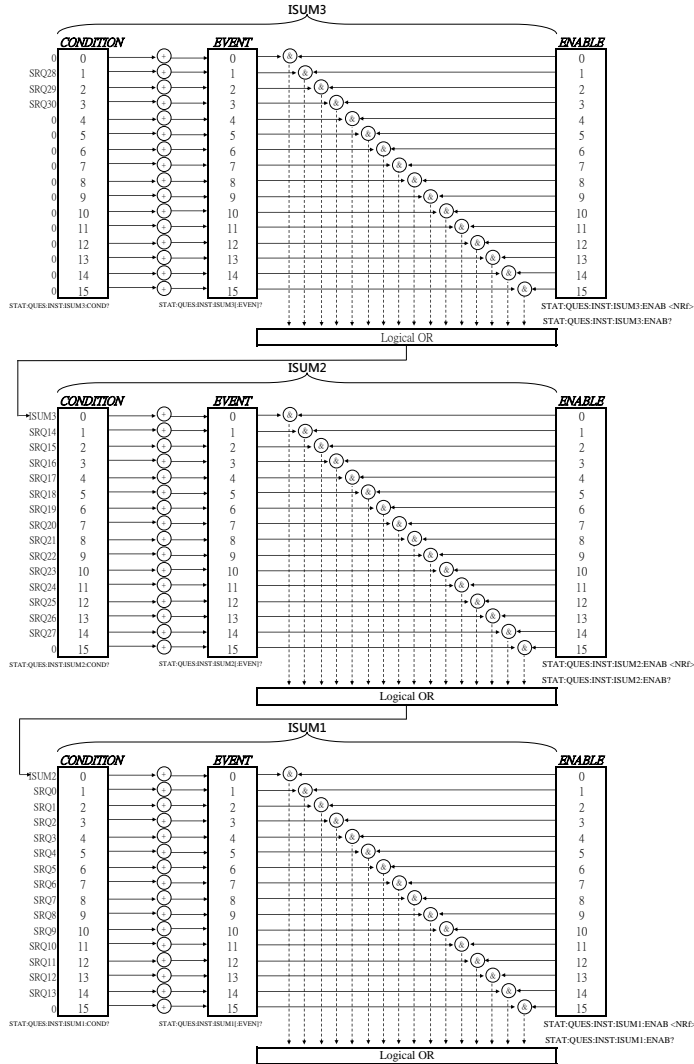

To Instrument Summary in Questionable Condition register (bit 14)

## Operation Status Register Group

### Overview

The Operation Status Register Group indicates the operating status of the power supply.

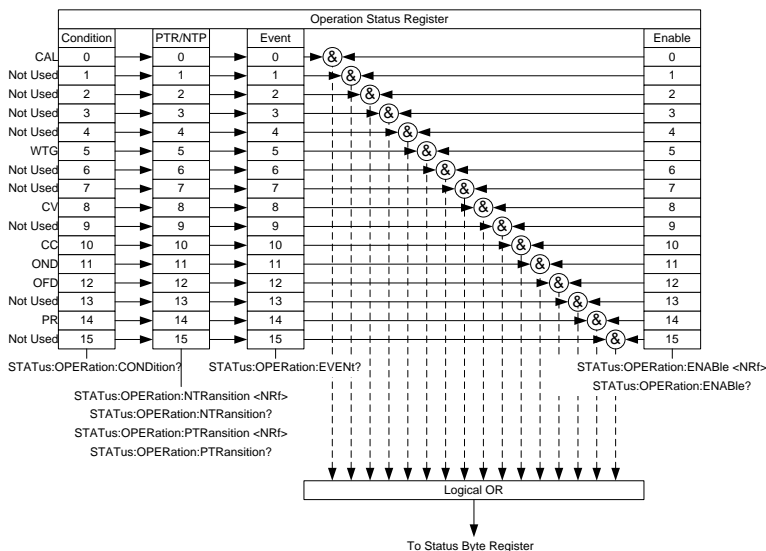

### Bit Summary

Event	Bit #	Bit Weight
CAL (Calibration mode)	0	1
Indicates if the PFR-100 is in calibration mode.		
WTG (Waiting for trigger)	5	32
Indicates if the PFR-100 is waiting for a trigger.		
CV (Constant voltage mode)	8	256
Indicates if the PFR-100 is in CV mode.		
CC (Constant current mode)	10	1024
Indicates if the PFR-100 is in CC mode.		

OND (Output ON Delay)	11	2048
-----------------------	----	------

Indicates if Output ON delay time is active

OFD (Output OFF Delay)	12	4096
------------------------	----	------

Indicates if Output OFF delay time is active

PR (Program Running)	14	16384
----------------------	----	-------

Indicates if a Test is running

Condition Register	The Operation Status Condition Register indicates the operating status of the power supply. If a bit is set in the Condition register, it indicates that the event is true. Reading the condition register does not change the state of the condition register.
--------------------	---

PTR/NTR Filters	The PTR/NTR (Positive/Negative transition) register determines the type of transition conditions that will set the corresponding bit in the Event Registers. Use the Positive transition filter to view events that change from false to positive, and use the negative transition filter to view events that change from positive to negative.
-----------------	---

Positive Transition	0→1
---------------------	-----

Negative Transition	1→0
---------------------	-----

Event Register	The PTR/NTR Register will dictate the type of transition conditions will set the corresponding bits in the Event Register. If the Event Register is read, it will be cleared to 0.
----------------	--

Enable Register	The Enable register determines which registered Events in the Event Register will be used to set the OPER bit in the Status Byte Register.
-----------------	--

## Standard Event Status Register Group

### Overview

The Standard Event Status Register Group indicates if any errors have occurred. The bits of the Event register are set by the error event queue.

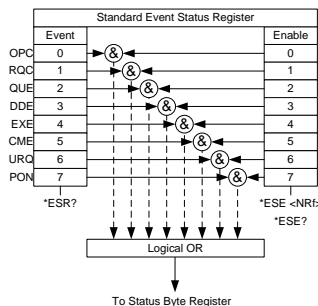

Bit Summary	Event	Bit #	Bit Weight
	OPC (Operation complete)	0	1
	The OCP bit is set when all selected pending operations are complete. This bit is set in response to the *OPC command.		
	RQC (Request control)	1	2
	QUE (Query Error)	2	4
	The Query Error bit is set in response to an error reading the Output Queue. This can be caused by trying to read the Output Queue when there is no data present.		
	DDE (Device Dependent Error)	3	8
	Device specific error.		

	EXE (Execution Error)	4	16
	The EXE bit indicates an execution error due to one of the following: illegal command parameter, parameter out of range, invalid parameter, the command didn't execute due to an overriding operation condition.		
	CME (Command Error)	5	32
	The CME bit is set when a syntax error has occurred. The CME bit can also be set when a <GET> command is received within a program message.		
	URQ (User Request)	6	64
	PON (Power On)	7	128
	Indicates the power is turned on.		
Event Register	Any bits set in the event register indicate that an error has occurred. Reading the Event register will reset the register to 0.		
Enable Register	The Enable register determines which Events in the Event Register will be used to set the ESB bit in the Status Byte Register.		

## Status Byte Register & Service Request Enable Register

### Overview

The Status Byte register consolidates the status events of all the status registers. The Status Byte register can be read with the \*STB? query and can be cleared with the \*CLS command.

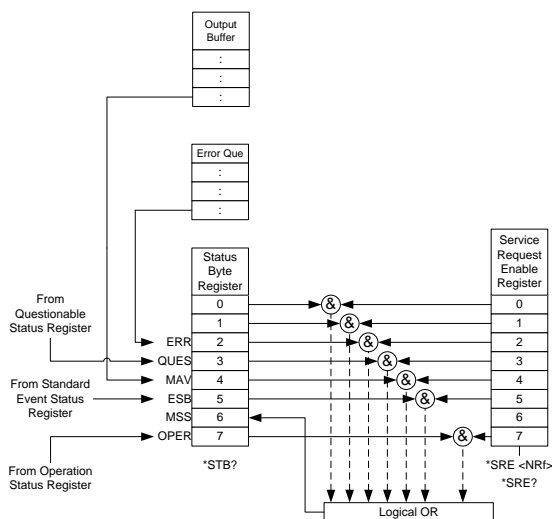

### Bit Summary

Event	Bit #	Bit Weight
ERR (Error Event/Queue)	2	4
If data is present in the Error queue, the ERR bit will be set.		
QUES (Questionable Status Register)	3	8
The summary bit for the Questionable Status Register group.		
MAV (Message Available)	4	16
This is set when there is data in the Output Queue waiting to be read.		



	(ESB) Event Summary Bit. The ESB is the summary bit for the Standard Event Status Register group.	5	32
	MSS Bit The MSS Bit is the summary of the Status Byte Register and Service Request register (bits 1-5, 7). This will be set to 1.	6	64
	OPER (Operation Status Register) Group. OPER bit is the summary bit for the Operation Status Register Group.	7	128
Status Byte Register	Any bits set in the Status byte register acts as a summary register for all the three other status registers and indicates if there is a service request, an error in the Error Queue or data in the Output Queue. Reading the Status Byte register will reset the register to 0.		
Service Request Enable Register	The Service Request Enable Register controls which bits in the Status Byte Register are able to generate service requests.		

## Error List

---

Command Errors .....	138
Execution Errors .....	142
Device Specific Errors.....	144
Query Errors .....	145

### Command Errors

---

**Overview** An <error/event number> in the range [ -199 , -100 ] indicates that an IEEE 488.2 syntax error has been detected by the instrument's parser. The occurrence of any error in this class shall cause the command error bit (bit 5) in the event status register (IEEE 488.2, section 11.5.1) to be set. One of the following events has occurred:

An IEEE 488.2 syntax error has been detected by the parser. That is, a controller-to-device message was received which is in violation of the IEEE 488.2 standard. Possible violations include a data element which violates the device listening formats or whose type is unacceptable to the device.

An unrecognized header was received. Unrecognized headers include incorrect device-specific headers and incorrect or unimplemented IEEE 488.2 common commands.

Events that generate command errors shall not generate execution errors, device-specific errors, or query errors; see the other error definitions in this chapter.

---

Error Code	Description
-100 Command Error	This is the generic syntax error for devices that cannot detect more specific errors. This code indicates only that a Command Error as defined in IEEE 488.2,11.5.1.1.4 has occurred.
-102 Syntax error	An unrecognized command or data type was encountered; for example, a string was received when the device does not accept strings.
-103 Invalid separator	The parser was expecting a separator and encountered an illegal character; for example, the semicolon was omitted after a program message unit, MEAS:VOLT:DC?:MEASCURR:DC?
-104 Data type error	The parser recognized a data element different than one allowed; for example, numeric or string data was expected but block data was encountered.
-108 Parameter not allowed	More parameters were received than expected for the header; for example, the KLOCK command only accepts one parameter, so receiving SYSTem:KLOCK 1,0 is not allowed.
-109 Missing parameter	Fewer parameters were received than required for the header; for example, the KLOCK command requires one parameter, so receiving KLOCK is not allowed.
-111 Header separator error	A character which is not a legal header separator was encountered while parsing the header; for example, no white space followed the header, thus *SRE2 is an error.
-112 Program mnemonic too long	The header contains more than twelve characters (see IEEE 488.2, 7.6.1.4.1).

- 113 Undefined header      The header is syntactically correct, but it is undefined for this specific device; for example, \*XYZ is not defined for any device.
- 114 Header suffix out of range      The value of a numeric suffix attached to a program mnemonic, see Syntax and Style section 6.2.5.2, makes the header invalid.
- 115 Unexpected number of parameters      The number of parameters received does not correspond to the number of parameters expected. This is typically due an inconsistency with the number of instruments in the selected group.
- 120 Numeric data error      This error, as well as errors -121 through -129, are generated when parsing a data element which appears to be numeric, including the nondecimal numeric types. This particular error message should be used if the device cannot detect a more specific error.
- 121 Invalid character in number      An invalid character for the data type being parsed was encountered; for example, an alpha in a decimal numeric or a "9" in octal data.
- 128 Numeric data not allowed      A legal numeric data element was received, but the device does not accept one in this position for the header.
- 131 Invalid suffix      The suffix does not follow the syntax described in IEEE 488.2, 7.7.3.2, or the suffix is inappropriate for this device.
- 141 Invalid character data      Either the character data element contains an invalid character or the particular element received is not valid for the header.
- 148 Character data not allowed      A legal character data element was encountered where prohibited by the device.

- 151 Invalid string data A string data element was expected, but was invalid for some reason (see IEEE 488.2, 7.7.5.2); for example, an END message was received before the terminal quote character.
- 158 String data not allowed A string data element was encountered but was not allowed by the device at this point in parsing.
- 160 Block data error This error, as well as errors -161 through -169, are generated when parsing a block data element. This particular error message should be used if the device cannot detect a more specific error.
- 161 Invalid block data A block data element was expected, but was invalid for some reason (see IEEE 488.2, 7.7.6.2); for example, an END message was received before the length was satisfied.
- 168 Block data not allowed A legal block data element was encountered but was not allowed by the device at this point in parsing.
- 178 Expression data not allowed A legal expression data was encountered but was not allowed by the device at this point in parsing.

## Execution Errors

---

**Overview** An <error/event number> in the range [ -299 , -200 ] indicates that an error has been detected by the instrument's execution control block. The occurrence of any error in this class shall cause the execution error bit (bit 4) in the event status register (IEEE 488.2, section 11.5.1) to be set. One of the following events has occurred:

A <PROGRAM DATA> element following a header was evaluated by the device as outside of its legal input range or is otherwise inconsistent with the device's capabilities.

A valid program message could not be properly executed due to some device condition.

Execution errors shall be reported by the device after rounding and expression evaluation operations have taken place. Rounding a numeric data element, for example, shall not be reported as an execution error. Events that generate execution errors shall not generate Command Errors, device-specific errors, or Query Errors; see the other error definitions in this section.

Error Code	Description
-200 Execution error	This is the generic syntax error for devices that cannot detect more specific errors. This code indicates only that an Execution Error as defined in IEEE 488.2, 11.5.1.1.5 has occurred.

- 201 Invalid while in local Indicates that a command is not executable while the device is in local due to a hard local control (see IEEE 488.2, 5.6.1.5); for example, a device with a rotary switch receives a message which would change the switches state, but the device is in local so the message cannot be executed.
- 203 Command protected Indicates that a legal password-protected program command or query could not be executed because the command was disabled.
- 211 Trigger ignored Indicates that a GET, \*TRG, or triggering signal was received and recognized by the device but was ignored because of device timing considerations; for example, the device was not ready to respond. Note: a DT0 device always ignores GET and treats \*TRG as a Command Error.
- 213 Init ignored Indicates that a request for a measurement initiation was ignored as another measurement was already in progress.
- 220 Parameter error Indicates that a program data element related error occurred. This error message should be used when the device cannot detect the more specific errors described for errors -221 through -229.
- 221 Settings conflict Indicates that a legal program data element was parsed but could not be executed due to the current device state (see IEEE 488.2, 6.4.5.3 and 11.5.1.1.5.).
- 222 Data out of range Indicates that a legal program data element was parsed but could not be executed because the interpreted value was outside the legal range as defined by the device (see IEEE 488.2, 11.5.1.1.5.).
- 224 Illegal parameter value Used where exact value, from a list of possibles, was expected.

## Device Specific Errors

---

**Overview** An <error/event number> in the range [ -399 , -300 ] or [ 1 , 32767 ] indicates that the instrument has detected an error which is not a command error, a query error, or an execution error; some device operations did not properly complete, possibly due to an abnormal hardware or firmware condition. These codes are also used for self-test response errors. The occurrence of any error in this class should cause the device-specific error bit (bit 3) in the event status register (IEEE 488.2, section 11.5.1) to be set. The meaning of positive error codes is device-dependent and may be enumerated or bit mapped; the <error message>string for positive error codes is not defined by SCPI and available to the device designer.

Note that the string is not optional; if the designer does not wish to implement a string for a particular error, the null string should be sent (for example, 42,""). The occurrence of any error in this class should cause the device-specific error bit (bit 3) in the event status register (IEEE 488.2, section 11.5.1) to be set. Events that generate device-specific errors shall not generate command errors, execution errors, or query errors; see the other error definitions in this section.

Error Code	Description
-310 System error	Indicates that some error, termed "system error" by the device, has occurred. This code is device-dependent.
-320 Storage fault	Indicates that the firmware detected a fault when using data storage. This error is not an indication of physical damage or failure of any mass storage element.



## Query Errors

---

**Overview** An <error/event number> in the range [ -499 , -400 ] indicates that the output queue control of the instrument has detected a problem with the message exchange protocol described in IEEE 488.2, chapter 6. The occurrence of any error in this class shall cause the query error bit (bit 2) in the event status register (IEEE 488.2, section 11.5.1) to be set. These errors correspond to message exchange protocol errors described in IEEE 488.2, section 6.5. One of the following is true:

An attempt is being made to read data from the output queue when no output is either present or pending;

Data in the output queue has been lost.

Events that generate query errors shall not generate command errors, execution errors, or device-specific errors; see the other error definitions in this section.

Error Code	Description
-400 Query error	This is the generic query error for devices that cannot detect more specific errors. This code indicates only that a Query Error as defined in IEEE 488.2, 11.5.1.1.7 and 6.3 has occurred.

# A PPENDIX

## PFR-100 Default Settings

The following default settings are the factory configuration settings for the power supply.

Initial Settings	Default Setting	
Output	Off	
LOCK	0 (Disabled)	
Voltage	0V	
Current	0A	
OVP	1.1 X Vrate	
OCP	1.1 X Irate	
Normal Function Settings	Setting	Default Setting
Output ON delay time	F-01	0.00s
Output OFF delay time	F-02	0.00s
V-I ode slew sate select	F-03	0 = CV high speed priority
Rising Voltage slew rate	F-04	100.0V/s (PFR-100L)
		500.0V/s (PFR-100M)
Falling Voltage slew rate	F-05	100.0V/s (PFR-100L)
		500.0V/s (PFR-100M)
Rising Current slew rate	F-06	20.00A/s (PFR-100L)
		4.000A/s (PFR-100M)
Falling Current slew rate	F-07	20.00A/s (PFR-100L)
		4.000A/s (PFR-100M)
Bleeder ON/OFF control	F-09	1 = ON
Buzzer ON/OFF control	F-10	1 = ON
Detection Time of OCP	F-12	0.0 sec
Current Setting limit	F-13	0 = OFF (The limit function of current setting is disabled.)
Voltage Setting limit	F-14	0 = OFF (The limit function of voltage setting is disabled.)
Memory Recall display	F-15	0 = OFF

Measurement average setting	F-17	0 = Low
Lock Mode	F-19	0: Lock Panel, Allow Output OFF
USB / GPIB setting	Setting	Default Setting
GPIB address	F-23	8
LAN setting	Setting	Default Setting
DHCP	F-37	1 = ON
Web password enable/disable	F-60	1 = Enable
UART setting	Setting	Default Setting
UART Baudrate	F-71	7 = 115200
UART Data Bits	F-72	1 = 8 bits
UART Parity	F-73	0 = None
UART Stop Bit	F-74	0 = 1 bit
UART TCP	F-75	0 = SCPI
Power On Configuration setting	Setting	Default Setting
CV Control	F-90	0 = Panel control (local)
CC Control	F-91	0 = Panel control (local)
Power ON Output	F-92	0 = Safe Mode (Output OFF at startup)
External Output Logic Control	F-94	0 = High ON

## Error Messages & Messages

The following error messages or messages may appear on the PFR-100 screen during operation.

Error Messages	Description
OHP	Over temperature protection
SENSE ALARM1	Sense Alarm1
SENSE ALARM2	Sense Alarm2
AC	AC fail
OVP	Over voltage protection
OCP	Over current protection
OPP	Over Power Protection
SHUT DOWN	Force shutdown
Err 001	USB mass storage is not present
Err 002	No (such)file in USB mass storage
Err 003	Empty memory location
Err 004	File access error
Err 005	File is too large
Err 007	Slave occurs Off-line (Multi-Drop mode)

Normal Messages	Description
MSG 001	External control of output. Output off (F-94=0, High=on)
MSG 002	External control of output. Output off (F-94=1, Low=on)

Communication Interface Messages	Description
USB ON	Rear USB port connected to PC
USB OFF	Rear USB port disconnected from PC
MS ON	Mass storage plugged into front USB port
MS OFF	Mass storage removed from front USB port

## LED ASCII Table Character Set

Use the following table to read the LCD display messages.

0	1	2	3	4	5	6	7	8	9	A	B	C	D
<i>0</i>	<i>1</i>	<i>2</i>	<i>3</i>	<i>4</i>	<i>5</i>	<i>6</i>	<i>7</i>	<i>8</i>	<i>9</i>	<i>A</i>	<i>b</i>	<i>C</i>	<i>d</i>
E	F	G	H	I	J	K	L	M	N	O	P	Q	R
<i>E</i>	<i>F</i>	<i>G</i>	<i>H</i>	<i>I</i>	<i>J</i>	<i>K</i>	<i>L</i>	<i>M</i>	<i>N</i>	<i>O</i>	<i>P</i>	<i>Q</i>	<i>R</i>
S	T	U	V	W	X	Y	Z	(	)	+	-	,	
<i>S</i>	<i>T</i>	<i>U</i>	<i>V</i>	<i>W</i>	<i>X</i>	<i>Y</i>	<i>Z</i>	<i>(</i>	<i>)</i>	<i>+</i>	<i>-</i>	<i>,</i>	<i>.</i>

# INDEX

Accessories .....	10	Remote control .....	26
Caution symbol .....	4	Command list .....	73
Cleaning the instrument .....	6	Command syntax .....	70
Configuration		Error list .....	138
normal function settings		Ethernet configuration .....	57
operation .....	19	Ethernet function check .....	58
power on configuration operation	21	GPIB configuration .....	36
table .....	22	GPIB function check .....	37
Display format .....	149	interface configuration .....	28
Disposal instructions .....	7	local bus configuration .....	45, 50
EN61010		multi-unit configuration .....	45, 50
pollution degree .....	6	multi-unit function check .....	53
Environment		sockets configuration .....	60
safety instruction .....	6	sockets function check .....	29, 61
Error messages .....	148	Status registers .....	125
Ethernet		UART configuration .....	41
sockets .....	60	UART function check .....	44, 54
web server .....	57	USB configuration .....	28
Ground		Service operation	
symbol .....	4	about disassembly .....	5
LED conversion .....	149	Socket server examples	
List of features .....	9	C++ .....	67
Messages .....	148	LabVIEW .....	69
Model differences .....	9	Visual basic .....	66
Optional accessories .....	10	Socket server function check	29, 61
Package contents .....	10	Warning symbol .....	4, 17
Rear panel diagram .....	17	Web server function check .....	58