

# Programmable Power Supply

PSP-603, PSP-405, PSP-2010

---

**USER MANUAL**



ISO-9001 CERTIFIED MANUFACTURER

**GW INSTEK**



# Table of Contents

<b>SAFETY INSTRUCTIONS</b> .....	<b>2</b>
<b>GETTING STARTED</b> .....	<b>7</b>
Main Features.....	8
Accessories.....	8
PSP Series Lineup.....	9
Front Panel Overview.....	10
Display Overview .....	12
Rear Panel Overview .....	14
Set Up .....	15
<b>OPERATION</b> .....	<b>17</b>
<b>REMOTE CONTROL</b> .....	<b>26</b>
Interface Configuration.....	28
Command Set.....	35
Setting for different command format .....	52
<b>FAQ</b> .....	<b>56</b>
<b>APPENDIX</b> .....	<b>57</b>
Fuse Replacement.....	57
Fan .....	58
Specification.....	59
Declaration of Conformity.....	61
<b>INDEX</b> .....	<b>62</b>

# S SAFETY INSTRUCTIONS

This chapter contains important safety instructions that you must follow when operating a PSP series power supply and when keeping it in storage. Read the following before any operation to insure your safety and to keep the instrument in the best possible condition.

## Safety Symbols

These safety symbols may appear in this manual or on the power supply.

---



WARNING

Warning: Identifies conditions or practices that could result in injury or loss of life.



CAUTION

Caution: Identifies conditions or practices that could result in damage to the power supply or to other property.



DANGER High Voltage



Attention Refer to the Manual



Protective Conductor Terminal



Earth (ground) Terminal

## Safety Guidelines

---

### General Guideline



#### CAUTION

- Do not place any heavy object on the power supply.
- Avoid severe impact or rough handling that could lead to damaging the power supply.
- Do not discharge static electricity to the power supply.
- Do not block or obstruct the cooling fan vent openings.
- Do not disassemble the power supply unless you are qualified as service personnel.

(Measurement categories) EN 61010-1:2001 specifies the measurement categories and their requirements as follows. The PSP series power supplies fall under category II.

- Measurement category IV is for measurement performed at the source of low-voltage installation.
  - Measurement category III is for measurement performed in the building installation.
  - Measurement category II is for measurement performed on the circuits directly connected to the low voltage installation.
  - Measurement category I is for measurements performed on circuits not directly connected to Mains.
- 

### Power Supply



#### WARNING

- AC Input voltage: 115V±10%/230V±15%, 50/60Hz.
  - Connect the protective grounding conductor of the AC power cord to an earth ground, to avoid electrical shock.
- 

### Fuse



#### WARNING

- Fuse type: Slow blow T3.15A/250V (230V input), T6.3A/250 (115V input).
- Make sure the correct type of fuse is installed before power up.

- For fire prevention, replace the fuse only with the specified type and rating.
  - Disconnect the power cord before fuse replacement.
  - Make sure the cause of the fuse blowout is fixed before replacing the fuse.
- 

#### Cleaning

- Disconnect the power cord before cleaning.
  - Use a soft cloth dampened in a solution of mild detergent and water. Do not spray any liquid.
  - Do not use chemicals or cleaners containing harsh materials such as benzene, toluene, xylene, and acetone.
- 

#### Operation Environment

- Location: Indoor, no direct sunlight, dust free, almost non-conductive pollution (Note below)
- Relative Humidity: < 80%
- Altitude: < 2000m
- Temperature: 0°C to 40°C

(Pollution Degree) EN 61010-1:2001 specifies the pollution degrees and their requirements as follows. The PSP power supply falls under degree 2.

Pollution refers to “addition of foreign matter, solid, liquid, or gaseous (ionized gases), that may produce a reduction of dielectric strength or surface resistivity”.

- Pollution degree 1: No pollution or only dry, non-conductive pollution occurs. The pollution has no influence.
  - Pollution degree 2: Normally only non-conductive pollution occurs. Occasionally, however, a temporary conductivity caused by condensation must be expected.
  - Pollution degree 3: Conductive pollution occurs, or dry, non-conductive pollution occurs which becomes conductive due to condensation which is expected. In such conditions, equipment is normally protected against exposure to direct sunlight, precipitation, and full wind pressure, but neither temperature nor humidity is controlled.
-

**Storage environment**

- Location: Indoor
- Relative Humidity: < 80%
- Temperature: -10°C to 70°C

**General Precautions****CAUTION**

- All electronically conducting materials (cables, leads, terminals) must be sufficiently insulated.
- Connected loads should not be left unsupervised.
- Ensure adequate ventilation for operation.
- High voltages or current can be hazardous, ensure proper safety precautions are used.
- Do not use the power supply in situations where condensation may have occurred, such as where severe temperature/humidity fluctuations have occurred.

## Power cord for the United Kingdom

When using the power supply in the United Kingdom, make sure the power cord meets the following safety instructions.

---

NOTE: This lead/appliance must only be wired by competent persons

 **WARNING: THIS APPLIANCE MUST BE EARTHED**

IMPORTANT: The wires in this lead are coloured in accordance with the following code:

Green/ Yellow:	Earth
Blue:	Neutral
Brown:	Live (Phase)



As the colours of the wires in main leads may not correspond with the coloured marking identified in your plug/appliance, proceed as follows:

The wire which is coloured Green & Yellow must be connected to the Earth terminal marked with either the letter E, the earth symbol  or coloured Green/Green & Yellow.

The wire which is coloured Blue must be connected to the terminal which is marked with the letter N or coloured Blue or Black.

The wire which is coloured Brown must be connected to the terminal marked with the letter L or P or coloured Brown or Red.

If in doubt, consult the instructions provided with the equipment or contact the supplier.

This cable/appliance should be protected by a suitably rated and approved HBC mains fuse: refer to the rating information on the equipment and/or user instructions for details. As a guide, a cable of 0.75mm<sup>2</sup> should be protected by a 3A or 5A fuse. Larger conductors would normally require 13A types, depending on the connection method used.

Any exposed wiring from a cable, plug or connection that is engaged in a live socket is extremely hazardous. If a cable or plug is deemed hazardous, turn off the mains power and remove the cable, any fuses and fuse assemblies. All hazardous wiring must be immediately destroyed and replaced in accordance to the above standard.





## Main Features

---

- |             |   |
|-------------|---|
| Performance | <ul style="list-style-type: none"><li>• 200 watt output</li><li>• 0~60V/0~3.5A (PSP-606)</li><li>• 0~40V/0~5A (PSP-405)</li><li>• 0~20V/0~10A (PSP-2010)</li><li>• High resolution and accuracy</li></ul>   |
| Operation   | <ul style="list-style-type: none"><li>• Current, power and voltage limits.</li><li>• Current limiter for short circuit and overload protection</li><li>• Key lock</li><li>• Percentage offset output</li><li>• LCD display</li><li>• Digital scroll wheel</li><li>• Course and fine control</li><li>• Temperature and load controlled fan</li><li>• Optional European terminals</li></ul> |
| Interface   | <ul style="list-style-type: none"><li>• Custom RS-232C (Please use GTL-232A cable only)</li></ul>   |
- 

## Accessories

---

- Power cord x1
  - Instruction manual x1
  - Test Lead x1
-

## PSP Series Lineup

The PSP Series are single output programmable switching DC power supplies. There are 3 models in the PSP series lineup. For detailed information, please see the specification table on page 58.

---

Model	Power	Voltage	Current
PSP-603	200W	0~60V	0~3.5A
PSP-405	200W	0~40V	0~5A
PSP-2010	200W	0~20V	0~10A

---

## Front Panel Overview

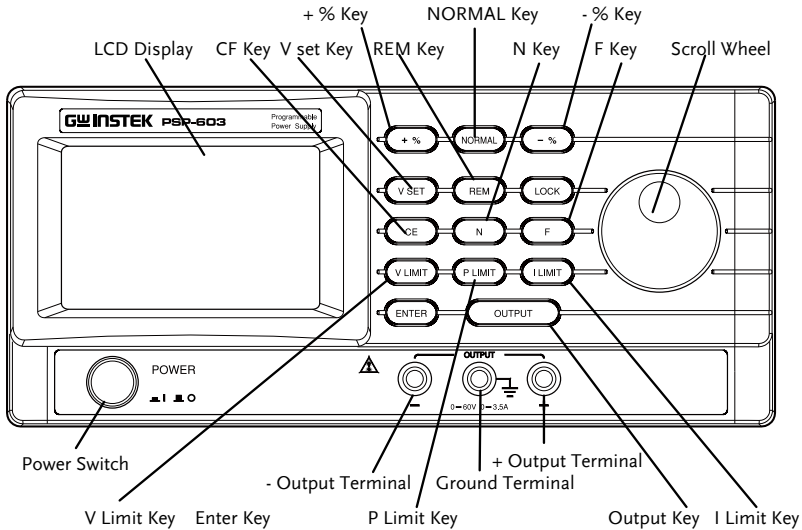

LCD Display

Monochrome LCD display.

CE key

**CE** Clears the last value entered.

V SET key

**V SET** Sets the output voltage level.

+% key











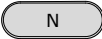
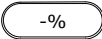

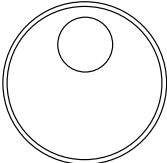
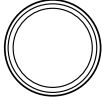
**+%** Sets the positive percentage offset value or increases the voltage output by the positive percentage offset.

REM key

**REM** Disables remote control. Activates all keys that were disabled during remote control.

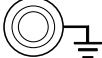
NORMAL key

**NORMAL** Returns the output voltage to the normal preset level after +% or -% key has been pressed.

- N key  Sets the scroll wheel to Normal (coarse) mode.
- % key  Sets the negative percentage offset value or decreases the voltage output by the negative percentage offset.
- LOCK  Locks the scroll wheel and panel keys.
- F key  Sets the scroll to Fine mode.
- Scroll Wheel  Adjustments measurement parameters and settings.
- POWER Switch  Power: ON:  I  
OFF:  O
- V LIMIT  Sets the voltage limit.
- ENTER  Confirms settings.
- Output Terminal  Negative terminal output.
- P LIMIT  Sets the power limit.
- Ground Terminal  Ground terminal.
- OUTPUT key  Turns the output ON/OFF.
- + Output Terminal  Positive terminal output.
- I LIMIT  Sets the current limit.

## Display Overview

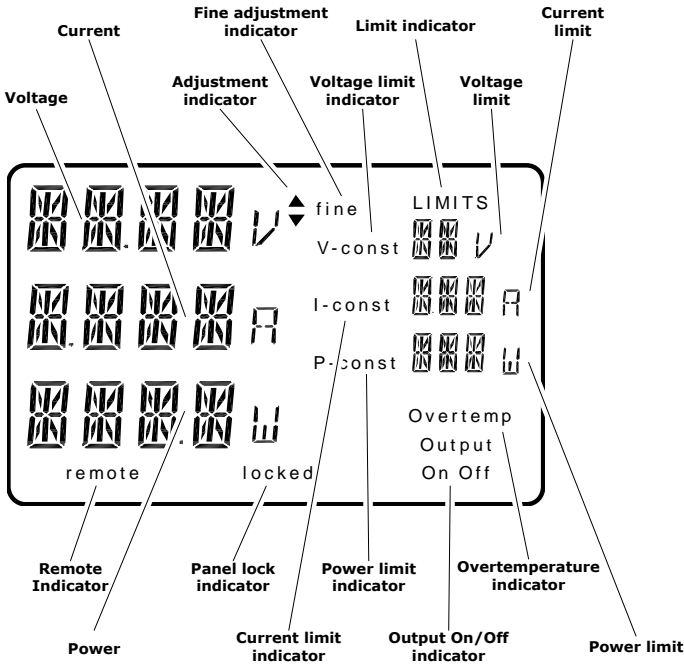

Voltage	Displays the voltage output.
Current	Displays the current output.
Adjustment Indicator	Displays the whether a parameter is adjusted higher of lower.
Fine Adjustment Indicator	Indicates when the scroll wheel is in fine mode.
Voltage limit/indicator	Used when adjusting the voltage limit.
Current limit/Indicator	Used when adjusting the current limit.
Power limit Indicator	Used when adjusting the power limit.

Over temperature indicator	When the temperature exceeds the internal temperature limit, the Over temperature indicator is displayed.
Panel Lock	Front panel key lock.
Remote	Remote is displayed when in remote control mode.
Power	Displays the power output.

## Rear Panel Overview

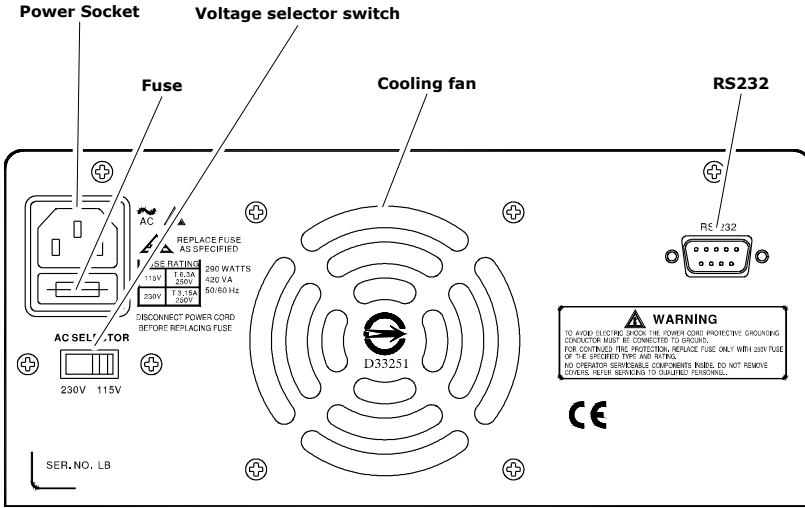

**Power Socket/Fuse**

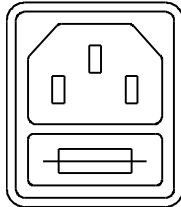

The power socket accepts AC mains voltage, 115V or 230V.

Fuse:

T3.15A/250V (230V input),  
T6.3A/250V (115V input)

**Voltage Selector**

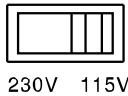

Sets the mains input voltage. Left, 230V, right, 115V.

**Cooling fan**

Temperature or current load controlled fan. See page 58.

**RS-232**

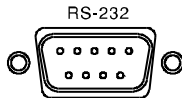

Custom RS-232C connector for remote control. (Please use GTL-232A cable only)



# Set Up

## Power up

Panel operation



1. Set the rear panel Voltage selector to the correct position according to the AC mains voltage.

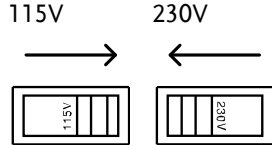

2. Connect the power cord to the socket.

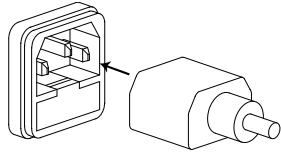

3. Turn On the power switch. The display becomes active in 2~3 seconds.

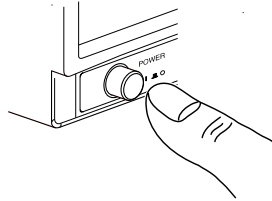

## Single Power Supply Connection

Panel operation

When connecting the power supply to a load, please ensure the safety guidelines below are adhered to.

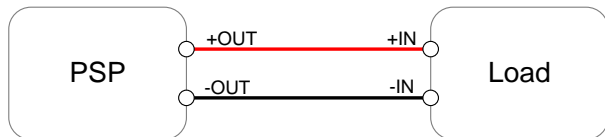

**Warning**

Ensure the output is off when connecting any cables to the power supply.

Inspect all cables or wires for damage before use. Any exposed wiring from cables can be extremely hazardous. If a cable is deemed hazardous, replace before use.

1. Ensure the power supply's output is turned off before proceeding with any connections.
2. Connect the positive terminal of the power supply to the positive terminal of the load.
3. Connect the negative terminal of the power supply to the load.

# OPERATION



The operation chapter describes how to set the limits, output voltage and how to adjust configuration settings.

---

Voltage Limit Settings.....	18
Current Limit Settings.....	19
Power Limit Settings.....	20
Voltage Output Setting.....	21
Output.....	22
Percentage Offset Output.....	22
Percentage Offset Settings.....	23
Scroll Wheel Step Resolution.....	24
Key Panel Lock.....	24
Remote Panel Lock.....	25

## Voltage Limit Settings

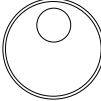
The voltage limit settings determine the maximum voltage output for the power supply.

- Panel operation
1. Press the V LIMIT key. The U-const icon will flash. 
  2. Use the scroll wheel to adjust the voltage limit in the U-const field. 
  3. Press ENTER to confirm the limit setting. 

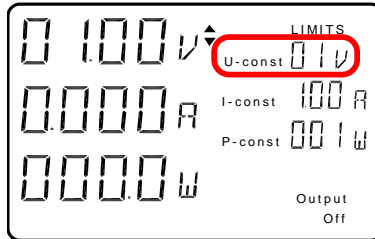

Range	0~Rating
Step resolution	1 volt

- Max Limit
4. Hold the V LIMIT key for 2 seconds to set to the rating voltage and to exit. 



- Clear
5. The CE key can be pressed to clear the voltage limit to the previous value when editing. This will also cancel editing the voltage limit and exit. 

Note

Editing the voltage limit will automatically adjust the power limit.

## Current Limit Settings

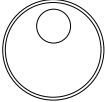
The current limit settings determine the maximum current output for the power supply.

- Panel operation
1. Press the I LIMIT key. The I-const icon will flash. 
  2. Use the scroll wheel to adjust the current limit in the I-const field. 
  3. Press ENTER to confirm the limit setting. 

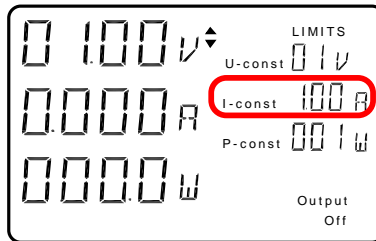

Range	0~Rating	
Step resolution	Fine	10mA
	Coarse	100mA



- Max Limit
4. Hold the I LIMIT key for 2 seconds to set to the rating current and to exit. 

- Clear
5. The CE key can be pressed to clear the current limit to the previous value when editing. This will also cancel editing the current limit and exit. 

Note Editing the current limit will automatically adjust the power limit.

## Power Limit Settings

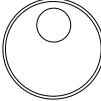
The power limit settings determine the maximum power output for the power supply.

- Panel operation
1. Press the P LIMIT key. The P-const icon will flash. 
  2. Use the scroll wheel to adjust the current limit in the P-const field. 
  3. Press ENTER to confirm the limit setting. 

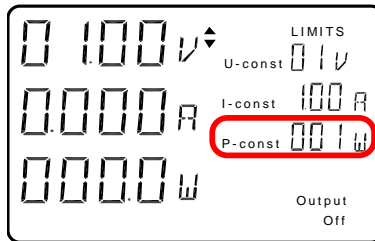

Range	0~Rating
Step resolution	1 watt

- Max Limit
4. Hold the P LIMIT key for 2 seconds to set to the rating power and to exit. 

- Clear
5. The CE key can be pressed to clear the power limit to the previous value when editing. This will also cancel editing the power limit and exit. 

Note                      Editing the power limit will automatically adjust the current limit.

## Voltage Output Setting

The voltage output can be changed at any time when the panel is not locked. The voltage output is limited by the voltage limit value (U-const). The voltage output can be edited regardless of whether the output is on or off.

- Panel operation 1. Use the scroll wheel to adjust the Voltage output.

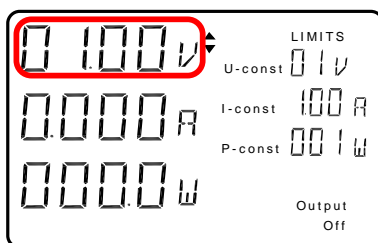
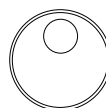

Range	0~voltage limit (U-const)	
Step resolution	Fine	10 mV
	Coarse	1V

## Output

The output can be turned on or off via the OUTPUT key. The power supply's output is off by default. The voltage output level can be changed regardless of whether the output is on or off.

Panel operation

1. Press the OUTPUT key to turn the output on or off. The output status is displayed in the lower left hand side.

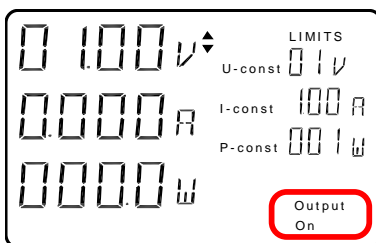
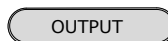

## Percentage Offset Output

The power supply output can be increased or decreased by a percentage offset.

Panel operation

1. Turn the output on.

Percentage Output

2. Press the + % key or the - % key to increase or decrease the voltage output by a set percentage offset. (see page 23)

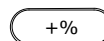

or

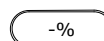

Normal Output

3. To cancel the percentage offset output, press the NORMAL key to revert the output to normal.





## Percentage Offset Settings

---

The power supply output can be increased or decreased by a set percentage. For example, if the voltage output is 10V, and the +% value is 110, then the voltage will be increased to 110%, making the final voltage 11V.

---

Panel operation 1. Ensure the Output is off. Page 22

2. Press the + % key or the - % key.

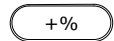

3. Use the scroll wheel to adjust the % setting.

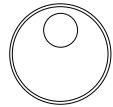

4. Press Enter to confirm the setting and exit.

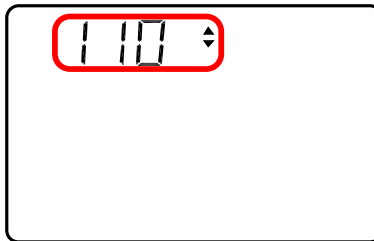

Range (-%) 50~100

(+%) 100~150

Step resolution 1 %

---

Exit 5. Press CE to cancel and exit.



## Scroll Wheel Step Resolution

The Step resolution of the scroll wheel can be adjusted by fine or coarse steps. Fine and Normal (Coarse) mode is applicable to limit and voltage output settings.

Fine Mode

1. Press the F key to select fine mode.
2. Fine will be displayed in the panel when in fine mode.

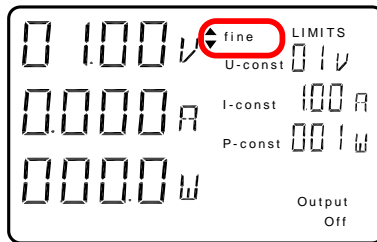

Normal Mode

3. Press the N key to select Normal (coarse) mode.
4. The fine icon will disappear when in coarse mode.

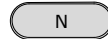

## Key Panel Lock

The panel keys and selector wheel can be locked to prevent the settings being changed. When the panel is locked only the power key and lock key can be used.

Panel Operation

1. Press the LOCK key.



- When the panel is locked, locked will be displayed at the bottom of the display.

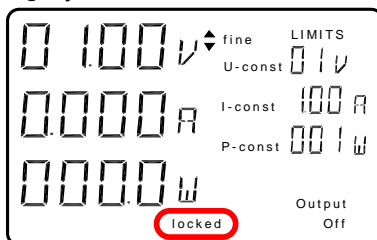

Unlock

- Press the LOCK key for two seconds.

LOCK

- The locked icon will disappear.

## Remote Panel Lock

When the PSP power supply is used via remote control, the panel keys will be locked. Remote will be displayed when remote control is active. The REM key can be used to unlock the panel and return the power supply to local control.

Panel Operation

- Press the REM key.

REM

- Remote will no longer be visible on the display panel.

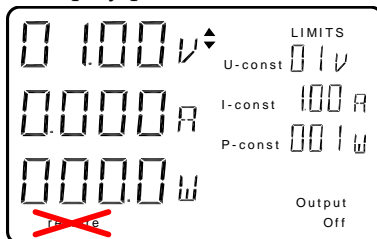

# REMOTE CONTROL

This chapter describes how to configure the power supply and PC for RS-232C remote control (Please use GTL-232A cable only).

---

Interface Configuration .....	28
Configure RS-232C interface.....	28
RS-232C Setup .....	29
Command Syntax.....	33
Command Set .....	35
L.....	35
V .....	37
A .....	38
W .....	38
U .....	39
I.....	39
P.....	40
F.....	41
SV+ .....	42
SV- .....	42
SU+.....	42
SU-.....	43
SI+ .....	43
SI- .....	43
SP+ .....	44
SP- .....	44
SUM .....	44
SIM .....	45
SPM .....	45
KF .....	45
KN .....	46
KO .....	46
KOE .....	46
KOD.....	46
EEP .....	47
B .....	47
D.....	48

Q.....	48
SB+.....	49
SB-.....	49
SD+.....	49
SD-.....	49
SV.....	50
SU.....	50
SI.....	50
SP.....	51
Setting for different command format .....	52

# Interface Configuration

## Configure RS-232C interface

RS-232C configuration	Connector	DB-9, Male
	Baud rate	2400
	Parity	None
	Data bit	8
	Stop bit	1
	Data flow control	none

Connect the GTL-232A cable (custom RS-232C) to the rear panel port: DB-9 male connector.

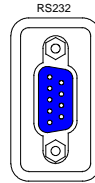

Pin assignment

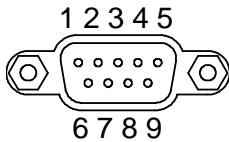

- 2: RxD (Receive data)
- 3: TxD (Transmit data)
- 4: +12V
- 5: GND
- 1, 6, 7, 8, 9: No connection

PC connection

Use the GTL-232A cable (custom RS-232C) only. The internal connection of GTL-232A is in the below diagram.

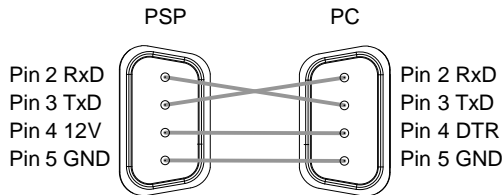



Note

Because DTR is controlled by software, it needs to be set beforehand. Otherwise, it may cause that 12V can't be output to PSP and no readback response.

## RS-232C Setup

---

### Background

For remote control connection, the PSP power supply series uses a custom RS-232C connection with a propriety pin out configuration. Please use the GTL-232A only. See the pin out configuration on page 28.

---

### Operation

1. Start the NI Measurement and Automation Explorer (MAX) program. Using Windows, press:



*Start>All Programs>National Instruments>Measurement & Automation*



2. From the Configuration panel access;

*My System>Devices and Interfaces>Network Devices*

3. Right click *ASRL2: INSTR"COM2"*



Note

The port number depends on which port you connected to PSP Power Supply.

Functionality Check

4. Click the *Open Visa Test Panel*.

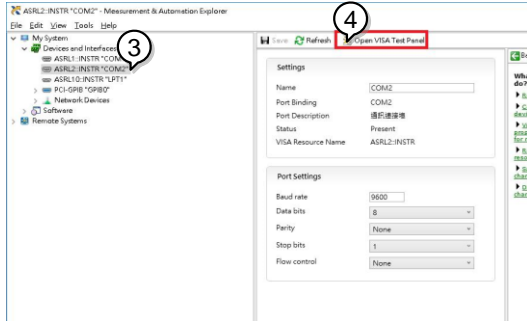

5. Click on the *Configuration* icon.
6. Select the *Serial Settings* tab.
7. Set the Baud rate to 2400.
8. Click *Apply Changes*.

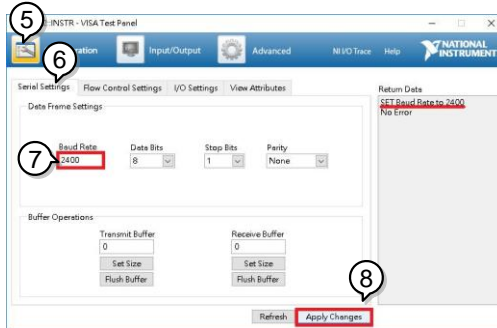



9. Click on the *Configuration* icon.
10. Select the *Flow Control Settings*.
11. Click *Apply Changes*.

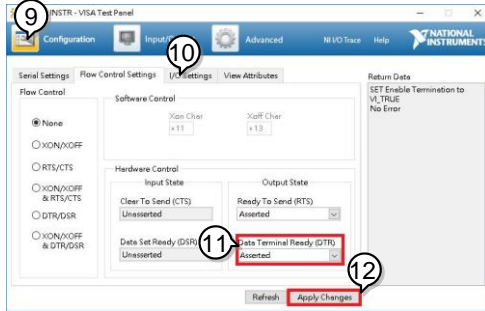

12. Click on the *Configuration* icon.
13. Select the *I/O Settings* tab.
14. Mark the *Enable Termination Character* checkbox. Make sure the termination character is a line feed (\n, value: xA).
15. Click *Apply Changes*.

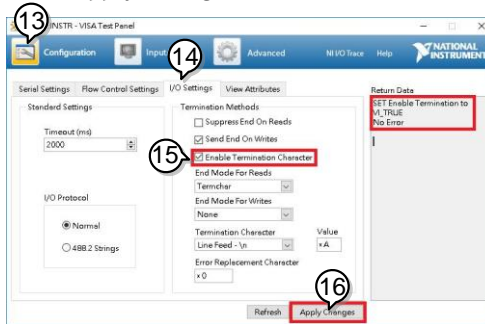

16. Click the *Input/Output* icon.
17. Enter “L\r” in the *Select or Enter Command* drop box.
18. Click on *Query*.
19. The information about xxx will be displayed in the buffer as below.



## Command Syntax

**Command types** The power supply has 25 remote commands. Commands and queries can be written in either ASCII or hexadecimal. All ASCII commands are case sensitive. All parameters are format sensitive.

<b>Command format</b>	<p><b>SV 10.00&lt;CR&gt;</b></p>	<p>1: command header</p> <p>2: space</p> <p>3: parameter</p> <p>4: message terminator</p>
	<p><b>W&lt;CR&gt;</b></p>	

<b>Return format</b>	<p><b>P100&lt;CR&gt;&lt;LF&gt; or &lt;CR&gt;&lt;CR&gt;&lt;LF&gt;</b></p>	<p>1: command header</p> <p>2: parameter</p> <p>3: message terminator</p>
----------------------	--	---

Parameters	Type	Example	Description
	xx	10	2 character ASCII number, no decimal places.
	xx.x	10.5	4 character ASCII number including the decimal point. One decimal place only.
	xx.xx	10.50	5 character ASCII number including the decimal point. 2 decimal places only.

---

Hexadecimal      Commands can be written in ASCII or Hexadecimal. Below are examples of ASCII and hexadecimal commands.

ASCII              W<CR>

Hex                57 0D

---

Message terminators      Each command must have a carriage return and line feed character as a message terminator.

All return messages are terminated with a carriage return and line feed terminator.

<CR><LF>      Carriage return/line feed



Note

Depend on firmware version, there will be different ending characters for the response code. It may appear on the display either <CR><LF> 0x0D 0x0A or <CR><CR><LF> 0x0D 0x0D 0x0A Refer to the section of "Setting for different command format" page for further information.

---

## Command Set

L		Query
Description	The L query returns all the status values of the power supply.	
Query Syntax	L<CR>	ASCII
	4C 0D	HEX
Return Parameter	Vvv.vvAa.aaaWwww.wUuuli.iiPpppFf1f2f3f4f5f6<CR><LF>	
	Character	Description
	V	Voltage unit
	vv.vv	Voltage value (5 characters, 2 decimal places)
	A	Current Unit
	a.aaa	Current value (5 characters, 3 decimal places)
	W	Power unit
	www.w	Power value (5 characters, 1 decimal place)
	U	Voltage limit unit
	uu	Voltage limit value (2 characters, no decimal)
	I	Current limit unit
	i.ii	Current limit value (4 characters, 2 decimal places)
	P	Power limit unit
	ppp	Power limit value (3 characters, no decimal)
	F	Status Byte character

f1 f2 f3 f4 f5 f6	f1 :Relay Status: 0: on, 1: off
	f2 :Temperature Status 0:normal, 1:overtemp
	f3 : Step mode: 0:coarse, 1:fine
	f4 : Scroll wheel status: 0:locked, 1:unlocked
	f5 : Remote Status: 0:normal, 1:remote
	f6 : Lock Status: 0:unlocked, 1:locked

Example	<p>L&lt;CR&gt; V20.00A2.500W050.0U4015. 00P200F101100&lt;CR&gt;&lt;LF&gt;</p>	<p>Returns the status values of the power supply in order.</p> <p>20.00V output voltage, 2.500A output current, 50W output load, 40V voltage limit, 5.00A current limit, 200W power limit, Relay off, temperature normal, fine step mode, scroll wheel unlocked, remote status normal, panel unlocked.</p>
---------	---	--

V		Query
Description	The V query returns the voltage output of the power supply.	
Query Syntax	V<CR>	ASCII
	56 0D	HEX
Return Parameter	Vvv.vv<CR><LF>	
	Character	Description
	V	Voltage unit
	vv.vv	Voltage value (5 characters, 2 decimal places)
Example	V<CR>	Returns the voltage output.
	V20.00<CR><LF>	20.00V

A		Query
Description	The A query returns the current output of the power supply.	
Query Syntax	A<CR>	ASCII
	41 0D	HEX
Return Parameter	Aa.aaa<CR><LF>	
	Character	Description
	A	Current unit
	a.aaa	current value (5 characters, 3 decimal places)
Example	A<CR>	Returns the current output.
	A1.000<CR><LF>	1.000A

W		Query
Description	The W query returns the load output of the power supply.	
Query Syntax	W<CR>	ASCII
	57 0D	HEX
Return Parameter	Wwww.w<CR><LF>	
	Character	Description
	W	Power unit
	www.w	power value (5 characters, 1 decimal place)
Example	W<CR>	Returns the load output.
	W050.0<CR><LF>	50W



U		Query
Description	The U query returns the current voltage limit.	
Query Syntax	U<CR>	ASCII
	55 0D	HEX
Return Parameter	Uuu<CR><LF>	
	Character	Description
	U	Voltage limit unit
	uu	Voltage limit value (2 characters, no decimal)
Example	U<CR>	Returns the current voltage limit.
	U10<CR><LF>	10V

I		Query
Description	The I query returns the current current limit.	
Query Syntax	I<CR>	ASCII
	49 0D	HEX
Return Parameter	Ii.ii<CR><LF>	
	Character	Description
	I	current limit unit
	i.ii	Current limit value (5 characters, 2 decimal places)
Example	I<CR>	Returns the current current limit.
	I1.500<CR><LF>	1.5A

P	Query	
Description	The P query returns the current power load limit.	
Query Syntax	P<CR>	ASCII
	50 0D	HEX
Return Parameter	Pppp<CR><LF>	
	Character	Description
	P	Power load limit unit
	ppp	Power limit value (3 characters, no decimal)
Example	P<CR>	Returns the current load limit.
	P050<CR><LF>	50W

F		Query
Description	The F query returns the status of the power supply.	
Query Syntax	F<CR> 46 0D	ASCII HEX
Return Parameter	F f1f2f3f4f5f6<CR><LF>	
	F	Status Byte character
	f1f2f3f4f5f6	f1 :Relay Status: 0: off, 1: on
		f2 :Temperature Status 0:normal, 1:overtemp
		f3 : Step mode: 0: normal, 1: fine
		f4 : Scroll wheel status: 0:locked, 1:unlocked
		f5 : Remote Status: 0:normal, 1:remote
		f6 : Lock Status: 0:unlocked, 1:locked
Example	F<CR> F101100<CR><LF>	Returns the status of the power supply. Relay on, temperature normal, fine step mode, scroll wheel unlocked, remote status normal, panel unlocked.

SV+	Command	
Description	The SV+ command increases the voltage output by 1V (coarse mode) or 1mV(fine mode). 20.00V→21.00V (coarse mode) 20.00V→20.01V (fine mode)	
Syntax	SV+<CR>	ASCII
	53 56 2B 0D	HEX
Example	SV+<CR>	Increases the voltage output by one unit.

SV-	Command	
Description	The SV- command decreases the voltage output by 1V (coarse mode) or 1mV(fine mode). 20.00V→19.00V (coarse mode) 20.00V→19.99V (fine mode)	
Syntax	SV-<CR>	ASCII
	53 56 2D 0D	HEX
Example	SV-<CR>	Decreases the voltage output by one unit.

SU+	Command	
Description	The SU+ command increases the voltage limit by 1V.	
Syntax	SU+<CR>	ASCII
	53 55 2B 0D	HEX
Example	SU+<CR>	Increases the voltage limit by one unit.

SU-		Command
Description	The SU- command decreases the voltage limit by 1V.	
Syntax	SU-<CR> 53 55 2D 0D	ASCII HEX
Example	SU-<CR>	Decreases the voltage limit by one unit.

SI+		Command
Description	The SI+ command increases the current limit by 10mA (coarse mode) or 1mA(fine mode). 3.01A→3.11A (coarse mode) 3.01A→3.02A (fine mode)	
Syntax	SI+<CR> 53 49 2B 0D	ASCII HEX
Example	SI+<CR>	Increases the current limit by one unit.

SI-		Command
Description	The SI- command decreases the current limit by 10mA (coarse mode) or 1mA(fine mode). 3.01A→2.91A (coarse mode) 3.01A→3.00A (fine mode)	
Syntax	SI-<CR> 53 49 2D 0D	ASCII HEX
Example	SI-<CR>	Decreases the current limit by one unit.

SP+		Command
Description	The SP+ command increases the load limit by 1W.	
Syntax	SP+<CR>	ASCII
	53 50 2B 0D	HEX
Example	SP+<CR>	Increases the load limit by one unit.

SP-		Command
Description	The SP- command decreases the load limit by 1W.	
Syntax	SP-<CR>	ASCII
	53 50 2D 0D	HEX
Example	SP-<CR>	Decreases the load limit by one unit.

SUM		Command
Description	The SUM command sets the voltage limit to the maximum rating.	
Syntax	SUM<CR>	ASCII
	53 55 4D 0D	HEX
Example	SUM<CR>	The voltage limit is set to the maximum rating.

SIM		Command
Description	The SIM command sets the current limit to the maximum rating.	
Syntax	SIM<CR>	ASCII
	53 49 4D 0D	HEX
Example	SIM<CR>	The current limit is set to the maximum rating.

SPM		Command
Description	The SPM command sets the load limit to the maximum rating.	
Syntax	SPM<CR>	ASCII
	53 50 4D 0D	HEX
Example	SPM<CR>	The load limit is set to the maximum rating.

KF		Command
Description	The KF command sets the step resolution to fine mode.	
Syntax	KF<CR>	ASCII
	4B 46 0D	HEX
Example	KF<CR>	The scroll wheel step resolution is set to fine.

KN		Command
Description	The KN command sets the step resolution to normal (coarse) mode.	
Syntax	KN<CR>	ASCII
	4B 4E 0D	HEX
Example	KN<CR>	The scroll wheel step resolution is set to normal (coarse).

KO		Command
Description	The KO command toggles the output On or Off.	
Syntax	KO<CR>	ASCII
	4B 4F 0D	HEX
Example	KO<CR>	Output is toggled On→Off or Off→On

KOE		Command
Description	The KOE command turns the output On.	
Syntax	KOE<CR>	ASCII
	4B 4F 45 0D	HEX
Example	KOE<CR>	Output is turned on.

KOD		Command
Description	The KOD command turns the output Off.	
Syntax	KOD<CR>	ASCII
	4B 4F 44 0D	HEX
Example	KOD<CR>	Output is turned off.



EEP		Command
Description	The EEP command saves the settings to internal memory. The settings will recalled upon the next startup.	
Syntax	EEP<CR>	ASCII
	45 45 50 0D	HEX
Example	EEP<CR>	Save settings to memory.

B		Query
Description	The B query returns the +% value.	
Query Syntax	B<CR>	ASCII
	42 0D	HEX
Return Parameter	Bbbb<CR><LF>	
	Character	Description
	B	+% unit
	Bbb	+% value 100~150 (3 characters, no decimal)
Example	B<CR>	Returns the +%unit and value
	B150<CR><LF>	150 %

D		Query
Description	The D query returns the -% value.	
Query Syntax	D<CR>	ASCII
	44 0D	HEX
Return Parameter	Bbbb<CR><LF>	
	Character	Description
	D	-% unit
	Dddd	-% value 50~100 (3 characters, no decimal)
Example	D<CR>	Returns the -%unit and value
	D050<CR><LF>	50 %

Q		Query
Description	The Q query returns the status of -% and +% offsets.	
Query Syntax	Q<CR>	ASCII
	51 0D	HEX
Return Parameter	Qq1q2q3q4q5q6<CR><LF>	
	Q	Percentage Offset Character
	q1q2q3q4q5q6	q1 :-% status: 0: off, 1: on
		q2 : +% status 0:off, 1:on
		q3-q6 : Not used

SB+		Command
Description	The SB+ command increases the +% offset by 1%.	
Syntax	SB+<CR>	ASCII
	53 42 2B 0D	HEX
Example	SB+<CR>	Increase the +% offset by 1 percent.

SB-		Command
Description	The SB- command decreases the +% offset by 1%.	
Syntax	SB-<CR>	ASCII
	53 42 2D 0D	HEX
Example	SB-<CR>	Decrease the +% offset by 1 percent.

SD+		Command
Description	The SD+ command increases the -% offset by 1%.	
Syntax	SD+<CR>	ASCII
	53 44 2B 0D	HEX
Example	SD+<CR>	Increase the -% offset by 1 percent.

SD-		Command
Description	The SD- command decreases the -% offset by 1%.	
Syntax	SD-<CR>	ASCII
	53 44 2D 0D	HEX
Example	SD-<CR>	Decrease the _% offset by 1 percent.

SV	Command	
Description	The SV command sets the voltage output level.	
Syntax	SV <parameter> <CR>	ASCII
	53 56 <parameter> 0D	HEX
Parameter	<parameter>	Description
	xx.xx	Voltage value( 5 characters, 2 decimal places)
Example	SV 10.50<CR>	Sets the voltage output to 10.5V.

SU	Command	
Description	The SU command sets the voltage output limit.	
Syntax	SU <parameter> <CR>	ASCII
	53 55<parameter> 0D	HEX
Parameter	<parameter>	Description
	xx	Voltage value( 2 characters, no decimal)
Example	SU 11<CR>	Sets the voltage limit to 11V.

SI	Command	
Description	The SI command sets the current limit. The power limit will be automatically altered to suit.	
Syntax	SI <parameter> <CR>	ASCII
	53 49<parameter> 0D	HEX
Parameter	<parameter>	Description
	x.xx	Current limit value( 4 characters, two decimal places)
Example	SI 1.10<CR>	Sets the current limit to 1.10A.

SP	Command	
Description	The SP command sets the power limit. When the power limit is changed the current limit will be automatically altered to suit.	
Syntax	SP <parameter> <CR>	ASCII
	53 50<parameter> 0D	HEX
Parameter	<parameter>	Description
	xxx	Power limit value( 3 characters, no decimal)
Example	SP 100<CR>	Sets the power limit to 100W.

## Setting for different command format

---

**Background** UART setting can be used to deter if command format to be modified for the PSP with firmware V1.66 or above.

Before setting, please make sure that the connection between a computer and the PSP is normal by entering "L" from terminal (2400/ N8/ 1 or 9600/ N/ 8/1) and get the response message as shown in the diagram below.

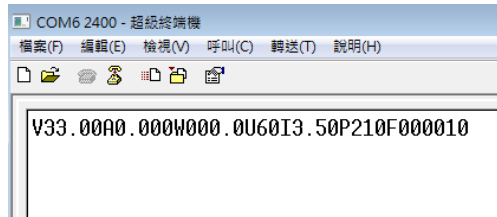

### Note

Please complete the settings within 15 seconds after power is on because setting can't be changed after 15 seconds.

The setting procedure only needs to be executed once. Afterward, the device will be kept in the same setting mode when the device is turned on every time.

---

Operation

1. Set PSP1 with setting A (see note below), then Enter "URPSP1".  
The PSP's response is shown in the diagram below and has beep sound.

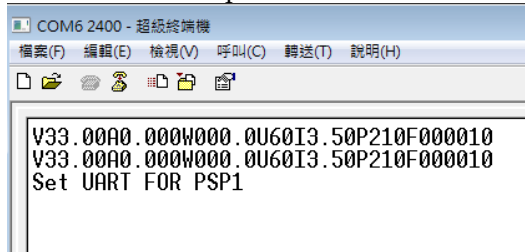

2. Set PSP2 without A(see note below), then Enter "URPSP2".  
The PSP's response is shown in the diagram below and has beep sound.

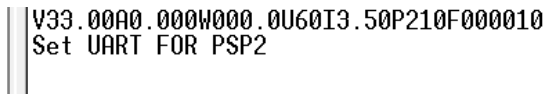

 Note

The difference between firmware V1.55 and the current firmware version for shipping PSP (V1.66).

When the letter "A" appears on the PSP's display as shown in the diagram below, it means that it is setting with A and the terminator for response message is 0x0D 0x0D 0x0A. Otherwise, it is 0x0D 0x0A.



When setting is with A, the terminator for responded message on the display is

0x0D 0x0D 0x0A as shown in the diagram below.

```

Communication
ASCII [HEX] Decimal Binary
09:56:18.587 [TX] - 56 0D
09:56:18.603 [RX] - 56 31 32 2E 30 30 0D 0D 0A
09:56:27.012 [TX] - 56 0D
09:56:27.028 [RX] - 56 30 35 2E 30 30 0D 0D 0A
09:56:30.395 [TX] - 41 0D
09:56:30.410 [RX] - 41 30 2E 30 30 30 0D 0D 0A
09:56:31.495 [TX] - 57 0D
09:56:31.509 [RX] - 57 30 30 30 2E 30 0D 0D 0A
09:56:33.425 [TX] - 49 0D
09:56:33.441 [RX] - 49 33 2E 35 30 0D 0D 0A
09:57:06.929 [TX] - 49 0D
09:57:06.946 [RX] - 49 30 2E 37 30 0D 0D 0A
    
```

When setting is without A, the terminator for responded message on the display is 0x0D 0x0A as shown in the diagram below.

```

Communication
ASCII [HEX] Decimal Binary
09:59:54.214 [TX] - 56 0D
09:59:54.229 [RX] - 56 31 32 2E 30 30 0D 0A
09:59:58.715 [TX] - 56 0D
09:59:58.730 [RX] - 56 35 2E 30 30 0D 0A
10:00:01.394 [TX] - 41 0D
10:00:01.408 [RX] - 41 30 2E 30 30 30 0D 0A
10:00:01.995 [TX] - 57 0D
10:00:02.008 [RX] - 57 30 2E 30 0D 0A
10:00:03.051 [TX] - 55 0D
10:00:03.068 [RX] - 55 36 30 0D 0A
10:00:03.652 [TX] - 49 0D
10:00:03.667 [RX] - 49 33 2E 35 30 0D 0A
    
```

On the other hand, you can judge if setting is with A by the readback voltage value.

When you see the readback voltage value insert an "0" digit before first digit if for voltage value less than 10, it means that setting is with A.

For example, if readback voltage value is 5V as the diagram shown below, it means that setting is with A.



ASCII	HEX	Decimal	Binary
09:56:18.587 [TX]	-	V	
09:56:18.603 [RX]	-	V12.00	
09:56:27.012 [TX]	-	V	
09:56:27.028 [RX]	-	V05.00	
09:56:30.395 [TX]	-	A	
09:56:30.410 [RX]	-	A0.000	
09:56:31.495 [TX]	-	W	
09:56:31.509 [RX]	-	W000.0	

Otherwise, it is setting without A as the diagram shown below.

Communication			
ASCII	HEX	Decimal	Binary
09:59:54.214 [TX]	-	V	
09:59:54.229 [RX]	-	V12.00	
09:59:58.715 [TX]	-	V	
09:59:58.730 [RX]	-	V5.00	
10:00:01.394 [TX]	-	A	
10:00:01.408 [RX]	-	A0.000	
10:00:01.995 [TX]	-	W	
10:00:02.008 [RX]	-	W0.0	

# FAQ

Q1. No Display.

---

A1.

- Ensure the power supply is turned on.
- Ensure the mains cable is properly inserted and power is on.  
Check the fuse assembly.

Q2. The front panel keys are inactive.

---

A2.

- The panel lock or remote control is activated. See page 24, 25.

For more information, contact your local dealer or GWInstek at [www.gwinstek.com.tw](http://www.gwinstek.com.tw) / [marketing@goodwill.com.tw](mailto:marketing@goodwill.com.tw).

# APPENDIX

## Fuse Replacement

---

- Step 3. Take off the power cord and remove the fuse socket using a minus driver.

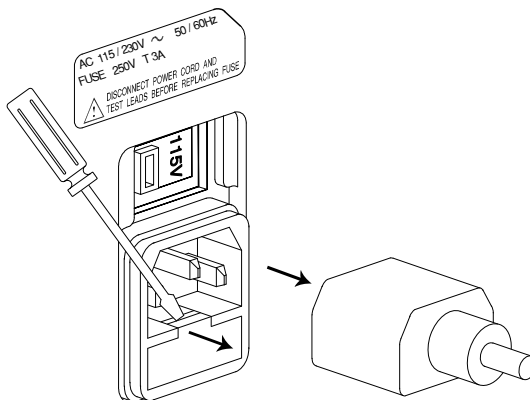

4. Replace the fuse in the holder.

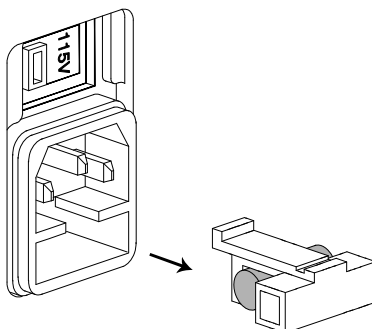

---

Rating T3.15A/250V

## Fan

---

Cooling fan      The PSP has a temperature or load controlled fan. The fan will be activated when the temperature or current exceeds a set level (model specific).

Model	PSP-405	PSP-603	PSP-2010
Fan On	45°C±5°C	45°C±5°C	45°C±5°C
	2.10A±50mA	1.40±50mA	2.10±50mA
Fan Off	40°C±5°C	40°C±5°C	40°C±5°C
	1.80A±50mA	1.20A±50mA	1.80A±50mA

## Specification

Model	PSP-603	PSP-405	PSP-2010
Operating voltage	115/230 VAC $\pm 15\%$		
Power frequency	50/60 Hz		
Power consumption	approx. 420VA max.		
Power output	200W max.		
Output voltage	0~60VDC 20mV resolution	0~40VDC 10mV resolution	0~20VDC 10mV resolution
Program Accuracy	$\pm 0.05\% \pm 4$ digits	$\pm 0.05\% \pm 3$ digits	$\pm 0.05\% \pm 3$ digits
Output Current	0~3.5A 10mA resolution	0~5A 10mA resolution	0~10A 10mA resolution
Program Accuracy	$\pm 0.1\% \pm 5$ digits	$\pm 0.1\% \pm 5$ digits	$\pm 0.3\% \pm 10$ digits
Voltage Load Regulation	$\leq 10$ mV		
Current Load Regulation	$\leq 5$ mA		
Voltage Line Regulation.	$\leq 0.05\%$		
Current Line Regulation	$\leq 0.05\%$		
Ripple Voltage	$\leq 20$ mV rms		
Ripple Current	$\leq 10$ mArms		
Readback Resolution(Meter)	20mV 2mA	10mV 2mA	10mV 5mA
Response Time	Rise Time	$\leq 150$ ms( $\leq 95\%$ rating load)	
	Full Time	$\leq 150$ ms( $\geq 10\%$ rating load)	
Recovery Time	30ms(50% Load Change, Minimum load 0.5A)		
	Readback Accuracy (Meter)		
Voltage	$\pm 0.05\% \pm 4$ digits	$\pm 0.05\% \pm 3$ digits	$\pm 0.05\% \pm 3$ digits

Current	$\pm 0.1\% \pm 5$ digits	$\pm 0.1\% \pm 5$ digits	$\pm 0.3\% \pm 10$ digits
Digital Display	Multi-line LCD with background lighting		
AC fuse	Slow-blow T6.3A/250V for 115V, T3.15A/250V for 230V		
Weight	Approx. 4 kg		
Dimensions (W × H × D)	Approx. 225×100×305 mm (excluding stand and power cable)		

## Declaration of Conformity

We

**GOOD WILL INSTRUMENT CO., LTD.**

Declare that the below mentioned product

**Model Number:** PSP-405, PSP-603, PSP-2010

satisfies all technical relations application to the product within the scope of council:

Directive: 2014/30/EU, 2014/35/EU, 2011/65/EU, 2012/19/EU

The above product is in conformity with the following standards or other normative documents:

© EMC	
EN 61326-1: EN 61326-2-1:	Electrical equipment for measurement, control and laboratory use -- EMC requirements (2013)
Conducted & Radiated Emission EN 55011: 2009+A1:2010 Class A	Electrical Fast Transients EN 61000-4-4: 2012
Current Harmonics EN 61000-3-2: 2014	Surge Immunity EN 61000-4-5: 2014
Voltage Fluctuations EN 61000-3-3:2013	Conducted Susceptibility EN 61000-4-6: 2014
Electrostatic Discharge EN 61000-4-2: 2009	Power Frequency Magnetic Field EN 61000-4-8: 2010
Radiated Immunity EN 61000-4-3: 2006+A2: 2010	Voltage Dip/ Interruption EN 61000-4-11: 2004

### © Safety

Low Voltage Equipment Directive 2014/35/EU	
Safety Requirements	EN 61010-1: 2010

**GOOD WILL INSTRUMENT CO., LTD.**

No. 7-1, Jhongsing Road, Tucheng Dist., New Taipei City 236, Taiwan

Tel: +886-2-2268-0389

Fax: +866-2-2268-0639

Web: [www.gwinstek.com](http://www.gwinstek.com)

Email: [marketing@goodwill.com.tw](mailto:marketing@goodwill.com.tw)

**GOOD WILL INSTRUMENT (SUZHOU) CO., LTD.**

No. 521, Zhujiang Road, Snd, Suzhou Jiangsu 215011, China

Tel: +86-512-6661-7177

Fax: +86-512-6661-7277

Web: [www.instek.com.cn](http://www.instek.com.cn)

Email: [marketing@instek.com.cn](mailto:marketing@instek.com.cn)

**GOOD WILL INSTRUMENT EURO B.V.**

De Run 5427A, 5504DG Veldhoven, The Netherlands

Tel: +31(0)40-2557790

Fax: +31(0)40-2541194

Email: [sales@gw-instek.eu](mailto:sales@gw-instek.eu)

# INDEX

Caution symbol .....	2, 29
Cleaning the instrument .....	4
Coarse mode .....	24
Command	
format .....	33
parameter .....	33
syntax .....	33
terminators .....	34
Current limit settings .....	19
Display overview .....	12
EN61010	
measurement category .....	3
pollution degree .....	4
Fine mode .....	24
front panel overview .....	10
fuse	
replacing .....	57
Fuse	
safety instruction .....	3
General precautions .....	5
ground symbol .....	2
Key panel lock .....	24
Main features .....	8
No display	
faq .....	56
Normal mode .....	24
Operating environment .....	4
Operation .....	17
Output .....	22
panel keys	
faq .....	56
Percentage offset output .....	22
Percentage offset settings .....	23
Power limit settings .....	20
Power supply	
safety instruction .....	3
Power up sequence .....	15
PSP series lineup .....	9
Rear panel overview .....	14
remote control .....	26
Remote Panel Lock .....	25
RS-232C configuration .....	28
Safety guidelines .....	3
service contact point .....	56
Single power supply	
connection .....	15
Step resolution .....	24
Storage environment .....	5
UK power cord .....	6
Voltage limit settings .....	18
Voltage output settings .....	21
Warning symbol .....	2