

Spectrum Analyzer

GSP-930

PROGRAMMING MANUAL

REVISION 1.0 May, 2012



ISO-9001 CERTIFIED MANUFACTURER

GW INSTEK

This manual contains proprietary information, which is protected by copyright. All rights are reserved. No part of this manual may be photocopied, reproduced or translated to another language without prior written consent of Good Will company.

The information in this manual was correct at the time of printing. However, Good Will continues to improve products and reserves the rights to change specification, equipment, and maintenance procedures at any time without notice.

Good Will Instrument Co., Ltd.
No. 7-1, Jhongsing Rd., Tucheng Dist., New Taipei City 236, Taiwan.

Table of Contents

SAFETY INSTRUCTIONS	2
GETTING STARTED.....	7
GSP-930 Introduction	8
Accessories.....	10
Appearance.....	12
REMOTE CONTROL.....	23
Interface Configuration	24
Command Syntax	35
Status Registers	40
Command List	49

S SAFETY INSTRUCTIONS

This chapter contains important safety instructions that you must follow during operation and storage. Read the following before any operation to insure your safety and to keep the instrument in the best possible condition.

Safety Symbols

These safety symbols may appear in this manual or on the instrument.



Warning: Identifies conditions or practices that could result in injury or loss of life.



Caution: Identifies conditions or practices that could result in damage to the instrument or to other properties.



DANGER High Voltage



Attention Refer to the Manual



Earth (ground) Terminal



Frame or Chassis Terminal



Do not dispose electronic equipment as unsorted municipal waste. Please use a separate collection facility or contact the supplier from which this instrument was purchased.

Safety Guidelines

General Guideline



CAUTION

- Do not place any heavy object on the instrument.
- Avoid severe impact or rough handling that leads to damaging the instrument.
- Do not discharge static electricity to the instrument.
- Use only mating connectors, not bare wires, for the terminals.
- Ensure signals to the RF input do not exceed +30dBm.
- Ensure reverse power to the TG output terminal does not exceed +30dBm.
- Do not supply any input signals to the TG output.
- Do not block the cooling fan opening.
- Do not disassemble the instrument unless you are qualified.

(Measurement categories) EN 61010-1:2010 specifies the measurement categories and their requirements as follows. The instrument falls under category II.

- Measurement category IV is for measurement performed at the source of low-voltage installation.
- Measurement category III is for measurement performed in the building installation.
- Measurement category II is for measurement performed on the circuits directly connected to the low voltage installation.
- Measurement category I is for measurements performed on circuits not directly connected to Mains.

Power Supply



WARNING

- AC Input voltage range: 100V~240V
 - Frequency: 50/60Hz
 - To avoid electrical shock connect the protective grounding conductor of the AC power cord to an earth ground.
-

Battery



CAUTION

- Rating: 10.8V, 6 cell Li-ion battery
- Turn off the power and remove the power cord before installing or removing the battery.

Cleaning

- Disconnect the power cord before cleaning.
- Use a soft cloth dampened in a solution of mild detergent and water. Do not spray any liquid.
- Do not use chemicals containing harsh material such as benzene, toluene, xylene, and acetone.

Operation Environment

- Location: Indoor, no direct sunlight, dust free, almost non-conductive pollution (Note below)
- Temperature: 5°C to 45°C
- Humidity: <90%

(Pollution Degree) EN 61010-1:2010 specifies the pollution degrees and their requirements as follows. The instrument falls under degree 2.

Pollution refers to “addition of foreign matter, solid, liquid, or gaseous (ionized gases), that may produce a reduction of dielectric strength or surface resistivity”.

- Pollution degree 1: No pollution or only dry, non-conductive pollution occurs. The pollution has no influence.
- Pollution degree 2: Normally only non-conductive pollution occurs. Occasionally, however, a temporary conductivity caused by condensation must be expected.
- Pollution degree 3: Conductive pollution occurs, or dry, non-conductive pollution occurs which becomes conductive due to condensation which is expected. In such conditions, equipment is normally protected against exposure to direct sunlight, precipitation, and full wind pressure, but neither temperature nor humidity is controlled.

Storage environment

- Location: Indoor
- Temperature: -20°C to 70°C
- Humidity: <90%

Disposal

Do not dispose this instrument as unsorted municipal waste. Please use a separate collection facility or contact the supplier from which this instrument was purchased. Please make sure discarded electrical waste is properly recycled to reduce environmental impact.

Power cord for the United Kingdom

When using the instrument in the United Kingdom, make sure the power cord meets the following safety instructions.

NOTE: This lead/appliance must only be wired by competent persons

 **WARNING: THIS APPLIANCE MUST BE EARTHED**

IMPORTANT: The wires in this lead are coloured in accordance with the following code:

Green/ Yellow:	Earth
Blue:	Neutral
Brown:	Live (Phase)



As the colours of the wires in main leads may not correspond with the coloured marking identified in your plug/appliance, proceed as follows:

The wire which is coloured Green & Yellow must be connected to the Earth terminal marked with either the letter E, the earth symbol  or coloured Green/Green & Yellow.

The wire which is coloured Blue must be connected to the terminal which is marked with the letter N or coloured Blue or Black.

The wire which is coloured Brown must be connected to the terminal marked with the letter L or P or coloured Brown or Red.

If in doubt, consult the instructions provided with the equipment or contact the supplier.

This cable/appliance should be protected by a suitably rated and approved HBC mains fuse: refer to the rating information on the equipment and/or user instructions for details. As a guide, a cable of 0.75mm² should be protected by a 3A or 5A fuse. Larger conductors would normally require 13A types, depending on the connection method used.

Any exposed wiring from a cable, plug or connection that is engaged in a live socket is extremely hazardous. If a cable or plug is deemed hazardous, turn off the mains power and remove the cable, any fuses and fuse assemblies. All hazardous wiring must be immediately destroyed and replaced in accordance to the above standard.

GETTING STARTED

This chapter provides a brief overview of the GSP-930, the package contents, instructions for first time use and an introduction to the front panel, rear panel and GUI.

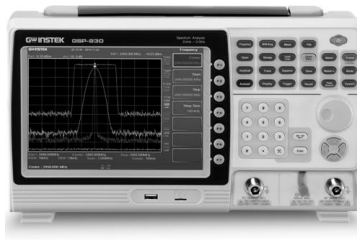

GSP-930 Introduction	8
Main Features.....	8
Accessories	10
Package Contents	11

GSP-930 Introduction

The GSP-930 is the most advanced spectrum analyzer GW Instek has produced to date. The GSP-930 features a split window display to view data in spectrum, topographic or spectrographic views.

Main Features

- | | |
|-------------|--|
| Performance | <ul style="list-style-type: none">• 9kHz~3GHz bandwidth• 1Hz resolution• Nominal RBW accuracy of 5% <750kHz, 8% @>750kHz• Video bandwidth 1Hz~1MHz (10 steps)• Amplitude measurement range: DANL~30dBm (frequency dependent)• Input attenuation: 0 ~ 50dB• Phase noise: < -88dBc/Hz@1GHz, 10kHz |
|-------------|--|
-

- | | |
|----------|--|
| Features | <ul style="list-style-type: none">• 10%-step increments for RBW bandwidth• Three display modes: Spectrum, Topographic and Spectrographic• Split window display• Built-in EMI filter• Auto Wake-up• Built-in preamplifier• Gate sweep• Marker Frequency counter• Two operating modes: Spectrum and Power Meter mode• SEM measurement• ACPR measurement• OCBW measurement |
|----------|--|
-

- Channel power measurement
 - Demodulation analyzer
 - Diverse marker functions and features with Peak Table
 - Sequence function to automatically perform pre-programmed sequential operations
 - Optional battery operation
-

Interface

- 8.4 color LCD (800×600)
- On-screen menu icons
- DVI-I video output
- RS-232 with RTS/CTS hardware flow control
- USB 2.0 with support for USB TMC
- LAN TCP/IP with LXI support
- Optional GPIB/IEEE488 interface
- IF output @ 886MHz
- Headphone output
- REF (reference clock) input/output BNC ports
- Alarm/Open collector output BNC port
- Trigger/Gate input BNC ports
- RF N-type input port
- Tracking generator output
- DC +7V/500mA output SMB port

Accessories

Standard Accessories	Part number	Description
	Region dependant	User manual
	Region dependant	Power cord
Options	Option number	Description
	Opt1.	Tracking generator
	Opt2.	Battery (11.1V/5200mAH Li-ion battery)
	Opt3.	GPIB interface (IEEE 488 bus)
Optional Accessories	Part number	Description
	PWS-06	USB Average Power Sensor (up to 6200 MHz; -32 to 20 dBm)
	GRA-415	6U Rack mount kit

Package Contents

Check the contents before using the GSP-930.

Opening the box

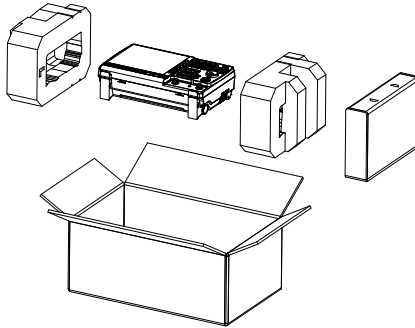

Contents
(single unit)



- Main unit
(may include optional GPIB, TG output)
- Quick Start manual
- User Manual CD
- Power cord x1 (region dependent)
- Optional battery pack
- Calibration certificate

Appearance

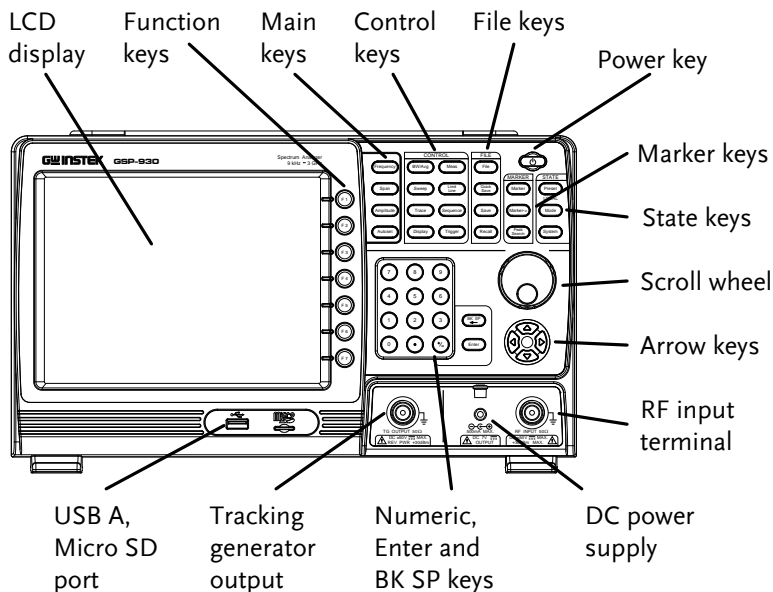

GSP-930 Front Panel







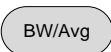
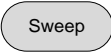
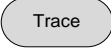
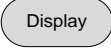
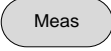
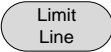
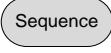

LCD display 800×600 color LCD display. The display shows the soft keys for the current function, frequency, amplitude and marker information.

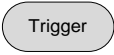
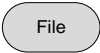
Function keys  ~  The F1 to F7 function keys directly correspond to the soft keys on the right-hand side of display.

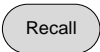
Main keys  Sets the center frequency, start frequency, stop frequency, center frequency step and frequency offset values.

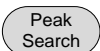
		Sets the span, with options for full span, zero span and last span.
		Sets the amplitude reference level, attenuation, pre-amplifier controls, scale and other options for attenuation and scale.
		Automatically searches the peak signal with maximum amplitude and displays it with appropriate horizontal and vertical scales.
Control keys		Sets the resolution bandwidth, video bandwidth, average type and turns the EMI filter on/off.
		Sets the sweep time and gate time.
		Sets traces and trace related functions.
		The Display key configures the windowing mode and basic display properties.
		Accesses measurement options such as ACPR, OCBW, demodulation measurements, SEM, TOI and other advanced measurements.
		Sets and tests Pass/Fail limit lines.
		Access, set and edit program sequences.

		Sets the triggering modes.
File		File utilities options
		The Quick Save utility allows you to save either the state, trace, screen limit line, correction or sequence with only a single press.
		Save the trace, state etc., and save options.
		Recall the trace, state etc., and recall options.
Marker		Turns the Markers on/off and configures the markers.
		The <i>Marker-></i> key positions the markers on the trace.
		Finds each maximum and minimum peak. Used with the Marker function.
State		The <i>Preset</i> key will restore the spectrum analyzer to the Factory or User-defined settings.
		The Preset key will also return the instrument back to local control after it has been in remote control mode.



The *Mode* key sets the spectrum analyzer to either Spectrum or Power Meter mode.

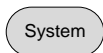

The System key shows system information, settings and other system related functions.

Power key

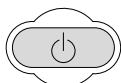

Turns the instrument on/off.

Scroll wheel

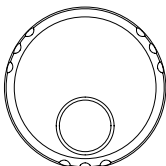

Edit values, select listed items.

Arrow keys

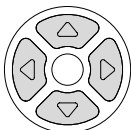

Increment/decrement values (in steps), select listed items.

RF input terminal

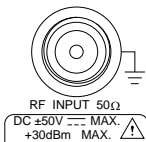

RF input port. Accepts RF inputs.

- Maximum input: +33dBm
- Input impedance: 50Ω
- Maximum DC voltage: ±50V
- N-type: female

DC power supply

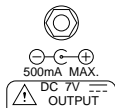

SMB port supplies power for optional accessories.

- DC +7V
- 500mA Max.

Numeric keypad

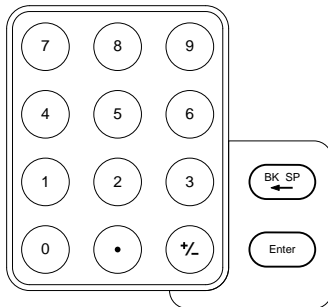

The numeric keypad is used to enter vales and parameters. It is often used in conjunction with the arrow keys and scroll wheel.

TG output port

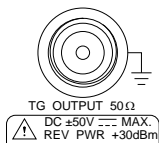

The Tracking Generator (TG) output source.

- N-type: female
- Input impedance: 50Ω
- Output power: -50dBm to 0dBm
- Maximum reversed power: +30dBm

USB A, Micro SD



USB A port, Micro SD port for saving/recalling settings/files.

Rear Panel

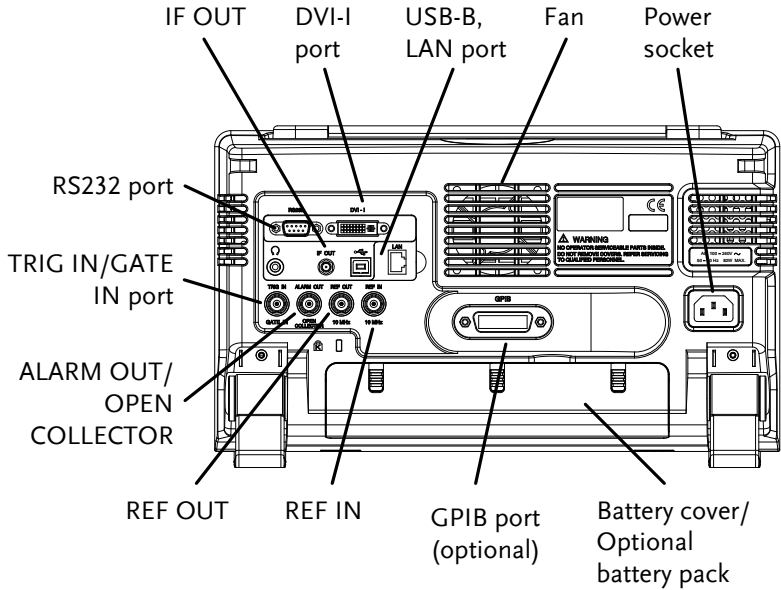

RS232

RS232

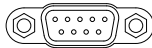

RS232 9 pin DSUB port.

IF OUT

IF OUT



SMA IF Out port.

DVI-I

DVI - I

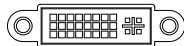

DVI video out port. Supports SVGA (800X600) @ 60Hz.

Fan

Power Socket

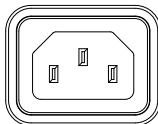

Power Socket:
100~240V, 50/60Hz.

Battery pack

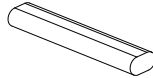

Voltage: 10.8V
Capacity: 5200mAH

REF IN

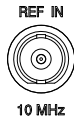

BNC female reference input.

REF OUT

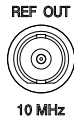

BNC female reference output:
10MHz, 50Ω impedance

Security Lock



ALARM OUT



BNC female open collector Alarm output.

TRIG IN/GATE IN

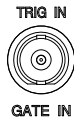

BNC female 3.3V CMOS trigger input/gated sweep input.

Phone



3.5mm stereo headphone jack
(wired for mono operation)

USB B



USB B Device port. USB 1.1/2.0

LAN





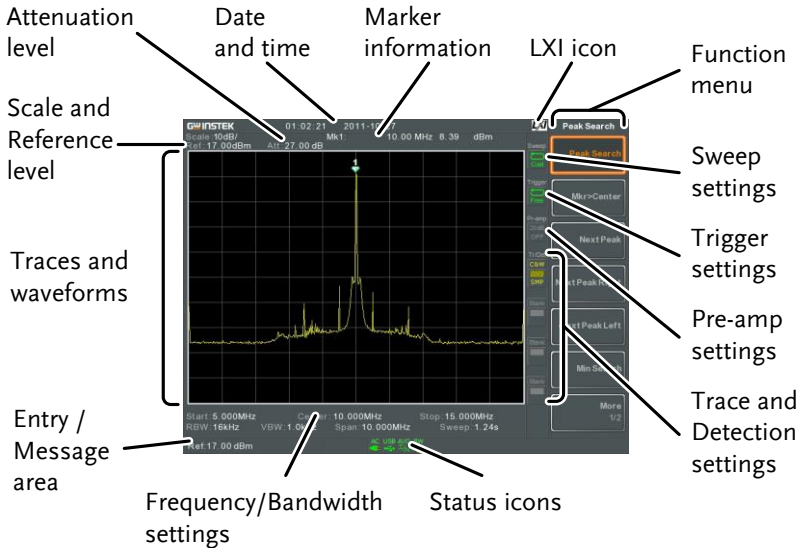

RJ-45 10Base-T/100Base-Tx











Display













- Reference level** Displays the reference level.
- Attenuation** Displays the vertical scale (attenuation) of the input signal.
- Date/Time** Displays the date and time.
- Marker information** Displays marker information.
- LXI icon** This icon indicates the status of the LXI connection. For details, see page 25.
- Function menu** Soft menu keys associated with the F1 to F7 function keys to the right of the display.

Sweep settings		Sweep icon that shows the sweep status.
Trigger settings		Trigger icon that shows the trigger status.
Pre-amp settings		Pre-amplifier icon that shows the Pre-amplifier status.
Trace and detection settings		Trace icon that shows the trace type and the detection mode used for each trace.
Status Icons	Displays the interface status, power source status, and alarm status, etc. See the Status Icon Overview on page 21 for a list of the status icons.	
Frequency/ Bandwidth settings	Displays the Start, Center and Stop frequencies, RBW, VBW, Span and Sweep settings.	
Entry/Message area	This area is used to show system messages, errors and input values/parameters.	
Trace and waveforms	Main display showing the input signals, traces, limit lines and marker positions.	

Status Icon Overview

PreAmp		Indicates that the pre amplifier is on.
AC		Shown when running on AC power.
AC Charge		Shown when the AC power is charging the battery.
Alarm Off		Alarm buzzer output is currently off.
Alarm On		Alarm buzzer output is currently on.
Amplitude Offset		Indicates that the amplitude-shift is active. This icon appears when amplitude-related functions are used: Reference level offset Amplitude Correction Input Z = 75Ω Input Z cal >0
Battery indicator	 ~ 	Indicates the battery charge.
Bandwidth Indicator		Indicates that the RBW or VBW settings are in manual mode.
Average		Indicates that the Average function is active.

External Lock		Indicates that the system is now locked and refers to the external reference input signal
External Trigger		External trigger signal is being used.
Math		Trace math is being used.
Sequence Indicator		Shown when a sequence is running.
Sweep Indicator		Indicates that the sweep time is manually set.
Tracking generator		Indicates the tracking generator is turned on.
TG Normalization		Indicates that the tracking generator has been normalized.
Wake-up clock		Indicates that the wake-up clock is turned on.
USB		Indicates that a USB flash drive is inserted into the front panel and is recognized.
Micro SD		Indicates that a micro SD card is inserted into the front panel and is recognized.

RREMOTE CONTROL

This chapter describes the basic configuration of IEEE488.2 based remote control. This chapter includes interface configuration, a remote control overview as well as the control syntax and commands.

Interface Configuration	24
Command Syntax	35
Status Registers	40
Command List	49

Interface Configuration

Configure to USB Remote Interface

USB configuration	PC side connector	Type A, host
	GSP side connector	Rear panel Type B, slave
	Speed	1.1/2.0 (full speed/high speed)
	USB Class	USB TMC (USB T&M class)



Note

Before communication with the GSP-930 via the USB interface, make sure **NI-Visa** has been properly installed on the PC beforehand.

(NI-Visa 3.0 or above supports USB TMC)

Panel operation

1. Connect the USB cable to the rear panel USB B port. 
2. Press **System** > *More 1/2[F7]* > *RmtInterface Config[F2]* > *USB Mode* and toggle the USB mode to *Device*.



Note

It may take a few moments to switch USB modes.

Configure GPIB Interface

To use GPIB, the optional GPIB port must be installed.

Configure GPIB

1. Ensure the spectrum analyzer is off before proceeding.

2. Connect a GPIB cable from a GPIB controller to the GPIB port on the spectrum analyzer.

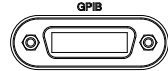

3. Turn the spectrum analyzer on.
4. Press **System** > More 1/2 [F7] > RmtInterface Config [F2] > GPIB Addr and set the GPIB address.

GPIB address 0~30

- GPIB constraints
- *Maximum 15 devices altogether, 20m cable length, 2m between each device*
 - *Unique address assigned to each device*
 - *At least 2/3 of the devices turned On*
 - *No loop or parallel connection*

Configure the LAN and LXI Interface

The GSP-930 is a class C LXI compliant instrument. The LXI specification allows instrumentation to be configured for basic remote control or monitoring over a LAN.

For details on the LXI specification and compliance classes, please see the LXI website @ <http://www.lxistandard.org>.

Background	The LAN interface is used for remote control over a network. The spectrum analyzer supports DHCP connections so the instrument can be automatically connected to an existing network. Alternatively, network settings can also be manually configured. The LAN port supports Auto-MDIX.
------------	---

LAN configuration Settings	IP Address	Default Gateway
	Subnet Mask	DNS Server
	DHCP on/off	

Connection Connect an Ethernet cable from the network to the rear panel LAN port. 

- Settings
- Press  >More 1/2[F7]>RmtInterface>LAN[F2]>LAN Config[F1] to set the LAN settings:
 - IP Address[F1]* Sets the IP address.
 - Subnet Mask[F2]* Sets the subnet mask.
 - Default*
 - Gateway[F3]* Sets the default gateway.
 - DNS Server[F4]* Sets the DNS server address
 - LAN Config[F5]* Toggles the LAN configuration between DHCP and manual settings.
 - Press *Apply[F6]* to confirm the LAN configuration settings.

Display Icon  The LXI icon turns green when connected to a LAN and will flash if the “Identification” setting is on, see page 31.

Set Password The password on the LXI webpage can be set from the spectrum analyzer. The password is shown in the system information.

By default the password is set to: lxiWNpwd

- Press  >More 1/2[F7]>RmtInterface Config[F2]>LAN[F2]>LXIPassword[F2] to set the password.

- Enter the password using the F1~F7 keys, as shown below, or use the numeric keypad to enter numbers:

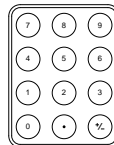

Limitations:

- No spaces
- Only 1~9, A~Z, a~z characters allowed

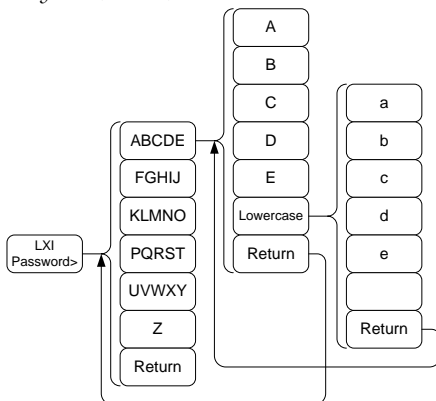

Menu tree to enter the password

- The password appears on the bottom of the screen as it is created.



Password

- Press  to confirm setting the password.

Reset LAN

It may be necessary to reset the LAN configuration settings before the LAN can be used.

7. Press  >More 1/2[F7]>RmtInterface Config[F2]>LAN Reset[F3] to reset the LAN.
 8. The GSP-930 will now automatically reboot.
-



Note

Each time the LAN is reset, the default password is restored.

Default password: lxiWNpwd

Configure RS232C

Background The RS232C interface is used for remote control with a PC.

RS232C Configuration settings	Baud Rate	Stop bit: 1 (fixed)
	Parity: none (fixed)	Data bit: 8 (fixed)

Connection Connect an RS232C cable from the PC to the rear panel RS232 port.

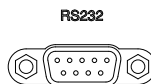

- Press **System** > More 1/2 [F7] > RmtInterface Config > RS232 BaudRate [F4] to set the baud rate.

300	600	1200
2400	4800	9600
19200	38400	57600
115200		

RS232C Remote Control Function Check

Functionality check Invoke a terminal application such as MTTY (Multi-Threaded TTY).

To check the COM port No, see the Device Manager in the PC. For WinXP; Control panel → System → Hardware tab.

Run this query command via the terminal after the instrument has been configured for RS232 remote control (page 26).

*idn?

This should return the Manufacturer, Model

number, Serial number, and Firmware version in the following format.

- *GWINSTEK,GSP-930,XXXXXXXXXXXXX,
V.X.X.X.X*

Manufacturer: GWINSTEK

Model number : GSP-930

Serial number : XXXXXXXXXXXXX

Firmware version : V.X.X.X



Note

For further details, please see the programming manual, available on the GW Instek web site @ www.gwinstek.com.

LXI Browser Interface and Function Check

Functionality check

Enter the IP address of the spectrum analyzer in a web browser after the instrument has been configured and connected to the LAN (page 25).

http:// XXX.XXX.XXX.XXX

The web browser interface appears:

Welcome Page

The Welcome Page lists all the LXI and LAN configuration settings as well as the instrument identification. The instrument identification can be disabled from this page.

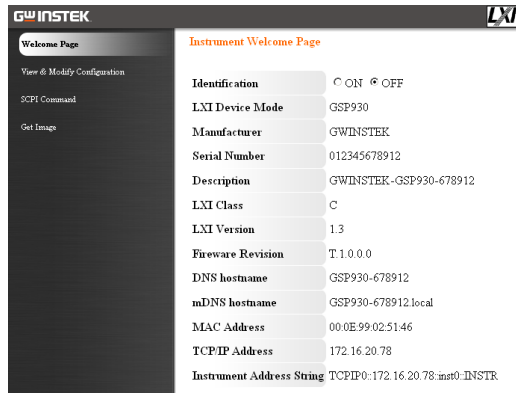

 Note



The LXI icon in the GSP-930 display will flash when the Identification setting is turned on.

View & Modify Configuration

The View & Modify Configuration allows you to modify the LAN settings from the browser. A password must be entered to alter the settings.

Password: lxiWNpwd
 [Note: password is case sensitive.]

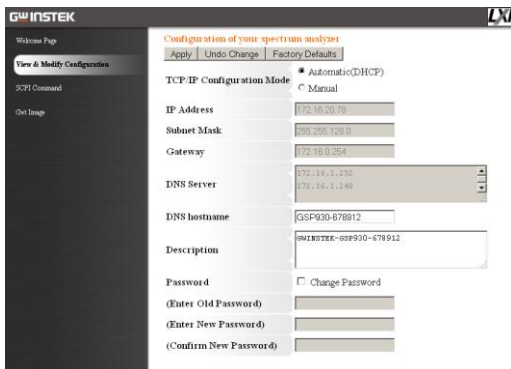

Note

If the “Factory Defaults” option is chosen, the password will be reset back to the default password

It will also be necessary to manually reset the spectrum analyzer when a message prompts you to do so on the web browser.

SCPI Command

The SCPI Command page allows you to enter SCPI commands directly from the browser for full remote control. Please see the programming manual for details. A password must be entered before remote commands can be used.

Password: lxiWNpwd
 [Note: password is case sensitive.]

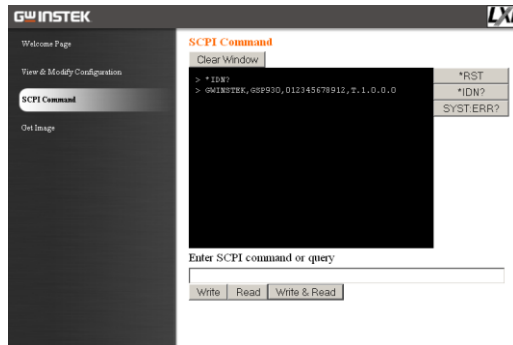

Get Image

The Get Image page allows the browser to remotely capture a screenshot of the GSP-930 display.

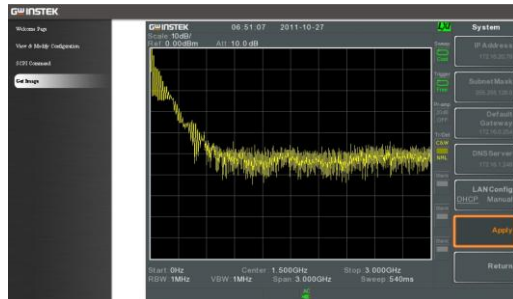

Note

For further details, please see the programming manual, available on the GW Instek web site @ www.gwinstek.com.

GPIB/LAN Control Function Check

Functionality
check

Please use the National Instruments
Measurement & Automation Controller
software to confirm GPIB/LAN functionality.

See the National Instrument website,
<http://www.ni.com> for details.



Note

For further details, please see the programming
manual, available on the GW Instek web site @
www.gwinstek.com.

Command Syntax

Compatible Standard	IEEE488.2	Full compatibility
	SCPI, 1999	Full compatibility

Command Structure

SCPI (Standard Commands for Programmable Instruments) commands follow a tree-like structure, organized into nodes. Each level of the command tree is a node. Each keyword in a SCPI command represents each node in the command tree. Each keyword (node) of a SCPI command is separated by a colon (:).

For example, the diagram below shows an SCPI sub-structure and a command example.

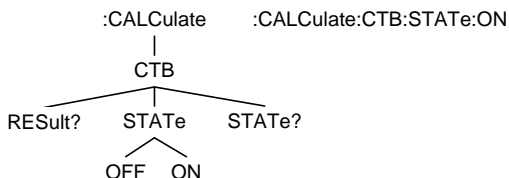

Command types

There are a number of different instrument commands and queries. A command sends instructions or data to the unit and a query receives data or status information from the unit.

Command types

Simple A single command with/without a parameter

Example *RST

Query	A query is a simple or compound command followed by a question mark (?). A parameter (data) is returned.
-------	--

Example	CALCulate:CSO:STATe?
---------	----------------------

Compound	Two or more commands on the same command line. Compound commands are separated with either a semi-colon (;) or a semi-colon and a colon (;:).
----------	---

A semi-colon is used to join two related commands, with the caveat that the last command must begin at the last node of the first command.

A semi-colon and colon are used to combine two commands from different nodes.

Example	calc:ctb:stat on;result?
---------	--------------------------

Command Forms Commands and queries have two different forms, long and short. The command syntax is written with the short form of the command in capitals and the remainder (long form) in lower case.

The commands can be written in capitals or lower-case, just so long as the short or long forms are complete. An incomplete command will not be recognized.

Below are examples of correctly written commands.

Long form	CALCulate:ACPR:STATe? calculate:acpr:state? CALCULATE:ACPR:STATE?
Short form	CALC:ACPR:STAT? calc:acpr:stat?

Square Brackets Commands that contain square brackets indicate that the contents are optional. The function of the command is the same with or without the square bracketed items, as shown below.

Both “:OUTPut[:STATe]?” and “:OUTPut?” are both valid forms.

Command Format

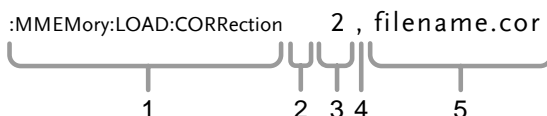

- | | |
|-------------------|--|
| 1. Command header | 4. Comma (no space before/after comma) |
| 2. Space | 5. Parameter 2 |
| 3. Parameter 1 | |

Common	Type	Description	Example	
Input Parameters	<Boolean>	Boolean logic	0, 1	
	<NR1>	integers	0, 1, 2, 3	
	<NR2>	decimal numbers	0.1, 3.14, 8.5	
	<NR3>	floating point	4.5e-1, 8.25e+1	
	<NRf>	any of NR1, 2, 3	1, 1.5, 4.5e-1	
	<freq>	Input: <NRf> + unit	2.5 mhz Unit = kHz, MHz, GHz. Note: The unit can be omitted (unit defaults to Hz). Return: <NR3>	2.5e+5 Note: Units = Hz.
	<limit num>	<NR1>		
	<point>	<NR1>		
	<offset>	Input: <NRf> + unit	30 db Note: The unit can be omitted (unit defaults to dB). Return: <NR3>	3.0e+1 Note: Units = dB.
	<rel_ampl>	Input: <NRf> + unit	20 db Note: The unit can be omitted (unit defaults to dB). Return: <NR3>	2.0e+1 Note: Units = dB.

<ampl> Input: 30 mv
 NR3 +unit type
 Note: The unit can be omitted.
 (Unit defaults to current y-axis
 unit).
 Return:
 <NR3> 3.0e-2
 Note: Units = current y axis unit.

<trace name> <NR1> trace1

<time> Input:
 <NR3> + unit 2.3e-6 ms
 Unit = ms, ns, ps, ks
 Note: The unit can be omitted
 (unit defaults to seconds).
 Return:
 <NR3> 3.0e-2
 Note: Units = seconds.

<ip address> <String> 172.16.20.20

Message LF Line feed code (0x0A)
 Terminator

Status Registers

Status Registers Overview

Description The status registers are used to determine the status of the spectrum analyzer. The status registers maintain the status of the pass/fail limits, trigger status and other operation statuses.

The status registers are arranged in a number of groups:

- *Questionable Status Registers*
- *Standard Event Status Registers*
- *Operation Status Registers*
- *Status Byte Register*
- *Service Request Enable Register*
- *Error/Event Queue*
- *Output Buffer*

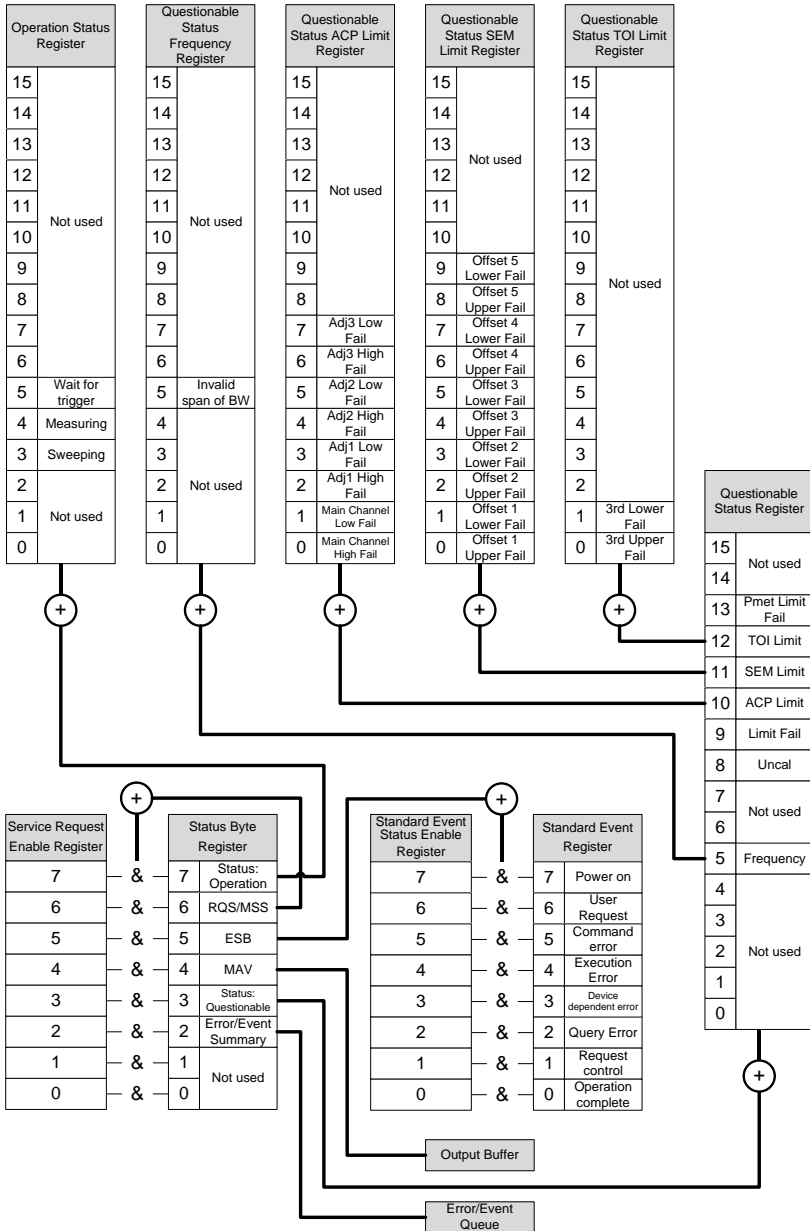

Status Register Structure	<p>Each status register (excluding the status byte register) is divided into a number of register structures:</p> <ul style="list-style-type: none">• <i>Condition register</i>• <i>Positive transition register</i>• <i>Negative transition register</i>• <i>Event Register</i>• <i>Event Enable Register</i>
Condition Registers	<p>The condition registers report the state of the GSP-930. Condition registers can only be read.</p>
PTR Registers	<p>The positive transition registers are used to filter for events that occur from a negative to a positive transition.</p>
NTR Registers	<p>The negative transition registers are used to filter for events that occur from a positive to negative transition.</p>
Event Registers	<p>The PTR/NTP registers dictate the type transition conditions that will set the corresponding bits in the event registers. The event registers can only be read. Reading an event register will clear it.</p>
Event Enable Registers	<p>The event enable registers determine which events in the corresponding event registers will set the summary bits in a higher-order register.</p>

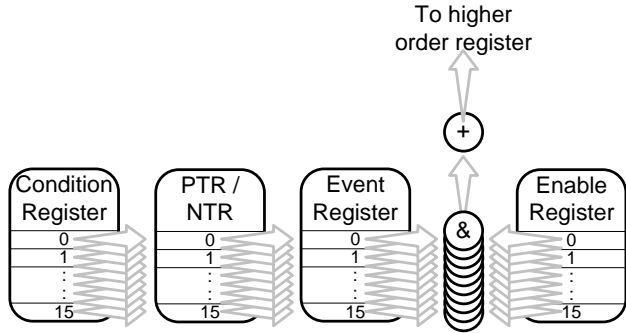

Status Byte Register (STB)

Overview

The Status Byte register consolidates the status events of all the status registers. The Status Byte register can be cleared with the *CLS command.

Any bits set in the Status byte register acts as a summary register for all the other status registers and indicates if there is a service request, an error in the Error Queue or data in the Output Queue. Reading the Status Byte register will reset the register to 0.

The Service Request Enable Register controls which bits in the Status Byte Register are able to generate service requests.

Bit Summary	Bit	Weight	Description
	2	4	Error/Event Queue Summary bit: This bit is set when there is a message in the error queue.
	3	8	Questionable Status Summary Bit: This is the summary bit for the Questionable Status Register.
	4	16	MAV: This bit is set when there is a message in the output queue.

5	32	ESB: This is the summary bit for the Standard Event Register.
6	64	MSS/RQS: The MSS bit is the summary bit for the Service Request Enable Register. The RQS bit is set to 1 when the MSS bit is set to 1.
7	128	Operation Status Summary Bit: This is the summary bit for the Operation Status Register.

Standard Event Status Register (ESR)

Overview The Standard Event Status Register Group indicates if any errors have occurred or fail limits tripped. Reading this register will clear the register.

Bit Summary	Bit	Weight	Description
	2	4	Query Error: When a query error has occurred, this bit is set to 1.
	3	8	Device-Specific Error: When a device dependent error has occurred, this bit is set to 1.
	4	16	Execution Error: When an execution error has occurred, this bit is set to 1.
	5	32	Command Error: When a command error has occurred, this bit is set to 1.
	6	64	User Request: When a panel key is pressed, this bit is set to 1.
	7	128	Power On: When the instrument is turned off → on, this bit is set to 1.

Operation Status Register

Overview The Operation Status Register Group indicates the operating status of the GSP-930.

Bit Summary	Bit	Weight	Description
	3	8	Sweeping: Indicates that a sweep is in progress.
	4	16	Measuring: The instrument is currently performing a measurement.
	5	32	Waiting for Trigger: The instrument is in a “wait for trigger” state.

Questionable Status Register

Overview The Questionable Status Register Group indicates if any limits have been tripped.

Bit Summary	Bit	Weight	Description
	5	32	Frequency Status Summary Bit: This is the summary bit of the Frequency Status Register.
	8	256	Uncal: This bit is set when a signal level occurs because the sweep is too fast.
	9	512	Limit fail: This bit is set to 1 when the limit line has been violated.
	10	1024	ACP Limit Status Summary Bit: This is the summary bit for the ACP Limit Status Register.
	11	2048	SEM Limit Status Summary Bit: This is the summary bit for the SEM Limit Status Register.
	12	4096	TOI Limit Status Summary Bit: This is the summary bit for the TOI Limit Status Register.
	13	8192	Pmet Limit Fail: This bit is set to 1 when the power meter limit has been violated.

Questionable Status Frequency Register

Overview The Questionable Status Frequency Register indicates if the span or BW settings are invalid.

Bit Summary	Bit	Weight	Description
	5	32	Invalid Span or BW: This bit is set to 1 when there is an invalid span or bandwidth (setting) during the frequency count.

Questionable Status ACP Limit Register

Overview The Questionable Status ACP Limit Register Group indicates if any adjacent channel limits have been tripped.

Bit Summary	Bit	Weight	Description
	0	1	Main Channel High Fail: This bit is set to 1 when the Main CH HLimit has been violated.
	1	2	Main Channel Low Fail: This bit is set to 1 when the Main CH LLimit has been violated.
	2	4	Adj1 High Fail: This bit is set to 1 when the ADJCH 1 HLimit has been violated.
	3	8	Adj1 Low Fail: This bit is set to 1 when the ADJCH 1 LLimit has been violated.
	4	16	Adj2 High Fail: This bit is set to 1 when the ADJCH 2 HLimit has been violated.
	5	32	Adj2 Low Fail: This bit is set to 1 when the ADJCH 2 LLimit has been violated.
	6	64	Adj3 High Fail: This bit is set to 1 when the ADJCH 3 HLimit has been violated.
	7	128	Adj3 Low Fail: This bit is set to 1 when the ADJCH 3 LLimit has been violated.

Questionable Status SEM Limit Register

Overview The Questionable Status SEM Limit Register Group indicates if any of the SEM offset limits have been tripped.

Bit Summary	Bit	Weight	Description
	0	1	Offset 1 Upper Fail: This bit is set to 1 when the SEM Offset 1 upper limit has been violated.
	1	2	Offset 1 Lower Fail: This bit is set to 1 when the SEM Offset 1 lower limit has been violated.
	2	4	Offset 2 Upper Fail: This bit is set to 1 when the SEM Offset 2 upper limit has been violated.
	3	8	Offset 2 Lower Fail: This bit is set to 1 when the SEM Offset 2 lower limit has been violated.
	4	16	Offset 3 Upper Fail: This bit is set to 1 when the SEM Offset 3 upper limit has been violated.
	5	32	Offset 3 Lower Fail: This bit is set to 1 when the SEM Offset 3 lower limit has been violated.
	6	64	Offset 4 Upper Fail: This bit is set to 1 when the SEM Offset 4 upper limit has been violated.
	7	128	Offset 4 Lower Fail: This bit is set to 1 when the SEM Offset 4 lower limit has been violated.
	8	256	Offset 5 Upper Fail: This bit is set to 1 when the SEM Offset 5 upper limit has been violated.
	9	512	Offset 5 Lower Fail: This bit is set to 1 when the SEM Offset 5 lower limit has been violated.

Questionable Status TOI Limit Register

Overview The Questionable Status TOI Limit Register Group indicates if the 3rd Order Upper or Lower limit has been tripped.

Bit Summary	Bit	Weight	Description
	0	1	3rd Upper Fail: This bit is set to 1 when the 3rd Order Upper limit has been tripped.
	1	2	3rd Lower Fail: This bit is set to 1 when the 3rd Order Lower limit has been tripped.

Command List

SCPI Commands	*CLS	59
	*IDN?	59
	*ESE	60
	*ESR?	60
	*OPC	60
	*RST	61
	*SRE	61
	*STB?	61
	*TST?	61
	*WAI	62
CALCulate Commands	:CALCulate:ACPR:ACHannel<n>:HLIMit:FAIL?	64
	:CALCulate:ACPR:ACHannel<n>:LLIMit:FAIL?	64
	:CALCulate:ACPR:ACHannel<n>:LOWer?	65
	:CALCulate:ACPR:ACHannel<n>:UPPer?	65
	:CALCulate:ACPR:ACHannel<n>:STATe	65
	:CALCulate:ACPR:CHANnel:HLIMit:FAIL?	66
	:CALCulate:ACPR:CHANnel:LLIMit:FAIL?	66
	:CALCulate:ACPR:CHPower?	66
	:CALCulate:ACPR:STATe	67
	:CALCulate:CNR:RESult?	67
	:CALCulate:CNR:STATe	67
	:CALCulate:CSO:RESult?	68
	:CALCulate:CSO:STATe	68
	:CALCulate:CTB:RESult?	69
	:CALCulate:CTB:STATe	69
	:CALCulate:CTB:REStart	69
	:CALCulate:DELTaMarker<n>:PAIR:SPAN	69
	:CALCulate:DELTaMarker<n>:PAIR:CENTer	70
	:CALCulate:DELTaMarker<n>:X	70
	:CALCulate:DELTaMarker<n>:Y?	70
	:CALCulate:DEMod:AM:RESult:CURRent?	71
	:CALCulate:DEMod:AM:RESult:MINimum?	71
	:CALCulate:DEMod:AM:RESult:MAXimum?	72
	:CALCulate:DEMod:AM:STATe	72
	:CALCulate:DEMod:EARPhone:STATe	73
	:CALCulate:DEMod:FM:RESult:CURRent?	73
	:CALCulate:DEMod:FM:RESult:MINimum?	73

:CALCulate:DEMod:FM:RESult:MAXimum?	74
:CALCulate:DEMod:FM:STATe	74
:CALCulate:DEMod:RESet	75
:CALCulate:JITTer:STATe	75
:CALCulate:JITTer:CARRier:POWer?	75
:CALCulate:JITTer:PHASe?	76
:CALCulate:JITTer:TIME?	76
:CALCulate:LIMit<n>:CLEar	76
:CALCulate:LIMit<n>:DATA	76
:CALCulate:LIMit:FAIL?	77
:CALCulate:LIMit:LOW	77
:CALCulate:LIMit:HIGH	77
:CALCulate:LIMit<n>:MARKer	78
:CALCulate:LIMit:PASS:MODE	78
:CALCulate:LIMit:STATe	78
:CALCulate:LIMit<n>:TRACe	79
:CALCulate:MARKer:AOFF	79
:CALCulate:MARKer<n>:FCOunt:RESolution	79
:CALCulate:MARKer<n>:FCOunt:RESolution:AUTO.80	80
:CALCulate:MARKer<n>:FCOunt:STATe	80
:CALCulate:MARKer<n>:FCOunt:X?	81
:CALCulate:MARKer<n>:NOISe:STATe	81
:CALCulate:MARKer<n>:NOISe:Y?	81
:CALCulate:MARKer<n>:PEAK	82
:CALCulate:MARKer:PEAK:CTRack:STATe	82
:CALCulate:MARKer:PEAK:DATA?	83
:CALCulate:MARKer:PEAK:EXCursion	83
:CALCulate:MARKer:PEAK:SORT:TYPE	83
:CALCulate:MARKer:PEAK:TABLE:STATe	84
:CALCulate:MARKer:PEAK:THReshold	84
:CALCulate:MARKer:PEAK:THReshold:STATe	84
:CALCulate:MARKer<n>:SET	85
:CALCulate:MARKer<n>:STATe	85
:CALCulate:MARKer:TABLE:STATe	86
:CALCulate:MARKer<n>:TRACe	86
:CALCulate:MARKer<n>:TRACe:AUTO	87
:CALCulate:MARKer<n>:TYPE	87
:CALCulate:MARKer<n>:X	87
:CALCulate:MARKer<n>:Y?	88
:CALCulate:MATH:PDIF	88
:CALCulate:MATH:LDIF	88
:CALCulate:MATH:LOFF	89
:CALCulate:NDB:STATe	89
:CALCulate:NDB:BANDwidth BWIDth?	90

	:CALCulate:NORMalize:STATe.....	90
	:CALCulate:OCBW:STATe	90
	:CALCulate:OCBW:BANDwidth BWIDth?	91
	:CALCulate:OCBW:CHPower?.....	91
	:CALCulate:OCBW:POWer?.....	91
	:CALCulate:PMETer:POWer?	91
	:CALCulate:PMETer:LIMit:STATe	92
	:CALCulate:PMETer:LIMit:FAIL?.....	92
	:CALCulate:SEM:STATe.....	92
	:CALCulate:SEM:OFFSet<n>:RESult?	93
	:CALCulate:TOI:DIFFerential?	93
	:CALCulate:TOI:FREQuency:DIFFerential?.....	94
	:CALCulate:TOI:LIMit:STATe	94
	:CALCulate:TOI:RESult?	94
	:CALCulate:TOI:STATe.....	95
CONFigure Commands	:CONFigure:MODE	95
DISPlay Commands	:DISPlay:BRIGhtness.....	97
	:DISPlay:ENABle	97
	:DISPlay:DEMod[:WINDow]:TRACe:X[:SCALe]:AUTO	97
	:DISPlay:DEMod[:WINDow]:TRACe:X[:SCALe] :PDIVision	98
	:DISPlay:DEMod[:WINDow]:TRACe:X[:SCALe] :RPOsition	98
	:DISPlay:DEMod[:WINDow]:TRACe:X[:SCALe] :RVALue.....	99
	:DISPlay:DEMod[:WINDow]:TRACe:Y[:SCALe]:AUTO	99
	:DISPlay:DEMod[:WINDow]:TRACe:Y[:SCALe] :PDIVision	99
	:DISPlay:DEMod[:WINDow]:TRACe:Y[:SCALe] :RPOsition	100
	:DISPlay:DEMod[:WINDow]:TRACe:Y[:SCALe] :RVALue.....	100
	:DISPlay[:WINDow]:NORMal	100
	:DISPlay[:WINDow]:SPECTrogram	101
	:DISPlay[:WINDow]:SPLit:NORMal:ALTernate.....	101
	:DISPlay[:WINDow]:SPLit:NORMal:ACTive	101

	:DISPlay[:WINDow]:SPLit:SPECtrogram	101
	:DISPlay[:WINDow]:SPLit:TOPO	102
	:DISPlay[:WINDow]:TOPO	102
	:DISPlay[:WINDow]:TRACe<n>:MODE	102
	:DISPlay[:WINDow]:TRACe:Y:DLINe	102
	:DISPlay[:WINDow]:TRACe:Y:DLINe:STATe	103
	:DISPlay[:WINDow]:TRACe:Y[:SCALE]:NRLevel	103
	:DISPlay[:WINDow]:TRACe:Y[:SCALE]:NRPosition..	104
	:DISPlay[:WINDow]:TRACe:Y[:SCALE] :PDIVision...	104
	:DISPlay[:WINDow]:TRACe:Y[:SCALE]:POSition.....	104
	:DISPlay[:WINDow]:TRACe:Y[:SCALE]:RLEVel	105
	:DISPlay[:WINDow]:TRACe:Y[:SCALE]:RLEVel:OFFSet	105
	:DISPlay[:WINDow]:TRACe:Y[:SCALE]:SPACing.....	105
	:DISPlay[:WINDow]:TRACe:Y[:SCALE]:STATe	106
INITiate	:INITiate:CONTInuous	107
Commands	:INITiate[:IMMediate]	107
INPut	:INPut:ATTenuation	108
Commands	:INPut:ATTenuation:AUTO	108
	:INPut:IMPedance	109
	:INPut:OFFSet	109
MMEMory	:MMEMory:CATalog?	110
commands	:MMEMory:CDIRectory.....	111
	:MMEMory:COPI	111
	:MMEMory:DELete	112
	:MMEMory:DESTination.....	112
	:MMEMory:LOAD:CORRection	113
	:MMEMory:LOAD:LIMit	113
	:MMEMory:LOAD:PMETer.....	113
	:MMEMory:LOAD:SEQuence	113
	:MMEMory:LOAD:STATe.....	114
	:MMEMory:LOAD:TRACe	114
	:MMEMory:MOVE	114
	:MMEMory:REName	115
	:MMEMory:STORe:CORRection.....	115
	:MMEMory:STORe:LIMit.....	115
	:MMEMory:STORe:PMETer	115
	:MMEMory:STORe:SCReen	116

	:MMEMory:STORe:SEQuence.....	116
	:MMEMory:STORe:STATe.....	116
	:MMEMory:STORe:TRACe.....	117
OUTPut commands	:OUTPut[:STATe]	117
SENSe commands	[[:SENSe]:ACPR:ACHannel<n>:BANDwidth BWIDth	121
	[[:SENSe]:ACPR:ACHannel<n>:HLIMit	121
	[[:SENSe]:ACPR:ACHannel<n>:LLIMit	121
	[[:SENSe]:ACPR:ACHannel<n>:OFFSet.....	122
	[[:SENSe]:ACPR:BANDwidth BWIDth	122
	[[:SENSe]:ACPR:HLIMit.....	122
	[[:SENSe]:ACPR:LLIMit.....	123
	[[:SENSe]:ACPR:HELP:STATe	123
	[[:SENSe]:ACPR:SPACe	123
	[[:SENSe]:ASET:AMPLitude	124
	[[:SENSe]:ASET:AMPLitude:AUTO	124
	[[:SENSe]:ASET:RUN	124
	[[:SENSe]:ASET:SPAN.....	125
	[[:SENSe]:ASET:SPAN:AUTO	125
	[[:SENSe]:AVERAge:COUNT.....	125
	[[:SENSe]:AVERAge:STATe	126
	[[:SENSe]:AVERAge:TYPE.....	126
	[[:SENSe]:BANDwidth BWIDth[:RESolution]	126
	[[:SENSe]:BANDwidth BWIDth[:RESolution]:AUTO.....	127
	[[:SENSe]:BANDwidth BWIDth:VIDeo	127
	[[:SENSe]:BANDwidth BWIDth:VIDeo:AUTO	128
	[[:SENSe]:CHANnel:SPACe:DOWN	128
	[[:SENSe]:CHANnel:SPACe:UP	128
	[[:SENSe]:CNR:CHANnel:SPACe.....	128
	[[:SENSe]:CNR:DELTamarker:MODE	129
	[[:SENSe]:CORRection:CSET<n>:DATA	129
	[[:SENSe]:CORRection:CSET<n>:STATe	130
	[[:SENSe]:CORRection:CSET<n>:DELete	130
	[[:SENSe]:CSO:CHANnel:SPACe	130
	[[:SENSe]:CTB:CHANnel:SPACe	131
	[[:SENSe]:DEMod:EARPhone:TYPE	131
	[[:SENSe]:DEMod:EARPhone:VOLume	131
	[[:SENSe]:DEMod:EARPhone:GAIN.....	132
	[[:SENSe]:DEMod:FILTer:LPASS.....	132

[SENSe]:DEMod:IFBW	133
[SENSe]:DETEctor[:FUNCTion]	133
[SENSe]:DETEctor[:FUNCTion]:AUTO	133
[SENSe]:EMIFilter:STATe.....	134
[SENSe]:EMIFilter:BANDwidth BWIDth[:RESolution]	134
.....	
[SENSe]:FREQuency:CENTer	135
[SENSe]:FREQuency:CENTer:STEP	135
[SENSe]:FREQuency:CENTer:STEP:AUTO.....	135
[SENSe]:FREQuency:OFFSet.....	136
[SENSe]:FREQuency:SPAN.....	136
[SENSe]:FREQuency:SPAN:FULL	136
[SENSe]:FREQuency:SPAN:PREVious.....	136
[SENSe]:FREQuency:STARt.....	137
[SENSe]:FREQuency:STOP	137
[SENSe]:LIMit<n>:DELeTe	137
[SENSe]:JITTer:OFFSet:STARt.....	137
[SENSe]:JITTer:OFFSet:STOP.....	138
[SENSe]:NDB:BANDwidth BWIDth	138
[SENSe]:OCBW:BANDwidth BWIDth.....	138
[SENSe]:OCBW:PERCent	139
[SENSe]:OCBW:SPACe	139
[SENSe]:PMETer:FREQuency	139
[SENSe]:PMETer:HLIMit.....	140
[SENSe]:PMETer:HOLD:STATe	140
[SENSe]:PMETer:LLIMit.....	140
[SENSe]:PMETer:PSEnsor:MODE.....	141
[SENSe]:PMETer:RECOrding:TIME.....	141
[SENSe]:PMETer:RECOrding:TIME:STEP	141
[SENSe]:POWEr[:RF]:GAIN	142
[SENSe]:SEMAsk:BANDwidth BWIDth:INTegration	142
[SENSe]:SEMAsk:BANDwidth BWIDth[:RESolution]	142
.....	
[SENSe]:SEMAsk:BANDwidth BWIDth	143
[:RESolution]:AUTO	143
[SENSe]:SEMAsk:CARRier:AUTO	143
[SENSe]:SEMAsk:CARRier:CPSD	144
[SENSe]:SEMAsk:CARRier:POWEr.....	144
[SENSe]:SEMAsk:FREQuency:SPAN.....	145
[SENSe]:SEMAsk:GWLan:MODulation.....	145
[SENSe]:SEMAsk:HELP:STATe	145
[SENSe]:SEMAsk:NWLan:CHANnel:	
BANDwidth BWIDth.....	146
[SENSe]:SEMAsk:OFFSet<n>:ADDition:	

BANDwidth BWIDth[:RESolution]?	146
[:SENSe]:SEMAsk:OFFSet<n>:ADDition:	
FREQuency:STARt?	148
[:SENSe]:SEMAsk:OFFSet<n>:ADDition:	
FREQuency:STOP?	148
[:SENSe]:SEMAsk:OFFSet<n>:ADDition:	
STARt:ABSolute?	149
[:SENSe]:SEMAsk:OFFSet<n>:ADDition:	
STOP:ABSolute?	149
[:SENSe]:SEMAsk:OFFSet<n>:BANDwidth	
BWIDth[:RESolution]	149
[:SENSe]:SEMAsk:OFFSet<n>:BANDwidth BWIDth[:R	
ESolution]:AUTO	150
[:SENSe]:SEMAsk:OFFSet<n>:FREQuency:STARt	150
[:SENSe]:SEMAsk:OFFSet<n>:FREQuency:STOP	151
[:SENSe]:SEMAsk:OFFSet<n>:STARt:ABSolute	151
[:SENSe]:SEMAsk:OFFSet<n>:STARt:RELative	151
[:SENSe]:SEMAsk:OFFSet<n>:STATe	152
[:SENSe]:SEMAsk:OFFSet<n>:STOP:ABSolute	152
[:SENSe]:SEMAsk:OFFSet<n>:STOP:ABSolute:COUPLE	
.....	152
[:SENSe]:SEMAsk:OFFSet<n>:STOP:RELative	153
[:SENSe]:SEMAsk:OFFSet<n>:STOP:RELative:COUPLE	
.....	153
[:SENSe]:SEMAsk:OFFSet<n>:TEST	154
[:SENSe]:SEMAsk:SELect	154
[:SENSe]:SEMAsk:TYPE	155
[:SENSe]:SEMAsk:W3GPP:DUPLex:TYPE	155
[:SENSe]:SEMAsk:W3GPP:FDD:ADDition:LIMit	156
[:SENSe]:SEMAsk:W3GPP:FDD:ADDition:MOPower	
.....	156
[:SENSe]:SEMAsk:W3GPP:FDD:MOPower	156
[:SENSe]:SEMAsk:W3GPP:FDD:TRANsmit:MODE	157
[:SENSe]:SEMAsk:W3GPP:TDD:CHIP:RATE	157
[:SENSe]:SEMAsk:W3GPP:TDD:MOPower	158
[:SENSe]:SEMAsk:W3GPP:TDD:TRANsmit:MODE	158
[:SENSe]:SEMAsk:WIMax:CHANnel:	
BANDwidth BWIDth	159
[:SENSe]:SEQuence<n>:DELete	159
[:SENSe]:SWEep:EGATe:DELay	159
[:SENSe]:SWEep:EGATe:LENGth	159
[:SENSe]:SWEep:EGATe:STATe	160
[:SENSe]:SWEep:TIME	160
[:SENSe]:SWEep:TIME:AUTO	160

	[:SENSe]:TOI:REFerence	161
	[:SENSe]:TOI:LIMit	161
SOURce	:SOURce:POWer[:LEVel][:IMMediate][:AMPLitude] ..	162
commands	:SOURce:POWer[:LEVel][:IMMediate][:AMPLitude]	
	:OFFSet	162
	:SOURce:POWer[:LEVel][:IMMediate][:AMPLitude]	
	:STEP	163
	:SOURce:POWer[:LEVel][:IMMediate][:AMPLitude]:	
	STEP:AUTO	163
	:SOURce:POWer:MODE	163
	:SOURce:POWer:SWEep	164
SYSTEM	:SYSTem:ALARm:STATe	165
commands	:SYSTem:CLOCK<n>:DATE	166
	:SYSTem:CLOCK<n>:MODE	166
	:SYSTem:CLOCK<n>:STATe	166
	:SYSTem:CLOCK<n>:TIME	167
	:SYSTem:COMMunicate:GPIB[:SELF]:ADDReSS	167
	:SYSTem:COMMunicate:LANReSet	167
	:SYSTem:COMMunicate:SERial[:RECeive]:BAUD	168
	:SYSTem:COMMunicate:USB:MODE	168
	:SYSTem:DATE	168
	:SYSTem:ERRor:CLear	168
	:SYSTem:ERRor[:NEXT]?	169
	:SYSTem:KLOCK	169
	:SYSTem:PRESet	169
	:SYSTem:PRESet:TYPE	169
	:SYSTem:PRESet:USER:SAVE	169
	:SYSTem:REBoot	170
	:SYSTem:SHUTdown	170
	:SYSTem:TIME	170
	:SYSTem:UPDate	170
	:SYSTem:VERSiOn:HARDware?	171
	:SYSTem:VERSiOn:SOFTware?	171
STATus	:STATus:OPERation:CONDition?	172
commands	:STATus:OPERation:ENABle	173
	:STATus:OPERation[:EVENT]?	173
	:STATus:OPERation:NTRansiOn	174
	:STATus:OPERation:PTRansiOn	174

	:STATus:QUESTionable:CONDition?	175
	:STATus:QUESTionable:ENABle	175
	:STATus:QUESTionable[:EVENT]t?	176
	:STATus:QUESTionable:NTRansition	176
	:STATus:QUESTionable:PTRansition	177
	:STATus:QUESTionable:FREQuency:CONDition?	177
	:STATus:QUESTionable:FREQuency:ENABle	178
	:STATus:QUESTionable:FREQuency[:EVENT]t?	178
	:STATus:QUESTionable:FREQuency:NTRansition	178
	:STATus:QUESTionable:FREQuency:PTRansition	179
	:STATus:QUESTionable:ACPLimit:CONDition?	179
	:STATus:QUESTionable:ACPLimit:ENABle	180
	:STATus:QUESTionable:ACPLimit[:EVENT]t?	180
	:STATus:QUESTionable:ACPLimit:NTRansition	181
	:STATus:QUESTionable:ACPLimit:PTRansition	181
	:STATus:QUESTionable:SEMLimit :CONDition?	182
	:STATus:QUESTionable:SEMLimit:ENABle?	182
	:STATus:QUESTionable:SEMLimit[:EVENT]t?	183
	:STATus:QUESTionable:SEMLimit :NTRansition	183
	:STATus:QUESTionable:SEMLimit:PTRansition	184
	:STATus:QUESTionable:TOILimit:CONDition?	185
	:STATus:QUESTionable:TOILimit:ENABle	185
	:STATus:QUESTionable:TOILimit[:EVENT]t?	186
	:STATus:QUESTionable:TOILimit:NTRansition	186
	:STATus:QUESTionable:TOILimit:PTRansition	186
	:STATus:PRESet	187
TRACe commands	:TRACe[:DATA]t?	187
TRIGger commands	:TRIGger[:SEQuence]:DELay	188
	:TRIGger[:SEQuence]:DEMod:DELay	188
	:TRIGger[:SEQuence]:DEMod:LEVel	189
	:TRIGger[:SEQuence]:DEMod:MODE	189
	:TRIGger[:SEQuence]:DEMod:SLOPe	189
	:TRIGger[:SEQuence]:DEMod:SOURce	190
	:TRIGger[:SEQuence]:EXTernal:SLOPe	190
	:TRIGger[:SEQuence]:MODE	190
	:TRIGger[:SEQuence]:PMETer:SOURce	191
	:TRIGger[:SEQuence]:SOURce	191
	:TRIGger[:SEQuence]:VIDeo:FREQuency	191
	:TRIGger[:SEQuence]:VIDeo:LEVel	192

	:TRIGger[:SEQuence]:VIDeo:SLOPe	192
UNIT commands	:UNIT:PMETer:POWer	193
	:UNIT:POWer	193

SCPI Commands

*CLS	59
*IDN?	59
*ESE	60
*ESR?	60
*OPC	60
*RST	61
*SRE	61
*STB?	61
*TST?	61
*WAI	62

*CLS

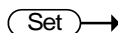

Description The *CLS command clears the Standard Event Status, Operation Status and Questionable Status registers. The corresponding Enable registers in each of the above registers are not cleared.

If a <NL> newline code immediately precedes a *CLS command, the Error Que and the MAV bit in the Status Byte Register is also cleared.

Syntax *CLS

*IDN?



Description Queries the manufacturer, model number, serial number, and firmware version of the instrument.

Query Syntax *IDN?

Return parameter <string> Returns the instrument identification as a string in the following format:

```
GWINSTEK,GSP-930,XXXXXXXXXXXX,V.X.X.X
Manufacturer: GWINSTEK
Model number : GSP-930
Serial number : XXXXXXXXXXXX
Firmware version : V.X.X.X
```

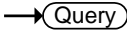
***ESE**

Description	Sets or queries the Standard Event Status Enable register.
Syntax	*ESE <NR1>
Query Syntax	*ESE?
Parameter	<NR1> 0~255
Return parameter	<NR1> Returns the bit sum of the Standard Event Status Enable register.



***ESR?**

Description	Queries the Standard Event Status register. The Event Status register is cleared after it is read.
Query Syntax	*ESR?
Return parameter	<NR1> Returns the bit sum of the Standard Event Status register and clears the register.

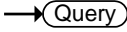
***OPC**

Description	<p>The *OPC command sets the OPC bit (bit0) of the Standard Event Status Register when all current commands have been processed.</p> <p>The *OPC? Query returns 1 when all the outstanding commands have completed.</p>
Syntax	*OPC
Query Syntax	*OPC?
Return parameter	1 Returns 1 when all the outstanding commands have completed.

***RST**

Set →

Description	*RST will perform a factory reset.
Syntax	*RST

***SRE**

Set →

→ Query

Description	Sets or queries the Service Request Enable register. The Service Request Enable register determines which registers of the Status Byte register are able to generate service requests.
Syntax	*SRE <NR1>
Query Syntax	*SRE?
Parameter	<NR1> 0~255
Return parameter	<NR1> Returns the bit sum of the Service Request Enable register.

***STB?**

→ Query

Description	Queries the bit sum of the Status Byte register with MSS (Master summary Status).
Query Syntax	*STB?
Return parameter	<NR1> Returns the bit sum of the Status Byte register with the MSS bit (bit 6).

***TST?**

→ Query

Description	Returns the result of a self-test. The GSP-930 does not support performing a selftest and thus will always return "0" for this query.
Query Syntax	*TST?
Return parameter	0 Returns "0"

*WAI



Description Prevents any other commands or queries from being executed until all outstanding commands have completed.

Syntax *WAI

CALCulate Commands

:CALCulate:ACPR:ACHannel<n>:HLIMit:FAIL?	64
:CALCulate:ACPR:ACHannel<n>:LLIMit:FAIL?	64
:CALCulate:ACPR:ACHannel<n>:LOWer?	65
:CALCulate:ACPR:ACHannel<n>:UPPer?	65
:CALCulate:ACPR:ACHannel<n>:STATe	65
:CALCulate:ACPR:CHANnel:HLIMit:FAIL?	66
:CALCulate:ACPR:CHANnel:LLIMit:FAIL?	66
:CALCulate:ACPR:CHPower?	66
:CALCulate:ACPR:STATe	67
:CALCulate:CNR:RESult?	67
:CALCulate:CNR:STATe	67
:CALCulate:CSO:RESult?	68
:CALCulate:CSO:STATe	68
:CALCulate:CTB:RESult?	69
:CALCulate:CTB:STATe	69
:CALCulate:CTB:REStart	69
:CALCulate:DELTamarker<n>:PAIR:SPAN	69
:CALCulate:DELTamarker<n>:PAIR:CENTer	70
:CALCulate:DELTamarker<n>:X	70
:CALCulate:DELTamarker<n>:Y?	70
:CALCulate:DEMod:AM:RESult:CURRent?	71
:CALCulate:DEMod:AM:RESult:MINimum?	71
:CALCulate:DEMod:AM:RESult:MAXimum?	72
:CALCulate:DEMod:AM:STATe	72
:CALCulate:DEMod:EARPhone:STATe	73
:CALCulate:DEMod:FM:RESult:CURRent?	73
:CALCulate:DEMod:FM:RESult:MINimum?	73
:CALCulate:DEMod:FM:RESult:MAXimum?	74
:CALCulate:DEMod:FM:STATe	74
:CALCulate:DEMod:RESet	75
:CALCulate:JITTer:STATe	75

:CALCulate:JITTer:CARRier:POWer?	75
:CALCulate:JITTer:PHASe?	76
:CALCulate:JITTer:TIME?	76
:CALCulate:LIMit<n>:CLEar	76
:CALCulate:LIMit<n>:DATA	76
:CALCulate:LIMit:FAIL?	77
:CALCulate:LIMit:LOW	77
:CALCulate:LIMit:HIGH	77
:CALCulate:LIMit<n>:MARKer	78
:CALCulate:LIMit:PASS:MODE	78
:CALCulate:LIMit:STATe	78
:CALCulate:LIMit<n>:TRACe	79
:CALCulate:MARKer:AOFF	79
:CALCulate:MARKer<n>:FCOunt:RESolution	79
:CALCulate:MARKer<n>:FCOunt:RESolution:AUTO	80
:CALCulate:MARKer<n>:FCOunt:STATe	80
:CALCulate:MARKer<n>:FCOunt:X?	81
:CALCulate:MARKer<n>:NOISe:STATe	81
:CALCulate:MARKer<n>:NOISe:Y?	81
:CALCulate:MARKer<n>:PEAK	82
:CALCulate:MARKer:PEAK:CTRack:STATe	82
:CALCulate:MARKer:PEAK:DATA?	83
:CALCulate:MARKer:PEAK:EXCursion	83
:CALCulate:MARKer:PEAK:SORT:TYPE	83
:CALCulate:MARKer:PEAK:TABLE:STATe	84
:CALCulate:MARKer:PEAK:THReshold	84
:CALCulate:MARKer:PEAK:THReshold:STATe	84
:CALCulate:MARKer<n>:SET	85
:CALCulate:MARKer<n>:STATe	85
:CALCulate:MARKer:TABLE:STATe	86
:CALCulate:MARKer<n>:TRACe	86
:CALCulate:MARKer<n>:TRACe:AUTO	87
:CALCulate:MARKer<n>:TYPE	87
:CALCulate:MARKer<n>:X	87
:CALCulate:MARKer<n>:Y?	88
:CALCulate:MATH:PDIF	88
:CALCulate:MATH:LDIF	88
:CALCulate:MATH:LOFF	89
:CALCulate:NDB:STATe	89
:CALCulate:NDB:BANDwidth BWIDth?	90
:CALCulate:NORMalize:STATe	90
:CALCulate:OCBW:STATe	90
:CALCulate:OCBW:BANDwidth BWIDth?	91
:CALCulate:OCBW:CHPPower?	91

:CALCulate:OCBW:POWer?91
 :CALCulate:PMETer:POWer?.....91
 :CALCulate:PMETer:LIMit:STATe.....92
 :CALCulate:PMETer:LIMit:FAIL?92
 :CALCulate:SEM:STATe92
 :CALCulate:SEM:OFFSet<n>:RESult?93
 :CALCulate:TOI:DIFFerential?.....93
 :CALCulate:TOI:FREQuency:DIFFerential?94
 :CALCulate:TOI:LIMit:STATe94
 :CALCulate:TOI:RESult?94
 :CALCulate:TOI:STATe.....95

**:CALCulate:ACPR:ACHannel<n>:HLIMit:
 FAIL?**

→ Query

Description	Returns the ACPR upper limit pass/fail judgment for the selected adjacent channel.	
Query Syntax	:CALCulate:ACPR:ACHannel<n>:HLIMit:FAIL?	
Parameter	<n>	<NR1>adjacent channel 1~3
Return parameter	0	<boolean>Pass
	1	<boolean>Fail
Query Example	:CALC:ACPR:ACH1:HLIM:FAIL? >0	

**:CALCulate:ACPR:ACHannel<n>:LLIMit:
 FAIL?**

→ Query

Description	Returns the ACPR lower limit pass/fail judgment for the selected adjacent channel.	
Query Syntax	:CALCulate:ACPR:ACHannel<n>:LLIMit:FAIL?	
Parameter	<n>	<NR1>adjacent channel 1~3
Return parameter	0	<boolean>Pass
	1	<boolean>Fail
Query Example	:CALC:ACPR:ACH1:LLIM:FAIL? >0	

:CALCulate:ACPR:ACHannel<n>:LOWer? → **Query**

Description	Returns the ACPR (adjacent channel power ratio in dB) calculated for the selected lower adjacent channel.	
Query Syntax	:CALCulate:ACPR:ACHannel<n>:LOWer?	
Parameter	<n>	<NR1>adjacent channel 1~3
Return parameter	<NR3>	Power ratio in dB
Query Example	:CALC:ACPR:ACH1:LOW? >1.801e+01	

:CALCulate:ACPR:ACHannel<n>:UPPer? → **Query**

Description	Returns the ACPR (adjacent channel power ratio in dB) calculated for the selected higher adjacent channel.	
Query Syntax	:CALCulate:ACPR:ACHannel<n>:UPPer?	
Parameter	<n>	<NR1>adjacent channel 1~3
Return parameter	<NR3>	Power ratio in dB
Query Example	:CALC:ACPR:ACH1:UPP? >1.921e+01	

Set →

:CALCulate:ACPR:ACHannel<n>:STATe → **Query**

Description	Sets or queries the state of the selected adjacent channel.	
Syntax	:CALCulate:ACPR:ACHannel<n>:STATe {OFF ON 0 1}	
Query Syntax	:CALCulate:ACPR:ACHannel<n>:STATe?	
Parameter	<n>	<NR1>adjacent channel 1~3
	0	Disable the selected channel.
	1	Enable the selected channel.
	OFF	Disable the selected channel.

	ON	Enable the selected channel.
Return parameter	0	The selected channel is disabled.
	1	The selected channel is enabled.
Query Example	:CALC:ACPR:ACH1:STAT? >1	

:CALCulate:ACPR:CHANnel:HLIMit:FAIL? → **Query**

Description	Returns the ACPR upper limit pass/fail judgment for the main channel. A pass indicates that every trace point in the main channel is lower than or equal to the upper limit.	
Query Syntax	:CALCulate:ACPR:CHANnel:HLIMit:FAIL?	
Return parameter	0	<boolean>Pass
	1	<boolean>Fail
Query Example	:CALC:ACPR:CHAN:HLIM:FAIL? >0	

:CALCulate:ACPR:CHANnel:LLIMit:FAIL? → **Query**

Description	Returns the ACPR lower limit pass/fail judgment for the main channel. A pass indicates that every trace point in the main channel is higher than or equal to the lower limit.	
Query Syntax	:CALCulate:ACPR:CHANnel:LLIMit:FAIL?	
Return parameter	0	<boolean>Pass
	1	<boolean>Fail
Query Example	:CALC:ACPR:CHAN:LLIM:FAIL? >0	

:CALCulate:ACPR:CHPower? → **Query**

Description	Returns the ACPR main channel power in the current chosen unit.	
-------------	---	--

Query Syntax :CALCulate:ACPR:CHPower?

Return parameter <NR3> Power

Query Example :CALC:ACPR:CHP?
>-1.028e+02

:CALCulate:ACPR:STATe

Set →

→ Query

Description Sets or queries the state of the ACPR measurement function.

Syntax :CALCulate:ACPR:STATe {OFF|ON|0|1}

Query Syntax :CALCulate:ACPR:STATe?

Parameter	0	ACPR is disabled.
	1	ACPR is enabled.
	OFF	ACPR is disabled.
	ON	ACPR is enabled.

Return parameter	0	ACPR is disabled.
	1	ACPR is enabled.

Query Example :CALC:ACPR:STAT?
>1

:CALCulate:CNR:RESult?

→ Query

Description Returns the CNR measurement result in dB.

Query Syntax :CALCulate:CNR:RESult?

Return parameter <NR3> CNR measurement in dB

Query Example :CALC:CNR:RES?
>-4.959e+01

:CALCulate:CNR:STATe

Set →

→ Query

Description Sets or queries the state of the CNR measurement function.

Syntax :CALCulate:CNR:STATe {ON|OFF|1|0}

Query Syntax	:CALCulate:CNR:STATe?	
Parameter	0	CNR is off.
	1	CNR is on.
	OFF	CNR is off.
	ON	CNR is on.
Return parameter	0	CNR is off.
	1	CNR is on.
Query Example	:CALC:CNR:STAT? >1	

:CALCulate:CSO:RESult? → Query

Description	Returns the CSO measurement result in dB.	
Query Syntax	:CALCulate:CSO:RESult?	
Return parameter	<NR3>	CSO measurement in dB
Query Example	:CALC:CSO:RES? >4.04e+00	

:CALCulate:CSO:STATe Set →
→ Query

Description	Sets or queries the state of the CSO measurement function.	
Syntax	:CALCulate:CSO:STATe {ON OFF 1 0}	
Query Syntax	:CALCulate:CSO:STATe?	
Parameter	0	CSO is off.
	1	CSO is on.
	OFF	CSO is off.
	ON	CSO is on.
Return parameter	0	CSO is off.
	1	CSO is on.
Query Example	:CALC:CSO:STAT? >1	

:CALCulate:CTB:RESult? → Query

Description	Returns the CTB measurement result in dB.	
Query Syntax	:CALCulate:CTB:RESult?	
Return parameter	<NR3>	CTB measurement in dB
Query Example	:CALC:CTB:RES? >-4.237e+01	

:CALCulate:CTB:STATe Set →
→ Query

Description	Sets or queries the state of the CTB measurement function.	
Syntax	:CALCulate:CTB:STATe {ON OFF 1 0}	
Query Syntax	:CALCulate:CTB:STATe?	
Parameter	0	CTB is off.
	1	CTB is on.
	OFF	CTB is off.
	ON	CTB is on.
Return parameter	0	CTB is off.
	1	CTB is on.
Query Example	:CALC:CTB:STAT? >0	

:CALCulate:CTB:REStart Set →

Description	Restarts the CTB measurement.
Syntax	:CALCulate:CTB:REStart

:CALCulate:DELTamarker<n>:PAIR:SPAN Set →

Description	Sets the span between the chosen marker and the delta marker.
-------------	---

Syntax	:CALCulate:DELTamarker<n>:PAIR:SPAN <freq>	
Parameter	<n>	Marker number.
	<freq>	<NRf> frequency of span.
Example	:CALC:DELT1:PAIR:SPAN 1e+9	

:CALCulate:DELTamarker<n>:PAIR:CENTer 

Description	Takes the current span between the chosen markers and relocates that center frequency to the chosen center frequency.	
Syntax	:CALCulate:DELTamarker<n>:PAIR:CENTer <freq>	
Parameter	<n>	Marker number.
	<freq>	<NRf> center frequency.
Example	:CALC:DELT1:PAIR:CENT 1e+9	

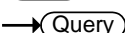
:CALCulate:DELTamarker<n>:X  

Description	Sets or queries the selected delta marker position.	
Syntax	:CALCulate:DELTamarker<n>:X <freq>	
Query Syntax	:CALCulate:DELTamarker<n>:X?	
Parameter	<n>	Marker number.
Return parameter	<freq>	<NR3> frequency in Hz.
Example	:CALC:DELT1:X? >1e+9	

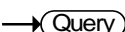
:CALCulate:DELTamarker<n>:Y? 

Description	Returns the selected delta marker Y axis value.	
Query Syntax	:CALCulate:DELTamarker<n>:Y?	

Parameter	<n>	Marker number.
Return parameter	<rel_ampl>	<NR3> in dB.
Example	:CALC:DELT1:Y? >-1.032e+1	

:CALCulate:DEMod:AM:RESult:CURRent? → **Query**

Description	Returns the current measurement results for AM demodulation as a comma separated string.	
Query Syntax	:CALCulate:DEMod:AM:RESult:CURRent?	
Return parameter	<depth,rate,power,offset,sinad>	
	depth	Modulation depth in %.
	rate	Modulation rate in Hz.
	power	Carrier power in the current Y-axis units.
	offset	Carrier frequency offset in Hz.
	sinad	Signal to noise and distortion ratio in dB
Query Example	:CALC:DEM:AM:RES:CURR? >9.840e+1,1.02e+2,-1.12e+1,3.21e+1,1.61e+1	

:CALCulate:DEMod:AM:RESult:MINimum? → **Query**

Description	Returns the minimum recorded measurement results for AM demodulation as a comma separated string.	
Query Syntax	:CALCulate:DEMod:AM:RESult:MINimum?	
Return parameter	<depth,rate,power,offset,sinad>	
	depth	Modulation depth in %.
	rate	Modulation rate in Hz.
	power	Carrier power in the current Y-axis units.
	offset	Carrier frequency offset in Hz.
	sinad	Signal to noise and distortion ratio in dB
Query Example	:CALC:DEM:AM:RES:MIN? >9.840e+1,1.02e+2,-1.12e+1,3.21e+1,1.61e+1	

:CALCulate:DEMod:AM:RESult:MAXimum? → **Query**

Description	Returns the maximum recorded measurement results for AM demodulation as a comma separated string.	
Query Syntax	:CALCulate:DEMod:AM:RESult:MAXimum?	
Return parameter	<depth,rate,power,offset,sinad>	
	depth	Modulation depth in %.
	rate	Modulation rate in Hz.
	power	Carrier power in the current Y-axis units.
	offset	Carrier frequency offset in Hz.
	sinad	Signal to noise and distortion ratio in dB.
Query Example	:CALC:DEM:AM:RES:MAX? >9.840e+1,1.02e+2,-1.12e+1,3.21e+1,1.61e+1	

Set →

:CALCulate:DEMod:AM:STATe → **Query**

Description	Sets or queries the state of the AM Analysis function.	
Syntax	:CALCulate:DEMod:AM:STATe {ON OFF 1 0}	
Query Syntax	:CALCulate:DEMod:AM:STATe?	
Parameter	0	Turn AM Analysis off.
	1	Turn AM Analysis on.
	OFF	Turn AM Analysis off.
	ON	Turn AM Analysis on.
Return parameter	0	AM Analysis is off.
	1	AM Analysis is on.
Example	:CALC:DEM:AM:STAT 1	

:CALCulate:DEMod:EARPhone:STATe (Set) →
→ (Query)

Description	Sets or queries the state of the ear phone out port.	
Syntax	:CALCulate:DEMod:EARPhone:STATe {ON OFF 1 0}	
Query Syntax	:CALCulate:DEMod:EARPhone:STATe?	
Parameter	0	Turn the phone output off.
	1	Turn the phone output on.
	OFF	Turn the phone output off.
	ON	Turn the phone output on.
Return parameter	0	Phone output is off.
	1	Phone output is on.
Example	:CALC:DEM:EARP:STAT 1	

:CALCulate:DEMod:FM:RESult:CURRent? → (Query)

Description	Returns the current measurement results for FM demodulation as a comma separated string.	
Query Syntax	:CALCulate:DEMod:FM:RESult:CURRent?	
Return parameter	<deviation,rate,power,offset,sinad>	
	deviation	Frequency deviation in Hz.
	rate	Modulation rate in Hz.
	power	Carrier power in the current Y-axis units.
	offset	Carrier frequency offset in Hz.
	sinad	Signal to noise and distortion ratio in dB.
Query Example	:CALC:DEM:FM:RES:CURR? >9.840e+1,1.02e+2,-1.12e+1,3.21e+1,1.61e+1	

:CALCulate:DEMod:FM:RESult:MINimum? → (Query)

Description	Returns the minimum recorded measurement results for FM demodulation as a comma separated string.	
Query Syntax	:CALCulate:DEMod:FM:RESult:MINimum?	

Return parameter	<deviation,rate,power,offset,sinad>	
	deviation	Frequency deviation in Hz.
	rate	Modulation rate in Hz.
	power	Carrier power in the current Y-axis units.
	offset	Carrier frequency offset in Hz.
	sinad	Signal to noise and distortion ratio in dB.

Query Example :CALC:DEM:FM:RES:MIN?
>9.840e+1,1.02e+2,-1.12e+1,3.21e+1,1.61e+1

:CALCulate:DEMod:FM:RESult:MAXimum? → **Query**

Description Returns the maximum recorded measurement results for FM demodulation as a comma separated string.

Query Syntax :CALCulate:DEMod:FM:RESult:MAXimum?

Return parameter	<deviation,rate,power,offset,sinad>	
	deviation	Frequency deviation in Hz.
	rate	Modulation rate in Hz
	power	Carrier power in the current Y-axis units.
	offset	Carrier frequency offset in Hz.
	sinad	Signal to noise and distortion ratio in dB.

Query Example :CALC:DEM:FM:RES:MAX?
>9.840e+1,1.02e+2,-1.12e+1,3.21e+1,1.61e+1

Set →

:CALCulate:DEMod:FM:STATe → **Query**

Description Sets or queries the state of the FM Analysis function.

Syntax :CALCulate:DEMod:FM:STATe {ON|OFF|1|0}

Query Syntax :CALCulate:DEMod:FM:STATe?

Parameter	0	Turn FM Analysis off.
	1	Turn FM Analysis on.
	OFF	Turn FM Analysis off.
	ON	Turn FM Analysis on.

Return parameter	0	FM Analysis is off.
	1	FM Analysis is on.
Example	:CALC:DEM:FM:STAT 1	

:CALCulate:DEMod:RESet (Set) →

Description This command will reset the max and min records for the current demodulation analysis.

Syntax :CALCulate:DEMod:RESet

:CALCulate:JITTer:STATe (Set) →
→ (Query)

Description Sets or queries the state of the Jitter Analysis function.

Syntax :CALCulate:JITTer:STATe {ON|OFF|1|0}

Query Syntax :CALCulate:JITTer:STATe?

Parameter	0	Turn Jitter Analysis off.
	1	Turn Jitter Analysis on.
	OFF	Turn Jitter Analysis off.
	ON	Turn Jitter Analysis on.

Return parameter	0	Jitter Analysis is off.
	1	Jitter Analysis is on.

Example :CALCulate:JITTer:STATe 1

:CALCulate:JITTer:CARRier:POWER? → (Query)

Description Returns the carrier power in the current Y-axis units.

Query Syntax :CALCulate:JITTer:CARRier:POWER?

Return parameter <NR3> In the current Y-axis units.

Query Example :CALC:JITT:CARR:POW?
>-5.237e+01

:CALCulate:JITTer:PHASe? → Query

Description	Returns the carrier phase jitter in radians.
Query Syntax	:CALCulate:JITTer:PHASe?
Return parameter	<NR3> Rad
Query Example	:CALC:JIT:PHAS? >1.5307e+01

:CALCulate:JITTer:TIME? → Query

Description	Returns the carrier jitter time in seconds.
Query Syntax	:CALCulate:JITTer:TIME?
Return parameter	<NR3> Seconds
Query Example	:CALC:JIT:TIME? >5.31e-08

:CALCulate:LIMit<n>:CLEar Set →

Description	Clears the High Limit, Low Limit and the Pass/Fail state for the selected limit line.
Syntax	:CALCulate:LIMit<n>:CLEar
Parameter	<n> Selected limit line
Example	:CALC:LIM1:CLE

:CALCulate:LIMit<n>:DATA Set →
→ Query

Description	Sets or queries the frequency, amplitude limit of every point in the selected limit line. The data is stored in CSV format. There are total of 10 pairs of data points (20 data entries in total) for the <csv data> data.
Syntax	:CALCulate:LIMit<n>:DATA <csv data>

Query Syntax	:CALCulate:LIMit<n>:DATA?	
Parameter/ Return parameter	<csv data>	pt#1 freq, pt#1 limit,pt#10 freq, pt#10 limit.
	<n>	Seleted limit line
Example	:CALCulate:LIMit3:DATA? >1e+6,-10,2e+6,-30,3e+6,-40,4e+6.....	

:CALCulate:LIMit:FAIL? → Query

Description	Returns the Pass/Fail judgment.	
Query Syntax	:CALCulate:LIMit:FAIL?	
Return parameter	0	Pass
	1	Fail
Query Example	:CALC:LIM:FAIL? >1	

:CALCulate:LIMit:LOW Set →

Description	Selects which limit line is used for the low limit.	
Syntax	:CALCulate:LIMit:LOW <limit num>	
Parameter	<limit num>	<NR1> 1~5
Example	:CALC:LIM:LOW 2	

:CALCulate:LIMit:HIGH Set →

Description	Selects which limit line is used for the high limit.	
Syntax	:CALCulate:LIMit:HIGH <limit num>	
Parameter	<limit num>	<NR1> 1~5
Example	:CALC:LIM:HIGH 2	

:CALCulate:LIMit<n>:MARKer (Set) →

Description	Sets the current marker position to a point on a limit line. The vertical position of the point is the marker's vertical position + a user-defined offset.	
Syntax	:CALCulate:LIMit<n>:MARKer <point>,<offset>	
Parameter	<point> <offset> <n>	<NR1> point 1~10 <NR3> dB Selected limit line
Example	:CALC:LIM1:MARK 5, 20	

**:CALCulate:LIMit:PASS:MODE (Set) →
→ (Query)**

Description	Sets or queries the Pass/Fail conditions for the limit line testing.	
Syntax	:CALCulate:LIMit:PASS:MODE {ALL MAX MIN}	
Query Syntax	:CALCulate:LIMit:PASS:MODE?	
Parameter/ Return Parameter	ALL MAX MIN	All-in. Max-In Min-In
Example	:CALC:LIM:PASS:MODE ALL	

**:CALCulate:LIMit:STATe (Set) →
→ (Query)**

Description	Turns the limit line Pass/Fail test on/off.	
Syntax	:CALCulate:LIMit:STATe {ON OFF 1 0}	
Query Syntax	:CALCulate:LIMit:STATe?	
Parameter	0 1 OFF ON	Pass/Fail test is off. Pass/Fail test is on. Pass/Fail test is off. Pass/Fail test is on.
Return parameter	0 1	Pass/Fail test is off. Pass/Fail test is on.

Example :CALC:LIM:STAT 1

:CALCulate:LIMit<n>:TRACe (Set) →

Description Creates a limit line from the currently selectly trace with a user defined offset.

Syntax :CALCulate:LIMit<n>:TRACe <offset>

Parameter <n> <NR1> limit line 1~5
<offset> <NR3> in dB

Example :CALC:LIM2:TRAC 10

:CALCulate:MARKer:AOff (Set) →

Description Turns all the markers off.

Syntax :CALCulate:MARKer:AOff

Example :CALC:MARK:AOff

:CALCulate:MARKer<n>:FCOunt:RESolution (Set) →
→ (Query)

Description Sets or queries the frequency counter resolution in Hz for the selected marker.

Syntax :CALCulate:MARKer<n>:FCOunt:RESolution <freq>

Query Syntax :CALCulate:MARKer<n>:FCOunt:RESolution?

Parameter <n> <NR1>Maker number 1~6*.
<freq> Frequency resolution in Hz**.

Return parameter <freq> Frequency resolution in Hz.

Note * Only one marker can be selected at a time to use the marker counter function.

The selected marker counter will disable the previously selected marker counter.

** Only 1000, 100, 10, 1 Hz are meaningful.

Example :CALC:MARK1:FCO:RES?
>1.0e+3

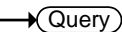
:CALCulate:MARKer<n>:FCOunt: 
RESolution:AUTO 

Description Sets the frequency counter resolution Auto setting on/off.

Syntax :CALCulate:MARKer<n>:FCOunt:RESolution:AUTO {ON|OFF|1|0}

Query Syntax :CALCulate:MARKer<n>:FCOunt:RESolution:AUTO?

Parameter	<n>	<NR1>Marker number 1~6
	0	Auto is off.
	1	Auto is on.
	OFF	Auto is off.
	ON	Auto is on.

Return parameter	0	Auto is off.
	1	Auto is on.

Example :CALC:MARK1:FCO:RES:AUTO?

:CALCulate:MARKer<n>:FCOunt:STATe 

Description Sets or queries the state of the frequency counter function.

Syntax :CALCulate:MARKer<n>:FCOunt:STATe {ON|OFF|1|0}

Query Syntax :CALCulate:MARKer<n>:FCOunt:STATe?

Parameter	<n>	<NR1>Marker number 1~6
	0	Turn frequency counter off.
	1	Turn frequency counter on.
	OFF	Turn frequency counter off.
	ON	Turn frequency counter on.

Return parameter	0	Frequency counter is off.
	1	Frequency counter is on.

Example :CALC:MARKer1:FCO:STAT 1

:CALCulate:MARKer<n>:FCOunt:X? → **Query**

Description Returns the counter frequency of the selected marker in Hz.

Query Syntax :CALCulate:MARKer<n>:FCOunt:X?

Parameter <n> <NR1> Marker number 1~6.

Return parameter <freq> <NR3> Frequency in Hz.

Example :CALC:MARK1:FCO:X?
>2.0083e+8

:CALCulate:MARKer<n>:NOISe:STATe → **Query**

Description Sets or queries the state of the Marker Noise function.

Syntax :CALCulate:MARKer<n>:NOISe:STATe {ON|OFF|1|0}

Query Syntax :CALCulate:MARKer<n>:NOISe:STATe?

Parameter	<n>	<NR1>Marker number 1~6.
	0	Turn marker noise off.
	1	Turn marker noise on.
	OFF	Turn marker noise off.
	ON	Turn marker noise on.

Return parameter	0	Marker noise is off.
	1	Marker noise is on.

Example :CALC:MARK2:NOIS:STAT ON

:CALCulate:MARKer<n>:NOISe:Y? → **Query**

Description Returns the normalized noise level over a BW of 1Hz from the marker position.

Query Syntax :CALCulate:MARKer<n>:NOISe:Y?

Parameter	<n>	<NR1> Marker number 1~6.
Return parameter	<NR3>	Normalized noise level in the Y-axis unit.
Example	:CALC:MARK1:NOIS:Y? >1.166e+2	

:CALCulate:MARKer<n>:PEAK (Set) →

Description	Sets the selected marker to the selected peak.	
Query Syntax	:CALCulate:MARKer<n>:PEAK {MAXimum MINimum NEXT RIGHT LEFT}	
Parameter	<n>	<NR1> Marker number 1~6
	MAXimum	Highest peak value
	MIMimum	Lowest peak value
	NEXT	Next peak
	RIGHT	Next peak right
	LEFT	Next peak left
Example	:CALC:MARK1:PEAK NEXT	

**:CALCulate:MARKer:PEAK:CTRack:STATe (Set) →
→ (Query)**

Description	Sets or queries the state of the Peak Track function. The Peak Track function only applies to the currently selected marker.	
Syntax	:CALCulate:MARKer:PEAK:CTRack:STATe {ON OFF 1 0}	
Query Syntax	:CALCulate:MARKer:PEAK:CTRack:STATe?	
Parameter	0	Turn peak track off.
	1	Turn peak track on.
	OFF	Turn peak track off.
	ON	Turn peak track on.
Return parameter	0	Peak track is off.
	1	Peak track is on.
Example	:CALC:MARK:PEAK:CTR:STAT ON	

:CALCulate:MARKer:PEAK:DATA? → Query

Description Returns all the top 10 peak data values in CSV format (returns the contents of the peak table).
The <csv data> data contains 10 pairs of data from the top 10 peaks. Each pair includes the peak frequency and the peak amplitude. There are a total of 10 pairs of data points (20 data entries in total) for the <csv data> data.

Query syntax :CALCulate:MARKer:PEAK:DATA?

Return parameter <csv data> pk#1 freq, pk#1 amp,..... pk#10 freq, pk#10 amp.

Example :CALCulate:MARKer:PEAK:DATA?
>1.250e+08,-5.052e+01,1.065000000e+09,...

Set →

:CALCulate:MARKer:PEAK:EXCursion → Query

Description Sets or queries the peak excursion value.

Syntax :CALCulate:MARKer:PEAK:EXCursion <rel ampl>

Query Syntax :CALCulate:MARKer:PEAK:EXCursion?

Parameter <rel ampl> Peak excursion dB (offset from threshold)

Return parameter <NR3> Peak excursion in dB.

Example :CALC:MARK:PEAK:EXC 6 db

Set →

:CALCulate:MARKer:PEAK:SORT:TYPE → Query

Description Sets or queries the peak sort type for the peak table.

Syntax :CALCulate:MARKer:PEAK:SORT:TYPE
{FREQuency|AMPLitude}

Query Syntax :CALCulate:MARKer:PEAK:SORT:TYPE?

Parameter/	FREQuency	Sort by frequency.
Return parameter	AMPLitude	Sort by amplitude.
Example	:CALC:MARK:PEAK:SORT:TYPE FREQ	

:CALCulate:MARKer:PEAK:TABLE:STATe (Set) →
→ (Query)

Description	Sets or queries the state of the Peak Table.	
Syntax	:CALCulate:MARKer:PEAK:TABLE:STATe {ON OFF 1 0}	
Query Syntax	:CALCulate:MARKer:PEAK:TABLE:STATe?	
Parameter	0	Turn peak table off.
	1	Turn peak table on.
	OFF	Turn peak table off.
	ON	Turn peak table on.
Return parameter	0	peak table is off.
	1	peak table is on.
Example	:CALC:MARK:PEAK:TABL:STAT ON	

:CALCulate:MARKer:PEAK:THReshold (Set) →
→ (Query)

Description	Sets or queries the peak threshold value.	
Syntax	:CALCulate:MARKer:PEAK:THReshold < ampl>	
Query Syntax	:CALCulate:MARKer:PEAK:THReshold?	
Parameter	< ampl>	Peak Threshold level
Return parameter	<NR3>	Peak threshold. Note: the unit returned depends on the currently set vertical units.
Example	:CALC:MARK:PEAK:THR -3 dBm	

:CALCulate:MARKer:PEAK:THReshold: STATE (Set) →
→ (Query)

Description	Sets or queries the state of the Peak Threshold.	
-------------	--	--

Syntax	:CALCulate:MARKer:PEAK:THReshold:STATe {ON OFF 1 0}	
Query Syntax	:CALCulate:MARKer:PEAK:THReshold:STATe?	
Parameter	0	Turn peak threshold off.
	1	Turn peak threshold on.
	OFF	Turn peak threshold off.
	ON	Turn peak threshold on.
Return parameter	0	Peak threshold is off.
	1	Peak threshold is on.
Example	:CALC:MARK:PEAK:THR:STAT ON	

:CALCulate:MARKer<n>:SET (Set) →

Description	Sets the selected marker to one of five preset positions.	
Query Syntax	:CALCulate:MARKer<n>:SET {CENTer START STOP STEP RLEVel}	
Parameter	<n>	<NR1> Marker number 1~6
	CENTer	Set to center frequency
	START	Set to start frequency
	STOP	Set to stop frequency
	STEP	Set to CF STEP frequency
	RLEVel	Set to the Reference level
Example	:CALC:MARK1:SET CENT	

:CALCulate:MARKer<n>:STATe (Set) →
← (Query)

Description	Sets or queries the state of the selected marker.	
Syntax	:CALCulate:MARKer<n>:STATe {ON OFF 1 0}	
Query Syntax	:CALCulate:MARKer<n>:STATe?	
Parameter	<n>	<NR1> Marker number 1~6
	0	Turn the selected marker off.
	1	Turn the selected marker on.
	OFF	Turn the selected marker off.

	ON	Turn the selected marker on.
Return parameter	0	The selected marker is off.
	1	The selected marker on.

Example :CALC:MARK1:STAT ON

:CALCulate:MARKer:TABLE:STATe



Description	Sets or queries the state of the marker table.	
Syntax	:CALCulate:MARKer:TABLE:STATe {ON OFF 1 0}	
Query Syntax	:CALCulate:MARKer:TABLE:STATe	
Parameter	0	Turn the table off.
	1	Turn the table on.
	OFF	Turn the table off.
	ON	Turn the table on.

Return parameter	0	The table is off.
	1	The table is on.

Example :CALC:MARK:TABL:STAT ON

:CALCulate:MARKer<n>:TRACe



Description	Assigns the selected marker to a trace. Queries which trace the selected marker is assigned to.	
Syntax	:CALCulate:MARKer<n>:TRACe <trace name>	
Query Syntax	:CALCulate:MARKer<n>:TRACe?	
Parameter/	<n>	<NR1> Marker number 1~6
Return parameter	<trace name>	The name of the trace: (1, 2, 3, 4)

Example :CALC:MARK2:TRAC 1

:CALCulate:MARKer<n>:TRACe:AUTO



Description Sets or queries the state of the Marker Trace function. Allows the selected marker to be automatically assigned to a trace (on) or be manually assigned a trace (off).

Syntax :CALCulate:MARKer<n>:TRACe:AUTO {ON|OFF|1|0}

Query Syntax :CALCulate:MARKer<n>:TRACe:AUTO?

Parameter	<n>	<NR1> Marker number 1~6
	0	Turn the auto function off.
	1	Turn the auto function on.
	OFF	Turn the auto function off.
	ON	Turn the auto function on.

Return parameter	0	The auto function is off.
	1	The auto function is on.

Example :CALC:MARK2:TRAC:AUTO OFF

:CALCulate:MARKer<n>:TYPE



Description Sets or queries the marker type.

Syntax :CALCulate:MARKer<n>:TYPE {NORMal|DELTA}

Query Syntax :CALCulate:MARKer<n>:TYPE?

Parameter/ Return parameter	<n>	<NR1> Marker number 1~6
	<NORMal>	Normal marker
	<DELTA>	Delta marker

Example :CALC:MARK1:TYPE NORM

:CALCulate:MARKer<n>:X



Description Sets or returns the marker position in Hz.

Syntax :CALCulate:MARKer<n>:X <freq>

Query Syntax :CALCulate:MARKer<n>:X?

Parameter/	<n>	<NR1> Marker number 1~6
Return parameter	<freq>	Hz
Example	:CALC:MARK4:X 2.0e+6	

:CALCulate:MARKer<n>:Y? → Query

Description	Returns the marker's vertical position in the current unit.	
Query Syntax	:CALCulate:MARKer<n>:Y?	
Parameter	<n>	<NR1> Marker number 1~6
Return parameter	<NR3>	Power or voltage
Example	:CALC:MARK1:Y? >-5.43e+1	

:CALCulate:MATH:PDIF Set →

Description	Calculates the power difference between two traces (T1 -the first trace operand- and T2 -the second trace operand-).	
Syntax	:CALCulate:MATH:PDIF <Destination Trace,T1,T2>	
Parameter	< Destination Trace>* < T1> < T2>	TRACe1, TRACe2, TRACe3 or TRACe4
Note	* The destination trace cannot be the same as the T1 or T2 trace.	
Example	:CALC:MATH:PDIF TRAC1,TRAC2,TRAC3	

:CALCulate:MATH:LDIF Set →

Description	Calculates the logarithmic difference between two traces (T1 - the first trace operand and T2 - the second trace operand) and assigns the designated reference level to the destination trace.	
-------------	--	--

Syntax	:CALCulate:MATH:LDIF <Destination Trace,T1,T2, Ref>	
Parameter	< Destination Trace>* < T1> < T2> <Ref>	TRACe1, TRACe2, TRACe3 or TRACe4 <NR1>Reference level
Note	* The destination trace cannot be the same the T1 or T2 traces.	
Example	:CALC:MATH:LDIF TRAC1,TRAC2,TRAC3,20	

:CALCulate:MATH:LOFF

Set →

Description	Adds an offset to T1 -the source trace- and puts the result into a destination trace.	
Syntax	:CALCulate:MATH:LOFF <Destination Trace,T1,offset>	
Parameter	< Destination Trace >* < T1> -source trace- <offset>	TRACe1, TRACe2, TRACe3 or TRACe4 <NRf>Offset in dB
Note	* The destination trace cannot be the same as the source trace.	
Example	:CALC:MATH:LOFF TRAC1,TRAC2,6	

:CALCulate:NDB:STATe

Set →
→ Query

Description	Sets or queries the state of the NdB BW function.	
Syntax	:CALCulate:NDB:STATe {ON OFF 1 0}	
Query Syntax	:CALCulate:NDB:STATe?	
Parameter	0 1 OFF ON	Turn NdB BW off. Turn NdB BW on. Turn NdB BW off. Turn NdB BW on.
Return parameter	0 1	NdB BW is off. NdB BW is on.

Example :CALC:NDB:STAT ON

:CALCulate:NDB:BANDwidth|BWIDth? → **Query**

Description Returns the NdB bandwidth measurement.

Query Syntax :CALCulate:NDB:BANDwidth|BWIDth?

Return parameter <NR3> NdB bandwidth in Hz.

Example :CALC:NDB:BAND?
>5.5e+04

Set →

:CALCulate:NORMalize:STATe → **Query**

Description Turns the tracking generator normalization on/off or queries its state.

Syntax :CALCulate:NORMalize:STATe{ON|OFF|1|0}

Query Syntax :CALCulate:NORMalize:STATe?

Parameter	0	Turn normalization off.
	1	Turn normalization on.
	OFF	Turn normalization off.
	ON	Turn normalization on.

Return parameter	0	normalization is off.
	1	normalization is on.

Example :CALC:NORM:STAT ON

Set →

:CALCulate:OCBW:STATe → **Query**

Description Turns the OCBW measurement on/off or queries its state.

Syntax :CALCulate:OCBW:STATe {ON|OFF|1|0}

Query Syntax :CALCulate:OCBW:STATe?

Parameter	0	Turn OCBW off.
	1	Turn OCBW on.
	OFF	Turn OCBW off.

	ON	Turn OCBW on.
Return parameter	0	OCBW is off.
	1	OCBW is on.
Example	:CALC:OCBW:STAT ON	

:CALCulate:OCBW:BANDwidth|BWIDth? → **Query**

Description	Returns the OCBW bandwidth measurement.	
Query Syntax	:CALCulate:OCBW:BANDwidth BWIDth?	
Return parameter	<NR3>	OCBW bandwidth in Hz.
Example	:CALC:OCBW:BAND? >4.1e+03	

:CALCulate:OCBW:CHPower? → **Query**

Description	Returns the OCBW channel power measurement.	
Query Syntax	:CALCulate:OCBW:CHPower?	
Return parameter	<NR3>	OCBW channel power in the current Y-axis unit.
Example	:CALC:OCBW:CHP? >9.13e+01	

:CALCulate:OCBW:POWER? → **Query**

Description	Returns the OCBW total power measurement.	
Query Syntax	:CALCulate:OCBW:POWER?	
Return parameter	<NR3>	OCBW total power in the current Y-axis unit.
Example	:CALC:OCBW:POW? >1.33e+01	

:CALCulate:PMETER:POWER? → **Query**

Description	Returns the power meter power measurement.
Query Syntax	:CALCulate:PMETer:POWer?
Return parameter	<NR3> Power in the current Y-axis unit.
Example	:CALC:PMET:POW? >0.83e+01

:CALCulate:PMETer:LIMit:STATe

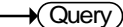

Description	Turns the pass/fail limits on/off in the Power Meter mode or queries its state.								
Syntax	:CALCulate:PMETer:LIMit:STATe {ON OFF 1 0}								
Query Syntax	:CALCulate:PMETer:LIMit:STATe?								
Parameter	<table border="0"> <tr> <td>0</td> <td>Turns limits off.</td> </tr> <tr> <td>1</td> <td>Turns limits on.</td> </tr> <tr> <td>OFF</td> <td>Turns limits off.</td> </tr> <tr> <td>ON</td> <td>Turns limits on.</td> </tr> </table>	0	Turns limits off.	1	Turns limits on.	OFF	Turns limits off.	ON	Turns limits on.
0	Turns limits off.								
1	Turns limits on.								
OFF	Turns limits off.								
ON	Turns limits on.								
Return parameter	<table border="0"> <tr> <td>0</td> <td>Turns limits off.</td> </tr> <tr> <td>1</td> <td>Turns limits on.</td> </tr> </table>	0	Turns limits off.	1	Turns limits on.				
0	Turns limits off.								
1	Turns limits on.								
Example	:CALC:PMET:LIM:STAT? >1								

:CALCulate:PMETer:LIMit:FAIL? 

Description	Returns the pass/fail judgment.				
Query Syntax	:CALCulate:PMETer:LIMit:FAIL?				
Return parameter	<table border="0"> <tr> <td>0</td> <td>Pass, or limits are not on.</td> </tr> <tr> <td>1</td> <td>Fail</td> </tr> </table>	0	Pass, or limits are not on.	1	Fail
0	Pass, or limits are not on.				
1	Fail				
Example	:CALC:PMET:LIM:FAIL? >1				

:CALCulate:SEM:STATe



Description	Turns the SEM measurement on/off or queries its state.	
Syntax	:CALCulate:SEM:STATe {ON OFF 1 0}	
Query Syntax	:CALCulate:SEM:STATe?	
Parameter	0	Turns SEM off.
	1	Turns SEM on.
	OFF	Turns SEM off.
	ON	Turns SEM on.
Return parameter	0	SEM is off.
	1	SEM is on.
Example	:CALC:SEM:STAT ON	

:CALCulate:SEM:OFFSet<n>:RESult? → 

Description	Returns the start, stop frequencies as well as the pass/fail limits and judgements for the chosen offset.	
Query syntax	:CALCulate:SEM:OFFSet<n>:RESult?	
Parameter	<n>	Offset number 1~5.
Return parameter	<start freq>	Start frequency of the selected channel
	<low dBm>	Lower dBm measurement
	<low p/f>	Lower pass/fail limit judgment. 0 = pass, 1 = fail.
	<stop freq>	Stop frequency of the selected channel
	<upp dBm>	Upper dBm measurement
	<upp p/f>	Upper pass/fail limit judgment 0 = pass, 1 = fail.
Example	:CALC:SEM:OFFS1:RES? >9e+7, -7.9e+1,0,1.7e+7,-6.9e+1,0	

:CALCulate:TOI:DIFFerential? → 

Description	Returns the third order intermodulation distortion.	
Query syntax	:CALCulate:TOI:DIFFerential?	

Return parameter	<base lower>	<NR3> dBc
	<base upper>	<NR3> dBc
	<3 rd order lower>	<NR3> dBc
	<3 rd order upper>	<NR3> dBc

Example :CALC:TOI:DIFF?
>0.0e+0,-1.67e-1,-1.09e+1,-6.61e+0

:CALCulate:TOI:FREQuency:DIFFerential? → **Query**

Description Returns the delta of the base lower frequency and base upper frequency.

Query syntax :CALCulate:TOI:FREQuency:STEPsize?

Return parameter	<NR3>	Δ f: Hz
------------------	-------	----------------

Example :CALC:TOI:FREQ:DIFF?
>6.65e+5

Set →

:CALCulate:TOI:LIMit:STATe → **Query**

Description Turns the TOI pass/fail limit on/off or queries its state.

Syntax :CALCulate:TOI:LIMit:STATe {ON|OFF|1|0}

Query Syntax :CALCulate:TOI:LIMit:STATe?

Parameter	0	Turns pass/fail limit off.
	1	Turns pass/fail limit on.
	OFF	Turns pass/fail limit off.
	ON	Turns pass/fail limit on.

Return parameter	0	Turns pass/fail limit off.
	1	Turns pass/fail limit on.

Example :CALC:TOI:LIM:STAT ON

:CALCulate:TOI:RESult? → **Query**

Description Returns the third order intercept and the pass/fail judgments.

Query syntax	:CALCulate:TOI:RESult?	
Return parameter	<3rd lower> <lower p/f> <3rd upper> <upper p/f>	3rd order lower intercept 3 rd order lower pass/fail judgment. 0=pass, 1=fail 3 rd order upper intercept 3 rd order lower pass/fail judgment 0=pass, 1=fail
Example	:CALC:TOI:RES? >-5.5e+1,0, -6.61e+1,0	

Set →
 → Query

:CALCulate:TOI:STATe

Description	Turns TOI measurement on/off or queries its state.	
Syntax	:CALCulate:TOI:STATe {ON OFF 1 0}	
Query Syntax	:CALCulate:TOI:STATe?	
Parameter	0 1 OFF ON	Turns TOI measurement off. Turns TOI measurement on. Turns TOI measurement off. Turns TOI measurement on.
Return parameter	0 1	TOI measurement is off. TOI measurement is on.
Example	:CALC:TOI:STAT ON	

CONFigure Commands

:CONFigure:MODE95

Set →
 → Query

:CONFigure:MODE

Description	Sets or queries the operating mode, spectrum or power meter.	
Query Syntax	:CONFigure:MODE {SA PMETer}	

Parameter/	<SA>	Spectrum mode
Return parameter	<PMETer>	Power meter mode
Example	:CONF:MODE SA	

DISPlay Commands

:DISPlay:BRIGhtness	97
:DISPlay:ENABle.....	97
:DISPlay:DEMod[:WINDow]:TRACe:X[:SCALe]	
:AUTO	97
:DISPlay:DEMod[:WINDow]:TRACe:X[:SCALe]	
:PDIVision.....	98
:DISPlay:DEMod[:WINDow]:TRACe:X[:SCALe]	
:RPOsition.....	98
:DISPlay:DEMod[:WINDow]:TRACe:X[:SCALe]	
:RVALue	99
:DISPlay:DEMod[:WINDow]:TRACe:Y[:SCALe]:AUTO95	
:DISPlay:DEMod[:WINDow]:TRACe:Y[:SCALe]	
:PDIVision.....	99
:DISPlay:DEMod[:WINDow]:TRACe:Y[:SCALe]	
:RPOsition.....	100
:DISPlay:DEMod[:WINDow]:TRACe:Y[:SCALe]	
:RVALue	100
:DISPlay[:WINDow]:NORMal	100
:DISPlay[:WINDow]:SPECTrogram	101
:DISPlay[:WINDow]:SPLit:NORMal:ALTernate	101
:DISPlay[:WINDow]:SPLit:NORMal:ACTive	101
:DISPlay[:WINDow]:SPLit:SPECTrogram	101
:DISPlay[:WINDow]:SPLit:TOPO	102
:DISPlay[:WINDow]:TOPO.....	102
:DISPlay[:WINDow]:TRACe<n>:MODE	102
:DISPlay[:WINDow]:TRACe:Y:DLINe	102
:DISPlay[:WINDow]:TRACe:Y:DLINe:STATe	103
:DISPlay[:WINDow]:TRACe:Y[:SCALe]:NRLevel.....	103
:DISPlay[:WINDow]:TRACe:Y[:SCALe]:NRPosition..	104
:DISPlay[:WINDow]:TRACe:Y[:SCALe]:PDIVision ..	104
:DISPlay[:WINDow]:TRACe:Y[:SCALe]:POsition	104
:DISPlay[:WINDow]:TRACe:Y[:SCALe]:RLEVel	105
:DISPlay[:WINDow]:TRACe:Y[:SCALe]:RLEVel	
:OFFSet.....	105
:DISPlay[:WINDow]:TRACe:Y[:SCALe]:SPACing.....	105
:DISPlay[:WINDow]:TRACe:Y[:SCALe]:STATe	106

:DISPlay:BRIGhtness





Description	Sets or queries the LCD brightness level.	
Syntax	:DISPlay:BRIGhtness {HIGH MIDDLE LOW}	
Query Syntax	:DISPlay:BRIGhtness?	
Parameter/ Return parameter	<HIGH> <MIDDLE> <LOW>	High brightness level Mid brightness level Low brightness level
Example	:DISP:BRIG HIGH	

:DISPlay:ENABle

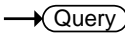

Description	Turns the LCD backlight on/off.	
Syntax	:DISPlay:ENABle {OFF ON 0 1}	
Query Syntax	:DISPlay:ENABle?	
Parameter	0 1 OFF ON	Turn LCD backlight off. Turn LCD backlight on. Turn LCD backlight off. Turn LCD backlight on.
Return parameter	0 1	LCD backlight is off. LCD backlight is on.
Example	:DISP:ENAB? >1	

**:DISPlay:DEMod[:WINDow]:TRACe:X
[:SCALE]:AUTO**



Description	Turns auto scale on/off for AM/FM demodulation or queries its state. When set to ON, the auto scale function will be executed continuously.	
Syntax	:DISPlay:DEMod[:WINDow]:TRACe:X[:SCALE]:AUTO {OFF ON 0 1}	

Query Syntax	:DISPlay:DEMod[:WINDow]:TRACe:X[:SCALe]:AUTO?	
Parameter	0	Turn Auto Scale off.
	1	Turn Auto Scale on.
	OFF	Turn Auto Scale off.
	ON	Turn Auto Scale on.
Return parameter	0	Auto Scale is off.
	1	Auto Scale is on.
Example	:DISP:DEM:TRAC:X:AUTO ON	

:DISPlay:DEMod[:WINDow]:TRACe:X (Set) →
[:SCALe]:PDIVision → (Query)

Description	Sets or queries the time axis scale/div.	
Syntax	:DISPlay:DEMod[:WINDow]:TRACe:X[:SCALe]:PDIVision <time>	
Query Syntax	:DISPlay:DEMod[:WINDow]:TRACe:X[:SCALe]:PDIVision?	
Parameter	<time>	<NRf>
Return parameter	<NR3>	Seconds
Example	:DISP:DEM:TRAC:X:PDIV 2 ms	

:DISPlay:DEMod[:WINDow]:TRACe:X (Set) →
[:SCALe]:RPOSition → (Query)

Description	Sets or queries the Reference Position of the trace for AM/FM demodulation (x-axis grid division).	
Syntax	:DISPlay:DEMod[:WINDow]:TRACe:X[:SCALe]:RPOSition <integer>	
Query Syntax	:DISPlay:DEMod[:WINDow]:TRACe:X[:SCALe]:RPOSition?	
Parameter/ Return parameter	<integer>	<NR1>1~10
Example	:DISP:DEM:TRAC:X:RPOS 2	

:DISPlay:DEMod[:WINDow]:TRACe:X (Set) →
[:SCALe]:RVALue → (Query)

Description	Sets or queries the Reference value time.	
Syntax	:DISPlay:DEMod[:WINDow]:TRACe:X[:SCALe]: RVALue <time>	
Query Syntax	:DISPlay:DEMod[:WINDow]:TRACe:X[:SCALe]: RVALue?	
Parameter	<time>	<NRf>
Return parameter	<NR3>	Seconds
Example	:DISP:DEM:TRAC:X:RVAL 2 ms	

:DISPlay:DEMod[:WINDow]:TRACe:Y[:
SCALe]:AUTO (Set) →

Description	Sets the vertical display scale to auto for AM/FM demodulation.	
Syntax	:DISPlay:DEMod[:WINDow]:TRACe:Y[:SCALe]: AUTO <integer>	
Example	:DISP:DEM:TRAC:Y:AUTO	

:DISPlay:DEMod[:WINDow]:TRACe:Y (Set) →
[:SCALe]:PDIVision → (Query)

Description	Sets or queries the Y-axis scale per division.	
Syntax	:DISPlay:DEMod[:WINDow]:TRACe:Y[:SCALe]: PDIVision <NRf>	
Query Syntax	:DISPlay:DEMod[:WINDow]:TRACe:Y[:SCALe]: PDIVision?	
Parameter	<NRf>	AM Unit: %, FM Unit: Hz
Return parameter	<NR3>	AM Unit: %, FM Unit: Hz
Example	:DISP:DEM:TRAC:Y:PDIV 2.3e+1	

`:DISPlay:DEMod[:WINDow]:TRACe:Y` (Set) →
`[:SCALe]:RPOSition` → (Query)

Description	Sets or queries the Reference Position of the trace for AM/FM demodulation (y-axis grid division).	
Syntax	:DISPlay:DEMod[:WINDow]:TRACe:Y[:SCALe]:RPOSition <integer>	
Query Syntax	:DISPlay:DEMod[:WINDow]:TRACe:Y[:SCALe]:RPOSition?	
Parameter/ Return parameter	<integer>	<NR1>1~10
Example	:DISP:DEM:TRAC:Y:RPOS 2	

`:DISPlay:DEMod[:WINDow]:TRACe:Y` (Set) →
`[:SCALe]:RVALue` → (Query)

Description	Sets or queries the Reference value (AM: %, FM: Hz).	
Syntax	:DISPlay:DEMod[:WINDow]:TRACe:Y[:SCALe]:RVALue <NRf>	
Query Syntax	:DISPlay:DEMod[:WINDow]:TRACe:Y[:SCALe]:RVALue?	
Parameter	<NRf>	AM Unit: %, FM Unit: Hz
Return parameter	<NR3>	AM Unit: %, FM Unit: Hz
Example	:DISP:DEM:TRAC:Y:RVAL 2 %	

`:DISPlay[:WINDow]:NORMal` (Set) →

Description	Sets the display window to the normal trace mode.	
Syntax	:DISPlay[:WINDow]:NORMal	
Example	:DISP:NORM	

:DISPlay[:WINDow]:SPECtrogram (Set) →

Description Sets the display window to spectrogram mode.

Syntax :DISPlay[:WINDow]:SPECtrogram

Example :DISP:SPEC

**:DISPlay[:WINDow]:SPLit:NORMal:
ALTErnate** (Set) →

Description Turns on the Alternate Sweep function for split window mode, both windows are in the normal trace mode.

(we also have Spectrogram and Topographic mode)

Syntax :DISPlay[:WINDow]:SPLit:NORMal:ALTErnate

Example :DISP:SPL:NORM:ALT

:DISPlay[:WINDow]:SPLit:NORMal:ACTive (Set) →

Description Sets which window (upper or lower) to display the normal trace mode in. It also becomes the active window. This command will also put the screen into split-screen mode if it is not already.

Syntax :DISPlay[:WINDow]:SPLit:NORMal:ACTive
{UPPer|LOWer}

Example :DISP:SPL:NORM:ACT UPP

:DISPlay[:WINDow]:SPLit:SPECtrogram (Set) →

Description Sets the split screen mode to Spectrogram + Spectrum.

Syntax :DISPlay[:WINDow]:SPLit:SPECtrogram

Example :DISP:SPL:SPEC

:DISPlay[:WINDow]:SPLit:TOPO (Set) →

Description Sets the split screen mode to Topographic + Spectrum.

Syntax :DISPlay[:WINDow]:SPLit:TOPO

Example :DISP:SPL:TOPO

:DISPlay[:WINDow]:TOPO (Set) →

Description Sets the display window to topographic.

Syntax :DISPlay[:WINDow]:TOPO

Example :DISP:TOPO

:DISPlay[:WINDow]:TRACe<n>:MODE (Set) →

Description Sets the operation mode of the selected trace.

Syntax :DISPlay[:WINDow]:TRACe<n>:MODE
{WRITe|VIEW|BLANK|MAXHold|MINHold}

Parameter	<n>	<NR1> Trace number 1~4
	WRITe	Clear and Write
	VIEW	Hold the last trace
	BLANK	Clears the trace
	MAXHold	Hold the maximum/minimum points
	MINHold	from each sweep

Example :DISP:TRAC4:MODE VIEW

:DISPlay[:WINDow]:TRACe:Y:DLINe (Set) →
→ (Query)

Description Sets or queries the display line amplitude level.

Syntax :DISPlay[:WINDow]:TRACe:Y:DLINe <ampl>

Query Syntax :DISPlay[:WINDow]:TRACe:Y:DLINe?

Parameter	<code><ampl></code>	<code><NRf></code> Power or voltage in the current Y-axis unit.
-----------	---------------------------	---

Return parameter	<code><NR3></code>	
------------------	--------------------------	--

Example	<code>:DISP:TRAC:Y:DLIN -5.0e+1</code>	
---------	--	--

Set →
 → Query

Description		Turns the display line on/off or queries its state.
-------------	--	---

Syntax	<code>:DISP:TRAC:Y:DLIN:STATe</code>	<code>{OFF ON 0 1}</code>
--------	--------------------------------------	---------------------------

Query Syntax	<code>:DISP:TRAC:Y:DLIN:STATe?</code>	
--------------	---------------------------------------	--

Parameter	0	Turn display line off.
	1	Turn display line on.
	OFF	Turn display line off.
	ON	Turn display line on.

Return parameter	0	The display line is off.
	1	The display line is on.

Example	<code>:DISP:TRAC:Y:DLIN:STAT ON</code>	
---------	--	--

Set →
 → Query

Description		Sets or queries the normalized reference level for the TG option.
-------------	--	---

Syntax	<code>:DISP:TRAC:Y:SCALE:NRLevel</code>	<code><ampl></code>
--------	---	---------------------------

Query Syntax	<code>:DISP:TRAC:Y:SCALE:NRLevel?</code>	
--------------	--	--

Parameter	<code><ampl></code>	<code><NRf></code> Power or voltage in the current Y-axis unit.
-----------	---------------------------	---

Return parameter	<code><NR3></code>	
------------------	--------------------------	--

Example	<code>:DISP:TRAC:Y:NRLevel 5 dBm</code>	
---------	---	--

:DISPlay[:WINDow]:TRACe:Y[:SCALe]:
NRPosition (Set) →
→ (Query)

Description	Sets or queries the position of the normalized reference level. The 0~10 Y-axis grid divisions correspond to the bottom~top grid divisions.	
Syntax	:DISPlay[:WINDow]:TRACe:Y[:SCALe]:NRPosition <integer>	
Query Syntax	:DISPlay[:WINDow]:TRACe:Y[:SCALe]:NRPosition?	
Parameter/ Return parameter	<integer>	<NR1> 0~10
Example	:DISP:TRAC:Y:NRP 5	

:DISPlay[:WINDow]:TRACe:Y[:SCALe]
:PDIVision (Set) →
→ (Query)

Description	Sets or queries the Y-axis scale/div when the amplitude scale is logarithmic.	
Syntax	:DISPlay[:WINDow]:TRACe:Y[:SCALe]:PDIVision{1 2 5 10}	
Query Syntax	:DISPlay[:WINDow]:TRACe:Y[:SCALe]:PDIVision?	
Parameter/ Return parameter	1	1 dB
	2	2 dB
	5	5 dB
	10	10 dB
Example	:DISP:TRAC:Y:PDIV 10	

:DISPlay[:WINDow]:TRACe:Y[:SCALe]:
POSition (Set) →
→ (Query)

Description	Sets or queries the position of the on-screen scale.	
Syntax	:DISPlay[:WINDow]:TRACe:Y[:SCALe]:POSition {LEFT CENTer RIGHT}	

Query Syntax :DISPlay[:WINDow]:TRACe:Y[:SCALe]:POSition?

Parameter/	LEFT	Position the scale to left
Return parameter	CENtEr	Position the scale to the center
	RIGHt	Position the scale to right

Example :DISP:TRAC:Y:POS LEFT

:DISPlay[:WINDow]:TRACe:Y[:SCALe]:
RLEVel (Set) →
→ (Query)

Description Sets or queries the Y-axis reference level. The units depend on the scale type (logarithmic/linear).

Syntax :DISPlay[:WINDow]:TRACe:Y[:SCALe]:RLEVel <ampl>

Query Syntax :DISPlay[:WINDow]:TRACe:Y[:SCALe]:RLEVel?

Parameter <ampl> <NRf>

Return parameter <NR3>

Example :DISP:TRAC:Y:RLEV 1 mV

:DISPlay[:WINDow]:TRACe:Y[:SCALe]:
RLEVel:OFFSet (Set) →
→ (Query)

Description Sets or queries the Y-axis reference level offset.

Syntax :DISPlay[:WINDow]:TRACe:Y[:SCALe]:RLEVel:OFFSet
<rel_ampl>

Query Syntax :DISPlay[:WINDow]:TRACe:Y[:SCALe]:RLEVel:OFFSet?

Parameter <ampl> <NRf> dB

Return parameter <NR3>

Example :DISP:TRAC:Y:RLEV OFFS -5.0e+1 dB

:DISPlay[:WINDow]:TRACe:Y[:SCALe]:
SPACing (Set) →
→ (Query)

Description Sets or queries the type of scale: logarithmic or linear.

Syntax	:DISPlay[:WINDow]:TRACe:Y[:SCALe]:SPACing {LINear LOGarithmic}	
Query Syntax	:DISPlay[:WINDow]:TRACe:Y[:SCALe]:SPACing?	
Parameter/	LINear	Linear scale
Return parameter	LOGarithmic	Logarithmic scale
Example	:DISP:TRAC:Y:SPAC LOG	

:DISPlay[:WINDow]:TRACe:Y[:SCALe]:
STATe

Description	Turns the on-screen scale on/off or queries its state.	
Syntax	:DISPlay[:WINDow]:TRACe:Y[:SCALe]:STATe {OFF ON 0 1}	
Query Syntax	:DISPlay[:WINDow]:TRACe:Y[:SCALe]:STATe?	
Parameter	0	Turn scale off.
	1	Turn scale on.
	OFF	Turn scale off.
	ON	Turn scale on.
Return parameter	0	Scale is off.
	1	Scale is on.
Example	:DISP:TRAC:Y:STAT ON	

INITiate Commands

:INITiate:CONTinuous	107
:INITiate[:IMMEDIATE].....	107

:INITiate:CONTinuous

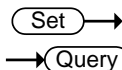

Description	Sets the sweep mode to continuous or single mode or queries its state.	
Syntax	:INITiate:CONTinuous {OFF ON 0 1}	
Query Syntax	:INITiate:CONTinuous?	
Parameter	0	single
	1	continuos
	OFF	single
	ON	continuos
Return parameter	0	single
	1	continuos
Example	:INIT:CONT ON	

:INITiate[:IMMEDIATE]



Description	Initiates an immediate single sweep then stops the sweep.	
Syntax	:INITiate[:IMMEDIATE]	
Example	:INIT	

INPut Commands

:INPut:ATTenuation	108
:INPut:ATTenuation:AUTO	108
:INPut:IMPedance	109
:INPut:OFFSet	109

:INPut:ATTenuation

Set →

→ Query

Description	Sets or queries the input attenuation.	
Syntax	:INPut:ATTenuation <integer>	
Query Syntax	:INPut:ATTenuation?	
Parameter/ Return parameter	<integer>	<NR1> 0 to 50
Example	:INP:ATT 10 dB	

Set →

→ Query

:INPut:ATTenuation:AUTO

Description	Sets or queries whether the automatic input attenuation is on/off.	
Syntax	:INPut:ATTenuation:AUTO {OFF ON 0 1}	
Query Syntax	:INPut:ATTenuation:AUTO?	
Parameter	0	Turn automatic input attenuation off.
	1	Turn automatic input attenuation on.
	OFF	Turn automatic input attenuation off.
	ON	Turn automatic input attenuation on.
Return parameter	0	Automatic input attenuation is off.
	1	Automatic input attenuation is on.
Example	:INP:ATT:AUTO ON	

:INPut:IMPedance (Set) →
→ (Query)

Description	Sets or queries the input impedance in Ω .	
Syntax	:INPut:IMPedance {50 75}	
Query Syntax	:INPut:IMPedance?	
Parameter/ Return parameter	50	<NR1> Ω
	75	<NR1> Ω
Example	:INP:IMP 75	

:INPut:OFFSet (Set) →
→ (Query)

Description	Sets or queries the input offset (Input Z Calibration).	
Syntax	:INPut:OFFSet <rel_ampl>	
Query Syntax	:INPut:OFFSet?	
Parameter/ Return parameter	<rel_ampl>	<NR3> dB
Example	:INP:OFFS 10 dB	

MMEMory Commands

:MMEMory:CATalog?	110
:MMEMory:CDIRectory	111
:MMEMory:COpy	111
:MMEMory:DELeTe	112
:MMEMory:DESTination	112
:MMEMory:LOAD:CORRection	113
:MMEMory:LOAD:LIMit	113
:MMEMory:LOAD:PMETer	113
:MMEMory:LOAD:SEQuence	113
:MMEMory:LOAD:STATe	114
:MMEMory:LOAD:TRACe	114
:MMEMory:MOVE	114
:MMEMory:REName	115
:MMEMory:STORe:CORRection	115
:MMEMory:STORe:LIMit	115
:MMEMory:STORe:PMETer	115
:MMEMory:STORe:SCReen	116
:MMEMory:STORe:SEQuence	116
:MMEMory:STORe:STATe	116
:MMEMory:STORe:TRACe	117

:MMEMory:CATalog?

→ Query

Description	Returns a list of all the files that have been saved to the local memory.
Query Syntax	:MMEMory:CATalog?
Example	:MMEM:CAT? >LocalState1.sta, QuickJpg.jpg,QuickJpg1.jpg,.....

:MMEMory:CDIRectory

Set →

Description Sets the source directory for memory related commands.

When you use a single USB drive/SD card with multiple partitions inside, the system will automatically name these partitions in the numeric order, so you need to specify the partition number.

The same situation applies when you use a USB hub to extend the number of USB ports. When a hub is used, *all* the partitions from *all* the attached devices are numbered in numerical order from the first port to the last port.

If a partition number is not supplied, the system will default to partition #1. For example:
 :MMEM:CDI USB0 = :MMEM:CDI USB)

Syntax :MMEMory:CDIRectory {LOCAL|USB[<n>]|SD[<n>]}

Parameter LOCAL
 USB<n> <NR1>
 SD<n> <NR1>

Example1 :MMEM:CDIR USB

Example2 :MMEM:CDIR USB3

:MMEMory:COPY

Set →

Description Copies a designated file from the current file directory to the destination directory. The file can be renamed after it is copied.

Syntax :MMEMory:COPY <src_file_name>,<dest_file_name>

Parameter <src_file_name>
 <dest_file_name>

Example :MMEM:COPY quick1.jpg,quick2.jpg

:MMEMory:DELeTe

Set →

Description	Deletes the designated file from the current directory.
Syntax	:MMEMory:DELeTe <src_file_name>
Parameter	<src_file_name>
Example	:MMEM:DEL quick1.jpg

:MMEMory:DESTination

Set →

Description	<p>Sets the destination directory for memory related commands.</p> <p>When you use a single USB drive/SD card with multiple partitions inside, the system will automatically name these partitions in the numeric order, so you need to specify the partition number.</p> <p>The same situation applies when you use a USB hub to extend the number of USB ports. When a hub is used, <i>all</i> the partitions from <i>all</i> the attached devices are numbered in numerical order from the first port to the last port.</p> <p>If a partition number is not supplied, the system will default to partition #1. For example: :MMEM:DEST USB0 = :MMEM:DEST USB)</p>						
Syntax	:MMEMory:DESTination {LOCAL USB[<n>] SD[<n>]}						
Parameter	<table border="1"> <tr> <td>LOCAL</td> <td></td> </tr> <tr> <td>USB<n></td> <td><NR1></td> </tr> <tr> <td>SD<n></td> <td><NR1></td> </tr> </table>	LOCAL		USB<n>	<NR1>	SD<n>	<NR1>
LOCAL							
USB<n>	<NR1>						
SD<n>	<NR1>						
Example	:MMEM:DEST SD						

:MMEMory:LOAD:CORRection**Set** →

Description Loads correction data from a file to the internal memory.

Syntax :MMEMory:LOAD:CORRection <corr num>, <src_file_name>

Parameter <corr num> <NR1> correction set 1~5
<src_file_name> XXX.cor

Example :MMEM:LOAD:CORR 2,test.cor

:MMEMory:LOAD:LIMit**Set** →

Description Loads limit line data from a file to the internal memory.

Syntax :MMEMory:LOAD:LIMit <lim num>,<src_file_name>

Parameter <lim num> <NR1> limit line 1~5
<src_file_name> XXX.lim

Example :MMEM:LOAD:LIM 2,test.lim

:MMEMory:LOAD:PMETer**Set** →

Description Loads power meter data from a file to the internal memory.

Syntax :MMEMory:LOAD:PMETer <src_file_name>

Parameter <src_file_name> XXX.pmet

Example :MMEM:LOAD:PMET test.pmet

:MMEMory:LOAD:SEQuence**Set** →

Description Loads sequence data from a file to the internal memory.

Syntax	:MMEMory:LOAD:SEqueNce <seq num>, <src_file_name>	
Parameter	<seq num> <src_file_name>	<NR1>sequence number 1~5 XXX.seq
Example	:MMEM:LOAD:SEQ 2,test.seq	

:MMEMory:LOAD:STATe (Set) →

Description	Loads the instrument state from a file to the internal memory.	
Syntax	:MMEMory:LOAD:STATe <src_file_name>	
Parameter	<src_file_name>	XXX.stat
Example	:MMEM:LOAD:STAT test.stat	

:MMEMory:LOAD:TRACe (Set) →

Description	Loads trace data from a file to the internal memory.	
Syntax	:MMEMory:LOAD:TRACe <trace name>, <src_file_name>	
Parameter	<trace name> <src_file_name>	<NR1> 1~4 XXX.tra
Example	:MMEM:LOAD:TRAC 2,test.tra	

:MMEMory:MOVE (Set) →

Description	Moves a designated file from the current file directory to the destination directory. The file can be renamed after it is moved.	
Syntax	:MMEMory:MOVE <src_file_name>,<dest_file_name>	
Parameter	<src_file_name> <dest_file_name>	
Example	:MMEM:MOVE quick1.jpg,quick2.jpg	

:MMEMory:REName**Set** →

Description	Renames the designated file from the current file.
-------------	--

Syntax	:MMEMory:REName <old_file_name>,<new_file_name>
--------	--

Parameter	<old_file_name> <new_file_name>
-----------	------------------------------------

Example	:MMEM:REN quick1.jpg, quick2.jpg
---------	----------------------------------

:MMEMory:STORe:CORRection**Set** →

Description	Store correction data to a file from the internal memory.
-------------	---

Syntax	:MMEMory:STOR:CORRection <corr num>,<new_dest_file_name>
--------	---

Parameter	<corr num> <NR1> correction set 1~5 <new_dest_file_name> XXX.cor
-----------	---

Example	:MMEM:STOR:CORR 2,test.cor
---------	----------------------------

:MMEMory:STORe:LIMit**Set** →

Description	Store limit line data to a file from the internal memory.
-------------	---

Syntax	:MMEMory:STOR:LIMit <lim num>,<new_dest_file_name>
--------	---

Parameter	<lim num> <NR1> limit line 1~5 <new_dest_file_name> XXX.lim
-----------	--

Example	:MMEM:STOR:LIM 2,test.lim
---------	---------------------------

:MMEMory:STORe:PMETer**Set** →

Description	Store power meter data to a file from the internal memory.
-------------	--

Syntax	:MMEMory:STORe:PMETer <new_dest_file_name>
Parameter	<new_dest_file_name> XXX.pmet
Example	:MMEM:STOR:PMET test.pmet

:MMEMory:STORe:SCReen (Set) →

Description	Store a screen-shot to the current file directory.
Syntax	:MMEMory:STORe:SCReen <new_dest_file_name>
Parameter	<new_dest_file_name> XXX.jpg
Example	:MMEMory:STOR:SCR test.jpg

:MMEMory:STORe:SEQuence (Set) →

Description	Store sequence data to a file from the internal memory.
Syntax	:MMEMory:STORe:SEQuence <seq num>, <new_dest_file_name>
Parameter	<seq num> <NR1>sequence number 1~5 <new_dest_file_name> XXX.seq
Example	:MMEM:STOR:SEQ 2,test.seq

:MMEMory:STORe:STATe (Set) →

Description	Store the instrument state to a file from the internal memory.
Syntax	:MMEMory:STORe:STATe <new_dest_file_name>
Parameter	<new_dest_file_name> XXX.stat
Example	:MMEM:STORe:STAT test.stat

:MMEMory:STORe:TRACe

Set →

Description	Store trace data to a file from the internal memory.	
Syntax	:MMEMory:STORe:TRACe <trace name>, <new_dest_file_name>	
Parameter	<trace name> <new_dest_file_name>	<NR1> 1~4 XXX.tra
Example	:MMEM:STORe:TRAC 2,test.tra	

OUTPut Commands

:OUTPut[:STATe] 117

:OUTPut[:STATe]

Set →

→ Query



Description	Turns the tracking generator output on/off or queries its state.	
Syntax	:OUTPut[:STATe] {OFF ON 0 1}	
Query Syntax	:OUTPut[:STATe]?	
Parameter	0 1 OFF ON	Turn TG output off. Turn TG output on. Turn TG output off. Turn TG output on.
Return parameter	0 1	TG output is off. TG output is on.
Example	:OUTP ON	

SENSe Commands

[SENSe]:ACPR:ACHannel<n>	
:BANDwidth BWIDth.....	121
[SENSe]:ACPR:ACHannel<n>:HLIMit	121
[SENSe]:ACPR:ACHannel<n>:LLIMit	121
[SENSe]:ACPR:ACHannel<n>:OFFSet	122
[SENSe]:ACPR:BANDwidth BWIDth	122
[SENSe]:ACPR:HLIMit	122
[SENSe]:ACPR:LLIMit.....	123
[SENSe]:ACPR:HELP:STATe	123
[SENSe]:ACPR:SPACe	123
[SENSe]:ASET:AMPLitude	124
[SENSe]:ASET:AMPLitude:AUTO	124
[SENSe]:ASET:RUN.....	124
[SENSe]:ASET:SPAN.....	125
[SENSe]:ASET:SPAN:AUTO	125
[SENSe]:AVERAge:COUNT.....	125
[SENSe]:AVERAge:STATe.....	126
[SENSe]:AVERAge:TYPE	126
[SENSe]:BANDwidth BWIDth[:RESolution].....	126
[SENSe]:BANDwidth BWIDth[:RESolution]:AUTO	127
[SENSe]:BANDwidth BWIDth:VIDeo	127
[SENSe]:BANDwidth BWIDth:VIDeo:AUTO.....	128
[SENSe]:CHANnel:SPACe:DOWN	128
[SENSe]:CHANnel:SPACe:UP	128
[SENSe]:CNR:CHANnel:SPACe.....	128
[SENSe]:CNR:DELTaMarker:MODE	129
[SENSe]:CORRection:CSET<n>:DATA	129
[SENSe]:CORRection:CSET<n>:STATe.....	130
[SENSe]:CORRection:CSET<n>:DELeTe	130
[SENSe]:CSO:CHANnel:SPACe	130
[SENSe]:CTB:CHANnel:SPACe.....	131
[SENSe]:DEMod:EARPhone:TYPE	131
[SENSe]:DEMod:EARPhone:VOLume.....	131
[SENSe]:DEMod:EARPhone:GAIN	132
[SENSe]:DEMod:FILTer:LPASS	132
[SENSe]:DEMod:IFBW	133
[SENSe]:DETEctor[:FUNCTion]	133
[SENSe]:DETEctor[:FUNCTion]:AUTO	133
[SENSe]:EMIFilter:STATe.....	134
[SENSe]:EMIFilter:BANDwidth BWIDth	

[:RESolution]	134
[:SENSe]:FREQuency:CENTer	135
[:SENSe]:FREQuency:CENTer:STEP	135
[:SENSe]:FREQuency:CENTer:STEP:AUTO	135
[:SENSe]:FREQuency:OFFSet	136
[:SENSe]:FREQuency:SPAN	136
[:SENSe]:FREQuency:SPAN:FULL	136
[:SENSe]:FREQuency:SPAN:PREVious	136
[:SENSe]:FREQuency:STARt	137
[:SENSe]:FREQuency:STOP	137
[:SENSe]:LIMit<n>:DELete	137
[:SENSe]:JITTer:OFFSet:STARt	137
[:SENSe]:JITTer:OFFSet:STOP	138
[:SENSe]:NDB:BANDwidth BWIDth	138
[:SENSe]:OCBW:BANDwidth BWIDth	138
[:SENSe]:OCBW:PERCent	139
[:SENSe]:OCBW:SPACe	139
[:SENSe]:PMETer:FREQuency	139
[:SENSe]:PMETer:HLIMit	140
[:SENSe]:PMETer:HOLD:STATe	140
[:SENSe]:PMETer:LLIMit	140
[:SENSe]:PMETer:PSENsor:MODE	141
[:SENSe]:PMETer:RECORDing:TIME	141
[:SENSe]:PMETer:RECORDing:TIME:STEP	141
[:SENSe]:POWER[:RF]:GAIN	142
[:SENSe]:SEMAsk:BANDwidth BWIDth:INTegration	142
[:SENSe]:SEMAsk:BANDwidth BWIDth	
[:RESolution]	143
[:SENSe]:SEMAsk:BANDwidth BWIDth	
[:RESolution]:AUTO	143
[:SENSe]:SEMAsk:CARRier:AUTO	143
[:SENSe]:SEMAsk:CARRier:CPSD	144
[:SENSe]:SEMAsk:CARRier:POWER	144
[:SENSe]:SEMAsk:FREQuency:SPAN	145
[:SENSe]:SEMAsk:GWLan:MODulation	145
[:SENSe]:SEMAsk:HELP:STATe	145
[:SENSe]:SEMAsk:NWLan:CHANnel: BANDwidth BWIDth	146
[:SENSe]:SEMAsk:OFFSet<n>:ADDition: BANDwidth BWIDth[:RESolution]?	146
[:SENSe]:SEMAsk:OFFSet<n>:ADDition: FREQuency:STARt?	148
[:SENSe]:SEMAsk:OFFSet<n>:ADDition: FREQuency:STOP?	148

[SENSe]:SEMask:OFFSet<n>:ADDition: STARt:ABSolute?	149
[SENSe]:SEMask:OFFSet<n>:ADDition: STOP:ABSolute?	149
[SENSe]:SEMask:OFFSet<n>:BANDwidth BWIDth[:RESolution].....	149
[SENSe]:SEMask:OFFSet<n>:BANDwidth BWIDth [:RESolution]:AUTO	150
[SENSe]:SEMask:OFFSet<n>:FREQuency:STARt....	150
[SENSe]:SEMask:OFFSet<n>:FREQuency:STOP	151
[SENSe]:SEMask:OFFSet<n>:STARt:ABSolute	151
[SENSe]:SEMask:OFFSet<n>:STARt:RELative	151
[SENSe]:SEMask:OFFSet<n>:STATe	152
[SENSe]:SEMask:OFFSet<n>:STOP:ABSolute	152
[SENSe]:SEMask:OFFSet<n>:STOP:ABSolute :COUple.....	152
[SENSe]:SEMask:OFFSet<n>:STOP:RELative.....	153
[SENSe]:SEMask:OFFSet<n>:STOP:RELative :COUple.....	153
[SENSe]:SEMask:OFFSet<n>:TEST	154
[SENSe]:SEMask:SElect.....	154
[SENSe]:SEMask:TYPE	155
[SENSe]:SEMask:W3GPP:DUPLex:TYPE	155
[SENSe]:SEMask:W3GPP:FDD:ADDition:LIMit.....	156
[SENSe]:SEMask:W3GPP:FDD:ADDition :MOPower	156
[SENSe]:SEMask:W3GPP:FDD:MOPower.....	156
[SENSe]:SEMask:W3GPP:FDD:TRANsmit:MODE..	157
[SENSe]:SEMask:W3GPP:TDD:CHIP:RATE	157
[SENSe]:SEMask:W3GPP:TDD:MOPower.....	158
[SENSe]:SEMask:W3GPP:TDD:TRANsmit:MODE .	158
[SENSe]:SEMask:WIMax:CHANnel :BANDwidth BWIDth.....	159
[SENSe]:SEQuence<n>:DELete	159
[SENSe]:SWEep:EGATe:DELay	159
[SENSe]:SWEep:EGATe:LENGth.....	159
[SENSe]:SWEep:EGATe:STATe	160
[SENSe]:SWEep:TIME.....	160
[SENSe]:SWEep:TIME:AUTO.....	160
[SENSe]:TOI:REFerence	161
[SENSe]:TOI:LIMit.....	161

`[[:SENSE]:ACPR:ACHannel<n>:BANDwidth|BWIDTH]`  

Description Sets or queries the adjacent channel bandwidth for the selected adjacent channel. Used with ACPR measurement.

Syntax `[[:SENSE]:ACPR:ACHannel<n>:BANDwidth|BWIDTH <freq>`

Query Syntax `[[:SENSE]:ACPR:ACHannel<n>:BANDwidth|BWIDTH?`

Parameter `<freq>` `<NRf>`

Return parameter `<NR3>` Hz

Example `:ACPR:ACH1:BAND 2.0e+6`

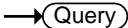
`[[:SENSE]:ACPR:ACHannel<n>:HLIMit]`  

Description Sets or queries the high limit for the selected adjacent channel. Used with ACPR measurement.

Syntax `[[:SENSE]:ACPR:ACHannel<n>:HLIMit <ampl>`

Query Syntax `[[:SENSE]:ACPR:ACHannel<n>:HLIMit?`

Parameter `<ampl>` `<NRf>` power or voltage

Return parameter `<NR3>`

Example `:ACPR:ACH1:HLIM -3.0e+1`

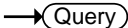
`[[:SENSE]:ACPR:ACHannel<n>:LLIMit]`  

Description Sets or queries the low limit for the selected adjacent channel. Used with ACPR measurement.

Syntax `[[:SENSE]:ACPR:ACHannel<n>:LLIMit <ampl>`

Query Syntax `[[:SENSE]:ACPR:ACHannel<n>:LLIMit?`

Parameter <ampl> <NRf3> power or voltage

Return parameter <NR3>

Example :ACPR:ACH1:LLIM -5.0e+1

Set →
 → Query

Description Sets or queries the adjacent channel offset for the selected adjacent channel. Used with ACPR measurement.

Syntax [:SENSE]:ACPR:ACHannel<n>:OFFSet <freq>

Query Syntax [:SENSE]:ACPR:ACHannel<n>:OFFSet?

Parameter <freq> <NRf>

Return parameter <NR3> Hz

Example :ACPR:ACH1:OFFSet 2.0e+6

Set →
 → Query

Description Sets or queries the main channel bandwidth for ACPR measurements.

Syntax [:SENSE]:ACPR:BANDwidth|BWIDth <freq>

Query Syntax [:SENSE]:ACPR:BANDwidth|BWIDth?

Parameter <freq> <NRf>

Return parameter <NR3> Hz

Example :ACPR: BAND 2.0e+6

Set →
 → Query

Description Sets or queries the high limit for the main channel. Used with ACPR measurement.

Syntax [:SENSE]:ACPR:HLIMit <ampl>

Query Syntax [:SENSE]:ACPR:HLIMit?

Parameter	<ampl>	<NRf> power or voltage
Return parameter	<NR3>	
Example	:ACPR:HLIM -3.0e+1	

Set →
 → Query

[[:SENSE]:ACPR:LLIMit

Description Sets or queries the low limit for the main channel. Used with ACPR measurement.

Syntax [[:SENSE]:ACPR:LLIMit <ampl>

Query Syntax [[:SENSE]:ACPR:LLIMit?

Parameter	<ampl>	<NRf> power or voltage
Return parameter	<NR3>	
Example	:ACPR:ACH1:LLIM -5.0e+1	

[[:SENSE]:ACPR:HELP:STATe Set →

Description Turns the on-screen help on/off.

Syntax [[:SENSE]:ACPR:HELP:STATe {OFF|ON|0|1}

Parameter	0	Turn help off.
	1	Turn help on.
	OFF	Turn help off.
	ON	Turn help on.

Example :ACPR:HELP:STAT ON

Set →
 → Query

[[:SENSE]:ACPR:SPACE

Description Sets or queries the channel spacing between the main channels.

Syntax [[:SENSE]:ACPR:SPACE <freq>

Query Syntax [[:SENSE]:ACPR:SPACE?

Parameter	<freq>	<NRf>
Return parameter	<NR3>	Hz
Example	:ACPR: SPAC 2.0e+6	

Set →
 → Query

Description	Sets or queries the autosest amplitude floor level.	
Syntax	[:SENSE]:ASET:AMPLitude <ampl>	
Query Syntax	[:SENSE]:ASET:AMPLitude?	
Parameter	<ampl>	<NRf> power or voltage
Return parameter	<NR3>	
Example	:ASET:AMPL 8.0e+1	

Set →
 → Query

Description	Sets autosest amplitude floor level to auto or manual or queries its state.	
Syntax	[:SENSE]:ASET:AMPLitude:AUTO {OFF ON 0 1}	
Query Syntax	[:SENSE]:ASET:AMPLitude:AUTO?	
Parameter	0	Turn autosest amplitude floor to manual.
	1	Turn autosest amplitude floor to auto.
	OFF	Turn autosest amplitude floor to manual.
	ON	Turn autosest amplitude floor to auto.
Return parameter	0	Autosest amplitude floor is in manual.
	1	Autosest amplitude floor is in auto.
Example	:ASET:AMPL:AUTO 1	

Set →

Description	Activates the Autosest function.
Syntax	[:SENSE]:ASET:RUN
Example	:ASET:RUN

Set →
 → Query

[[:SENSE]:ASET:SPAN

Description	Sets or queries the Autoset span.	
Syntax	[:SENSE]:ASET:SPAN <freq>	
Query Syntax	[:SENSE]:ASET:SPAN?	
Parameter	<freq>	<NRf>
Return parameter	<NR3>	Hz
Example	ASET:SPAN 2.0e+6	

Set →
 → Query

[[:SENSE]:ASET:SPAN:AUTO

Description	Turns the Autoset span to auto or manual or queries its state.	
Syntax	[:SENSE]:ASET:SPAN:AUTO {OFF ON 0 1}	
Query Syntax	[:SENSE]:ASET:SPAN:AUTO?	
Parameter	0	Turn Autoset span to manual (off).
	1	Turn Autoset span to automatic (on).
	OFF	Turn Autoset span to manual (off).
	ON	Turn Autoset span to automatic (on).
Return parameter	0	Autoset span is set to manual (off).
	1	Autoset span is set to automatic (on).
Example	:ASET:SPAN:AUTO	

Set →
 → Query

[[:SENSE]:AVERage:COUNT

Description	Sets or queries the number of traces that are used with the average function.	
Syntax	[:SENSE]:AVERage:COUNT <integer>	
Query Syntax	[:SENSE]:AVERage:COUNT?	

Parameter/	<integer>	<NR1>
Return parameter		

Example :AVER:COUN 20

Set →
 → Query

[:SENSe]:AVERage:STATe

Description Turns the Average function on/off or queries its state.

Syntax [:SENSe]:AVERage:STATe {OFF|ON|0|1}

Query Syntax [:SENSe]:AVERage:STATe?

Parameter	0	Turn the Average function off.
	1	Turn the Average function on.
	OFF	Turn the Average function off.
	ON	Turn the Average function on.

Return parameter	0	The Average function is off.
	1	The Average function is on.

Example :AVER:STAT ON

[:SENSe]:AVERage:TYPE Set →

Description Sets the method that the Average function uses to calculate the average.

Syntax [:SENSe]:AVERage:TYPE {VOLTage|LOGarithmic|POWER}

Query syntax [:SENSe]:AVERage:TYPE?

Parameter/Return parameter	VOLTage	Sets Average to voltage
	LOGarithmic	Sets Average to logarithmic
	POWER	Sets Average to power

Example :AVER:TYPE VOLT

Set →
 → Query

[:SENSe]:BANDwidth|BWIDth[:RESolution]

Description Sets or queries the resolution bandwidth (RBW).

Syntax	[:SENSe]:BANDwidth BWIDth[:RESolution] <freq>	
Query Syntax	[:SENSe]:BANDwidth BWIDth[:RESolution]?	
Parameter	<freq>	<NRf>
Return parameter	<NR3>	Hz
Example	:BAND 1.0e+6	

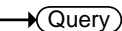
[:SENSe]:BANDwidth|BWIDth 
 [:RESolution]:AUTO 

Description Turns the RBW to auto (on) or manual (off) or queries its state.

Syntax [:SENSe]: BANDwidth|BWIDth[:RESolution]:AUTO {OFF|ON|0|1}

Query Syntax [:SENSe]: BANDwidth|BWIDth[:RESolution]:AUTO?

Parameter	0	Turn RBW to manual (off).
	1	Turn RBW to automatic (on).
	OFF	Turn RBW to manual (off).
	ON	Turn RBW to automatic (on).

Return parameter	0	RBW is set to manual (off).
	1	RBW is set to automatic (on).

Example :BAND:AUTO ON

[:SENSe]:BANDwidth|BWIDth:VIDeo 

Description Sets or queries the video bandwidth (VBW).

Syntax [:SENSe]:BANDwidth|BWIDth:VIDeo <freq>

Query Syntax [:SENSe]:BANDwidth|BWIDth:VIDeo?

Parameter <freq> <NRf>

Return parameter <NR3> Hz

Example BAND:VID 1.0e+6

[[:SENSE]:BANDwidth|BWIDth:VIDeo:AUTO (Set) →
→ (Query)

Description	Turns the VBW to auto (on) or manual (off) or queries its state.	
Syntax	[:SENSE]:BANDwidth BWIDth:VIDeo:AUTO {OFF ON 0 1}	
Query Syntax	[:SENSE]:BANDwidth BWIDth:VIDeo:AUTO?	
Parameter	0	Turn VBW to manual (off).
	1	Turn VBW to automatic (on).
	OFF	Turn VBW to manual (off).
	ON	Turn VBW to automatic (on).
Return parameter	0	VBW is set to manual (off).
	1	VBW is set to automatic (on).
Example	:BAND:VID:AUTO OFF	

[[:SENSE]:CHANnel:SPACe:DOWN (Set) →

Description	Moves to the previous main channel when using measurements that have a channel space setting.	
Syntax	[:SENSE]:CHANnel:SPACe:DOWN	
Example	:CHAN:SPAC:DOWN	

[[:SENSE]:CHANnel:SPACe:UP (Set) →

Description	Moves to the next main channel when using measurements that have a channel space setting.	
Syntax	[:SENSE]:CHANnel:SPACe:UP	
Example	:CHAN:SPAC:UP	

[[:SENSE]:CNR:CHANnel:SPACe (Set) →
→ (Query)

Description	Sets or queries the channel space bandwidth for CNR measurements.	
-------------	---	--

Syntax	[:SENSe]:CNR:CHANnel:SPACe <freq>	
Query Syntax	[:SENSe]:CNR:CHANnel:SPACe?	
Parameter	<freq>	<NRf>
Return parameter	<NR3>	Hz
Example	:CNR:CHAN:SPAC 6.0e+6	

[:SENSe]:CNR:DELTamarker:MODE Set →

Description	Turns the CNR Noise Marking function to Min(AUTO) or ΔMarker(MANual).	
Syntax	[:SENSe]:CNR:DELTamarker:MODE {AUTO MANual }	
Parameter	AUTO	Sets the Noise Marking to Min.
	ΔMarker	Sets the Noise Marking to ΔMarker.
Example	:CNR:DELT:MODE AUTO	

**[:SENSe]:CORRection:CSET<n>:DATA Set →
→ Query**

Description	As a command, sets an offset for a certain frequency for a selected correction set. As a query, returns the data contents for the selected correction set as <csv data>. The data will be arranged as: pt#1 freq, pt#1 offset, pt#2 freq, pt#2 offset,...	
Syntax	[:SENSe]:CORRection:CSET<n>:DATA <freq>,<offset>	
Query syntax	[:SENSe]:CORRection:CSET<n>:DATA?	
Parameter	<freq>	<NRf> Hz
	<offset>	<NRf> dB
	<n>	<NR1>correction set number
Return parameter	<CSV data>	pt#1 freq, pt#1 offset,..... pt#n freq, pt#n offset
Example	CORR:CSET1:DATA 2e+6,30	

[[:SENSe]:CORRection:CSET<n>:STATe (Set) →
→ (Query)

Description	Turns the selected correction set on/off or queries its state.	
Syntax	[:SENSe]:CORRection:CSET<n>:STATe {OFF ON 0 1}	
Query Syntax	[:SENSe]:CORRection:CSET<n>:STATe?	
Parameter	0	Turn turn the selected correction set off.
	1	Turn turn the selected correction set on.
	OFF	Turn turn the selected correction set off.
	ON	Turn turn the selected correction set on.
	<n>	<NR1>correction set number
Return parameter	0	The selected correction set is off.
	1	The selected correction set is on.
Example	:CORR:CSET1:STAT ON	

[[:SENSe]:CORRection:CSET<n>:DELeTe (Set) →

Description	Deletes the chosen correction set.	
Syntax	[:SENSe]:CORRection:CSET<n>:DELeTe	
Parameter	<n>	<NR1>correction set number
Example	:CORR:CSET1:DEL 2	

[[:SENSe]:CSO:CHANnel:SPACe (Set) →
→ (Query)

Description	Sets the channel space bandwidth for CSO measurements.	
Syntax	[:SENSe]:CSO:CHANnel:SPACe <freq>	
Query Syntax	[:SENSe]:CSO:CHANnel:SPACe?	
Parameter	<freq>	<NRf>
Return parameter	<NR3>	Hz
Example	:CSO:CHAN:SPAC 6.0e+6	

Set →
 → Query

[[:SENSe]:CTB:CHANnel:SPACe

Description	Sets the channel space bandwidth for CTB measurements.	
Syntax	[:SENSe]:CTB:CHANnel:SPACe <freq>	
Query Syntax	[:SENSe]:CTB:CHANnel:SPACe?	
Parameter	<freq>	<NRf>
Return parameter	<NR3>	Hz
Example	:CTB:CHAN:SPAC 6.0e+6	

Set →
 → Query

[[:SENSe]:DEMod:EARPhOne:TYPE

Description	Sets or queries the demodulation type for the Ear Phone Out demodulation function.	
Syntax	[:SENSe]:DEMod:EARPhOne:TYPE {AM FM}	
Query Syntax	[:SENSe]:DEMod:EARPhOne:TYPE?	
Parameter	AM	AM demodulation
	FM	FM demodulation
Example	:DEM:EARP:TYPE AM	

Set →
 → Query

[[:SENSe]:DEMod:EARPhOne:VOLume

Description	Sets or queries the volume setting for the demodulation function.	
Syntax	[:SENSe]:DEMod:EARPhOne:VOLume <integer>	
Query Syntax	[:SENSe]:DEMod:EARPhOne:VOLume?	
Parameter/ Return parameter	<integer>	<NR1> 0~15
Example	:DEM:EARP:VOL 7	

Set →
 → Query

[[:SENSE]:DEMod:EARPhone:GAIN

Description	Sets or queries the gain setting for the demodulation function.	
Syntax	[:SENSE]:DEMod:EARPhone:GAIN <rel_amp>	
Query Syntax	[:SENSE]:DEMod:EARPhone:GAIN?	
Parameter/ Return parameter	<rel_amp>	<NR1> 0~18, 6dB steps
Example	:DEM:EARP:GAIN 6	

Set →
 → Query

[[:SENSE]:DEMod:FILTer:LPASs

Description	Sets or queries the low pass filter settings for the AM/FM Analysis function.	
Syntax	[:SENSE]:DEMod:FILTer:LPASs {LEVEL<n> Bypass}	
Query Syntax	[:SENSE]:DEMod:FILTer:LPASs?	
Parameter/ Return parameter	Bypass <n>	Sets the low pass filter to bypass. <NR1>1~5

The filters 1 to 5 are shown in the table below. The GSP-930 will automatically detect the signal frequency.

AM/FM Signal Frequency (Hz)	Selectable bandwidth of LPF (Hz)				
	<n>=1	<n>=2	<n>=3	<n>=4	<n>=5
≥78,125	156,250	78,125	52,083	39,063	31,250
≥39,063	78,125	39,063	26,042	19,531	15,625
≥19,531	39,063	19,531	13,021	9,766	7,813
≥7,813	15,625	7,813	5,208	3,906	3,125
≥3,906	7,813	3,906	2,604	1,953	1,563
≥1,953	3,906	1,953	1,302	977	781
≥781	1,563	781	521	391	313
≥391	781	391	260	195	156
≥195	391	195	130	98	78
≥78	156	78	52	39	31
≥39	78	39	26	20	16
≥20	39	20	13	10	8
≥8	16	8	5	4	3

Example :DEM:FILT:LPAS B

[[:SENSe]:DEMod:IFBW

Set →

→ Query

Description Sets or queries the IF bandwidth for the AM/FM Analysis function.

Syntax [[:SENSe]:DEMod:IFBW <freq>

Query Syntax [[:SENSe]:DEMod:IFBW?

Parameter <freq> <NRf>

Return parameter <NR3> Hz

Example DEM:IFBW 3.0e+5

[[:SENSe]:DETEctor[:FUNction]

Set →

→ Query

Description Sets or queries the trace detection mode when in manual mode.

Syntax [[:SENSe]:DETEctor[:FUNction] {AVERage|SAMple|POSitive|NEGative|NORMal}

Query Syntax [[:SENSe]:DETEctor[:FUNction]?

Parameter/ Return parameter	AVERage	Sets the detector mode to Average.
	SAMple	Sets the detector mode to Sample.
	POSitive	Sets the detector mode to Peak+.
	NEGative	Sets the detector mode to Peak-.
	NORMal	Sets the detector mode to Normal.

Example :DET NORM

[[:SENSe]:DETEctor[:FUNction]:AUTO

Set →

→ Query

Description Turns the trace detection mode to auto (on) or manual (off) or queries its state.

Syntax [[:SENSe]:DETEctor[:FUNction]:AUTO {OFF|ON|0|1}

Query Syntax [[:SENSe]:DETEctor[:FUNction]:AUTO?

Parameter	0	Turn the detection mode to manual (off).
	1	Turn the detection mode to auto (on).
	OFF	Turn the detection mode to manual (off).
	ON	Turn the detection mode to auto (on).
Return parameter	0	The detection mode is set to manual.
	1	The detection mode is set to automatic.
Example	:DET:AUTO ON	

Set →
 → Query

[[:SENSE]:EMIFilter:STATe

Description	Turns the EMI filter on/off or queries its state.	
Syntax	[:SENSE]:EMIFilter:STATe {OFF ON 0 1}	
Query Syntax	[:SENSE]:EMIFilter:STATe?	
Parameter	0	Turn the EMI filter off.
	1	Turn the EMI filter on.
	OFF	Turn the EMI filter off.
	ON	Turn the EMI filter on.
Return parameter	0	The EMI filter is off.
	1	The EMI filter is on.
Example	:EMI:STAT 0	

[[:SENSE]:EMIFilter:BANDwidth|BWIDth
[[:RESolution] Set →

Description	Sets the EMI filter bandwidth (must be set to the exact bandwidth).	
Syntax	[:SENSE]:EMIFilter:BANDwidth BWIDth[:RESolution] <freq>	
Parameter	<freq>	<NRf> (Only 200Hz, 9kHz, 120kHz are valid settings)
Example	:EMIF:BAND 2.0e+2	

Set →
 → Query

[[:SENSe]:FREQuency:CENTer

Description	Sets or queries the center frequency.	
Syntax	[:SENSe]:FREQuency:CENTer <freq>	
Query Syntax	[:SENSe]:FREQuency:CENTer?	
Parameter	<freq>	<NRf>
Return parameter	<NR3>	Hz
Example	FREQ:CENT 1.0e+9	

Set →
 → Query

[[:SENSe]:FREQuency:CENTer:STEP

Description	Sets or queries the CF Step frequency.	
Syntax	[:SENSe]:FREQuency:CENTer:STEP <freq>	
Query Syntax	[:SENSe]:FREQuency:CENTer:STEP?	
Parameter	<freq>	<NRf>
Return parameter	<NR3>	Hz
Example	FREQ:CENT:STEP 1.0e+3	

Set →
 → Query

[[:SENSe]:FREQuency:CENTer:STEP:AUTO

Description	Turns the CF Step frequency setting to auto (on) or manual (off) or queries its state.	
Syntax	[:SENSe]:FREQuency:CENTer:STEP:AUTO {OFF ON 0 1}	
Query Syntax	[:SENSe]:FREQuency:CENTer:STEP:AUTO?	
Parameter	0	Turn CF Step to manual (off).
	1	Turn CF Step to auto (on).
	OFF	Turn CF Step to manual (off).
	ON	Turn CF Step to auto (on).
Return parameter	0	CF Step is set to manual.
	1	CF Step is set to automatic.

Example :FREQ:CENT:STEP:AUTO OFF

[[:SENSE]:FREQUENCY:OFFSET

Set →

→ Query

Description Sets or queries the frequency offset settings.

Syntax [[:SENSE]:FREQUENCY:OFFSET <freq>

Query Syntax [[:SENSE]:FREQUENCY:OFFSET?

Parameter <freq> <NRf>

Return parameter <NR3>

Example FREQ:OFFS: 1.0e+6

[[:SENSE]:FREQUENCY:SPAN

Set →

→ Query

Description Sets or queries the span settings.

Syntax [[:SENSE]:FREQUENCY:SPAN <freq>

Query Syntax [[:SENSE]:FREQUENCY:SPAN?

Parameter <freq> <NRf>

Return parameter <NR3> Hz

Example FREQ:SPAN: 2.0e+9

[[:SENSE]:FREQUENCY:SPAN:FULL

Set →

Description Set the span to Full Span.

Syntax [[:SENSE]:FREQUENCY:SPAN:FULL

Example :FREQ:SPAN:FULL

[[:SENSE]:FREQUENCY:SPAN:PREVIOUS

Set →

Description Set the span to the previous span setting.

Syntax [[:SENSE]:FREQUENCY:SPAN:PREVIOUS

Example :FREQ:SPAN:PREV

[[:SENSE]:FREQUENCY:START (Set) →
→ (Query)

Description	Sets or queries the start frequency.	
Syntax	[:SENSE]:FREQUENCY:START <freq>	
Query Syntax	[:SENSE]:FREQUENCY:START?	
Parameter	<freq>	<NRf>
Return parameter	<NR3>	Hz
Example	FREQ:STAR: 0	

[[:SENSE]:FREQUENCY:STOP (Set) →
→ (Query)

Description	Sets or queries the stop frequency.	
Syntax	[:SENSE]:FREQUENCY:STOP <freq>	
Query Syntax	[:SENSE]:FREQUENCY:STOP?	
Parameter	<freq>	<NRf>
Return parameter	<NR3>	Hz
Example	FREQ:STOP: 1.0e+6	

[[:SENSE]:LIMIT<n>:DELETE (Set) →

Description	Deletes the chosen limit line.	
Syntax	[:SENSE]:LIMIT<n>:DELETE	
Parameter	<n>	<NR1> limit line number
Example	:LIM3:DEL	

[[:SENSE]:JITTER:OFFSET:START (Set) →
→ (Query)

Description	Sets or queries the start offset for phase jitter measurements.	
Syntax	[:SENSE]:JITTER:OFFSET:START <freq>	

Query Syntax	[:SENSE]:JITTer:OFFSet:STARt?	
Parameter	<freq>	<NRf>
Return parameter	<NR3>	Hz
Example	JITT:OFFS:STAR 1.0e+7	

Set →
 → Query

[:SENSE]:JITTer:OFFSet:STOP

Description	Sets or queries the stop offset for phase jitter measurements.	
Syntax	[:SENSE]:JITTer:OFFSet:STOP <freq>	
Query Syntax	[:SENSE]:JITTer:OFFSet:STOP?	
Parameter	<freq>	<NRf>
Return parameter	<NR3>	Hz
Example	JITT:OFFS:STOP 1.5e+7	

Set →
 → Query

[:SENSE]:NDB:BANDwidth|BWIDth

Description	Sets or queries the NdB amplitude for NdB bandwidth measurements.	
Syntax	[:SENSE]:NDB:BANDwidth BWIDth <rel_amp>	
Query Syntax	[:SENSE]:NDB:BANDwidth BWIDth?	
Parameter	<rel_amp>	<NRf>
Return parameter	<NR3>	dB
Example	:NDB:BAND 3 dB	

Set →
 → Query

[:SENSE]:OCBW:BANDwidth|BWIDth

Description	Sets or queries the OCBW bandwidth for OCBW measurements.	
Syntax	[:SENSE]:OCBW:BANDwidth BWIDth <freq>	
Query Syntax	[:SENSE]:OCBW:BANDwidth BWIDth?	

Parameter	<freq>	<NRf>
Return parameter	<NR3>	Hz
Example	:OCBW:BAND 4.5+6	

Set →
 → Query

[[:SENSE]:OCBW:PERCent

Description Sets or queries the OCBW percentage (OCBW %) parameter.

Syntax [[:SENSE]:OCBW:PERCent <integer>

Query Syntax [[:SENSE]:OCBW:PERCent?

Parameter/ Return parameter	<integer>	<NR1>0~100
--------------------------------	-----------	------------

Example :OCBW:PERC 90

Set →
 → Query

[[:SENSE]:OCBW:SPACe

Description Sets or queries the OCBW channel space for OCBW measurements.

Syntax [[:SENSE]:OCBW:SPACe <freq>

Query Syntax [[:SENSE]:OCBW:SPACe?

Parameter	<freq>	<NRf>
Return parameter	<NR3>	

Example :OCBW:SPAC 6e+7

Set →
 → Query

[[:SENSE]:PMETER:FREQuency

Description Sets or queries the power meter measurement frequency.

Syntax [[:SENSE]:PMETER:FREQuency <freq>

Query Syntax [[:SENSE]:PMETER:FREQuency?

Parameter	<freq>	<NRf>
Return parameter	<NR3>	Hz
Example	:PMET:FREQ 2e+7	

Set →
 → Query

[[:SENSE]:PMETer:HLIMit

Description	Sets or queries the power meter high limit for pass/fail tests.	
Syntax	[:SENSE]:PMETer:HLIMit <ampl>	
Query Syntax	[:SENSE]:PMETer:HLIMit?	
Parameter	<ampl>	<NRf> power unit, default = dBm
Return parameter	<NR3>	Unit = current unit.
Example	:PMET:HLIM 10	

Set →
 → Query

[[:SENSE]:PMETer:HOLD:STATe

Description	Turns the power meter Max/Min Hold function on/off or queries its state.	
Syntax	[:SENSE]:PMETer:HOLD:STATe {OFF ON 0 1}	
Query Syntax	[:SENSE]:PMETer:HOLD:STATe?	
Parameter	0	Turn the Max/Min Hold function off.
	1	Turn the Max/Min Hold function on.
	OFF	Turn the Max/Min Hold function off.
	ON	Turn the Max/Min Hold function on.
Return parameter	0	The Max/Min Hold function is off.
	1	The Max/Min Hold function is on.
Example	:PEMT:HOLD:STAT 0	

Set →
 → Query

[[:SENSE]:PMETer:LLIMit

Description	Sets or queries the power meter low limit for pass/fail tests.	
-------------	--	--

Syntax	[:SENSe]:PMETer:LLIMit <ampl>	
Query Syntax	[:SENSe]:PMETer:LLIMit?	
Parameter	<ampl>	<NRf> power unit, default = dBm
Return parameter	<NR3>	Unit = current unit.
Example	:PMET:LLIM 0	

Set →
 → Query

[:SENSe]:PMETer:PSENSor:MODE

Description	Sets or queries the power meter sensor mode.	
Syntax	[:SENSe]:PMETer:PSENSor:MODE {LOWNoise FASTer}	
Query Syntax	[:SENSe]:PMETer:PSENSor:MODE?	
Parameter/ Return parameter	LOWNoise FASTer	Sets the power meter mode to low noise. Set the power meter mode to fast.
Example	:PMET:PSEN:MODE	

Set →
 → Query

[:SENSe]:PMETer:RECORDing:TIME

Description	Sets or queries the power meter recording time.	
Syntax	[:SENSe]:PMETer:RECORDing:TIME <hour>,<minute>,<second>	
Query Syntax	[:SENSe]:PMETer:RECORDing:TIME?	
Parameter/ Return parameter	<hour> <minute> <second>	<NR1>Recording time: hours. <NR1>Recording time: minutes. <NR1>Recording time: seconds.
Example	:PMET:REC:TIME 1,10,30	

Set →
 → Query

[:SENSe]:PMETer:RECORDing:TIME:STEP

Description	Sets or queries the power meter recording interval in seconds.	
Syntax	[:SENSe]:PMETer:RECORDing:TIME:STEP <time>	

Query Syntax	[:SENSE]:PMETer:RECORDing:TIME:STEP?	
Parameter	<time>	<NRf>
Return parameter	<NR3>	seconds
Example	:PMET:REC:TIME:STEP 10s	

[:SENSE]:POWer[:RF]:GAIN

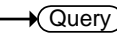

Description	Sets the preamplifier to Auto or Bypass mode or queries its state.	
Syntax	[:SENSE]:POWer[:RF]:GAIN {AUTO BYPASS}	
Query Syntax	[:SENSE]:POWer[:RF]:GAIN?	
Parameter/ Return parameter	AUTO BYPASS	Sets the preamplifier to auto mode. Sets the preamplifier to bypass mode.
Example	:POW:GAIN AUTO	

[:SENSE]:SEMAsk:BANDwidth|BWIDth:INTegration

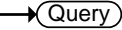

Description	Sets or queries the channel integration bandwidth for SEM measurements (user defined only).	
Syntax	[:SENSE]:SEMAsk:BANDwidth BWIDth:INTegration <freq>	
Query Syntax	[:SENSE]:SEMAsk:BANDwidth BWIDth:INTegration?	
Parameter	<freq>	<NRf>
Return parameter	<NR3>	Hz
Example	:SEM:BAND:INT 3.84e+6	

`[[:SENSe]:SEMAsk:BANDwidth|BWIDth
[:RESolution]`  

Description Sets or queries the RBW for SEM measurements.

Syntax `[[:SENSe]:SEMAsk:BANDwidth|BWIDth[:RESolution]
<freq>`

Query Syntax `[[:SENSe]:SEMAsk:BANDwidth|BWIDth[:RESolution]?]`

Parameter `<freq>` `<NRF>`

Return parameter `<NR3>` Hz

Example `:SEM:BAND 2.2e+4`

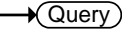
`[[:SENSe]:SEMAsk:BANDwidth|BWIDth
[:RESolution]:AUTO]`  

Description Turns the RBW setting to auto (on) or manual (off) for SEM measurements or queries its state.

Syntax `[[:SENSe]:SEMAsk:BANDwidth|BWIDth[:RESolution]:
AUTO {OFF|ON|0|1}]`

Query Syntax `[[:SENSe]:SEMAsk:BANDwidth|BWIDth[:RESolution]:
AUTO?]`

Parameter

0	Turn RBW to manual (off).
1	Turn RBW to auto (on).
OFF	Turn RBW to manual (off).
ON	Turn RBW to auto (on).

Return parameter

0	RBW is set to manual.
1	RBW is set to automatic.

Example `:SEM:BAND: AUTO OFF`

`[[:SENSe]:SEMAsk:CARRier:AUTO]`  

Description Turns the PSDRef or TotalPwrRef modes to auto (on) or manual (off) for SEM measurements or queries their state.

Syntax	[:SENSe]:SEMAsk:CARRier:AUTO {OFF ON 0 1}	
Query Syntax	[:SENSe]:SEMAsk:CARRier:AUTO?	
Parameter	0	Turn PSDRef/TotalPwrRef to manual (off).
	1	Turn PSDRef/TotalPwrRef to auto (on).
	OFF	Turn PSDRef/TotalPwrRef to manual (off).
	ON	Turn PSDRef/TotalPwrRef to auto (on).
Return parameter	0	PSDRef/TotalPwrRef is set to manual.
	1	PSDRef/TotalPwrRef is set to automatic.
Example	:SEM:CARR:AUTO OFF	

Set →
 → Query

[:SENSe]:SEMAsk:CARRier:CPSD

Description	Sets or queries the value of the PSDRef for SEM measurements.	
Syntax	[:SENSe]:SEMAsk:CARRier:CPSD <NR3>	
Query Syntax	[:SENSe]:SEMAsk:CARRier:CPSD?	
Parameter/ Return parameter	<NR3>	PSD ref unit = dBm/Hz
Example	:SEM:CARR:CPSD 20	

Set →
 → Query

[:SENSe]:SEMAsk:CARRier:POWer

Description	Sets or queries the value of the TotalPwrRef amplitude for SEM measurements.	
Syntax	[:SENSe]:SEMAsk:CARRier: POWer <ampl>	
Query Syntax	[:SENSe]:SEMAsk:CARRier: POWer?	
Parameter	<ampl>	<NRf>
Return parameter	<NR3>	dBm
Example	:SEM:CARR:POW 2 dbm	

Set →
 → Query

[[:SENSE]:SEMAsk:FREQUency:SPAN

Description	Sets or queries the channel span for SEM measurements (user-defined only).	
Syntax	[:SENSE]:SEMAsk:FREQUency:SPAN<freq>	
Query Syntax	[:SENSE]:SEMAsk:FREQUency:SPAN?	
Parameter	<freq>	<NR3>
Return parameter	<NR3>	Hz
Example	:SEM:FREQ:SPAN 2.2e+7	

Set →
 → Query

[[:SENSE]:SEMAsk:GWLan:MODulation

Description	Sets or queries the modulation type for the 802.11g SEM measurement.	
Syntax	[:SENSE]:SEMAsk:GWLan:MODulation {GRoup<n>}	
Query Syntax	[:SENSE]:SEMAsk:GWLan:MODulation?	
Parameter/ Return parameter	<n>=1 <n>=2	ERP-DSSS/ERP-PBCC/ERP-CCK ERP-OFDM/DSSS-OFDM
Example	:SEM:GWL:MOD GR1	

Set →
 → Query

[[:SENSE]:SEMAsk:HELP:STATe

Description	Turns the on-screen help window on/off or queries its state.	
Syntax	[:SENSE]:SEMAsk:HELP:STATe {OFF ON 0 1}	
Query Syntax	[:SENSE]:SEMAsk:HELP:STATe?	
Parameter	0 1 OFF ON	Turns the help window off. Turns the help window on. Turns the help window off. Turns the help window on.
Return parameter	0 1	Help window is off. Help window is on.

Example :SEM:HELP:STATE 1

[[:SENSE]:SEMask:NWLan:CHANnel:
BANDwidth|BWIDth Set →
← Query

Description Sets the channel bandwidth for the 802.11n SEM measurement. Only 20MHz or 40MHz can be used.

Syntax [[:SENSE]:SEMask:NWLan:CHANnel:
BANDwidth|BWIDth <freq>

Parameter <freq> <Nrf> (20 MHz or 40MHz)

Return parameter <NR3>

Example :SEM:NWL:CHAN:BAND 20 MHZ

[[:SENSE]:SEMask:OFFSet<n>:ADDition:
BANDwidth|BWIDth[:RESolution]? → Query

Description Returns the RBW of the selected offset for the additional requirements of the selected 3GPP SEM test.

Query syntax [[:SENSE]:SEMask:OFFSet<n>:ADDition:
BANDwidth|BWIDth[:RESolution]?

3GPP-FDD BS Additional Requirements For operation in bands II, IV, V, X, XII, XIII, XIV and XXV, additional requirements (listed below) apply in addition to the minimum requirements listed above.

For 3GPP-FDD UE
A means <1>
B means <2>
(UM P138)

Bands: II, IV, X	Unit: MHz	Additional ^[3]	RBW
	$2.5 \leq A < 3.5$	-15dBm	30kHz
	$3.5 \leq B < \Delta f_{max}$	-13dBm	1MHz
Bands: V	Unit: MHz	Additional ^[3]	RBW
	$2.5 \leq A < 3.5$	-15dBm	30kHz
	$3.5 \leq B < \Delta f_{max}$	-13dBm	100kHz
Bands: XII, XIII, XIV	Unit: MHz	Additional ^[3]	RBW
	$2.5 \leq A < 3.5$	-13dBm	30kHz
	$3.5 \leq B < \Delta f_{max}$	-13dBm	100kHz

3GPP-FDD UE Additional Requirements

Additional requirements for 3GPP-FDD UE. For 3GPP-FDD BS:
 A means <1>
 B means <2>
 (UM P137)

Bands II, IV, X	Unit: MHz	Additional ^[3]	RBW
	$2.5 \leq A < 3.5$	-15dBm	30kHz
	$3.5 \leq B < 12.5$	-15dBm	1MHz
Band V	Unit: MHz	Additional ^[3]	RBW
	$2.5 \leq A < 3.5$	-15dBm	30kHz
	$3.5 \leq B < 12.5$	-13dBm	100kHz
Bands XII, XIII, XIV	Unit: MHz	Additional ^[3]	RBW
	$2.5 \leq A < 3.5$	-13dBm	30kHz
	$3.5 \leq B < 12.5$	-13dBm	100kHz

Parameter/	<n>	Offset 1 to 5
Return parameter	<NR3>	RBW in Hz

Example :SEM:OFFS1:ADD:BAND?
> 3.000000000e+04

**[[:SENSE]:SEMASK:OFFSET<n>:ADDITION:
FREQUENCY:START?**

→ **Query**

Description	Returns the start frequency (referred to the center) of the selected offset for the additional requirements of the selected 3GPP SEM test.	
Query syntax	[:SENSE]:SEMASK:OFFSET<n>:ADDITION: FREQUENCY:START?	
Parameter/ Return parameter	<n> <NR3>	Offset 1 to 5 Start frequency in Hz
Example	:SEM:OFFS1:ADD:FREQ:STAR? >2.5e+6	

**[[:SENSE]:SEMASK:OFFSET<n>:ADDITION:
FREQUENCY:STOP?**

→ **Query**

Description	Returns the stop frequency (referred to the center) of the selected offset for the additional requirements of the selected 3GPP SEM test.	
Query syntax	[:SENSE]:SEMASK:OFFSET<n>:ADDITION: FREQUENCY:STOP?	
Parameter/ Return parameter	<n> <NR3>	Offset 1 to 5 Stop frequency in Hz
Example	:SEM:OFFS1:ADD:FREQ:STOP? >3.5e+6	

`[[:SENSE]:SEMASK:OFFSET<n>:ADDITION:START:ABSOLUTE?` → Query

Description Returns the “start” amplitude (dBm) of the Absolute Mask for the selected offset for the additional requirements of the selected 3GPP SEM test.

Query syntax `[[:SENSE]:SEMASK:OFFSET<n>:ADDITION:START:ABSOLUTE?`

Parameter/	<code><n></code>	Offset 1 to 5
Return parameter	<code><NR3></code>	Amplitude at start frequency

Example `:SEM:OFFS1:ADD:STAR:ABS?
>-1.5e+1`

`[[:SENSE]:SEMASK:OFFSET<n>:ADDITION:STOP:ABSOLUTE?` → Query

Description Returns the “Stop” amplitude (dBm) of the Absolute Mask for the selected offset for the additional requirements of the selected 3GPP SEM test.

Query syntax `[[:SENSE]:SEMASK:OFFSET<n>:ADDITION:STOP:ABSOLUTE?`



Parameter/	<code><n></code>	Offset 1 to 5
Return parameter	<code><NR3></code>	Amplitude at stop frequency

Example `:SEM:OFFS1:ADD:STOP:ABS?
>-1.5e+1`



`[[:SENSE]:SEMASK:OFFSET<n>:BANDWIDTH| BANDWIDTH[:RESOLUTION]` Set →
→ Query

Description Sets or queries the resolution bandwidth of the selected offset.

Syntax	[:SENSe]:SEMAsk:OFFSet<n>:BANDwidth BWIDth [:RESolution] <freq>	
Query Syntax	[:SENSe]:SEMAsk:OFFSet<n>:BANDwidth BWIDth [:RESolution]?	
Parameter/ Return parameter	<freq> <n>	<NR3> Hz <NR1>offset 1~5
Example	SEM:OFFS1:BAND 3.0e+3	

[:SENSe]:SEMAsk:OFFSet<n>:BANDwidth|B  →
 WIDTH[:RESolution]:AUTO 

Description	Turns the resolution bandwidth for the selected channel to manual or automatic mode or queries its state.	
Syntax	[:SENSe]:SEMAsk:OFFSet<n>:BANDwidth BWIDth [:RESolution]:AUTO {OFF ON 0 1}	
Query Syntax	[:SENSe]:SEMAsk:OFFSet<n>:BANDwidth BWIDth [:RESolution]:AUTO?	
Parameter	0 1 OFF ON	Set RBW to manual. Set RBW to auto. Set RBW to manual. Set RBW to auto.
Return parameter	0 1	RBW is set to manual. RBW is set to auto.

[:SENSe]:SEMAsk:OFFSet<n>:FREQUency:  →
 START 

Description	Sets or queries the start frequency of the selected offset.	
Syntax	[:SENSe]:SEMAsk:OFFSet<n>:FREQUency:START <freq>	
Query Syntax	[:SENSe]:SEMAsk:OFFSet<n>:FREQUency:START?	

Parameter/	<freq>	<NR3> Hz
Return parameter	<n>	<NR1>offset 1~5
Example	SEM:OFFS1:FREQ:STAR 2.5e+3	

[[:SENSe]:SEMAsk:OFFSet<n>:FREQuency: STOP (Set) →
→ (Query)

Description	Sets or queries the stop frequency of the selected offset.	
Syntax	[:SENSe]:SEMAsk:OFFSet<n>:FREQuency:STOP <freq>	
Query Syntax	[:SENSe]:SEMAsk:OFFSet<n>:FREQuency:STOP?	
Parameter/	<freq>	<NR3> Hz
Return parameter	<n>	<NR1>offset 1~5
Example	SEM:OFFS1:FREQ:STOP 2.5e+3	

[[:SENSe]:SEMAsk:OFFSet<n>:STARt: ABSolute (Set) →
→ (Query)

Description	Sets or queries the amplitude of the start frequency of the Absolute Mask for the selected offset.	
Syntax	[:SENSe]:SEMAsk:OFFSet<n>:STARt:ABSolute <ampl>	
Query Syntax	[:SENSe]:SEMAsk:OFFSet<n>:STARt:ABSolute?	
Parameter/	<ampl>	<NR3> dBm
Return parameter	<n>	<NR1>offset 1~5
Example	SEM:OFFS1:STAR:ABS 1.5e+1	

[[:SENSe]:SEMAsk:OFFSet<n>:STARt: RELative (Set) →
→ (Query)

Description	Sets or queries the amplitude of the start frequency of the Relative Mask for the selected offset.	
Syntax	[:SENSe]:SEMAsk:OFFSet<n>:STARt:RELative <ampl>	

Query Syntax	[:SENSe]:SEMAsk:OFFSet<n>:STARt:RELative?	
Parameter/	<ampl>	<NR3> dBc
Return parameter	<n>	<NR1> offset 1~5
Example	SEM:OFFS1:STAR:REL 2.5e+1	

Set →
 → Query

[:SENSe]:SEMAsk:OFFSet<n>:STATe

Description	Turns the selected offset on/off or queries its state.	
Syntax	[:SENSe]:SEMAsk:OFFSet<n>:STATe {OFF ON 0 1}	
Query Syntax	[:SENSe]:SEMAsk:OFFSet<n>:STATe?	
Parameter	0	Turns the selected offset off.
	1	Turns the selected offset on.
	OFF	Turns the selected offset off.
	ON	Turns the selected offset on.
Return parameter	0	The selected offset is off.
	1	The selected offset is on.
Example	SEM:OFFS1:STAT 1	

Set →
 → Query

[:SENSe]:SEMAsk:OFFSet<n>:STOP:ABSolute

Description	Sets or queries the amplitude of the stop frequency of the Absolute Mask for the selected offset.	
Syntax	[:SENSe]:SEMAsk:OFFSet<n>:STOP:ABSolute <ampl>	
Query Syntax	[:SENSe]:SEMAsk:OFFSet<n>:STOP:ABSolute?	
Parameter/	<ampl>	<NR3> dBm
Return parameter	<n>	<NR1>offset 1~5
Example	SEM:OFFS1:STOP:ABS 1.5e+1	

Set →
 → Query

[:SENSe]:SEMAsk:OFFSet<n>:STOP:ABSolute:COUple

Description	Couples the Absolute Stop amplitude to the Absolute Start amplitude for the selected offset.	
Syntax	[:SENSe]:SEMAsk:OFFSet<n>:STOP:ABSolute:COUPLE {OFF ON 0 1}	
Query Syntax	[:SENSe]:SEMAsk:OFFSet<n>:STOP:ABSolute:COUPLE?	
Parameter	0	Turns coupling off.
	1	Turns coupling on.
	OFF	Turns coupling off.
	ON	Turns coupling on.
Return parameter	0	Coupling is off.
	1	Coupling is on.
Example	SEM:OFFS1:STOP:ABS:COUP 0	

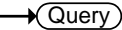
[:SENSe]:SEMAsk:OFFSet<n>:STOP:RELative  

Description	Sets or queries the amplitude of the stop frequency of the Relative Mask for the selected offset.	
Syntax	[:SENSe]:SEMAsk:OFFSet<n>:STOP:RELative <ampl>	
Query Syntax	[:SENSe]:SEMAsk:OFFSet<n>:STOP:RELative?	
Parameter/ Return parameter	<ampl> <n>	<NR3> dBc <NR1>offset 1~5
Example	SEM:OFFS1:STOP:REL 1.5e+1	

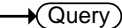
[:SENSe]:SEMAsk:OFFSet<n>:STOP:RELative:COUPLE  

Description	Couples the Relative Stop amplitude to the Relative Start amplitude for the selected offset.	
Syntax	[:SENSe]:SEMAsk:OFFSet<n>:STOP:RELative:COUPLE {OFF ON 0 1}	

Query Syntax	[:SENSE]:SEMask:OFFSet<n>:STOP:RELative:COUPle?	
Parameter	0	Turns coupling off.
	1	Turns coupling on.
	OFF	Turns coupling off.
	ON	Turns coupling on.
Return parameter	0	Coupling is off.
	1	Coupling is on.

Set →
 → Query

[:SENSE]:SEMask:OFFSet<n>:TEST

Description	Sets or queries the masks to use for the Fail Mask(s).	
Syntax	[:SENSE]:SEMask:OFFSet<n>:TEST {ABS REL AND OR}	
Query Syntax	[:SENSE]:SEMask:OFFSet<n>:TEST?	
Parameter/ Return parameter	ABS	Absolute mask
	REL	Relative mask
	AND	Absolute and Relative mask
	OR	Absolute or Relative mask
Example	:SEM:OFFS:1:TEST ABS	

Set →
 → Query

[:SENSE]:SEMask:SELEct

Description	Selects or queries the type of spectrum emission mask.	
Syntax	[:SENSE]:SEMask:SELEct {MANual W3GPP BWLan GWLan NWLan WIMax}	
Query Syntax	[:SENSE]:SEMask:SELEct?	

Parameter/	MANual	User-defined SEM
Return parameter	W3GPP	3GPP SEM
	BWLan	802.11b SEM
	GWLan	802.11g SEM
	NWLan	802.11n SEM
	WIMax	802.16 SEM

Example :SEM:SEL MAN

[[:SENSe]:SEMAsk:TYPE (Set) →
→ (Query)

Description Selects or queries the method used as the reference for calculating the offset power: Total power reference or power spectral density reference.

Syntax [:SENSe]:SEMAsk:TYPE {PSDRef|TPRef}

Query Syntax [:SENSe]:SEMAsk:TYPE?

Parameter/	PSDRef	Power Spectral Density Reference
Return parameter	TPRef	Total Power Reference

Example :SEM:TYPE PSDR

[[:SENSe]:SEMAsk:W3GPP:DUPLex:TYPE (Set) →
→ (Query)

Description Selects or queries the type of duplexing used for 3GPP tests.

Syntax [:SENSe]:SEMAsk:W3GPP:DUPLex:TYPE {FDD|TDD}

Query Syntax [:SENSe]:SEMAsk:W3GPP:DUPLex:TYPE?

Parameter/	FDD	Frequency-division duplexing
Return parameter	TDD	Time-division duplexing

Example :SEM:W3GPP:DUPL:TYPE FDD

[:SENSe]:SEMask:W3GPP:FDD:ADDition: LIMit (Set) →
→ (Query)

Description	Selects or queries the operating band used for the 3GPP FDD additional requirements. See the user manual for a list of the 3GPP operation bands.	
Syntax	[:SENSe]:SEMask:W3GPP:FDD:ADDition:LIMit {NONE BAND<n>}	
Query Syntax	[:SENSe]:SEMask:W3GPP:FDD:ADDition:LIMit?	
Parameter/ Return parameter	NONE BAND<n>	When n = band number
Example	:SEM:W3GPP:FDD:ADD:LIM BAND4	

[:SENSe]:SEMask:W3GPP:FDD:ADDition: MOPower (Set) →
→ (Query)

Description	Selects or queries Max Out Power for the 3GPP additional requirements for the selected offset. Please see the user manual for a list of the selectable maximum power output levels.	
Syntax	[:SENSe]:SEMask:W3GPP:FDD:ADDition:MOPower {NONE LEVel<n>}	
Query Syntax	[:SENSe]:SEMask:W3GPP:FDD:ADDition:MOPower?	
Parameter/ Return parameter	NONE LEVEL<n>	n=1 for 6≤P≤20 n=2 for P<6
Example	:SEM:W3GPP:FDD:ADD:MOP LEV1	

[:SENSe]:SEMask:W3GPP:FDD:MOPower (Set) →
→ (Query)

Description	Selects or queries Max Out Power for the selected offset. Please see the user manual for a list of the selectable maximum power output levels.	
-------------	--	--

Syntax	[:SENSe]:SEMAsk:W3GPP:FDD:MOPower {LEVel<n>}	
Query Syntax	[:SENSe]:SEMAsk:W3GPP:FDD:MOPower?	
Parameter/ Return parameter	NONE LEVEL<n>	n=1 for 43<=P n=2 for 39<=P<43 n=3 for 31<=P<39 n=4 for P<31
Example	:SEM:W3GPP:FDD:MOP LEV1	

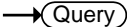
[:SENSe]:SEMAsk:W3GPP:FDD:TRANsmit: 
 MODE 

Description	Selects or queries the transmit mode of the FDD 3GPP test: Base station, or User Equipment.	
Syntax	[:SENSe]:SEMAsk:W3GPP:FDD:TRANsmit:MODE {BS UE}	
Query Syntax	[:SENSe]:SEMAsk:W3GPP:FDD:TRANsmit:MODE?	
Parameter/ Return parameter	BS UE	Base station User Equipment
Example	:SEM:W3GPP:FDD:TRAN:MODE UE	

 [:SENSe]:SEMAsk:W3GPP:TDD:CHIP:RATE 

Description	Selects or queries the chip rate for TDD 3GPP tests.	
Syntax	[:SENSe]:SEMAsk:W3GPP:TDD:CHIP:RATE {3.84e+6 1.28e+6 7.68e+6}	
Query Syntax	[:SENSe]:SEMAsk:W3GPP:TDD:CHIP:RATE?	
Parameter/ Return parameter	3.84e+6 1.28e+6 7.68e+6	<freq> <freq> <freq>
Example	:SEM:W3GPP:TDD:CHIP:RATE 3.84e+6	

`[[:SENSE]:SEMask:W3GPP:TDD:MOPower` (Set) →
→ (Query)

Description	Selects or queries Max Out Power for TDD 3GPP tests. See the user manual for the a list of the power levels.	
Syntax	[:SENSE]:SEMask:W3GPP:TDD:MOPower {LEVel<n>}	
Query Syntax	[:SENSE]:SEMask:W3GPP:TDD:MOPower?	
Parameter/ Return parameter	LEVEL<n>	For 3GPP TDD BS 3.84 and 7.68Mcps : n=1 for 43<=P n=2 for 39<=P<43 n=3 for 31<=P<39 n=4 for P<31 for 3GPP TDD BS 1.28Mcps: n=1 for 34<=P n=2 for 26<=P<34 n=3 for 26<31
Example	:SEM:W3GPP:TDD:MOP LEV1	

`[[:SENSE]:SEMask:W3GPP:TDD:TRANsmite` (Set) →
→ (Query)
MODE

Description	Selects or queries the transmit mode of the TDD 3GPP test: Base station, or User Equipment.	
Syntax	[:SENSE]:SEMask:W3GPP:TDD:TRANsmite:MODE {BS UE}	
Query Syntax	[:SENSE]:SEMask:W3GPP:TDD:TRANsmite:MODE?	
Parameter/ Return parameter	BS UE	Base station User Equipment
Example	:SEM:W3GPP:TDD:TRAN:MODE UE	

**[[:SENSe]:SEMAsk:WIMax:CHANnel:
BANDwidth|BWIDth** (Set) →
→ (Query)

Description	Selects or queries the 802.16 channel bandwidth (10M or 20M channelization).	
Syntax	[:SENSe]:SEMAsk:WIMax:CHANnel:BANDwidth BWIDth {1e+7 2e+7}	
Query Syntax	[:SENSe]:SEMAsk:WIMax:CHANnel:BANDwidth BWIDth?	
Parameter/ Return parameter	1e+7 2e+7	<freq> <freq>
Example	:SEM:WIM:CHAN:BAND 1e+7	

[[:SENSe]:SEQuence<n>:DELeTe (Set) →

Description	Deletes the chosen sequence.	
Syntax	[:SENSe]:SEQuence<n>:DELeTe	
Parameter	<n>	<NR1> sequence 1 to 5.
Example	:SEQ1:DEL	

[[:SENSe]:SWEep:EGATe:DELay (Set) →
→ (Query)

Description	Sets or queries the gate delay time.	
Syntax	[:SENSe]:SWEep:EGATe:DELay <time>	
Query Syntax	[:SENSe]:SWEep:EGATe:DELay?	
Parameter/ Return parameter	<time>	Gate delay time in seconds
Example	SWE:EGAT:DEL 10 ms	

[[:SENSe]:SWEep:EGATe:LENGth (Set) →
→ (Query)

Description	Sets or queries the gate length time.	
-------------	---------------------------------------	--

Syntax	[:SENSE]:SWEep:EGATe:LENGth <time>	
Query Syntax	[:SENSE]:SWEep:EGATe:LENGth?	
Parameter/ Return parameter	<time>	Gate length time in seconds
Example	SWE:EGAT:LENG 10 ms	

Set →
 → Query

[:SENSE]:SWEep:EGATe:STATe

Description	Turns the gated sweep mode on/off or queries its state.	
Syntax	[:SENSE]:SWEep:EGATe:STATe {OFF ON 0 1}	
Query Syntax	[:SENSE]:SWEep:EGATe:STATe?	
Parameter	0	Turns gated sweep mode off.
	1	Turns gated sweep mode on.
	OFF	Turns gated sweep mode off.
	ON	Turns gated sweep mode on.
Return parameter	0	Gated sweep mode is off.
	1	Gated sweep mode is on.
Example	:SWE:EGAT:STAT 1	

Set →
 → Query

[:SENSE]:SWEep:TIME

Description	Sets the sweep time.	
Syntax	[:SENSE]:SWEep:TIME <time>	
Query Syntax	[:SENSE]:SWEep:TIME?	
Parameter/ Return parameter	<time>	Sweep time in seconds
Example	SWE:TIME 60 ms	

Set →
 → Query

[:SENSE]:SWEep:TIME:AUTO

Description	Turns the Sweep time setting to auto (on) or manual (off).	
-------------	--	--

Syntax	[:SENSe]:SWEep:TIME:AUTO {OFF ON 0 1}	
Query Syntax	[:SENSe]:SWEep:TIME:AUTO?	
Parameter	0	Turn sweep time to manual (off).
	1	Turn sweep time to auto (on).
	OFF	Turn sweep time to manual (off).
	ON	Turn sweep time to auto (on).
Return parameter	0	Sweep time is set to manual.
	1	Sweep time is set to automatic.
Example	:SWE:TIME:AUTO 0	

Set →
 → Query

Description	Sets or queries the TOI reference to the upper or lower base.	
Syntax	[:SENSe]:TOI:REfERENCE {UPPer LOWer}	
Query Syntax	[:SENSe]:TOI:REfERENCE?	
Parameter/	UPPer	Upper base.
Return parameter	LOWer	Lower base.
Example	:TOI:REF UPp	

Set →
 → Query

Description	Sets the TOI pass/fail limit amplitude.	
Syntax	[:SENSe]:TOI:LIMit <ampl>	
Query Syntax	[:SENSe]:TOI:LIMit?	
Parameter	<ampl>	<NRf>Power or voltage
Return parameter	<NR3>	
Example	TOI:LIM 30	



SOURce Commands

:SOURce:POWer[:LEVel][:IMMediate][:AMPLitude] ...162
 :SOURce:POWer[:LEVel][:IMMediate][:AMPLitude]

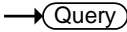
:OFFSet..... 162
 :SOURce:POWer[:LEVel][:IMMediate][:AMPLitude]
 :STEP 163
 :SOURce:POWer[:LEVel][:IMMediate][:AMPLitude]:
 STEP:AUTO 163
 :SOURce:POWer:MODE 163
 :SOURce:POWer:SWEEP..... 164

:SOURce:POWer[:LEVel][:IMMediate] 
 [:AMPLitude] 

Description	Sets or queries the tracking generator power level.	
Syntax	:SOURce:POWer[:LEVel][:IMMediate][:AMPLitude] <ampl>	
Query Syntax	:SOURce:POWer[:LEVel][:IMMediate][:AMPLitude]?	
Parameter	<ampl>	<NRf>Power or voltage
Return parameter	<NR3>	
Example	:SOUR:POW 30 dbm	

:SOURce:POWer[:LEVel][:IMMediate] 
 [:AMPLitude]:OFFSet 

Description	Sets or queries the tracking generator offset level.	
Syntax	:SOURce:POWer[:LEVel][:IMMediate][:AMPLitude] :OFFSet <rel_ampl>	
Query Syntax	:SOURce:POWer[:LEVel][:IMMediate][:AMPLitude] :OFFSet?	
Parameter	<rel_ampl>	<NRf>
Return parameter	<NR3>	dB
Example	:SOUR:POW:OFFS 10 db	

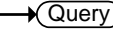
**:SOURce:POWer[:LEVel][:IMMediate]
[:AMPLitude]:STEP**
 →
 → 

Description	Sets or queries the tracking generator step level.	
Syntax	:SOURce:POWer[:LEVel][:IMMediate][:AMPLitude]:STEP <rel_amp>	
Query Syntax	:SOURce:POWer[:LEVel][:IMMediate][:AMPLitude]:STEP?	
Parameter	<rel_amp>	<NRf>
Return parameter	<NR3>	dB
Example	:SOUR:POW:STEP .5 db	

**:SOURce:POWer[:LEVel][:IMMediate]
[:AMPLitude]:STEP:AUTO**
 →
 → 

Description	Turns the tracking generator step level setting to auto (on) or manual (off).	
Syntax	:SOURce:POWer[:LEVel][:IMMediate][:AMPLitude]:STEP:AUTO {OFF ON 0 1}	
Query Syntax	:SOURce:POWer[:LEVel][:IMMediate][:AMPLitude]:STEP:AUTO?	
Parameter	0	Turn TG step level to manual (off).
	1	Turn TG step level to auto (on).
	OFF	Turn TG step level to manual (off).
	ON	Turn TG step level to auto (on).
Return parameter	0	TG step level is set to manual.
	1	TG step level is set to automatic.
Example	:SOUR:POW:STEP:AUTO 1	

:SOURce:POWer:MODE
 →
 → 

Description	Sets the Power Sweep mode.	
-------------	----------------------------	--

Syntax	:SOURce:POWer:MODE {FIXed SWEep}	
Query Syntax	:SOURce:POWer:MODE?	
Parameter/	FIXed	Power sweep off.
Return parameter	SWEep	Power sweep on.
Example	:SOUR:POW:MODE FIX	

:SOURce:POWer:SWEep





Description	Sets the Power Sweep offset level.	
Syntax	:SOURce:POWer:SWEep <rel_ampl>	
Query Syntax	:SOURce:POWer:SWEep?	
Parameter	<rel_ampl>	<NRf> (-5 to +5 dB)
Return parameter	<NR3>	dB
Example	:SOUR:POW:SWE 5 db	

SYSTEM Commands

:SYSTem:ALARm:STATe.....	165
:SYSTem:CLOCK<n>:DATE.....	166
:SYSTem:CLOCK<n>:MODE.....	166
:SYSTem:CLOCK<n>:STATe.....	166
:SYSTem:CLOCK<n>:TIME.....	167
:SYSTem:COMMunicate:GPIB[;SELf]:ADDReSS.....	167
:SYSTem:COMMunicate:LANReSet.....	167
:SYSTem:COMMunicate:SERial[;RECeive]:BAUD.....	168
:SYSTem:COMMunicate:USB:MODE.....	168
:SYSTem:DATE.....	168
:SYSTem:ERRor:CLEAr.....	168
:SYSTem:ERRor[:NEXT]?.....	169
:SYSTem:KLOCK.....	169
:SYSTem:PRESet.....	169
:SYSTem:PRESet:TYPE.....	169
:SYSTem:PRESet:USER:SAVE.....	169
:SYSTem:REBoot.....	170
:SYSTem:SHUTdown.....	170
:SYSTem:TIME.....	170
:SYSTem:UPDate.....	170
:SYSTem:VERSIon:HARDware?.....	171
:SYSTem:VERSIon:SOFTware?.....	171

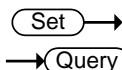
:SYSTem:ALARm:STATe



Description	Sets the system alarm output on/off	
Syntax	:SYSTem:ALARm:STATe {OFF ON 0 1}	
Query Syntax	:SYSTem:ALARm:STATe?	
Parameter	0	Turn the alarm off.
	1	Turn the alarm on.
	OFF	Turn the alarm off.
	ON	Turn the alarm off.
Return parameter	0	The alarm is off.
	1	The alarm is on.
Example	:SYST:ALAR:STAT 1	

:SYSTem:CLOCK<n>:DATE (Set) →
→ (Query)

Description	Sets the day for the selected wake-up clock.	
Syntax	:SYSTem:CLOCK<n>:DATE [MONday TUESday WEDnesday THURsday FRIday SATurday SUNday]	
Query Syntax	:SYSTem:CLOCK<n>:DATE?	
Parameter/ Return parameter	<n> MONday TUESday WEDnesday THURsday FRIday SATurday SUNday	Wake-up clock number 1 to 7 Set to Monday Set to Tuesday Set to Wednesday Set to Thursday Set to Friday Set to Saturday Set to Sunday
Example	:SYST:CLOC1:DATE MON	

:SYSTem:CLOCK<n>:MODE (Set) →
→ (Query)

Description	Sets the alarm mode for the selected wake-up clock.	
Syntax	:SYSTem:CLOCK<n>:MODE {REPeat SINGle}	
Query Syntax	:SYSTem:CLOCK<n>:MODE?	
Parameter/ Return parameter	<n> REPeat SINGle	Wake-up clock number 1 to 7 Set the wake-up clock to repeat. Set the wake-up clock to single.
Example	:SYST:CLOC1:MODE REP	

:SYSTem:CLOCK<n>:STATe (Set) →
→ (Query)

Description	Turns the selected wake-up clock on/off.	
Syntax	:SYSTem:CLOCK<n>:STATe {OFF ON 0 1}	
Query Syntax	:SYSTem:CLOCK<n>:STATe?	

Parameter	<n>	Wake-up clock number 1 to 7
	0	Turn the wake-up clock off.
	1	Turn the wake-up clock on.
	OFF	Turn the wake-up clock off.
	ON	Turn the wake-up clock off.
Return parameter	0	The wake-up clock is off.
	1	The wake-up clock is on.
Example	:SYST:CLOC1:STATE 1	

:SYSTem:CLOCK<n>:TIME (Set) →
→ (Query)

Description	Sets the alarm time for the selected wake-up clock.	
Syntax	:SYSTem:CLOCK<n>:TIME <hour>,<minute>	
Query Syntax	:SYSTem:CLOCK<n>:TIME?	
Parameter/ Return parameter	<hour>	<NR1> Sets the alarm hour.
	<minute>	<NR1> Sets the alarm minute.
	<n>	Wake-up clock number 1 to 7
Example	:SYST:CLOC1:TIME 20,50	

:SYSTem:COMMunicate:GPIB[:SELF]
:ADDRess (Set) →

Description	Sets the GPIB address.	
Syntax	:SYSTem:COMMunicate:GPIB[:SELF]:ADDRess <integer>	
Parameter	<integer>	0 to 30
Example	:SYST:COMM:GPIB:ADDR 10	

:SYSTem:COMMunicate:LANReset (Set) →

Description	Reset the LAN configuration and reboot.	
Syntax	:SYSTem:COMMunicate:LANReset	
Example	:SYST:COMM:LANR	

:SYSTem:COMMunicate:SERial[:RECeive]

:BAUD

Set →

Description Sets the RS232 Baud rate.

Syntax :SYSTem: COMMunicate:SERial[:RECeive]:BAUD
<integer>

Parameter <integer> 300|600|1200|2400|4800|9600|19200|
38400|57600|115200

Example :SYST:COMM:SER:BAUD 9600

:SYSTem:COMMunicate:USB:MODE

Set →

Description Configures the USB mode.

Syntax :SYSTem:COMMunicate:USB:MODE {HOST|DEvIce}

Parameter/ HOST USB host mode
Return parameter DEvIce USB device mode

Example :SYST:COMM:USB:MODE DEV

:SYSTem:DATE

Set →

→ **Query**

Description Sets the system date.

Syntax :SYSTem:DATE <year>,<month>,<day>

Query Syntax :SYSTem:DATE?

Parameter/ <year> <NR1>
Return parameter <month> <NR1>
<day> <NR1>

Example :SYST:DATE 2011,03,27

:SYSTem:ERRor:CLEar

Set →

Description Clears the errors messages from the error queue.

Syntax :SYSTem:ERRor:CLEar

:SYSTem:ERRor[:NEXT]? → Query

Description Returns the next message from the error queue. Reading the error from the error queue will clear that error from the queue.

Syntax :SYST:ERR?

:SYSTem:KLOCK Set →

Description Locks/unlocks the front panel keys.

Syntax :SYSTem:KLOCK {ON|OFF}

Parameter	ON	Lock the front panel keys
	OFF	Unlock the front panel keys

Example :SYST:KLOCK OFF

:SYSTem:PRESet Set →

Description Returns the GSP-930 to preset settings.

Syntax :SYST:PRES

:SYSTem:PRESet:TYPE Set →

Description Sets the preset type between user-defined and factory default.

Syntax :SYSTem:PRESet:TYPE {USER|FACTory}

Query Syntax :SYSTem:PRESet:TYPE?

Parameter/ Return parameter	USER	User defined preset
	FACTory	Factory default

Example :SYST:PRES:TYPE USER

:SYSTem:PRESet:USER:SAVE Set →

Description Save the current environment as the “User” preset settings.

Syntax :SYST:PRES:USER:SAVE

:SYSTem:REBoot

Set →

Description Restart/Reboot the GSP-930.

Syntax :SYSTem:REBoot

:SYSTem:SHUTdown

Set →

Description Shut down the GSP-930.

Syntax :SYST:SHUT

:SYSTem:TIME

Set →

→ Query

Description Sets the system time.

Syntax :SYSTem:TIME <hour>,<minute>,<second>

Query Syntax :SYSTem:TIME?

Parameter/	<hour>	<NR1>
Return parameter	<minute>	<NR1>
	<second>	<NR1>

Example :SYST:TIME 19,26,30

:SYSTem:UPDate

Set →

Description Updates the system with new firmware from files located on an external USB drive. The firmware files must be included in the directory named /gsp930.

Warning Do not perform this command if the update file is *not* on the USB drive.

If the update file is not on the USB drive, it will cause the instrument to continuously loop until a USB drive with the appropriate update file is inserted into the USB drive.

Syntax :SYST:UPD

:SYSTem:VERSion:HARDware? → Query

Description Returns the system firmware version.

Query Syntax :SYSTem:VERSion:HARDware?

Return parameter <string> T.1.X.X.X

Example :SYST:VERS:HARD?
>T.1.0.0.0

:SYSTem:VERSion:SOFTware? → Query

Description Returns the system software version.

Query Syntax :SYSTem:VERSion:SOFTware?

Return parameter <string> T1.00_2011.11.21_13
Where:
T1.00 = firmare version
2011 = year
11 = month
21 = day
13 = internal reference (not for end-user)

Example :SYST:VERS:SOFT?
> T1.00_2011.11.21_13

STATus Commands

:STATus:OPERation:CONDition?	172
:STATus:OPERation:ENABle	173
:STATus:OPERation[:EVENT]?	173
:STATus:OPERation:NTRansition	174
:STATus:OPERation:PTRansition	174
:STATus:QUEStionable:CONDition?	175
:STATus:QUEStionable:ENABle	175
:STATus:QUEStionable[:EVENT]?	176
:STATus:QUEStionable:NTRansition	176
:STATus:QUEStionable:PTRansition	177
:STATus:QUEStionable:FREQuency:CONDition?	177
:STATus:QUEStionable:FREQuency:ENABle	178
:STATus:QUEStionable:FREQuency[:EVENT]?	178
:STATus:QUEStionable:FREQuency:NTRansition	178
:STATus:QUEStionable:FREQuency:PTRansition	179
:STATus:QUEStionable:ACPLimit:CONDition?	179
:STATus:QUEStionable:ACPLimit:ENABle	180
:STATus:QUEStionable:ACPLimit[:EVENT]?	180
:STATus:QUEStionable:ACPLimit:NTRansition	181
:STATus:QUEStionable:ACPLimit:PTRansition	181
:STATus:QUEStionable:SEMLimit:CONDition?	182
:STATus:QUEStionable:SEMLimit:ENABle?	182
:STATus:QUEStionable:SEMLimit[:EVENT]?	183
:STATus:QUEStionable:SEMLimit:NTRansition	183
:STATus:QUEStionable:SEMLimit:PTRansition	184
:STATus:QUEStionable:TOILimit:CONDition?	185
:STATus:QUEStionable:TOILimit:ENABle	185
:STATus:QUEStionable:TOILimit[:EVENT]?	186
:STATus:QUEStionable:TOILimit:NTRansition	186
:STATus:QUEStionable:TOILimit:PTRansition	186
:STATus:PRESet	187

:STATus:OPERation:CONDition?



Description	Returns the bit weight of the Operation Status Condition register.
-------------	--

Query Syntax	:STATus:OPERation:CONDition?
--------------	------------------------------

Return parameter	Bit	Bit Weight	Description
	0~2	N/A	Not used
	3	8	Sweeping
	4	16	Measuring
	5	32	Wait for Trigger
	6~15	N/A	Not used

Example :STAT:OPER:COND?
>8

:STATus:OPERation:ENABLE (Set) →
← (Query)

Description Sets or queries the Operation Status Event Enable register.

Syntax :STATus:OPERation:ENABLE <integer>

Query Syntax :STATus:OPERation:ENABLE?

Return parameter	Bit	Bit Weight	Description
	0~2	N/A	Not used
	3	8	Sweeping
	4	16	Measuring
	5	32	Wait for Trigger
	6~15	N/A	Not used

Example :STAT:OPER:ENAB 32

:STATus:OPERation[:EVENT]? → (Query)

Description Returns the bit weight of the Operation Status Event register. Reading this register will clear the event register.

Query Syntax :STATus:OPERation[:EVENT]?

Return parameter	Bit	Bit Weight	Description
	0~2	N/A	Not used
	3	8	Sweeping
	4	16	Measuring
	5	32	Wait for Trigger
	6~15	N/A	Not used

Example :STAT:OPER?
>8

:STATus:OPERation:NTRansition (Set) →
→ (Query)

Description Sets or queries the bit weight of the NTR filter for the Operation Status register.

Syntax :STATus:OPERation:NTRansition <integer>

Query Syntax :STATus:OPERation:NTRansition?

Return parameter	Bit	Bit Weight	Description
	0~2	N/A	Not used
	3	8	Sweeping
	4	16	Measuring
	5	32	Wait for Trigger
	6~15	N/A	Not used

Example :STAT:OPER:NTR 32

:STATus:OPERation:PTRansition (Set) →
→ (Query)

Description Sets or queries the bit weight of the PTR filter for the Operation Status register.

Syntax :STATus:OPERation:PTRansition <integer>

Query Syntax :STATus:OPERation:PTRansition?

Return parameter	Bit	Bit Weight	Description
	0~2	N/A	Not used
	3	8	Sweeping
	4	16	Measuring
	5	32	Wait for Trigger
	6~15	N/A	Not used

Example :STAT:OPER:PTR 32

:STATus:QUEStionable:CONDition? → Query

Description Returns the bit weight of the Questionable Status Condition register.

Query Syntax :STATus:QUEStionable:CONDition?

Return parameter	Bit	Bit Weight	Description
	5	32	Frequency
	8	256	Uncal
	9	512	Limit Fail
	10	1024	ACPLimit
	11	2048	SEM Limit
	12	4096	TOI Limit
	13	8192	Pmet Limit Fail

Example :STAT:QUES:COND?
>16

:STATus:QUEStionable:ENABLE Set →
→ Query

Description Sets or queries the Questionable Status Event Enable register.

Syntax :STATus:QUEStionable:ENABLE <integer>

Query Syntax :STATus:QUEStionable:ENABLE?

Return parameter	Bit	Bit Weight	Description
	5	32	Frequency
	8	256	Uncal
	9	512	Limit Fail
	10	1024	ACPLimit
	11	2048	SEM Limit
	12	4096	TOI Limit
	13	8192	Pmet Limit Fail

Example :STAT:QUES:ENAB 4096

:STATus:QUEStionable[:EVENT]? → Query

Description Returns the bit weight of the Questionable Status Event register. Reading this register will clear the event register.

Query Syntax :STATus:QUEStionable[:EVENT]?

Return parameter	Bit	Bit Weight	Description
	5	32	Frequency
	8	256	Uncal
	9	512	Limit Fail
	10	1024	ACPLimit
	11	2048	SEM Limit
	12	4096	TOI Limit
	13	8192	Pmet Limit Fail

Example :STAT:QUES?
>16

Set →

:STATus:QUEStionable:NTRansition → Query

Description Sets or queries the bit weight of the NTR filter for the Questionable Status register.

Syntax :STATus:QUEStionable:NTRansition <integer>

Query Syntax :STATus: QUEStionable:NTRansition?

Return parameter	Bit	Bit Weight	Description
	5	32	Frequency
	8	256	Uncal
	9	512	Limit Fail
	10	1024	ACPLimit
	11	2048	SEM Limit
	12	4096	TOI Limit
	13	8192	Pmet Limit Fail

Example :STAT:QUES:NTR 32

:STATus:QUEStionable:PTRansition (Set) →
→ (Query)

Description Sets or queries the bit weight of the PTR filter for the Questionable Status register.

Syntax :STATus:QUEStionable:PTRansition <integer>

Query Syntax :STATus:QUEStionable:PTRansition?

Return parameter	Bit	Bit Weight	Description
	5	32	Frequency
	8	256	Uncal
	9	512	Limit Fail
	10	1024	ACPLimit
	11	2048	SEM Limit
	12	4096	TOI Limit
	13	8192	Pmet Limit Fail

Example :STAT:QUES:PTR 32

:STATus:QUEStionable:FREQuency:CONDition? → (Query)

Description Returns the bit weight of the Questionable Status Frequency Condition register.

Query Syntax :STATus:QUEStionable:FREQuency:CONDition?

Return parameter	Bit	Bit Weight	Description
	5	32	Invalid Span/BW

Example :STAT:QUES:FREQ:COND?
>32

:STATus:QUESTionable:FREQuency:ENABLE  

Description Sets or queries the Questionable Status Frequency Event Enable register.

Syntax :STATus:QUESTionable:FREQuency:ENABLE <integer>

Query Syntax :STATus:QUESTionable:FREQuency:ENABLE?

Return parameter	Bit	Bit Weight	Description
	5	32	Invalid Span/BW

Example :STAT:QUES:FREQ:ENAB 32

:STATus:QUESTionable:FREQuency
[:EVENT]? 

Description Returns the bit weight of the Questionable Status Frequency Event register. Reading this register will clear the event register.

Query Syntax :STATus:QUESTionable:FREQuency[:EVENT]?

Return parameter	Bit	Bit Weight	Description
	5	32	Invalid Span/BW

Example :STAT:QUES:FREQ?
>32

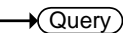
:STATus:QUESTionable:FREQuency:
NTRansition  

Description Sets or queries the bit weight of the NTR filter for the Questionable Status Frequency register.

Syntax :STATus:QUESTionable:FREQuency:NTRansition
<integer>

Query Syntax :STATus:QUESTionable:FREQuency:NTRansition?

Return parameter	Bit	Bit Weight	Description
	5	32	Invalid Span/BW

Example :STAT:QUES:FREQ:NTR 32

:STATus:QUESTionable:FREQuency:PTRansition (Set) →
→ (Query)

Description Sets or queries the bit weight of the PTR filter for the Questionable Status Frequency register.

Syntax :STATus:QUESTionable:FREQuency:PTRansition <integer>

Query Syntax :STATus:QUESTionable:FREQuency:PTRansition?

Return parameter	Bit	Bit Weight	Description
	5	32	Invalid Span/BW

Example :STAT:QUES:FREQ:PTR 32

:STATus:QUESTionable:ACPLimit:CONDition? → (Query)

Description Returns the bit weight of the Questionable Status ACP Limit Condition register.

Query Syntax :STATus:QUESTionable:ACPLimit:CONDition?

Return parameter	Bit	Bit Weight	Description
	0	1	Main channel high fail
	1	2	Main channel low fail
	2	4	Adj1 high fail
	3	8	Adj1 low fail
	4	16	Adj2 high fail
	5	32	Adj2 low fail
	6	64	Adj3 high fail
	7	128	Adj3 low fail

Example :STAT:QUES:ACPL:COND? >1

:STATus:QUEStionable:ACPLimit:ENABLE  

Description	Sets or queries the Questionable Status ACP Limit Event Enable register.		
Syntax	:STATus:QUEStionable:ACPLimit:ENABLE <integer>		
Query Syntax	:STATus:QUEStionable:ACPLimit:ENABLE?		
Return parameter	Bit	Bit Weight	Description
	0	1	Main channel high fail
	1	2	Main channel low fail
	2	4	Adj1 high fail
	3	8	Adj1 low fail
	4	16	Adj2 high fail
	5	32	Adj2 low fail
	6	64	Adj3 high fail
	7	128	Adj3 low fail
Example	:STAT:QUES:ACPL:ENAB 3		

:STATus:QUEStionable:ACPLimit[:EVENT]? 

Description	Returns the bit weight of the Questionable Status ACP Limit Event register. Reading this register will clear the event register.		
Query Syntax	:STATus:QUEStionable:ACPLimit[:EVENT]?		
Return parameter	Bit	Bit Weight	Description
	0	1	Main channel high fail
	1	2	Main channel low fail
	2	4	Adj1 high fail
	3	8	Adj1 low fail
	4	16	Adj2 high fail
	5	32	Adj2 low fail
	6	64	Adj3 high fail
	7	128	Adj3 low fail
Example	:STAT:QUES:ACPL?>3		

**:STATus:QUEStionable:ACPLimit:
NTRansition**



Description Sets or queries the bit weight of the NTR filter for the Questionable Status ACP Limit register.

Syntax :STATus:QUEStionable:ACPLimit:NTRansition <integer>

Query Syntax :STATus:QUEStionable:ACPLimit:NTRansition?

Return parameter	Bit	Bit Weight	Description
	0	1	Main channel high fail
	1	2	Main channel low fail
	2	4	Adj1 high fail
	3	8	Adj1 low fail
	4	16	Adj2 high fail
	5	32	Adj2 low fail
	6	64	Adj3 high fail
	7	128	Adj3 low fail

Example :STAT:QUES:ACPL:NTR 3

**:STATus:QUEStionable:ACPLimit:
PTRansition**



Description Sets or queries the bit weight of the PTR filter for the Questionable Status ACP Limit register.

Syntax :STATus:QUEStionable:ACPLimit:PTRansition <integer>

Query Syntax :STATus:QUEStionable:ACPLimit:PTRansition?

Return parameter	Bit	Bit Weight	Description
	0	1	Main channel high fail
	1	2	Main channel low fail
	2	4	Adj1 high fail
	3	8	Adj1 low fail
	4	16	Adj2 high fail
	5	32	Adj2 low fail
	6	64	Adj3 high fail
	7	128	Adj3 low fail

Example :STAT:QUES:ACPL:PTR 3

:STATus:QUESTionable:SEMLimit

:CONDition?

→ Query

Description Returns the bit weight of the Questionable Status SEM Limit Condition register.

Query Syntax :STATus:QUESTionable:SEMLimit:CONDition?

Return parameter	Bit	Bit Weight	Description
	0	1	Offset 1, Upper fail
	1	2	Offset 1, Lower fail
	2	4	Offset 2, Upper fail
	3	8	Offset 2, Lower fail
	4	16	Offset 3, Upper fail
	5	32	Offset 3, Lower fail
	6	64	Offset 4, Upper fail
	7	128	Offset 4, Lower fail
	8	256	Offset 5, Upper fail
	9	512	Offset 5, Lower fail

Example :STAT:QUES:SEML:COND?
>3

Set →

:STATus:QUESTionable:SEMLimit:ENABLE?

→ Query

Description Sets or queries the Questionable Status SEM Limit Enable register.

Syntax :STATus:QUESTionable:SEMLimit:ENABLE <integer>

Query Syntax :STATus:QUEStionable:SEMLimit:ENABle?

Return parameter	Bit	Bit Weight	Description
	0	1	Offset 1, Upper fail
	1	2	Offset 1, Lower fail
	2	4	Offset 2, Upper fail
	3	8	Offset 2, Lower fail
	4	16	Offset 3, Upper fail
	5	32	Offset 3, Lower fail
	6	64	Offset 4, Upper fail
	7	128	Offset 4, Lower fail
	8	256	Offset 5, Upper fail
	9	512	Offset 5, Lower fail

Example :STAT:QUES:SEML:ENAB 3

:STATus:QUEStionable:SEMLimit[:EVENT]? → **Query**

Description Returns the bit weight of the Questionable Status SEM Limit Event register. Reading this register will clear the event register.

Query Syntax :STATus:QUEStionable:SEMLimit[:EVENT]?

Return parameter	Bit	Bit Weight	Description
	0	1	Offset 1, Upper fail
	1	2	Offset 1, Lower fail
	2	4	Offset 2, Upper fail
	3	8	Offset 2, Lower fail
	4	16	Offset 3, Upper fail
	5	32	Offset 3, Lower fail
	6	64	Offset 4, Upper fail
	7	128	Offset 4, Lower fail
	8	256	Offset 5, Upper fail
	9	512	Offset 5, Lower fail

Example :STAT:QUES:SEML?
>3

:STATus:QUEStionable:SEMLimit
:NTRansition

Set →

→ **Query**

Description	Sets or queries the bit weight of the NTR filter for the Questionable Status SEM Limit register.		
Syntax	:STATus:QUEStionable:SEMLimit:NTRansition <integer>		
Query Syntax	:STATus:QUEStionable:SEMLimit:NTRansition?		
Return parameter	Bit	Bit Weight	Description
	0	1	Offset 1, Upper fail
	1	2	Offset 1, Lower fail
	2	4	Offset 2, Upper fail
	3	8	Offset 2, Lower fail
	4	16	Offset 3, Upper fail
	5	32	Offset 3, Lower fail
	6	64	Offset 4, Upper fail
	7	128	Offset 4, Lower fail
	8	256	Offset 5, Upper fail
	9	512	Offset 5, Lower fail
Example	:STAT:QUES:SEML:NTR 3		

:STATus:QUEStionable:SEMLimit:
PTRansition

Description	Sets or queries the bit weight of the PTR filter for the Questionable Status SEM Limit register.		
Syntax	:STATus:QUEStionable:SEMLimit:PTRansition <integer>		
Query Syntax	:STATus:QUEStionable:SEMLimit:PTRansition?		

Return parameter	Bit	Bit Weight	Description
	0	1	Offset 1, Upper fail
	1	2	Offset 1, Lower fail
	2	4	Offset 2, Upper fail
	3	8	Offset 2, Lower fail
	4	16	Offset 3, Upper fail
	5	32	Offset 3, Lower fail
	6	64	Offset 4, Upper fail
	7	128	Offset 4, Lower fail
	8	256	Offset 5, Upper fail
	9	512	Offset 5, Lower fail

Example :STAT:QUES:SEML:PTR 3

:STATus:QUESTIONable:TOILimit:
CONDition?

→ Query

Description Returns the bit weight of the Questionable Status
TOI Limit Condition register.

Query Syntax :STATus:QUESTIONable:ACPLimit:CONDition?

Return parameter	Bit	Bit Weight	Description
	0	1	3 rd lower fail
	1	2	3 rd upper fail

Example :STAT:QUES:TOIL:COND?
>1

Set →

:STATus:QUESTIONable:TOILimit:ENABLE

→ Query

Description Sets or queries the Questionable Status TOI Limit
Event Enable register.

Syntax :STATus:QUESTIONable:TOILimit:ENABLE <integer>

Query Syntax :STATus:QUESTIONable:TOILimit:ENABLE?

Return parameter	Bit	Bit Weight	Description
	0	1	3 rd lower fail
	1	2	3 rd upper fail

Example :STAT:QUES:TOIL:ENAB 1

Return parameter	Bit	Bit Weight	Description
	0	1	3 rd lower fail
	1	2	3 rd upper fail

Example :STAT:QUES:TOIL:PTR 1

:STATus:PRESet (Set) →

Description Loads the preset settings.

Syntax :STATus:PRESet

TRACe Commands

:TRACe[:DATA]?187

:TRACe[:DATA]? → (Query)

Description Returns the trace data for the selected trace in CSV format. There are 601 data points in total.

Query Syntax :TRACe[:DATA]? TRACe<n>

Parameter <n> <NR1> 1~4

Return Parameter <csv data> Trace data in CSV format:
point#1, point#2.....point#n

Example :TRAC? TRAC1
>-5.234e+01,-4.593e+01,-5.533e+01,-4.604e+01,-
>5.353e+01,-4.557e+01,-5.280e+0
>1,-4.785e+01,-5.459e+01,-4.578e+01,.....

TRIGger Commands

:TRIGger[:SEQuence]:DELay.....	188
:TRIGger[:SEQuence]:DEMod:DELay.....	188
:TRIGger[:SEQuence]:DEMod:LEVel.....	189
:TRIGger[:SEQuence]:DEMod:MODE.....	189
:TRIGger[:SEQuence]:DEMod:SLOPe.....	189
:TRIGger[:SEQuence]:DEMod:SOURce.....	190
:TRIGger[:SEQuence]:EXTernal:SLOPe.....	190
:TRIGger[:SEQuence]:MODE.....	190
:TRIGger[:SEQuence]:PMETer:SOURce.....	191
:TRIGger[:SEQuence]:SOURce.....	191
:TRIGger[:SEQuence]:VIDeo:FREQuency.....	191
:TRIGger[:SEQuence]:VIDeo:LEVel.....	192
:TRIGger[:SEQuence]:VIDeo:SLOPe.....	192

Set →
 → Query

:TRIGger[:SEQuence]:DELay

Description	Sets the trigger delay time in seconds.	
Syntax	:TRIGger[:SEQuence]:DELay <time>	
Query Syntax	:TRIGger[:SEQuence]:DELay?	
Parameter/ Return parameter	<time>	Delay time in seconds
Example	:TRIG:DEL 1.0e-2	

Set →
 → Query

:TRIGger[:SEQuence]:DEMod:DELay

Description	Sets the AF trigger delay time in seconds for AM/FM demodulation.	
Syntax	:TRIGger[:SEQuence]:DEMod:DELay <time>	
Query Syntax	:TRIGger[:SEQuence]:DEMod:DELay?	
Parameter/ Return parameter	<time>	Delay time in seconds
Example	:TRIG:DEM:DEL 1.0 ms	

Set →
 → Query

:TRIGger[:SEQuence]:DEMod:LEVel

Description Sets the trigger level for AM/FM demodulation.

Syntax :TRIGger[:SEQuence]:DEMod:LEVel <NRf>

Query Syntax :TRIGger[:SEQuence]:DEMod:LEVel?

Parameter	<NRf>	AM unit = % FM unit = Hz
------------------	-------	-----------------------------

Return parameter	<NR3>	
-------------------------	-------	--

Example :TRIG:DEM:LEV 10

Set →
 → Query

:TRIGger[:SEQuence]:DEMod:MODE

Description Sets the triggering mode for the AF Trigger in AM/FM demodulation.

Syntax :TRIGger[:SEQuence]:DEMod:MODE {NORMal|SINGle|CONTInuous}

Query Syntax :TRIGger[:SEQuence]:DEMod:MODE?

Parameter/ Return parameter	NORMal	Normal trigger mode
	SINGle	Single trigger
	CONTInuous	Continuous trigger

Example :TRIG:DEM:MODE CONT

Set →
 → Query

:TRIGger[:SEQuence]:DEMod:SLOPe

Description Sets the trigger slope.

Syntax :TRIGger[:SEQuence]:DEMod:SLOPe {POSitive|NEGative}

Query Syntax :TRIGger[:SEQuence]:DEMod:SLOPe?

Parameter/ Return parameter	POSitive	Positive slope
	NEGative	Negative slope

Example :TRIG:DEM:SLOP POS

:TRIGger[:SEQuence]:DEMod:SOURce (Set) →

Description	Sets the triggering source for AM/FM demodulation	
Syntax	:TRIGger[:SEQuence]:DEMod:SOURce {IMMEDIATE VIDEo}	
Parameter	IMMEDIATE	Free run trigger
	VIDEo	Trigger on the video signal level
Example	:TRIG:DEM:SOUR IMM	

:TRIGger[:SEQuence]:EXTernal:SLOPe (Set) →
→ (Query)

Description	Sets the external trigger slope	
Syntax	:TRIGger[:SEQuence]:EXTernal:SLOPe {POSitive NEGative}	
Query Syntax	:TRIGger[:SEQuence]:EXTernal:SLOPe?	
Parameter/ Return parameter	POSitive	Positive slope
	NEGative	Negative slope
Example	:TRIG:EXT:SLOP POS	

:TRIGger[:SEQuence]:MODE (Set) →
→ (Query)

Description	Sets the triggering mode.	
Syntax	:TRIGger[:SEQuence]:MODE {NORMAl SINGle CONTInuous}	
Query Syntax	:TRIGger[:SEQuence]:MODE?	
Parameter/ Return parameter	NORMAl	Normal trigger mode
	SINGle	Single trigger
	CONTInuous	Continuous trigger
Example	:TRIG: MODE CONT	

:TRIGger[:SEQuence]:PMETer:SOURce



Description	Sets the triggering source to immediate or external	
Syntax	:TRIGger[:SEQuence]:PMETer:SOURce {IMMEDIATE EXTERNAL}	
Query Syntax	:TRIGger[:SEQuence]:PMETer:SOURce?	
Parameter/ Return parameter	IMMEDIATE	Free run trigger
	EXTERNAL	External trigger
Example	:TRIG:PMET:SOUR IMM	

:TRIGger[:SEQuence]:SOURce



Description	Sets the triggering source to immediate, external or video.	
Syntax	:TRIGger[:SEQuence]:SOURce {IMMEDIATE EXTERNAL VIDEO}	
Query Syntax	:TRIGger[:SEQuence]:SOURce?	
Parameter/ Return parameter	IMMEDIATE	Free run trigger
	EXTERNAL	External trigger
	VIDEO	Video trigger
Example	:TRIG:SOUR IMM	

:TRIGger[:SEQuence]:VIDeo:FREQuency



Description	Sets the video trigger frequency.	
Syntax	:TRIGger[:SEQuence]:VIDeo:FREQuency <freq>	
Query Syntax	:TRIGger[:SEQuence]:VIDeo:FREQuency?	
Parameter	<freq>	<NRf>
Return parameter	<NR3>	Hz
Example	:TRIG:VID:FREQ? >2.5e+6	

:TRIGger[:SEQuence]:VIDeo:LEVel (Set) →
→ (Query)

Description	Sets the video trigger level.	
Syntax	:TRIGger[:SEQuence]:VIDeo:LEVel <ampl>	
Query Syntax	:TRIGger[:SEQuence]:VIDeo:LEVel?	
Parameter	<ampl>	<NRf> power or voltage.
Return parameter	<NR3>	
Example	:TRIG:VID:LEV 10	

:TRIGger[:SEQuence]:VIDeo:SLOPe (Set) →
→ (Query)

Description	Sets the video trigger slope	
Syntax	:TRIGger[:SEQuence]:VIDeo:SLOPe {POSitive NEGative}	
Query Syntax	:TRIGger[:SEQuence]:VIDeo:SLOPe?	
Parameter/ Return parameter	POSitive	Positive slope
	NEGative	Negative slope
Example	:TRIG:VID:SLOP POS	

UNIT Commands

:UNIT:PMETer:POWer.....	193
:UNIT:POWer.....	193

:UNIT:PMETer:POWer
 →
 →

Description Sets the amplitude unit used for the Power Meter mode.

Syntax :UNIT:PMETer:POWer {DBM|MW}

Query Syntax :UNIT:PMETer:POWer?

Parameter/	DBM	Decibels
Return parameter	MW	Milliwatts

Example :UNIT:PMET:POW DBM

:UNIT:POWer
 →
 →

Description Sets the amplitude unit used for the Spectrum mode.

Syntax :UNIT:POWer {DBM|DBMV|DBUV|W|V}

Query Syntax :UNIT:POWer?

Parameter/	DBM	Decibels
Return parameter	DBMV	decibels relative to one millivolt
	DBUV	decibels relative to one microvolt
	W	Watt
	V	Volt

Example :UNIT:POW DBM