

# Digital Storage Oscilloscope

GDS-1000B Series

---

**USER MANUAL**



ISO-9001 CERTIFIED MANUFACTURER

**GW INSTEK**

This manual contains proprietary information, which is protected by copyright. All rights are reserved. No part of this manual may be photocopied, reproduced or translated to another language without prior written consent of Good Will company.

The information in this manual was correct at the time of printing. However, Good Will continues to improve products and reserves the rights to change specification, equipment, and maintenance procedures at any time without notice.

# Table of Contents

<b>SAFETY INSTRUCTIONS</b> .....	5
<b>GETTING STARTED</b> .....	10
GDS-1000B Series Overview .....	11
Appearance .....	14
Set Up .....	26
Built-in Help .....	36
<b>MEASUREMENT</b> .....	37
Basic Measurement .....	38
Automatic Measurement.....	45
Cursor Measurement .....	59
Math Operation .....	67
<b>CONFIGURATION</b> .....	77
Acquisition .....	79
Display .....	84
Horizontal View .....	90
Vertical View (Channel).....	97
Bus Key Configuration .....	105
Trigger .....	128
System Settings and Miscellaneous Settings .....	160
<b>APPS</b> .....	165
Applications.....	166
<b>SAVE/RECALL</b> .....	176
File Format/Utility .....	177
Create/Edit Labels .....	182
Save.....	185
Recall.....	193

Reference Waveforms .....	199
<b>FILE UTILITIES</b> .....	<b>201</b>
<b>HARDCOPY KEY</b> .....	<b>208</b>
<b>REMOTE CONTROL CONFIG</b> .....	<b>212</b>
Interface Configuration .....	213
<b>MAINTENANCE</b> .....	<b>224</b>
<b>FAQ</b> .....	<b>230</b>
<b>APPENDIX</b> .....	<b>232</b>
Updating the Firmware .....	233
Installing Optional Apps .....	235
GDS-1000B Specifications .....	238
Probe Specifications .....	242
GDS-1000B Dimensions .....	244
Certificate of Compliance .....	245
<b>INDEX</b> .....	<b>246</b>

# S SAFETY INSTRUCTIONS

This chapter contains important safety instructions that you must follow during operation and storage. Read the following before any operation to insure your safety and to keep the instrument in the best possible condition.

## Safety Symbols

These safety symbols may appear in this manual or on the GDS-1000B.

---



WARNING

Warning: Identifies conditions or practices that could result in injury or loss of life.



CAUTION

Caution: Identifies conditions or practices that could result in damage to the GDS-1000B or to other properties.



DANGER High Voltage



Attention Refer to the Manual



Protective Conductor Terminal



Earth (ground) Terminal



Do not dispose electronic equipment as unsorted municipal waste. Please use a separate collection facility or contact the supplier from which this instrument was purchased.

## Safety Guidelines

---

### General Guideline



### CAUTION

- Make sure the BNC input voltage does not exceed 300Vrms.
- Never connect a hazardous live voltage to the ground side of the BNC connectors. It might lead to fire and electric shock.
- Do not place any heavy object on the GDS-1000B.
- Avoid severe impact or rough handling that leads to damaging the GDS-1000B.
- Do not discharge static electricity to the GDS-1000B.
- Use only mating connectors, not bare wires, for the terminals.
- Do not block the cooling fan opening.
- Do not perform measurement at a power source or building installation site (Note below).
- Do not disassemble the GDS-1000B unless you are qualified.

(Measurement categories) EN 61010-1:2010 specifies the measurement categories and their requirements as follows. The GDS-1000B falls under category I.

- Measurement category IV is for measurement performed at the source of low-voltage installation.
- Measurement category III is for measurement performed in the building installation.
- Measurement category II is for measurement performed on the circuits directly connected to the low voltage installation.
- Measurement category I is for measurements performed on circuits not directly connected to Mains.

- 
- |   |  |
|---|--|
| Power Supply  | <ul style="list-style-type: none"><li>• AC Input voltage: 100 - 240V AC, 50 - 60Hz, auto selection. Power consumption: 30 Watts.</li></ul>                       |
|  WARNING | <ul style="list-style-type: none"><li>• Connect the protective grounding conductor of the AC power cord to an earth ground, to avoid electrical shock.</li></ul> |
- 
- |                        |   |
|------------------------|---|
| Cleaning the GDS-1000B | <ul style="list-style-type: none"><li>• Disconnect the power cord before cleaning.</li><li>• Use a soft cloth dampened in a solution of mild detergent and water. Do not spray any liquid.</li><li>• Do not use chemicals containing harsh materials such as benzene, toluene, xylene, and acetone.</li></ul> |
|------------------------|---|
- 
- |                       |   |
|-----------------------|---|
| Operation Environment | <ul style="list-style-type: none"><li>• Location: Indoor, no direct sunlight, dust free, almost non-conductive pollution (Note below)</li><li>• Relative Humidity: <math>\leq 80\%</math>, <math>40^{\circ}\text{C}</math> or below; <math>\leq 45\%</math>, <math>41^{\circ}\text{C} \sim 50^{\circ}\text{C}</math></li><li>• Altitude: <math>&lt; 2000\text{m}</math></li><li>• Temperature: <math>0^{\circ}\text{C}</math> to <math>50^{\circ}\text{C}</math></li></ul> <p>(Pollution Degree) EN 61010-1:2010 specifies the pollution degrees and their requirements as follows. The GDS-1000B falls under degree 2.</p> <p>Pollution refers to “addition of foreign matter, solid, liquid, or gaseous (ionized gases), that may produce a reduction of dielectric strength or surface resistivity”.</p> <ul style="list-style-type: none"><li>• Pollution degree 1: No pollution or only dry, non-conductive pollution occurs. The pollution has no influence.</li><li>• Pollution degree 2: Normally only non-conductive pollution occurs. Occasionally, however, a temporary conductivity caused by condensation must be expected.</li><li>• Pollution degree 3: Conductive pollution occurs, or dry, non-conductive pollution occurs which becomes conductive due to condensation which is expected. In such conditions, equipment is normally protected against exposure to direct sunlight, precipitation, and full wind pressure, but neither temperature nor humidity is controlled.</li></ul> |
|-----------------------|---|
-

**Storage environment**

- Location: Indoor
  - Temperature: -10°C to 60°C
  - Humidity: Up to 93% RH (non-condensing) /  $\leq 40^{\circ}\text{C}$ , up to 65% RH (non-condensing) /  $41^{\circ}\text{C} \sim 60^{\circ}\text{C}$
- 

**Disposal**

Do not dispose this instrument as unsorted municipal waste. Please use a separate collection facility or contact the supplier from which this instrument was purchased. Please make sure discarded electrical waste is properly recycled to reduce environmental impact.



## Power cord for the United Kingdom

When using the oscilloscope in the United Kingdom, make sure the power cord meets the following safety instructions.

NOTE: This lead/appliance must only be wired by competent persons



**WARNING: THIS APPLIANCE MUST BE EARTHED**

IMPORTANT: The wires in this lead are coloured in accordance with the following code:

Green/ Yellow:	Earth
Blue:	Neutral
Brown:	Live (Phase)



As the colours of the wires in main leads may not correspond with the coloured marking identified in your plug/appliance, proceed as follows:

The wire which is coloured Green & Yellow must be connected to the Earth terminal marked with either the letter E, the earth symbol  or coloured Green/Green & Yellow.

The wire which is coloured Blue must be connected to the terminal which is marked with the letter N or coloured Blue or Black.

The wire which is coloured Brown must be connected to the terminal marked with the letter L or P or coloured Brown or Red.

If in doubt, consult the instructions provided with the equipment or contact the supplier.

This cable/appliance should be protected by a suitably rated and approved HBC mains fuse: refer to the rating information on the equipment and/or user instructions for details. As a guide, a cable of 0.75mm<sup>2</sup> should be protected by a 3A or 5A fuse. Larger conductors would normally require 13A types, depending on the connection method used.

Any exposed wiring from a cable, plug or connection that is engaged in a live socket is extremely hazardous. If a cable or plug is deemed hazardous, turn off the mains power and remove the cable, any fuses and fuse assemblies. All hazardous wiring must be immediately destroyed and replaced in accordance to the above standard.

# GETTING STARTED

This chapter describes the GDS-1000B in a nutshell, including its main features and front / rear panel introduction. After going through the overview, follow the Set Up section to properly set up the oscilloscope for first time use. The Set Up section also includes a starter on how to use this manual effectively.



<b>GDS-1000B Series Overview</b> .....	<b>11</b>
Series lineup.....	11
Main Features.....	12
Accessories.....	13
<b>Appearance</b> .....	<b>14</b>
GDS-1054B/1074B/1104B Front Panel.....	14
GDS-1072B/1102B/1202B Front Panel.....	15
Rear Panel.....	22
Display.....	24
<b>Set Up</b> .....	<b>26</b>
Tilt Stand.....	26
Power Up.....	27
First Time Use.....	28
How to Use This Manual.....	31
<b>Built-in Help</b> .....	<b>36</b>

## GDS-1000B Series Overview

### Series lineup

The GDS-1000B series consists of 6 models, divided into 2-channel and 4-channel versions.

Model name	Frequency bandwidth	Input channels	Max. Real-time Sampling Rate
GDS-1072B	70MHz	2	1GSa/s
GDS-1102B	100MHz	2	1GSa/s
GDS-1202B	200MHz	2	1GSa/s
GDS-1054B	50MHz	4	1GSa/s
GDS-1074B	70MHz	4	1GSa/s
GDS-1104B	100MHz	4	1GSa/s

## Main Features

---

- Features
- 7 inch, 800 x 480, WVGA TFT display.
  - Available from 50MHz to 200MHz.
  - Real-time sampling rate of 1GSa/s max.
  - Deep memory: 10M points record length.
  - Waveform capture rate of 50,000 waveforms per second.
  - Vertical sensitivity: 1mV/div~10V/div.
  - On-screen Help.
  - 32 MB internal flash disk.
  - Go-NoGo app.
  - Serial Bus Decode: Serial bus decoding of UART, I<sup>2</sup>C, SPI, CAN and LIN buses.
  - Remote Disk app (4 channel models only).
  - Optional apps available for download.
- 

- Interface
- USB host port: front panel, for storage devices.
  - USB device port: rear panel, for remote control or printing (to PictBridge compatible printers).
  - Probe compensation output with selectable output frequency (1kHz ~ 200kHz).
  - Ethernet port (GDS-1054B, GDS-1074B, GDS-1104B only).
  - Calibration output.

## Accessories

### Standard Accessories

Part number	Description
	User manual CD
N/A region dependent	Power cord
GTP-070B-4, for GDS-1054B, GDS-1072B, GDS-1074B	Passive probe; 70 MHz
GTP-100B-4, for GDS-1102B, GDS-1104B	Passive probe; 100 MHz
GTP-200B-4, for GDS-1202B	Passive probe; 200 MHz

### Optional Accessories

Part number	Description
GTC-001	Instrument cart, 470(W)x430(D)mm (U.S. type input socket)
GTC-002	Instrument cart, 330(W)x430(D)mm (U.S. type input socket)
GTL-110	Test lead, BNC to BNC heads
GTL-242	USB cable, USB2.0A-B type cable 4P

### Standard Apps

Name	Description
Go-NoGo	Go-NoGo testing app.
Remote Disk	Allows the scope to mount a network share drive (4 channel models only).

### Drivers

USB driver	LabVIEW driver
------------	----------------

# Appearance

## GDS-1054B/1074B/1104B Front Panel

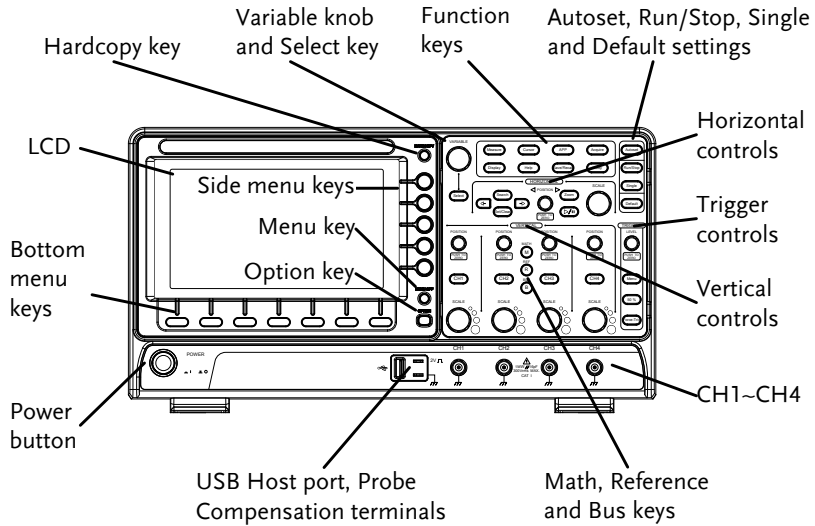

**GDS-1072B/1102B/1202B Front Panel**

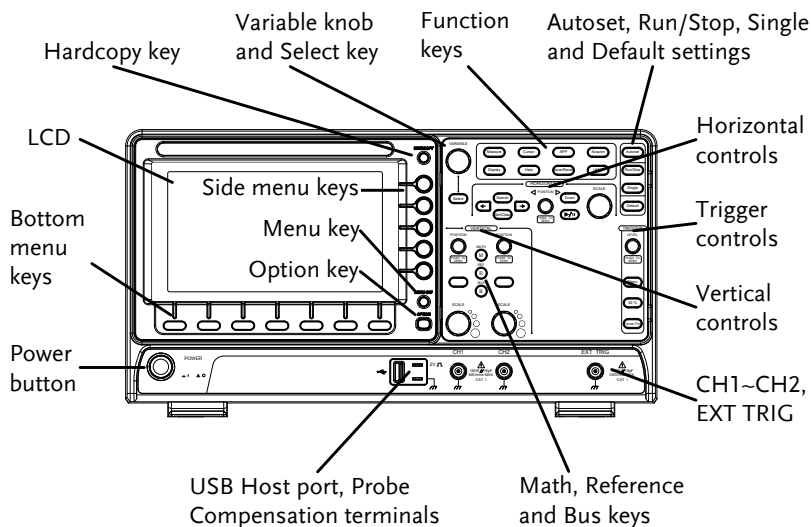

**LCD Display**      7" WVGA TFT color LCD. 800 x 480 resolution, wide angle view display.

**Menu Off Key**      **MENU OFF**      Use the Menu Off key to hide the onscreen menu system.

○

**Option Key**      **OPTION**      Not available.

◻

**Menu Keys**

The side menu and bottom menu keys are used to make selections from the soft-menus on the LCD user interface.

To choose menu items, use the 7 Bottom menu keys located on the bottom of the display panel.

To select a variable or option from a menu, use the side menu keys on the side of the panel. See page 31 for details.

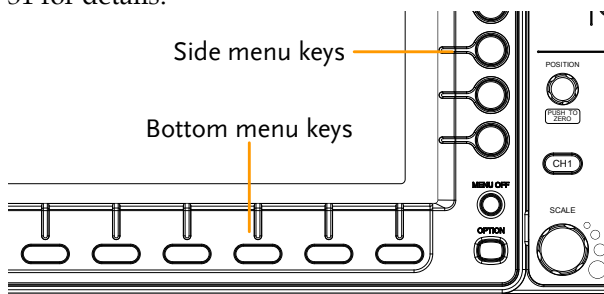

**Hardcopy Key**

**HARDCOPY**



The Hardcopy key is a quick-save or quick-print key, depending on its configuration. For more information see pages 210(save) or 209(print).

**Variable Knob and Select Key**

**VARIABLE**

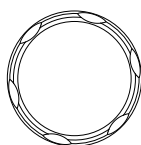





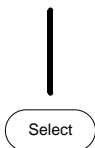



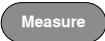
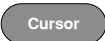





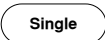

The Variable knob is used to increase/decrease values or to move between parameters.

The Select key is used to make selections.

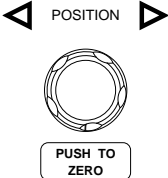
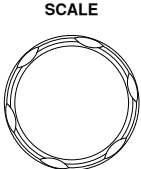



Function Keys		The Function keys are used to enter and configure different functions on the GDS-1000B.
Measure		Configures and runs automatic measurements.
Cursor		Configures and runs cursor measurements.
APP		Configures and runs GW Instek applications.
Acquire		Configures the acquisition mode.
Display		Configures the display settings.
Help		Shows the Help menu.
Save/Recall		Used to save and recall waveforms, images, panel settings.
Utility		Configures the Hardcopy key, display time, language, probe compensation and calibration. It also accesses the file utilities menu.
Autoset		Press the Autoset key to automatically set the trigger, horizontal scale and vertical scale.
Run/Stop Key		Press to Freeze (Stop) or continue (Run) signal acquisition (page 41).
Single		Sets the acquisition mode to single triggering mode.

Default Setup		Resets the oscilloscope to the default settings.
Horizontal Controls	The horizontal controls are used to change the position of the cursor, set the time base settings and zoom into the waveforms.	
Horizontal Position		The Position knob is used to position the waveforms horizontally on the display screen. Pressing the knob will reset the position to zero.
SCALE		The Scale knob is used to change the horizontal scale (TIME/DIV).
Zoom		Press Zoom in combination with the horizontal Position knob.
Play/Pause		The Play/Pause key allows you to play through a waveform in zoom mode.
Search		Not available.
Search Arrows		Not available.
Set/Clear		Not available.

Trigger Controls    The trigger controls are used to control the trigger level.

Level Knob



Used to set the trigger level. Pressing the knob will reset the level to zero.

Trigger Menu Key



Used to bring up the trigger menu.

50% Key



Sets the trigger level to the half way point (50%).

Force - Trig



Press to force an immediate trigger of the waveform.

Vertical POSITION



Sets the vertical position of the waveform. Push the knob to reset the vertical position to zero.

Channel Menu Key



Press the CH1~4 key to set and configure the channel.

(Vertical)SCALE Knob

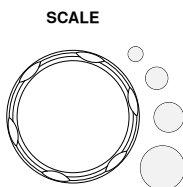

Sets the vertical scale of the channel (TIME/DIV).

External Trigger Input

**EXT TRIG**

Accepts external trigger signals (page 105). Only on 2 channel models.



Input impedance:  $1M\Omega$   
 Voltage input:  $\pm 2.5V$  (peak), EXT trigger capacitance:  $16pF$  ( $14pF$  for GDS-1202B).

Math Key

MATH



Use the Math key to set and configure math functions.

Reference Key

REF



Press the Reference key to set or remove reference waveforms.

BUS Key

BUS



The Bus key is used for parallel and serial bus (UART, I<sup>2</sup>C, SPI, CAN, LIN) configuration.

Channel Inputs

**CH1**

Accepts input signals.

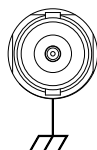

Input impedance:  $1M\Omega$ .  
 Capacitance:  $16pF$  ( $14pF$  for GDS-1202B)  
 CAT I

USB Host Port

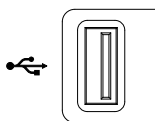

Type A, 1.1/2.0 compatible. Used for data transfer.

Ground Terminal

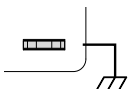

Accepts the DUT ground lead for common ground.

Probe  
Compensation  
Outputs

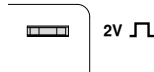

The probe compensation output is used for probe compensation. It also has an adjustable output frequency.

By default this port outputs a 2Vpp, square wave signal at 1kHz for probe compensation.

Please see page 162 for details.

Power Switch



POWER

Used to turn the power on/off.



■ | ○: ON

■ ○: OFF

### Rear Panel

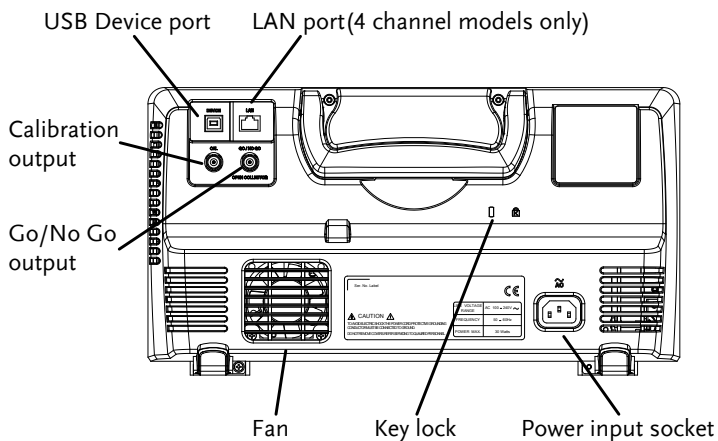

Calibration Output



Outputs the signal for vertical scale accuracy calibration (page 225).

USB Device Port

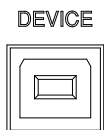

The USB Device port is used for remote control.

LAN (Ethernet) Port

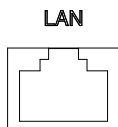

The LAN port is used for remote control over a network or when combined with the Remote Disk app, it allows the oscilloscope to mount a network share disk.

Note: the LAN port is only available for the 4 channel models (GDS-1054B, GDS-1074B, GDS-1104B).

Power Input  
Socket

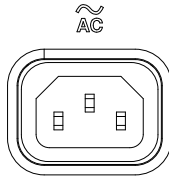

Power cord socket accepts AC mains, 100 ~ 240V, 50/60Hz.

For power up sequence, see page 27.

Security Slot



Kensington security slot compatible.

Go-NoGo Output

GO / NO GO



OPEN COLLECTOR

Outputs Go-NoGo test results (page 168) as a 500us pulse signal.

## Display

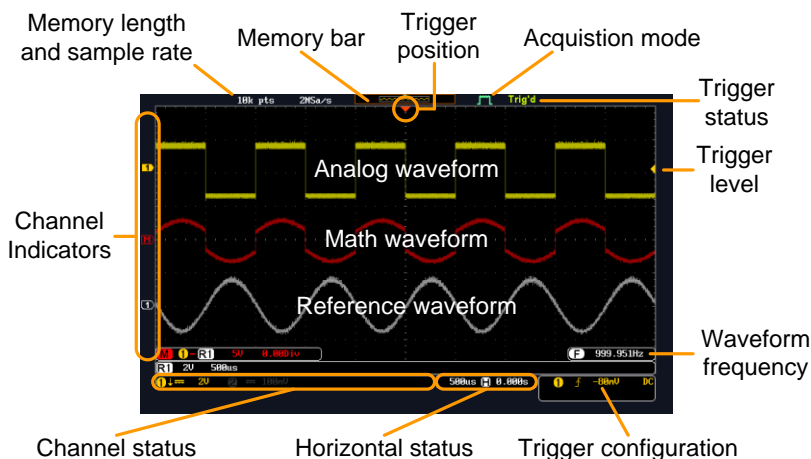

Analog Waveforms	Shows the analog input signal waveforms. Channel 1: Yellow      Channel 2: Blue Channel 3: Pink      Channel 4: Green
Bus Waveforms	Shows the bus waveforms for serial buses. The values are displayed in hex or binary.
Channel Indicators	The channel indicators show the zero volt level of the signal waveform for each activated channel. Any active channel is shown with a solid color. <b>A</b> Analog channel indicator <b>B</b> Bus indicator(B) <b>1</b> Reference waveform indicator <b>M</b> Math indicator
Trigger Position	Shows the position of the trigger.
Horizontal Status	Shows the horizontal scale and position.
Trigger Level	 Shows the trigger level on the graticule.



Memory Bar

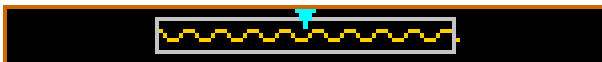



The ratio and the position of the displayed waveform compared to the internal memory (page 90). The color of the active channel is also shown as the color of the waveform within the memory bar.

Trigger Status

- Trig'd Triggered.
- PrTrig Pre-trigger.
- Trig? Not triggered, display not updated.
- Stop Trigger stopped. Also appears in Run/Stop (page 41).
- Roll Roll mode.
- Auto Auto trigger mode.



For trigger details, see page 105.

Acquisition Mode

-  Normal mode
-  Peak detect mode
-  Average mode

For acquisition details, see page 79.

Signal Frequency

-  Shows the trigger source frequency.
-  Indicates the frequency is less than 2Hz (lower frequency limit).

Trigger Configuration

-  Trigger source, slope, voltage, coupling.

Horizontal Status

-  Horizontal scale, horizontal position.

For trigger details, see page 105.

Channel Status

-  Channel 1, DC coupling, 2V/Div.

For channel details, see page 97.

# Set Up

## Tilt Stand

Tilt

To tilt, pull the legs forward, as shown below.

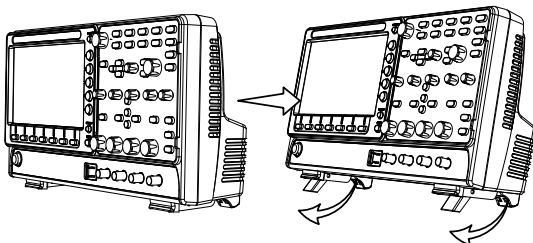

Stand

To stand the scope upright, push the legs back under the casing as shown below.

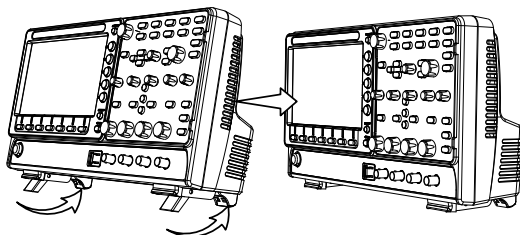

## Power Up

---

**Requirements**      The GDS-1000B accepts line voltages of 100 ~ 240V at 50 or 60Hz.

**Step**

1. Connect the power cord to the rear panel socket.

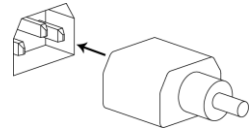

2. Press the POWER key. The display becomes active in ~ 30 seconds.

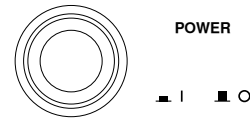

■ I: ON

■ ○: OFF



Note

The GDS-1000B recovers the state right before the power is turned OFF. The default settings can be recovered by pressing the Default key on the front panel. For details, see page 194.

## First Time Use

**Background** This section describes how to connect a signal, adjust the scale, and compensate the probe. Before operating the GDS-1000B in a new environment, run these steps to make sure the instrument performs at its full potential.

**1. Power On** Follow the procedures on the previous page.

**2. Firmware** Update to the latest firmware. Page 233

**3. Install Apps** Install optional apps. Page 233

Optional apps are available as a free download from the GW Instek website.

**4. Reset System** Reset the system by recalling the factory settings. Press the *Default* key on the front panel. For details, see page 194.



**5. Connect Probe** Connect the probe to the Channel 1 input and to the probe compensation output. This output provides a 2Vp-p, 1kHz square wave for signal compensation by default.

Set the probe attenuation to x10 if the probe has adjustable attenuation.

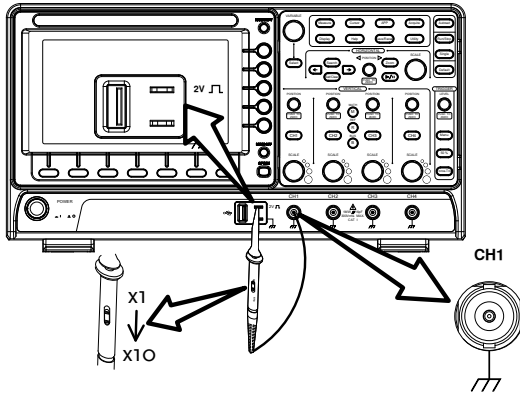

**6. Capture Signal (Autoset)**

Press the *Autoset* key. A square waveform appears on the center of the screen. For Autoset details, see page 39.

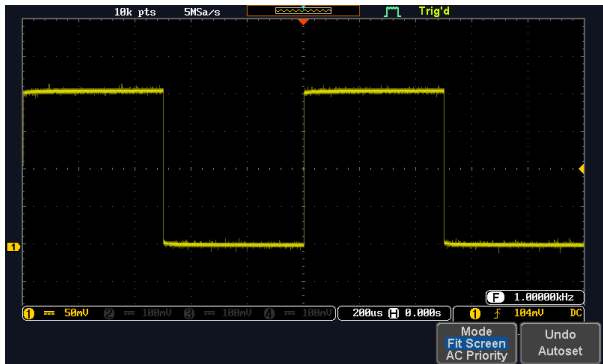

**7. Select Vector Waveform**

Press the *Display* key, and set the display to *Vector* on the bottom menu.

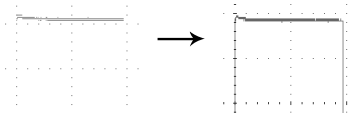

8. Compensate Probe Turn the adjustment point on the probe to make the square waveform edge flat.

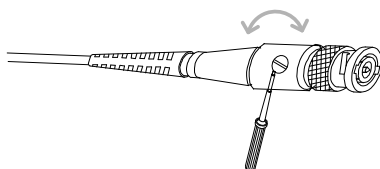
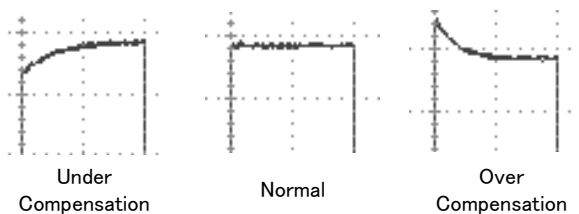

- 
9. Start Operation Continue with the other operations.

Measurement: page 37	Configuration: page 77
Save/Recall: page 176	File Utilities: page 201
Apps: page 165	Hardcopy key: page 208
Remote Control: page 212	Maintenance: page 224

## How to Use This Manual

---

**Background** This section describes the conventions used in this manual to operate the GDS-1000B.

Throughout the manual any reference to pressing a menu key refers to the keys directly below or beside any menu icons or parameters.

When the user manual says to “toggle” a value or parameter, press the corresponding menu item. Pressing the item will toggle the value or parameter.

Active parameters are highlighted for each menu item. For example in the example below, Coupling is currently set to DC.

If a menu item can be toggled from one value or parameter to another, the available options will be visible, with the current option highlighted. In the example below the slope can be toggled from a rising slope to a falling slope or either slope.

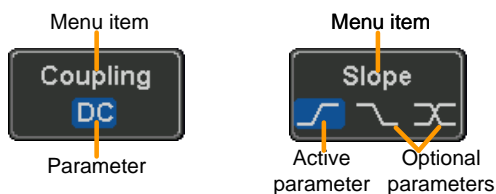

**Selecting a Menu Item, Parameter or Variable** When the user manual says to “select” a value from one of the side menu parameters, first press the corresponding menu key and use the Variable knob to either scroll through a parameter list or to increase or decrease a variable.

Example 1

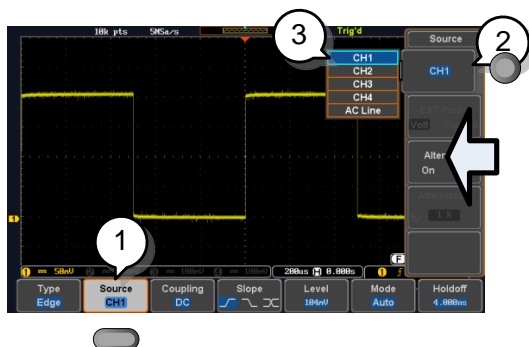

1. Press a bottom menu key to access the side menu.

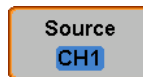

2. Press a side menu key to either set a parameter or to access a sub menu.



3. If accessing a sub menu or setting a variable parameter, use the Variable knob to scroll through menu items or variables. Use the Select key to confirm and exit.

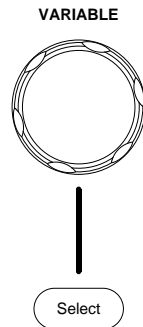

4. Press the same bottom menu key again to reduce the side menu.

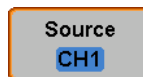

Example 2

For some variables, a circular arrow icon indicates that the variable for that menu key can be edited with the Variable knob.



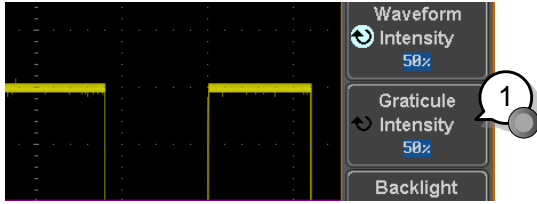

1. Press the desired menu key to select it. The circular arrow will become highlighted.

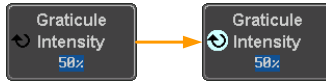

2. Use the Variable knob to edit the value.

toggling a Menu Parameter

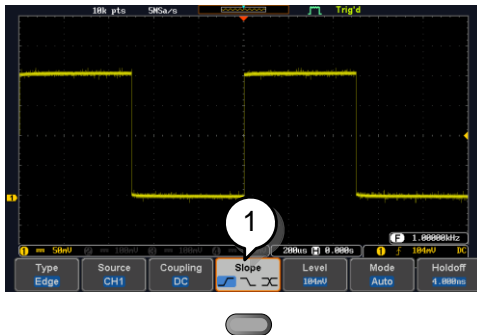

1. Press the bottom menu key to toggle the parameter.



Reduce Side Menu

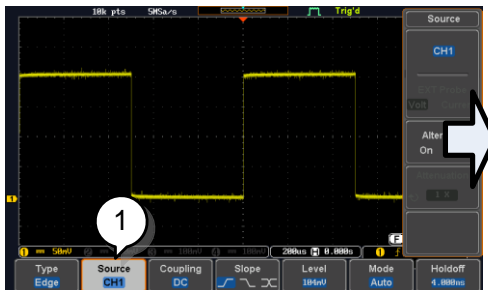

1. To reduce the side menu, press the corresponding bottom menu that brought up the side menu originally.

For example: Press the *Source* soft-key to reduce the Source menu.

Reduce Lower Menu

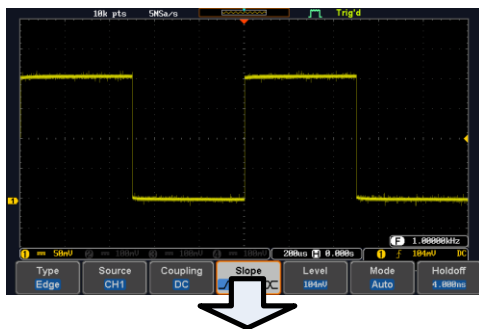

1. Press the relevant function key again to reduce the bottom menu. For example: press the Trigger Menu key to reduce the trigger menu.

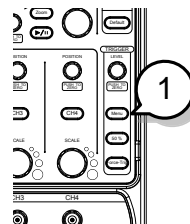

Remove All Menus

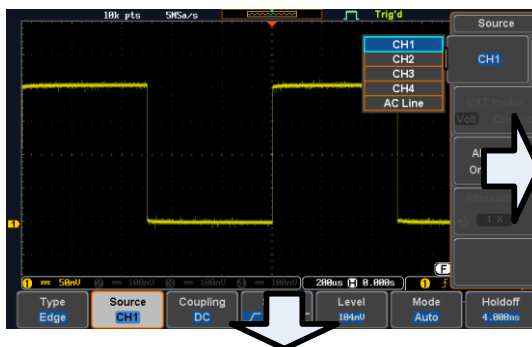

1. Press the *Menu Off* key to reduce the side menu, press again to reduce the bottom menu.

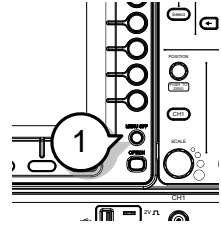

---

### Remove On-Screen Messages

1. The *Menu Off* key can also be used to remove any on screen messages.

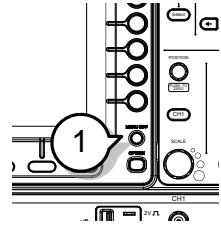

## Built-in Help

The Help key accesses a context sensitive help menu. The help menu contains information on how to use the front panel keys.

Panel Operation 1. Press the *Help* key. The display changes to Help mode.



2. Use the *Variable* knob to scroll up and down through the Help contents. Press *Select* to view the help on the selected item.

Example: Help on the Display key

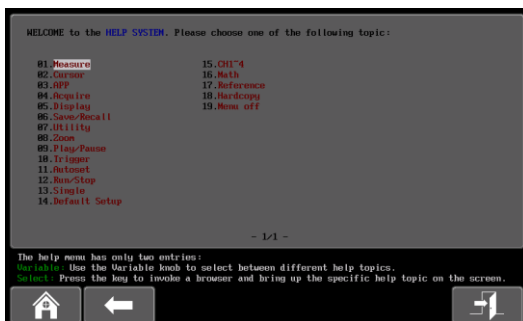

Home Key Press the *Home* key to return to the main help screen.



Go Back Press the *Back* key to go to the previous menu page.



Exit Press the *Help* key again or press the *Exit* key to exit the Help mode.

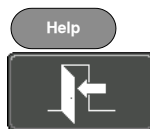

# M EASUREMENT

---

<b>Basic Measurement .....</b>	<b>38</b>
Channel Activation.....	38
Autoset .....	39
Run/Stop .....	41
Horizontal Position/Scale .....	42
Vertical Position/Scale .....	44
<b>Automatic Measurement.....</b>	<b>45</b>
Measurement Items.....	45
Add Measurement.....	49
Remove Measurement.....	51
Gated mode.....	52
Display All mode.....	53
High Low Function.....	54
Statistics.....	55
Reference Levels.....	58
<b>Cursor Measurement .....</b>	<b>59</b>
Use Horizontal Cursors.....	59
Use Vertical Cursors .....	63
<b>Math Operation .....</b>	<b>67</b>
Basic Math Overview & Operators.....	67
Addition/Subtraction/Multiplication/Division.....	67
FFT Overview & Window Functions .....	69
FFT Operation.....	70
Advanced Math Overview .....	72
Advanced Math Operation .....	73

## Basic Measurement

This section describes the basic operations required in capturing and viewing the input signal. For more detailed operations, see the following chapters.

- Cursor Measurement → from page 59
- Configuration → from page 77

Before operating the oscilloscope, please see the Getting Started chapter, page 10.

## Channel Activation

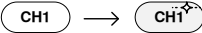
**Activate Channel** To activate an input channel, press a *channel* key. 

When activated, the channel key will light up. The corresponding channel menu will also appear.

Each channel is associated with the color shown beside each channel's vertical SCALE dial: CH1: yellow, CH2: blue, CH3: pink and CH4: green.

When a channel is activated, it is shown above the bottom menu system.

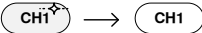

**De-activate Channel** To de-activate a channel, press the corresponding *channel* key again. If the channel menu is not open, press the *channel* key twice (the first press shows the Channel menu). 

Default Setup      To activate the default state, press *Default*. 

## Autoset

---

**Background**      The Autoset function automatically configures the panel settings to position the input signal(s) to the best viewing condition. The GDS-1000B automatically configures the following parameters:

- Horizontal scale
- Vertical scale
- Trigger source channel

There are two operating modes for the Autoset function: Fit Screen Mode and AC Priority Mode.

Fit Screen Mode will fit the waveform to the best scale, including any DC components (offset). AC priority mode will scale the waveform to the screen by removing any DC component.

**Panel Operation**      1. Connect the input signal to the GDS-1000B and press the *Autoset* key. 

2. The waveform appears in the center of the display.

Before



After



3. To undo Autoset, press *Undo Autoset* from the bottom menu.

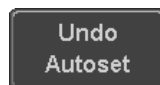

Change modes

1. Choose between *Fit Screen Mode* and *AC Priority Mode* from the bottom menu.



2. Press the *Autoset* key again to use Autoset in the new mode.

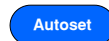

Fit Screen Mode

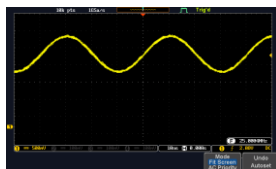

AC Priority



Limitation

Autoset does not work in the following situations:

- Input signal frequency is less than 20Hz
- Input signal amplitude is less than 10mV



Note

The Autoset key does NOT automatically activate the channels to which input signals are connected.



## Run/Stop

**Background** By default, the waveform on the display is constantly updated (Run mode). Freezing the waveform by stopping signal acquisition (Stop mode) allows flexible observation and analysis. To enter Stop mode, two methods are available: pressing the Run/Stop key or using the Single Trigger mode.

**Stop mode icon**  When in Stop mode, the Stop icon appears at the top of the display.

**Triggered icon**  top of the display.

**Freeze Waveform using the Run/Stop Key** Press the *Run/Stop* key once. The Run/Stop key turns red. The waveform and signal acquisition freezes.

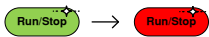
**Stop:** 

To unfreeze, press the *Run/Stop* key again. The Run/Stop key turns green again.

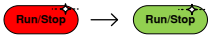
**Run:** 

**Freeze Waveform by Single Trigger Mode** Press the *Single* key to go into the Single Trigger mode. The Single key turns bright white.

In the Single Trigger mode, the scope will be put into the pre-trigger mode until the scope encounters the next trigger point. After the scope has triggered, it will remain in Stop mode, until the *Single* key is pressed again or the *Run/Stop* key is pressed.

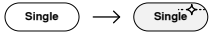
**Single:** 

**Waveform Operation** The waveform can be moved or scaled in both Run and Stop mode, but in different manners. For details, see page 90 (Horizontal position/scale) and page 97 (Vertical position/scale).

## Horizontal Position/Scale

For more detailed configuration, see page 90.

**Set Horizontal Position**

The horizontal position knob moves the waveform left and right.

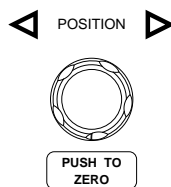

**Set Horizontal Position to 0**

Pressing the horizontal position knob will reset the horizontal position to 0.

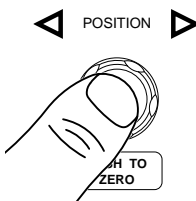

Alternatively, pressing the *Acquire* key and then pressing *Reset H Position to 0s* from the bottom menu will also reset the horizontal position.



As the waveform moves, the display bar on the top of the display indicates the portion of the waveform currently shown on the display and the position of the horizontal marker on the waveform.



**Position Indicator**

The horizontal position is shown at the bottom of the display grid to the right of the H icon.



**Select Horizontal Scale**

To select the timebase, turn the horizontal *SCALE* knob; left (slow) or right (fast).

**SCALE**

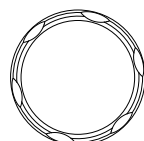

Range 5ns/div ~ 100s/div, 1-2-5 increments

The scale is displayed to the left of the H icon at the bottom of the screen.



Display bar The display bar indicates how much of the waveform is displayed on the screen at any given time. Changes to timebase will be reflected on the display bar. The display bar is not shown in rolling acquisition mode.

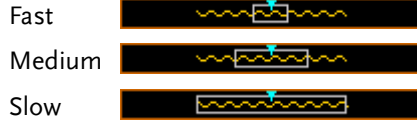

Stop mode In the Stop mode, the waveform size changes according to the scale.

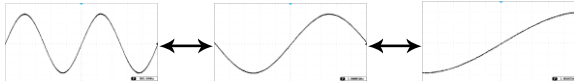

The Sample rate changes according to the timebase and record length. See page 83.

## Vertical Position/Scale

For more detailed configuration, see page 97.

**Set Vertical Position**

To move the waveform up or down, turn the *vertical position knob* for each channel.



PUSH TO ZERO

Push the *vertical position knob* to reset the position to 0.

As the waveform moves, the vertical position of the cursor appears on the display.

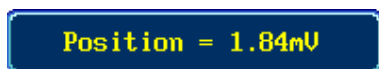
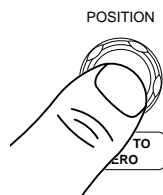

**Run/Stop mode**

The waveform can be moved vertically in both Run and Stop mode.

**Select Vertical Scale**

To change the vertical scale, turn the vertical *SCALE knob*; left (down) or right (up).

SCALE

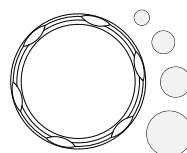

**Range**

1mV/div ~ 10V/div  
1-2-5 increments

The vertical scale indicator for each channel on the bottom of the display changes accordingly.











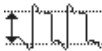

# Automatic Measurement

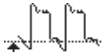

The automatic measurement function measures and updates major items for Voltage/Current, Time, and Delay type measurements.











## Measurement Items









	V/I Measurements	Time Meas.	Delay Meas.
Overview	Pk-Pk		Frequency
	Max		Period
	Min		RiseTime
	Amplitude		FallTime
	High		+Width
	Low		-Width
	Mean		Dutycycle
	Cycle Mean		+Pulses
	RMS		-Pulses
	Cycle RMS		+Edges
	Area		-Edges
	Cycle Area		
	ROVShoot		
	FOVShoot		
	RPREShoot		
FPREShoot			

Voltage/Current Measurement	Pk-Pk (peak to peak)		Difference between positive and negative peak. (=max - min)
	Max		Positive peak.
	Min		Negative peak.

Amplitude		Difference between the global high value and the global low value, measured over the entire waveform or gated region. (=high – low)
High		Global high voltage. See page 54 for details.
Low		Global low voltage. See page 54 for details.
Mean		The arithmetic mean value is calculated for all data samples as specified by the Gating option.
Cycle Mean		The arithmetic mean value is calculated for all data samples within the first cycle found in the gated region.
RMS		The root mean square of all data samples specified by the Gating option.
Cycle RMS		The root mean square value is calculated for all data samples within the first cycle found in the gated region.
Area		Measures the positive area of the waveform and subtracts it from the negative area. The ground level determines the division between positive and negative areas.
Cycle Area		The Summation based on all data samples within the first cycle found in the gated region.
ROVShoot		Rise overshoot

FOVShoot		Fall overshoot
RPREShoot		Rise preshoot
FPREShoot		Fall preshoot

Time Measurement	Frequency		Frequency of the waveform.
	Period		Waveform cycle time. (=1/Freq)
	RiseTime		The time required for the leading edge of the first pulse to rise from the low reference value to the high reference value.
	FallTime		The time required for the falling edge of the first pulse to fall from the high reference value to the low reference value.
	+Width		Positive pulse width.
	-Width		Negative pulse width.
	Duty Cycle		Ratio of signal pulse compared with whole cycle. =100x (Pulse Width/Cycle)
	+Pulses		Measures the number of positive pulses.
	-Pulses		Measures the number of negative pulses.
	+Edges		Measures the number of positive edges.

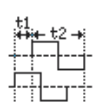
	-Edges		Measures the number of negative edges.
Delay Measurement	FRR		Time between: Source 1 first rising edge and Source 2 first rising edge.
	FRF		Time between: Source 1 first rising edge and Source 2 first falling edge.
	FFR		Time between: Source 1 first falling edge and Source 2 first rising edge.
	FFF		Time between: Source 1 first falling edge and Source 2 first falling edge.
	LRR		Time between: Source 1 first rising edge and Source 2 last rising edge.
	LFR		Time between: Source 1 first rising edge and Source 2 last falling edge.
	LRF		Time between: Source 1 first falling edge and Source 2 last rising edge.
	LFF		Time between: Source 1 first falling edge and Source 2 last falling edge.
	Phase		The phase difference of two signals, calculated in degrees. $\frac{t1}{t2} \times 360^\circ$





Note

The in-built help system can be used to see detailed automatic measurement definitions.

## Add Measurement

The *Add Measurement* function allows you to add up to eight automatic measurement items on the bottom of the screen from any channel source.

Add Measurement Item

1. Press the *Measure* key.



2. Press *Add Measurement* from the bottom menu.

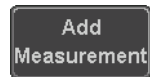

3. Choose either a *V/I*, *Time* or *Delay* measurement from the side menu and choose the type of measurement you wish to add.

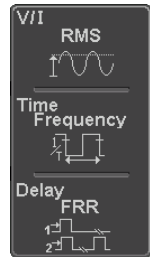

V/I (Voltage/ Current)	Pk-Pk, Max, Min, Amplitude, High, Low, Mean, Cycle Mean, RMS, Cycle RMS, Area, Cycle Area, ROVShoot, FOVShoot, RPRESshoot, FPRESshoot
Time	Frequency, Period, RiseTime, FallTime, +Width, -Width, Duty Cycle, +Pulses, -Pulses, +Edges, -Edges
Delay	FRR, FRF, FFR, FFF, LRR, LRF, LFR, LFF, Phase

- All of the chosen automatic measurements will be displayed in a window on the bottom of the screen. The channel number and channel color indicate the measurement source.

For the analog inputs: yellow = CH1, blue = CH2, pink = CH3, green = CH4.



**Choose a Source** The channel source for measurement items can be set either before or when selecting a measurement item.

- To set the source, press either the *Source1* or *Source2* key from the side menu and choose the source. Source 2 is only applicable for delay measurements.



Range CH1~ CH4, Math

## Remove Measurement

Individual measurements can be removed at any time using the Remove Measurement function.

---

Remove  
Measurement  
Item

1. Press the *Measure* key.
2. Press *Remove Measurement* from the bottom menu.
3. Press *Select Measurement* and select the item that you want to remove from the measurement list.

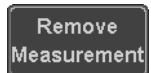
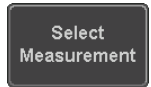
A light gray, rounded rectangular button with the word "Measure" in a dark gray font.A dark gray, rounded rectangular button with the words "Remove Measurement" in a light gray font.A dark gray, rounded rectangular button with the words "Select Measurement" in a light gray font.

---

Remove All Items Press *Remove All* to remove all the measurement items.

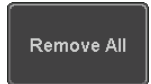
A dark gray, rounded rectangular button with the words "Remove All" in a light gray font.

## Gated mode

Some automatic measurements can be limited to a “gated” area between cursors. Gating is useful for measuring a magnified waveform or when using a fast time base. The gated mode has three possible configurations: Off (Full Record), Screen and Between Cursors.

Set Gating Mode 1. Press the *Measure* key.



2. Press *Gating* from the bottom menu.



3. Choose one of the gating modes from the side menu: *Off (full record)*, *Screen*, *Between Cursors*.

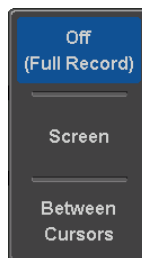

Cursors On Screen

If *Between Cursors* is selected, the cursor positions can be edited by using the cursor menu.

Page 59

## Display All mode

Display All mode shows and updates all items from Voltage and Time type measurements.

View  
Measurement  
Results

1. Press the *Measure* key.
2. Press *Display All* from the bottom menu.
3. Press *Source* from the side menu and choose a measurement source.  
  
Range CH1~CH4, Math

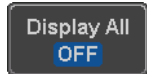

4. The results of Voltage and Time type measurements appear on the display.

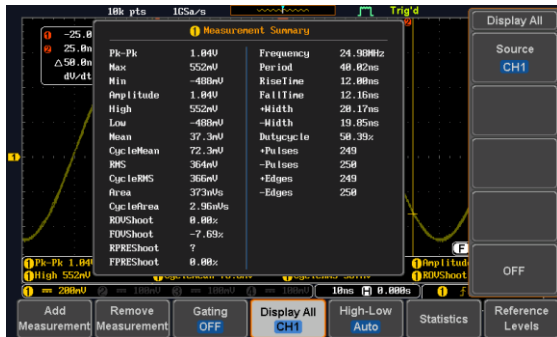

Remove  
Measurements

To remove the measurement results, press *OFF*.



Delay  
Measurements

Delay type measurements are not available in this mode as only one channel is used as the source. Use the individual measurement mode (page 49) instead.

## High Low Function

**Background** The High-Low function is used to select the method for determining the value of the High-Low measurement values.

- Auto** Automatically chooses the best high-low setting for each waveform when measuring.
- Histogram** Uses histograms to determine the high-low values. This mode ignores any preshoot and overshoot values. This mode is particularly useful for pulse-type waveforms

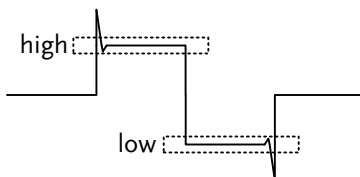

- Min-max** Sets the high-low values as the minimum or maximum measured values.

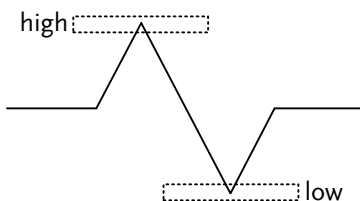

**Set High-Low**

1. Press the *Measure* key.
2. Press *High-Low* from the bottom menu.



3. Select the type of High-Low settings from the side menu.

High-Low Settings: Histogram, Min-Max, Auto

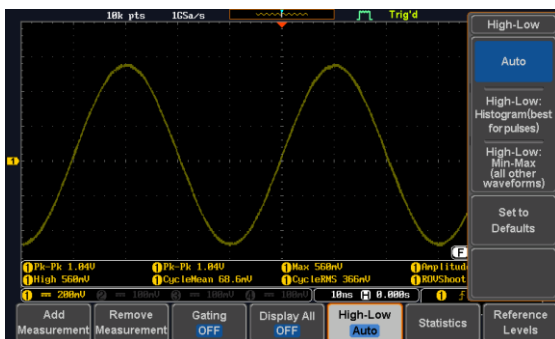

Restore Default High-Low Settings

To return to the default High-Low settings, press *Set to Defaults*.



## Statistics



Background

The Statistics function can be used to view a number of statistics for the selected automatic measurements. The following information is displayed with the Statistics function:

Value	Currently measured value
Mean	The mean value is calculated from a number of automatic measurement results. The number of samples used to determine the mean can be user-defined.
Min	The minimum value observed from a series of measured results for the selected automatic measurement items.

Max	The maximum value observed from a series of measured results for the selected automatic measurement items.
Standard Deviation	The variance of the currently measured value from the mean. The standard deviation equals the squared root of the variance value. Measuring the standard deviation can, for example, determine the severity of jitter in a signal. The number of samples used to determine the standard deviation can be user-defined.

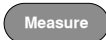
Panel Operation

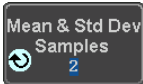
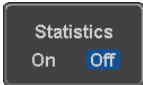
1. Press the *Measure* key. 
2. Select at least one automatic measurement. Page 49
3. Press *Statistics* from the bottom menu. 
4. Set the number of samples to be used in the mean and standard deviation calculations.   
 Samples: 2~1000
5. Press *Statistics* and turn Statistics on. 
6. The statistics for each automatic measurement will appear at the bottom of the display in a table.



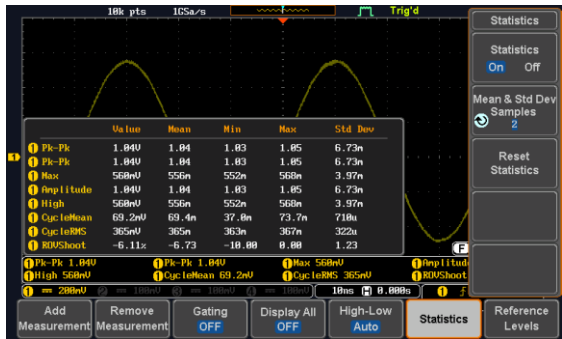



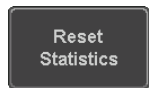

Reset Statistics

To reset the standard deviation calculations, press *Reset Statistics*.

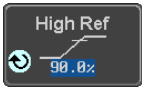

## Reference Levels

Background	<p>The reference level settings determine the measurement threshold levels for some measurements like the Rise Time measurement.</p>
	<p>High Ref: Sets the high reference level.</p>
	<p>Mid Ref: Sets the middle reference for the first and second waveforms.</p>
	<p>Low Ref: Sets the low reference level.</p>

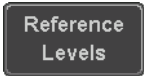
Panel Operation	<ol style="list-style-type: none"> <li>1. Press the <i>Measure</i> key. </li> <li>2. Press <i>Reference Levels</i> from the bottom menu. </li> <li>3. Set the reference levels from the side menu.</li> </ol> <p>Ensure the reference levels do not cross over.</p> <table border="0" style="margin-left: 40px;"> <tr> <td>High Ref</td> <td>0.0% ~ 100%</td> </tr> <tr> <td>Mid Ref</td> <td>0.0% ~ 100%</td> </tr> <tr> <td></td> <td>0.0% ~ 100%</td> </tr> <tr> <td>Low Ref</td> <td>0.0% ~ 100%</td> </tr> </table>	High Ref	0.0% ~ 100%	Mid Ref	0.0% ~ 100%		0.0% ~ 100%	Low Ref	0.0% ~ 100%
High Ref	0.0% ~ 100%								
Mid Ref	0.0% ~ 100%								
	0.0% ~ 100%								
Low Ref	0.0% ~ 100%								

Default Settings	<ol style="list-style-type: none"> <li>4. Press <i>Set to Defaults</i> to set the reference levels back to the default settings. </li> </ol>
------------------	---

# Cursor Measurement

Horizontal or vertical cursors are used to show the position and values of waveform measurements and math operation results. These results cover voltage, time, frequency and other math operations. When the cursors (horizontal, vertical or both) are activated, they will be shown on the main display unless turned off.

## Use Horizontal Cursors

Panel Operation 1. Press the *Cursor* key once.

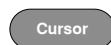

2. Press *H Cursor* from the bottom menu if it is not already selected.

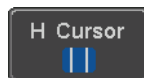

3. When the H Cursor is selected, repeatedly pressing the *H Cursor* key or the *Select* key will toggle which cursors are selected.



OR



Range	Description
∷	Left cursor (1) movable, right cursor position fixed
∷	Right cursor (2) movable, left cursor position fixed
	Left and right cursor (1+2) movable together

4. The cursor position information appears on the top left hand side of the screen

①	-3.74ms	1.40U
②	7.84ms	1.40U
△	11.5ms	△0.00U
	dV/dt	0.00U/s

- Cursor ① Hor. position, Voltage/Current  
 Cursor ② Hor. position, Voltage/Current  
 △ Delta (difference between cursors)  
 dV/dt or dI/dt

5. Use the *Variable* knob to move the movable cursor(s) left or right.



Select Units

6. To change the units of the horizontal position, press *H Unit*.

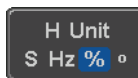

Units S, Hz, %(ratio), °(phase)

Phase or Ratio Reference

7. To set the 0% and 100% ratio or the 0° and 360° phase references for the current cursor positions, press *Set Cursor Positions As 100%*.



Example

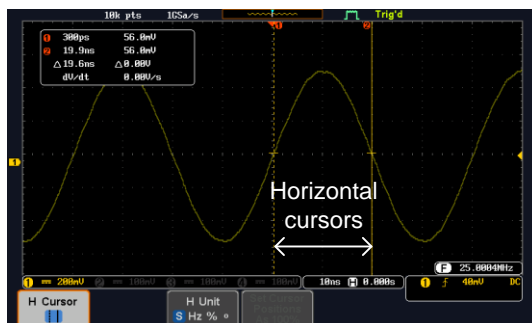

**FFT**

FFT cursors can use different units. For FFT details, see page 69.

□	1.0175GHz	21.2dB
○	2.2788GHz	-51.4dB
△	1.2525GHz	△72.6dB
	d/dt	-58.0ndB/Hz

- Cursor **1** Hor. position, dB/Voltage
- Cursor **2** Hor. position, dB/Voltage
- △ Delta (difference between cursors)  
dV/dt or d/dt

**Example**

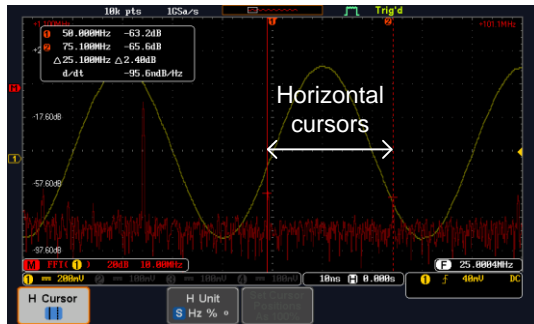

**XY Mode**

XY mode cursors measure a number of X by Y measurements.

	<b>1</b> (X)	<b>2</b> (Y)	△
Versus	t: -625us	625us	1.25ns
Rectangular	x: 16.0V y: 1.76V	17.6V -1.44V	1.60V -3.20V
Polar	r: 16.0V θ: 6.27°	17.6V -4.67°	3.57V -63.4°
Product	x×y: 28.10V	-25.30V	-5.120V
Ratio	y÷x: 110nV/V	-81.8nV/V	-2.00V/V

- Cursor **1** Time, rectangular, polar coordinates, product, ratio.
- Cursor **2** Time, rectangular, polar coordinates, product, ratio.
- △ Delta (difference between cursors)

Example

Horizontal  
cursors

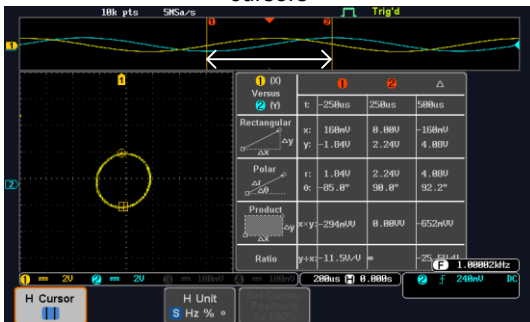

## Use Vertical Cursors

Panel Operation/  
Range

1. Press the *Cursor* key twice.



2. Press *V Cursor* from the bottom menu if it is not already selected.



3. When the *V Cursor* is selected, repeatedly pressing the *V Cursor* key or the *Select* key will toggle which vertical cursor is selected.



OR



Range



Upper cursor movable, lower cursor position fixed



Lower cursor movable, upper cursor position fixed



Upper and lower cursor movable together

4. The cursor position information appears on the top left hand side of the screen.

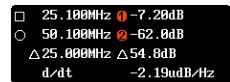

Time: cursor 1, cursor 2



Voltage/Current: cursor1, cursor2



Delta (difference between cursors)

dV/dt or dI/dt

5. Use the *Variable* knob to move the cursor(s) up or down.

**VARIABLE**

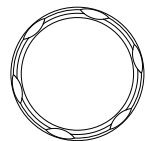

Select Units

6. To change the units of the vertical position, press *V Unit*.

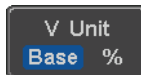

Units            Base (source wave units), % (ratio)

Base or Ratio Reference

7. To set the 0% and 100% ratio references for the current vertical cursor position, press *Set Cursor Positions As 100%*.



Example

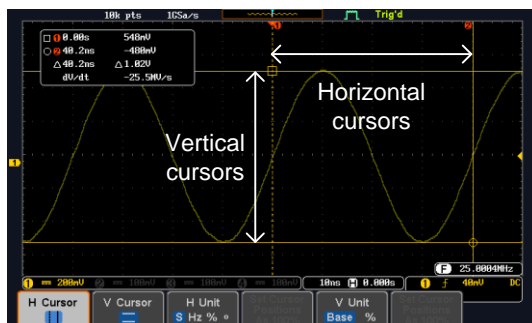

FFT

FFT has different content. For FFT details, see page 69.

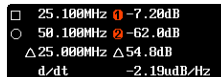

- , ○            Frequency/Time: cursor1, cursor2
- ①, ②            dB/V: cursor1, cursor2
- △                Delta (difference between cursors)
- d/dt



Example

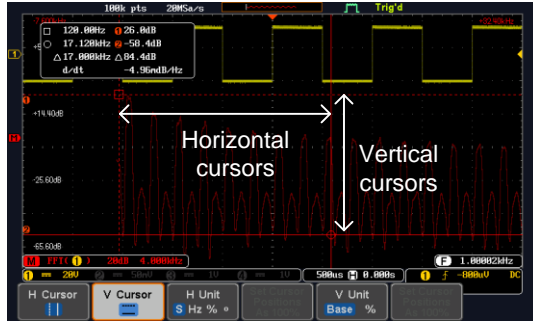

XY Mode

XY mode cursors measure a number of X by Y measurements.

	1 (X)	2 (Y)	Δ	
Versus				
	t:	-625us	625us	1.25ns
Rectangular	x:	18.4U	-14.4U	-32.8U
	y:	-1.44U	-1.68U	-240nU
Polar	r:	18.4U	14.4U	32.8U
	θ:	-4.47°	-173°	-179°
Product	x×y:	-26.40U	24.10U	7.870U
Ratio	y÷x:	-78.2nU/U	116nU/U	7.31nU/U

- Cursor **1** Rectangular, polar co-ordinates, product, ratio.
- Cursor **2** Rectangular, polar co-ordinates, product, ratio.
- Δ Delta (difference between cursors)

Example

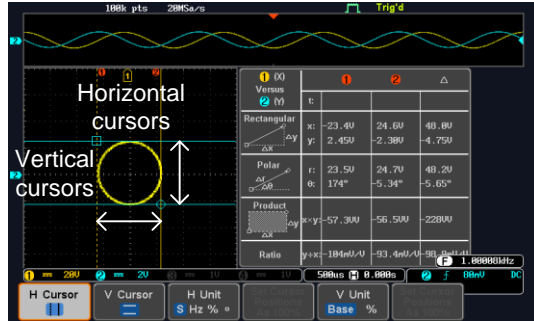

# Math Operation

## Basic Math Overview & Operators

Background	The Math function performs basic math functions (addition, subtraction, multiplication, division) on the input signals or the reference waveforms. The resultant waveform will be shown on the screen in real-time.
Addition (+)	Adds the amplitude of two signals. Source CH1~4, Ref1~4
Subtraction (-)	Extracts the amplitude difference between two signals. Source CH1~4, Ref1~4
Multiplication (×)	Multiplies the amplitude of two signals. Source CH1~4, Ref1~4
Division (÷)	Divides the amplitude of two signals. Source CH1~4, Ref1~4

## Addition/Subtraction/Multiplication/Division

Panel Operation 1. Press the *Math* key.

MATH



2. Press the *Math* key on the lower bezel.

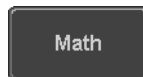

3. Select *Source 1* from the side menu



Range CH1~4, Ref1~4

4. Press *Operator* to choose the math operation.

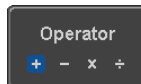

Range      +, -, x, ÷

5. Select *Source 2* from the side menu.



Range      CH1~4, Ref1~4

6. The math measurement result appears on the display. The vertical scale of the math waveform appears at the bottom of the screen.



From left: Math function, source1, operator, source2, Unit/div

Example

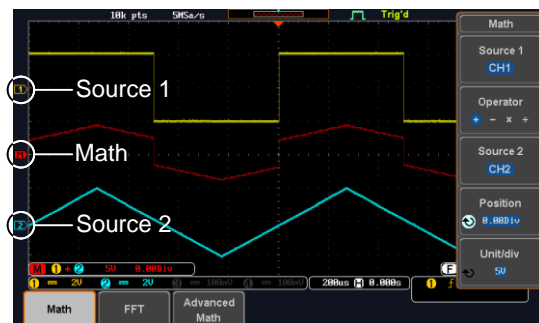

**Position and Unit** To move the math waveform vertically, press the *Position* key from the side menu and use the *Variable* knob to set the position.



Range      -12.00 Div ~ +12.00 Div

To change the unit/div settings, press *Unit/div*, then use the *Variable* knob to change the unit/div.

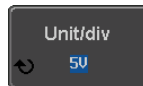

The units that are displayed depend on which operator has been selected, and whether the probe for the selected channel has been set to voltage or current.

Operator:	Unit/div:
Multiplication	VV, AA or W
Division	V/V, A/A
Addition/Subtraction	V or A

Turn Off Math

To turn off the Math result from the display, press the *Math* key again.



## FFT Overview & Window Functions

Background



The FFT Math function performs a Fast Fourier Transform on one of the input signals or the reference waveforms. The resultant spectrum will be shown on the screen in real-time. Four types of FFT windows are available: Hanning, Hamming, Rectangular, and Blackman, as described below.

Hanning FFT Window

Frequency resolution	Good
Amplitude resolution	Not good
Suitable for...	Frequency measurement on periodic waveforms

Hamming FFT Window	Frequency resolution	Good
	Amplitude resolution	Not good
	Suitable for...	Frequency measurement on periodic waveforms
Rectangular FFT Window	Frequency resolution	Very good
	Amplitude resolution	Bad
	Suitable for...	Single-shot phenomenon (this mode is the same as having no window at all)
Blackman FFT Window	Frequency resolution	Bad
	Amplitude resolution	Very good
	Suitable for...	Amplitude measurement on periodic waveforms

### FFT Operation

- Panel Operation
- Press the *Math* key.
 
  - Press *FFT* from the bottom menu.
 
  - Select the *Source* from the side menu.
 

Range CH1~4, Ref~4
  - Press the *Vertical Units* key from the side menu to select the vertical units used.
 

Range Linear RMS, dBV RMS

5. Press the *Window* key from the side menu and select the window type.

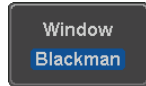

Range           Hanning, Hamming, Rectangular, and Blackman.

6. The FFT result appears. For FFT, the horizontal scale changes from time to frequency, and the vertical scale from voltage/current to dB/RMS.

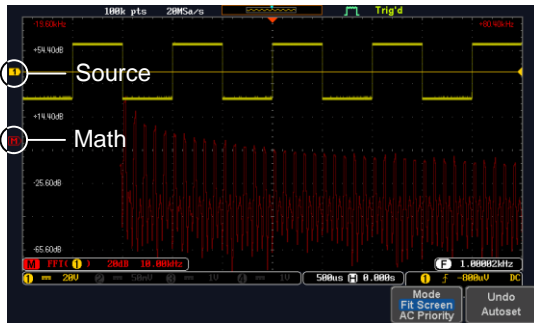

Position and Scale

To move the FFT waveform vertically, press *Vertical* until the *Div* parameter is highlighted and then use the Variable knob.

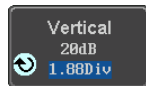

Range           -12.00 Div ~ +12.00 Div

To select the vertical scale of the FFT waveform, press *Vertical* until the *dB* or *voltage* parameters are highlighted and then use the Variable knob.

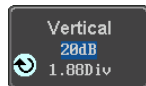

Range           2mV~1kV RMS, 1~20 dB

Horizontal Position and Scale

To move the FFT waveform horizontally, press *Horizontal* until the *Frequency* parameter is highlighted and then use the Variable knob.



Range           0Hz ~ 2.5MHz

To select the horizontal scale of the FFT waveform, press *Horizontal* repeatedly until the *Hz/div* parameter is highlighted and then use the Variable knob.

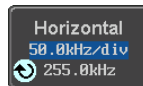

Range            10kHz/Div ~ 250kHz/Div

## Advanced Math Overview

**Background**            The advanced math function allows complex math expressions to be created based on the input sources, reference waveforms or even the automatic measurements available from the *Measure* menu (see page 45).

An overview of each of the major parameters that can be used in the advanced math function are shown below:

**Expression**            Displays the function expression as it is created.

**Source**                    Selects the source signal.

Source                    CH1~4, Ref1~4

**Function**                Adds a mathematical function to the expression.

Function                Intg, Diff, log, Ln, Exp, Sqrt, Abs, Rad, Deg, Sin, Cos, Tan, Asin, Acos, Atan

**Variable**                Adds a user-specified variable to the expression. The variable is a floating point number consisting of a mantissa and an exponent.

Variable                VAR1, VAR2

**Operator**                Adds an operator or parenthesis to the function expression.



	Operator	+, -, *, /, (, ), !(, <, >, <=, >=, ==, !=,   , &&
Figure	Adds a value to the expression.	
	Figure	Integers, floating point, or floating point with exponent values.
Measurement	Adds automatic measurements to the expression. Not all automatic measurements are supported.	
	Measurement	Pk-Pk, Max, Min, Amp, High, Low, Mean, CycleMean, RMS, CycleRMS, Area, CycleArea, ROVShoot, FOVShoot, Freq, Period, Rise, Fall, PosWidth, NegWidth, Dutycycle, FRR, FRF, FFR, FFF, LRR, LRF, LFR, LFF, Phase

## Advanced Math Operation

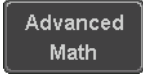
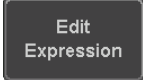
- Panel Operation
1. Press the *Math* key.
 
  2. Press *Advanced Math* from the bottom menu.
 
  3. Press *Edit Expression*.
 
  4. The Edit f(x) screen appears. CH1 + CH2 is shown in the expression box as an example at startup.

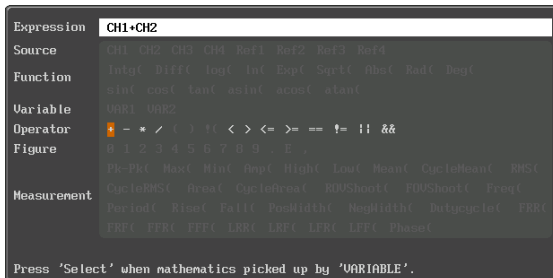

5. Press *Clear* to clear the expression entry area.

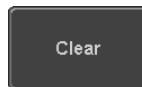

6. Use the *Variable* knob and *Select* key to create an expression.

Use the *Variable* knob to highlight a source, function, variable, operator, figure or measurement in orange.

Press the *Select* key to make the selection.

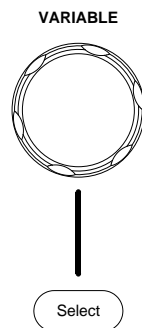

If a particular parameter is grayed out, it indicates that that particular parameter is not available at that time.

Back Space

7. To delete the last parameter press *Back Space*.



8. When the expression is complete, press *OK Accept*.

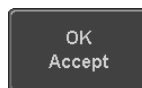

Example:  
CH1 + CH2

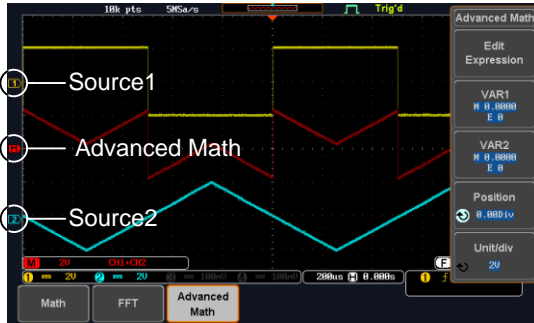

Set the VAR1 & VAR2

9. Press *VAR1* or *VAR2* to set VAR1/VAR2 if they were used in the expression created previously.

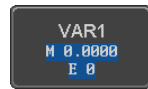

10. Press *Mantissa*.

Use the *Left* and *Right* arrow keys to select a digit and use the variable knob to set the value of the selected digit.



11. Press *Exponent*.

Use the Variable knob to set the exponent of the variable.

12. Press *Go Back* to finish editing VAR1 or VAR2.

Vertical Position and Scale

13. Press *Unit/div* and use the Variable knob to set the vertical scale of the math waveform.



14. Press *Position* and use the Variable knob to set the vertical position of the math waveform on the display.



Clear Advanced  
Math

To clear the advanced math result  
from the display, press the *Math* key  
again.

MATH



# C ONFIGURATION

---

<b>Acquisition .....</b>	<b>79</b>
Select Acquisition Mode.....	79
Show Waveform in XY Mode .....	81
Set the Record Length.....	83
<b>Display .....</b>	<b>84</b>
Display Waveform as Dots or Vectors.....	84
Set the Level of Persistence.....	85
Set the Intensity Level .....	85
Select Display Graticule .....	88
Freeze the Waveform (Run/Stop) .....	89
Turn Off Menu.....	89
<b>Horizontal View .....</b>	<b>90</b>
Move Waveform Position Horizontally .....	90
Select Horizontal Scale .....	91
Select Waveform Update Mode.....	92
Zoom Waveform Horizontally .....	93
Play/Pause .....	95
<b>Vertical View (Channel).....</b>	<b>97</b>
Move Waveform Position Vertically.....	97
Select Vertical Scale.....	98
Select Coupling Mode.....	98
Input Impedance .....	99
Invert Waveform Vertically .....	99
Limit Bandwidth.....	100
Expand by Ground/Center.....	101
Select Probe Type.....	102
Select Probe Attenuation Level .....	103
Set the Deskew .....	103
<b>Bus Key Configuration .....</b>	<b>105</b>
Bus Display.....	105
Serial Bus.....	107
Serial Bus Overview .....	107
UART Serial Bus Configuration .....	109
I <sup>2</sup> C Serial Bus Interface .....	111

SPI Serial Bus Interface .....	112
CAN Serial Bus Interface .....	114
LIN Serial Bus Interface .....	115
Bus Encoding .....	116
Threshold Configuration .....	117
Serial Bus Event Tables .....	119
Event Tables Format .....	123
Adding a Label to the Serial Bus .....	124
Using Cursors with the Serial Bus .....	126
<b>Trigger .....</b>	<b>128</b>
Trigger Type Overview .....	128
Trigger Parameter Overview .....	130
Setup Holdoff Level .....	135
Setup Trigger Mode .....	136
Using the Edge Trigger .....	136
Using Advanced Delay Trigger .....	138
Using Pulse Width Trigger .....	139
Using Video Trigger .....	141
Pulse Runt trigger .....	142
Using Rise and Fall Trigger .....	144
Using the Timeout Trigger .....	145
Using the Bus Trigger .....	147
UART BUS Trigger Settings .....	147
IPC Bus Trigger Settings .....	148
SPI Bus Trigger Settings .....	152
CAN Bus Trigger .....	154
LIN Bus Trigger .....	157
Common Bus Trigger Settings .....	159
Bus Trigger Mode .....	159
<b>System Settings and Miscellaneous Settings .....</b>	<b>160</b>
Select Menu Language .....	160
View System Information .....	161
Erase Memory .....	161
Probe Compensation Frequency .....	162
QR Code Reader Function .....	163

## Acquisition

The Acquisition process samples the analog input signals and converts them into digital format for internal processing.

### Select Acquisition Mode

---

Background	The acquisition mode determines how the samples are used to reconstruct a waveform.
------------	---

---

Sample	This is the default acquisition mode. Every sample from each acquisition is used.
--------	---

---

Peak detect	Only the minimum and maximum value pairs for each acquisition interval (bucket) are used. This mode is useful for catching abnormal glitches in the signal.
-------------	---

---

Average	Multiple acquired data is averaged. This mode is useful for drawing a noise-free waveform. To select the average number, use the Variable knob. Average number: 2, 4, 8, 16, 32, 64, 128, 256
---------	--

---

Panel Operation 1. Press the *Acquire* key.



2. To set the Acquisition mode, press *Mode* on the bottom menu.



3. Select an acquisition mode from the side menu.

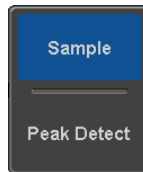

4. If *Average* was chosen, set the number of samples to be used for the average function.

Mode            Sample, Peak Detect, Average

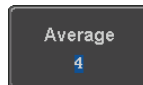

Average sample    2, 4, 8, 16, 32, 64, 128, 256

Example

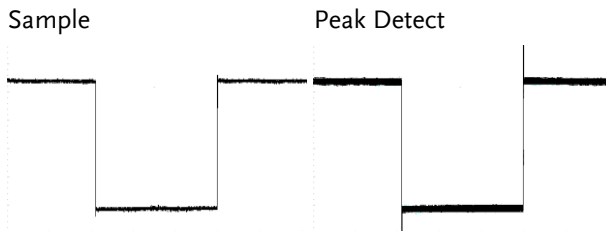

Average (256 times)

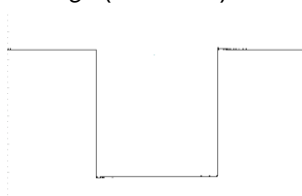



## Show Waveform in XY Mode



**Background**      The XY mode maps the input of channel 1 to the input of channel 2. In 4 channel models, the input of channel 3 can be mapped to the input of channel 4. This mode is useful for observing the phase relationship between waveforms.

Reference waveforms can also be used in XY mode. Ref1 is mapped to Ref2 and Ref3 is mapped to Ref4. Using the reference waveforms is the same as using the channel input waveforms.

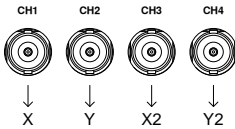
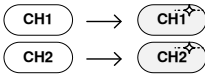
**Connection**

1. Connect the signals to Channel 1 (X-axis) and Channel 2 (Y-axis) or Channel 3 (X2-axis) and Channel 4 (Y2-axis).
 
2. Make sure a channel pair is active (CH1&CH2 or CH3&CH4). Press the Channel key if necessary. A channel is active if the channel key is lit.
 

**Panel Operation**

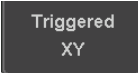
1. Press the *Acquire* menu key.
 
2. Press *XY* from the bottom menu.
 
3. Choose *Triggered XY* from the side menu.
 

XY mode is split into two windows. The top window shows the signals over the full time range. The bottom window shows XY mode.

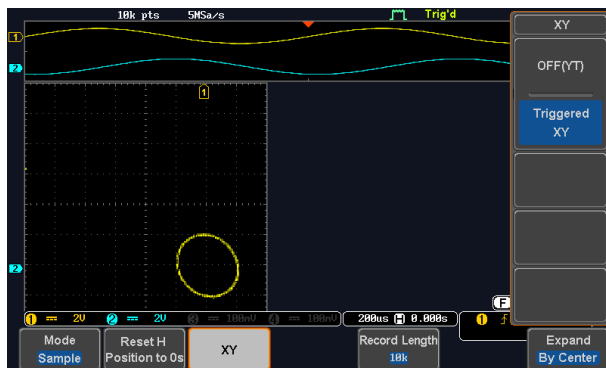

To move the X Y waveform position, use the vertical position knob: Channel 1 knob moves the X Y waveform horizontally, Channel 2 knob moves the X Y waveform vertically. Similarly, the X2 and Y2 axis can be positioned using the channel 3 and channel 4 vertical position knobs.

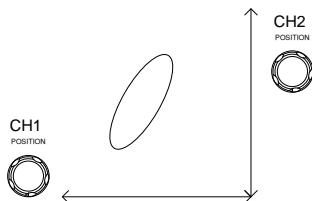

The horizontal position knob and horizontal scale knob can still be used under the XY mode.

Turn Off XY Mode To turn off XY mode, choose *OFF (YT)* mode.



Cursors and XY Mode

Cursors can be used with XY mode. See the Cursor chapter for details.

## Set the Record Length

**Background**      The number of samples that can be stored is set by the record length. Record length is important in an oscilloscope as it allows longer waveforms to be recorded.

The maximum record length for the GDS-1000B depends on the operating mode. The table below describes the record lengths that are available for each mode.

### Limitations

Record Length	Normal	Zoom	FFT	FFT in Zoom Window
1k	✓	✗	✓	✗
10k	✓	✓	✓	✓
100k	✓	✓	✓	✓
1M	✓	✓	✓	✗
10M	✓	✓	✗	✗

**Panel Operation**    1. Press the *Acquire* key.



2. Press the *Record Length* key on the bottom menu and choose the record length.

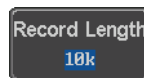

Record length    1000, 10k, 100k, 1M, 10M points



Note

The sampling rate may also be changed when the record length is changed.

## Display

The Display menu defines how the waveforms and parameters appear on the main LCD display.

### Display Waveform as Dots or Vectors

**Background** When the waveform is displayed on the screen, it can be displayed as dots or vectors.

**Panel Operation** 1. Press the *Display* menu key.

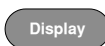

2. Press *Dot / Vector* to toggle between Dot and Vector mode.



<b>Range</b>	<b>Dot</b>	Only the sampled dots are displayed.
	<b>Vectors</b>	Both the sampled dots and the connecting line are displayed.

**Example:**

**Vectors**

**Dots**





## Set the Level of Persistence

---

**Background**      The persistence function allows the GDS-1000B to mimic the trace of a traditional analog oscilloscope. A waveform trace can be configured to “persist” for a designated amount of time.

---

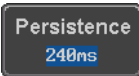
**Panel Operation**

1. Press the *Display* menu key. 
2. To set the persistence time, press the *Persistence* menu button on the bottom bezel. 
3. Use the Variable knob to select a persistence time. 

Time      16ms, 30ms, 60ms, 120ms, 240ms, 0.5s, 1s, 2s, ~4s, Infinite, Off

---

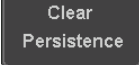
**Clear**      To clear persistence, press *Clear Persistence*. 

## Set the Intensity Level

---

**Background**      The intensity level of a signal can also be set to mimic the intensity of an analog oscilloscope by setting the digital intensity level.

---

**Panel Operation**

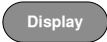
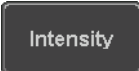
1. Press the *Display* menu key. 
2. Press *Intensity* from the bottom menu. 

---

Waveform Intensity      3. To set the waveform intensity, press *Waveform Intensity* and edit the intensity.

Range      0~100%

Example      Waveform Intensity 50%      Waveform Intensity 100%

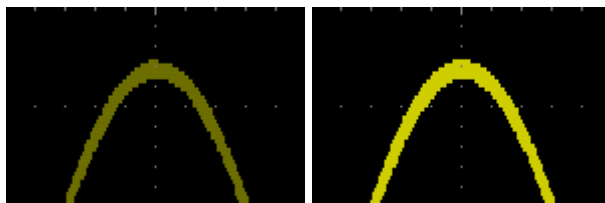

Graticule Intensity      4. To set the graticule intensity, press *Graticule Intensity* from the side menu and edit the intensity value.

Range      10~100%

Example      Graticule Intensity 100%      Graticule Intensity 10%

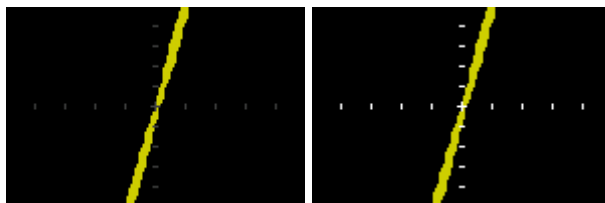

Backlight Intensity      5. To set the LCD backlight intensity, press *Backlight Intensity* from the side menu and edit the intensity value.

Range      2~100%

Backlight Auto-Dim

6. To automatically dim the backlight after a set duration, set *Backlight Auto-Dim* to On and then set the *Time* parameter to the appropriate time.

After a set amount of time with no panel activity, the screen will dim until a panel key is pressed again. This function will prolong the life of the LCD display.

Range      1~180 min

---

## Select Display Graticule

---

Panel Operation 1. Press the *Display* menu key.

A rounded rectangular button with the word "Display" in the center.

2. Press *Graticule* from the bottom menu.

A dark rectangular button with the word "Graticule" in the center.

3. From the side menu choose the graticule display type.



*Full*: Shows the full grid; X and Y axis for each division.



*Grid*: Show the full grid without the X and Y axis.



*Cross Hair*: Shows only the center X and Y frame.







*Frame*: Shows only the outer frame.



### Freeze the Waveform (Run/Stop)

For more details about Run/Stop mode, see page 41.

- Panel Operation
4. Press the *Run/Stop* key. The *Run/Stop* key turns red and waveform acquisition is paused.
  → 
  
  5. The waveform and the trigger freezes. The trigger indicator on the top right of the display shows Stop.
 
  
  6. To unfreeze the waveform, press the *Run/Stop* key again. The Run/Stop key turns green again and acquisition resumes.
  → 

### Turn Off Menu

- Panel Operation
1. Press the *Menu Off* key below the side menu keys to reduce a menu. The menu key needs to be pressed each time to reduce one menu.
   
  
 See page 31 for more information.

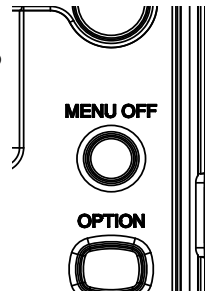

## Horizontal View

This section describes how to set the horizontal scale, position, and waveform display mode.

### Move Waveform Position Horizontally

**Panel Operation** The horizontal position knob moves the waveform left/right.

**Note:** the horizontal position is not applicable in the Roll mode.

As the waveform moves, a position indicator on the top of the display indicates the horizontal position of the waveform in memory.

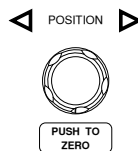

**Reset Horizontal Position** 1. To reset the horizontal position, press the Acquire key and then press *Reset H Position to 0s* from the bottom menu.

Alternatively, pushing the horizontal position knob will also reset the position to zero.

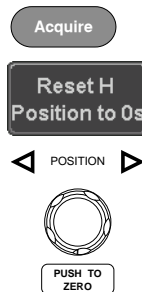

**Run Mode** In Run mode, the memory bar keeps its relative position in the memory since the entire memory is continuously captured and updated.

## Select Horizontal Scale

Select Horizontal Scale To select the timebase (time/div), turn the horizontal Scale knob; left (slow) or right (fast).



Range 5ns/div ~ 100s/div, 1-2-5 increment

The timebase indicator updates as the horizontal scale is adjusted.

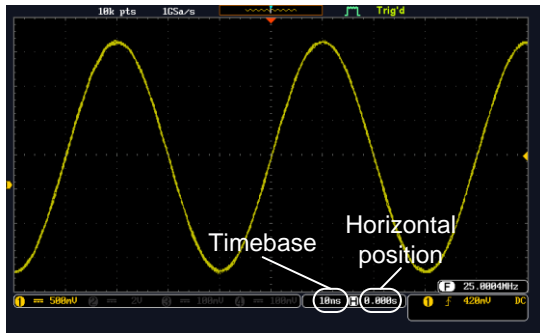

**Run Mode** In Run mode, the memory bar and waveform size keep their proportion. When the timebase becomes slower, roll mode is activated (if the trigger is set to Auto).

**Stop Mode** In Stop mode, the waveform size changes according to the scale.

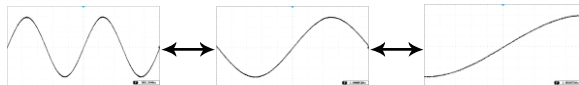

## Select Waveform Update Mode

Background	The display update mode is switched automatically or manually according to the timebase and trigger.
Normal	<p>Updates the whole displayed waveform at once. Automatically selected when the timebase (sampling rate) is fast.</p> <p>Timebase    <math>\leq 50\text{ms/div}</math></p> <p>Trigger      all modes</p>
Roll Mode	<p><b>Roll</b> Updates and moves the waveform gradually from the right side of the display to the left. Automatically selected when the timebase (sampling rate) is slow.</p> <p>Timebase    <math>\geq 100\text{ms/div}</math></p> <p>Trigger      all modes</p>



Select Roll Mode Manually 1. Press the *Trigger Menu* key.



2. Press *Mode* from the bottom menu and select *Auto (Untriggered Roll)* from the side menu.

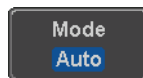

## Zoom Waveform Horizontally

**Background** When in Zoom mode, the screen is split into 2 sections. The top of the display shows the full record length, while the bottom of the screen shows the normal view.

**Panel Operation** 1. Press the *Zoom* key.



2. The Zoom mode screen appears.

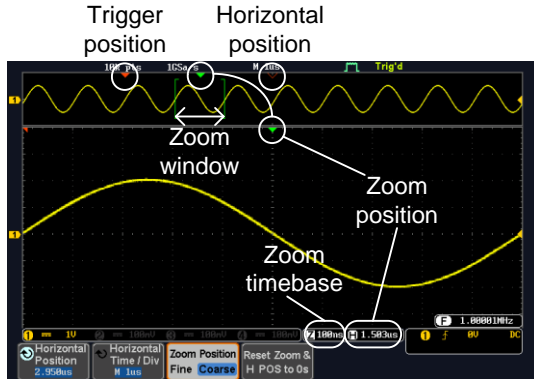

**Horizontal Navigation**

To scroll the waveform left or right, press *Horizontal Position* and use the *Variable Position* knob.



The horizontal position will be shown on the *Horizontal Position* icon.

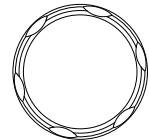

**Horizontal Scale** To change the horizontal scale, press *Horizontal Time/Div* and use the *Variable Position* knob.



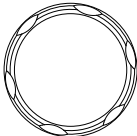

The scale will be shown on the *Horizontal Time/Div* icon.

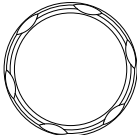

**Zoom** To increase the zoom range, use the *Horizontal Scale* knob.

The zoom time base (Z) at the bottom of the screen will change accordingly.

**Move the Zoom Window** Use the *Horizontal Position* knob to pan the zoom window horizontally.

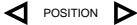

To reset the zoom position, press the *Horizontal Position* knob.



The position of the zoom window, relative to the horizontal position is shown at the bottom of the screen next to the Zoom time base.



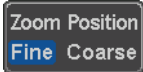

**Scroll Sensitivity** To alter the scrolling sensitivity of the zoom window, press the *Zoom Position* key to toggle the scrolling sensitivity.

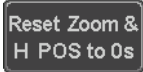

Sensitivity Fine, Coarse

**Reset the Zoom & Horizontal Position** To reset both the zoom and horizontal position, press *Reset Zoom & H POS to 0s*.



Exit To go back to the original view, press the *Zoom* key again. 

## Play/Pause

---

Background The Play/Pause key can be used to play through signals in the Zoom mode.

---

Panel Operation 1. Press the *Play/Pause* menu key. 

2. The scope will go into the Zoom Play mode and begin to scroll through the acquisition (from left to right).

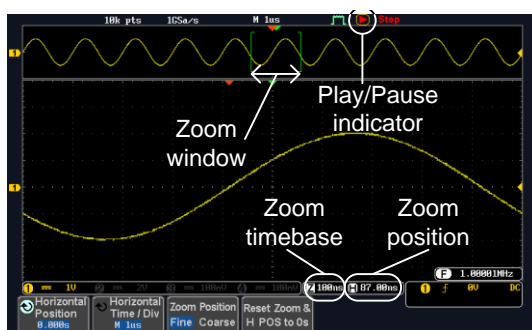

The full-record length waveform will be shown at the top and the zoomed section will be shown at the bottom. The Play/Pause indicator shows the play status.



**Zoom** To increase the zoom range, use the horizontal *Scale* knob.

The zoom time base (Z) at the bottom of the screen will change accordingly.

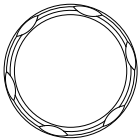
**SCALE**

**Scroll Speed** To alter the scrolling speed of the zoom window, press the *Zoom Position* key to toggle the scrolling speed.

**Zoom Position**  
Fine Coarse

Sensitivity Fine, Coarse

Alternatively, use the horizontal position knob to control the scroll speed.

- Turning the *Horizontal Position* knob determines the speed and direction of the scrolling.

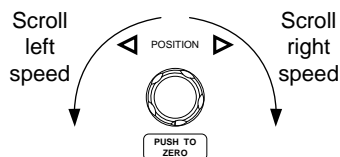

**Reset the Zoom Position** To reset both the zoom position and horizontal position, press *Reset Zoom & H POS to 0s*.

**Reset Zoom & H POS to 0s**

**Pause** Press the *Play/Pause* key to pause or resume playing the waveform.



**Reverse Direction** Press the *Play/Pause* key when at the end of the record length to play back through the waveform in reverse.



**Exit** To exit, press the *Zoom* key.





## Vertical View (Channel)

This section describes how to set the vertical scale, position, and coupling mode.

### Move Waveform Position Vertically

Panel Operation

1. To move the waveform up or down, turn the *Vertical Position* knob for each channel.

POSITION



PUSH TO ZERO

2. As the waveform moves, the vertical position of the waveform appears at the bottom half of the display.

**Position = 0.000**

View or Set the Vertical Position

1. Press a channel key. The vertical position is shown in the  $\updownarrow$ Position /  $\downarrow$ Set to 0 soft key.
2. To change the position, press  $\updownarrow$ Position /  $\downarrow$ Set to 0 to reset the vertical position or turn the *vertical position* knob to the desired level.

CH1



POSITION



PUSH TO ZERO

Run/Stop Mode

The waveform can be moved vertically in both Run and Stop mode.

## Select Vertical Scale

**Panel Operation** To change the vertical scale, turn the *Vertical Scale* knob; left (down) or right (up).

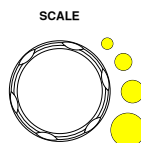

The vertical scale indicator on the bottom left of the display changes accordingly for the specific channel.

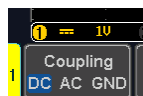

**Range** 1mV/div ~ 10V/div. 1-2-5 increments

**Stop Mode** In Stop mode, the vertical scale setting can be changed.

## Select Coupling Mode

**Panel Operation** 1. Press a *channel* key.



2. Press *Coupling* repeatedly to toggle the coupling mode for the chosen channel.



**Range**

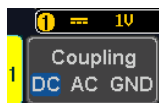

DC coupling mode. The whole portion (AC and DC) of the signal appears on the display.

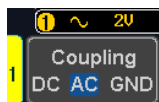

AC coupling mode. Only the AC portion of the signal appears on the display. This mode is useful for observing AC waveforms mixed with DC signals.

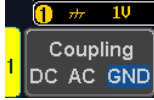

Ground coupling mode. The display shows only the zero voltage level as a horizontal line.

Example

Observing the AC portion of the waveform using AC coupling

DC coupling

AC coupling



## Input Impedance

Background

The input impedance of the GDS-1000B is fixed at 1MΩ. The impedance is displayed in the channel menu.

View Impedance

1. Press the *Channel* key.



2. The impedance is displayed in the bottom menu.



## Invert Waveform Vertically

Panel Operation

1. Press the *Channel* key.



2. Press *Invert* to toggle Invert On or Off.

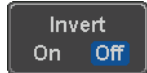

## Limit Bandwidth

**Background**      Bandwidth limitation puts the input signal into a selected bandwidth filter.

This function is useful for cutting out high frequency noise to see a clear waveform shape.

The bandwidth filters available are dependent on the bandwidth of the oscilloscope model.

**Panel Operation**    1. Press the *Channel* key.



2. Press *Bandwidth* from the bottom menu.



3. Choose a bandwidth\* from the side menu.

Range      Full, 20MHz

**Example**

BW Full

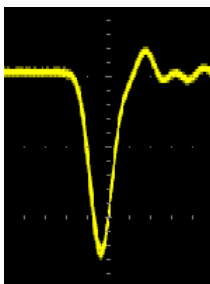

BW Limit 20MHz

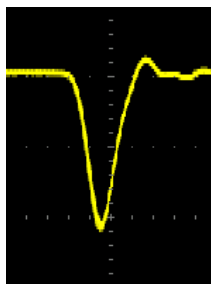



## Expand by Ground/Center

---

**Background**      When the voltage scale is changed, the Expand function designates whether the signal expands from the center of the screen or from the signal ground level. Expand by center can be used to easily see if a signal has a voltage bias. Expand by ground is the default setting.

---

**Panel Operation**

1. Press a *channel* key. 
2. Press *Expand* repeatedly to toggle between expand *By Ground* and *Center*. 

Range      By Ground, By Center

---

**Example**      If the vertical scale is changed when the Expand function is set to ground, the signal will expand from the ground level\*. The ground level does not change when the vertical scale is changed.

If the vertical scale is changed when the Expand function is set to center, the signal will expand from the center of the screen. The ground level will suit to match the signal position.

\*Or from the upper or lower edge of the screen if the ground level is off-screen.

Expand by Ground

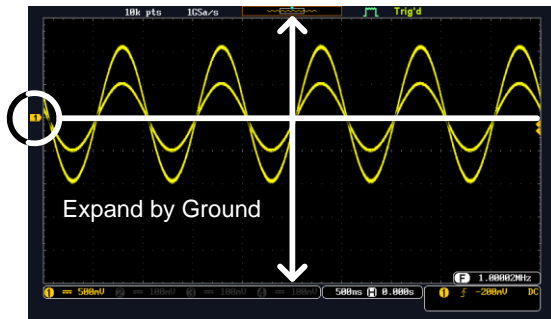

Expand by Center

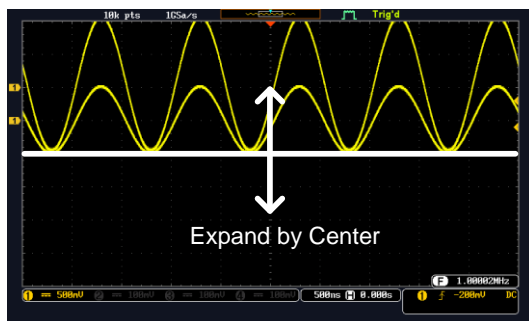

### Select Probe Type

**Background** A signal probe can be set to voltage or current.

**Panel Operation** 1. Press the *Channel* key.



2. Press *Probe* from the bottom menu.

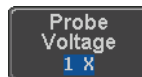



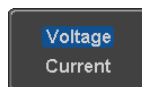

3. Press the *Voltage/Current* soft-key to toggle between voltage and current.



## Select Probe Attenuation Level

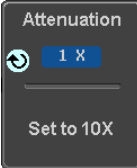

**Background** An oscilloscope probe has an attenuation switch to lower the original DUT signal level to the oscilloscope input range, if necessary. The probe attenuation selection adjusts the vertical scale so that the voltage level on the display reflects the real value on a DUT.

- Panel Operation**
1. Press the *Channel* key. 
  2. Press *Probe* from the bottom menu. 
  3. Press *Attenuation* on the side menu and use the Variable knob to set the attenuation. 
- Alternatively, press *Set to 10X*.
- Range      1mX ~1kX (1-2-5 step)

 **Note** The attenuation factor adds no influence on the real signal. It just changes the voltage/current scale on the display.

## Set the Deskew

**Background** The deskew function is used to compensate for the propagation delay between the oscilloscope and the probe.

- Panel Operation**
1. Press one of the *Channel* keys. 
  2. Press *Probe* from the bottom menu. 

3. Press *Deskew* on the side menu and use the Variable knob to set the deskew time.

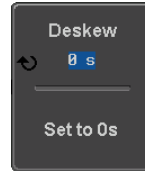

Alternatively, press *Set to 0s* to reset the deskew time.

Range      -50ns~50ns, 10ps increments

4. Repeat the procedure for another channel if necessary.



## Bus Key Configuration

The Bus key is used to configure the Serial bus inputs. The Bus menu also features event tables to track and save your bus data. The Bus key is used in conjunction with the Bus trigger (page 147) to decode serial bus signals.



Note

The Bus key can only be used after the Serial Bus Decode function module (DSIB-BUS) has been installed. See page for details.

## Bus Display

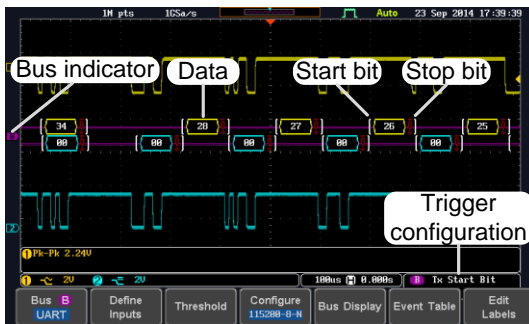

Start Bit/Start of Frame [ The Start bit is shown as an open bracket.

Stop Bit/End of Frame ] The Stop bit is shown as a closed bracket.

Data [ F9 Data packets/frames can be shown in Hex or Binary. The color of the bus data indicates the type of data or the channel the data is coming from, depending on the bus type.

UART: Color of packet = Color of source channel.

I<sup>2</sup>C: Color packet = SDA source channel.

- SPI: Color of packet = MOSI or MISO source channel.
- CAN: Purple = Error frame, Data length control (DLC), Overload.  
Yellow = Identifier.  
Cyan = Data.  
Orange = CRC.  
Red = Bit stuffing error
- LIN: Purple = Break, Sync and Checksum errors, Wakeup  
Yellow = Identifier, Parity  
Cyan = Data  
Red = Error type

Error Indicator/  
Missing Ack

 If there is an error/missing acknowledge in decoding the serial data, a red error indicator will be shown.

Bus Indicator

The Bus indicator shows the bus position. The active bus is shown with a solid color. The Variable knob can be used to horizontally position the Bus indicator when it is active.

-  Active bus (solid indicator)
-  Activated bus (transparent indicator)

Trigger Configuration

Shows the bus trigger (B) and the *Trigger On* settings.

 Tx Start Bit

## Serial Bus

The Serial Bus includes support for 5 common serial interfaces, SPI, UART, I<sup>2</sup>C, CAN and LIN. Each interface is fully configurable to accommodate variations in the basic protocols.

Each input can be displayed as binary, hexadecimal or ASCII. An event table can also be created to aid in debugging.

### Serial Bus Overview

---

UART	<p>Universal Asynchronous Receiver Transmitter. The UART bus is able to accommodate a wide range of various common UART serial communications.</p> <p>The UART serial bus software is suitable for a number of RS-232 protocol variants.</p> <table> <tr> <td>Inputs</td> <td>Tx, Rx</td> </tr> <tr> <td>Threshold</td> <td>Tx, Rx</td> </tr> <tr> <td>Configuration</td> <td>Baud rate, Parity, Packets, End of packets, Input polarity</td> </tr> <tr> <td>Trigger On</td> <td>Tx Start Bit, Rx Start Bit, Tx End of Packet, Rx End of Packet, Tx Data, Rx Data, Tx Parity Error, Rx Parity Error</td> </tr> </table>	Inputs	Tx, Rx	Threshold	Tx, Rx	Configuration	Baud rate, Parity, Packets, End of packets, Input polarity	Trigger On	Tx Start Bit, Rx Start Bit, Tx End of Packet, Rx End of Packet, Tx Data, Rx Data, Tx Parity Error, Rx Parity Error
Inputs	Tx, Rx								
Threshold	Tx, Rx								
Configuration	Baud rate, Parity, Packets, End of packets, Input polarity								
Trigger On	Tx Start Bit, Rx Start Bit, Tx End of Packet, Rx End of Packet, Tx Data, Rx Data, Tx Parity Error, Rx Parity Error								
I <sup>2</sup> C	<p>Inter Integrated Circuit is a two line serial data interface with a serial data line (SDA) and serial clock line (SCLK). The R/W bit can be configured.</p> <table> <tr> <td>Inputs</td> <td>SCLK, SDA</td> </tr> <tr> <td>Threshold</td> <td>SCLK, SDA</td> </tr> <tr> <td>Configuration</td> <td>Addressing mode, Read/Write in address</td> </tr> <tr> <td>Trigger On</td> <td>Start, Repeat Start, Stop, Missing Ack, Address, Data, Address/Data</td> </tr> </table>	Inputs	SCLK, SDA	Threshold	SCLK, SDA	Configuration	Addressing mode, Read/Write in address	Trigger On	Start, Repeat Start, Stop, Missing Ack, Address, Data, Address/Data
Inputs	SCLK, SDA								
Threshold	SCLK, SDA								
Configuration	Addressing mode, Read/Write in address								
Trigger On	Start, Repeat Start, Stop, Missing Ack, Address, Data, Address/Data								

**SPI**                    The SPI (Serial Interface Peripheral) bus is fully configurable to accommodate the wide variety of SPI interfaces. This bus is only available on 4 channel models.

- Inputs                SCLK, SS, MOSI, MISO
- Threshold          SCLK, SS, MOSI, MISO
- Configuration    SCLK edge, SS logic level, Word size, Bit order
- Trigger On        SS Active, MOSI, MISO, MOSI&MISO

**CAN**                    The CAN (Controller Area Network) bus is a 2-wire, message-based protocol.

- Inputs                CAN Input
- Threshold          CAN Input
- Configuration    Signal Type, Bit Rate
- Trigger On        Start of Frame, Type of Frame, Identifier, Data, Id & Data, End of Frame, Missing Ack, Bit Stuffing Err.

**LIN**                    The LIN (Local Interconnect Network) bus is used to decode a wide range of common LIN configurations.

- Inputs                LIN Input
- Threshold          LIN Input
- Configuration    Bit Rate, LIN Standard, Include Parity Bits with Id
- Trigger On        Sync, Identifier, Data, Id & Data, Wakeup Frame, Sleep Frame, Error

## UART Serial Bus Configuration

The UART bus menu is designed to decode RS-232 and other common RS-232 variants such as RS-422, RS-485. The software configuration is also flexible enough to decode the many proprietary protocols based on RS-232.

### Background

Basic RS-232 protocol uses single-ended data transmissions. The signal voltage levels can be high ( $\pm 15V$ ) and employ active low signaling.

High speed variants of RS-232, such as RS-422 and RS-485 use differential signaling and commonly employ low voltage differential signals with active high signaling.

Universal Asynchronous Receiver/Transmitter (UART) or RS-232 driver/receiver ICs commonly used for embedded applications typically use active high signaling with standard IC signal levels.

### Operation

1. Connect each of the bus signals ( $T_x$ ,  $R_x$ ) to one of the oscilloscope channels. Connect the ground potential of the bus to one of the probes' ground clip.

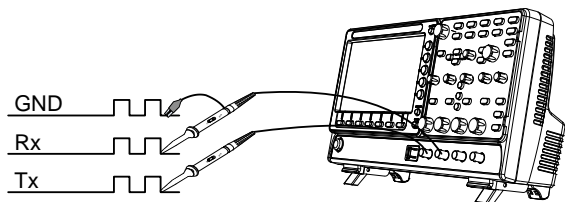

2. Press the *BUS* key.



3. Press *Bus* from the bottom menu and choose the *UART* serial bus on the side menu.

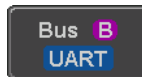

Define Inputs

4. Press *Define Inputs* from the bottom menu.

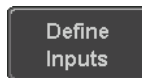

5. From the side menu choose the *Tx Input* and the *Rx Input* source and the signal polarity.

Tx            OFF, CH1 ~ CH4

Rx            OFF, CH1 ~ CH4

Polarity    Normal (High = 0), Inverted (High = 1)

Configuration

The Configure key sets the baud rate, number of data bits and parity.

6. Press *Configure* from the bottom menu.

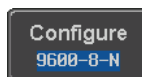

7. From the side menu select the *Baud rate*, *Data bits*, *Parity*, *Packets* and *End of Packet bits*.

Baud Rate    50, 75, 110, 134, 150, 300, 600, 1200, 1800, 2000, 2400, 3600, 4800, 7200, 9600, 14400, 15200, 19200, 28800, 31250, 38400, 56000, 57600, 76800, 115200, 128000, 230400, 460800, 921600, 1382400, 1843200, 2764800

Data Bits    8 (fixed)

Parity        Odd, Even, None

Packets      On, Off

End of Packet (Hex)    00(NUL), 0A(LF), 0D(CR), 20(SP), FF

## I<sup>2</sup>C Serial Bus Interface

The I<sup>2</sup>C bus is a 2 wire interface with a serial data line (SDA) and serial clock line (SCLK). The I<sup>2</sup>C protocol supports 7 or 10 bit addressing and multiple masters. The scope will trigger on any of the following conditions: a start/stop condition, a restart, a missing acknowledge message, Address, Data or Address&Data frames. The I<sup>2</sup>C trigger can be configured for 7 or 10 bit addressing with the option to ignore the R/W bit as well as triggering on a data value or a specific address and direction (read or write or both).

- Panel operation
1. Connect each of the bus signals (SCLK, SDA) to one of the oscilloscope channels. Connect the ground potential to one of the probes' ground clip.

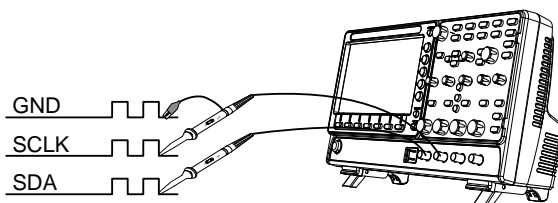

2. Press the *Bus* key.



3. Press *Bus* from the bottom menu and choose I<sup>2</sup>C from the side menu.

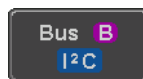

- Define Inputs
4. Press *Define Inputs* from the bottom menu.

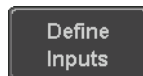

5. From the side menu choose the SCLK input and the SDA Input.

SCLK      CH1 ~ CH4

SDA      CH1 ~ CH4

Include R/W in address To configure whether you want the R/W bit to be included in the address, press *Include R/W in address* and set to Yes or No in the side menu.



R/W Bit Yes, No

### SPI Serial Bus Interface

The serial peripheral interface (SPI) is a full duplex 4 wire synchronous serial interface. The 4 signals lines: Serial clock line (SCLK), slave select (SS), Master output/slave input (MOSI, or SIMO) and the Master input/slave output (MISO, or SOMI). The word size is configurable from 4 to 32 bits. The SPI triggers on the data pattern at the start of each framing period. Note: The SPI bus is only available for 4 channel models.

- Panel operation
1. Connect each of the bus signals (*SCLK*, *SS*, *MOSI*, *MISO*) to one of the channel inputs. Connect the ground potential of the bus to one of the probes' ground clip.

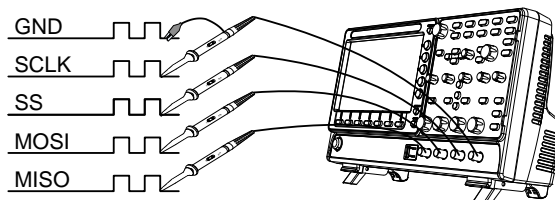

2. Press the *Bus* key.



3. Press *Bus* from the bottom menu and choose the *SPI* serial bus.

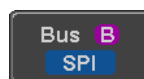

- Define Inputs
4. Press *Define Inputs* from the lower menu.

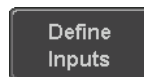



- From the side menu choose the *SCLK*, *SS*, *MOSI* and *MISO* inputs.



SCLK	CH1 ~ CH4
SS	CH1 ~ CH4
MOSI	OFF, CH1 ~ CH4
MISO	OFF, CH1 ~ CH4

**Configuration**      The *Configure* menu sets the data line logic level, SCLK edge polarity, word size and bit order.

- Press *Configure* from the bottom menu.



- From the side menu select SCLK edge, SS logic level, word Size and Bit order.

SCLK	rising edge  , falling edge 
SS	Active High, Active Low
Word Size	4 ~ 32 bits
Bit Order	MS First, LS First

### CAN Serial Bus Interface

The controller area network (CAN) bus is a half duplex 2 wire synchronous serial interface. The CAN bus is a multi-master communication system that relies on arbitration to solve contention issues. The GDS-2000E supports both CAN 2.0A and 2.0B. The CAN bus uses two wires, CAN-High and CAN-Low. These wires are voltage inverted, and as such, the GDS-2000E only needs one wire, CAN-High or CAN-Low for decoding.

- Panel operation
1. Connect the bus signal (*CAN Input*) to one of the channel inputs. Connect the ground potential of the bus to the probe's ground clip.

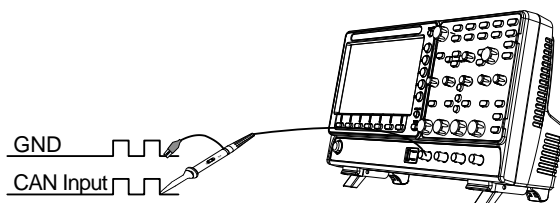

2. Press the *Bus* key.



3. Press *Bus* from the bottom menu and choose the *CAN* serial bus.

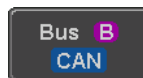

- Define Inputs
4. Press *Define Inputs* from the lower menu.

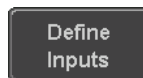

5. From the side menu choose the *CAN Input* inputs and the signal type.

CAN Input CH1 ~ CH4

Signal Type CAN\_H, CAN\_L, Tx, Rx.



Note

The *Sample Point* soft-key indicates the sampling position of each bit. This parameter is fixed.

Bit Rate

The *Bit Rate* menu sets the bit rate of the bus. The bit rate is usually tied to the bus length.

6. Press *Bit Rate* from the bottom menu and set the bit rate.



Bit Rate    10kbps, 20kbps, 50kbps, 125kbps,  
250kbps, 500kbps, 800kbps, 1Mbps

### LIN Serial Bus Interface

The local interconnect network (LIN) bus is a single wire interface.

Panel operation

1. Connect the bus signal (*LIN Input*) to one of the channel inputs. Connect the ground potential of the bus to the probe's ground clip.

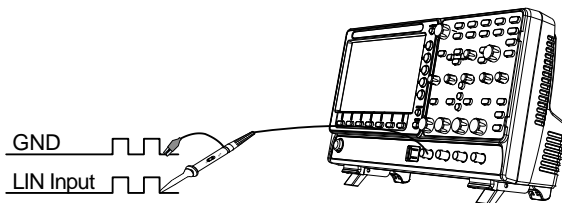

2. Press the *Bus* key.



3. Press *Bus* from the bottom menu and choose the *LIN* serial bus.



Define Inputs

4. Press *Define Inputs* from the lower menu.

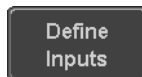

- From the side menu choose the LIN input and the polarity of the bus.

LIN Input CH1 ~ CH4

Polarity Normal (High = 1),  
Inverted(High = 0)



Note

The *Sample Point* soft-key indicates the sampling position of each bit. This parameter is fixed.

Configuration

The *Configure* menu sets the bit rate, the LIN standard and the parity options for the Id frame.

- Press *Configure* from the bottom menu.

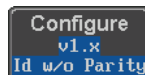

- From the side menu select configuration items.

Bit Rate 1.2kbps, 2.4kbps, 4.8kbps,  
9.6kbps, 10.417kbps, 19.2kbps

LIN Standard V1.x, V2.x, Both

Include Parity On, Off  
Bits with Id

## Bus Encoding

Background

The bus that is displayed on the screen or in the event tables can be set to either hex or binary formats.

Operation

Press *Bus Display* from the Bus menu and choose either Hex or Binary from the side menu.

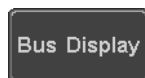

## Threshold Configuration

**Background**      The threshold levels for the Serial buses can be set to either a user-defined threshold level or to pre-set threshold.

**Set the Threshold** 1. Press *Threshold* from the bottom menu.

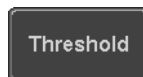

2. Press *Select* from the side menu and choose a one of the serial bus lines.



UART	Tx, Rx
I <sup>2</sup> C	SCLK, SDA
SPI	SCLK, SS, MOSI, MOSI
CAN	CAN_H, CAN_L, Tx, Rx
LIN	LIN Input

3. Press *Choose Preset* to select a pre-set logic threshold.

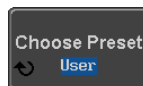

Logic Type	Threshold
TTL	1.4V
5.0V CMOS	2.5V
3.3V CMOS	1.65V
2.5V CMOS	1.25V
ECL	-1.3V
PECL	3.7V
0V	0V

4. Press *Threshold* to set a user defined threshold for the currently selected group. The threshold level depends on vertical scale.

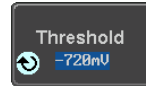

Scale	Range	Scale	Range
10V/Div	±290V	50mV/Div	±5.2V
5V/Div	±270V	20mV/Div	±580mV
2V/Div	±33V	10mV/Div	±540mV
1V/Div	±29V	5mV/Div	±520mV
500mV/Div	±27V	2mV/Div	±508mV
200mV/Div	±5.8V	1mV/Div	±504mV
100mV/Div	±5.4V		

## Serial Bus Event Tables

---

**Background**      The serial bus event tables list when each data event on the bus occurred. The data is displayed as either hex or binary, depending on the bus display settings.

Event tables can be saved to disk in a CSV format. The files will be named "Event\_TableXXXX.CSV", where XXXX is a number from 0000 to 9999. See page 123 for details.

---

### Operation

1. Press *Event Table* from the bottom menu.

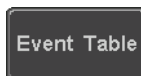

2. Press *Event Table* from the side menu to turn the event table on or off.

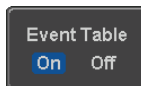

Event      On, Off

Use the Variable knob to scroll through the event table.

### Data Detail (I<sup>2</sup>C only)

3. To view the data at a particular address in more detail, turn *Data Detail* On. This is only available for the I<sup>2</sup>C bus.

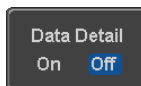

Detail      On, Off

Use the Variable knob to scroll through the Data Detail event table.

- Save Event Table 4. To save the event table, press *Save Event Table*. The Event table will be saved to the current file path in a CSV format. See page 123 for details.

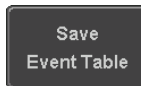

Use the variable knob to scroll through the event table.

Example:  
UART Event table

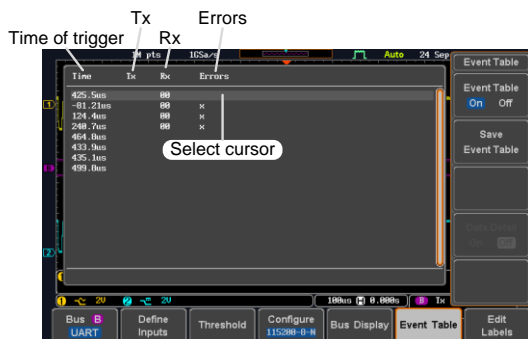

Example:  
I<sup>2</sup>C Event table

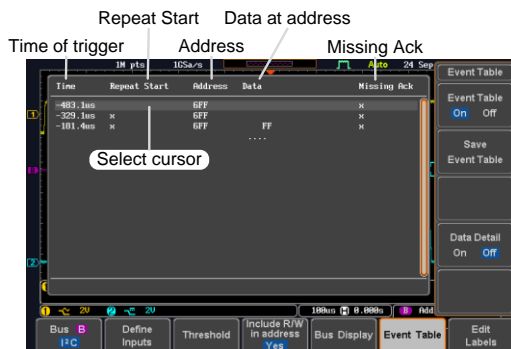



Example:  
I<sup>2</sup>C Data Detail

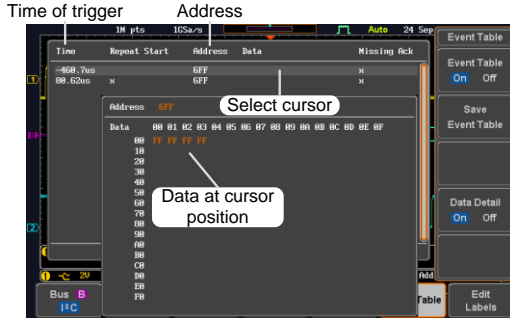

Note

Data Detail is only available with the I<sup>2</sup>C bus.

Example:  
SPI Event table

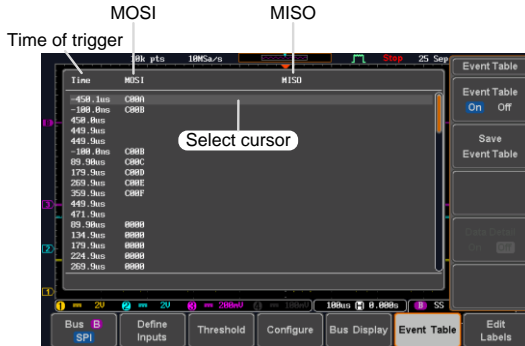

Example:  
CAN Event table

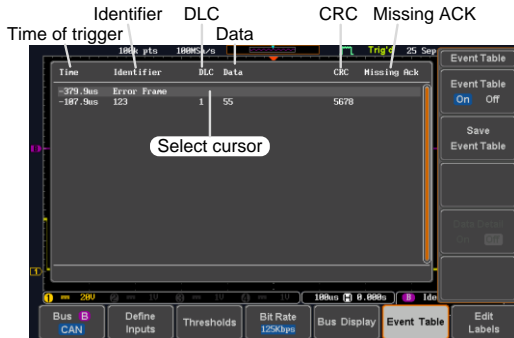

Example:  
LIN Event table

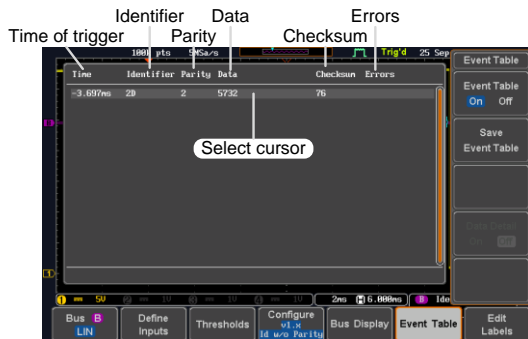

## Event Tables Format

Each bus type (UART, I<sup>2</sup>C, SPI, CAN, LIN) can have an event table saved containing each bus event as a .CSV file. For serial buses, an event is defined as the data on the bus when a Stop or End of Packet (UART) is encountered. The data associated with each event and the time of each event is recorded.

---

**File Type** Each event table is saved as Event\_TableXXXX.CSV into the designated file path. Each event table is numbered sequentially from 0000 to 9999. For example the first event table will be saved as Event\_Table0000.CSV, the second as Event\_Table0001.CSV, and so on.

**Event Table Data** Each event table saves a timestamp of each event relative to the trigger as well as the data in each frame/packet at the time of an event. The frame/packet data is saved in HEX format.

The table below lists in order the data saved for each event table.

UART	Time, Tx frame data, Rx frame data, Errors.
I <sup>2</sup> C	Time, Repeat Start, Address, Data, Missing Ack.
SPI	Time, MISO frame data, MOSI frame data.
CAN	Time, Identifier, DLC, Data, CRC, Missing Ack.
LIN	Time, Identifier, Parity, Data, Checksum, Errors.

**Example** Below shows the data associated with an SPI event table in a spreadsheet.

Time	MOSI	MISO
-11.60us	0D87	0D87
-10.16us	06C0	06C0
-8.720us	8343	343
-7.282us	243	243
-5.840us	0C88	0C88

## Adding a Label to the Serial Bus

---

**Background** A Label can be added to the serial buses. This label will appear next to the bus indicator on the left hand-side of the display.

---

**Panel Operation** 1. To add a label to the bus, press *Edit Labels* from the Bus menu.

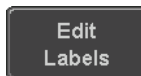

2. To choose a preset label, Press *User Preset* from the side menu and choose a label.



**Labels** ACK, AD0, ADDR, ANALOG, BIT, CAS, CLK, CLOCK, CLR, COUNT, DATA, DTACK, ENABLE, HALT, INT, IN, IRQ, LATCH, LOAD, NMI

**Edit Label** 3. Press *Edit Character* to edit the current label.

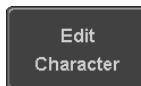

- The Edit Label window appears.

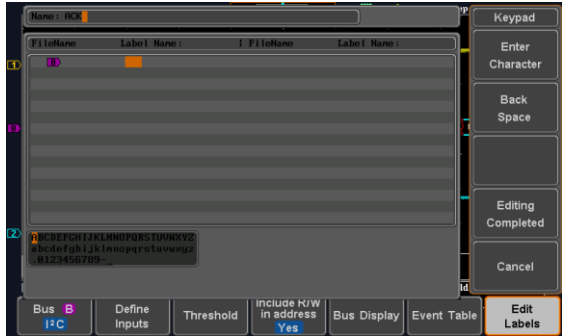

- Use the Variable knob to highlight a character.

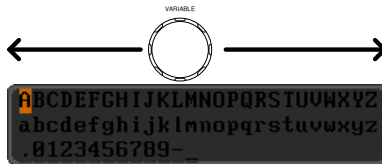

Press *Enter Character* to select a number or letter.

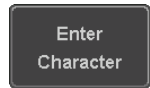

Press *Back Space* to delete a character.

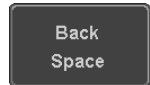

Press *Editing Completed* to create the new label and return to the previous menu.

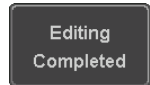

Note: this key must be pressed to save the label, even for the preset labels.

Press *Cancel* to cancel the editing and return to the Edit Label menu.

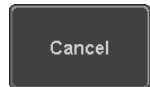

- The label will appear next to the bus indicator.

Below, the label “ACK” was created for the bus.



The bus is labeled as ACK

Remove Label      Press *Label Display* to toggle the label on or off.

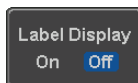

### Using Cursors with the Serial Bus

---

Background      The cursors can be used to read bus values at any position.



Note

Ensure that one of the serial buses has been selected and is activated.

Panel Operation      1. Press the *Cursor* key. Horizontal cursors appear on the display.

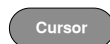

2. Press the *H Cursor* soft-key and select which cursor(s) you wish to position.



Range	Description
∷	Left cursor (1) movable, right cursor position fixed
∷	Right cursor (2) movable, left cursor position fixed
∷	Left and right cursor (1+2) movable together

3. The cursor position information appears on the top left hand side of the screen.

```
❶ -268us   Addr :0x6FF
❷  232us   Data :0xFF
  Δ500us
```

Example: I<sup>2</sup>C cursors.

Cursor ❶ Hor. position, Bus value(s)

Cursor ❷ Hor. position, Bus value(s)

4. Use the *Variable knob* to move the movable cursor(s) left or right.

VARIABLE

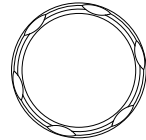

# Trigger

The trigger configures the conditions for when the GDS-1000B captures a waveform.

## Trigger Type Overview

---

**Edge**                      The edge trigger is the simplest trigger type. An edge trigger triggers when the signal crosses an amplitude threshold with either a positive or negative slope.

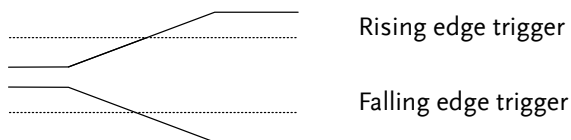

**Delay**                      The Delay trigger works in tandem with the edge trigger, by waiting for a specified time (duration) or number of events before the delay trigger starts. This method allows pinpointing a location in a long series of trigger events.

Note: when using the delay trigger, the edge trigger source can be any one of the channel inputs, the EXT\* input or the AC line. \*EXT only available on 2 channel models.

Delay trigger example (by event)

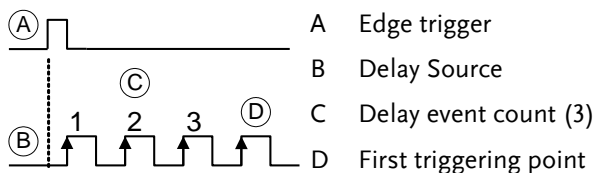



Delay trigger example (by time)

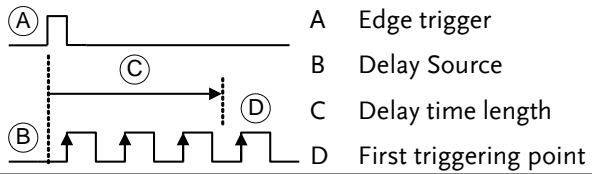

**Pulse Width** Triggers when the pulse width of the signal is less than, equal, not equal or greater than a specified pulse width.

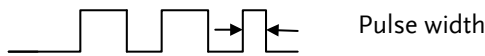

**Video** Extracts a sync pulse from a video format signal, and triggers on a specific line or field.

**Pulse and Runt** Triggers on a "runt". A runt is a pulse that passes a specified threshold but fails to pass a second threshold. Both positive and negative runts can be detected.

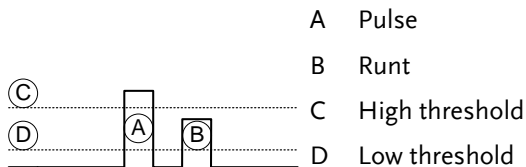

**Rise and Fall (Slope)** Trigger on rising and or falling edges, below or over a specified rate. The threshold can also be specified.

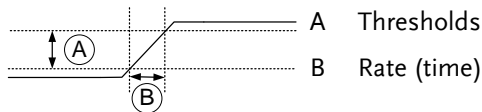

**Timeout** Triggers when the signal stays high, low or either for a designated amount of time. The trigger level determines when a signal is high or low.

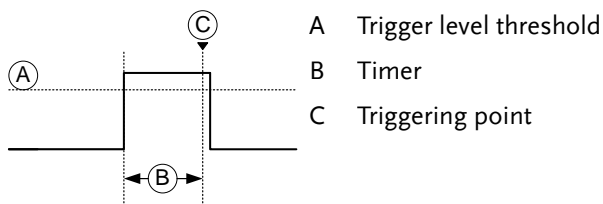

Bus Triggers on SPI, UART, I<sup>2</sup>C, CAN or LIN bus.

### Trigger Parameter Overview

All the following parameters are common for all the trigger types unless stated otherwise.

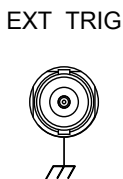

Trigger Source	CH1 ~ 4	Channel 1 ~ 4 input signals.
	EXT	External trigger input signal. Only available on 2 channel models.
	AC Line	AC mains signal.
	Alternate	Alternate between channel sources for the trigger source.
	EXT Probe	Configures the probe connected to the EXT TRIG BNC as a current or voltage probe. Only available on 2 channel models.
Source Bus	UART	UART bus
	I <sup>2</sup> C	Inter-Integrated Circuit
	SPI	Serial Peripheral Bus
	CAN	Controller Area Network bus
	LIN	Local Interconnect Network

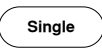

Trigger Mode	Auto (un-triggered roll)	The GDS-1000B generates an internal trigger if there is no trigger event, to make sure waveforms are constantly updated regardless of trigger events. Select this mode especially when viewing rolling waveforms at slower timebases.
	Normal	The GDS-1000B acquires a waveform only when a trigger event occurs.
	Single	The GDS-1000B acquires a waveform once when a trigger event occurs, then stops acquiring. Press the Single key to acquire a waveform again.



Coupling (Edge, Delay, Timeout)	DC	DC coupling.
	AC	AC coupling. Blocks DC components from the trigger circuits.
	HF reject	High frequency filter above 70kHz.
	LF reject	Low frequency filter below 70kHz.
	Reject noise	DC coupling with low sensitivity to reject noise.

Slope (Edge, Delay, Rise & Fall)		Trigger on a rising edge.
		Trigger on a falling edge.
		Either. (either rising or falling edge) (Edge, Delay, Rise & Fall trigger type only)

Trigger Level (Edge, Delay)	Level	Adjusts the trigger manually using the Trigger LEVEL knob.
--------------------------------	-------	--

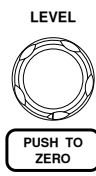

	Set to TTL 1.4V	Sets the trigger level to 1.4V, suitable for triggering on TTL signals.	
	Set to ECL - 1.3V	Sets the trigger to -1.3V. This is suitable for ECL circuits.	
	Set to 50%	Sets the trigger level to 50% of the waveform amplitude.	

---

Holdoff	Holdoff	Sets the holdoff time.
	Set to Minimum	Set the holdoff time to the minimum.

---

Delay (Delay)	Time	Sets the delay time (4ns ~ 10s) between the trigger event and the real trigger timing.
	Event	Sets the number of events (1 ~ 65535) passed after the trigger event, until the real trigger timing.
	Set to Minimum	Sets the source trigger to the minimum time.





---

When (Pulse Width)	Sets the pulse width (4ns ~ 10s) and the triggering condition.		
	>	Longer than	= Equal to
	<	Shorter than	≠ Not equal to

---

Threshold (Pulse Width)	Sets the amplitude threshold level for the pulse widths.		
	Threshold	-XXV ~ +XXV, user-set level	
	Set to TTL	1.4V	
	Set to ECL	-1.3V	
	Set to 50%	Sets the threshold to 50%	

---

Standard (Video)	NTSC	National Television System Committee
	PAL	Phase Alternate by Line
	SECAM	SEquential Couleur A Memoire
Polarity (Pulse Width, Video)		Positive polarity (triggered on the high to low transition)
		Negative polarity (triggered on the low to high transition)
Polarity (Pulse Runt)		Positive polarity (positive runt)
		Negative polarity (negative runt)
		Either (either negative or positive runt)
Trigger On (Video)	Selects the trigger point in the video signal.	
	Odd Field	NTSC: 1 ~ 263 PAL/SECAM: 1 ~ 313 EDTV: 1~525(480P), 1~625(576P) HDTV: 1~750(720P), 1~563(1080i), 1~1125(1080P)
	Even Field	NTSC: 1 ~ 262, PAL/SECAM: 1 ~ 312 HDTV: 1~562(1080i)
	All Fields	Triggers on all fields.
	All Lines	Triggers on all lines.
Trigger On (Bus)	Selects the conditions for the bus triggers.	
	UART Bus	Tx Start Bit, Rx Start Bit, Tx End of Packet, Rx End of Packet, Tx Data, Rx Data, Tx Parity Error, Rx Parity Error
	I <sup>2</sup> C	Start, Repeat Start, Stop, Missing Ack, Address, Data, Address/Data
	SPI	SS Active, MOSI, MISO, MOSI & MISO

CAN	Start of Frame, Type of Frame, Identifier, Data, Id & Data, End of Frame, Missing Ack, Bit Stuffing Err
LIN	Sync, Identifier, Data, Id & Data, Wakeup Frame, Sleep Frame, Error

Threshold (Pulse Runt)  Sets the upper threshold limit.

 Sets the lower threshold limit.

Threshold (Rise & Fall)  High Sets the High threshold.

 Low Sets the Low threshold.

Trigger When (Timeout) Stays High Triggers when the input signal stays high for a designated amount of time.

Stays Low Triggers when the input signal stays low for a designated amount of time.

Either Triggers when the input signal stays high or low for a designated amount of time.

Timer (Timeout) 4ns~10.0s Sets the amount of time that a signal must stay high or low for the timeout trigger.

## Setup Holdoff Level

**Background** The holdoff function defines the waiting period before the GDS-1000B starts triggering again after a trigger point. The holdoff function ensures a stable display if there are a number of points in a periodic waveform that can be triggered. Holdoff applies to all the triggering types.

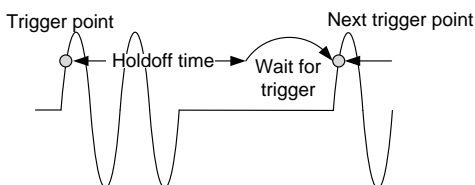



- Panel Operation**
1. Press the trigger *Menu* key. Menu
  
  2. To set the Holdoff time, press the *Holdoff* (or *Mode/Holdoff*) menu button on the bottom bezel. Holdoff  
4.000ns
  
  3. Use the side menu to set the Holdoff time. ↻ 4.000ns
- Range      4ns~10s
- Pressing *Set to Minimum* sets the Holdoff time to the minimum, 4ns. Set to  
Minimum

 **Note**





The holdoff function is automatically disabled when the waveform update mode is in roll mode (page92).

## Setup Trigger Mode

**Background** The trigger mode can be set to Normal or Auto (untriggered roll). The triggering mode applies to all the trigger types. See page 92.

- Panel Operation**
1. Press the Trigger menu key. 
  2. Press *Mode* from the bottom menu to change the triggering mode. 
  3. Use the side panel to select *Auto* or *Normal* triggering modes.  
Range Auto, Normal

## Using the Edge Trigger

- Panel Operation**
1. Press the trigger *Menu* key. 
  2. Press *Type* from the lower bezel menu. 
  3. Select *Edge* from the side menu. The edge trigger indicator appears at the bottom of the display.   
  
From left: trigger source, slope, trigger level, coupling
  4. Press *Source* to change the trigger source. 



5. Use the side menu to select the trigger source type.

Range Channel 1 ~ 4 (Alternate On/Off),  
EXT (Ext Probe: Volt/Current,  
Attenuation: 1mX~1kX, CH2  
models only), AC Line

6. Press *Coupling* from the bottom bezel menu to select the trigger coupling or frequency filter settings.

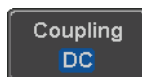

Choose the coupling from the side menu.

Range DC, AC, HF Reject, LF Reject

7. Toggle *Noise Rejection* On or Off from the side menu.

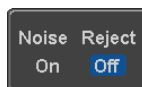

Range On, Off

8. From the bottom menu press *Slope* to toggle the slope type.



Range Rising edge, falling edge, either

9. To set the trigger level, select *Level* from the bottom bezel menu. (Not applicable for AC line source)

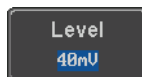

Set the trigger level using the side menu.



Range 00.0V~ 5 screen divisions  
Set to TTL 1.4V  
Set to ECL -1.3V  
Set to 50%

## Using Advanced Delay Trigger

Panel Operation 1. Set the edge trigger source. This will set the initializing trigger for the delay source. Page 136

2. Press the trigger *Menu* key.



3. Press *Type* from the lower bezel menu.



4. Select *Delay* from the side menu. The delay trigger indicator appears at the bottom of the display.

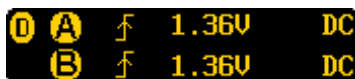

From left: Delay trigger indicator (D), edge trigger (A), edge slope, edge level, edge coupling, delay trigger (B), delay slope, delay trigger level, delay coupling.

5. To set the delay source, press *Source* and select a source from the side menu.



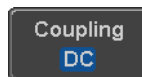

Source CH1 ~ CH4, AC Line, EXT\*  
\*2 channel models only.

6. Press *Coupling* from the bottom bezel menu to select the trigger coupling or frequency filter settings.





Choose the coupling from the side menu.

Range DC, AC, HF Reject, LF Reject

- 7. To set the delay press *Delay* from the bottom bezel. 
- 8. To Delay by Time (Duration), press *Time* from the side menu and set the delay time. 
  - Range 4ns ~ 10s (by time)
  - Set to minimum
- 9. To Delay by Event, press *Event* from the side menu and set the number of events. 
  - Range 1 ~ 65535 events
  - Set to Minimum

### Using Pulse Width Trigger

---

- Panel Operation
- 1. Press the trigger *Menu* key. 
  - 2. Press the *Type* key from the lower bezel menu. 
  - 3. Select *Pulse Width* from the side menu. The pulse width trigger indicator appears at the bottom of the display. 



From left: source, polarity, when, coupling
  - 4. Press *Source* from the lower bezel. 

5. Use the side menu to select the pulse width trigger source.
- Range Channel 1 ~ 4 (Alternate On/Off),  
EXT (Ext Probe: Volt/Current,  
Attenuation: 1mX~1kX ), AC Line

6. Press *Polarity* to toggle the polarity type.

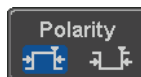

- Range Positive (high to low transition)  
Negative (low to high transition)

7. Press *When* from the lower bezel.

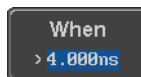

Then use the side menu to select the pulse width condition and width.

Condition > , < , = , ≠

Width 4ns ~ 10s

8. Press *Threshold* from the lower bezel to edit the pulse width threshold.



Use the side menu to set the threshold.

- Range -XXV~XXV  
Set to TTL 1.4V  
Set to ECL -1.3V  
Set to 50%

## Using Video Trigger

---

Panel Operation 1. Press the trigger *Menu* key.



2. Press the *Type* key from the lower bezel menu.



3. Select *Video* from the side menu.  
The video trigger indicator appears at the bottom of the display.



From left: source, video standard, field, line, coupling

4. Press *Source* from the lower bezel.



5. Use the side menu to select the video trigger source.

Range Channel 1 ~ 4

6. Press *Standard* on the bottom bezel.



Use the side menu to select the video standard.

Range NTSC, PAL, SECAM, EDTV(480P, 576P), HDTV(720P, 1080i, 1080P)

7. Press *Trigger On* to edit the video field and line.

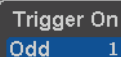

Use the side menu to select the field and line.

- Odd Field NTSC: 1 ~ 263  
PAL/SECAM: 1 ~ 313  
EDTV: 1~525(480P), 1~625(576P)  
HDTV: 1~750(720P), 1~563(1080i),  
1~1125(1080P)
- Even Field NTSC: 1 ~ 262  
PAL/SECAM: 1 ~ 312  
HDTV: 1~562(1080i)
- All Fields Triggers on all fields.
- All Lines Triggers on all lines.

8. Press *Polarity* to toggle the polarity type.



Range positive, negative

## Pulse Runt trigger

---

Panel Operation 1. Press the trigger *Menu* key.



2. Press the *Type* key from the lower bezel menu.



3. Select *Others* → *Pulse Runt* from the side menu. The Pulse and Runt indicator appears at the bottom of the display.

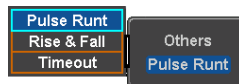

From left: polarity, source, high/low threshold, threshold level, coupling

4. Press *Source* from the lower menu.



Use the side menu to select a source.

Range Channel 1 ~ 4(Alternate On/Off)

5. Press *Polarity* to toggle the polarity.



Range Rising edge, falling edge, either.

6. Press *When* from the lower menu.

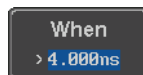

Then use the side menu to select the condition and width.

Condition > , < , = , ≠

Width 4ns ~ 10s

7. Press *Threshold* from the lower bezel to edit the threshold for the upper and lower threshold.

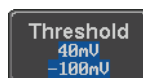

8. Use the side menu to set the upper threshold.



Range -XXV~XXV

9. Use the side menu to set the lower threshold.



Range -XXV~XXV

## Using Rise and Fall Trigger

Panel Operation 1. Press the trigger *Menu* key.



2. Press the *Type* key from the lower bezel menu.



3. Select *Others* → *Rise and Fall* from the side menu. The Rise and Fall indicator appears at the bottom of the display.

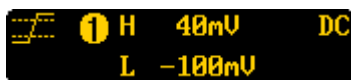
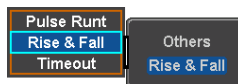

From left: slope, source, high/low threshold, threshold level, coupling

4. Press *Source* from the lower menu.



Use the side menu to select a source.

Range Channel 1 ~ 4(Alternate On/Off)

5. Press *Slope* from the bottom menu to toggle the slope.



Range Rising edge, falling edge, either

6. Press *When* from the lower menu.

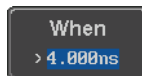

Then use the side menu to select the logic conditions and true or false status.

Condition > , < , = , ≠



Width 4ns ~ 10s

7. Press *Threshold* from the lower bezel to edit the High and Low threshold.



Range High: -XXV~XXV  
Low: -XXV~XXV

## Using the Timeout Trigger

---

- Panel Operation 1. Press the trigger *Menu* key.



2. Press the *Type* key from the lower bezel menu.



3. Select *Others* → *Timeout* from the side menu. The Timeout indicator appears at the bottom of the display.

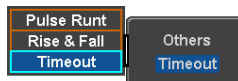

**1 Timeout 1.40V DC**

From left: Source, Trigger type, threshold level, coupling

4. Press *Source* from the lower menu.



Use the side menu to select a source.

Range Channel 1 ~ 4, EXT (Ext Probe: Volt/Current, Attenuation: 1mX~1kX), AC Line

5. Press *Coupling* from the bottom bezel menu to select the trigger coupling or frequency filter settings.

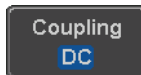

Choose the coupling from the side menu.

Range DC, AC, HF Reject, LF Reject

6. Toggle *Noise Rejection* On or Off from the Coupling side menu.

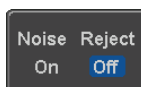

Range On, Off

7. Press *Trigger When* from the lower menu.



Then use the side menu to select trigger conditions.

Condition Stays High, Stays Low, Either

8. Press *Level* from the lower bezel to set the trigger level.

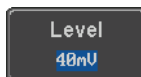

Range -XXV~XXV

Set to TTL 1.4V

Set to ECL -1.3V

Set to 50%

9. Press *Timer* from the lower bezel to set the timer time.

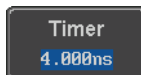

Range 4ns~10.0S

## Using the Bus Trigger

**Background**      The Bus trigger is used to trigger and decode UART, I<sup>2</sup>C, SPI, CAN and LIN serial bus signals.

### UART BUS Trigger Settings

The UART bus trigger conditions can be set at any time after the bus settings have been set to *UART*.

**Panel Operation**    1. Set the Bus to UART in the bus menu.      Page 109

2. Press the *Trigger Menu* key.



3. Press *Type* from the bottom menu.



4. Press *Others* from the side menu and select *Bus*.

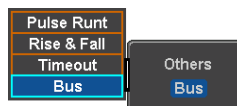

The Trigger on settings will be reflected on the Trigger Configuration icon.



From left: Bus trigger, Trigger source

5. Press *Trigger On* and select the triggering condition for the UART bus.



**Trigger On** Tx Start Bit, Rx Start Bit, Tx End of Packet, Rx End of Packet, Tx Data, Rx Data, Tx Parity Error, Rx Parity Error

Trigger On – Tx Data, Rx Data      If Tx Data or Rx Data was configured for the Trigger On setting, then the number of bytes and data can also be configured.

6. Press *Data* from the bottom menu.



7. Press *Number of Bytes* from the side menu and choose the number of bytes for the data.

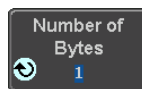

UART      1~10 Bytes

8. Press *Data* from the side menu to edit the triggering data.

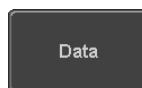

To edit the data, use the *Variable* knob to highlight a binary or hex digit and press *Select*. Use the *Variable* knob to choose a value for the digit and press *Select* to confirm.

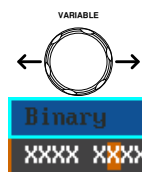

- Binary      0,1,X (don't care)
- Hex          0~F, X (don't care)
- ASCII        ASCII characters for the equivalent Hex characters 00 to FF



### I<sup>2</sup>C Bus Trigger Settings

The I<sup>2</sup>C bus trigger conditions can be set at any time after the bus settings has been set to I<sup>2</sup>C.

Panel Operation      1. Set the Bus to I<sup>2</sup>C in the bus menu.      Page 111

2. Press the *Trigger Menu* key.



- 3. Press *Type* from the bottom menu. 
- 4. Press *Others* from the side menu and select *Bus*. 



The Trigger on settings will be reflected on the Trigger Configuration icon.

**B Data**

From left: Bus trigger, Trigger source

- 5. Press *Trigger On* and select the triggering condition for the selected bus. 
- Trigger On Start, Repeat Start, Stop, Missing Ack, Address, Data, Address/Data

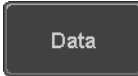
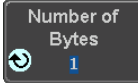
**Trigger On – Data** If Data or Address/Data was configured for the Trigger On setting, then the number of bytes, data and addressing mode (I<sup>2</sup>C) can be configured.

- 6. Press *Data* from the bottom menu. 
- 7. Press *Number of Bytes* from the side menu and choose the number of bytes for the data.   
I<sup>2</sup>C 1~5 Bytes
- 8. Press *Addressing Mode* to toggle between 7 and 10 bit addressing modes. 

9. Press *Data* from the side menu to edit the triggering data.

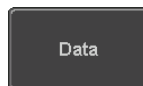

To edit the data, use the *Variable* knob to highlight a binary or hex digit and press *Select*. Use the *Variable* knob to choose a value for the digit and press *Select* to confirm.

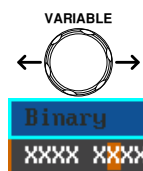

Binary      0,1,X (don't care)

Hex          0~F, X (don't care)

Trigger On -  
Address

If Address or Address/Data was configured for the Trigger On setting, then the triggering address must be configured.

10. Press *Address* on the bottom menu.



11. Press *Addressing Mode* to toggle between 7 and 10 bit addressing modes.



12. To choose a preset address as the default address, press *Choose Preset* and select a preset address.

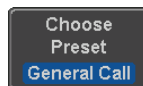

Address	Description
0000 000 0	General Call
0000 000 1	START Byte
0000 1XX X	Hs-mode
1010 XXX X	EEPROM
0000 001 X	CBUS

Press *Apply Preset* to set the default address to the preset.

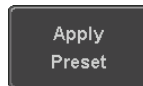

Note

Presets are not available for Trigger *On Address/Data*.

13. Press *Address* from the side menu to manually edit the triggering address.

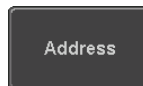

To edit the address, use the *Variable* knob to highlight a binary or hex digit and press *Select*. Use the *Variable* knob to choose a value for the digit and press *Select* to confirm.

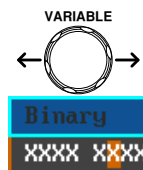

Binary      0,1, X (don't care)

Hex          0~F, X (don't care)

Direction

14. Press *Direction* on the bottom menu and choose the direction from the side menu.



Direction      Write, Read, Read or Write

## SPI Bus Trigger Settings

The SPI bus trigger conditions can be set at any time after the bus setting has been set to SPI.

Panel Operation 1. Set the Bus to SPI in the bus menu. Page 112

2. Press the *Trigger Menu* key.



3. Press *Type* from the bottom menu.



4. Press *Others* from the side menu and select *Bus*.

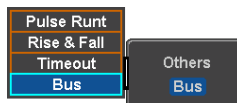

The Trigger on settings will be reflected on the Trigger Configuration icon.



From left: Bus trigger, Trigger source

5. Press *Trigger On* and select the triggering condition for the SPI bus.

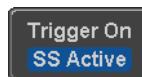

SPI SS Active, MOSI, MISO, MOSI&MISO

Trigger On – Data If MOSI, MISO or MISO/MOSI was configured for the Trigger On setting, then the number of words and the data can be configured.

6. Press *Data* from the bottom menu.





7. Press *Number of Words* from the side menu and choose the number of words for the data.



SPI            1~32 Words

8. Press *MOSI* or *MISO* from the side menu to edit the triggering data.



To edit the data, use the *Variable* knob to highlight a binary or hex digit and press *Select*. Use the *Variable* knob to choose a value for the digit and press *Select* to confirm.

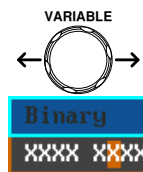

Binary        0,1,X (don't care)

Hex            0~F, X (don't care)

## CAN Bus Trigger

The CAN bus trigger conditions can be set at any time after the bus setting has been set to CAN.

Panel Operation 1. Set the Bus to CAN in the bus menu. Page 114

2. Press the *Trigger Menu* key.



3. Press *Type* from the bottom menu.



4. Select *Others* → *Bus* from the side menu. The Bus indicator appears at the bottom of the display.

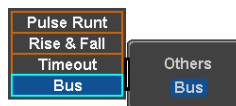

The Trigger on settings will be reflected on the Trigger Configuration icon.



From left: Bus trigger, Trigger source

5. Press *Trigger On* and select the triggering condition for the selected bus.



Trigger On Start of Frame, Type of Frame, Identifier, Data, Id & Data, End of Frame, Missing Ack, Bit Stuffing Err

Trigger On –Type of Frame 6. If *Type of Frame* was configured for the Trigger On setting, then the type of frame can be configured from the side menu.

Type Data Frame, Remote Frame, Error Frame, Overload Frame

Trigger On – Identifier

- If *Identifier/Id & Data* was configured for the Trigger On setting, select the format from the side menu.

Format      Standard, Extended

- Press *Identifier* from the side menu to set the identifier data.

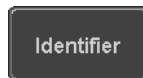

To edit the identifier, use the *Variable* knob to highlight a binary or hex digit and press *Select*. Use the *Variable* knob to choose a value for the digit and press *Select* to confirm.

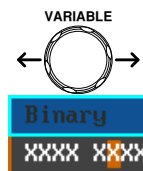

Binary      0,1,X (don't care)

Hex          0~F, X (don't care)

- Press *Direction* on the bottom menu and select the CAN Direction from the side menu.



CAN Direction    Write, Read, Read or Write

Trigger On - Data    If *Data/Id and Data* was configured for the Trigger On setting, then the triggering data must be configured.

- Press *Data* on the bottom menu.

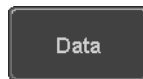

- Press *Number of Bytes* from the side menu and choose the number of bytes for the data.

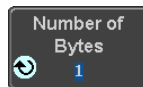

Bytes          1~8 Bytes

12. Press *Data* from the side menu to edit the triggering data.

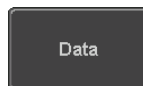

To edit the data, use the *Variable* knob to highlight a binary or hex digit and press *Select*. Use the *Variable* knob to choose a value for the digit and press *Select* to confirm.

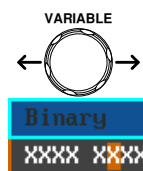

Binary      0,1,X (don't care)

Hex          0~F, X (don't care)

13. Press *Trigger When* from the side menu to choose the triggering condition for the data.

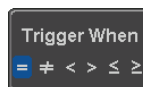

When        =, ≠, <, >, ≤, ≥

14. The bus will now trigger when the specified data matches the *Trigger When* conditions.

## LIN Bus Trigger

The LIN bus trigger conditions can be set at any time after the bus setting has been set to LIN.

---

Panel Operation 1. Set the Bus to LIN in the bus menu. Page 115

2. Press the *Trigger Menu* key.



3. Press *Type* from the bottom menu.



4. Select *Others* → *Bus* from the side menu. The Bus indicator appears at the bottom of the display.

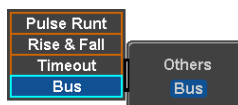

From left: Bus trigger, Trigger source

5. Press *Trigger On* and select the triggering condition for the selected bus.



Trigger On Sync, Identifier, Data, Id and Data, Wakeup Frame, Sleep Frame, Error.

---

Trigger On – Identifier

6. If *Identifier* or *Id & Data* was configured for the Trigger On setting, press *Identifier* from the bottom menu.

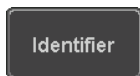

7. Press *Identifier* from the side menu to set the identifier data.

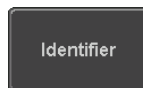

To edit the identifier, use the *Variable* knob to highlight a binary or hex digit and press *Select*. Use the *Variable* knob to choose a value for the digit and press *Select* to confirm.

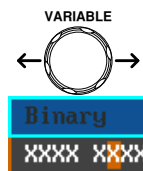

Binary      0,1,X (don't care)

Hex          0~F, X (don't care)

**Trigger On - Data**

If *Data/Id and Data* was configured for the *Trigger On* setting, then the triggering data must be configured.

8. Press *Data* on the bottom menu.



9. Press *Number of Bytes* from the side menu and choose the number of bytes for the data.

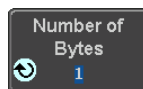

Bytes          1~8 Bytes

10. Press *Data* from the side menu to edit the triggering data.

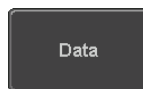

To edit the data, use the *Variable* knob to highlight a binary or hex digit and press *Select*. Use the *Variable* knob to choose a value for the digit and press *Select* to confirm.

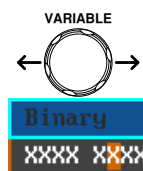

Binary      0,1,X (don't care)

Hex          0~F, X (don't care)

11. Press *Trigger When* from the side menu to choose the triggering condition for the data.

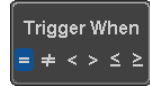

When      =, ≠, <, >, ≤, ≥

12. The bus will now trigger when the specified data matches the *Trigger When* conditions.

## Common Bus Trigger Settings

### Bus Trigger Mode

---

- Trigger Mode
1. Like the other trigger configurations, the Bus Trigger mode can be set to Auto (Untriggered Roll) and Normal.

2. Press *Mode* from the bottom menu to change the triggering mode.



3. Use the side panel to select *Auto* or *Normal* triggering modes.

Range      Auto, Normal

## System Settings and Miscellaneous Settings

This section describes how to set the interface, language, time/date, probe compensation signal, erase the internal memory and access useful QR codes.

### Select Menu Language

---

Description	The GDS-1000B has a number of different languages to choose from.
-------------	---

---

Panel Operation 1. Press the *Utility* key.

A dark grey, rounded rectangular button with the word "Utility" in white text.

2. Press *Language* on the lower menu.

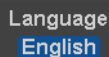
A dark grey, rounded rectangular button with a thin border. The word "Language" is in white text at the top, and "English" is in blue text below it.

3. Select the language\* from the side menu.

\*Language selections may differ based on region, and as such are not listed here.

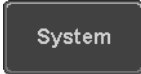

## View System Information

- Panel Operation
1. Press the *Utility* key. 
  2. Press *System* from the lower menu. 
  3. Press *System Info* from the side menu. A display panel will appear showing:
    - Manufacturer name
    - Model name
    - Serial number
    - Firmware version
    - Manufacturer URL



## Erase Memory

**Background**      The Erase Memory function will erase all internal waveforms, setup files and labels from internal memory.

**Erased Items**      Waveform 1~20, Setting memory 1~20, Reference 1~4, Labels

- Panel Operation
1. Press the *Utility* key. 

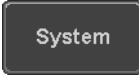
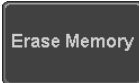
2. Press *System* from the lower menu. 
3. Press *Erase Memory* from the side menu. 

A message will prompt you to press *Erase Memory* again to confirm the process. Pressing any other key will cancel erasing the memory.

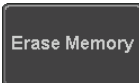
4. Press *Erase Memory* again. 

## Probe Compensation Frequency

---

**Background** The probe compensation output can be set from 1kHz (default) to 200kHz, in steps of 1kHz.

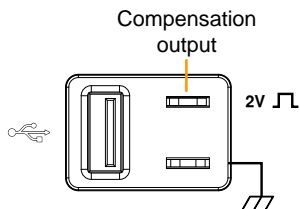

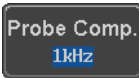
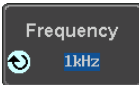
- |                                       |  |
|---------------------------------------|--|
| <b>Panel Operation/<br/>Parameter</b> | <ol style="list-style-type: none"> <li>1. Press the <i>Utility</i> key. </li> <li>2. Press <i>Probe Comp.</i> on the lower menu. </li> <li>3. Press <i>Frequency</i> and change the frequency of the probe compensation signal. </li> </ol> |
|---------------------------------------|--|

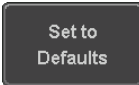
- |                          |  |
|--------------------------|--|
| <b>Default Frequency</b> | <ol style="list-style-type: none"> <li>4. Press <i>Set to Defaults</i> to set the frequency of the probe compensation signal to 1kHz default. </li> </ol> |
|--------------------------|--|

## QR Code Reader Function



---

**Background**      The QR Code reader function displays a number of preset QR codes that link to useful websites.

---

**QR Code Items**      • GW Instek website  
                                  • GW Instek contact window (marketing department)

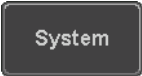
---

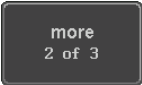
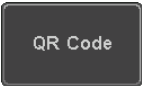
<b>Panel Operation/ Parameter</b>	<ol style="list-style-type: none"> <li>1. Press the <i>Utility</i> key.</li> </ol>	
	<ol style="list-style-type: none"> <li>2. Press <i>System</i> from the lower menu.</li> </ol>	
	<ol style="list-style-type: none"> <li>3. Press <i>More 1 of 3</i>, <i>More 2 of 3</i> from the side menu.</li> </ol>	  
	<ol style="list-style-type: none"> <li>4. Press <i>QR Code</i> from the side menu. There will be two pages of QR codes to choose from.</li> </ol>	

Press *Page 1* or *Page 2* to navigate to each page.



5. Use a QR code reader app on your smart phone or tablet to read one of the QR codes.

# A PPS

---

Applications.....	166
Overview.....	166
Running Applications .....	167
Using Go-NoGo .....	168
Remote Disk.....	173

# Applications

## Overview

**Background**      The APP function allows different software applications to be run. The GDS-1000B comes pre-installed with the Go-NoGo app and on 4 channel models the Mount Remote Disk app is also included.

Other optional applications can be downloaded from the GW Instek website free of charge.

For details on how to install or uninstall apps, please see page 235 for details.

<b>Included Applications</b>	<b>Go/No-Go</b>	The Go/No-Go application can be used to set threshold boundaries for input signals. Go/No-Go tests to see if a waveform will fit inside a user-specified maximum and minimum amplitude boundary (template).
------------------------------	-----------------	---

<b>Mount Remote Disk*</b>	This app allows the scope to mount a network share drive.
---------------------------	---



\* 4 channel models only.

<b>Optional Applications</b>	<b>Digital Filter</b>	Adds a digital low or high pass filter to any of the input channels. Each filter can have a user-defined cutoff frequency set.
------------------------------	-----------------------	--

DVM	The DVM application displays a digital voltage meter readout that floats on the top left-hand side of the screen.
Data Log	The Data Log app will log waveform data and/or screenshots at set intervals for set duration of time.

## Running Applications

Background	The APP function can host a number of different applications, some of which are pre-installed and some of which can be downloaded as optional extras.
------------	---

- Panel Operation
1. Press the *APP* key. 
  2. Press *APP* from the bottom menu. 
  3. Scroll through each application using the *Variable* knob.



Note: DVM, Datalog and Digital Filter apps are not installed by default.

4. Select an application by pressing the *Select* key *twice*. Select x2

## Using Go-NoGo

### Background

The Go-NoGo test checks if a waveform fits inside a user-specified maximum and minimum boundary. Boundary templates are automatically created from a source channel. Boundary tolerances and violation conditions can be set.

This application is pre-installed.

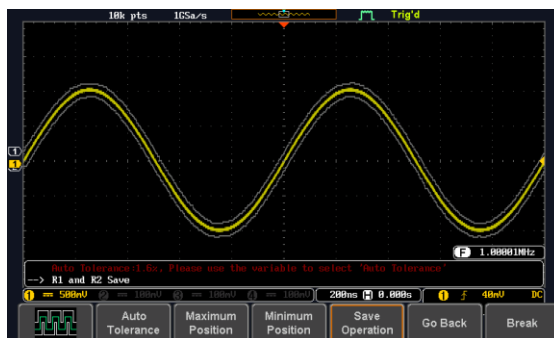

Choose the Go\_NoGo application from the APP menu. See page 167.

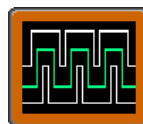

### Set Go-NoGo Conditions

Select the Go-NoGo conditions (NG When) and actions when a Go-NoGo condition has been met (Violating).

1. Press *NG When* from the bottom menu and select the NoGo conditions:

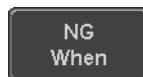



Enter

Enter: Sets the NoGo condition to when the input signal stays within the limit boundary.

Exit

Exit: Sets the NoGo condition to when the input signal exceeds the limit boundary.

2. Press *Go Back* to return to the previous menu.

Go Back

### Set Go-NoGo Actions

1. Press *Violating* to set what action to perform when a signal violates the Go-NoGo conditions.

Violating

Stop

The waveform stops when the conditions are violated.

Continue

Ignore violations and continue to monitor the signal. Each violation is counted.

2. Press *Go Back* to return to the previous menu.

Go Back

### Set Go-NoGo Source

1. Press *Compare Source* from the bottom menu to set the Go-NoGo boundary source.

Compare Source

CH1

Sets CH1 as the source.

CH2

Sets CH2 as the source.

CH3





Sets CH3 as the source.

CH4

Sets CH4 as the source.

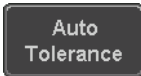
2. Press *Go Back* to return to the previous menu.

Go Back

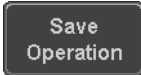
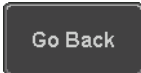
Set Boundary Tolerance	1. To set the Go-NoGo boundary tolerance, press <i>Reference Mode</i> .	
Auto Tolerance	2. To set the boundary tolerance as a percentage offset from the source waveform, press <i>Auto Tolerance</i> and use the Variable knob.	 
	Offset      0.4% ~ 40% (.4% steps)	
Maximum and Minimum Position	3. To manually set the template tolerance, press <i>Minimum Position</i> or <i>Maximum Position</i> and use the Variable knob to set the absolute minimum or maximum position.	 or 
	Range      Voltage division range	
Save Boundary Template	4. Press <i>Save Operation</i> to save the tolerance boundaries.	
	5. The Maximum Position tolerance will be saved to reference waveform R1, and the Minimum Position tolerance to R2.	
	6. Press <i>Go Back</i> to return to the previous menu.	

**Start Go-NoGo** Press *Enable* to start the Go-NoGo test. The Enable button will change to Disable. Pressing *Disable* will stop the Go-NoGo test and toggle the button back to Enable.

If the Violating setting was set to Stop, press *Enable* to restart the test after it has stopped.

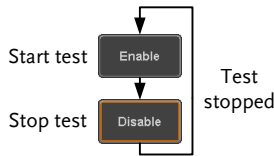

**Results** When Go-NoGo is running, the violation/test ratio is displayed in the bottom left-hand corner. The first digit represents the number of violations, and the right hand digit represents the number of tests.

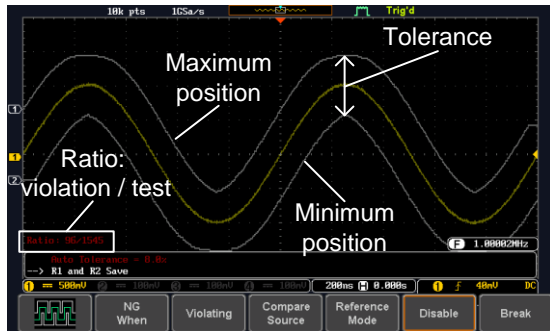

**Exit the Application**

To exit the application, press *Break*.

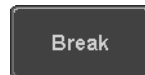

After you exit the Go/NoGo app, the boundary templates that were saved to R1 & R2 reference waveforms will still be turned on. See page 199 to turn the reference waveforms off.

**Using the Go-NoGo Output**

To output the Go-NoGo results to an external device, the Go-NoGo rear panel terminal (open collector) can be used. The Go-NoGo terminal will output a positive pulse each time a NoGo violation has occurred for a minimum of 500us. The voltage of the pulse depends on the external pull-up voltage.



**Timing Diagram**

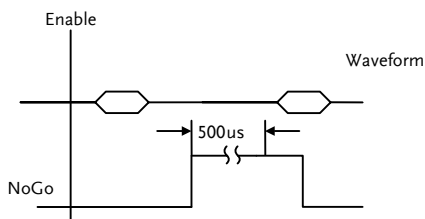

**Circuit Diagram**

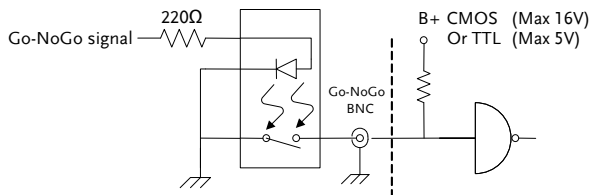

## Remote Disk

**Background**      The Remote Disk app allows the scope to mount a network share drive. This app is only included on 4 channel models.

Basic Features:

- Save and load files from the network share drive.
- Ability to automatically mount the network share drive at startup.

### Example

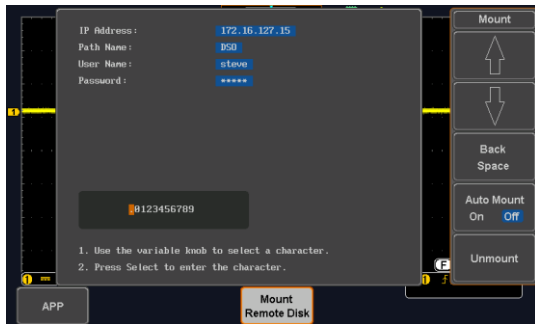

**Panel Operation**    1. Press the *APP* key.



2. Press *Mount Remote Disk* from the bottom menu.

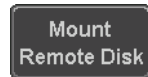

3. A form will appear (above) prompting you to enter the IP Address, Path Name, User Name and Password.
    - IP Address refers to the IP address of the network share drive.
    - Path Name refers to name of the shared directory of the network drive. This path must be in the root directory of the boot drive of the network disk. No sub-directories are allowed in the path name. For example a path name of “DSO” would be equivalent to C:/DSO.
    - User Name refers to a username with permission to access the share drive.
    - Password refers to the password for the username above.
    - Use the Up and Down soft-keys to navigate to each item in the form.
    - Use the Variable knob and Back Space soft-key to enter characters for each item in the form.
- 

- Mount/Unmount 4. To mount the network share driver, press *Mount* from the side menu. Press again to unmount.



When the drive is successfully mounted, “Complete!” will be shown on the display.

---

- Auto Mount 5. Press *Auto Mount* to automatically mount the network share drive at startup.

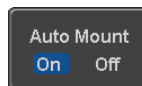

- Set File Path
6. When accessing the file utilities, the network share drive is shown as “Z” drive. Files can be saved to or recalled from the network share drive in the same manner as the internal memory or a USB flash disk. See the File Utilities chapter for usage details.
- Page 201

### Example

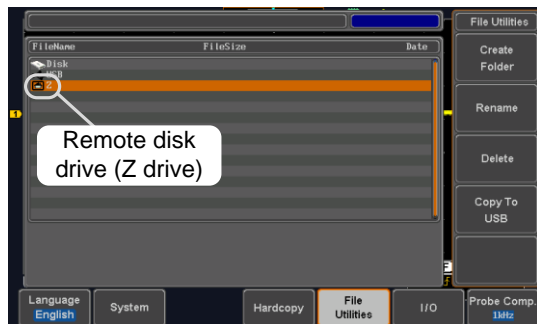

# SAVE/RECALL

---

File Format/Utility .....	177
Image File Format .....	177
Waveform File Format .....	177
Spreadsheet File Format .....	178
Setup File Format .....	180
Create/Edit Labels .....	182
Save .....	185
File Type/Source/Destination .....	185
Save Image .....	186
Save Waveform .....	189
Save Setup .....	191
Recall .....	193
File Type/Source/Destination .....	193
Recall Default Panel Setting .....	194
Recall Waveform .....	196
Recall Setup .....	197
Reference Waveforms .....	199
Recall and Display Reference Waveforms .....	199



## File Format/Utility

### Image File Format

---

Format	*.bmp or *.png
Default Filename	DSxxxx.bmp/png
Contents	The display image is 800 by 480 pixels. The background color can be inverted (Ink saver function). Each image file is saved to the current file path as a bitmap or PNG file.

### Waveform File Format

---

Format	DSxxxx.lsf, CH1~CH4.lsf	
	The LSF file format efficiently stores waveforms. This is the file format used for storing and recalling all waveforms that are used with the GDS-1000B series.	
Filename	DSxxxx.lsf, CH1 ~ CH4.lsf	
Waveform Type	CH1 ~ 4	Input channel signal
	REF	Reference waveform
	Math	Math operation result (page 67)
	All Displayed	Saves all the activated input channels or onscreen reference waveforms.
Storage Location	Wave1 ~ Wave20	Waveform files stored to the internal memory. Stored waveforms can be transferred to Ref. 1 ~ 4 to be viewed on the display. (W1 ~ W20 waveforms cannot be directly recalled on the display).

Ref 1~4 Reference waveforms stored in the internal memory, separate from W1 ~ W20. Reference waveforms (Ref 1 ~ 4) can be displayed directly onto the display with amplitude and frequency information. Ref 1~4 are useful for reference purposes. Other waveforms (LSF and W1~20) must be recalled to R1~4 before being displayed.

---

Contents: The waveform data can be used for detailed  
Waveform Data analysis. It consists of the horizontal and vertical data used by the waveform.

## Spreadsheet File Format

---

Format \*.csv (Comma-separated values format, can be opened in spreadsheet applications such as Microsoft Excel).

CSV-formatted files can be stored in either a short-memory format or a long-memory format: Detail CSV, Fast CSV. The number of points that are saved depends on the record length settings.

Detail CSV will record both the horizontal and vertical sample points of the waveform. All the points are recorded in scientific notation for analog data.

Fast CSV will only record the vertical amplitude of the sample points. Fast CSV also contains data that enables the horizontal data points to be reconstructed, such as trigger position, etc. Data is recorded as integers.

Note, however, that only fast CSV can be recalled to the internal memory. Detailed CSV cannot be recalled.

---

Filename DSxxxx.csv

---

---

Waveform Type	CH1 ~ 4	Input channel signal
	Ref1 ~ 4	Reference waveform
	Math	Math operation result (page 67)

---

Contents:  
Detail CSV

Detail CSV waveform data contains channel information such as vertical and horizontal position of a signal for all the recorded points.

The following information is included in Detail CSV, where applicable:

- Format (scope type)
  - Trigger Level
  - Label
  - Vertical units
  - Vertical position
  - Horizontal scale
  - Horizontal mode
  - Firmware
  - Mode
  - Horizontal data
  - Memory length
  - Source
  - Probe ratio
  - Vertical scale
  - Horizontal units
  - Horizontal position
  - Sampling period
  - Time
  - Vertical data
- 

Contents:  
Fast CSV

The following information is included in the Fast CSV waveform files, where applicable:

- Format (scope type)
- IntpDistance (input trigger distance)
- Trigger level
- Vertical units
- Vertical units extend div
- Probe type
- Memory length
- Trigger address
- Source
- Vertical units div
- Label
- Probe ratio

- Vertical scale
- Horizontal units
- Horizontal position
- SincET mode (sampling mode)
- Horizontal old scale
- Firmware
- Mode
- Vertical position
- Horizontal scale
- Horizontal mode
- Sampling period
- Horizontal old position
- Time
- Raw vertical waveform data

### Setup File Format

Format	DSxxxx.set (proprietary format) The setup file saves or recalls the following settings.		
Contents	Acquire	<ul style="list-style-type: none"> <li>• Mode</li> <li>• Sample rate</li> <li>• XY</li> </ul>	<ul style="list-style-type: none"> <li>• Sample mode</li> <li>• Record Length</li> </ul>
	Display	<ul style="list-style-type: none"> <li>• Mode</li> <li>• Persistence</li> <li>• Waveform intensity</li> <li>• Graticule intensity</li> </ul>	<ul style="list-style-type: none"> <li>• Backlight intensity</li> <li>• Graticule</li> <li>• Backlight</li> <li>• Auto-dim</li> </ul>
	Channel	<ul style="list-style-type: none"> <li>• Scale</li> <li>• Channel</li> <li>• Coupling</li> <li>• Impedance</li> <li>• Invert</li> <li>• Bandwidth</li> </ul>	<ul style="list-style-type: none"> <li>• Expand</li> <li>• Position</li> <li>• Probe</li> <li>• Probe attenuation</li> <li>• Deskew</li> </ul>

Cursor	<ul style="list-style-type: none"> <li>• Horizontal cursor</li> <li>• H Unit</li> </ul>	<ul style="list-style-type: none"> <li>• Vertical cursor</li> <li>• V Unit</li> </ul>
Measure	<ul style="list-style-type: none"> <li>• Source</li> <li>• Gating</li> <li>• Statistics</li> </ul>	<ul style="list-style-type: none"> <li>• Display</li> <li>• High-Low</li> <li>• Reference levels</li> </ul>
Horizontal	<ul style="list-style-type: none"> <li>• Scale</li> </ul>	
Math	<ul style="list-style-type: none"> <li>• Source1</li> <li>• Operator</li> <li>• Source2</li> </ul>	<ul style="list-style-type: none"> <li>• Position</li> <li>• Unit/Div</li> <li>• Math Off</li> </ul>
FFT Math	<ul style="list-style-type: none"> <li>• Source</li> <li>• Vertical Units</li> <li>• Window</li> </ul>	<ul style="list-style-type: none"> <li>• Vertical position</li> <li>• Horizontal position</li> </ul>
Advanced Math	<ul style="list-style-type: none"> <li>• Expression</li> <li>• VAR1</li> <li>• VAR2</li> </ul>	<ul style="list-style-type: none"> <li>• Position</li> <li>• Unit/Div</li> </ul>
Trigger	<ul style="list-style-type: none"> <li>• Type</li> <li>• Source</li> <li>• Coupling</li> <li>• Alternate</li> <li>• Rejection</li> <li>• Noise Rejection</li> </ul>	<ul style="list-style-type: none"> <li>• Slope</li> <li>• Level</li> <li>• Mode</li> <li>• Trigger When</li> <li>• Timer</li> <li>• Holdoff</li> </ul>
Utility	<ul style="list-style-type: none"> <li>• Language</li> <li>• Hardcopy key</li> <li>• File Format</li> </ul>	<ul style="list-style-type: none"> <li>• Ink Saver</li> <li>• Assign Save</li> <li>• Probe Comp.</li> </ul>
Save/ recall	<ul style="list-style-type: none"> <li>• Image file format</li> </ul>	<ul style="list-style-type: none"> <li>• Data file format</li> </ul>

## Create/Edit Labels

**Overview** Reference files, Setup files and the analog input channels can have individual file labels set.

For the analog channels and reference waveforms, the file label can be displayed next to the channel/reference indicator.

The file labels are also used to easily identify reference files, setup files or channels when saving or recalling waveforms and setups.

### Example

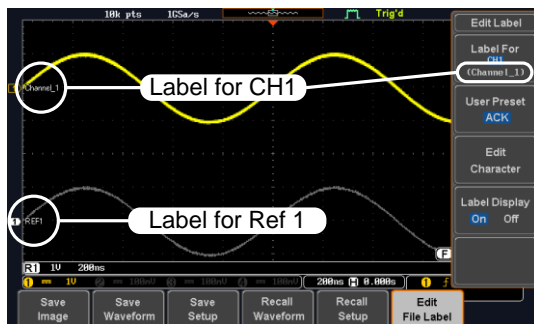

In the example above, the file label for channel 1 is displayed next to the channel indicator and is also displayed in the *Edit Label* menu. The Ref\_1 file label is shown next to the reference indicator.

### Panel Operation

1. Press the *Save/Recall* key from the front panel.
2. Press *Edit File Label* from the bottom menu.
3. Press *Label For* and select the item that you want to create the label for.

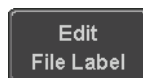

Label For CH1~CH4, Ref1~4, Set1~20, Math

- To choose a preset label, Press *User Preset* from the side menu and choose a label.



Labels ACK, AD0, ANALOG, BIT, CAS, CLK, CLOCK, CLR, COUNT, DATA, DTACK, ENABLE, HALT, INT, IN, IRQ, LATCH, LOAD, NMI

Edit Label

- Press *Edit Character* to edit the current label.

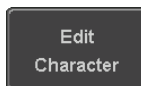

- The Edit Label window appears.

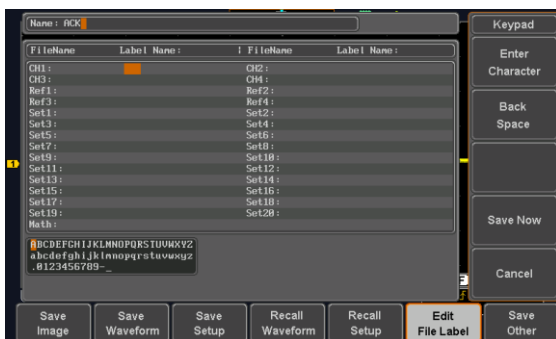

- Use the Variable knob to highlight a character.



Press *Enter Character* to select a number or letter.

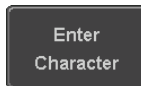

Press *Back Space* to delete a character.



Press *Save Now* to save the label and return to the previous menu.



To cancel the editing the label and return to the previous menu, press *Cancel*.

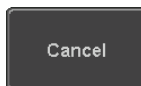

---

#### Display Label

To display the currently selected file label on the screen next to its respective indicator, toggle *Label Display* to On.

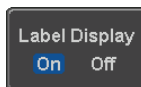

Conversely, if you want to remove the currently selected file label from the display, toggle *Label Display* to Off.



## Save

### File Type/Source/Destination

Item	Source	Destination
Panel Setup (DSxxxx.set)	<ul style="list-style-type: none"> <li>• Front panel settings</li> </ul>	<ul style="list-style-type: none"> <li>• Internal memory: Set1 ~ Set20</li> <li>• File system: Disk, USB</li> </ul>
Waveform Data (DSxxxx.csv) (DSxxxx.lsf) (CH1~CH4.lsf, Ref1~Ref4.lsf, Math.lsf)* ALLxxxx.csv	<ul style="list-style-type: none"> <li>• Channel 1 ~ 4</li> <li>• Math operation result</li> <li>• Reference waveform Ref1~4</li> <li>• All displayed waveforms</li> </ul>	<ul style="list-style-type: none"> <li>• Internal memory: Reference waveform Ref1~4, Wave1 ~ Wave20</li> <li>• File system: Disk, USB</li> </ul>
Display Image (DSxxxx.bmp/png) (Axxx1.bmp/png)**	<ul style="list-style-type: none"> <li>• Display image</li> </ul>	<ul style="list-style-type: none"> <li>• File system: Disk, USB</li> </ul>

\*Stored in ALLXXXX directories when All Displayed waveforms are saved.

\*\*Stored in ALLXXXX directories when the Hardcopy key is assigned to save Waveform, Setup or All.



Note

By default all filenames/directories are named DSxxxx/ALLxxxx where xxxx is a number starting from 0001 and is incremented by one after each save.

## Save Image

Images can be saved either using the Save/Recall key or by using the Hardcopy key. To save images using the Hardcopy key, see the hardcopy section on page 208.

Panel Operation 1. To save to USB, connect a USB Front Panel

drive to the front panel USB port. If a USB drive is not connected, images can still be saved to the internal memory.

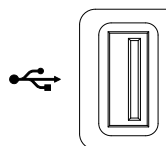

2. Press the *Save/Recall* key from the front panel.



3. Press *Save Image* from the bottom menu.



4. Press *File Format* to choose PNG or BMP file types.

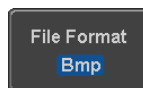

Range DSxxxx.bmp, DSxxxx.png

5. Press *Ink Saver* to toggle Ink Saver On or Off.

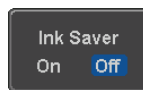

**Ink Saver On**

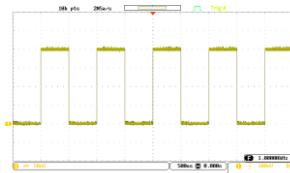

**Ink Saver Off**

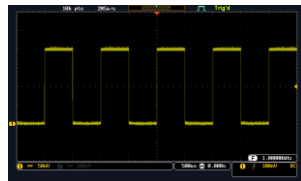

6. Press *Save* from the side menu to save the display as an image file.



7. You will automatically be taken to a file utility where you will be able to edit the name of the file.

8. To edit the file name, use the *Variable* knob to highlight a character.



Press *Enter Character* or the *Select* key to select a number or letter.

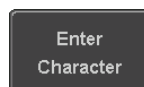

Press *Back Space* to delete a character.



9. Press *Save Now* to save the file. The file name need not have been edited to save the file.

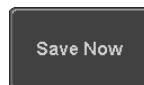

Note: Pressing *Cancel* will cancel the save operation and return you to the Save/Recall menu.

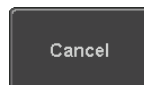

After *Save Now* has been pressed the file will be saved.

Image saved to USB :/DS0197.BMP.



Note

The file will not be saved if the power is turned off or the USB drive is taken out before the message ends.

**File Utility**

To edit the internal memory or the USB flash drive contents (create/delete/rename files and folders) or to edit the default file path, press *File Utilities* from the side menu. See page 201 for details.

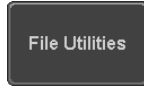

## Save Waveform

- Panel Operation
- To save to an external USB flash drive, connect the drive to the front panel USB port. If a USB drive is not connected, files can still be saved to the internal memory.

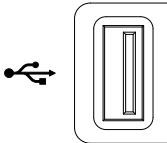

  - Press the *Save/Recall* key from the front panel.

  - Press *Save Waveform* from the bottom menu.

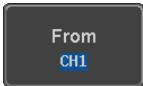
  - Choose the *From* waveform on the side menu.



Source                      CH1~4, Math, Ref1~4, All Displayed
  - Press *To* (internal memory) or *To File* and choose a destination to save.



To                      Ref1~4, Wave1~20

To File              Format: LSF, Detail CSV, Fast CSV
  - Press *Save* to save the file.

  - If you are saving to a file, a file utility appears where you will be able to edit the name of the file from the default "DSXXX" filename.

- To edit the filename, use the *Variable* knob to highlight a character.



Press *Enter Character* or the *Select* key to select a number or letter.

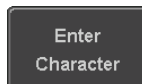

Press *Back Space* to delete a character.

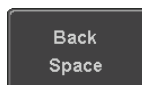

- Press *Save Now* to save the file. The filename need not have been edited to save the file.



Note: Pressing *Cancel* will cancel the save operation and return you to the *Save/Recall* menu.

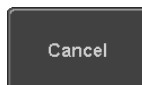

After *Save Now* has been pressed the file will be saved.



Note

The file will not be saved if the power is turned off or the USB drive is taken out before the message ends.

File Utility

To edit the internal memory or the USB flash drive contents (create/delete/rename files and folders), press *File Utilities*. For details, see page 201.

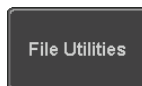



## Save Setup

- Panel Operation
- To saving to an external USB flash drive connect the drive to the front or rear panel USB port. If a USB drive is not connected, files can be saved to the internal memory.

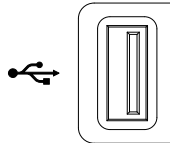
Front Panel



  - Press the *Save/Recall* key from the front panel.



  - Press *Save Setup* from the bottom menu.

  - Press *To* (internal memory) or *To File* and choose a destination to save to.

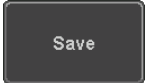

To	Set1~Set20
To File	DSxxxx.set
  - Press *Save* to confirm saving. When completed, a message appears at the bottom of the display.

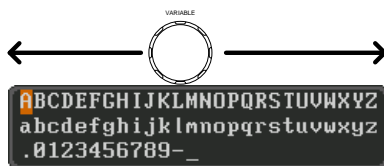
  - If you are saving to a file, a file utility appears where you will be able to edit the name of the file from the default "DSxxxx" filename.
  - To edit the filename, use the *Variable* knob to highlight a character.



Press *Enter Character* or the *Select* key to select a number or letter.

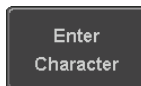

Press *Back Space* to delete a character.



8. Press *Save Now* to save the file. The filename need not have been edited to save the file.

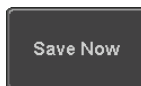

Note: Pressing *Cancel* will cancel the save operation and return you to the *Save/Recall* menu.

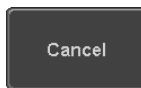

After *Save Now* has been pressed the file will be saved.



Note

The file will not be saved if the power is turned off or the USB drive is taken out before the message ends.

File Utility

To edit the internal memory or the USB flash drive contents (create/delete/ rename files and folders) or to set the file path, press *File Utilities*. For details, see 201.

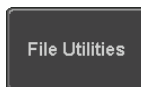

Edit Label

To edit labels for Setup files, press *Edit Label*. For more details on editing labels, see page 182.

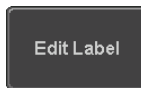



## Recall

### File Type/Source/Destination

Item	Source	Destination
Default Panel Setup	<ul style="list-style-type: none"> <li>Factory installed setting</li> </ul>	<ul style="list-style-type: none"> <li>Current front panel</li> </ul>
Reference Waveform	<ul style="list-style-type: none"> <li>Internal memory: Ref1~4</li> </ul>	<ul style="list-style-type: none"> <li>Current front panel</li> </ul>
Panel Setup (DSxxx.set)	<ul style="list-style-type: none"> <li>Internal memory: S1 ~ S20</li> <li>File system: Disk, USB</li> </ul>	<ul style="list-style-type: none"> <li>Current front panel</li> </ul>
Waveform Data (DSxxx.lsf, DSxxx.csv**, (CH1~CH4.lsf, Ref1~Ref4.lsf, Math.lsf)*	<ul style="list-style-type: none"> <li>Internal memory: Wave 1 ~ Wave20</li> <li>File system: Disk, USB</li> </ul>	<ul style="list-style-type: none"> <li>Reference waveform 1 ~ 4</li> </ul>

\*Recalled from ALLXXX directories. Note that Allxxx.csv cannot be recalled to the oscilloscope.

\*\*Detail CSV files cannot be recalled to the oscilloscope.

## Recall Default Panel Setting

Panel Operation 1. Press the *Default* key.



2. The screen will update with the default panel settings.

Setting Contents The following is the default (factory) setting contents.

Acquire	Mode: Sample	XY: OFF
	Record Length: 10k	Expand: By Center
Display	Mode: Vector	Persistence: 240ms
	Waveform intensity: 50%	Graticule intensity: 50%
	Backlight Intensity: 80%	Backlight Auto-dim: On
	Time: 10min	Graticule: full 
Channel	Scale: 100mV/Div	CH1: On
	Coupling: DC	Impedance: 1MΩ
	Invert: Off	Bandwidth: full
	Expand: By Ground	Position: 0.00V
	Probe: Voltage	Probe attenuation: 1x
	Deskew: 0s	
Cursor	Horizontal cursor: Off	Vertical Cursor: Off
Measure	Source: CH1	Gating: Screen
	Display All: Off	High-Low: Auto
	Statistics: Off	Mean & Std Dev
		Samples: 2
	High Ref: 90.0%	Mid Ref: 50.0%
	Low Ref: 10.0%	

Horizontal	Scale: 10us/Div	Position: 0.000s
Math	Source1: CH1	Operator: +
	Source2: CH2	Position: 0.00 Div
	Unit/Div: 200mV	Math Off
FFT	Source: CH1	Vertical Units: dBV RMS
	Window: Hanning	Vertical: 20dB
	Horizontal:5MHz/div	
Advanced Math	Expression: CH1+CH2	VAR1: 0
	VAR2: 1	Position: 0.00Div
	Unit/div: 500mV	
APP	App: Go-NoGo, Mount Remote Disk	
Trigger	Type: Edge	Source: CH1
	Coupling: DC	Alternate: Off
	Noise Rejection: Off	Slope: Positive
	Level: 0.00V	Mode: Auto
	Holdoff: 10.0ns	
Utility	Hardcopy: Save	Ink Saver: Off
	Assign Save To: Image	File Format: Bmp
	Probe Comp.: 1kHz	

## Recall Waveform

Panel Operation

1. For recalling from an external USB flash drive, connect the drive to the front or rear panel USB port.

Front Panel

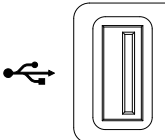

2. The waveform must be stored in advance. See page 189 for waveform store details.

3. Press the *Save/Recall* key.



4. Press *Recall Waveform* from the bottom menu. The Recall menu appears.

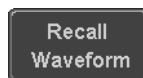

5. Press *From* (internal memory) or *From File* and choose a source to recall from.

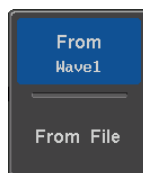

From Wave1~20

From File\* File format: Lsf, Fast Csv

\*Only files in the current file path will be available, this includes files saved in the ALLxxxx directories.

Allxxxx.csv files cannot be recalled to the oscilloscope.

Only the "Fast CSV", "LSF" files can be recalled to the oscilloscope.

6. Press *To* and select the reference waveform to recall to.

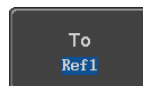

To                      Ref1~4

7. Press *Recall Now* to recall the waveform. The reference waveform will appear on the screen when successful.

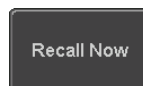

#### File Utility

To edit USB flash drive contents (create/ delete/ rename files and folders) or to set the file path, press *File Utilities*. For details, see page 201.

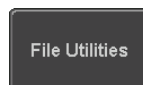

## Recall Setup

---

- Panel Operation 1. (For recalling from an external USB flash drive) Connect the drive to the front or rear panel USB port.

Front Panel

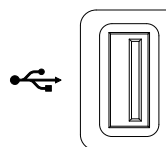

2. Press the *Save/Recall* key.



3. Press *Recall Setup* from the bottom menu.

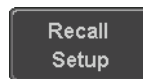

4. Press *From* (internal memory) or *From File* and choose a source to recall from.

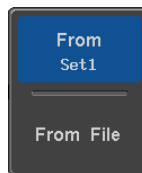

From Set1~20

From File DSxxxx.set (USB, Disk)\*

\* Only files in the current file path will be available.

5. Press *Recall Now* to confirm recalling. When completed, a message appears at the bottom of the display.

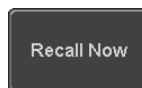

Note

The file will not be recalled if the power is turned off or the USB drive is taken out before the message appears.

File Utility

To edit the internal memory or the USB flash drive contents (create/ delete/ rename files and folders) or to set the file path, press *File Utilities*. For details, see page 201.

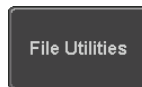

Edit Label

To edit labels for Setup files, press *Edit label*. For more details on editing labels, see page 182.

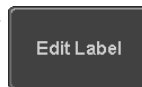

# Reference Waveforms

## Recall and Display Reference Waveforms

**Panel Operation** A reference waveform must be stored in advance. See page 189 to store waveforms as reference waveforms.

1. Press the REF key on the front panel.



2. Pressing R1~R4 repeatedly will toggle the corresponding reference waveform OFF/ON.



Turning R1~R4 ON will open the corresponding reference menu.

3. If a reference waveform is ON but not active, its reference menu can be opened by pressing the corresponding R1~R4 key from the bottom menu.

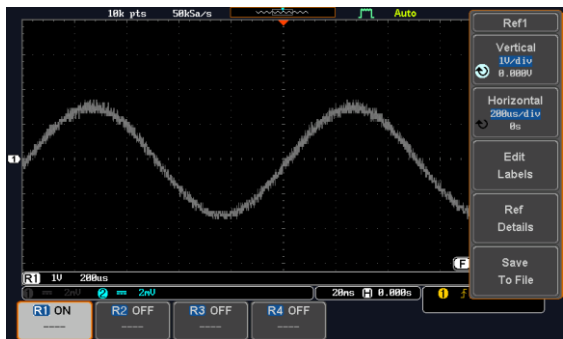

**Vertical Navigation**      Press *Vertical* repeatedly from the side menu to choose to edit the vertical position or Unit/Div. Use the Variable knob to edit the values.

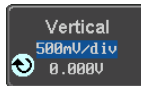

**Horizontal Navigation**      Press *Horizontal* repeatedly from the side menu to choose to edit the Time/Div or the horizontal position. Use the Variable knob to edit the value.



**View Reference Waveform Details**      Pressing *Ref Details* will display the reference waveform details.

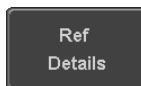

Details:      Sample Rate, Record Length, Date



**Edit Labels**      To edit labels for Setup files, press *Edit Labels*. For more details on editing labels, see page 182.

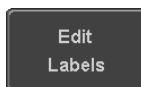

**Save Reference Waveforms**      To save reference waveforms, press *Save to File*. For more details on saving waveforms, see page 189.

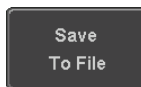



# FILE UTILITIES

The file utilities are used each time files need to be saved to internal or external memory. The file utilities can create directories, delete directories, rename files as well as copy files from internal memory to USB. The File Utilities menu also sets the file path for saving and recalling files from the Save/Recall menu.

---

File Navigation.....	202
Create Folder.....	204
Rename File.....	205
Delete File or Folder.....	206
Copy File to USB.....	207

## File Navigation

The File Utilities menu can be used to choose files or to set the file path for saving/recalling files.

### File System

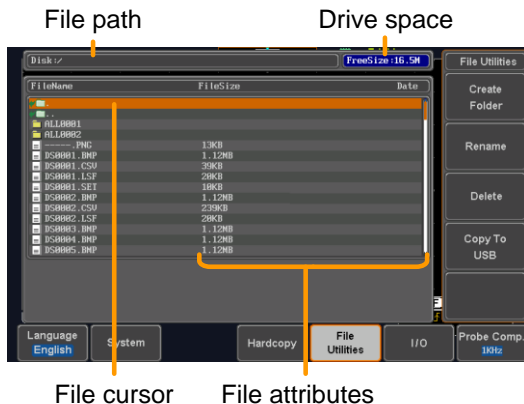

### Panel Operation

1. Press the *Utility* key.
2. Press *File Utilities* from the bottom menu.

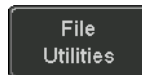

3. The file system appears.



4. Use the *Variable* knob to move the file cursor up and down.

Use the *Select* key to choose a file or directory or to set the file path.

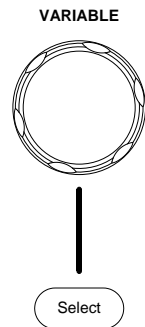

- When a USB flash drive is used, the file path is remembered each time the USB flash drive is used. This saves you the hassle of setting the USB file path each time the USB flash drive is inserted into the scope.

## Create Folder

Panel Operation 1. Press the *Utility* key.



2. Press *File Utilities* from the bottom menu.

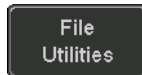

3. Use the *Variable* knob and *Select* key to navigate the file system.

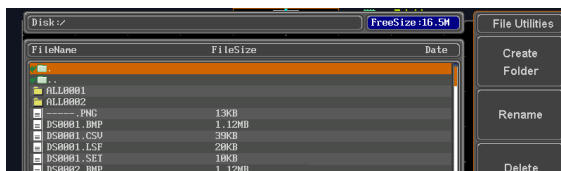

Create Folder 4. Press *Create Folder* to make a new directory at the selected location.

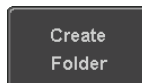

5. Use the *Variable* knob to highlight a character.



Press *Enter Character* or the *Select* key to select a number or letter.

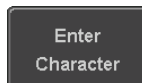

Press *Back Space* to delete a character.



6. Press *Save Now* to create the folder.



Cancel

Press *Cancel* to cancel the operation.

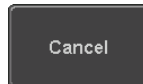

## Rename File

---

Panel Operation

1. Press the Utility key.



2. Press *File Utilities* from the bottom menu.

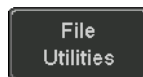

3. Use the Variable knob and select key to choose a file to rename.

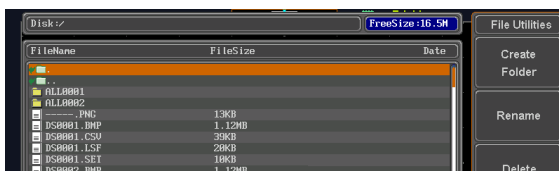

4. Press *Rename* when a file is chosen.

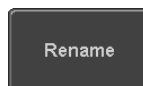

5. Use the *Variable* knob to highlight a character.



Press *Enter Character* or the *Select* key to select a number or letter.

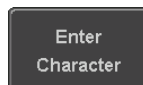

Press *Back Space* to delete a character.



- Press *Save Now* to rename the folder or file.



## Delete File or Folder

---

- Panel Operation
- Press the *Utility* key.



- Press *File Utilities* from the bottom menu.



- Use the Variable knob and select key to navigate the file system to choose a file.

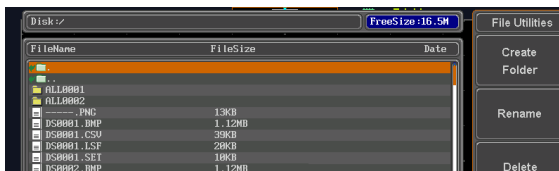

- Press *Delete* to delete the selected file.



- Press *Delete* again to confirm the deletion.



## Copy File to USB

Panel Operation 1. Connect a USB drive to the front panel USB port.

Front Panel

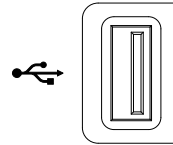

2. Press the *Utility* key.



3. Press *File Utilities* from the bottom menu.

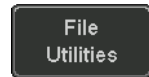

4. Use the *Variable* knob and *Select* key to navigate the file system to choose a file from internal memory.

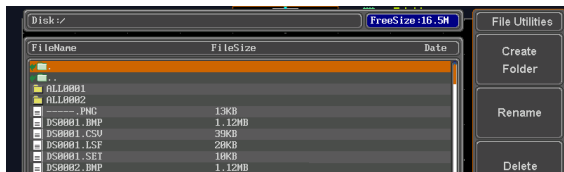

5. Press *Copy To USB* to copy the selected file to the USB drive.



If the same file name already exists on the USB drive, it will be copied over.

# HARDCOPY KEY

The Hardcopy key is used as quick-save or quick-print key. The Hardcopy key can be assigned either to printout screenshots or to save files.

When assigned to “Print” the screen image can be printed to a PictBridge compatible printer using the USB device port. To reduce the amount of printer ink used for each print, images can be printed using the Ink Saver function.

When assigned to “Save”, pressing the Hardcopy key can be used to save a screen shot, a waveform, or the current setup, depending on the configuration.

## Printer I/O Configuration

---

- Panel Operation
1. Connect a PictBridge printer to the USB device port on the rear panel.

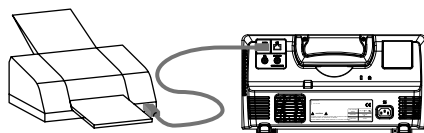



2. Press the *Utility* key.
3. Press *I/O* from the bottom menu.
4. Press *USB Device Port* from the side menu and select *Printer*.

UtilityI/OUSB Device Port  
Printer

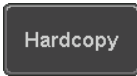
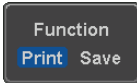

### Print Output

Ensure the USB port has been configured for the printer and the printer is connected to the scope before trying to print, see page 208.

- |                 |   |  |
|-----------------|---|--|
| Panel Operation | 1. Press the <i>Utility</i> key.  |                     |
|                 | 2. Press <i>Hardcopy</i> from the bottom menu.                                  |                     |
|                 | 3. On the side menu, press <i>Function</i> and select <i>Print</i> .            |                     |
|                 | 4. Press the <i>Hardcopy</i> key to print.<br>The display image is printed out. | <b>HARDCOPY</b><br> |

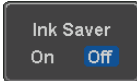
Ink Saver	To have a white background on the printed display image, set <i>Ink Saver</i> to On.	
-----------	--	---

**Ink Saver On**

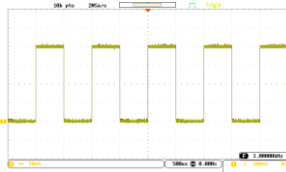

**Ink Saver Off**

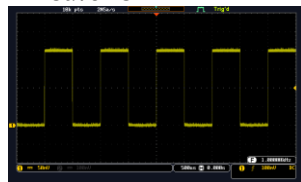



## Save - Hardcopy Key

**Background** When the Hardcopy key is assigned to “Save”, pressing the Hardcopy key can be used to save a screen shot, a waveform, or the current setup, depending on the configuration.

- Panel Operation**
1. If you wish to save to USB, connect a USB drive to the front panel USB port, otherwise the file will save to internal memory.
 

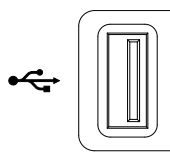
Front

  2. Press the *Utility* key.
 

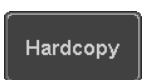

  3. Press *Hardcopy* from the bottom menu.
 

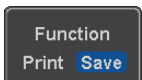
  4. On the side menu, press *Function* to select Save.
 

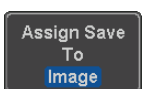
  5. Press *Assign Save To* and select which type of file will be saved when the Hardcopy key is pressed.
 



File Type: Image, Waveform, Setup, All
  6. Press the *Hardcopy* key to save the file\*.
 

- A message will appear when the save is successful.

**Image saved to USB :/DS0197.BMP.**

Image File  
Format

1. For image files the file format can be selected with the *File Format* key.

Format: BMP, PNG



File Format  
Bmp

Ink Saver

2. To have a white background for image files, set *Ink Saver* to On.



Ink Saver  
On Off

Ink Saver On

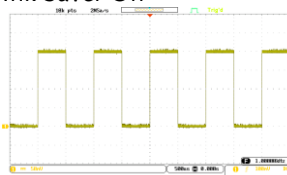

Ink Saver Off

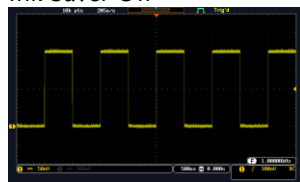

Note

\*Each time the Hardcopy key is used to save waveforms or setup files, the files are saved into a new directory each time. The save directory is labeled ALLXXXX, where XXXX is a number that is incremented with each save. This directory is created in either the internal memory or to a USB flash drive.

# **R**EMOTE CONTROL **CONFIG**

This chapter describes basic configuration for remote control. For a command list, refer to the programming manual downloadable from GWInstek website, [www.gwinstek.com](http://www.gwinstek.com)



---

Interface Configuration .....	213
Configure USB Interface .....	213
USB Functionality Check .....	214
Configure the Ethernet Interface .....	215
Configure Socket Server .....	217
Socket Server Functionality Check .....	218

## Interface Configuration

### Configure USB Interface

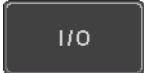
USB Configuration	PC side connector	Type A, host
	GDS-1000B side connector	Type B, device
	Speed	1.1/2.0
	USB Class	CDC (communications device class)

- Panel Operation
1. Press the Utility key. 
  2. Press I/O from the bottom menu. 
  3. Press *USB Device Port* from the side menu and select *Computer*. 
  4. Connect the USB cable to the rear panel device port. 
  5. When the PC asks for the USB driver, select the USB driver included on the accompanying User Manual CD or download the driver from the GW Instek website, [www.gwinstek.com](http://www.gwinstek.com), in the GDS-1000B Download section. The driver automatically sets the GDS-1000B as a serial COM port (Shown as VPO in the PORTS node of the Windows Device Manager).

## USB Functionality Check

Terminal Application

Invoke a terminal application such as RealTerm.

Set the COM port, baud rate, stop bit, data bit, and parity accordingly.

To check the COM port number and associated port settings, see the Device Manager in the PC. For Windows 7:

*Control panel → Hardware and Sound → Device Manager*

Example: Configuring RealTerm:

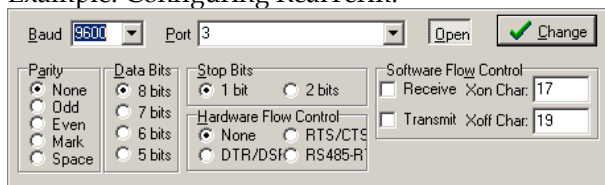

Functionality Check

Key in this query command via the terminal application.

`*idn?`

This should return the Manufacturer, Model number, Serial number, and Firmware version in the following format.

*GW,GDS-1072B,PXXXXXX,V1.00*



Note



For further details about remote control and remote commands, please see the GDS-1000B programming manual, available on the GW Instek website.

## Configure the Ethernet Interface

Ethernet Configuration	MAC Address	Domain Name
	Instrument Name	DNS IP Address
	User Password	Gateway IP Address
	Instrument IP Address	Subnet Mask
		HTTP Port 80 (fixed)

**Background** The Ethernet interface is used for remote control using a socket server connection. For details, please see the Socket Server section on page 217.

The Ethernet interface is only available on the 4 channel models (GDS-1054B, GDS-1074B, GDS-1104B).

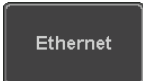
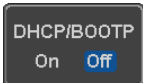
- |                 |   |   |
|-----------------|---|---|
| Panel Operation | 1. Connect the Ethernet cable to the LAN port on the rear panel.        |    |
|                 | 2. Press the <i>Utility</i> key.  |    |
|                 | 3. Press <i>I/O</i> from the bottom menu.                               |   |
|                 | 4. Press <i>Ethernet</i> from the side menu.                            |  |
|                 | 5. Set <i>DHCP/BOOTP</i> to <i>On</i> or <i>Off</i> from the side menu. |  |



Note

IP addresses will automatically be assigned with DHCP/BOOTP set to on. For Static IP Addresses, DHCP/BOOTP should be set to off.

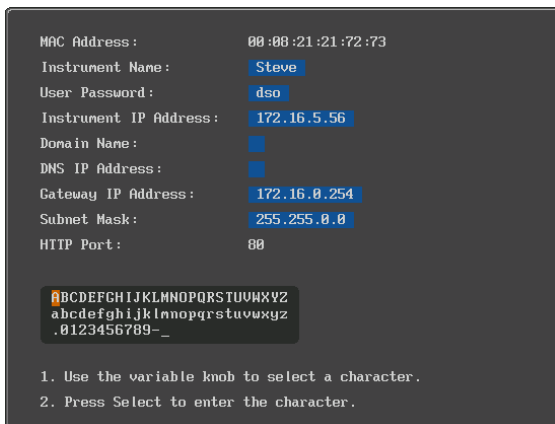

6. Use the *Up* and *Down* arrows on the side menu to navigate to each Ethernet configuration item.

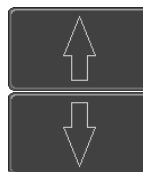

Items      MAC Address, Instrument Name, User Password, Instrument IP Address, Domain Name, DNS IP Address, Gateway IP Address, Subnet Mask

Note: HTTP Port is fixed at 80.

7. Use the *Variable* knob to highlight a character and use the *Select* key to choose a character.

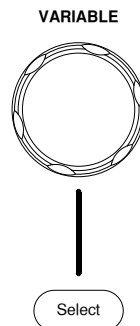



Press *Backspace* to delete a character.

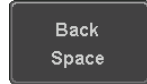

Press *Save Now* to save the configuration. Complete will be displayed when successful.



## Configure Socket Server

The GDS-1000B supports socket server functionality for direct two-way communication with a client PC or device over LAN. By default, the Socket Server is off.

Configure Socket Server 1. Configure the IP address for the GDS-1000B. Page 215

2. Press the *Utility* key.



3. Press *I/O* from the bottom menu.

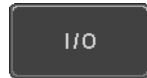

4. Press *Socket Server* from the side menu.

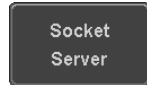

5. Press *Select Port* and choose the port number with the Variable knob.

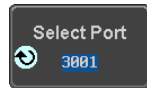

Range 1024~65535

6. Press *Set Port* to confirm the port number.

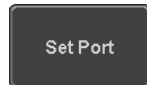

7. The Current Port icon will update to the new port number.



8. Press *Server* and turn the socket server On.

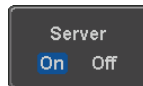

## Socket Server Functionality Check

---

NI Measurement and Automation Explorer To test the socket server functionality, National Instruments Measurement and Automation Explorer can be used. This program is available on the NI website, [www.ni.com](http://www.ni.com).

- |           |   |
|-----------|---|
| Operation | <ol style="list-style-type: none"> <li>1. Configure the IP address for the GDS-1000B. <span style="float: right;">Page 215</span></li> <li>2. Configure the socket port. <span style="float: right;">Page 217</span></li> <li>3. Start the NI Measurement and Automation Explorer (MAX) program. Using Windows, press:</li> </ol> |
|-----------|---|



*Start>All Programs>National Instruments>Measurement & Automation*



4. From the Configuration panel access;
 

*My System>Devices and Interfaces>Network Devices*

5. Right click *Network Devices* and select *Create New Visa TCP/IP Resource...*

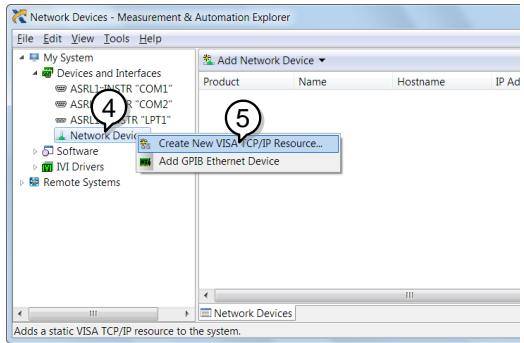

6. Select *Manual Entry of Raw Socket* from the popup window.
7. Click *Next*.

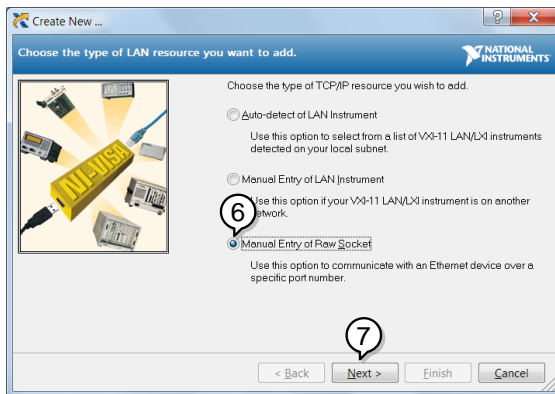

8. Enter the GDS-1000B's IP address and socket port number.
9. Click *Validate*.
10. A popup will appear to tell you if a VISA socket session was successfully created.
11. Click *Next*.

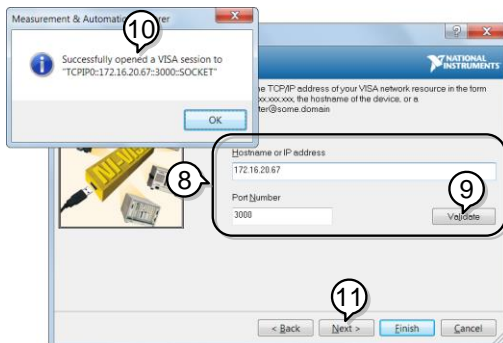

12. Choose an alias for the socket connection if you like.
13. Click *Finish* to finish the configuration.



14. The GDS-1000B will now appear under Network Devices in the Configuration Panel.

Functionality  
Check

15. Click the *Open Visa Test Panel* to send a remote command to the GDS-1000B.

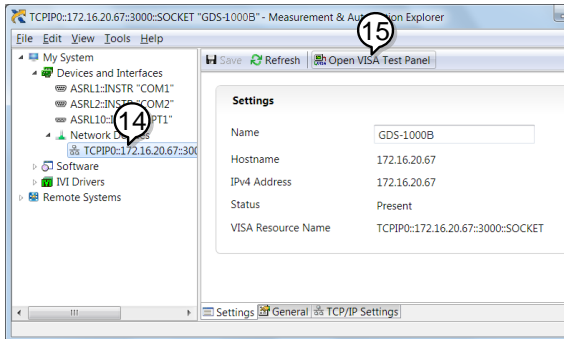

16. Click on the *Configuration* icon.
17. Select the *I/O Settings* tab.
18. Mark the *Enable Termination Character* checkbox.  
Make sure the termination character is a line feed (/n, value: xA).
19. Click *Apply Changes*.

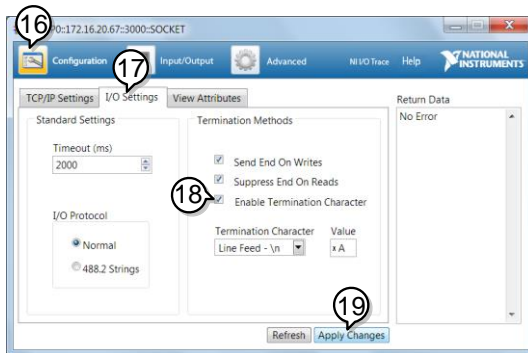

20. Click the *Input/Output* icon.
21. Make sure the \*IDN? query is selected in the *Select or Enter Command* drop box.
22. Click on *Query*.
23. The manufacturer, model number, serial number and firmware version will be displayed in the buffer. For example:  
GW,GDS-1072B,PXXXXXX,V1.00

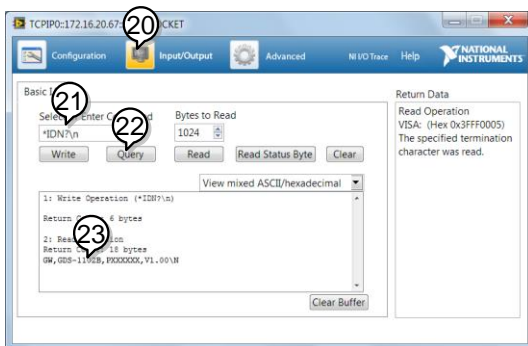

Note

For further details about remote control and remote commands, please see the GDS-1000B programming manual.

# M AINTENANCE

Two types of maintenance operations are available: calibrate vertical accuracy, and compensate the probe. Run these operations when using the GDS-1000B in a new environment.

---



How to use SPC function .....	225
Vertical Accuracy Calibration .....	226
Probe Compensation .....	227



## How to use SPC function

---

**Background** Signal Path Compensation (SPC) is used to compensate the internal signal path due to ambient temperature. SPC is able to optimize the accuracy of the oscilloscope with respect to the ambient temperature.

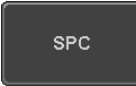
- Panel Operation**
1. Press the *Utility* key. 
  2. Press *System* from the bottom menu. 
  3. Press *SPC* from the side menu. A message showing a brief introduction to SPC appears on the screen. 



Note

Disconnect all probes and cables from all channels before calibrating.

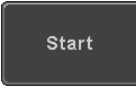

The DSO needs to be warmed up for at least 30 minutes before using the SPC function.

4. Press *Start* on the side menu to start SPC calibration. 
5. The SPC Calibration will proceed one channel at a time, from channel 1 to channel 4. It will take approximately 10 minutes in total.

- Abort**
6. Press *Abort* to abort the calibration. 

## Vertical Accuracy Calibration

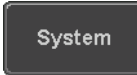
---

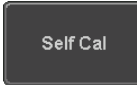
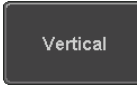
- Panel Operation
1. Press the *Utility* key. 
  2. Press *System* from the bottom menu. 
  3. Press *more 1 of 3* from the side menu. 
  4. Press *Self Cal* on the side menu. 
  5. Press *Vertical* on the side menu. 
  6. A message appears to “Now performing vertical calibration...  
CH1  
Connect the CAL output to channel, then press the Vertical key”.
  7. Connect the calibration signal from the rear panel (CAL port) to the Channel 1 input with a BNC cable.

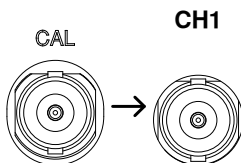

8. Press *Vertical* again after connecting CAL to the channel 1 input.

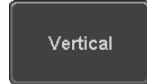

The calibration for Channel 1 starts and ends automatically, in less than 5 minutes. A message is displayed when the calibration procedure has ended.

9. Repeat the above step for Channel 2, 3\* and 4\* when prompted.

\*4 channel models only.

10. When the calibration for all channels has completed, the display goes back to the default state.

11. After the completion of the vertical calibration, please use an oscilloscope calibrator to verify the accuracy of signals amplitude.

## Probe Compensation

---

- Panel Operation
1. Connect the probe between the Channel 1 input and the probe compensation output (default set as 2Vp-p, 1kHz square wave) on the front panel. Set the probe attenuation to x10.
  2. Alternatively, the probe compensation frequency can be changed. See page 162 for details.

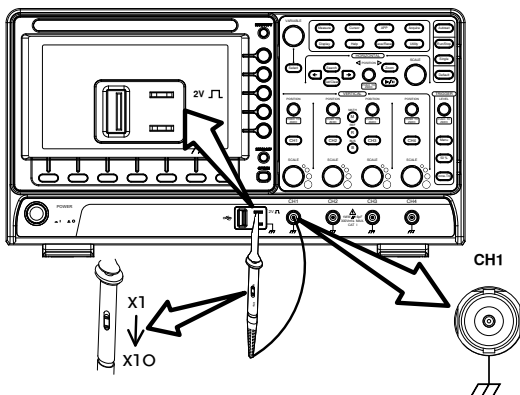

3. Press the *CH1* key to activate CH1.



4. Set the *Coupling* to DC from the bottom menu.

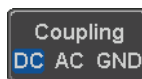

5. Set the Probe attenuation to *Voltage, 10X*.

Page 103

6. Press the *Autoset* key. The compensation signal appears on the display.

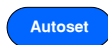

7. Press the *Display* key, then set the display type to *Vector*.

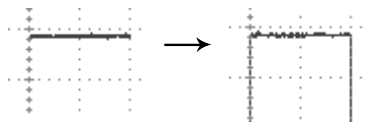
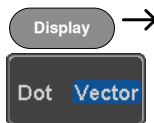

8. Turn the adjustment point on the probe to make the waveform as square as possible.

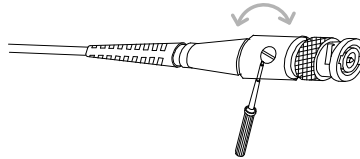
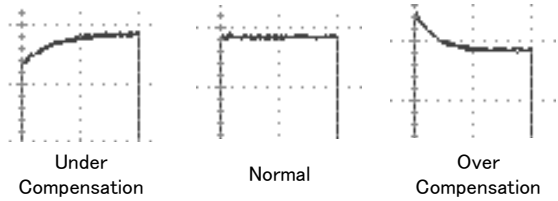

# FAQ

---

- I connected the signal but it does not appear on the display.
- I want to remove the (Measurement result / FFT result / Help contents) from the display.
- The waveform does not update (frozen).
- The probe waveform is distorted.
- Autoset does not catch the signal well.
- The display image printout is too dark on the background.
- The accuracy does not match the specification.

## I connected the signal but it does not appear on the display.

---

Make sure you have activated the channel by pressing the Channel key (the channel key lights up).

## I want to remove the (Measurement result / FFT result / Help contents) from the display.

---

To clear automatic measurement results, press the Measure key, select Remove Measurement and choose Remove All. See page 51.

To clear individual measurements from the screen, press the Measure key, select Display All and choose Off. See page 53.

To clear the FFT result, press the Math key twice. See page 67 for details.

To clear the Help result, press the Help key again. See page 36 for details.

The waveform does not update (frozen).

---

Press the Run/Stop key to unfreeze the waveform. See page 41 for details.

If this does not help, the trigger mode might be set to Single. Press the Single key to exit Single mode. See page 41 for Single trigger details.

The probe waveform is distorted.

---

You might need to compensate the probe. For details, see page 227.

Autoset does not catch the signal well.

---

The Autoset function cannot catch signals under 10mV or 20Hz. Please use the manual operation. See page 39 for Autoset details.

The display image printout is too dark on the background.

---

Use the Ink Saver function which reverses the background color. For details, see page 209.

The accuracy does not match the specification.

---

Make sure the device is powered On for at least 30 minutes, within +20°C~+30°C. This is necessary to stabilize the unit to match the specification.

For more information, contact your local dealer or GW Instek at [www.gwinstek.com](http://www.gwinstek.com) / [marketing@goodwill.com.tw](mailto:marketing@goodwill.com.tw).

# APPENDIX

---

Updating the Firmware .....	233
Installing Optional Apps .....	235
Installing Optional Apps .....	235
Uninstalling Optional Apps .....	236
GDS-1000B Specifications.....	238
Model-specific .....	238
Common .....	239
Probe Specifications .....	242
GTP-070B-4 .....	242
GTP-100B-4 .....	242
GTP-200B-4 .....	243
GDS-1000B Dimensions.....	244



## Updating the Firmware

**Background** New firmware can be downloaded from our website in the GDS products section.

Place a copy of the firmware file (xxx.upg) onto the root directory of a USB flash disk.

**Panel Operation** 1. Put the USB drive that contains the firmware into the front panel USB port.

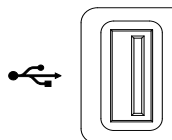

2. Power up the oscilloscope and at the same time, rotating the "VARIABLE" knob several times until the oscilloscope boot in the firmware upgrade mode as in the snapshot below.

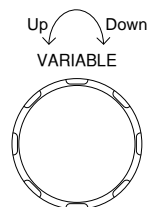

3. When the firmware file of USB flash disk has been recognized by oscilloscope, a message of "Found UPG: xxx.upg" will appear on the lower corner.

4. Press the “Start Now” (F1) key. The oscilloscope will automatically start upgrading the firmware. Or press the “Cancel” (F3) key to quit the firmware upgrading procedure.

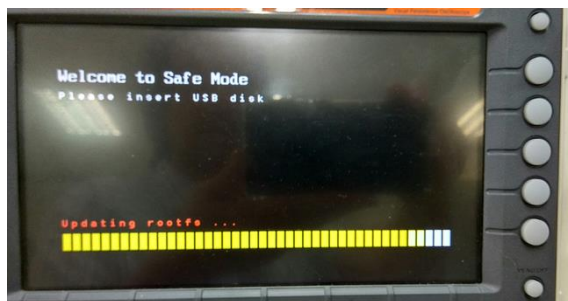

5. When the status indicator shows the complete status (status indicator in yellow completely) and a message of “Update NAND flash success” will appear on the top of status indicator. The firmware upgrading procedure is completed.

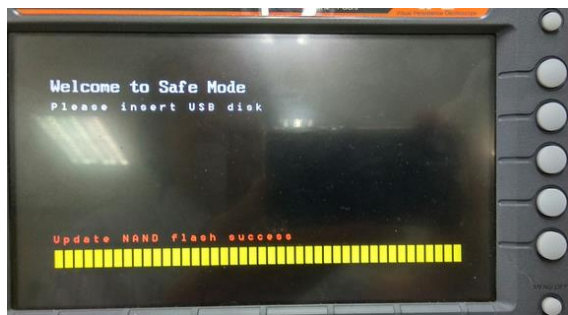

6. Restart the oscilloscope manually. Check the firmware version by pressing the “Utility” → “System” → “System Info”. The system information screen that it is being updated.

## Installing Optional Apps

### Installing Optional Apps

---

**Background**      The GDS-1000B has optional software apps that can be installed to add additional functionality to the DSO.

For the latest information regarding the optional apps, see the GW Instek website:  
[www.gwinstek.com](http://www.gwinstek.com) or contact your nearest distributor.

---

- Steps**
1. Download the Datalog App zip file from the GW Instek website.
  2. Unzip the Datalog App zip file.  
  
The App zip file contains the APP installation file (DataLog\_1KB.gz) and this user manual..
  3. Copy the installation file(DataLog\_1KB.gz) onto a USB flash drive.
  4. Insert the USB flash drive that contains the DataLog\_1KB.gz file into the front panel USB A port of the GDS-1000B.
  5. Press the *Utility* key then the *File Utilities* soft-key.

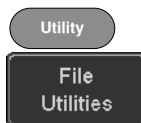
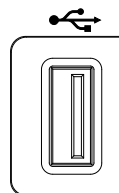

6. Use the *Variable* knob and *Select* key to navigate to the DataLog\_1KB.gz file on the USB drive.
7. Press the *Select* key to start the installation.
8. The installation will complete in a few seconds. When finished a pop-up message will appear asking you to restart the GDS-1000B.
9. Restart the GDS-1000B.



## Uninstalling Optional Apps

---

### Background

Any optional apps that were installed can be uninstalled from the APP menu. Pre-installed apps, such as the Go-NoGo app cannot be uninstalled.

For the latest information regarding the optional apps, see the GW Instek website: [www.gwinstek.com](http://www.gwinstek.com) or contact your nearest distributor.

### Steps

1. Press the *APP* key.
2. Highlight the app that you want to uninstall with the *Variable* knob.

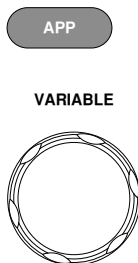

3. Press *Uninstall* twice from the side menu to uninstall the selected app.

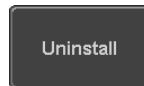

x2

## GDS-1000B Specifications

The specifications apply when the GDS-1000B is powered on for at least 30 minutes under +20°C~+30°C.

### Model-specific

GDS-1054B	Channels	4
	Bandwidth	DC ~ 50MHz (-3dB)
	Rise Time	7ns
	Bandwidth Limit	20MHz
GDS-1072B	Channels	2 + Ext
	Bandwidth	DC ~ 70MHz (-3dB)
	Rise Time	5ns
	Bandwidth Limit	20MHz
GDS-1074B	Channels	4
	Bandwidth	DC ~ 70MHz (-3dB)
	Rise Time	5ns
	Bandwidth Limit	20MHz
GDS-1102B	Channels	2 + Ext
	Bandwidth	DC ~ 100MHz (-3dB)
	Rise Time	3.5ns
	Bandwidth Limit	20MHz
GDS-1104B	Channels	4
	Bandwidth	DC ~ 100MHz (-3dB)
	Rise Time	3.5ns
	Bandwidth Limit	20MHz
GDS-1202B	Channels	2 + EXT
	Bandwidth	DC ~ 200MHz
	Rise Time	1.75ns
	Bandwidth Limit	20MHz

**Common**

Vertical Sensitivity	Resolution	8 bit: 1mV~10V/div	
	Input Coupling	AC, DC, GND	
	Input Impedance	1MΩ// 16pF approx. 14pF for GDS-1202B model only	
	DC Gain	1mV: ±4% full scale	
	Accuracy	>2mV: ±3% full scale	
	Polarity	Normal & Invert	
	Maximum Input Voltage	300Vrms, CAT I	
	Offset Position	1mV/div : ±1.25V	
	Range	2mV/div ~ 100mV/div : ±2.5V 200mV/div ~ 10V/div : ±125V	
	Waveform	+, -, x, ÷, FFT, FFTrms, User Defined Expression	
	Signal Process	FFT: Spectral magnitude. Set FFT Vertical Scale to Linear RMS or dBV RMS, and FFT Window to Rectangular, Hamming, Hanning, or Blackman-Harris	
	Trigger	Source	CH1, CH2, CH3*, CH4*, Line, EXT** *four channel models only. **two channel models only.
		Trigger Mode	Auto (supports Roll Mode for 100 ms/div and slower), Normal, Single Sequence
		Trigger Type	Edge, Pulse Width(Glitch), Video, Pulse Runt, Rise & Fall, Timeout, Alternate, Event-Delay(1~65535 events), Time-Delay(Duration, 4ns~10s)
		Holdoff range	4ns to 10s
Coupling		AC, DC, LF rej., Hf rej., Noise rej.	
Sensitivity		1div	
External Trigger*	Range	±2.5V	
	Sensitivity	DC ~ 100MHz Approx. 100mV	
	Input Impedance	1MΩ±3%~16pF 14pF for GDS-1202B model only	
	Horizontal	Timebase	5ns/div ~ 100s/div (1-2-5 increments)
Horizontal	Range	ROLL: 100ms/div ~ 100s/div	
	Pre-trigger	10 div maximum	
	Post-trigger	2,000,000 div maximum	
	Timebase Accuracy	±50 ppm over any ≥ 1 ms time interval	
	Real Time Sample Rate	1GSa/s max.	
	Record Length	Max. 10Mpts	

	Acquisition Mode	Normal, Average, Peak Detect, Single
	Peak Detection	2ns (typical)
	Average	selectable from 2 to 256
X-Y Mode	X-Axis Input	Channel 1; Channel 3* *four channel models only
	Y-Axis Input	Channel 2; Channel 4* *four channel models only
	Phase Shift	$\pm 3^\circ$ at 100kHz
Cursors and Measurement	Cursors	Amplitude, Time, Gating available; Unit: Seconds(s), Hz(1/s), Phase(degree), Ration(%)
	Automatic Measurement	36 sets: Pk-Pk, Max, Min, Amplitude, High, Low, Mean, Cycle Mean, RMS, Cycle RMS, Area, Cycle Area, ROVShoot, FOVShoot, RPREShoot, FPREShoot, Frequency, Period, RiseTime, FallTime, +Width, -Width, Duty Cycle, +Pulses, -Pulses, +Edges, -Edges, FRR, FRF, FFR, FFF, LRR, LRF, LFR, LFF, Phase
	Cursors measurement	Voltage difference between cursors ( $\Delta V$ ) Time difference between cursors ( $\Delta T$ )
	Auto counter	6 digits, range from 2Hz minimum to the rated bandwidth
Control Panel Function	Autoset	Single-button, automatic setup of all channels for vertical, horizontal and trigger systems, with undo Autoset
	Save Setup	20set
	Save Waveform	24set
Display	TFT LCD Type	7" TFT WVGA color display
	Display Resolution	800 horizontal $\times$ 480 vertical pixels (WVGA)
	Interpolation	Sin(x)/x
	Waveform Display	Dots, vectors, variable persistence (16ms-4s), infinite persistence
	Waveform Update Rate	50,000 waveforms per second, maximum
	Display Graticule	8 x 10 divisions
	Display Mode	YT, XY
Interface	USB Port	USB 2.0 High-speed host port X1, USB High-speed 2.0 device port X1
	Ethernet Port (LAN)	RJ-45 connector, 10/100Mbps with HP Auto-MDIX (Only for the GDS-1054B, GDS-1074B, GDS-1104B.)
	Go-NoGo BNC	5V Max/10mA TTL open collector output



	Kensington Style Lock	Rear-panel security slot connects to standard Kensington-style lock
Miscellaneous	Multi-language menu	Available
	Operation Environment	Temperature: 0°C to 50°C. Relative Humidity ≤ 80% at 40°C or below; ≤ 45% at 41°C ~ 50°C
	On-line help	Available
	Dimensions	384mmX208mmX127.3mm
	Weight	2.8kg

\* External trigger function is not supported when both channels (CH1+CH2) are turned on at the same time for GDS-1202B

## Probe Specifications

### GTP-070B-4

Applicable to: GDS-1054B, GDS-1072B & GDS-1074B

Position x10	Attenuation Ratio	10:1
	Bandwidth	DC to 70MHz
	Input Resistance	10MΩ when used with oscilloscopes with 1MΩ input
	Input Capacitance	14.5pF to 17.5pF
	Compensation Range	10pF to 35pF
	Max. Input Voltage	≤600V DC + ACpk
Position x1	Attenuation Ratio	1:1
	Bandwidth	DC to 10MHz
	Input Resistance	1MΩ (oscilloscope input resistance)
	Input Capacitance	85pF to 115pF
	Max. Input Voltage	≤200V DC + ACpk
Operating Cond.	Temperature	-10°C to 50°C
	Relative Humidity	≤85%

### GTP-100B-4

Applicable to: GDS-1102B & GDS-1104B

Position X10	Attenuation Ratio	10:1
	Bandwidth	DC to 100MHz
	Input Resistance	10MΩ when used with oscilloscopes with 1MΩ input.
	Input Capacitance	14.5pF to 17.5pF
	Compensation Range	5pF to 30pF
	Max. Input Voltage	≤600V DC + ACpk
Position X1	Attenuation Ratio	1:1
	Bandwidth	DC to 10MHz
	Input Resistance	1MΩ (oscilloscope input resistance)
	Input Capacitance	85pF to 115pF
	Max. Input Voltage	≤200V DC + ACpk
Operating Cond.	Temperature	-10°C ~ 50°C
	Relative Humidity	≤85%

**GTP-200B-4**

Applicable to: GDS-1202B

Position X10	Attenuation Ratio	10:1
	Bandwidth	DC to 200MHz
	Input Resistance	10MΩ when used with oscilloscopes with 1MΩ input.
	Input Capacitance	10.5pF to 17.5pF
	Compensation Range	5pF to 30pF
	Max. Input Voltage	≤600V DC + ACpk
Position X1	Attenuation Ratio	1:1
	Bandwidth	DC to 10MHz
	Input Resistance	1MΩ (oscilloscope input resistance)
	Input Capacitance	65pF to 105pF
	Max. Input Voltage	≤200V DC + ACpk
Operating Cond.	Temperature	-10°C to 50°C
	Relative Humidity	≤85%

## GDS-1000B Dimensions

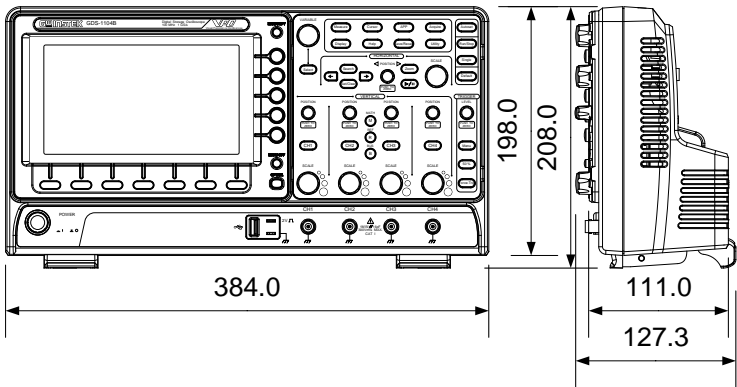
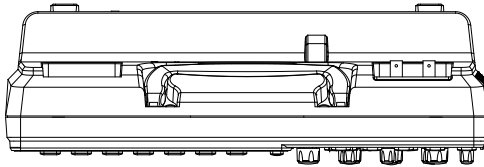

# Certificate of Compliance

We

**GOOD WILL INSTRUMENT CO., LTD.**

declare that the CE marking mentioned product

satisfies all the technical relations application to the product within the scope of council:

Directive: EMC; LVD; WEEE; RoHS

The product is in conformity with the following standards or other normative documents:

© EMC	
EN 61326-1	Electrical equipment for measurement, control and laboratory use -- EMC requirements
Conducted & Radiated Emission EN 55011 / EN 55032	Electrical Fast Transients EN 61000-4-4
Current Harmonics EN 61000-3-2 / EN 61000-3-12	Surge Immunity EN 61000-4-5
Voltage Fluctuations EN 61000-3-3 / EN 61000-3-11	Conducted Susceptibility EN 61000-4-6
Electrostatic Discharge EN 61000-4-2	Power Frequency Magnetic Field EN 61000-4-8
Radiated Immunity EN 61000-4-3	Voltage Dip/ Interruption EN 61000-4-11 / EN 61000-4-34
© Safety	
EN 61010-1 :	Safety requirements for electrical equipment for measurement, control, and laboratory use - Part 1: General requirements

**GOODWILL INSTRUMENT CO., LTD.**

No. 7-1, Jhongsing Road, Tucheng District, New Taipei City 236, Taiwan

Tel: [+886-2-2268-0389](tel:+886-2-2268-0389)

Fax: [+886-2-2268-0639](tel:+886-2-2268-0639)

Web: <http://www.gwinstek.com>

Email: [marketing@goodwill.com.tw](mailto:marketing@goodwill.com.tw)

**GOODWILL INSTRUMENT (SUZHOU) CO., LTD.**

No. 521, Zhujiang Road, Snd, Suzhou Jiangsu 215011, China

Tel: [+86-512-6661-7177](tel:+86-512-6661-7177)

Fax: [+86-512-6661-7277](tel:+86-512-6661-7277)

Web: <http://www.instek.com.cn>

Email: [marketing@instek.com.cn](mailto:marketing@instek.com.cn)

**GOODWILL INSTRUMENT EURO B.V.**

De Run 5427A, 5504DG Veldhoven, The Netherlands

Tel: [+31-\(0\)40-2557790](tel:+31-(0)40-2557790)

Fax: [+31-\(0\)40-2541194](tel:+31-(0)40-2541194)

Email: [sales@gw-instek.eu](mailto:sales@gw-instek.eu)

# INDEX

2-4 channel differences .....	11	Bandwidth filter .....	100
AC coupling .....	98	Blackman window .....	70
AC Priority mode .....	40	Built-in help .....	36
Acquisition .....	79	Caution symbol .....	5
average .....	79	Channel .....	38
indicator .....	25	status indicator .....	25
peak detect .....	79	Cleaning the instrument .....	7
record length .....	83	Control panel function	
sample .....	79	specification .....	240
XY mode .....	81	Conventions .....	31
Advanced math		Coupling mode .....	98
expression .....	72	Cursor	
operation .....	73	horizontal .....	59
source .....	72	specification .....	240
Amplitude measurements .....	46	vertical .....	63
APP		DC coupling .....	98
Go-NoGo .....	168	Declaration of conformity .....	245
overview .....	166	Default setup .....	194
Remote disk .....	173	contents .....	194
run .....	167	effect on channel .....	39
App installation .....	235	Delay measurements .....	48
App uninstallation .....	236	Deskew .....	103
Area measurements .....	46	Dimensions	
Auto trigger .....	131	diagram .....	244
Auto-dim .....	87	Display	
Automatic measurement		Bus .....	105
Add measurement .....	49	diagram .....	24
display all .....	53	specification .....	240
gated mode .....	52	Disposal instructions .....	8
High-Low .....	54	Dots .....	84
overview .....	45	Edge Trigger .....	136
Reference levels .....	58	EN61010	
remove measurement .....	51	measurement category .....	6
Statistics .....	55	pollution degree .....	7
Autoset .....	39	Environment	
AC Priority mode .....	40	safety instruction .....	7
effect on channel .....	40	Erase memory .....	161
exception .....	40	Ethernet	
Fit Screen mode .....	40		

interface .....	215	Keys overview .....	15
Event table format .....	123	Labels .....	182
Expand by ground/center .....	101	Language selection .....	160
External trigger .....	130	List of features .....	12
input terminal .....	20	Math	
specification .....	239	Advanced math overview .....	72
FAQ .....	230	basic .....	67
FFT		FFT operation .....	70
horizontal cursor .....	61	FFT overview .....	69
vertical cursor .....	64	Mean measurements .....	46
File		Memory bar	
create folder .....	204	indicator .....	25
delete .....	206	Menu on/off .....	89
rename .....	205	Miscellaneous	
File navigation .....	202	specification .....	241
File path .....	203	Model difference .....	11
Firmware update .....	233	Normal trigger .....	131
Firmware version .....	161	NTSC .....	133
First time use .....	28	On-screen help .....	36
Fit Screen mode .....	40	Overshoot measurements .....	46
Frequency measurements .....	47	PAL .....	133
Front panel diagram .....	14	Peak measurements .....	45
Go-NoGo		Peak to peak measurement .....	45
circuit diagram .....	172	Persistence .....	85
Go-NoGo .....	168	Play waveform .....	95
timing .....	172	Power on/off	
Ground		safety instruction .....	7
coupling .....	99	Printing	
symbol .....	5	connection .....	208
terminal .....	20	Hardcopy key .....	209
Hamming window .....	70	ink saver .....	209
Hanning window .....	69	Probe	
Holdoff .....	135	attenuation level .....	103
Horizontal		attenuation type .....	102
basic operation .....	42	deskew .....	103
position .....	90	Probe compensation .....	227
scale .....	91	Probe compensation frequency .....	162
specification .....	239	Pulse runt trigger .....	142
Image file format .....	177	Pulse measurements .....	47
Impedance .....	99	Pulse width trigger .....	139
Initialization .....	28	QR code reader function .....	163
Input frequency indicator .....	25	Rear panel diagram .....	22
Intensity .....	85	Recall .....	193
Interface .....	213	default setup .....	194
specification .....	240	reference .....	199
Invert waveform .....	99	setup .....	197

waveform .....	196	file format .....	180
Rectangular window .....	70	Signal path compensation .....	225
Reduce any menu .....	34	Single trigger mode .....	131
Reduce lower menu .....	34	Run/Stop .....	41
Reduce side menu .....	33	Socket server	
Remote control .....	212	function check .....	218
interface configuration .....	213	Socket server	
Remote disk .....	173	interface .....	217
Rise and fall trigger .....	144	Software installation .....	235
RMS measurements .....	46	Software uninstallation .....	236
Roll mode .....	92	SPC .....	225
Run/Stop .....	41, 89	Specifications .....	238
horizontal position .....	90	Spreadsheet file format .....	178
Horizontal scale .....	91	Stop icon .....	41
Save .....	185	System information .....	161
Hardcopy key .....	210	Tilt stand .....	26
image .....	186	Trigger .....	128
setup .....	191	Bus	
waveform .....	189	CAN .....	154
Screen dimmer .....	87	I <sup>2</sup> C .....	148
SECAM .....	133	LIN .....	157
Serial bus		SPI .....	152
cursors .....	126	UART .....	147
encoding .....	116	edge .....	136
event tables .....	119	holdoff .....	135
labels .....	124	indicator .....	25
overview .....	107	mode .....	136
threshold .....	117	parameters .....	130
trigger settings		pulse runt .....	142
CAN .....	154	pulse width .....	139
I <sup>2</sup> C .....	148	Rise and fall .....	144
LIN .....	157	Single .....	41
mode .....	159	specification .....	239
SPI .....	152	status indicator .....	25
UART .....	147	Timeout .....	145
Serial Bus .....	107	overview .....	134
CAN .....	114	video .....	141
I <sup>2</sup> C .....	111	UK power cord .....	9
LIN .....	115	Updating the firmware .....	233
SPI .....	112	USB	
UART .....	109	function check .....	214
Serial number .....	161	remote control interface .....	213
Service operation		Vectors .....	84
about disassembly .....	6	Vertical .....	97
contact .....	231	accuracy calibration .....	226
Setup		basic operation .....	44
default contents .....	194	position .....	97



---

scale.....	98	play/pause key .....	95
specification.....	239	roll mode.....	92
Video trigger .....	141	zoom mode .....	93
Warning symbol .....	5	Waveform color.....	24
Waveform		Waveform file format .....	177
CSV file contents.....	179	XY	
file contents .....	178	specification.....	240
how to recall.....	196	Zoom waveform.....	93
how to save.....	189		
invert waveform .....	99		