

# Digital Storage Oscilloscope

GDS-1000B Series

---

## PROGRAMMING MANUAL



ISO-9001 CERTIFIED MANUFACTURER

**GW INSTEK**

March 2020

This manual contains proprietary information which is protected by copyright. All rights are reserved. No part of this manual may be photocopied, reproduced or translated to another language without prior written consent of Good Will Corporation.

The information in this manual was correct at the time of printing. However, Good Will continues to improve products and reserves the right to change specifications, equipment, and maintenance procedures at any time without notice.

*Windows is a registered trademark of Microsoft Corporation in the United States and other countries.*

**Good Will Instrument Co., Ltd.**

**No. 7-1, Jhongsing Rd., Tucheng Dist., New Taipei City 236, Taiwan.**

# Table of Contents

<b>INTERFACE OVERVIEW .....</b>	<b>5</b>
Interface Configuration .....	5
<b>COMMAND OVERVIEW .....</b>	<b>16</b>
Command Syntax .....	16
List of Commands in Functional Order.....	18
<b>COMMAND DETAILS .....</b>	<b>27</b>
Common Commands.....	29
Acquisition Commands .....	35
Autoscale Commands.....	42
Vertical Commands .....	43
Math Commands.....	49
Cursor Commands .....	58
Display Commands .....	69
Hardcopy Commands.....	73
Measure Commands .....	76
Measurement Commands .....	101
Reference Commands.....	109
Run Command .....	112
Stop Command .....	112
Single Command .....	112
Force Command .....	113
Timebase Commands.....	114
Trigger Commands .....	117
System Commands.....	134
Save/Recall Commands.....	135
Ethernet Commands.....	140
Label Commands.....	141
DVM Commands .....	145
Go_NoGo Commands .....	148

Data Logging Commands .....	154
Remote Disk Commands .....	158
USB Delay Command .....	161
<b>APPENDX</b> .....	<b>162</b>
Error messages .....	162
<b>INDEX</b> .....	<b>166</b>





# INTERFACE OVERVIEW

This manual describes how to use the GDS-1000B's remote command functionality and lists the command details. The Overview chapter describes how to configure the GDS-1000B USB and Ethernet remote control interface.

## Interface Configuration

### Configure USB Interface

USB Configuration	PC side connector	Type A, host
	GDS-1000B side connector	Type B, device
	Speed	1.1/2.0
	USB Class	CDC (communications device class)

- Panel Operation
1. Press the Utility key. 
  2. Press *I/O* from the bottom menu. 
  3. Press *USB Device Port* from the side menu and select *Computer*. 
  4. Connect the USB cable to the rear panel device port. 

5. When the PC asks for the USB driver, select the USB driver included on the accompanying User Manual CD or download the driver from the GW Instek website, [www.gwinstek.com](http://www.gwinstek.com), in the GDS-1000B Download section. The driver automatically sets the GDS-1000B as a serial COM port (Shown as VPO in the PORTS node).

## USB Functionality Check

---

### Terminal Application

Invoke a terminal application such as RealTerm.

Set the COM port, baud rate, stop bit, data bit, and parity accordingly.

To check the COM port number and associated port settings, see the Device Manager in the PC. For Windows 7:

*Control panel* → *Hardware and Sound* → *Device Manager*

Example: Configuring RealTerm:

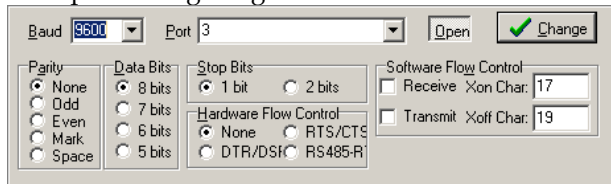

### Functionality Check

Key in this query command via the terminal application.

`*idn?`





This should return the Manufacturer, Model number, Serial number, and Firmware version in the following format.

*GW,GDS-1102B,PXXXXXX,V1.00*

## Configure the Ethernet Interface

Ethernet Configuration	MAC Address	Domain Name
	Instrument Name	DNS IP Address
	User Password	Gateway IP Address
	Instrument IP Address	Subnet Mask
		HTTP Port 80 (fixed)

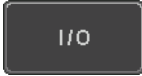
**Background** The Ethernet interface is used for remote control using a socket server connection. For details, please see the Socket Server section on page 10.

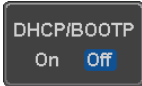
- Panel Operation**
1. Connect the Ethernet cable to the LAN port on the rear panel. 
  2. Press the *Utility* key. 
  3. Press *I/O* from the bottom menu. 
  4. Press *Ethernet* from the side menu. 
  5. Set *DHCP/BOOTP* to *On* or *Off* from the side menu. 



Note

IP addresses will automatically be assigned with DHCP/BOOTP set to on. For Static IP Addresses, DHCP/BOOTP should be set to off.



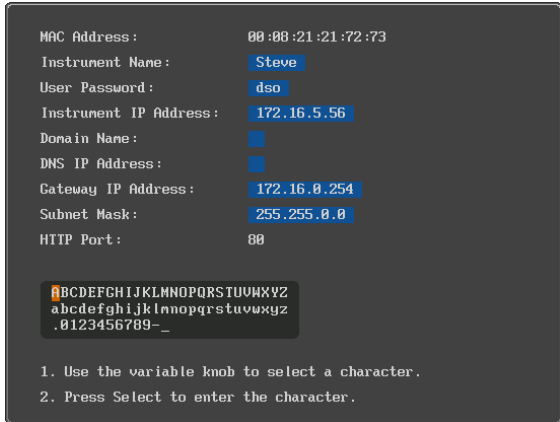

6. Use the *Up* and *Down* arrows on the side menu to navigate to each Ethernet configuration item.

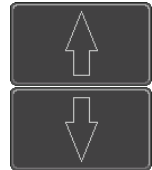

Items      MAC Address, Instrument Name, User Password, Instrument IP Address, Domain Name, DNS IP Address, Gateway IP Address, Subnet Mask

Note: HTTP Port is fixed at 80.

7. Use the *Variable* knob to highlight a character and use the *Select* key to choose a character.

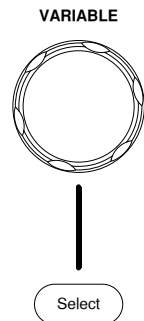

Press *Backspace* to delete a character.



Press *Save Now* to save the configuration. Complete will be displayed when successful.



## Configure Socket Server

The GDS-1000B supports socket server functionality for direct two-way communication with a client PC or device over LAN. By default, the Socket Server is off.

Configure Socket Server

1. Configure the IP address for the GDS-1000B.

Page 8

2. Press the *Utility* key.



3. Press *I/O* from the bottom menu.

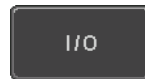

4. Press *Socket Server* from the side menu.

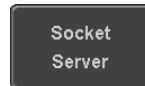

5. Press *Select Port* and choose the port number with the Variable knob.



Range 1024~65535

6. Press *Set Port* to confirm the port number.

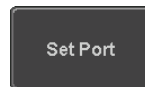

7. The Current Port icon will update to the new port number.



8. Press *Server* and turn the socket server On.

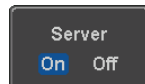

## Socket Server Functionality Check

---

NI Measurement and Automation Explorer To test the socket server functionality, National Instruments Measurement and Automation Explorer can be used. This program is available on the NI website, [www.ni.com](http://www.ni.com).

- |           |  |   |
|-----------|--|---|
| Operation | 1. Configure the IP address for the GDS-1000B.   | Page 8  |
|           | 2. Configure the socket port.  | Page 10   |
|           | 3. Start the NI Measurement and Automation Explorer (MAX) program. Using Windows, press: |  |

*Start>All Programs>National Instruments>Measurement & Automation*



4. From the Configuration panel access;

*My System>Devices and Interfaces>Network Devices*

- Right click *Network Devices* and select *Create New Visa TCP/IP Resource...*

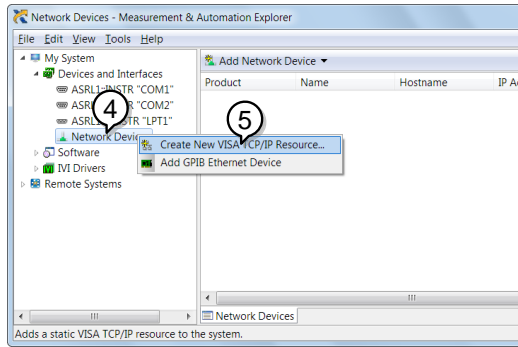

- Select *Manual Entry of Raw Socket* from the popup window.
- Click *Next*.

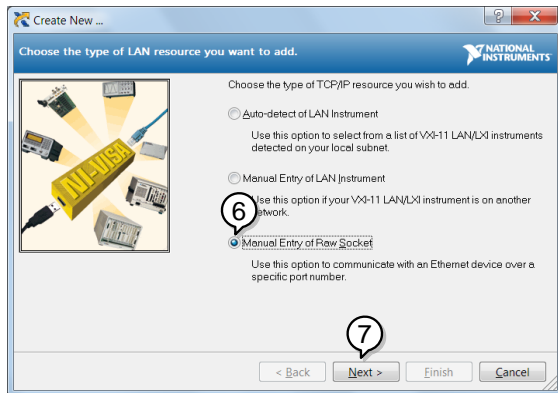

8. Enter the GDS-1000B's IP address and socket port number.
9. Click *Validate*.
10. A popup will appear to tell you if a VISA socket session was successfully created.
11. Click *Next*.

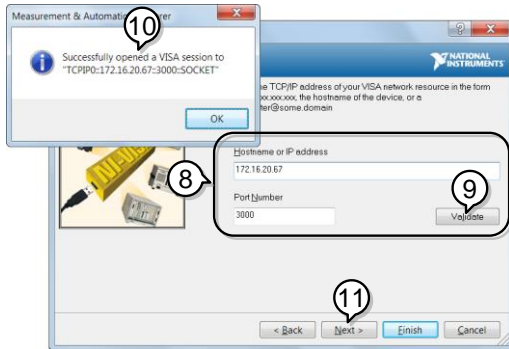

12. Choose an alias for the socket connection if you like.
13. Click *Finish* to finish the configuration.



14. The GDS-1000B will now appear under Network Devices in the Configuration Panel.

Functionality  
Check

15. Click the *Open Visa Test Panel* to send a remote command to the GDS-1000B.

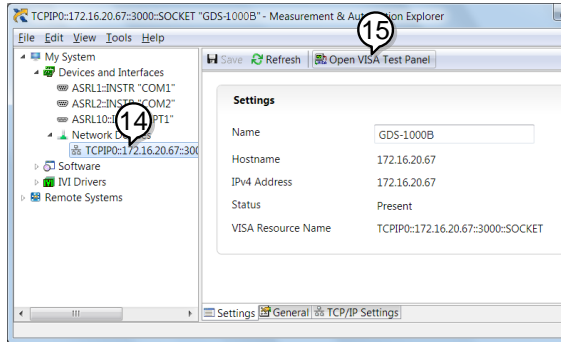

16. Click on the *Configuration* icon.

17. Select the *I/O Settings* tab.

18. Mark the *Enable Termination Character* checkbox. Make sure the termination character is a line feed (/n, value: xA).

19. Click *Apply Changes*.

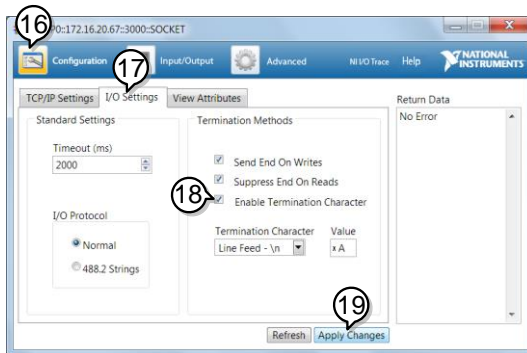

20. Click the *Input/Output* icon.
21. Make sure *\*IDN?* query is selected in the *Select or Enter Command* drop box.
22. Click on *Query*.
23. The manufacturer, model number, serial number and firmware version will be displayed in the buffer. For example:  
GW,GDS-1102B,PXXXXXX,V1.00

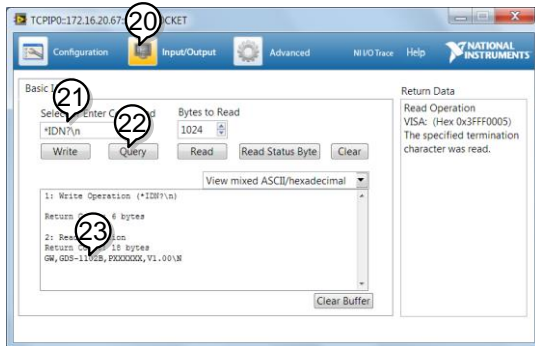

# C **COMMAND OVERVIEW**

The Command overview chapter lists all GDS-1000B commands in functional order as well as alphabetical order. The command syntax section shows you the basic syntax rules you have to apply when using commands.

## Command Syntax

---

- |                     |   |
|---------------------|---|
| Compatible standard | <ul style="list-style-type: none"> <li>• USB CDC_ACM compatible</li> <li>• SCPI, 1994 (partially compatible)</li> </ul> |
|---------------------|---|

**Command forms** Commands and queries have two different forms, long and short. The command syntax is written with the short form of the command in capitals and the remainder (long form) in lower case.

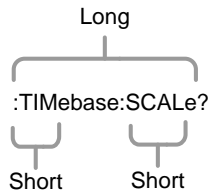

The commands can be written in capitals or lower-case, just so long as the short or long forms are complete. An incomplete command will not be recognized.

Below are examples of correctly written commands.

LONG :TiMebase:SCALe? :TIMEBASE:SCALE?  
 :timebase:scale?

---



SHORT :TIM:SCAL?                    :TIM:SCAL?

Command format :TIMEbase:SCALE <NR3>LF

1: command header  
 2: single space  
 3: parameter  
 4: message terminator

Parameter	Type	Description	Example
	<Boolean>	boolean logic	0, 1
	<NR1>	Integers	0, 1, 2, 3
	<NR2>	floating point	0.1, 3.14, 8.5
	<NR3>	floating point with an exponent	4.5e-1, 8.25e+1
	<NRf>	any of NR1, 2, 3	1, 1.5, 4.5e-1
Message terminator	LF	line feed code	

Note                    Commands are non-case sensitive.

## List of Commands in Functional Order

Common	*IDN?	29
	*LRN?	29
	*SAV	30
	*RCL	31
	*RST	31
	*CLS	31
	*ESE	31
	*ESR	32
	*OPC	33
	*SRE	33
*STB	34	
<hr/>		
Acquisition	:ACQuire:AVERAge	35
	:ACQuire:MODE	36
	:ACQuire<X>:MEMory?	36
	:ACQuire:FILTer:SOURce	38
	:ACQuire:FILTer	39
	:ACQuire:FILTer:FREQuency	39
	:ACQuire:FILTer:TRACking	40
	:ACQuire<X>:STATe?	40
	:ACQuire:RECOrdlength	40
:HEADer	41	
<hr/>		
Autoscale	:AUTOSet	42
	:AUTORSET:MODE	42

---

Vertical Scale	:CHANnel<X>:BWLimit.....43	43
	:CHANnel<X>:COUPling.....44	44
	:CHANnel<X>:DESKew .....44	44
	:CHANnel<X>:DISPlay .....44	44
	:CHANnel<X>:EXPand .....45	45
	:CHANnel<X>:IMPedance? .....45	45
	:CHANnel<X>:INVert .....46	46
	:CHANnel<X>:POSition .....46	46
	:CHANnel<X>:PROBe:RATio .....47	47
	:CHANnel<X>:PROBe:TYPe .....47	47
	:CHANnel<X>:SCALe .....47	47

---

Math	:MATH:DISP .....49	49
	:MATH:TYPe .....50	50
	:MATH:DUAL:SOURce<X> .....50	50
	:MATH:DUAL:OPERator .....50	50
	:MATH:DUAL:POSition .....51	51
	:MATH:DUAL:SCALe .....51	51
	:MATH:FFT:SOURce .....52	52
	:MATH:FFT:MAG .....52	52
	:MATH:FFT:WINDow .....52	52
	:MATH:FFT:POSition .....53	53
	:MATH:FFT:SCALe.....53	53
	:MATH:FFT:HORizontal:SCALe .....54	54
	MATH:FFT:HORizontal:POSition .....54	54
	:MATH:DEFine .....54	54
	MATHVAR? .....55	55
	MATHVAR:VAR<X> .....56	56
	:MATH:ADVanced:POSition .....56	56
	:MATH:ADVanced:SCALe.....56	56

---

Cursor	:CURSor:MODE .....58	58
	:CURSor:SOURce.....59	59
	:CURSor:HUNI .....59	59
	:CURSor:HUSE .....60	60
	:CURSor:VUNI .....60	60

	:CURSor:VUSE .....	61
	:CURSor:DDT .....	61
	:CURSor:H1Position .....	61
	:CURSor:H2Position .....	62
	:CURSor:HDELta .....	62
	:CURSor:V1Position.....	62
	:CURSor:V2Position.....	63
	:CURSor:VDELta .....	63
	:CURSor:XY:RECTangular:X:POSition<X> .....	63
	:CURSor:XY:RECTangular:X:DELta .....	64
	:CURSor:XY:RECTangular:Y:POSition<X> .....	64
	:CURSor:XY:RECTangular:Y:DELta .....	65
	:CURSor:XY:POLar:RADIUS:POSition<X> .....	65
	:CURSor:XY:POLar:RADIUS:DELta .....	65
	:CURSor:XY:POLar:THETA:POSition<X> .....	66
	:CURSor:XY:POLar:THETA:DELta.....	66
	:CURSor:XY:PRODuct:POSition<X> .....	66
	:CURSor:XY:PRODuct:DELta .....	67
	:CURSor:XY:RATio:POSition<X>.....	67
	:CURSor:XY:RATio:DELta .....	67
<hr/>		
Display	:DISPlay:INTensity:WAVEform.....	69
	:DISPlay:INTensity:GRATICule .....	69
	:DISPlay:INTensity:BACKLight .....	70
	:DISPlay:INTensity:BACKLight:AUTODim:ENABLE ....	70
	DISPlay:INTENSITY:BACKLight:AUTODim:TIME .....	70
	:DISPlay:PERSistence .....	71
	:DISPlay:GRATICule .....	71
	:DISPlay:WAVEform .....	72
	:DISPlay:OUTPut .....	72

Hardcopy	:HARDcopy:START .....	73
	:HARDcopy:MODE .....	73
	:HARDcopy:PRINTINKSaver .....	74
	:HARDcopy:SAVEINKSaver .....	74
	:HARDcopy:SAVEFORMat .....	74
	:HARDcopy:ASSIGN .....	75
Measure	:MEASure:GATing .....	77
	:MEASure:SOURce .....	77
	:MEASure:METHod .....	78
	:MEASUrement:REFLevel:PERCent:HIGH .....	78
	:MEASUrement:REFLevel:PERCent:LOW .....	79
	:MEASUrement:REFLevel:PERCent:MID .....	79
	:MEASUrement:REFLevel:PERCent:MID2 .....	79
	:MEASure:FALL .....	80
	:MEASure:FOVShoot .....	80
	:MEASure:FPReshoot .....	81
	:MEASure:FREQuency .....	81
	:MEASure:NWIDth .....	82
	:MEASure:PDUTy .....	82
	:MEASure:PERiod .....	83
	:MEASure:PWIDth .....	83
	:MEASure:RISe .....	84
	:MEASure:ROVShoot .....	84
	:MEASure:RPReshoot .....	85
	:MEASure:PPULSE .....	86
	:MEASure:NPULSE .....	86
	:MEASure:PEDGE .....	87
	:MEASure:NEDGE .....	87
	:MEASure:AMPlitude .....	88
	:MEASure:MEAN .....	88
	:MEASure:CMEan .....	89
	:MEASure:HIGH .....	90
	:MEASure:LOW .....	90
:MEASure:MAX .....	91	

	:MEASure:MIN .....	91
	:MEASure:PK2PK .....	92
	:MEASure:RMS .....	92
	:MEASure:CRMS .....	93
	:MEASure:AREa .....	94
	:MEASure:CARea .....	94
	:MEASure:FRRDelay .....	95
	:MEASure:FRFDelay .....	95
	:MEASure:FFRDelay .....	96
	:MEASure:FFFDelay .....	97
	:MEASure:LRRDelay .....	97
	:MEASure:LRFDelay .....	98
	:MEASure:LFRDelay .....	98
	:MEASure:LFFDelay .....	99
	:MEASure:PHase .....	100
<hr/>		
Measurement	:MEASUrement:MEAS<X>:SOURCE<X> .....	101
	:MEASUrement:MEAS<X>:TYPe .....	102
	:MEASUrement:MEAS<X>:STATE .....	102
	:MEASUrement:MEAS<X>:VALue .....	103
	:MEASUrement:MEAS<X>:MAXimum .....	104
	:MEASUrement:MEAS<X>:MEAN .....	105
	:MEASUrement:MEAS<X>:MINimum .....	105
	:MEASUrement:MEAS<X>:STDdev .....	106
	:MEASUrement:STATIstics:MODE .....	107
	:MEASUrement:STATIstics:WEIghting .....	107
	:MEASUrement:STATIstics .....	108
<hr/>		
Reference	:REF<X>:DISPlay .....	109
	:REF<X>:TIMebase:POSition .....	109
	:REF<X>:TIMebase:SCALE .....	110
	:REF<X>:OFFSet .....	110
	:REF<x>:SCALE .....	111
<hr/>		
Run	:RUN .....	112

---

Stop	:STOP .....	112
<hr/>		
Single	:SINGle.....	112
<hr/>		
Force	:FORCe .....	113
<hr/>		
Timebase	:TIMebase:EXPand .....	114
	:TIMebase:POSition .....	114
	:TIMebase:SCALe.....	114
	:TIMebase:MODE .....	115
	:TIMebase:WINDow:POSition .....	115
	:TIMebase:WINDow:SCALE .....	116
<hr/>		
Trigger	:TRIGger:FREQuency.....	118
	:TRIGger:TYPe.....	118
	:TRIGger:SOURce .....	119
	:TRIGger:COUPle.....	119
	:TRIGger:NREJ .....	119
	:TRIGger:MODE.....	120
	:TRIGger:HOLDoff.....	120
	:TRIGger:LEVel.....	120
	:TRIGger:HLEVel.....	121
	:TRIGger:LLEVel.....	121
	:TRIGger:EDGe:SLOP .....	122
	:TRIGger:DELaY:SLOP .....	122
	:TRIGger:DELaY:TYPe .....	123
	:TRIGger:DELaY:TIME.....	123
	:TRIGger:DELaY:EVENt.....	123
	:TRIGger:DELaY:LEVel .....	124
	:TRIGger:PULSEWidth:POLarity.....	124
	:TRIGger:RUNT:POLarity .....	125
	:TRIGger:RUNT:WHEn .....	125
	:TRIGger:RUNT:TIME .....	126
:TRIGger:RISEFall:SLOP.....	126	
:TRIGger:RISEFall:WHEn.....	126	

---

	:TRIGger:RISEFall:TIME .....	127
	:TRIGger:VIDeo:TYPe .....	127
	:TRIGger:VIDeo:FIELD .....	128
	:TRIGger:VIDeo:LINE .....	129
	:TRIGger:VIDeo:POLarity .....	129
	:TRIGger:PULSE:WHEn .....	129
	:TRIGger:PULSE:TIME .....	130
	:TRIGger:TIMEOut:WHEn.....	130
	:TRIGger:TIMEOut:TIMER .....	131
	:TRIGger:ALTErnate .....	131
	:TRIGger:STATe .....	131
	:TRIGger:EXTErNal:PROBe:TYPe.....	132
	:TRIGger:EXTErNal:PROBe:RATio .....	133
<hr/>		
System	:SYSTem:LOCK .....	134
commands	:SYSTem:ERRor .....	134
<hr/>		
Save/Recall	:RECALL:SETUp .....	135
	:RECALL:WAVEform .....	135
	:SAVE:IMAGe .....	136
	:SAVE:IMAGe:FILEFormat.....	136
	:SAVE:IMAGe:INKSaver.....	137
	:SAVE:SETUp .....	137
	:SAVE:WAVEform.....	138
	:SAVE:WAVEform:FILEFormat .....	139
<hr/>		
Ethernet	:ETHERnet:DHCP .....	140
Commands		
<hr/>		
Label Commands	:CHANnel<X>:LABel.....	141
	:CHANnel<X>:LABel:DISPlay.....	142
	:REF<X>:LABel .....	142
	:REF<X>:LABel:DISPlay .....	143
	:SET<X>:LABel .....	144



DVM Commands	:DVM:STATE .....	145
	:DVM:SOURce .....	145
	:DVM:MODE.....	146
	:DVM:VALue .....	146
<hr/>		
Go-NoGo	:GONogo:CLEar.....	148
Commands	:GONogo:EXECute .....	148
	:GONogo:FUNcTion.....	149
	:GONogo:NGCount.....	149
	:GONogo:NGDefine .....	149
	:GONogo:SOURce.....	150
	:GONogo:VIOlAtion.....	150
	:GONogo:SCRipt .....	150
	:TEMPlate:MODE .....	151
	:TEMPlate:MAXimum.....	151
	:TEMPlate:MINimum .....	151
	:TEMPlate:POSition:MAXimum .....	152
	:TEMPlate:POSition:MINimum .....	152
	:TEMPlate:SAVe:MAXimum .....	152
	:TEMPlate:SAVe:MINimum .....	153
	:TEMPlate:TOLerance.....	153
	:TEMPlate:SAVe:AUTO.....	153
<hr/>		
Data Logging	:DATALOG:STATE .....	154
Commands	:DATALOG:SOURce .....	155
	:DATALOG:SAVe .....	155
	:DATALOG:INTerval .....	156
	:DATALOG:DURation.....	157
<hr/>		
Remote Disk	:REMOTEDisk:IPADdRes .....	158
Commands	:REMOTEDisk:PATHName .....	158
	:REMOTEDisk:USERName .....	159
	:REMOTEDisk:PASSWord .....	159
	:REMOTEDisk:MOUNT.....	159
	:REMOTEDisk:AUTOMount.....	160

---

USB Delay command	:USBDelay .....	161
----------------------	-----------------	-----

# C COMMAND DETAILS

The Command details chapter shows the detailed syntax, equivalent panel operation, and example for each command. For the list of all commands, see page18.

---

Common Commands.....	29
Acquisition Commands .....	35
Autoscale Commands.....	42
Vertical Commands .....	43
Math Commands.....	49
Cursor Commands .....	58
Display Commands .....	69
Hardcopy Commands.....	73
Measure Commands .....	76
Measurement Commands .....	101
Reference Commands.....	109
Run Command .....	112
Stop Command .....	112
Single Command.....	112
Force Command.....	113
Timebase Commands.....	114
Trigger Commands .....	117
System Commands.....	134
Save/Recall Commands.....	135
Ethernet Commands.....	140
Label Commands.....	141
DVM Commands .....	145
Go_NoGo Commands .....	148
Data Logging Commands .....	154

Remote Disk Commands .....	158
USB Delay Command .....	161

## Common Commands

*IDN?	29
*LRN?	29
*SAV	30
*RCL	31
*RST	31
*CLS	31
*ESE	31
*ESR	32
*OPC	33
*SRE	33
*STB	34

### \*IDN?

→ Query

**Description** Returns the manufacturer, model, serial number and version number of the unit.

**Syntax** \*IDN?

**Example** \*IDN?  
GW,GDS-1074B,PXXXXXX,V1.XX

### \*LRN?

→ Query

**Description** Returns the oscilloscope settings as a data string.

**Syntax** \*LRN?

**Example** \*LRN?  
>;TYPE EDGE;SOURCE CH1;COUPLE AC;NREJ  
OFF;REJECT OFF;MODE AUTO;HOLDoff 4.000e-  
08;LEVELH -2.000E-04;LEVEL ?;EDGE:SLOP  
RISE;DELAY:TYPE TIME;DELAY:TIME  
0.000;DELAY:EVENT 1;DELAY:LEVEL ?;DELAY:SLOP  
RISE;PULSEWidth:POLarity POSITIVE;RUNT:POLarity

```

POSITIVE;RUNT:WHEn THAN;RUNT:TIME
0.000;RISEFall:SLOP RISE;RISEFall:WHEn
THAN;RISEFall:TIME 0.000;VIDeo:TYPe
NTSC;VIDeo:FIEld FIELD1;VIDeo:LINE
1;VIDeo:POLarity NEGATIVE;PULSe:WHEn
THAN;PULSe:TIME 0.000;ALTErnate
OFF;EXTErnal:PRObe:TYPe
VOLTAGE;EXTErnal:PRObe:RATio
1.000e+00;:REF1:DISPlay ON;TIMEbase:POSition
0.000E+00;SCALe 5.000E-04;OFFSet 4.000E+00;SCALe
2.000E+00;:REF2:DISPlay OFF;TIMEbase:POSition
0.000E+00;SCALe 5.000E-04;OFFSet 3.840E+00;SCALe
2.000E+00;:REF3:DISPlay OFF;TIMEbase:POSition
0.000E+00;SCALe 2.000E-04;OFFSet 0.000E+00;SCALe
5.000E-01;:REF4:DISPlay OFF;TIMEbase:POSition
0.000E+00;SCALe 2.000E-04;OFFSet 0.000E+00;SCALe
5.000E-
01;:CHANnel1:LAbel ;;CHANnel2:LAbel ;;REF1:LAbel ;
:REF2:LAbel ;;REF3:LAbel ;;REF4:LAbel ;;SET1:LAbel ;;
SET2:LAbel ;;SET3:LAbel ;;SET4:LAbel ;;SET5:LAbel ;;S
ET6:LAbel ;;SET7:LAbel ;;SET8:LAbel ;;SET9:LAbel ;;SE
T10:LAbel ;;SET11:LAbel ;;SET12:LAbel ;;SET13:LAbel
;;SET14:LAbel ;;SET15:LAbel ;;SET16:LAbel ;;SET17:LA
Bel ;;SET18:LAbel ;;SET19:LAbel ;;SET20:LAbel ;;CHA
Nnel1:LAbel:DISPlay OFF;:CHANnel2:LAbel:DISPlay
OFF;:REF0:LAbel:DISPlay OFF;:REF1:LAbel:DISPlay
OFF;:REF2:LAbel:DISPlay OFF;:REF3:LAbel:DISPlay
OFF
    
```

**\*SAV**



Description	Saves the current panel settings to the selected memory number( setup 1 ~ 20).
Syntax	*SAV {1   2   3  ...   20}
Example	*SAV 1 Saves the current panel settings to Set 1.

**\*RCL**

Set →

Description	Recalls a set of panel settings.
Syntax	*RCL {1   2   3   ...   20}
Example	*RCL 1 Recalls the selected setup from Set 1.

**\*RST**

Set →

Description	Resets the GDS-1000B (recalls the default panel settings).
Syntax	*RST

**\*CLS**

Set →

Description	Clears the error queue.
Syntax	*CLS

**\*ESE**

Set →

→ Query

Description	Sets or queries the Standard Event Status Enable register.			
Syntax	*ESE <NR1>			
Query Syntax	*ESE?			
Return parameter	<NR1>	0~255		
Bit Weight	Bit#	Weight	Event	Description
	0	1	OPC	Operation Complete Bit
	1	2	RQC	Not used
	2	4	QYE	Query Error
	3	8	DDE	Device Error

	4	16	EXE	Execution Error
	5	32	CME	Command Error
	6	64	URQ	User Request
	7	128	PON	Power On

Example \*ESE?  
>4  
Indicates that there is a query error.

**\*ESR**



Description Queries the Standard Event Status (Event) register. The Event Status register is cleared after it is read.

Query Syntax \*ESR?

Return parameter <NR1> 0~255

Bit Weight	Bit#	Weight	Event	Description
	0	1	OPC	Operation Complete Bit
	1	2	RQC	Not used
	2	4	QYE	Query Error
	3	8	DDE	Device Error
	4	16	EXE	Execution Error
	5	32	CME	Command Error
	6	64	URQ	User Request
	7	128	PON	Power On

Example \*ESR?  
>4  
Indicates that there is a query error.



\*OPC

**Description**      The \*OPC command sets the OPC bit (bit0) of the Standard Event Status Register when all current commands have been processed.

                         The \*OPC? Query returns 1 when all the outstanding commands have completed.

**Syntax**              \*OPC

**Query Syntax**      \*OPC?

**Return parameter**   1      Returns 1 when all the outstanding commands have completed.

\*SRE

**Description**      Sets or queries the Service Request Enable register. The Service Request Enable register determines which registers of the Status Byte register are able to generate service requests.

**Syntax**              \*SRE <NR1>

**Query Syntax**      \*SRE?

**Parameter/**      <NR1>    0~255  
**Return parameter**

Bit Weight	Bit#	Weight	Event	Description
	0	1		Not used
	1	2		Not used
	2	4		Not used
	3	8		Not used
	4	16	MAV	Message Available Bit
	5	32	ESB	Event Status Bit
	6	64	MSS	Master Summary Bit
	6	64	RQS	Request Service Bit

7 128 Not used

Example \*SRE?  
>48  
Indicates that the MAVB and ESB bit are both set.

**\*STB**



Description Queries the bit sum of the Status Byte register with MSS (Master summary Status) replacing the RQS bit (bit 6).

Query Syntax \*STB?

Return parameter <NR1> 0 ~ 255

Bit Weight	Bit#	Weight	Event	Description
	0	1		Not used
	1	2		Not used
	2	4		Not used
	3	8		Not used
	4	16	MAV	Message Available Bit
	5	32	ESB	Event Status Bit
	6	64	MSS	Master Summary Bit
	6	64	RQS	Request Service Bit
	7	128		Not used

Example \*STB?  
>16  
Indicates that the MAV bit is set.

## Acquisition Commands

:ACQuire:AVERage.....	35
:ACQuire:MODE .....	36
:ACQuire<X>:MEMory? .....	36
:ACQuire:FILTer:SOURce .....	38
:ACQuire:FILTer .....	39
:ACQuire:FILTer:FREQuency .....	39
:ACQuire:FILTer:TRACking .....	40
:ACQuire<X>:STATe? .....	40
:ACQuire:RECOrdlength .....	40
:HEADer .....	41

:ACQuire:AVERage 

Description	Selects or returns the number of waveform acquisitions that are averaged in the average acquisition mode.
Syntax	:ACQuire:AVERage {<NR1>  ?}
Related Commands	:ACQuire:MODE
Parameter	<NR1> 2, 4, 8, 16, 32, 64, 128, 256
Note	Before using this command, select the average acquisition mode. See the example below.
Example	:ACQuire:MODE AVERage :ACQuire:AVERage 2 Selects the average acquisition mode, and sets the average number to 2.

Set →

→ Query

**:ACquire:MODE**

Description	Selects or returns the acquisition mode.	
Syntax	:ACquire:MODE {SAMPlE   PDETECT   AVERAge   ?}	
Related Commands	:ACquire:AVERAge	
Parameter	SAMPlE	Sample mode sampling
	PDETECT	Peak detect sampling
	AVERAge	Average sampling mode
Example	:ACquire:MODE PDETECT Sets the sampling mode to peak detection.	

**:ACquire<X>:MEMory?**

→ Query

Description	Returns the data in acquisition memory for the selected channel as a header + raw data.	
Syntax	:ACquire<X>:MEMory?	
Related Commands	:ACquire:RECOrdlength :HEADer	
Parameter	<X>	Channel number (1 to 4)
Return parameter	<string> <waveform block data>	Returns acquisition settings followed by raw waveform block data. <string> Returns the acquisition settings for the selected channel. Format: parameter(1),setting(1);parameter(2),setting(2)...parameter(n),setting(n);Waveform Data; <waveform block data> Header followed by the raw waveform data.

Format:

Header: The header (in ASCII) encodes the number of bytes for the header followed by the number of data points in bytes for the raw data.

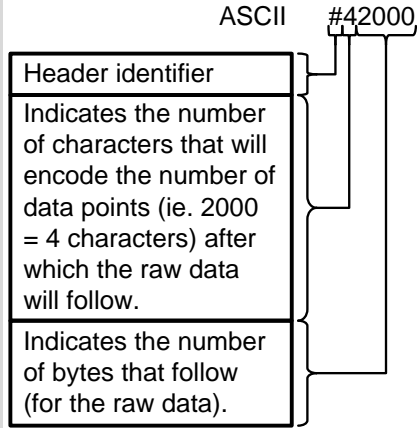

Raw Data:

Each two bytes (in hex) encodes the vertical data of a data point. The data is signed hex data (2's complement, -32768 ~ 32767).

Waveform Raw Data Example:

Header raw data.....

Hex:

23 34 32 30 30 30 00 1C 00 1B 00 1A 00  
1A 00 1B .....

ASCII/Decimal:

#42000 28 27 26 26 27.....

The actual value of a data point can be calculated with the following formula:  
(Decimal value of hex data/AD Factor) \* vertical scale.

Note: AD Factor is fixed as 25. The vertical scale is returned with the

acquisition settings that precede the raw data.

For example if the raw data for a point is 001C (=28 decimal) then,  
 $(28/25) \times 0.5 = 0.56V$

Example :ACQuire1:MEMory?  
 Format,1.0B;Memory Length,10000;IntpDistance,0;  
 Trigger Address,4999;Trigger Level,1.160E+01;  
 Source,CH1;Vertical Units,V;Vertical Units  
 Div,0;Vertical Units Extend  
 Div,15;Label,ACK ;Probe Type,0;Probe  
 Ratio,1.000e+01;Vertical Scale,5.000e+00;Vertical  
 Position,-1.100e+01;Horizontal Units,S;Horizontal  
 Scale,5.000E-04;Horizontal Position,0.000E+00;  
 Horizontal Mode,Main;SincET Mode,Real  
 Time;Sampling Period,5.000e-07;Horizontal Old  
 Scale,5.000E-04;Horizontal Old Position,0.000E+00;  
 Firmware,V0.99b8;Waveform Data;  
 #520000.....follows waveform block  
 data in hex.....

Set →

→ Query

:ACQuire:FILTer:SOURce

Description	Returns the source of the filter.
Note	This command is only applicable when the Digital Filter app is installed. See the Digital Filter app user manual for details.
Syntax	:ACQuire:FILTer:SOURce {CH1 CH2 CH3 CH4 ?}
Parameter/ Return parameter	CH1 ~ CH4 Source channel
Example	:ACQuire:FILTer:SOURce? CH1 Sets the filter source to CH1.

**:ACQUIRE:FILTER** 



Description	Turns the filter on/off or queries its status.	
Note	This command is only applicable when the Digital Filter app is installed. See the Digital Filter app user manual for details.	
Syntax	:ACQUIRE:FILTER {ON OFF ?}	
Parameter/ Return parameter	ON	Filter on.
	OFF	Filter off.
Example	:ACQUIRE:FILTER? OFF Indicates that the filter is turned off.	

**:ACQUIRE:FILTER:FREQUENCY** 

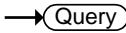

Description	Sets or queries the filter frequency.	
Note	This command is only applicable when the Digital Filter app is installed. See the Digital Filter app user manual for details.	
Syntax	:ACQUIRE:FILTER:FREQUENCY {DEFAULT <NRF> ?}	
Parameter/ Return parameter	DEFAULT	Sets the filter frequency to the default.
	<NRF>	Manually sets the filter frequency. (1Hz ~ 500MHz)
Example	:ACQUIRE:FILTER:FREQUENCY 1 Sets the filter frequency to 1Hz.	

:ACQUIRE:FILTER:TRACKing (Set) →  
→ (Query)

Description	Turns filter tracking on/off or queries its state.	
Note	This command is only applicable when the Digital Filter app is installed. See the Digital Filter app user manual for details.	
Syntax	:ACQUIRE:FILTER:TRACKing {ON OFF ?}	
Parameter/ Return parameter	OFF	Tracking off
	ON	Tracking on
Example	:ACQUIRE:FILTER:TRACKing ON Turns filter tracking on.	

:ACQUIRE<X>:STATE? → (Query)

Description	Returns the status of waveform data.	
Syntax	:ACQUIRE<X>:STATE?	
Parameter	<X>	Channel number (1 to 4)
Return parameter	0	Raw data is not ready
	1	Raw data is ready
Example	:ACQUIRE1:STATE? 0 Returns 0. Channel 1's raw data is not ready. <i>Note: If the oscilloscope changes the acquisition status from STOP to RUN, the status will be reset as zero.</i>	

:ACQUIRE:RECORDlength (Set) →  
→ (Query)

Description	Sets or queries the record length.	
Syntax	:ACQUIRE:RECORDlength {<NRf>  ?}	
Parameter/Return parameter	<NRf>	Record length. Settable record length: (1e+3   1e+4   1e+5   1e+6   1e+7)



Example :ACQuire:RECOrdlength 1e+3  
Sets the record length to 1000 points.

:HEADer

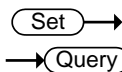

Description Configures whether the returned data of the :ACQuire:MEM query will contain header information or not. It is set to ON by default.

Syntax :HEADer {OFF | ON | ?}

Related Commands :ACQuire<X>:MEMory?

Parameter	ON	Add header information.
	OFF	Don't add header information.

Return parameter Returns the configuration (ON, OFF) for the selected channel.

Example :HEADer ON

## Autoscale Commands

:AUTOSet .....	42
:AUTORSET:MODE .....	42

### :AUTOSet



**Description**      Runs the Autoset function to automatically configure the horizontal scale, vertical scale, and trigger according to the input signal.

**Syntax**            :AUTOSet

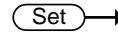

### :AUTORSET:MODE



**Description**      Sets the Autoset mode or queries its state.

**Syntax**            :AUTORSET:MODE {FITScreen | ACPriority | ?}

**Related Commands**      :AUTOSet

<b>Parameter/Return parameter</b>	FITScreen	Fit Screen mode
	ACPriority	AC priority mode

**Example**            :AUTORSET?  
FITSCREEN

## Vertical Commands

:CHANnel<X>:BWLimit .....	43
:CHANnel<X>:COUPling.....	44
:CHANnel<X>:DESKew .....	44
:CHANnel<X>:DISPlay .....	44
:CHANnel<X>:EXPanD .....	45
:CHANnel<X>:IMPedance? .....	45
:CHANnel<X>:INVert .....	46
:CHANnel<X>:POSition .....	46
:CHANnel<X>:PROBe:RATio .....	47
:CHANnel<X>:PROBe:TYPe .....	47
:CHANnel<X>:SCALe .....	47

:CHANnel<X>:BWLimit 

Description	Sets or returns the bandwidth limit on/off.	
Syntax	:CHANnel<X>:BWLimit {FULL   <NR3>   ?}	
Parameter	<X>	Channel 1,2,3,4
	FULL	Full bandwidth
	<NR3>	Sets the bandwidth limit to a pre-defined bandwidth. 20E+6: 20MHz
Return Parameter	<NR3>	Returns the bandwidth.
	Full	Full bandwidth
Example	:CHANnel1:BWLimit 2.000E+07 Sets the channel 1 bandwidth to 20MHz.	

**:CHANnel<X>:COUPling** 

Description	Selects or returns the coupling mode.	
Syntax	CHANnel<X>:COUPling {AC   DC   GND   ?}	
Parameter	<X>	Channel 1,2,3,4
	AC	AC coupling
	DC	DC coupling
	GND	Ground coupling
Return parameter	Returns the coupling mode.	
Example	:CHANnel1:COUPling DC Sets the coupling to DC for Channel 1.	

**:CHANnel<X>:DESKew** 

Description	Sets the deskew time in seconds.	
Syntax	:CHANnel<X>:DESKew { <NR3>   ?}	
Parameter	<X>	Channel 1,2,3,4
	<NR3>	Deskew time: -5.00E -11 to 5.00E-11 -50ns to 50 ns. (10 ps /step)
Return parameter	<NR3>	Returns the deskew time.
Example	:CHANnel1:DESKew 1.300E-9 Sets the deskew time to 1.3 nano seconds.	

**:CHANnel<X>:DISPlay** 

Description	Turns a channel on/off or returns its status.	
Syntax	:CHANnel<X>:DISPlay {OFF   ON   ?}	
Parameter	<X>	Channel 1,2,3,4
	OFF	Channel off
	ON	Channel on

Return Parameter	ON	Channel is on
	OFF	Channel is off

Example :CHANnel1:DISPlay ON  
Turns on Channel 1

:CHANnel<X>:EXPand (Set) →  
→ (Query)

Description Sets Expand By Ground or Expand By Center for a channel or queries its status.

Syntax :CHANnel<X>:EXPand {GND | CENTER | ?}

Parameter	<X>	Channel 1,2,3,4
	GND	Ground
	CENTER	Center

Return parameter	GND	Expand By Ground
	CENTER	Expand By Center

Example :CHANnel1:EXPand GND  
Sets Channel 1 to Expand By Ground.

:CHANnel<X>:IMPedance? → (Query)

Description Returns the impedance of the oscilloscope. (The impedance of the GDS-1000B is fixed at 1MΩ)

Syntax :CHANnel<X>:IMPedance?

Parameter	<x>	Channel
	1/2/3/4	CH1/2/3/4

Return parameter <NR3> Returns the impedance value.

Example :CHANnel1:IMPedance?  
1.000000E+06  
The impedance is 1M ohms.

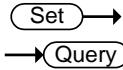

**:CHANnel<X>:INVert**

Description	Inverts a channel or returns its status.	
Syntax	:CHANnel<X>:INVert {OFF   ON   ?}	
Parameter	<X>	Channel 1, 2, 3, 4
	OFF	Invert off
	ON	Invert on
Return parameter	ON	Invert on
	OFF	Invert off
Example	:CHANnel1:INVert ON Inverts Channel 1	

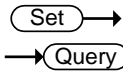

**:CHANnel<X>:POSition**

Description	Sets or returns the position level for a channel.	
Note	The vertical position will only be set to closest allowed value. The position level range depends on the vertical scale.	
	The scale must first be set before the position can be set.	
Syntax	:CHANnel<X>:POSition { <NRf>   ?}	
Parameter	<X>	Channel 1, 2, 3, 4
	<NRf>	Position. Range depends on the vertical scale.
Return parameter	<NR3>	Returns the position value.
Example 1	:CHANnel1:POSition 2.4E-3 Sets the Channel 1 position to 2.4mV/mA	
Example 2	:CHANnel1:POSition? 2.4E-3 Returns 2.4mV as the vertical position.	

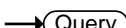
**:CHANnel<X>:PROBE:RATio**

Description	Sets or returns the probe attenuation factor.	
Syntax	:CHANnel<X>:PROBE:RATio { <NRf>   ? }	
Related Commands	:CHANnel<X>:PROBE:TYPE	
Parameter	<X>	Channel 1, 2, 3, 4
	<NRf>	Probe attenuation factor
Return parameter	<NR3>	Returns the probe attenuation factor
Example	:CHANnel1:PROBE:RATio 1.00E+0 Sets the Channel 1 probe attenuation factor to 1x	

**:CHANnel<X>:PROBE:TYPE**

Description	Sets or returns the probe type (voltage/current).	
Syntax	:CHANnel<X>:PROBE:TYPE { VOLTage   CURRent   ? }	
Related Commands	:CHANnel<X>:PROBE:RATio	
Parameter	<X>	Channel 1, 2, 3, 4
	VOLTage	Voltage
	CURRent	Current
Return parameter	Returns the probe type.	
Example	:CHANnel1:PROBE:TYPE VOLTage Sets the Channel 1 probe type to voltage.	

**:CHANnel<X>:SCALE**

Description	Sets or returns the vertical scale. The scale depends on the probe attenuation factor.  Note the probe attenuation factor should be set before the scale.	
-------------	---	--

Syntax	:CHANnel<X>:SCALE { <NRf>   ?}	
Parameter	<X>	Channel 1, 2, 3, 4
	<NRf>	Vertical scale: 2e-3 to 1e+1 2mV to 10V (Probe x1)
Return parameter	<NR3>	Returns the vertical scale in volts or amps.
Example	:CHANnel1:SCALE 2.00E-2	
	Sets the Channel 1 vertical scale to 20mV/div	



## Math Commands

:MATH:DISP .....	49
:MATH:TYPE .....	50
:MATH:DUAL:SOURce<X> .....	50
:MATH:DUAL:OPERator .....	50
:MATH:DUAL:POSition .....	51
:MATH:DUAL:SCALe .....	51
:MATH:FFT:SOURce .....	52
:MATH:FFT:MAG .....	52
:MATH:FFT:WINDow .....	52
:MATH:FFT:POSition .....	53
:MATH:FFT:SCALe .....	53
:MATH:FFT:HORIZontal:SCALe .....	54
MATH:FFT:HORIZontal:POSition .....	54
:MATH:DEFine .....	54
MATHVAR? .....	55
MATHVAR:VAR<X> .....	56
:MATH:ADVanced:POSition .....	56
:MATH:ADVanced:SCALe .....	56

### :MATH:DISP

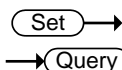

Description	Turns the math display on or off on the screen.	
Syntax	:MATH:DISP {OFF ON ?}	
Parameter/ Return parameter	OFF	Math is not displayed on screen
	ON	Math is displayed on screen
Example	:MATH:DISP OFF Math is off.	

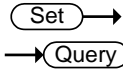

**:MATH:TYPE**

Description	Queries or sets the Math type to FFT, Advanced Math or to dual channel math operations (basic +, -, $\times$ , $\div$ , operations).						
Syntax	:MATH:TYPE { DUAL   ADVanced   FFT   ? }						
Related Commands	:MATH:DISP						
Parameter	<table border="1"> <tr> <td>DUAL</td> <td>Dual channel operations</td> </tr> <tr> <td>ADVanced</td> <td>Advanced math operations</td> </tr> <tr> <td>FFT</td> <td>FFT operations</td> </tr> </table>	DUAL	Dual channel operations	ADVanced	Advanced math operations	FFT	FFT operations
DUAL	Dual channel operations						
ADVanced	Advanced math operations						
FFT	FFT operations						
Return parameter	Returns the math type.						
Example	:MATH:TYPE DUAL Sets the Math type to dual channel math operation.						

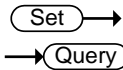

**:MATH:DUAL:SOURce<X>**

Description	Sets the dual math source for source 1 or 2.						
Syntax	:MATH:DUAL:SOURce<X> { CH1   CH2   CH3   CH4   REF1   REF2   REF3   REF4   ? }						
Parameter	<table border="1"> <tr> <td>&lt;X&gt;</td> <td>Source number 1 or 2</td> </tr> <tr> <td>CH1~4</td> <td>Channel 1 to 4</td> </tr> <tr> <td>REF1~4</td> <td>Reference waveforms 1 to 4</td> </tr> </table>	<X>	Source number 1 or 2	CH1~4	Channel 1 to 4	REF1~4	Reference waveforms 1 to 4
<X>	Source number 1 or 2						
CH1~4	Channel 1 to 4						
REF1~4	Reference waveforms 1 to 4						
Return parameter	Returns the source for the source 1 or 2.						
Example	:MATH:DUAL:SOURce1 CH1 Sets source1 as channel 1.						

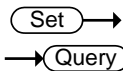

**:MATH:DUAL:OPERator**

Description	Sets the math operator for dual math operations.
-------------	--

Syntax	:MATH:DUAL:OPERator {PLUS   MINUS   MUL   DIV ?}	
Parameter	PLUS	+ operator
	MINUS	- operator
	MUL	× operator
	DIV	÷ operator
Return parameter	Returns operator type.	
Example	:MATH:DUAL:OPERator PLUS Sets the math operator as plus (+).	

:MATH:DUAL:POSition 



Description	Sets the vertical position of the displayed math result expressed by unit/division.	
Syntax	:MATH:DUAL:POSition {<NRf>   ? }	
Parameter	<NRf>	Vertical position Depends on the vertical scale (Unit/Div)
Return parameter	<NR3>	Returns the vertical position.
Example	:MATH:DUAL:POSition 1.0E+0 Sets the vertical position to 1.00 unit/div.	

:MATH:DUAL:SCALE 



Description	Sets the vertical scale of the displayed math result.	
Syntax	:MATH:DUAL:SCALE {<NRf>   ?}	
Parameter	<NRf>	Vertical scale
Return parameter	<NR3>	Returns the scale.
Example	:MATH:DUAL:SCALE 2.0E-3 Sets the vertical scale to 2mV/2mA.	

Set →  
→ Query

**:MATH:FFT:SOURce**

---

Description	Sets and queries the FFT math source.	
Syntax	:MATH:FFT:SOURce { CH1   CH2   CH3   CH4   REF1   REF2   REF3   REF4   ? }	
Related commands	:MATH:ADVanced:EDIT:SOURce<X> :MATH:ADVanced:EDIT:OPERator	
Parameter	CH1~4	Channel 1 to 4
	REF1~4	Reference waveform 1 to 4
Return parameter	Returns the FFT source.	
Example	:MATH:FFT:SOURce CH1 Sets the FFT math source as channel 1.	

Set →  
→ Query

**:MATH:FFT:MAG**

---

Description	Sets FFT vertical units as linear or decibels.	
Syntax	:MATH:FFT:MAG {LINEAR   DB   ?}	
Parameter	LINEAR	Linear units (Vrms)
	DB	Logarithmic units (dB)
Return parameter	Returns the FFT vertical units.	
Example	:MATH:FFT:MAG DB Sets FFT vertical units to dB.	

Set →  
→ Query

**:MATH:FFT:WINDow**

---

Description	Sets the windowing filter used for the FFT function.	
Syntax	:MATH:FFT:WINDow {RECTangular HAMming HANning BLAckman ?}	

Parameter	RECTangular	Rectangular window
	HAMming	Hamming window
	HANning	Hanning window
	BLAckman	Blackman window

Return parameter Returns the FFT window.

Example :MATH:FFT:WINDow HAMming  
Sets the FFT window filter to hamming.

Set →

**:MATH:FFT:POSition**

→ Query

Description Sets the vertical position of the displayed FFT result.

Syntax MATH:FFT:POSition { <NRf> | ? }

Parameter	<NRf>	Vertical position: -12e+0 to +12e+0 (12 units/division to +12 units/division.)
-----------	-------	---

Return parameter	<NR3>	Returns the vertical position.
------------------	-------	--------------------------------

Example :MATH:FFT:POSition -2e-1  
Sets the FFT position to -0.2 divisions.

Set →

**:MATH:FFT:SCALE**

→ Query

Description Sets the vertical scale of the displayed FFT result.

Syntax :MATH:FFT:SCALE {<NRf> | ?}

Parameter	<NRf>	Vertical scale: Linear: 2e-3 to 1e+3 (2mV~1kV) dB: 1e+0 to 2e+1 (1~20dB)
-----------	-------	--

Return parameter	<NR3>	Returns vertical scale.
------------------	-------	-------------------------

Example :MATH:FFT:SCALE 1.0e+0  
Sets the scale to 1dB.

:MATH:FFT:HORizontal:SCALE (Set) →  
→ (Query)

Description	Sets or queries the zoom scale for FFT math.	
Syntax	:MATH:FFT:HORizontal:SCALE {<NRf>   ?}	
Parameter	<NRf>	Zoom scale: 1 to 20 times
Return parameter	<NR3>	Returns zoom scale.
Example	:MATH:FFT:HORizontal:SCALE 5 Sets the zoom scale to 5X.	

MATH:FFT:HORizontal:POSition (Set) →  
→ (Query)

Description	Sets the horizontal position of the displayed FFT result.	
Syntax	MATH:FFT:HORizontal:POSition { <NRf>   ? }	
Parameter	<NRf>	Horizontal position: 0Hz ~ 999.9kHz
Return parameter	<NR3>	Returns the vertical position.
Example	:MATH:FFT:HORizontal:POSition 6.0e5 Sets the FFT horizontal position to 600kHz.	

:MATH:DEFine (Set) →  
→ (Query)

Description	Sets or queries the advanced math expression as a string.	
Syntax	:MATH:DEFine {<string>   ?}	
Related	:MATH:DISP :MATH:TYPE	
Parameter	<string>	An expression enclosed in double quotes. Note, ensure parentheses are used correctly in the expression. The expression can contain the following parts:

Source	CH1~CH4, Ref1~Ref4
Function	Intg(, Diff(, log(, ln(, Exp(, Sqrt(, Abs(, Rad(, Deg(, sin(, cos(, tan(, asin(, acos(, atan(
Variable	VAR1, VAR2
Operator	+, -, *, /, (, ), !(, <, >, <=, >=, ==, !=,   , &&
Figure	0, 1, 2, 3, 4, 5, 6, 7, 8, 9, ., E
Measurement	Pk-Pk(, Max(, Min(, Amp(, High(, Low(, Mean(, CycleMean(, RMS(, CycleRMS(, Area(, CycleArea(, ROVShoot(, FOVShoot(, Freq(, Period(, Rise(, Fall(, PosWidth(, NegWidth(, Dutycycle(, FRR(, FRF(, FFR(, FFF(, LRR(, LRF(, LFR(, LFF(, Phase(

Return parameter Returns the expression as a string.

Example :MATH:DISP ON  
:MATH:TYPe ADVanced  
MATH:DEFine "CH1-CH2"  
Sets the math expression to CH1-CH2.

## MATHVAR?



Description	Returns the value of the VAR1 and VAR2 variables.
Syntax	MATHVAR?
Related Commands	MATHVAR:VAR<X> MATH:DEFine
Return parameter	<string> VAR1 <NR3>; VAR2 <NR3>

Example            MATHVAR?  
                      VAR1 1.000000E+06; VAR2 1.0E+1  
                      Returns the value of both variables.

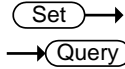

**MATHVAR:VAR<X>**

Description	Sets or returns the VAR1 or VAR2 variables.	
Syntax	MATHVAR:VAR<x> {<NRf>   ?}	
Related Commands	MATH:DEFine	
Parameter	<X>	1, 2 (VAR1 or VAR2)
	<NRf>	Value of VAR1/VAR2
Return parameter	<NR3>	Returns the value of VAR1/VAR2
Example	:MATH:VAR1 6.0e4 Sets VAR1 to 60000.	

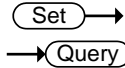

**:MATH:ADVanced:POSition**

Description	Sets the vertical position of the advanced math result, expressed in unit/div.	
Syntax	MATH:ADVanced:POSition {<NRf>   ?}	
Parameter	<NRf>	Vertical position: -12e+0 to +12e+0 (12 units/division to +12 units/division.)
Return parameter	<NR3>	Returns the vertical position.
Example	:MATH:ADVanced:POSition 1.0e+0 Sets the position as 1.00 unit/div.	

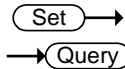

**:MATH:ADVanced:SCALE**

Description	Sets or queries the vertical scale the advanced math result.	
Syntax	:MATH:ADVanced:SCALE {<NRf>   ?}	



---

Parameter	<NRf>	Vertical scale
Return parameter	<NR3>	Returns the vertical scale.
Example	:MATH:ADVanced:SCALe 2.0E-3 Sets the vertical scale to 2mV/Div.	

---

## Cursor Commands

:CURSor:MODE	58
:CURSor:SOURce	59
:CURSor:HUNI	59
:CURSor:HUSE	60
:CURSor:VUNI	60
:CURSor:VUSE	61
:CURSor:DDT	61
:CURSor:H1Position	61
:CURSor:H2Position	62
:CURSor:HDELta	62
:CURSor:V1Position	62
:CURSor:V2Position	63
:CURSor:VDELta	63
:CURSor:XY:RECTangular:X:POSition<X>	63
:CURSor:XY:RECTangular:X:DELta	64
:CURSor:XY:RECTangular:Y:POSition<X>	64
:CURSor:XY:RECTangular:Y:DELta	65
:CURSor:XY:POLar:RADIUS:POSition<X>	65
:CURSor:XY:POLar:RADIUS:DELta	65
:CURSor:XY:POLar:THETA:POSition<X>	66
:CURSor:XY:POLar:THETA:DELta	66
:CURSor:XY:PRODuct:POSition<X>	66
:CURSor:XY:PRODuct:DELta	67
:CURSor:XY:RATio:POSition<X>	67
:CURSor:XY:RATio:DELta	67

:CURSor:MODE 

**Description**      Sets cursor mode to horizontal (H) or horizontal and vertical (HV).

**Syntax**            :CURSor:MODE {OFF | H | HV | ? }

Parameter	OFF	Turns the cursors off.
	H	Turns the horizontal cursors on.
	HV	Turns horizontal and vertical cursors on.

Return parameter Returns the state of the cursors (H, HV, OFF).

Example :CURSor:MODE OFF  
Turns the cursors off.

**:CURSor:SOURce**

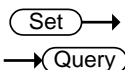

Description	Sets or queries the cursor source.	
Syntax	:CURSor:SOURce {CH1   CH2   CH3   CH4   REF1   REF2   REF3   REF4   MATH   ?}	
Parameter	CH1~CH4	Channel 1 to 4
	REF1~4	Reference waveform 1 to 4
	MATH	Math source

Return parameter Returns the cursor source.

Example :CURSor:SOURce CH1  
Turns the cursor source as channel 1.

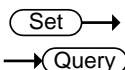

**:CURSor:HUNI**

Description	Sets or queries the units for the horizontal bar cursors.	
Syntax	:CURSor:HUNI {SECOnds   HERTz   DEGRees   PERcent   ?}	
Related Commands	:CURSor:MODE	
Parameter	SECOnds	Sets the cursor units to time in seconds.
	HERTz	Sets the cursor units to frequency.
	DEGRees	Sets the cursor units to degrees.
	PERcent	Sets the cursor units to percent.

Return parameter Returns the unit type.

Example :CURSor:HUNI SEConds  
Sets the units to time in seconds.

**:CURSor:HUSE**



Description Sets the current cursor position as the phase or ratio reference for the Percent or Degrees (horizontal) cursors.

Note This command can only be used when :CURSor:HUNI is set to DEGRees or PERcent.

Syntax :CURSor:HUSE {CURRent}

Related Commands :CURSor:MODE  
:CURSor:HUNI

Parameter CURRent Uses the current horizontal position

Example :CURSor:HUSE CURRent.

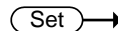

**:CURSor:VUNI**



Description Sets or queries the units for the vertical bar cursors.

Syntax :CURSor:VUNI {BASE | PERcent | ?}

Related Commands :CURSor:MODE  
Commands

Parameter	BASE	Sets the vertical cursor units the same as the scope units (V or A).
	PERcent	Sets the displayed units to percent.

Return parameter Returns the unit type.

Example :CURSor:VUNI BASE  
Sets the units to the base units.

**:CURSor:VUSE****Set** →

Description	Sets the current cursor position as the ratio reference for the Percent (vertical) cursors.
Note	This command can only be used when :CURSor:VUNI is set to PERcent.
Syntax	:CURSor:VUSE {CURRent}
Related Commands	:CURSor:MODE :CURSor:VUNI
Parameter	CURRent Uses the current vertical position
Example	:CURSor:VUSE CURRent.

**:CURSor:DDT**→ **Query**

Description	Returns the deltaY/deltaT (dy/dT) readout. This function is only supported if the source channels are CH1~4, Ref1~4 or Math.
Syntax	:CURSor:DDT{?}
Related Commands	:CURSor:MODE
Return Parameter	<NR3> Returns the readout in <NR3> format.
Example	:CURSor:DDT? 4.00E-05

**Set** →**:CURSor:H1Position**→ **Query**

Description	Sets or returns the first horizontal cursor (H1) position.
Syntax	:CURSor:H1Position {<NRF>  ?}
Related Commands	:CURSor:H2Position

Parameter	<NRf>	Horizontal position
Return parameter	Returns the cursor position.	
Example	:CURSOR:H1Position? -1.34E-3 Returns the H1 cursor position as -1.34ms.	

Set →

→ Query

**:CURSOR:H2Position**

Description	Sets or returns the second horizontal cursor (H2) position.	
Syntax	:CURSOR:H2Position {<NRf>   ?}	
Related Commands	:CURSOR:H1Position	

Parameter	<NRf>	Horizontal position
Return parameter	Returns the cursor position.	
Example	:CURSOR:H2Position 1.5E-3 Sets the H2 cursor position to 1.5ms.	

→ Query

**:CURSOR:HDELta**

Description	Returns the delta of H1 and H2.	
Syntax	:CURSOR:HDELta{?}	
Return Parameter	<NR3>	Returns the distance between two horizontal cursors.

Example	:CURSOR:HDELta? 5.0E-9 Returns the horizontal delta as 5ns.	
---------	---	--

Set →

→ Query

**:CURSOR:V1Position**

Description	Sets the first vertical cursor (V1) position.	
-------------	---	--

Syntax	:CURSor:V1Position {<NRf>  ?}	
Parameter	<NRf>	Vertical position. Depends on the vertical scale.
Return parameter	<NR3>	Returns the cursor position.
Example	:CURSor:V1Position 1.6E -1 Sets the V1 cursor position to 160mA.	

Set →

→ Query

### :CURSor:V2Position

Description	Sets the first vertical cursor (V2) position.	
Syntax	:CURSor:V2Position {<NRf>   ?}	
Parameter	<NRf>	Vertical position. Depends on the vertical scale.
Return parameter	<NR3>	Returns the cursor position.
Example	:CURSor:V2Position 1.1E-1 Sets the V2 cursor position to 110mA.	

### :CURSor:VDELta

→ Query

Description	Returns the delta of V1 and V2.	
Syntax	:CURSor:VDELta{?}	
Return Parameter	<NR3>	Returns the difference between two vertical cursors.
Example	:CURSor:VDELta? 4.00E+0 Returns the vertical delta as 4 volts.	

Set →

→ Query

### :CURSor:XY:RECTangular:X:POSition<X>

Description	Sets or queries the horizontal position in XY mode for the X rectangular coordinates for cursor 1 or 2.	
Syntax	:CURSor:XY:RECTangular:X:POSition<X> {<NRf> ?}	

Parameter	<X>	Cursor 1, 2
	<NRf>	Horizontal position co-ordinates
Return parameter	<NR3>	Returns the cursor position.
Example	:CURSor:XY:RECTangular:X:POSition1 4.0E-3 Sets the X-coordinate cursor 1 position to 40mV/mV.	

**:CURSor:XY:RECTangular:X:DELta** → Query

Description	Returns the delta value of cursor 1 and 2 on the X coordinate.	
Syntax	:CURSor:XY:RECTangular:X:DELta{?}	
Return Parameter	<NR3>	Returns the delta value of cursor 1 and 2 as <NR3>.
Example	:CURSor:XY:RECTangular:X:DELta? 80.0E-3 Returns the horizontal delta as 80mV.	

Set →

**:CURSor:XY:RECTangular:Y:POSition<X>** → Query

Description	Sets or queries the vertical position in XY mode for the Y rectangular coordinates for cursor 1 or 2.	
Syntax	:CURSor:XY:RECTangular:Y:POSition<X> {<NRf> ?}	
Parameter	<X>	Cursor 1, 2
	<NRf>	Vertical position co-ordinates
Return parameter	<NR3>	Returns the cursor position.
Example	:CURSor:XY:RECTangular:Y:POSition1 4.0E-3 Sets the Y-coordinate cursor 1 position to 40mV/mV.	



:CURSor:XY:RECTangular:Y:DELta → Query

Description	Returns the delta value of cursor 1 and 2 on the Y coordinate.
Syntax	:CURSor:XY:RECTangular:Y:DELta{?}
Return Parameter	<NR3> Returns the delta value of cursor 1 and 2 as <NR3>.
Example	:CURSor:XY:RECTangular:Y:DELta? 80.0E-3 Returns the horizontal delta as 80mV.

:CURSor:XY:POLar:RADIUS:POSition<X> → Query

Description	Queries the polar radius position for the specified cursor in XY mode, where X can be either cursor 1 or 2.
Syntax	:CURSor:XY:POLar:RADIUS:POSition<X>{?}
Parameter	<X> 1, 2 (cursor 1, cursor 2)
Return Parameter	<NR3> Returns the polar radius position.
Example	:CURSor:XY:POLar:RADIUS:POSition1? 80.0E-3 Returns the polar radius position as 80.0mV.

:CURSor:XY:POLar:RADIUS:DELta → Query

Description	Returns the radius delta value of cursor 1 and 2.
Syntax	:CURSor:XY:POLar:RADIUS:DELta{?}
Return Parameter	<NR3> Returns the radius delta.
Example	:CURSor:XY:POLar:RADIUS:DELta? 31.4E-3 Returns the radius delta as 31.4mV.

:CURSor:XY:POLar:THETA:POSition<X> → Query

Description Queries the polar angle for the specified cursor in XY mode, where X can be either 1 or 2.

Syntax :CURSor:XY:POLar:THETA:POSition<X>{?}

Parameter <X> 1, 2 (Cursor 1, Cursor 2)

Return parameter <NR3> Returns the polar angle.

Example :CURSor:XY:POLAR:RADIUS:POSition1?  
8.91E+1  
Returns the polar angle for cursor1 as 89.1°.

:CURSor:XY:POLar:THETA:DELta → Query

Description Queries the polar angle delta between cursor1 and cursor2.

Syntax :CURSor:XY:POLar:THETA:DELta{?}

Return parameter <NR3> Returns the theta delta between cursor1 and cursor2.

Example :CURSor:XY:POLar:THETA:DELta?  
9.10E+0  
Returns the delta as 9.1°.

:CURSor:XY:PRODuct:POSition<X> → Query

Description Queries the product in XY mode for the specified cursor, where x can be either 1 or 2.

Syntax :CURSor:XY:PRODuct:POSition<X>{?}

Parameter <X> 1, 2 (Cursor 1, Cursor 2)

Return parameter <NR3> Returns the product value of the Cursor1 or Cursor2.

Example :CURSor:XY:PRODUct:POSItion1?  
9.44E-5  
Returns the product of cursor1 as 94.4uVV.

:CURSor:XY:PRODUct:DELta 

Description Queries the product delta in XY mode.

Syntax :CURSor:XY:PRODUct:DELta{?}

Return parameter <NR3> Returns the product delta.

Example :CURSor:XY:PRODUct:DELta?  
1.22E-5  
Returns the product delta as 12.2uVV.

:CURSor:XY:RATio:POSItion<X> 

Description Queries the ratio in XY mode for the specified cursor, where x can be either cursor 1 or 2.

Syntax :CURSor:XY:RATio:POSItion<X>{?}

Parameter <X> 1, 2 (Cursor 1, Cursor 2)

Return parameter <NR3> Returns the ratio.

Example :CURSor:XY:RATio:POSItion?  
6.717E+1  
Returns the ratio value as 6.717V/V.

:CURSor:XY:RATio:DELta 

Description Queries the ratio delta in XY mode.

Syntax :CURSor:XY:RATio:DELta{?}

Return parameter <NR3> Returns the ratio delta.

Example           :CURSor:XY:RATio:DELta?  
                  5.39E+1  
                  Returns the ratio delta as 53.9V/V.

## Display Commands

:DISPlay:INTensity:WAVEform.....	69
:DISPlay:INTensity:GRATicule.....	69
:DISPlay:INTensity:BACKLight .....	70
:DISPlay:INTensity:BACKLight:AUTODim:ENABle .....	70
DISplay:INTENSITy:BACKLight:AUTODim:TIME .....	70
:DISPlay:PERsistence .....	71
:DISPlay:GRATicule .....	71
:DISPlay:WAVEform.....	72
:DISPlay:OUTPut .....	72

:DISPlay:INTensity:WAVEform (Set) →  
→ (Query)

**Description** Sets or queries the waveform intensity level.

**Syntax** :DISPlay:INTensity:WAVEform {<NRf> | ?}

**Parameter** <NRf> 0.0E+0 to 1.0E+2 (0% to 100%)

**Return Parameter** <NR3> Returns the intensity.

**Example** :DISPlay:INTensity:WAVEform 5.0E+1  
 Sets the waveform intensity to 50%.

:DISPlay:INTensity:GRATicule (Set) →  
→ (Query)

**Description** Sets or queries the graticule intensity level.

**Syntax** :DISPlay:INTensity:GRATicule {<NRf> | ?}

**Parameter** <NRf> 1.0E+0 to 1.0E+2 (10% to 100%)

**Return Parameter** <NR3> Returns the graticule intensity.

**Example** :DISPlay:INTensity:GRATicule 5.0E+1  
 Sets the graticule intensity to 50%.

:DISPlay:INTensity:BACKLight (Set) →  
→ (Query)

Description	Sets or queries the intensity of the backlight display.	
Syntax	:DISPlay:INTensity:BACKLight {<NRf>   ?}	
Parameter	<NRf>	1.0E+0 to 1.0E+2 (10% to 100%)
Return Parameter	<NR3>	Returns the backlight intensity.
Example	:DISPlay:INTensity:BACKLight 5.0E+1 Sets the backlight intensity to 50%.	

:DISPlay:INTensity:BACKLight:AUTODim:ENABLE (Set) →  
→ (Query)

Description	Sets or queries the display auto-dim function.	
Syntax	:DISPlay:INTensity:BACKLight:AUTODim:ENABLE {OFF   ON   ?}	
Parameter/ Return parameter	OFF ON	Turn auto-dim on. Turn auto-dim off.
Example	:DISPlay:INTensity:BACKLight:AUTODim:ENABLE ON Turns the auto-dim function on.	

DISPlay:INTENSITY:BACKLight:AUTODim:TIME (Set) →  
→ (Query)

Description	Sets or queries the display auto-dim time.	
Syntax	:DISPlay:INTensity:BACKLight:AUTODim:TIME {<NR1>   ?}	
Parameter/ Return parameter	<NR1>	1 ~ 180 minutes. Time in minutes.
Example	:DISPlay:INTensity:BACKLight:AUTODim:TIME 10 Sets the auto-dim time to 10 minutes.	





Set →  
 → Query

**:DISPlay:PERsistence**

Description	Sets or queries the waveform persistence level.	
Syntax	:DISPlay:PERsistence { INFInite   OFF   <NRf>   ? }	
Parameter	<NRf>	1.6E-2 ~ 4.0E+0. (16mS to 4S) Range(1.6E-2, 30E-3, 60E-3, 120E-2, 240E-3, 500E-3, 750E-3, 1, 1.5,2, 4
	INFInite	Infinite persistence
	OFF	No persistence
Return Parameter	<NR3>	Returns the persistence time.
	INFInite	Infinite persistence
	OFF	No persistence
Example	:DISPlay:PERsistence 2.0E+0 Sets the persistence to 2 seconds.	

Set →  
 → Query

**:DISPlay:GRATicule**

Description	Sets or queries graticule display type.			
Syntax	:DISPlay:GRATicule {FULL   GRID CROsS   FRAMe   ?}			
Parameter	FULL		CROsS	
	FRAMe		GRID	
Return parameter	Returns the graticule type.			
Example	:DISPlay:GRATicule FULL Sets the graticule to  .			

Set →  
 → Query

**:DISPlay:WAVEform**

---

Description	Sets or queries whether the waveforms are drawn as vectors or dots.	
Syntax	:DISPlay:WAVEform {VECTor   DOT   ?}	
Parameter	VECTor	Vectors
	DOT	Dots
Return parameter	Returns VECTOR or DOT.	
Example	:DISPlay:WAVEform VECTor Sets the waveform to vectors.	

→ Query

**:DISPlay:OUTPut**

---

Description	Returns the screen image as a 16 bit RGB run length encoded image.	
Syntax	:DISPlay:OUTPut{?}	
Return parameter	Format: header+data+LF  For example assuming the image data size is 60072 bytes then the following would be returned: #560072<[count] [color] [count] [color]..... ><LF>  Where #560072 is the header, each [count] and [color] data are 2 bytes and <LF> is a line feed character.	



## Hardcopy Commands

:HARDcopy:START .....	73
:HARDcopy:MODE .....	73
:HARDcopy:PRINTINKSaver .....	74
:HARDcopy:SAVEINKSaver .....	74
:HARDcopy:SAVEFORMat .....	74
:HARDcopy:ASSIGN .....	75

### :HARDcopy:START



Description	Executing the HARDcopy:START command is the equivalent of pressing the Hardcopy key on the front panel.
Syntax	:HARDcopy:START
Related Commands	:HARDcopy:MODE :HARDcopy:PRINTINKSaver :HARDcopy:SAVEINKSaver :HARDcopy:SAVEFORMat :HARDcopy:ASSIGN

### :HARDcopy:MODE

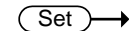

Description	Sets or queries whether hardcopy is set to print or save.				
Syntax	:HARDcopy:MODE { PRINT   SAVE   ? }				
Related Commands	:HARDcopy:START				
Parameter	<table> <tr> <td>PRINT</td> <td>Print mode</td> </tr> <tr> <td>SAVE</td> <td>Save mode</td> </tr> </table>	PRINT	Print mode	SAVE	Save mode
PRINT	Print mode				
SAVE	Save mode				
Return parameter	Returns the mode.(PRINT/SAVE)				

Example :HARDcopy:MODE PRINT  
Sets hardcopy to print.

:HARDcopy:PRINTINKSaver (Set) →  
→ (Query)

Description	Sets Inksaver On or Off for printing.	
Syntax	:HARDcopy:PRINTINKSaver { OFF   ON   ? }	
Related Commands	:HARDcopy:START :HARDcopy:MODE	
Parameter	ON	Inksaver ON
	OFF	Inksaver OFF
Return parameter	Returns the print Ink Saver mode.(ON/OFF)	

Example :HARDcopy:PRINTINKSaver ON  
Sets Ink Saver to ON for printing.

:HARDcopy:SAVEINKSaver (Set) →  
→ (Query)

Description	Sets Inksaver On or Off for saving screen images.	
Syntax	:HARDcopy:SAVEINKSaver { OFF   ON   ? }	
Related Commands	:HARDcopy:START :HARDcopy:MODE	
Parameter	ON	Inksaver ON
	OFF	Inksaver OFF
Return parameter	Returns the screen image Ink Saver mode (ON/OFF).	

Example :HARDcopy:SAVEINKSaver ON  
Sets Inksaver to ON for saving screen images.

:HARDcopy:SAVEFORMat (Set) →  
→ (Query)

Description	Sets or queries the image save file type.	
Syntax	:HARDcopy:SAVEFORMat { PNG   BMP   ? }	

Related Commands	:HARDcopy:START :HARDcopy:MODE
Parameter	PNG      PNG file format BMP      BMP file format
Return parameter	Returns the image file format (PNG/BMP).
Example	:HARDcopy:SAVEFORMat PNG Sets the file format to PNG.

**:HARDcopy:ASSIGN**

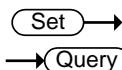

Description	Sets or queries what file type the hardcopy key has been assigned to save.
Syntax	:HARDcopy:ASSIGN {IMAGe   WAVEform   SETUp   ALL   ?}
Related Commands	:HARDcopy:START :HARDcopy:MODE
Parameter	IMAGe      Save image files. WAVEform      Save waveforms. SETUp      Save the panel setup. ALL      Save All (image, waveform,setup)
Return parameter	Returns the file type. (IMAGE/WAVEFORM/SETUP/ALL)
Example	:HARDcopy:ASSIGN IMAGE. Set the hardcopy key to save image files.

## Measure Commands

---

:MEASure:GATing.....	77
:MEASure:SOURce .....	77
:MEASure:METHod .....	78
:MEASUrement:REFLevel:PERCent:HIGH .....	78
:MEASUrement:REFLevel:PERCent:LOW .....	79
:MEASUrement:REFLevel:PERCent:MID .....	79
:MEASUrement:REFLevel:PERCent:MID2 .....	79
:MEASure:FALL.....	80
:MEASure:FOVShoot.....	80
:MEASure:FPreshoot .....	81
:MEASure:FREQuency.....	81
:MEASure:NWIDth .....	82
:MEASure:PDUTy .....	82
:MEASure:PERiod .....	83
:MEASure:PWIDth .....	83
:MEASure:RISe .....	84
:MEASure:ROVShoot.....	84
:MEASure:RPreshoot.....	85
:MEASure:PPULSE.....	86
:MEASure:NPULSE.....	86
:MEASure:PEDGE .....	87
:MEASure:NEDGE .....	87
:MEASure:AMPlitude.....	88
:MEASure:MEAN .....	88
:MEASure:CMEan .....	89
:MEASure:HIGH .....	90
:MEASure:LOW.....	90
:MEASure:MAX.....	91
:MEASure:MIN .....	91
:MEASure:PK2PK.....	92
:MEASure:RMS .....	92
:MEASure:CRMS.....	93

:MEASure:AREa .....	94
:MEASure:CARea .....	94
:MEASure:FRRDelay .....	95
:MEASure:FRFDelay.....	95
:MEASure:FFRDelay.....	96
:MEASure:FFFDelay.....	97
:MEASure:LRRDelay .....	97
:MEASure:LRFDelay.....	98
:MEASure:LFRDelay.....	98
:MEASure:LFFDelay.....	99
:MEASure:PHAsE.....	100

**:MEASure:GATing**

Set →

→ Query

Description	Sets or queries the measurement gating.	
Syntax	:MEASure:GATing { OFF   SCREEn   CURSor   ? }	
Parameter	OFF	Full record
	SCREEn	Gating set to screen width
	CURSor	Gating between cursors
Return parameter	Returns the gating. (OFF, SCREEN, CURSOR)	
Example	:MEASure:GATing OFF Turns gating off (full record).	

**:MEASure:SOURce**

Set →

→ Query

Description	Sets or queries the measurement source for source1 or source2.	
Syntax	:MEASure:SOURce<X> { CH1   CH2   CH3   CH4   MATH   ? }	
Parameter	<X>	Source1 or source2
	CH1~CH4	Channel 1 to 4

**MATH** Math

Return parameter Returns the source (CH1, CH2, CH3, CH4, MATH)

Example :MEASure:SOURce1 CH1  
Sets source1 to channel 1.

Set →

→ Query

**:MEASure:METHOD**

Description Sets or queries the method used to determine the High-Low measurement values.

Syntax :MEASure:METHOD { AUTO | HISTogram | MINMax | ? }

Parameter	AUTO	Set to auto.
	HISTogram	Set to the Histogram method.
	MINMax	Set to the Min-Max method.

Return parameter Returns the measurement method (AUTO, HISTOGRAM, MINMAX)

Example :MEASure:METHOD: AUTO  
Set the measurement method to auto.

Set →

→ Query

**:MEASUrement:REFLevel:PERCent:HIGH**

Description Sets or queries the high reference level as a percentage.

Syntax :MEASUrement:REFLevel:PERCent:HIGH {<NRF> | ?}

Parameter	<NRF>	0 - 100%
-----------	-------	----------

Return parameter Returns the high reference level

Example :MEASUrement:REFLevel:PERCent:HIGH 50.1  
Set the high reference level to 50.1%.

**:MEASUrement:REFLevel:PERCent:LOW** 



Description	Sets or queries the low reference level as a percentage.
Syntax	:MEASUrement:REFLevel:PERCent:LOW {<NRf>   ?}
Parameter	<NRf> 0 - 100%
Return parameter	Returns the low reference level.
Example	:MEASUrement:REFLevel:PERCent:LOW 40.1 Set the low reference level to 40.1%.

**:MEASUrement:REFLevel:PERCent:MID** 



Description	Sets or queries the first mid reference level as a percentage.
Syntax	:MEASUrement:REFLevel:PERCent:MID {<NRf>   ?}
Parameter	<NRf> 0 - 100%
Return parameter	Returns the mid reference level.
Example	:MEASUrement:REFLevel:PERCent:MID 50 Set the mid reference level to 50%.

**:MEASUrement:REFLevel:PERCent:MID2** 



Description	Sets or queries the second mid reference level as a percentage.
Syntax	:MEASUrement:REFLevel:PERCent:MID2 {<NRf>   ?}
Parameter	<NRf> 0 - 100%
Return parameter	Returns the mid reference level of the second source.
Example	:MEASUrement:REFLevel:PERCent:MID2 50 Set the mid reference level to 50%.

**:MEASure:FALL**

→ **Query**

Description	Returns the fall time measurement result.	
Syntax	:MEASure:FALL{?}	
Related Commands	:MEASure:SOURce<X>	
Return parameter	<NR3>	
	Chan Off	Indicates the source channel is not activated.
Note	Before using this command, select the measurement channel. See the example below.	
Example	:MEASure:SOURce1 CH1 :MEASure:FALL? Selects Channel 1 as the source, and then measures the fall time.	

**:MEASure:FOVShoot**

→ **Query**

Description	Returns the fall overshoot amplitude.	
Syntax	:MEASure:FOVShoot{?}	
Related Commands	:MEASure:SOURce<X>	
Return parameter	<NR3>	Returns the fall overshoot as a percentage
	Chan Off	Indicates the source channel is not activated.
Note	Before using this command, select the measurement channel. See the example below.	



Example           :MEASure:SOURce1 CH1  
                   :MEASure:FOVShoot?  
                   1.27E+0  
 Selects Channel 1, and then measures the fall overshoot.

**:MEASure:FPReshoot** → Query

Description       Returns fall preshoot amplitude.

Syntax            :MEASure:FPReshoot{?}

Related Commands   :MEASure:SOURce<X>

Returns           Returns the fall preshoot as <NR3>.

Return parameter	<NR3>	Returns the fall preshoot as a percentage.
	Chan Off	Indicates the source channel is not activated.

Note              Before using this command, select the measurement channel. See the example below.

Example           :MEASure:SOURce1 CH1  
                   :MEASure:FPReshoot?  
 Selects Channel 1, and then measures the fall preshoot.

**:MEASure:FREQuency** → Query

Description       Returns the frequency value.

Syntax            :MEASure:FREQuency{?}

Related Commands   :MEASure:SOURce<X>

Return parameter	<NR3>	Returns the frequency in Hz.
	Chan Off	Indicates the source channel is not activated.

Note Before using this command, select the measurement channel. See the example below.

Example :MEASure:SOURce1 CH1  
 :MEASure:FREQuency?  
 >1.0E+3  
 Selects Channel 1, and then measures the frequency.

**:MEASure:NWIDth** → Query

Description Returns the first negative pulse width timing.

Syntax :MEASure:NWIDth{?}

Related Commands :MEASure:SOURce<X>

Return parameter	<NR3>	Returns the negative pulse width in seconds.
	Chan Off	Indicates the source channel is not activated.

Note Before using this command, select the measurement channel. See the example below.

Example :MEASure:SOURce1 CH1  
 :MEASure:NWIDth?  
 4.995E-04  
 Selects Channel 1, and then measures the negative pulse width.

**:MEASure:PDUTy** → Query

Description Returns the positive duty cycle ratio as percentage.

Syntax :MEASure:PDUTy{?}

Related commands :MEASure:SOURce<X>

Return parameter	<NR3>	Returns the positive duty ratio.
------------------	-------	----------------------------------

Chan Off	Indicates the source channel is not activated.
----------	--

**Note** Before using this command, select the measurement channel. See the example below.

**Example** :MEASure:SOURce1 CH1  
 :MEASure:PDUTy?  
 5.000E+01  
 Selects Channel 1, and then measures the positive duty cycle.

**:MEASure:PERiod** → Query

**Description** Returns the period.

**Syntax** :MEASure:PERiod{?}

**Related Commands** :MEASure:SOURce<X>

<b>Return parameter</b> <NR3>	Returns the period.
Chan Off	Indicates the source channel is not activated.

**Note** Before using this command, select the measurement channel. See the example below.

**Example** :MEASure:SOURce1 CH1  
 :MEASure:PERiod?  
 1.0E-3  
 Selects Channel 1, and then measures the period.

**:MEASure:PWIDth** → Query

**Description** Returns the first positive pulse width.

**Syntax** :MEASure:PWIDth{?}

**Related Commands** :MEASure:SOURce<X>

Return parameter	<NR3>	Returns the positive pulse width.
	Chan Off	Indicates the source channel is not activated.

**Note** Before using this command, select the measurement channel. See the example below.

**Example** :MEASure:SOURce1 CH1  
 :MEASure:PWIDth?  
 5.0E-6  
 Selects Channel 1, and then measures the positive pulse width.

**:MEASure:RISe** → Query

**Description** Returns the first pulse rise time.

**Syntax** :MEASure:RISe{?}

**Related Commands** :MEASure:SOURce<X>

Return parameter	<NR3>	Returns the rise time.
	Chan Off	Indicates the source channel is not activated.

**Note** Before using this command, select the measurement channel. See the example below.

**Example** :MEASure:SOURce1 CH1  
 :MEASure:RISe?  
 8.5E-6  
 Selects Channel 1, and then measures the rise time.

**:MEASure:ROVShoot** → Query

**Description** Returns the rising overshoot over the entire waveform in percentage.

**Syntax** :MEASure:ROVShoot{?}

Related Commands	:MEASure:SOURce<X>	
Return parameter	<NR3>	Returns the overshoot.
	Chan Off	Indicates the source channel is not activated.
Note	Before using this command, select the measurement channel. See the example below.	
Example	:MEASure:SOURce1 CH1 :MEASure:ROVShoot? 5.00E+00 Selects Channel 1, and then measures the rise overshoot.	

**:MEASure:RPReshoot** → Query

Description	Returns rising preshoot over the entire waveform in percentage.	
Syntax	:MEASure:RPReshoot{?}	
Related Commands	:MEASure:SOURce<X>	
Return parameter	<NR3>	Returns the rising preshoot.
	Chan Off	Indicates the source channel is not activated.
Note	Before using this command, select the measurement channel. See the example below.	
Example	:MEASure:SOURce1 CH1 :MEASure:RPReshoot? 2.13E-2 Selects Channel 1, and then measures the rise preshoot.	

**:MEASure:PPULSE**

→ Query

Description	Returns the number of positive pulses.	
Syntax	:MEASure:PPULSE{?}	
Related Commands	:MEASure:SOURce<X>	
Return parameter	<NR3>	Returns the number of positive pulses.
	Chan Off	Indicates the source channel is not activated.
Note	Before using this command, select the measurement channel. See the example below.	
Example	:MEASure:SOURce1 CH1	
	:MEASure:PPULSE?	
	6.000E+00	
	Selects Channel 1, and then measures the number of positive pulses.	

**:MEASure:NPULSE**

→ Query

Description	Returns the number of negative pulses.	
Syntax	:MEASure:NPULSE{?}	
Related Commands	:MEASure:SOURce<X>	
Return parameter	<NR3>	Returns the number of negative pulses.
	Chan Off	Indicates the source channel is not activated.

Note Before using this command, select the measurement channel. See the example below.

Example :MEASure:SOURce1 CH1  
 :MEASure:NPULSE?  
 4.000E+00  
 Selects Channel 1, and then measures the number of negative pulses.

**:MEASure:PEDGE** → Query

Description Returns the number of positive edges.

Syntax :MEASure:PEDGE{?}

Related Commands :MEASure:SOURce<X>

Return parameter	<NR3>	Returns the number of positive edges.
	Chan Off	Indicates the source channel is not activated.

Note Before using this command, select the measurement channel. See the example below.

Example :MEASure:SOURce1 CH1  
 :MEASure:PEDGE?  
 1.100E+01  
 Selects Channel 1, and then measures the number of positive edges.

**:MEASure:NEDGE** → Query

Description Returns the number of negative edges.

Syntax :MEASure:NEDGE{?}

Related Commands :MEASure:SOURce<X>

Return parameter	<NR3> Chan Off	Returns the number of negative edges. Indicates the source channel is not activated.
------------------	-------------------	---

**Note** Before using this command, select the measurement channel. See the example below.

**Example** :MEASure:SOURce1 CH1  
:MEASure:NEDGE?  
1.100E+01  
Selects Channel 1, and then measures the number of negative edges.

**:MEASure:AMplitude** → Query

**Description** Returns the amplitude difference between the Vhigh-Vlow.

**Syntax** :MEASure:AMplitude{?}

**Related Commands** :MEASure:SOURce<X>

Return parameter	<NR3> Chan Off	Returns the amplitude. Indicates the source channel is not activated.
------------------	-------------------	--

**Note** Before using this command, select the measurement channel. See the example below.

**Example** :MEASure:SOURce1 CH1  
:MEASure:AMplitude?  
3.76E-3  
Selects Channel 1, and then measures the amplitude.

**:MEASure:MEAN** → Query

**Description** Returns the mean voltage/current of one or more full periods.



Syntax	:MEASure:MEAN{?}	
Related Commands	:MEASure:SOURce<X>	
Return parameter	<NR3>	Returns the mean.
	Chan Off	Indicates the source channel is not activated.
Note	Before using this command, select the measurement channel. See the example below.	
Example	<pre>:MEASure:SOURce1 CH1 :MEASure:MEAN? 1.82E-3</pre> Selects Channel 1, and then measures the mean value.	

## :MEASure:CMEan



Description	Returns the mean voltage/current of one full period.	
Syntax	:MEASure:CMEan{?}	
Related Commands	:MEASure:SOURce<X>	
Return parameter	<NR3>	Returns the cyclic mean.
	Chan Off	Indicates the source channel is not activated.
Note	Before using this command, select the measurement channel. See the example below.	
Example	<pre>:MEASure:SOURce1 CH1 :MEASure:CMEan? 9.480E-01</pre> Selects Channel 1, and then measures the mean value of the first period.	

**:MEASure:HIGH**

→ Query

Description	Returns the global high voltage/current.	
Syntax	:MEASure:HIGH{?}	
Related Commands	:MEASure:SOURce<X>	
Return parameter	<NR3>	Returns the high value.
	Chan Off	Indicates the source channel is not activated.
Note	Before using this command, select the measurement channel. See the example below.	
Example	:MEASure:SOURce1 CH1	
	:MEASure:HIGH?	
	3.68E-3	
	Selects Channel 1, and then measures the high voltage/current.	

**:MEASure:LOW**

→ Query

Description	Returns the global low voltage/current.	
Syntax	:MEASure:LOW{?}	
Related Commands	:MEASure:SOURce<X>	
Return parameter	<NR3>	Returns the global low value.
	Chan Off	Indicates the source channel is not activated.
Note	Before using this command, select the measurement channel. See the example below.	

Example           :MEASure:SOURce1 CH1  
                   :MEASure:LOW?  
                   1.00E-0  
 Selects Channel 1, and then measures the low current/voltage.

**:MEASure:MAX** → Query

Description       Returns the maximum amplitude.

Syntax            :MEASure:MAX{?}

Related Commands   :MEASure:SOURce<X>

Return parameter	<NR3>	Returns the maximum amplitude.
	Chan Off	Indicates the source channel is not activated.

Note              Before using this command, select the measurement channel. See the example below.

Example           :MEASure:SOURce1 CH1  
                   :MEASure:MAX?  
                   1.90E-3  
 Selects Channel 1, and then measures the maximum amplitude.

**:MEASure:MIN** → Query

Description       Returns the minimum amplitude.

Syntax            :MEASure:MIN{?}

Related Commands   :MEASure:SOURce<X>

Return parameter	<NR3>	Returns the minimum amplitude.
	Chan Off	Indicates the source channel is not activated.

Note Before using this command, select the measurement channel. See the example below.

Example :MEASure:SOURce1 CH1  
 :MEASure:MIN?  
 -8.00E-3  
 Selects Channel 1, and then measures the minimum amplitude.

**:MEASure:PK2PK** → Query

Description Returns the peak-to-peak amplitude (difference between maximum and minimum amplitude).

Syntax :MEASure:PK2Pk{?}

Related Commands :MEASure:SOURce<X>

Return parameter	<NR3>	Returns the voltage or current peak to peak measurement.
	Chan Off	Indicates the source channel is not activated.

Note Before using this command, select the measurement channel. See the example below.

Example :MEASure:SOURce1 CH1  
 :MEASure:PK2Pk?  
 2.04E-1  
 Selects Channel 1, and then measures the peak-to-peak amplitude.

**:MEASure:RMS** → Query

Description Returns the root-mean-square voltage/current of one or more full periods.

Syntax :MEASure:RMS{?}

Related Commands	:MEASure:SOURce<X>	
Return parameter	<NR3>	Returns the RMS value.
	Chan Off	Indicates the source channel is not activated.
Note	Before using this command, select the measurement channel. See the example below.	
Example	:MEASure:SOURce1 CH1 :MEASure:RMS? 1.31E-3 Selects Channel 1, and then measures the RMS voltage/current.	

**:MEASure:CRMS** → Query

Description	Returns the root-mean-square voltage/current of one full period.	
Syntax	:MEASure:CRMS{?}	
Related Commands	:MEASure:SOURce<X>	
Return parameter	<NR3>	Returns the CRMS value.
	Chan Off	Indicates the source channel is not activated.
Note	Before using this command, select the measurement channel. See the example below.	
Example	:MEASure:SOURce1 CH1 :MEASure:CRMS? 1.31E-3 Selects Channel 1, and then measures the CRMS voltage/current.	

**:MEASure:AREa**

→ **Query**

Description	Returns the voltage/current area over one or more full periods.	
Syntax	:MEASure:AREa{?}	
Related Commands	:MEASure:SOURce<X>	
Return parameter	<NR3>	Returns the area value.
	Chan Off	Indicates the source channel is not activated.
Note	Before using this command, select the measurement channel. See the example below.	
Example	:MEASure:SOURce1 CH1 :MEASure:AREa? 1.958E-03 Selects Channel 1, and then measures the area.	

**:MEASure:CARea**

→ **Query**

Description	Returns the voltage/current area over one full period.	
Syntax	:MEASure:CARea{?}	
Related Commands	:MEASure:SOURce<X>	
Return parameter	<NR3>	Returns the area value.
	Chan Off	Indicates the source channel is not activated.
Note	Before using this command, select the measurement channel. See the example below.	

Example :MEASure:SOURce1 CH1  
 :MEASure:CARea?  
 1.958E-03  
 Selects Channel 1, and then measures the area.

**:MEASure:FRRDelay** → Query

Description Returns the delay between the first rising edge of source1 and the first rising edge of source2.

Syntax :MEASure:FRRDelay{?}

Related Commands :MEASure:SOURce<X>

Return parameter	<NR3>	Returns the delay.
	Chan Off	Indicates the source channel is not activated.

Note Select the two source channels before entering this command.

Example :MEASure:SOURce1 CH1  
 :MEASure:SOURce2 CH2  
 :MEASure:FRRDelay?  
 -4.68E-6  
 Select channel 1 and 2 as source1/2, and then measure FRR.

**:MEASure:FRFDelay** → Query

Description Returns the delay between the first rising edge of source1 and the first falling edge of source2.

Syntax :MEASure:FRFDelay{?}

Related Commands :MEASure:SOURce<X>

Return parameter	<NR3> Chan Off	Returns the delay. Indicates the source channel is not activated.
Note	Select the two source channels before entering this command.	
Example	<pre>:MEASure:SOURce1 CH1 :MEASure:SOURce2 CH2 :MEASure:FRFDelay? 3.43E-6</pre> <p>Select channel 1 and 2 as source1/2, and then measures FRF.</p>	

**:MEASure:FRFDelay** → Query

Description	Returns the delay between the first falling edge of source1 and the first rising edge of source2.	
Syntax	:MEASure:FRRDelay{?}	
Related Commands	:MEASure:SOURce<X>	
Return parameter	<NR3> Chan Off	Returns the delay. Indicates the source channel is not activated.
Note	Select the two source channels before entering this command.	
Example	<pre>:MEASure:SOURce1 CH1 :MEASure:SOURce2 CH2 :MEASure:FRRDelay? -8.56E-6</pre> <p>Select channel 1 and 2 as delay source1/2, and then measure FFR.</p>	



**:MEASure:FFFDelay** → Query

**Description** Returns the delay between the first falling edge of source1 and the first falling edge of source2.

**Syntax** :MEASure:FFFDelay{?}

**Related Commands** :MEASure:SOURce<X>

<b>Return parameter</b>	<b>&lt;NR3&gt;</b>	Returns the delay.
	<b>Chan Off</b>	Indicates the source channel is not activated.

**Note** Select the two source channels before entering this command.

**Example**

```
:MEASure:SOURce1 CH1
:MEASure:SOURce2 CH2
:MEASure:FFFDelay?
-8.89E-6
```

Select channel 1 and 2 as delay source1/2, and then measure FFF.

**:MEASure:LRRDelay** → Query

**Description** Returns the delay between the first rising edge of source1 and the last rising edge of source2.

**Syntax** :MEASure:LRRDelay{?}

**Related Commands** :MEASure:SOURce<X>

<b>Return parameter</b>	<b>&lt;NR3&gt;</b>	Returns the delay.
	<b>Chan Off</b>	Indicates the source channel is not activated.

**Note** Select the two source channels before entering this command.

Example :MEASure:SOURce1 CH1  
 :MEASure:SOURce2 CH2  
 :MEASure:LRRDelay?  
 -8.89E-6  
 Select channel 1 and 2 as delay source1/2, and then measure LRR.

**:MEASure:LRFDelay** → Query

Description Returns the delay between the first rising edge of source1 and the last rising edge of source2.

Syntax :MEASure:LRFDelay{?}

Related Commands :MEASure:SOURce<X>

Return parameter	<NR3>	Returns the delay.
	Chan Off	Indicates the source channel is not activated.

Note Select the two source channels before entering this command.

Example :MEASure:SOURce1 CH1  
 :MEASure:SOURce2 CH2  
 :MEASure:LRFDelay?  
 -4.99E-6  
 Select channel 1 and 2 as delay source1/2, and then measure LRF.

**:MEASure:LFRDelay** → Query

Description Returns the delay between the first falling edge of source1 and the last rising edge of source2.

Syntax :MEASure:LFRDelay{?}

Related Commands :MEASure:SOURce<X>

Return parameter	<NR3>	Returns the delay.
	Chan Off	Indicates the source channel is not activated.

**Note** Select the two source channels before entering this command.

**Example**

```
:MEASure:SOURce1 CH1
:MEASure:SOURce2 CH2
:MEASure:LFRDelay?
-9.99E-6
```

Select channel 1 and 2 as delay source1/2, and then measure LFR.

**:MEASure:LFFDelay** → **Query**

**Description** Returns the delay between the first falling edge of source1 and the last falling edge of source2.

**Syntax** :MEASure:LFFDelay{?}

**Related Commands** :MEASure:SOURce<X>

Return parameter	<NR3>	Returns the delay.
	Chan Off	Indicates the source channel is not activated.

**Note** Select the two source channels before entering this command.

**Example**

```
:MEASure:SOURce1 CH1
:MEASure:SOURce2 CH2
:MEASure:LFFDelay?
-9.99E-6
```

Select channel 1 and 2 as delay source1/2, and then measure LFF.

**:MEASure:PHase**

→ **Query**

Description	Returns the phase between source 1 and source 2.	
Syntax	:MEASure:PHase{?}	
Related Commands	:MEASure:SOURce<X>	
Return parameter	<NR3>	Returns the phase difference.
	Chan Off	Indicates the source channel is not activated.
Note	Select the two source channels before entering this command.	
Example	:MEASure:SOURce1 CH1 :MEASure:SOURce2 CH2 :MEASure:PHase? 4.50E+01 Select channel 1 and 2 as phase source1/2, and then measure the phase in degrees.	

## Measurement Commands

:MEASUrement:MEAS<X>:SOURCE<X> .....101  
 :MEASUrement:MEAS<X>:TYPE .....102  
 :MEASUrement:MEAS<X>:STATE .....102  
 :MEASUrement:MEAS<X>:VALue .....103  
 :MEASUrement:MEAS<X>:MAXimum .....104  
 :MEASUrement:MEAS<X>:MEAN .....105  
 :MEASUrement:MEAS<X>:MINimum .....105  
 :MEASUrement:MEAS<X>:STDdev .....106  
 :MEASUrement:STATIstics:MODE .....107  
 :MEASUrement:STATIstics:WEIghting .....107  
 :MEASUrement:STATIstics .....108

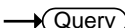
:MEASUrement:MEAS<X>:SOURCE<X>  

Description	Sets or queries the measurement source for a selected automatic measurement. This is a statistics related command.	
Syntax	:MEASUrement:MEAS<X>:SOURCE<X> { CH1   CH2   CH3   CH4   MATH   ? }	
Related commands	:MEASUrement:MEAS<X>:TYPE	
Parameter	MEAS<X>	The automatic measurement number from 1 to 8.
	SOURCE<X>	SOURCE1: the source for all single channel measurements.
	SOURCE<X>	SOURCE2: the source for all delay or phase measurements.
	CH1 to CH4	Channel 1, 2, 3, 4
	MATH	Math source

Return parameter	CH1 to CH4	Channel 1, 2, 3, 4
	MATH	Math source

Example :MEASUrement:MEAS1:SOURCE1  
>CH1  
Returns the (first) source for measurement 1.

:MEASUrement:MEAS<X>:TYPE (Set) →  
→ (Query)

Description Sets or queries the measurement type for a selected automatic measurement. This is a statistics related command.

Syntax :MEASUrement:MEAS<X>:TYPE  
{PK2pk | MAXimum | MINIMUM | AMPLitude | HIGH | LOW | MEAN | CMEan | RMS | CRM s | AREa | CARea | ROVShoot | FOVShoot | RPReshoot | FPReshoot | FREQuency | PERIod | RISE | FALL | PWIdth | NWIdth | PDUTy | PPULSE | NPULSE | PEDGE | NEDGE | FRRDelay | FRFDelay | FFRDelay | FFFDelay | LRRDelay | LRFDelay | LFRDelay | LFFDelay | PHAse | ?}

Related commands :MEASUrement:MEAS<X>:SOURCE<X>

Parameter	MEAS<X>	The automatic measurement number from 1 to 8.
-----------	---------	---

Return parameter Returns the measurement type

Example :MEASUrement:MEAS1:TYPE RMS  
Sets measurement 1 to RMS measurement.

:MEASUrement:MEAS<X>:STATE (Set) →  
→ (Query)

Description Sets or queries the state of a selected measurement. This is a statistics related command.

Syntax :MEASUrement:MEAS<X>:STATE { ON | OFF | 1 | 0 | ? }

Related commands	:MEASUrement:MEAS<X>:SOURce<X> :MEASUrement:MEAS<X>:TYPE	
Parameter	MEAS<X>	The automatic measurement number from 1 to 8.
	ON/1	Turn the measurement on.
	OFF/0	Turn the measurement off.
Return parameter	0	Measurement is off.
	1	Measurement is on.
Example	:MEASUrement:MEAS1:STATE 1 Turns measurement 1 on.	

**:MEASUrement:MEAS<X>:VALue** → Query

Description	Returns the measurement results for the selected measurement. This is a statistics related command.	
Syntax	:MEASUrement:MEAS<X>:VALue?	
Related Commands	:MEASure:SOURce<X>	
Parameter	MEAS<X>	The automatic measurement number from 1 to 8.
Return parameter	<NR3>	Returns the measurement for the selected measurement number.
Note	The measurement source(s), measurement number, measurement type and measurement state must first be set before a measurement result can be returned.	

Example                   :MEASUrement:MEAS1:SOUrce1 CH1  
                               :MEASUrement:MEAS1:TYPe PK2PK  
                               :MEASUrement:MEAS1:STATE ON  
                               :MEASUrement:MEAS1:VALue?  
                               5.000E+0

Selects channel 1 as the source for measurement 1, sets measurement 1 to peak to peak measurement and then turns on the measurement. The result returns the peak to peak measurement.

**:MEASUrement:MEAS<X>:MAXimum**                   → **Query**

Description           Returns the maximum measurement results for the selected measurement from the last time the statistics were reset. This is a statistics related command.

Syntax                :MEASUrement:MEAS<X>:MAXimum?

Related Commands    :MEASUrement:STATIstics:MODE

Parameter	MEAS<X>	The automatic measurement number from 1 to 8.
Return parameter	<NR3>	Returns the measurement for the selected measurement number.

Example                   :MEASUrement:MEAS3:SOUrce1 CH1  
                               :MEASUrement:MEAS3:TYPe PK2PK  
                               :MEASUrement:MEAS3:STATE ON  
                               :MEASUrement:STATIstics:MODE ON  
                               :MEASUrement:MEAS3:MAXimum?  
                               2.800E-02

Returns the maximum measurement result for measurement number 3.



**:MEASUrement:MEAS<X>:MEAN**

→ Query

**Description** Returns the mean measurement results for the selected measurement from the last time the statistics were reset. This is a statistics related command.

**Syntax** :MEASUrement:MEAS<X>:MEAN?

**Related Commands** :MEASUrement:STATIstics:MODE

**Parameter** MEAS<X> The automatic measurement number from 1 to 8.

**Return parameter** <NR3> Returns the measurement for the selected measurement number.

**Example** :MEASUrement:MEAS3:SOUrce1 CH1  
 :MEASUrement:MEAS3:TYPe PK2PK  
 :MEASUrement:MEAS3:STATE ON  
 :MEASUrement:STATIstics:MODE ON  
 :MEASUrement:MEAS3:MEAN?  
 2.090E-02

Returns the mean measurement result for measurement number 3.

**:MEASUrement:MEAS<X>:MINIum**

→ Query

**Description** Returns the minimum measurement results for the selected measurement from the last time the statistics were reset. This is a statistics related command.

**Syntax** :MEASUrement:MEAS<X>:MINIum?

**Related Commands** :MEASUrement:STATIstics:MODE

Parameter	MEAS<X>	The automatic measurement number from 1 to 8.
-----------	---------	---

Return parameter	<NR3>	Returns the measurement for the selected measurement number.
------------------	-------	--

Example

```
:MEASUrement:MEAS3:SOUrce1 CH1
:MEASUrement:MEAS3:TYPe PK2PK
:MEASUrement:MEAS3:STATE ON
:MEASUrement:STATIstics:MODE ON
:MEASUrement:MEAS3:MINImum?
1.600E-02
```

Returns the minimum measurement result for measurement number 3.

**:MEASUrement:MEAS<X>:STDdev** → Query

**Description** Returns the standard deviation for the selected measurement from the last time the statistics were reset. This is a statistics related command.

**Syntax** :MEASUrement:MEAS<X>:STDdev?

**Related Commands** :MEASUrement:STATIstics:MODE

Parameter	MEAS<X>	The automatic measurement number from 1 to 8.
-----------	---------	---

Return parameter	<NR3>	Returns the measurement for the selected measurement number.
------------------	-------	--

Example :MEASUrement:MEAS3:SOUrce1 CH1  
 :MEASUrement:MEAS3:TYPe PK2PK  
 :MEASUrement:MEAS3:STATE ON  
 :MEASUrement:STATIstics:MODE ON  
 :MEASUrement:MEAS3:STDdev?  
 1.530E-03  
 Returns the standard deviation for measurement number 3.

**:MEASUrement:STATIstics:MODE**

Set →

→ Query

Description Puts the statics measurement results on the display or queries whether the statistics are displayed.

Syntax :MEASUrement:STATIstics:MODE {OFF | ON | ?}

Related commands :MEASUrement:STATIstics

Parameter/ Return parameter	ON	Display the statistics on the screen.
	OFF	Remove the statistics from the screen

Example :MEASUrement:STATIstics:MODE ON  
 Displays statistics on the screen.

**:MEASUrement:STATIstics:WEIghting**

Set →

→ Query

Description Sets and queries the number of samples (weighting) used for the statistics calculations.

Syntax :MEASUrement:STATIstics:WEIghting { <NR1> | ? }

Parameter/ Return parameter	<NR1>	Number of samples (2~1000)
--------------------------------	-------	----------------------------

Example :MEASUrement:STATIstics:WEIghting 5  
 Sets the number of samples to 5.

**:MEASUrement:STATIstics****Set** →

---

Description	Resets the statics calculations. This command will clear all the currently accumulated measurements.
-------------	--

---

Syntax	:MEASUrement:STATIstics {RESET}
--------	---------------------------------

## Reference Commands

:REF<X>:DISPlay.....	109
:REF<X>:TIMebase:POSition .....	109
:REF<X>:TIMebase:SCALe .....	110
:REF<X>:OFFSet .....	110
:REF<x>:SCALe .....	111

:REF<X>:DISPlay 
 Set →  
 →  Query

**Description** Sets or queries whether a reference waveform will be shown on the display. A reference waveform must first be saved before this command can be used.

**Syntax** :REF<x>:DISPlay { OFF| ON | ? }

<b>Parameter</b>	<X>	Reference waveform 1, 2, 3, 4.
	OFF	Turns the selected reference waveform off
	ON	Turns the selected reference waveform on

**Return parameter** Returns the status of the selected reference waveform. (OFF, ON).

**Example** :REF1:DISPlay ON  
Turns on reference1 (REF 1) on the display.

:REF<X>:TIMebase:POSition 
 Set →  
 →  Query

**Description** Sets or returns the selected reference waveform time base position.

**Syntax** :REF<X>:TIMebase:POSition { <NRF> | ? }

**Related commands** :REF<X>:DISPlay

Parameter	<X>	Reference waveform 1, 2, 3, 4.
	<NRf>	Horizontal co-ordinates

Return parameter	<NR3>	Returns the reference waveform position
------------------	-------	---

Example :REF1:TIMebase:POSition -5.000E-5  
 Selects reference 1, and then sets the horizontal position to -50us.

Set →  
 → Query

---

Description	Sets or returns the selected reference waveform time base scale.	
-------------	--	--

Syntax	:REF<X>:TIMebase:SCALe { <NRf>   ?}	
--------	-------------------------------------	--

Related commands	:REF<X>:DISPlay	
------------------	-----------------	--

Parameter	<X>	Reference waveform 1, 2, 3, 4.
	<NRf>	Horizontal scale

Return parameter	<NR3>	Returns the reference waveform scale.
------------------	-------	---------------------------------------

Example :REF1:TIMebase:SCALe 5.00E-4  
 Selects reference 1, and then sets the horizontal scale to 500us/div.

Set →  
 → Query

---

Description	Sets or returns the selected reference waveform vertical position (offset).	
-------------	---	--

Syntax	:REF<X>:OFFSet { <NRf>   ?}	
--------	-----------------------------	--

Related commands	:REF<X>:DISPlay	
------------------	-----------------	--

Parameter	<X>	Reference waveform 1, 2, 3, 4.
	<NRf>	Vertical offset

Return parameter <NR3> Returns the reference waveform vertical position.

Example :REF1:OFFSet -5.000E-2  
 Selects reference 1, and then sets the vertical position to -50mV/mA.

:REF<x>:SCALE  

Description Sets or returns the selected reference waveform vertical scale.

Syntax :REF<X>:SCALE { <NRf> | ? }

Related commands :REF<X>:DISPlay

Parameter <X> Reference waveform 1, 2, 3, 4.  
 <NRf> Vertical scale

Return parameter <NR3> Returns the reference waveform vertical scale.

Example :REF1:SCALE 5.000E-2  
 Selects reference 1, and then sets the vertical scale to 50mV | mA/div.

## Run Command

---

:RUN



---

Description      The run command allows the oscilloscope to continuously make acquisitions (equivalent to pressing the Run key on the front panel).

---

Syntax            :RUN

---

## Stop Command

---

:STOP



---

Description      The stop command stops the oscilloscope making further acquisitions (equivalent to pressing the Stop key on the front panel).

---

Syntax            :STOP

---

## Single Command

---

:SINGle



---

Description      The single command allows the oscilloscope to capture a single acquisition when trigger conditions have been fulfilled (equivalent to pressing the Single key on the front panel).

---

Syntax            :SINGle

---



## Force Command

---

:FORCe



---

Description	The Force command forces an acquisition (equivalent to pressing the Force-Trig key on the front panel).
-------------	---

---

Syntax	:FORCe
--------	--------

---

## Timebase Commands

:TIMebase:EXPand .....	114
:TIMebase:POSition .....	114
:TIMebase:SCALE .....	114
:TIMebase:MODE .....	115
:TIMebase:WINDow:POSition .....	115
:TIMebase:WINDow:SCALE .....	116

:TIMebase:EXPand 

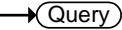

Description	Sets or queries the horizontal expansion mode.	
Syntax	:TIMebase:EXPand {CENTer TRIGger ?}	
Parameter/Return parameter	CENTer	Expand from the center of the display.
	TRIGger	Expand from the trigger point.
Example	:TIMebase:EXPand TRIGger Sets the expansion point to the trigger point.	

:TIMebase:POSition 



Description	Sets or queries the horizontal position.	
Syntax	:TIMebase:POSition {<NRf>   ?}	
Parameter	<NRf>	Horizontal position
Return parameter	<NR3>	Returns the horizontal position
Example	:TIMebase:POSition 5.00E-4 Sets the horizontal position as 500us.	

:TIMebase:SCALE 

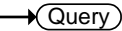

Description	Sets or queries the horizontal scale.	
-------------	---------------------------------------	--

Syntax	:TIMebase:SCALE {<NRf>   ?}	
Parameter	<NRf>	Horizontal scale
Return parameter	<NR3>	Returns the horizontal scale.
Example	:TIMebase:SCALE 5.00E-2 Sets the horizontal scale to 50ms/div.	

**:TIMebase:MODE** (Set) →  
→ (Query)

Description	Sets or queries the time base mode. The time base mode determines the display view window on the scope.	
Syntax	:TIMebase:MODE {MAIN   WINDow   XY   ?}	
Parameter	MAIN	Sets the time base mode to the main screen.
	WINDow	Sets the time base mode to the zoom window.
	XY	Sets the time base mode to the XY display.
Return parameter	Returns the time base mode (MAIN, WINDOW, XY)	
Example	:TIMebase:MODE MAIN Sets the time base mode to the main mode.	

**:TIMebase:WINDow:POSition** (Set) →  
→ (Query)

Description	Sets or queries the zoom horizontal position.	
Syntax	:TIMebase:WINDow:POSition {<NRf>   ?}	
Related commands	:TIMebase:MODE	
Parameter	<NRf>	Horizontal position for zoom window
Return parameter	<NR3>	Returns the zoom horizontal position.

Example :TIMebase:WINDow:POSition 2.0E-3  
 Sets the zoom horizontal position as 20ms.

Set →

:TIMebase:WINDow:SCALE

→ Query

Description	Sets or queries the zoom horizontal scale.	
Note	If the oscilloscope is under “ZOOM” mode, the main timebase function will be disabled and cannot be modified.	
Syntax	:TIMebase:WINDow:SCALE {<NRf>   ?}	
Related commands	:TIMebase:MODE	
Parameter	<NRf>	Zoom horizontal scale. The range will depend on the time base.
Return parameter	<NR3>	Returns the zoom horizontal scale.
Example	:TIMebase:WINDow:SCALE 2.0E-3 Sets the zoom horizontal scale to 2ms.	

## Trigger Commands

---

:TRIGger:FREQuency.....	118
:TRIGger:TYPe.....	118
:TRIGger:SOURce.....	119
:TRIGger:COUPle.....	119
:TRIGger:NREJ.....	119
:TRIGger:MODE.....	120
:TRIGger:HOLDoff.....	120
:TRIGger:LEVel.....	120
:TRIGger:HLEVel.....	121
:TRIGger:LLEVel.....	121
:TRIGger:EDGE:SLOP.....	122
:TRIGger:DELaY:SLOP.....	122
:TRIGger:DELaY:TYPe.....	123
:TRIGger:DELaY:TIME.....	123
:TRIGger:DELaY:EVENT.....	123
:TRIGger:DELaY:LEVel.....	124
:TRIGger:PULSEWidth:POLarity.....	124
:TRIGger:RUNT:POLarity.....	125
:TRIGger:RUNT:WHEn.....	125
:TRIGger:RUNT:TIME.....	126
:TRIGger:RISEFall:SLOP.....	126
:TRIGger:RISEFall:WHEn.....	126
:TRIGger:RISEFall:TIME.....	127
:TRIGger:VIDeo:TYPe.....	127
:TRIGger:VIDeo:FIELD.....	128
:TRIGger:VIDeo:LINE.....	129
:TRIGger:VIDeo:POLarity.....	129
:TRIGger:PULSe:WHEn.....	129
:TRIGger:PULSe:TIME.....	130
:TRIGger:TIMEOut:WHEn.....	130
:TRIGger:TIMEOut:TIMER.....	131
:TRIGger:ALTErnate.....	131

:TRIGger:STATe .....131  
 :TRIGger:EXTERnal:PROBe:TYPe.....132  
 :TRIGger:EXTERnal:PROBe:RATio .....133

**:TRIGger:FREQuency** → Query

Description	Queries the trigger frequency.
Syntax	:TRIGger:FREQuency{?}
Return parameter	<NR3> Returns the trigger frequency.
Example	:TRIGger:FREQuency? 1.032E+3 Returns the trigger frequency.

Set →

**:TRIGger:TYPe** → Query

Description	Sets or queries the trigger type.
Syntax	:TRIGger:TYPe {EDGE   DELay   PULSEWidth   VIDEo   RUNT   RISEFall   TIMEOut   ? }
Parameter	EDGE Edge trigger DELay Delay trigger PULSEWidth Pulse width trigger VIDeo Video trigger RUNT Runt trigger RISEFall Rise and fall trigger TIMEOut Timeout trigger
Return parameter	Returns the trigger type.
Example	:TRIGger:TYPe EDGE Sets the trigger type to edge.

**:TRIGger:SOURce** 

Description	Sets or queries the trigger source.	
Syntax	:TRIGger:SOURce { CH1   CH2   CH3   CH4   EXT   LINe   ? }	
Parameter	CH1 to CH4	Channel 1 to channel 4
	EXT	External source
	LINe	AC Line
Return parameter	Returns the trigger source.	
Example	:TRIGger:SOURce CH1 Sets the trigger source to channel 1.	

**:TRIGger:COUPlE** 

Description	Sets or queries the trigger coupling.	
Note	Applicable for edge and delay triggers only.	
Syntax	:TRIGger:COUPlE {AC   DC   HF   LF   ?}	
Parameter	AC	AC mode
	DC	DC mode
	HF	High frequency rejection
	LF	Low frequency rejection
Return parameter	Returns the trigger coupling.	
Example	:TRIGger:COUPlE AC Sets the trigger coupling to AC.	

**:TRIGger:NREJ** 

Description	Sets or queries noise rejection status.	
Syntax	:TRIGger:NREJ {OFF  ON  ?}	

Parameter	OFF	Turns noise rejection off
	ON	Turns noise rejection on

Return parameter Returns the noise rejection status (ON, OFF).

Example :TRIGger:NREJ ON  
Turns noise rejection on.

Set →

→ Query

**:TRIGger:MODE**

Description Sets or queries the trigger mode.

Syntax :TRIGger:MODE {AUTo | NORMal | ?}

Parameter	AUTo	Auto trigger (Untriggered roll)
	NORMal	Normal trigger

Return parameter Returns the trigger mode.

Example :TRIGger:MODE NORMal  
Sets the trigger mode to normal.

Set →

→ Query

**:TRIGger:HOLDoff**

Description Sets or queries the holdoff time.

Syntax :TRIGger:HOLDoff {<NRf> | ?}

Parameter	<NRf>	Holdoff time
-----------	-------	--------------

Return parameter <NR3> Returns the trigger holdoff time.

Example :TRIGger:HOLDoff 1.00E-8  
Sets the trigger holdoff time to 10ns.

Set →

→ Query

**:TRIGger:LEVel**

Description Sets or queries the level.

Note Not applicable to Pulse Runt and Rise & Fall triggers.



Syntax	:TRIGger:LEVel {TTL   ECL   SETTO50   <NRf>   ?}	
Related commands	:TRIGger:TYPe	
Parameter	<NRf>	Trigger level value.
	TTL	Sets the trigger level to TTL.
	ECL	Sets the trigger level to ECL.
	SETTO50	Sets the trigger level to the User level (50% by default).
Return parameter	<NR3>	Returns the trigger level.
Example1	:TRIGger:LEVel TTL Sets the trigger to TTL.	
Example2	:TRIGger:LEVel 3.30E-1 Sets the trigger level to 330mV/mA.	

**:TRIGger:HLEVel**

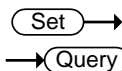

Description	Sets or queries the high trigger level.	
Note	Applicable for Rise and Fall/Pulse Runt triggers.	
Syntax	:TRIGger:HLEVel {<NRf>   ?}	
Related commands	:TRIGger:TYPe	
Parameter	<NRf>	High level value.
Return parameter	<NR3>	Returns the trigger high level.
Example	:TRIGger:HLEVel 3.30E-1 Sets the trigger high level to 330mV/mA.	

**:TRIGger:LLEVel**

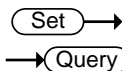

Description	Sets or queries the low trigger level.	
Note	Applicable for Rise and Fall/Pulse Runt triggers.	

Syntax	:TRIGger:LLEVel {<NRf>   ?}	
Related commands	:TRIGger:TYPe	
Parameter	<NRf>	Low level value.
Return parameter	<NR3>	Returns the trigger low level.
Example	:TRIGger:LLEVel -3.30E-3 Sets the trigger low level to -330mV/mA.	

Set →

→ Query

**:TRIGger:EDGE:SLOP**

Description	Sets or queries the trigger slope.	
Syntax	:TRIGger:EDGE:SLOP {RISe   FALL   EITHer   ? }	
Related commands	:TRIGger:TYPe	
Parameter	RISe	Rising slope
	FALL	Falling slope
	EITHer	Either rising or falling slope
Return parameter	Returns the trigger slope.	
Example	:TRIGger:EDGE:SLOP FALL Sets the trigger slope to falling.	

Set →

→ Query

**:TRIGger:DELAy:SLOP**

Description	Sets or queries the trigger slope for the delay trigger.	
Syntax	:TRIGger:DELAy:SLOP {RISe   FALL   EITHer   ? }	
Related commands	:TRIGger:TYPe	
Parameter	RISe	Rising slope
	FALL	Falling slope
	EITHer	Either rising or falling slope

Return parameter Returns the trigger slope.

Example :TRIGger:DELay:SLOP FALL  
Sets the trigger slope to falling.

Set →

→ Query

### :TRIGger:DELay:TYPE

Description Sets or queries the trigger delay type.

Syntax :TRIGger:DELay:TYPE {TIME | EVENT | ?}

Related commands :TRIGger:TYPE

Parameter	TIME	Sets the delay type to time.
	EVENT	Sets the delay type to event.

Return parameter Returns the trigger delay type.

Example :TRIGger:DELay:TYPE TIME  
Sets the delay type to time delay.

Set →

→ Query

### :TRIGger:DELay:TIME

Description Sets or queries the delay time value.

Syntax :TRIGger:DELay:TIME {<NRf> | ?}

Related commands :TRIGger:DELay:TYPE

Parameter	<NRf>	Delay time (1.00E-8~1.00E+1)
-----------	-------	------------------------------

Return parameter	<NR3>	Returns the delay time.
------------------	-------	-------------------------

Example :TRIGger:DELay:TIME 1.00E-6  
Sets the delay time to 1us.

Set →

→ Query

### :TRIGger:DELay:EVENT

Description Sets or queries the number of events for the event delay trigger.

Syntax	:TRIGger:DElay:EVENT {<NR1>   ?}	
Related commands	:TRIGger:DElay:TYPe	
Parameter	<NR1>	1~65535 events
Return parameter	<NR1>	Returns the number of events.
Example	:TRIGger:DElay:EVENT 2 Sets the number of events to 2.	

Set →  
 → Query

---

**:TRIGger:DElay:LEVel**

Description	Sets or queries the trigger delay level.	
Syntax	:TRIGger:DElay:LEVel {<NRf>   ?}	
Parameter	<NRf>	Delay trigger level
Return parameter	<NR3>	Returns the delay trigger.
Example	:TRIGger:DElay:LEVel 5.00E-3 Sets the delay trigger level to 5mV/ mA.	

Set →  
 → Query

---

**:TRIGger:PULSEWidth:POLarity**

Description	Sets or queries the pulse width trigger polarity.	
Syntax	:TRIGger:PULSEWidth:POLarity {POSitive   NEGative   ?}	
Related commands	:TRIGger:TYPe	
Parameter	POSitive	Positive polarity
	NEGative	Negative polarity
Return parameter	Returns the pulse width polarity.	
Example	:TRIGger:PULSEWidth:POLarity POSitive Sets the pulse width polarity to positive.	

**:TRIGger:RUNT:POLarity** 

Description	Sets or queries the Pulse Runt trigger polarity.	
Syntax	:TRIGger:RUNT:POLarity { POSitive   NEGative   EITher   ? }	
Related commands	:TRIGger:TYPE	
Parameter	POSitive	Positive polarity
	NEGative	Negative polarity
	EITher	Positive or negative polarity
Return parameter	Returns the pulse runt trigger polarity.	
Example	:TRIGger:RUNT:POLarity POSitive Sets the Pulse Runt trigger polarity to positive.	

**:TRIGger:RUNT:WHEn** 

Description	Sets or queries the Pulse Runt trigger conditions.	
Syntax	:TRIGger:RUNT:WHEn { MOREthan   LESSthan   EQual   UNEQual   ? }	
Related commands	:TRIGger:TYPE :TRIGger:RUNT:TIME	
Parameter	MOREthan	>
	LESSthan	<
	EQual	=
	UNEQual	≠
Return parameter	Returns the pulse runt trigger condition.	
Example	:TRIGger:RUNT:WHEn UNEQual Sets the Pulse Runt trigger condition to unequal (≠).	

Set →  
 → Query

**:TRIGger:RUNT:TIME**

---

Description	Sets or queries the Pulse Runt trigger time.	
Syntax	:TRIGger:RUNT:TIME {<NRf>   ? }	
Related commands	:TRIGger:TYPe :TRIGger:RUNT:WHEn	
Parameter	<NRf>	Pulse runt time (4nS to 10S)
Return Parameter	<NR3>	Returns the runt time in seconds
Example	:TRIGger:RUNT:TIME 4.00E-5 Sets the runt time to 40.0uS.	

Set →  
 → Query

**:TRIGger:RISEFall:SLOP**

---

Description	Sets or queries the Rise & Fall slope.	
Syntax	:TRIGger:RISEFall:SLOP {RISe   FALL   EITHer   ? }	
Parameter	RISe	Rising slope
	FALL	Falling slope
	EITHer	Either rising or falling slope
Return parameter	Returns the rise & fall slope.	
Example	:TRIGger:RISEFall:SLOP RISe Sets the Rise & Fall slope to rising.	

Set →  
 → Query

**:TRIGger:RISEFall:WHEn**

---

Description	Sets or queries the rise/fall trigger conditions.	
Syntax	:TRIGger:RISEFall:WHEn {MOREthan   LESSthan   EQual   UNEQual   ? }	
Related commands	:TRIGger:TYPe :TRIGger:RISEFall:TIME	

Parameter	MOREthan	>
	LESSthan	<
	Equal	=
	UNEQual	≠

Return parameter Returns the rise/fall trigger condition.

Example :TRIGger:RISEFall:WHEn UNEQual  
Sets the Rise and Fall trigger condition to unequal (≠).

:TRIGger:RISEFall:TIME (Set) →  
→ (Query)

Description Sets or queries the Rise and Fall time.

Syntax :TRIGger:RISEFall:TIME {<NRf> | ? }

Related commands :TRIGger:TYPe  
:TRIGger:RISEFall:WHEn

Parameter	<NRf>	Rise and Fall time (4nS to 10S)
Return Parameter	<NR3>	Returns the rise and fall time in seconds

Example :TRIGger:RISEFall:TIME 4.00E-5  
Sets the trigger rise & fall to 40.0us.

:TRIGger:VIDeo:TYPe (Set) →  
→ (Query)

Description Sets or queries the video trigger type.

Syntax :TRIGger:VIDeo:TYPe {NTSC | PAL | SECam | EDTV480P | EDTV576P | HDTV720P | HDTV1080I | HDTV1080P | ? }

Related commands :TRIGger:TYPe

Parameter	NTSC	NTSC
	PAL	PAL
	SECAM	SECAM
	EDTV480P	Extra definition TV 480P
	EDTV576P	Extra definition TV 576P
	HDTV720P	High definition TV 720P
	HDTV1080I	High definition TV 1080i
	HDTV1080P	High definition TV 1080P

Return parameter Returns the video trigger type.

Example :TRIGger:VIDeo:TYPe NTSC  
Sets the video trigger to NTSC.

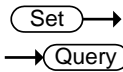

:TRIGger:VIDeo:FIELD

Description Sets or queries the video trigger field.

Syntax :TRIGger:VIDeo:FIELD { FIELD1 | FIELD2 | ALLFields | ALLLines | ? }

Related commands :TRIGger:TYPe

Parameter	FIELD1	Trigger on field 1
	FIELD2	Trigger on field 2
	ALLFields	Trigger on all fields
	ALLLines	Trigger on all lines

Return parameter Returns the video trigger field.

Example :TRIGger:VIDeo:FIELD ALLFields  
Sets the video trigger to trigger on all fields.



Set →  
 → Query

**:TRIGger:VIDeo:LINE**

Description	Sets or queries the video trigger line.	
Syntax	:TRIGger:VIDeo:LINE {<NR1>   ?}	
Related commands	:TRIGger:TYPE	
Parameter	<NR1>	Video line
Return parameter	<NR3>	Returns the video trigger line.
Example	:TRIGger:VIDeo:LINE 1 Sets the video trigger to line 1.	

Set →  
 → Query

**:TRIGger:VIDeo:POLarity**

Description	Sets or queries the video trigger polarity.	
Syntax	:TRIGger:VIDeo:POLarity { POSitive   NEGative   ? }	
Related commands	:TRIGger:TYPE	
Parameter	POSitive	Positive polarity
	NEGative	Negative polarity
Return parameter	Returns the video trigger polarity.	
Example	:TRIGger:VIDeo:POLarity POSitive Sets the video trigger polarity to positive.	

Set →  
 → Query

**:TRIGger:PULSe:WHEn**

Description	Sets or queries the pulse width trigger conditions.	
Syntax	:TRIGger:PULSe:WHEn { MOREthan   LESSthan   EQUAL   UNEQUAL   ? }	
Related commands	:TRIGger:TYPE :TRIGger:PULSe:TIME	

Parameter	MORE than	>
	LESS than	<
	Equal	=
	UNEQUAL	≠

Return parameter Returns the pulse width trigger conditions.

Example :TRIGger:PULSe:WHEn UNEQUAL  
Sets the trigger pulse width conditions to not equal to (≠).

:TRIGger:PULSe:TIME (Set) →  
→ (Query)

Description Sets or queries the pulse width time.

Syntax :TRIGger:PULSe:TIME {<NRf> | ?}

Related commands :TRIGger:TYPe  
:TRIGger:PULSe:WHEn

Parameter	<NRf>	Pulse width time (4ns~10s)
-----------	-------	----------------------------

Return parameter	<NR3>	Returns the pulse width time in seconds.
------------------	-------	--

Example :TRIGger:PULSe:TIME 4.00E-5  
Sets the trigger pulse width to 40.0us.

:TRIGger:TIMEOut:WHEn (Set) →  
→ (Query)

Description Sets or queries the timeout trigger condition.

Syntax :TRIGger:TIMEOut:WHEn {HIGH|LOW|EITHER|?}

Related commands :TRIGger:TIMEOut:TIMER

Parameter	HIGH	Signal is high.
	LOW	Signal is low.
	EITHER	Signal is high or low.

Return parameter Returns the timeout condition (HIGH, LOW, EITHER).

Example1 :TRIGger:TIMEOut:WHEn LOW

Sets the timeout condition to low.

Set →

**:TRIGger:TIMEOut:TIMER**

→ Query

Description Sets or returns timeout trigger time.

Syntax :TRIGger:TIMEOut:TIMER {<NRf> | ?}

Related commands :TRIGger:TIMEOut:WHEn

Parameter <NRf> Timeout time. (4nS to 10S).

Return parameter Returns the timeout time as <NR3>.

Example :TRIGger:TIMEOut:TIMER?

8.960e-05

Set →

**:TRIGger:ALternate**

→ Query

Description Sets alternating between source triggers on or off or queries its state.

Syntax :TRIGger:ALternate {OFF | ON |?}

Parameter OFF Alternate off  
ON Alternate on

Return parameter Returns the Alternate trigger status (ON, OFF).

Example :TRIGger:ALternate ON

Turns on alternating between source triggers.

**:TRIGger:STATE**

→ Query

Description Returns the current state of the triggering system.

Syntax :TRIGger:STATE?

Return parameter	*ARMED	Indicates that the oscilloscope is acquiring pretrigger information.
	*AUTO	Indicates that the oscilloscope is in the automatic mode and acquires data even in the absence of a trigger.
	*READY	Indicates that all pretrigger information has been acquired and that the oscilloscope is ready to accept a trigger.
	*SAVE	Indicates that the oscilloscope is in save mode and is not acquiring data.
	*TRIGGER	Indicates that the oscilloscope triggered and is acquiring the post trigger information.

Example           :TRIGger:STATe?  
                   AUTO  
                   The trigger is in auto mode.

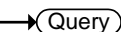
:TRIGger:EXTERnAl:PROBE:TYPE  

Description	Sets or queries the external probe type.	
Syntax	:TRIGger:EXTERnAl:PROBE:TYPE { VOLTage   CURRent   ? }	
Related commands	:TRIGger:EXTERnAl:PROBE:RATio	
Parameter	VOLTage	Voltage
	CURRent	Current
Return parameter	Returns the probe type.	
Example	:TRIGger:EXTERnAl:PROBE:TYPE? CURRENT	

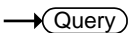
**:TRIGger:EXTERnal:PROBe:RATio** 

  

Description	Sets or queries the external probe ratio (attenuation).	
Syntax	:TRIGger:EXTERnal:PROBe:RATio {<NRf>   ?}	
Related commands	:TRIGger:EXTERnal:PROBe:TYPe	
Parameter	<NRf>	External probe attenuation factor.
Return parameter	<NR3>	Returns the probe attenuation factor.
Example	:TRIGger:EXTERnal:PROBe:RATio? 5.000000e+01	

## System Commands

:SYSTem:LOCK .....	134
:SYSTem:ERRor .....	134

:SYSTem:LOCK 



Description	Turns the panel lock on off.	
Syntax	:SYSTem:LOCK {OFF   ON   ? }	
Parameter	OFF	System lock off
	ON	System lock on
Return parameter	Returns the status of the panel lock (ON, OFF).	
Example	:SYSTem:LOCK ON Turns the panel lock on.	

:SYSTem:ERRor 



Description	Queries the error queue. See the appendix on page 162 for details.	
Syntax	:SYSTem:ERRor?	
Return parameter	Returns the last message in the error queue.	
Example	:SYSTem:ERRor? +0, "No error."	

## Save/Recall Commands

:RECALL:SETUp .....	135
:RECALL:WAVEform .....	135
:SAVe:IMAGe .....	136
:SAVe:IMAGe:FILEFormat .....	136
:SAVe:IMAGe:INKSaver .....	137
:SAVe:SETUp .....	137
:SAVe:WAVEform .....	138
:SAVe:WAVEform:FILEFormat .....	139

### :RECALL:SETUp



Description	Recalls setup settings from memory or USB.	
Syntax	:RECALL:SETUp {S1~S20   <file path>("Disk:/xxx.SET", "USB:/xxx.SET")}	
Parameter	S1~S20	Recall Set1~Set20
	<file path>	Recall a file from the DSO internal files system or from a USB flash drive.
Example	:RECALL:SETUp S1 Recalls setup setting S1 from memory. :RECALL:SETUp "Disk:/DS0001.SET" Recall the setup setting DS0001.SET from the internal memory.	

### :RECALL:WAVEform



Description	Recalls a waveform from wave1~wave20 or from file to REF1~4.
Note	Detail CSV files cannot be recalled.
Syntax	:RECALL:WAVEform {W<n>   <file path> ("Disk:/xxx.LSF", "USB:/xxx.LSF")}, REF<X>

Parameter	n	1~20 (Wave1~wave20)
	<file page>	Filename in file path. Example: "Disk:/xxx.LSF", "USB:/xxx.LSF", "Disk:/xxx.CSV", "USB:/xxx.CSV"
	<X>	1,2,3,4 (REF1, REF2, REF3, REF4)

Example :RECALL:WAVEform W1, REF1  
 Recalls the waveform stored in Wave1 to reference 1.

**:SAVE:IMAGe**



Description	Saves a screen image to the assigned file path with a specified filename.	
Syntax	:SAVE:IMAGe {<file path> ("Disk:/xxx.PNG", "USB:/xxx.BMP")}	
Related commands	:SAVE:IMAGe:FILEFormat :SAVE:IMAGe:INKSaver	
Parameter	xxx.PNG or xxx.BMP	File name (8 characters max)

Example :SAVE:IMAGe "Disk:/pic1.PNG"  
 Saves a screen image named pic1.png to the root directory (Disk:/) of the scope.  
 :SAVE:IMAGe "USB:/pic1.BMP"  
 Saves a screen image named pic1.bmp to the root directory of the external USB flash disk.



**:SAVE:IMAGe:FILEFormat**



Description	Sets the file format for image.	
Syntax	:SAVE:IMAGe:FILEFormat {PNG   BMP   ?}	
Related commands	:SAVE:IMAGe :SAVE:IMAGe:INKSaver	



Parameter	PNG	Sets the file format to PNG
	BMP	Sets the file format to BMP

Return parameter Returns the file format (PNG, BMP).

Example :SAVE:IMAGE:FILEFormat PNG  
Sets the image file format to PNG.

### :SAVe:IMAGe:INKSaver

Set →

→ Query

Description	Turns Ink Saver on or off.	
Syntax	:SAVe:IMAGe:INKSaver {OFF   ON  ?}	
Related commands	:SAVe:IMAGe :SAVe:IMAGe:FILEFormat	

Parameter	OFF	Turns Inksaver off.
	ON	Turns Inksaver on.

Return parameter Returns Ink Saver status (ON, OFF).

Example :SAVe:IMAGe:INKSaver ON  
Turns Ink Saver on.

### :SAVe:SETUp

Set →

Description	Saves the current setup to internal memory (Set1~Set20) or the designated file path.	
Syntax	:SAVe:SETUp {<file path> ("Disk:/xxx.SET", "USB:/xxx.SET)   S1~S20}	
Parameter	S1~S20	Saves the setup to Set1~Set20
	File path	Saves the setup to disk to the specified file path.

Example :SAVE:SETUp S1  
 Saves the current setup to Set1 in internal memory.  
 :SAVE:SETUp "Disk:/DS0001.SET"  
 Saves the current setup to DS0001.SET in the root directory of the internal memory.

**:SAVE:WAVEform**



Description	Saves a waveform to internal memory or to a designated file path.	
Related commands	:SAVE:WAVEform:FILEFormat	
Syntax	:SAVE:WAVEform {CH1~REF4, REF<X> }   {CH1~REF4, W1~W20}   {CH1~ALL, file path}	
Parameter	CH1~REF4	CH1~CH4, Math, REF1~4
	<X>	1,2,3,4 (REF1, REF2, REF3, REF4)
	W1~W20	Wave1~Wave20
	ALL	All the displayed waveforms on screen.
	File path	Saves the waveform(s) to disk or USB to the specified file path. (LSF or CSV, but note that detail CSV can't be recalled to the scope.)
Example 1	:SAVE:WAVEform CH1, REF2 Saves the channel1 waveform to REF2.	
Example 2	:SAVE:WAVEform:FILEFormat LSF :SAVE:WAVEform ALL, "Disk:/ALL001" Sets the file format to LSF. A folder named "ALL001" is created and saves all displayed waveforms to the "ALL001" directory in the LSF format.	

**Example 3**           :SAVE:WAVEform:FILEFormat FCSV  
                       :SAVE:WAVEform ALL, "Disk:/ALL002"  
 Sets the file format to FCSV (fast CSV format). It then saves the all channel's waveforms to the root directory (Disk:/) of the internal flash disk in the CSV format (with the filename ALL002.CSV).

**Example 4**           :SAVE:WAVEform:FILEFormat LSF  
                       :SAVE:WAVEform CH2, "Disk:/DS0003.LSF"  
 Save the channel 2's waveform to the root directory (Disk:/) of the internal flash disk in the LSF format with DS0003.LSF as the filename.

:SAVE:WAVEform:FILEFormat Set →  
→ Query

<b>Description</b>	Sets the waveform savefile format.	
<b>Syntax</b>	:SAVE:WAVEform:FILEFormat {LSF   DCSV   FCSV   ?}	
<b>Parameter</b>	LSF	Sets the file format to the GDS 1000B's internal file format, LSF. (xxx.LSF)
	DCSV	Sets the file format to detail CSV. (xxx.CSV)
	FCSV	Sets the file format to fast CSV. (xxx.CSV)
<b>Return parameter</b>	Returns the file format (LSF, DCSV, FCSV).	

**Example**           :SAVE:WAVEform:FILEFormat LSF  
 Sets the file format to LSF.

# Ethernet Commands

:ETHERnet:DHCP .....140

:ETHERnet:DHCP 
 →  
 →

Description	Sets or queries the DHCP settings.	
Note	The Ethernet commands are only applicable to GDS-1074B & GDS-1104B.	
Syntax	:ETHERnet:DHCP { OFF   ON   ? }	
Parameter	ON	Turns DHCP on.
	OFF	Turns DHCP off.
Example	:ETHERnet:DHCP ON Turns DHCP on.	

## Label Commands

:CHANnel<X>:LABel.....	141
:CHANnel<X>:LABel:DISPlay .....	142
:REF<X>:LABel .....	142
:REF<X>:LABel:DISPlay .....	143
:SET<X>:LABel .....	144

:CHANnel<X>:LABel 

Description	Sets or returns the file label for the selected channel.	
Syntax	:CHANnel<X>:LABel {<string>   ?}	
Related commands	:CHANnel<X>:LABel:DISPlay	
Parameter	<X>	Channel 1, 2, 3, 4
	<string>	The string must be no more than 8 characters and only contain alphanumeric characters in addition to period, dash and underscore characters. The string must be enclosed in double quotes, "string".
Return parameter	<string>	Returns the label for the selected channel. No return indicates that there has not been a file label assigned for the selected channel.
Example1	:CHANnel1:LABel "CH1_lab" Sets the channel 1 label as "CH1_lab".	
Example2	:CHANnel1:LABel? CH1_lab	

**:CHANnel<X>:LABel:DISPlay**

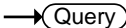
---

Description	Turns the label on/off for the selected channel or returns its status.	
Syntax	:CHANnel<X>:LABel:DISPlay { OFF   ON   ? }	
Related commands	:CHANnel<X>:LABel	
Parameter	<b>&lt;X&gt;</b>	Channel 1, 2, 3, 4
	OFF	Turns the file label off for the selected channel.
	ON	Turns the file label on for the selected channel.
Return parameter	Returns the status of the file label for the selected channel (ON, OFF).	

**Example**

```
:CHANnel1:LABel "CH1"
:CHANnel1:LABel:DISPlay ON
:CHANnel1:LABel:DISPlay?
ON
```

Sets the channel 1 label to "CH1" and then turns the label display on. The query return shows that the label is on.

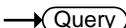
**:REF<X>:LABel**

---

Description	Sets or returns the file label for the selected reference waveform.	
Syntax	:REF<X>:LABel {<string>   ?}	
Related commands	:REF<X>:LABel:DISPlay	

Parameter	<X> <string>	REF 1, 2, 3, 4 The string must be no more than 8 characters and only contain alphanumeric characters in addition to period, dash and underscore characters. The string must be enclosed in double quotes, "string".
Return parameter	<string>	Returns the label for the selected reference waveform. No return indicates that there has not been a file label assigned for the selected reference waveform.
Example1	:REF1:LABel "REF1_lab"	Sets the REF1 label as "REF1_lab".
Example2	:REF1:LABel? REF1_lab	
	:REF<X>:LABel:DISPlay	
Description		Turns the label on/off for the selected reference waveform or returns its status.
Syntax		:REF<X>:LABel:DISPlay { OFF   ON   ? }
Related commands		:REF<X>:LABel
Parameter	<X> OFF ON	Reference waveform 1, 2, 3, 4 Turns the file label off for the selected reference waveform. Turns the file label on for the selected reference waveform.
Return parameter		Returns the status of the file label for the selected reference waveform (ON, OFF).

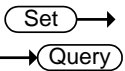
Example :REF1:LABel "REF1"  
 :REF1:LABel:DISPlay ON  
 :REF1:LABel:DISPlay?  
 ON

Sets the label for reference waveform 1 to "REF1" and then turns the label display on. The query return shows that the label is on.

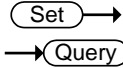

**:SET<X>:LABel**

Description Sets or returns the file label for the selected setup.

Syntax :SET<X>:LABel {<string> | ?}

Related commands :SET<X>:LABel:DISPlay

Parameter	<X>	Setup number 1 to 20
	<string>	The string must be no more than 8 characters and only contain alphanumeric characters in addition to period, dash and underscore characters. The string must be enclosed in double quotes, "string".
Return parameter	<string>	Returns the label for the selected setup. No return indicates that there has not been a file label assigned for the selected setup.

Example1 :SET1:LABel "SET1\_lab"  
 Sets the label for setup 1 as "SET1\_lab".

Example2 :SET1:LABel?  
 SET1\_lab



## DVM Commands

The DVM commands are only available when the optional DVM app is installed.

:DVM:STATE .....	145
:DVM:SOURce .....	145
:DVM:MODE.....	146
:DVM:VALue .....	146

:DVM:STATE 

Description	Sets or queries the DVM state to on or off.	
Note	This command is only applicable when the DVM app is installed. See the DVM app user manual for details.	
Syntax	:DVM:STATE {OFF   ON   ? }	
Related commands	:DVM:SOURce :DVM:MODE	
Parameter/ Return parameter	OFF	Turns the DVM off.
	ON	Turns the DVM on.
Example	:DVM:STATE ON Turns the DVM state on.	

:DVM:SOURce 

Description	Sets or queries the source of the DVM.	
Note	This command is only applicable when the DVM app is installed. See the DVM app user manual for details.	
Syntax	:DVM:SOURce {CH1 CH2 CH3 CH4 ?}	

Related commands	:DVM:STATE :DVM:MODE
Parameter/ Return parameter	CH1~CH4 Channel 1 to 4.
Example	:DVM:SOURce CH1 Sets the DVM source to channel 1.

:DVM:MODE 



Description	Sets or queries the DVM mode.
Note	This command is only applicable when the DVM app is installed. See the DVM app user manual for details.

Syntax :DVM:MODE {ACRMS|DC|DCRMS|DUTY|FREQUENCY|?}

Related commands	:DVM:SOURce :DVM:STATE
------------------	---------------------------

Parameter/ Return parameter	ACRMS Sets the mode to AC RMS
	DC Sets the mode to DC
	DCRMS Sets the mode to DC RMS
	DUTY Sets the mode to AC Duty
	FREQUENCY Sets the mode to AC frequency

Example	:DVM:MODE DUTY Sets the DVM mode to DUTY.
---------	--

:DVM:VALue 

Description	Returns the measurement value of the selected mode.
Note	This command is only applicable when the DVM app is installed. See the DVM app user manual for details.

---

Syntax	:DVM:VALue?
Related commands	:DVM:SOURce :DVM:STATE :DVD:MODE
Return parameter	Returns the measurement value as <NR3>.
Example	:DVM:VALue? >8.410E-04 Returns the measurement.

---

## Go\_NoGo Commands

The GoNoGo APP must first be launched (or use the command, “:GONogo:SCRipt”) before any of the Go\_NoGo or Template commands can be used.

:GONogo:CLear.....	148
:GONogo:EXECute .....	148
:GONogo:FUNCTion.....	149
:GONogo:NGCount .....	149
:GONogo:NGDefine.....	149
:GONogo:SOURce .....	150
:GONogo:VIOLation .....	150
:GONogo:SCRipt .....	150
:TEMPlate:MODE .....	151
:TEMPlate:MAXimum.....	151
:TEMPlate:MINimum.....	151
:TEMPlate:POSition:MAXimum.....	152
:TEMPlate:POSition:MINimum .....	152
:TEMPlate:SAVe:MAXimum .....	152
:TEMPlate:SAVe:MINimum .....	153
:TEMPlate:TOLerance.....	153
:TEMPlate:SAVe:AUTO .....	153

### :GONogo:CLear

Set →

Description Clears the Go/NoGo counter.

Syntax :GONogo:CLear

### :GONogo:EXECute

Set →  
→ Query

Description Enables or disables the Go/NoGo function or queries its state.

Syntax :GONogo:EXECute {OFF|ON|?}

Parameter/	OFF	Disabled
Return Parameter	ON	Enabled

Example :GONogo:EXECute OFF  
Turns Go/NoGo off.

**:GONogo:FUNcTion** (Set) →

Description Initializes the Go/NoGo APP. This must be run after the Go/NoGo APP has been started.

Syntax :GONogo:FUNcTion

**:GONogo:NGCount** → (Query)

Description Returns the Go/NoGo counter.

Syntax :GONogo:NGCount{?}

Return parameter Returns a string in the following format “number of violations,total tests”

Example :GONogo:NGCount?  
> 3,25  
Indicates that 3 violations occurred over 25 tests.

**:GONogo:NGDefine** (Set) →  
→ (Query)

Description Sets the Go/NoGo “When” conditions.

Syntax :GONogo:NGDefine {EXITs|ENTers}?}

Parameter/	EXITs	Sets the NoGo condition to when the input signal exceeds the limit boundary.
Return Parameter	ENTers	Sets the NoGo condition to when the input signal stays within the limit boundary.

Example :GONogo:NGDefine EXITs  
Sets the Go/NoGo condition to EXITs.

Set →  
 → Query

**:GONogo:SOURce**

---

Description	Sets the source for the Go/NoGo signal.	
Syntax	:GONogo:SOURce {CH1 CH2 CH3 CH4 ?}	
Parameter/ Return Parameter	CH1~CH4	
Example	:GONogo:SOURce CH1 Sets the source to CH1.	

Set →  
 → Query

**:GONogo:VIOLation**

---

Description	Sets or returns actions for the Go/NoGo violations.	
Syntax	:GONogo:VIOLation {STOP   CONTINUE   ?}	
Parameter/ Return Parameter	STOP	The waveform will be frozen.
	CONTINUE	Ignore the violation.
Example	:GONogo:VIOLation STOP Sets violation action to STOP.	

Set →

**:GONogo:SCRipt**

---

Description	Activates/Deactivates the Go/NoGo APP or queries its state.	
Syntax	:GONogo:SCRipt {OFF   ON   ?}	
Parameter/ Return Parameter	ON	Turns Go/NoGo APP on.
	OFF	Turns the Go/NoGo APP off.
Example	:GONogo:SCRipt? >ON The Go/NoGo script is on.	

 →  
 → 

**:TEMPlate:MODE**

**Description**      Sets or returns the Go/NoGo template mode.

**Syntax**            :TEMPlate:MODE {MAXimum|MINimum|AUTO|?}

<b>Parameter/ Return Parameter</b>	MAXimum	Maximum template
	MINimum	Minimum template
	AUTO	Auto template

**Example**            :TEMPlate:MODE AUTO  
 Sets the template mode to AUTO.

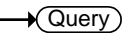
 →  
 → 

**:TEMPlate:MAXimum**

**Description**      Defines or queries which waveform memory (REF1 or W1~W20) is set to the maximum template.

**Syntax**            :TEMPlate:MAXimum {REF1|W1~W20|?}

<b>Parameter/ Return Parameter</b>	REF1	Reference one
	W1~W20	Waveform memory 1 to 20

**Example**            :TEMPlate:MAXimum REF1  
 Saves the maximum template to REF1.

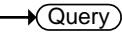
 →  
 → 

**:TEMPlate:MINimum**

**Description**      Defines or queries which waveform memory (REF2 or W1~W20) is set to the minimum template.

**Syntax**            :TEMPlate:MINimum {REF2|W1~W20|?}

<b>Parameter/ Return Parameter</b>	REF2	Reference two
	W1~W20	Waveform memory 1 to 20

**Example**            :TEMPlate:MINimum REF2  
 Saves the minimum template to REF2.

**:TEMPlate:POSition:MAXimum** 

Description	Sets or queries the position of the maximum template.	
Syntax	:TEMPlate:POSition:MAXimum {<NR2> ?}	
Parameter	<NR2>	Desired template position (-12.0 ~ +12.0 divisions)
Return parameter	Returns the position in the following format: “<NR2>Div”	
Example	:TEMPlate:POSition:MAXimum 3.00  Sets the maximum template position to 3.00 divisions.	

**:TEMPlate:POSition:MINimum** 

Description	Sets or queries the position of the minimum template.	
Syntax	:TEMPlate:POSition:MINimum {<NR2> ?}	
Parameter	<NR2>	Desired template position (-12.0 ~ +12.0 divisions)
Return parameter	Returns the position in the following format: “<NR2>Div”	
Example	:TEMPlate:POSition:MINimum 3.00  Sets the minimum template position to 3.00 divisions.	

**:TEMPlate:SAVe:MAXimum** 

Description	Saves the maximum template.	
Syntax	:TEMPlate:SAVe:MAXimum	



**:TEMPlate:SAVe:MINimum** (Set) →

Description      Saves the maximum template.

Syntax            :TEMPlate:SAVe:MINimum

(Set) →

**:TEMPlate:TOLerance**

→ (Query)

Description      Sets or queries the tolerance as a percentage.

Syntax            :TEMPlate:TOLerance {<NR2>|?}

Parameter/ Return Parameter	<NR2>	The auto tolerance range (0.4% ~ 40%)
--------------------------------	-------	---------------------------------------

Example            :TEMPlate:TOLerance 10  
Sets the tolerance to 10%.

**:TEMPlate:SAVe:AUTO** (Set) →

Description      Saves the AUTO template (maximum and minimum templates).

Syntax            :TEMPlate:SAVe:AUTO

## Data Logging Commands

The data logging commands are only applicable after the optional Data Log app has been installed.

:DATALOG:STATE .....	154
:DATALOG:SOURce .....	155
:DATALOG:SAVe .....	155
:DATALOG:INTerval.....	156
:DATALOG:DUration.....	157

:DATALOG:STATE 

  

Description	Sets or queries the state of the data logging app.	
Note	This command is only applicable when the Datalog app is installed. See the Datalog user manual for details.	
Syntax	:DATALOG:STATE {OFF ON ?}	
Related commands	:DATALOG:SOURce :DATALOG:SAVe :DATALOG:INTerval :DATALOG:DUration	
Parameter/ Return parameter	OFF	Turns the data logging off.
	ON	Turns the data logging on.
Example	:DATALOG:STATE ON Turns the data logging app on.	

		Set →
		→ Query
<b>:DATALOG:SOURce</b>		
Description	Sets or queries the data logging source channel.	
Note	This command is only applicable when the Datalog app is installed. See the Datalog user manual for details.	
Syntax	:DATALOG:SOURce {CH1~CH4 all ?}	
Related commands	:DATALOG:STATE :DATALOG:SAVE :DATALOG:INTERval :DATALOG:DURation	
Parameter/Return parameter	CH1 ~CH4 all	Channel 1, 2, 3 or 4 All displayed channels.
Example	:DATALOG:SOURce CH1 Sets the source to CH1.	

		Set →
		→ Query
<b>:DATALOG:SAVE</b>		
Description	Sets or queries the save format as image or waveform.	
Note	This command is only applicable when the Datalog app is installed. See the Datalog user manual for details.	
Syntax	:DATALOG:SAVE {IMAGe WAVEform ?}	
Related commands	:DATALOG:STATE :DATALOG:SOURce :DATALOG:INTERval :DATALOG:DURation	
Parameter/Return parameter	IMAGe WAVEform	Save as images. Save as waveforms.

Example :DATALOG:SAVe WAVEform  
 Sets the save format to waveform.

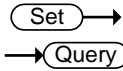

**:DATALOG:INTerval**

Description Sets or queries the recording interval time in seconds. The interval times that can be set are dependent on the settings of the DATALOG:SOURce and DATALOG:SAVe commands.

Note This command is only applicable when the Datalog app is installed. See the Datalog user manual for details.

Syntax :DATALOG:INTerval {<NR1>|?}

Related commands :DATALOG:STATE  
 :DATALOG:SOURce  
 :DATALOG:SAVe  
 :DATALOG:DURation

Parameter/Return parameter	<NR1>	Sets or returns the interval time in discrete seconds:  Interval time for DATALOG:SOURce = All or DATALOG:SAVe=IMAGE: 5, 10, 15, 20, 25, 30, 35, 60, 120  Interval time for DATALOG:SOURce = CH1~CH4: 2, 3, 4, 5, 10, 20, 30, 60, 120
----------------------------	-------	--

Example :DATALOG:INTerval 5  
 Sets the recording interval to 5 seconds.

Set →

→ Query

**:DATALOG:DURation**

Description	Sets or queries the recording duration time in minutes.	
Note	This command is only applicable when the Datalog app is installed. See the Datalog user manual for details.	
Syntax	:DATALOG:DURation {<NR1> ?}	
Related commands	:DATALOG:STATE :DATALOG:SOURce :DATALOG:SAVe :DATALOG:INTerval	
Parameter/Return parameter	<NR1>	Sets returns the duration time in discrete minutes: 5, 10, 15, 20, 25, 30, 60, 90, 120, 150, 180, 210, 240, 270, 300, 330, 360, 390, 420, 450, 480, 510, 540, 570, 600, 1200, 1800, 2400, 3000, 3600, 4200, 4800, 5400, 6000
Example	:DATALOG:DURation 10 Sets the recording duration to 10 minutes.	

## Remote Disk Commands

The remote disk commands are only available on 4 channel models.

:REMOTEDisk:IPADDRESS.....	158
:REMOTEDisk:PATHName.....	158
:REMOTEDisk:USERName.....	159
:REMOTEDisk:PASSWord.....	159
:REMOTEDisk:MOUNT.....	159
:REMOTEDisk:AUTOMount.....	160

(Set) →  
← (Query)

**:REMOTEDisk:IPADDRESS**

---



Description	Sets or returns the IP address of remote disk.
Note	This command is only available on 4 channel models.
Syntax	:REMOTEDisk:IPADDRESS {<string> ?}
Parameter/ Return parameter	<string> IP address enclosed in double quotes. Eg., 172.16.20.255
Example	:REMOTEDisk:IPADDRESS "172.16.20.255" Sets the remote disk IP address as 172.16.20.255.

(Set) →  
← (Query)



**:REMOTEDisk:PATHName**

---

Description	Sets or returns the file path of the remote disk.
Note	This command is only available on 4 channel models.
Syntax	:REMOTEDisk:PATHName {<string> ?}
Parameter/ Return parameter	<string> File path is enclosed in double quotes eg., "remote_disk"
Example	:REMOTEDisk:PATHName "remote_disk" Sets the file path to c:/remote_disk.

**:REMOTEDisk:USERName** 



Description	Sets or queries the account username for the remote disk.	
Note	This command is only available on 4 channel models.	
Syntax	:REMOTEDisk:USERName {<string>   ? }	
Parameter/Return parameter	<string>	User name enclosed in double quotes eg., "User_Name".
Example	:REMOTEDisk:USERName "User_Name" Sets the account name as User_Name.	

**:REMOTEDisk:PASSWord** 



Description	Sets or queries the account password for the remote disk.	
Note	This command is only available on 4 channel models.	
Syntax	:REMOTEDisk:PASSWord {<string>   ? }	
Parameter/Return parameter	<string>	Username password enclosed in double quotes eg., "Password".
Example	:REMOTEDisk:PASSWord "Password" Sets the account password as Password.	

**:REMOTEDisk:MOUNT** 



Description	Mounts/Unmounts the remote disk or queries its state.	
Note	This command is only available on 4 channel models.	
Syntax	:REMOTEDisk:MOUNT { OFF   ON   ? }	

Parameter/Return parameter	OFF	Unmount remote disk
	ON	Mount remote disk

---

Example :REMOTEDisk:IPADDRESS "172.16.5.154"  
:REMOTEDisk:PATHName "remote\_disk"  
:REMOTEDisk:USERName "guest"  
:REMOTEDisk:PASSWord "password"  
:REMOTEDisk:MOUNT ON  
Sets the remote disk parameters and mounts the remote disk.

Set →  
→ Query

---

:REMOTEDisk:AUTOMount

Description	Turns automount on/off or queries its state. The remote disk must be configured beforehand.	
Note	This command is only available on 4 channel models.	
Syntax	:REMOTEDisk:AUTOMount { OFF   ON   ? }	
Parameter/Return parameter	OFF	Don't mount the remote disk at start up.
	ON	Automatically mount the remote disk on start up.

---

Example :REMOTEDisk:AUTOMount ON  
Turns the automount function on.



## USB Delay Command

:USBDelay					
Description	Sets or returns the USB delay function for the PC connection which Windows 10 installed				
Syntax	:USBDelay {OFF ON} :USBDelay?				
Parameter/ Return parameter	<table border="0" style="width: 100%;"> <tr> <td style="background-color: #e0e0e0; padding: 2px;">&lt;ON&gt;</td> <td style="padding: 2px;">Turns on the USB delay function</td> </tr> <tr> <td style="background-color: #e0e0e0; padding: 2px;">&lt;OFF&gt;</td> <td style="padding: 2px;">Turns off the USB delay function</td> </tr> </table>	<ON>	Turns on the USB delay function	<OFF>	Turns off the USB delay function
<ON>	Turns on the USB delay function				
<OFF>	Turns off the USB delay function				
Example	:USBDelay ON  Turns on the USB delay function when the scope connected with window 10 installed PC.				
Example	:REMOTEDisk:AUTOMount ON  Turns the automount function on.				

# APPENDIX

## Error messages

Description	The following error messages may be returned from the :SYSTem:ERRor? query. For details see page 134.																									
List of error messages	<table border="1"> <thead> <tr> <th data-bbox="333 598 722 630">Error number, "Error Description"</th> </tr> </thead> <tbody> <tr><td data-bbox="333 635 504 667">+0, "No error."</td></tr> <tr><td data-bbox="333 671 604 703">-100, "Command error"</td></tr> <tr><td data-bbox="333 708 610 740">-101, "Invalid character"</td></tr> <tr><td data-bbox="333 745 560 777">-102, "Syntax error"</td></tr> <tr><td data-bbox="333 782 616 813">-103, "Invalid separator"</td></tr> <tr><td data-bbox="333 818 593 850">-104, "Data type error"</td></tr> <tr><td data-bbox="333 855 610 887">-105, "GET not allowed"</td></tr> <tr><td data-bbox="333 892 677 924">-108, "Parameter not allowed"</td></tr> <tr><td data-bbox="333 928 632 960">-109, "Missing parameter"</td></tr> <tr><td data-bbox="333 965 688 997">-110, "Command header error"</td></tr> <tr><td data-bbox="333 1002 683 1034">-111, "Header separator error"</td></tr> <tr><td data-bbox="333 1038 750 1070">-112, "Program mnemonic too long"</td></tr> <tr><td data-bbox="333 1075 627 1107">-113, "Undefined header"</td></tr> <tr><td data-bbox="333 1112 722 1144">-114, "Header suffix out of range"</td></tr> <tr><td data-bbox="333 1149 823 1181">-115, "Unexpected number of parameters"</td></tr> <tr><td data-bbox="333 1185 644 1217">-120, "Numeric data error"</td></tr> <tr><td data-bbox="333 1222 744 1254">-121, "Invalid character in number"</td></tr> <tr><td data-bbox="333 1259 638 1291">-123, "Exponent too large"</td></tr> <tr><td data-bbox="333 1295 604 1327">-124, "Too many digits"</td></tr> <tr><td data-bbox="333 1332 722 1364">-128, "Numeric data not allowed"</td></tr> <tr><td data-bbox="333 1369 548 1401">-130, "Suffix error"</td></tr> <tr><td data-bbox="333 1406 571 1437">-131, "Invalid suffix"</td></tr> <tr><td data-bbox="333 1442 588 1474">-134, "Suffix too long"</td></tr> <tr><td data-bbox="333 1479 627 1511">-138, "Suffix not allowed"</td></tr> </tbody> </table>	Error number, "Error Description"	+0, "No error."	-100, "Command error"	-101, "Invalid character"	-102, "Syntax error"	-103, "Invalid separator"	-104, "Data type error"	-105, "GET not allowed"	-108, "Parameter not allowed"	-109, "Missing parameter"	-110, "Command header error"	-111, "Header separator error"	-112, "Program mnemonic too long"	-113, "Undefined header"	-114, "Header suffix out of range"	-115, "Unexpected number of parameters"	-120, "Numeric data error"	-121, "Invalid character in number"	-123, "Exponent too large"	-124, "Too many digits"	-128, "Numeric data not allowed"	-130, "Suffix error"	-131, "Invalid suffix"	-134, "Suffix too long"	-138, "Suffix not allowed"
Error number, "Error Description"																										
+0, "No error."																										
-100, "Command error"																										
-101, "Invalid character"																										
-102, "Syntax error"																										
-103, "Invalid separator"																										
-104, "Data type error"																										
-105, "GET not allowed"																										
-108, "Parameter not allowed"																										
-109, "Missing parameter"																										
-110, "Command header error"																										
-111, "Header separator error"																										
-112, "Program mnemonic too long"																										
-113, "Undefined header"																										
-114, "Header suffix out of range"																										
-115, "Unexpected number of parameters"																										
-120, "Numeric data error"																										
-121, "Invalid character in number"																										
-123, "Exponent too large"																										
-124, "Too many digits"																										
-128, "Numeric data not allowed"																										
-130, "Suffix error"																										
-131, "Invalid suffix"																										
-134, "Suffix too long"																										
-138, "Suffix not allowed"																										

- 140, "Character data error"
- 141, "Invalid character data"
- 144, "Character data too long"
- 148, "Character data not allowed"
- 150, "String data error"
- 151, "Invalid string data"
- 158, "String data not allowed"
- 160, "Block data error"
- 161, "Invalid block data"
- 168, "Block data not allowed"
- 170, "Expression error"
- 171, "Invalid expression"
- 178, "Expression data not allowed"
- 180, "Macro error"
- 181, "Invalid outside macro definition"
- 183, "Invalid inside macro definition"
- 184, "Macro parameter error"
  
- 200, "Execution error"
- 201, "Invalid while in local"
- 202, "Settings lost due to rtl"
- 203, "Command protected"
- 210, "Trigger error"
- 211, "Trigger ignored"
- 212, "Arm ignored"
- 213, "Init ignored"
- 214, "Trigger deadlock"
- 215, "Arm deadlock"
- 220, "Parameter error"
- 221, "Settings conflict"
- 222, "Data out of range"
- 223, "Too much data"
- 224, "Illegal parameter value"
- 225, "Out of memory"
- 226, "Lists not same length"
- 230, "Data corrupt or stale"
- 231, "Data questionable"
- 232, "Invalid format"
- 233, "Invalid version"
- 240, "Hardware error"

- 241, "Hardware missing"
- 250, "Mass storage error"
- 251, "Missing mass storage"
- 252, "Missing media"
- 253, "Corrupt media"
- 254, "Media full"
- 255, "Directory full"
- 256, "File name not found"
- 257, "File name error"
- 258, "Media protected"
- 260, "Expression error"
- 261, "Math error in expression"
- 270, "Macro error"
- 271, "Macro syntax error"
- 272, "Macro execution error"
- 273, "Illegal macro label"
- 274, "Macro parameter error"
- 275, "Macro definition too long"
- 276, "Macro recursion error"
- 277, "Macro redefinition not allowed"
- 278, "Macro header not found"
- 280, "Program error"
- 281, "Cannot create program"
- 282, "Illegal program name"
- 283, "Illegal variable name"
- 284, "Program currently running"
- 285, "Program syntax error"
- 286, "Program runtime error"
- 290, "Memory use error"
- 291, "Out of memory"
- 292, "Referenced name does not exist"
- 293, "Referenced name already exists"
- 294, "Incompatible type"
  
- 300, "Device-specific error"
- 310, "System error"
- 311, "Memory error"
- 312, "PUD memory lost"
- 313, "Calibration memory lost"
- 314, "Save/recall memory lost"

- 315, "Configuration memory lost"
- 320, "Storage fault"
- 321, "Out of memory"
- 330, "Self-test failed"
- 340, "Calibration failed"
- 350, "Queue overflow"
- 360, "Communication error"
- 361, "Parity error in program message"
- 362, "Framing error in program message"
- 363, "Input buffer overrun"
- 365, "Time out error"
  
- 400, "Query error"
- 410, "Query INTERRUPTED"
- 420, "Query UNTERMINATED"
- 430, "Query DEADLOCKED"
- 440, "Query UNTERMINATED after indefinite response"

# INDEX

ACQuire	
AVERage .....	35
HEADer .....	41
MEMory .....	36
MODe .....	36
RECOrdlength .....	40
STATe .....	38, 39, 40
AUTORSET	
MODe .....	42
AUTOSet .....	42
CHANnel	
BWLimit .....	43
COUPling .....	44
DESKew .....	44
DISPlay .....	44
EXPand .....	45
IMPedance .....	45, 55
INVert .....	46
LABel .....	141
DISPlay .....	142
POSiTion .....	46
PROBe	
TYPE .....	47
PROBe	
RATio .....	47
SCALe .....	47
CLS .....	31
CURSor	
DDT .....	61
H1Position .....	61
H2Position .....	62
HDELta .....	62
HUNI .....	59
HUSE .....	60
MODe .....	58
SOURce .....	59
V1Position .....	62, 63
VDELta .....	63
VUNI .....	60
VUSE .....	61
XY	
POLar	
RADIUS	
DELta .....	65
POSiTion .....	65
THETA	
DELta .....	66
POSiTion .....	66
PRODuct	
DELta .....	67
POSiTion .....	66
RATio	
DELta .....	67
RATio	
POSiTion .....	67
RECTangular	
X	
DELta .....	64
POSiTion .....	63
Y	
DELta .....	65
POSiTion .....	64
DATALOG	
DURation .....	157
INTERval .....	156
SAVE .....	155, 159, 160
SOURce .....	155, 159
STATE .....	154, 158
DISPlay	
GRATICule .....	71
INTensity	
GRATICule .....	69, 70
WAVEform .....	69
OUTPut .....	72
PERSistence .....	71
WAVEform .....	72
DVM	
MODe .....	146

SOURce.....145  
 STATE.....145  
 Error list ..... 162  
 Ethernet  
     interface .....8  
 ETHERnet  
     DHCP.....140  
 FORCe ..... 113  
 GONogo  
     CLEar .....148  
     EXECute.....148  
     FUNcTion .....149  
     NGCount ..... 149, 161  
     NGDefine.....149  
     SCRipt.....150  
     SOURce.....150  
     VIOlAtion.....150  
 HARDcopy  
     ASSIGN.....75  
     MODE.....73  
     PRINTINKSaver .....74  
     SAVEFORMat .....74  
     SAVEINKSaver.....74  
     START.....73  
 HEADER ..... 41  
 IDN? ..... 29  
 Interface ..... 5  
 LRN?..... 29  
 MATH  
     ADVanced  
         OPERator ..... 54  
         POSition .....56  
         SCALE.....56  
     DISP.....49  
     DUAL  
         OPERator .....50  
         POSition .....51  
         SCALE.....51  
         SOURce .....50  
     FFT  
         HORizontal  
             SCALE.....54  
         MAG .....52  
         POSition .....53, 54

SCALE..... 53  
 SOURce..... 52  
 WINDow ..... 52  
 TYPE.....50

**MEASure**

AMPliTude ..... 88  
 AREa..... 94  
 CARea ..... 94  
 CMean..... 89  
 FALL..... 80  
 FFFDelay ..... 97  
 FFRDelay..... 96  
 FOVShoot..... 80  
 FPReshoot ..... 81  
 FREQuency ..... 81  
 FRFDelay..... 95  
 FRRDelay ..... 95  
 GATing.....77  
 HIGH..... 90  
 LFFDelay..... 99  
 LFRDelay ..... 98  
 LOW ..... 90  
 LRFDelay ..... 98  
 LRRDelay ..... 97  
 MAX ..... 91  
 MEAN ..... 88  
 METHod ..... 78, 79  
 MIN ..... 91  
 NEDGE..... 87  
 NPULSE ..... 86  
 NWIDth..... 82  
 PDUTy..... 82  
 PEDGE..... 87  
 PERiod..... 83  
 PHAse..... 100  
 PK2PK ..... 92  
 PPULSE ..... 86  
 PWIDth..... 83  
 RISE..... 84  
 RMS ..... 92, 93  
 ROVShoot ..... 84  
 RPReshoot..... 85  
 SOURce ..... 77

**MEASurement**

MEAS  
     MAXimum ..... 104  
     MEAN..... 105  
     MINImum..... 105  
     SOURCE ..... 101

STATE .....	102	LOCK .....	134
STDdev .....	106	TEMPlate	
TYPe .....	102	MAXimum.....	151
VALue .....	103	MINimum.....	151
STATIstics .....	108	MODE.....	151
MODE.....	107	POSition	
WEIghting.....	107	MAXimum .....	152
RCL.....	31	MINimum .....	152
RECALL		SAVe	
SETUp.....	135	AUTo .....	153
WAVEform .....	135	MAXimum .....	152
REF		MINimum .....	153
DISPlay .....	109	TOLerance .....	153
LABel .....	142	TIMEbase	
DISPlay .....	143	EXPand.....	114
OFFSet .....	110	MODE.....	115
SCALe.....	111	POSition .....	114
TIMEbase		SCALe .....	114
POSition .....	109	WINDow	
SCALe.....	110	POSition.....	115
Remote control		SCALe .....	116
interface configuration .....	5	TRIGger	
RST .....	31	ALTErnate.....	131
RUN .....	112	COUPLe .....	119
SAV .....	30	DELay	
SAVe		EVENT.....	123
IMAGe.....	136	LEVel .....	124
FILEFormat.....	136	SLOP .....	122
INKSaver.....	137	TIME .....	123
SETUp.....	137	TYPe .....	123
WAVEform .....	138	EDGE	
FILEFormat.....	139	SLOP .....	122
SET		EXTErNal	
LABel .....	144	PRObe	
SINGle.....	112	RATio .....	133
Socket server		TYPe .....	132
function check.....	11	FREQUency.....	118
Socket server		HLEVel.....	120, 121
interface.....	10	HOLDoff.....	120
STOP .....	112	LLEVel .....	121
SYSTEM		MODE.....	120
ERRor.....	134	NREJ .....	119
		PULSe	
		TIME .....	130
		WHEn .....	129
		PULSEWidth	
		POLarity .....	124
		RISEFall	
		SLOP .....	126
		Time.....	127



WHEn.....	126	TYPE.....	118
RUNT		VIDeo	
POLarity.....	125	FIEld.....	128
TIMe.....	126	LINE.....	129
WHEn.....	125	POLarity.....	129
SOURce.....	119	TYPe.....	127
STATe.....	131	USB	
TIMEOut		function check.....	7
TIMER.....	131	remote control interface.....	5
WHEn.....	130		