

Multi-Range DC Power Supply

PSW Series

PROGRAMMING MANUAL



ISO-9001 CERTIFIED MANUFACTURER

GW INSTEK

This manual contains proprietary information, which is protected by copyright. All rights are reserved. No part of this manual may be photocopied, reproduced or translated to another language without prior written consent of Good Will company.

The information in this manual was correct at the time of printing. However, Good Will continues to improve products and reserves the rights to change specification, equipment, and maintenance procedures at any time without notice.

Good Will Instrument Co., Ltd.
No. 7-1, Jhongsing Rd., Tucheng Dist., New Taipei City 236, Taiwan.

Table of Contents

S	SAFETY INSTRUCTIONS	4
G	GETTING STARTED.....	7
	PSW Series Overview	8
	Appearance	14
	Configuration Settings	21
R	REMOTE CONTROL.....	29
	Interface Configuration	30
	Socket Server Examples	44
	Command Syntax	48
	Command List	52
	Status Register Overview	101
	Error List	111
A	APPENDIX.....	120
	PSW Default Settings	120
	Error Messages & Messages	123
	LED Display Format	123
I	INDEX.....	124

S SAFETY INSTRUCTIONS

This chapter contains important safety instructions that you must follow during operation and storage. Read the following before any operation to insure your safety and to keep the instrument in the best possible condition.

Safety Symbols

These safety symbols may appear in this manual or on the instrument.



WARNING

Warning: Identifies conditions or practices that could result in injury or loss of life.



CAUTION

Caution: Identifies conditions or practices that could result in damage to the PSW or to other properties.



DANGER High Voltage



Attention Refer to the Manual



Protective Conductor Terminal



Earth (ground) Terminal



Do not dispose electronic equipment as unsorted municipal waste. Please use a separate collection facility or contact the supplier from which this instrument was purchased.

Safety Guidelines

General Guideline



CAUTION

- Do not place any heavy object on the PSW.
- Avoid severe impact or rough handling that leads to damaging the PSW.
- Do not discharge static electricity to the PSW.
- Use only mating connectors, not bare wires, for the terminals.
- Do not block the cooling fan opening.
- Do not disassemble the PSW unless you are qualified.

Power Supply



WARNING

- AC Input voltage rating: 100Vac-240Vac +/-10%
- Frequency: 47Hz~63Hz
- To avoid electrical shock connect the protective grounding conductor of the AC power cord to an earth ground.

Cleaning the PSW

- Disconnect the power cord before cleaning.
- Use a soft cloth dampened in a solution of mild detergent and water. Do not spray any liquid.
- Do not use chemicals containing harsh material such as benzene, toluene, xylene, and acetone.

Operation Environment

- Location: Indoor, no direct sunlight, dust free, almost non-conductive pollution (Note below)
- Relative Humidity: 20%~ 85%
- Altitude: < 2000m
- Temperature: 0°C to 50°C

- Mains supply voltage fluctuations: +/-10 %
- Overvoltage category: OVC II
- If the equipment is used in a manner not specified by the manufacturer, the protection provided by the equipment may be impaired.
- LAN, RS232/RS485, USB, and GPIB ports are only to be connected to the circuits which are separated from mains supply by double / reinforce insulation.

(Pollution Degree) EN61010-1 and EN61010-2-030 specify the pollution degrees and their requirements as follows. The PSW falls under degree 2.

Pollution refers to “addition of foreign matter, solid, liquid, or gaseous (ionized gases), that may produce a reduction of dielectric strength or surface resistivity”.

- Pollution degree 1: No pollution or only dry, non-conductive pollution occurs. The pollution has no influence.
- Pollution degree 2: Normally only non-conductive pollution occurs. Occasionally, however, a temporary conductivity caused by condensation must be expected.
- Pollution degree 3: Conductive pollution occurs, or dry, non-conductive pollution occurs which becomes conductive due to condensation which is expected. In such conditions, equipment is normally protected against exposure to direct sunlight, precipitation, and full wind pressure, but neither temperature nor humidity is controlled.

Storage environment

- Location: Indoor
- Temperature: -25°C to 70°C
- Relative Humidity: <90%

Disposal



Do not dispose this instrument as unsorted municipal waste. Please use a separate collection facility or contact the supplier from which this instrument was purchased. Please make sure discarded electrical waste is properly recycled to reduce environmental impact.

G E T T I N G S T A R T E D

This chapter describes the power supply in a nutshell, including its main features and front / rear panel introduction, as well as an overview of the configuration settings.



PSW Series Overview	8
Series lineup.....	8
Main Features.....	9
Accessories	10
PSW 30/40/80/160 Accessories.....	10
PSW 250/800 Accessories	12
Appearance	14
PSW Front Panel.....	14
Rear Panel	17
Configuration Settings	21
Setting Normal Function Settings	21
Setting Power On Configuration Settings.....	22
Configuration Table.....	24

PSW Series Overview

Series lineup

The PSW series consists of 18 models, divided into 3 different model types covering 3 power capacities: Type I (360 Watt), Type II (720 Watt) and Type III (1080 Watt).



Note

Throughout the user manual, PSW 30, PSW 40, PSW 80, PSW 160, PSW 250 or PSW 800 will refer to any of the PSW models with a maximum voltage rating of 30V, 40V, 80V, 160V, 250V or 800V, respectively.

Model name	Type	Voltage Rating	Current Rating	Power
PSW 30-36	Type I	0~30V	0~36A	360W
PSW 40-27	Type I	0~40V	0~27A	360W
PSW 80-13.5	Type I	0~80V	0~13.5A	360W
PSW 160-7.2	Type I	0~160V	0~7.2A	360W
PSW 250-4.5	Type I	0~250V	0~4.5A	360W
PSW 800-1.44	Type I	0~800V	0~1.44A	360W
PSW 30-72	Type II	0~30V	0~72A	720W
PSW 40-54	Type II	0~40V	0~54A	720W
PSW 80-27	Type II	0~80V	0~27A	720W
PSW 160-14.4	Type II	0~160V	0~14.4A	720W
PSW 250-9	Type II	0~250V	0~9A	720W
PSW 800-2.88	Type II	0~800V	0~2.88A	720W
PSW 30-108	Type III	0~30V	0~108A	1080W
PSW 40-81	Type III	0~40V	0~81A	1080W
PSW 80-40.5	Type III	0~80V	0~40.5A	1080W
PSW 160-21.6	Type III	0~160V	0~21.6A	1080W

PSW 250-13.5	Type III 0~250V	0~13.5A	1080W
PSW 800-4.32	Type III 0~800V	0~4.32A	1080W

Apart from the differences in output, each unit differs in size. The 720 and 1080 watt models are larger than the 360 watt models to accommodate the increase in power.

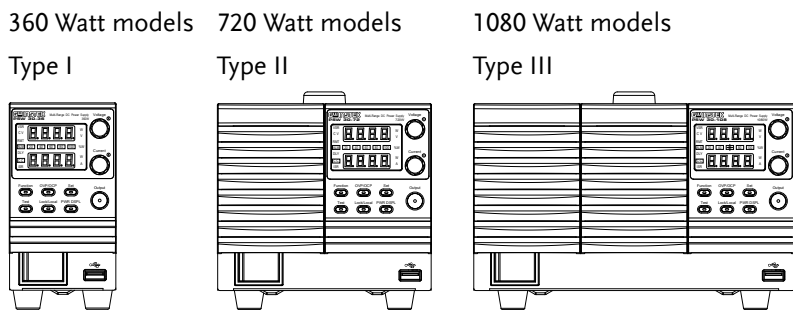

Main Features

- | | |
|-------------|---|
| Performance | <ul style="list-style-type: none"> • High performance/power • Power efficient switching type power supply • Low impact on load devices • Fast transient recovery time of 1ms • Fast output response time |
|-------------|---|

- | | |
|----------|---|
| Features | <ul style="list-style-type: none"> • OVP, OCP and OHP (OTP) protection • Adjustable voltage and current slew rates • User adjustable bleeder control to quickly dissipate the power after shutdown to safe levels. • Extensive remote monitoring and control options • Support for serial* and parallel connections.
*(30, 40, 80, 160 volt models only) |
|----------|---|

- Power on configuration settings.
- Supports test scripts
- Web server monitoring and control

- Interface
- Ethernet port
 - Analog connector for analog voltage and current monitoring
 - USB host and device port

Accessories

Please check the contents before using the PSW.

PSW 30/40/80/160 Accessories

Standard Accessories	Part number	Description
	CD-ROM	User manual, programming manual
		Power cord (Type I/II)
		Power cord (Type III)
		Output terminal cover
	GTL-123	Test leads: 1x red, 1x black
	GTL-240	USB Cable
	PSW-004	Basic Accessory Kit: M4 terminal screws and washers x2, M8 terminal bolts, nuts and washers x2, Air filter x1, Analog control protection dummy x1, Analog control lock level x1

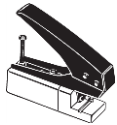
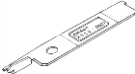
Optional Accessories	Part number	Description
	GET-001	Extended terminal with max. 30A
	GET-005	Extended European terminal with max. 20A
	PSW-001	Accessory Kit: Pin contact x10, Socket x1, Protection cover x1
	PSW-002	Simple IDC Tool 
	PSW-003	Contact Removal Tool 
	PSW-005	Series operation cable for 2 units.
	PSW-006	Parallel operation cable for 2 units.
	PSW-007	Parallel operation cable for 3 units.
	GRA-410-J	Rack mount adapter (JIS)
	GRA-410-E	Rack mount adapter (EIA)
	GUG-001	GPIB to USB adapter
	GTL-240	USB Cable
	PSW-010	Large filter (Type II/III)
	GUR-001A	RS-232 to USB adapter with M3 rivet nut (Support only when firmware version is 2.25 or above)
	GUR-001B	RS-232 to USB adapter with #4-40 UNC rivet nut (Support only when firmware version is 2.25 or above)

Download	Name	Description
	psw_cdc.inf	USB driver

PSW 250/800 Accessories

Standard Accessories	Part number	Description
	CD-ROM	User manual, programming manual Power cord (Type I/II) Power cord (Type III) High voltage output terminal cover
	GTL-240	USB Cable High voltage output terminal
	PSW-008	Basic Accessory Kit: (Air filter x1, Analog control protection dummy x1, Analog control lock level x1)
Optional Accessories	Part number	Description
	GET-002	Extended terminal with max. 10A
	PSW-001	Accessory Kit: Pin contact x10, Socket x1, Protection cover x1
	PSW-002	Simple IDC Tool
	PSW-003	Contact Removal Tool
	PSW-006	Parallel operation cable for 2 units.
	PSW-007	Parallel operation cable for 3 units.
	GRA-410-J	Rack mount adapter (JIS)
	GRA-410-E	Rack mount adapter (EIA)
	GTL-130	Test leads: 2x red, 2x black

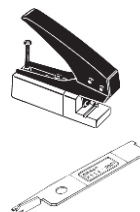

	GUG-001	GPIB to USB adapter
	GTL-240	USB Cable
	PSW-010	Large filter (Type II/III)
	GUR-001A	RS-232 to USB adapter with M3 rivet nut (Support only when firmware version is 2.25 or above)
	GUR-001B	RS-232 to USB adapter with #4-40 UNC rivet nut (Support only when firmware version is 2.25 or above)
Download	Name	Description
	psw_cdc.inf	USB driver

Appearance

PSW Front Panel

720W: PSW 30-72, 40-54, 80-27, 160-14.4, 250-9, 800-2.88

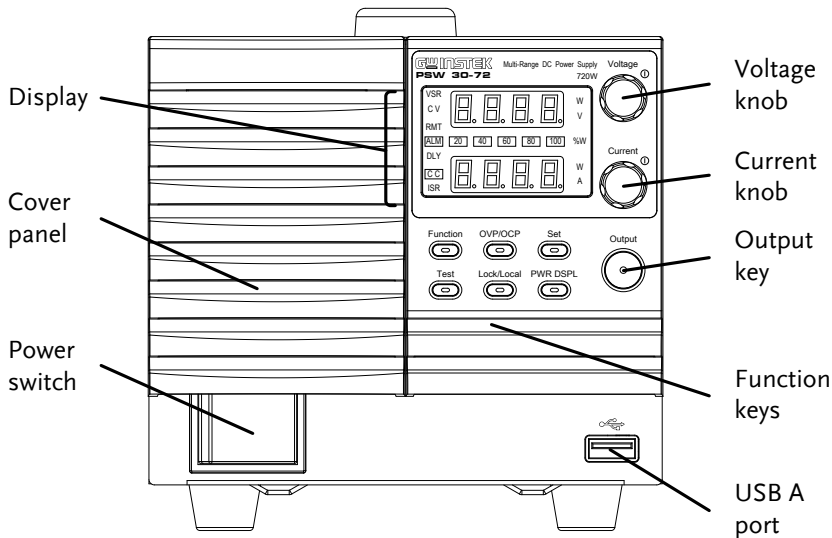

1080W: PSW 30-108, 40-81, 80-40.5, 160-21.6, 250-13.5, 800-4.32

360W: PSW 30-36, 40-27, 80-13.5, 160-7.2, 250-4.5, 800-1.44

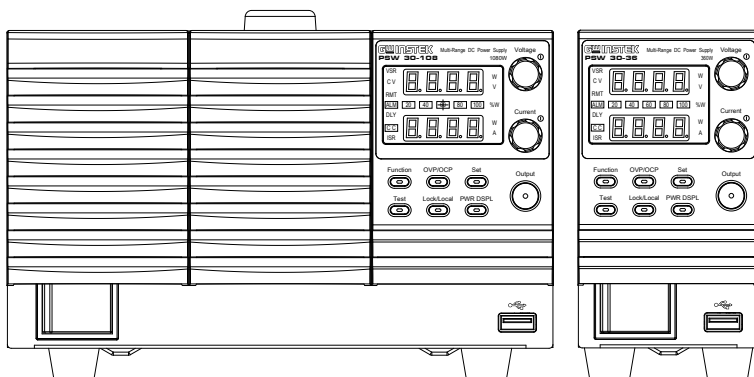

Function Keys The Function keys along with the Output key will light up when a key is active.

Function



The Function key is used to configure the power supply.

OVP/OCV



Set the over current or over voltage protection levels.

Set



Sets the current and voltage limits.

Test



Used to run customized scripts for testing.

Lock/Local



Locks or unlocks the panel keys to prevent accidentally changing panel settings.

PWR DSPL



Toggles the display from viewing V/A → V/W or A/W*.
*Press the Voltage knob for V/W, press the Current knob for A/W.

Display Indicators

VSR

Voltage Slew Rate

C V

Constant Voltage Mode

RMT

Remote Control Mode

ALM

Alarm on

DLY

Delay Output

C C

Constant Current Mode

ISR

Current Slew Rate

20 **40** **60**

Power bar

80 **100** % W

Indicates the current power output as a percentage.

Voltage Knob

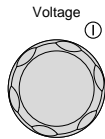

Sets the voltage.

Current Knob

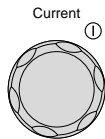

Sets the current.

Output

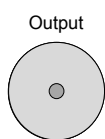

Press to turn on the output. The Output key will light up when the output is active.

USB

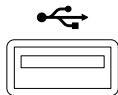

USB A port for data transfer, loading test scripts etc.

Power Switch

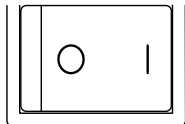

Used to turn the power on/off.

Rear Panel

720W: PSW 30-72, 40-54, 80-27, 160-14.4

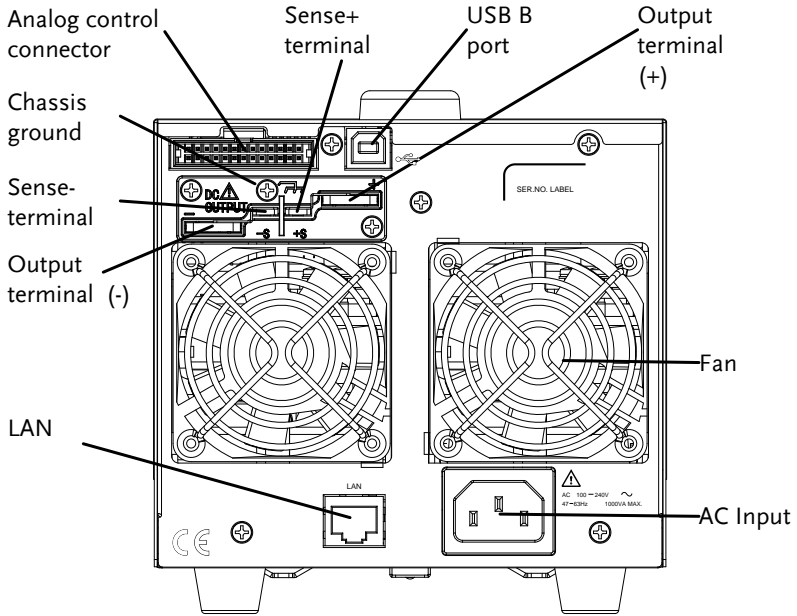

1080W: PSW 30-108, 40-81, 80-40.5, 160-21.6

360W: PSW 30-36,
40-27, 80-13.5,
160-7.2

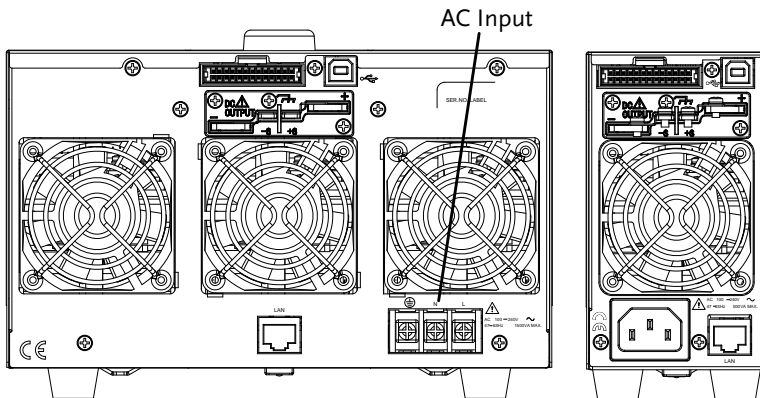

720W: PSW 250-9, 800-2.88

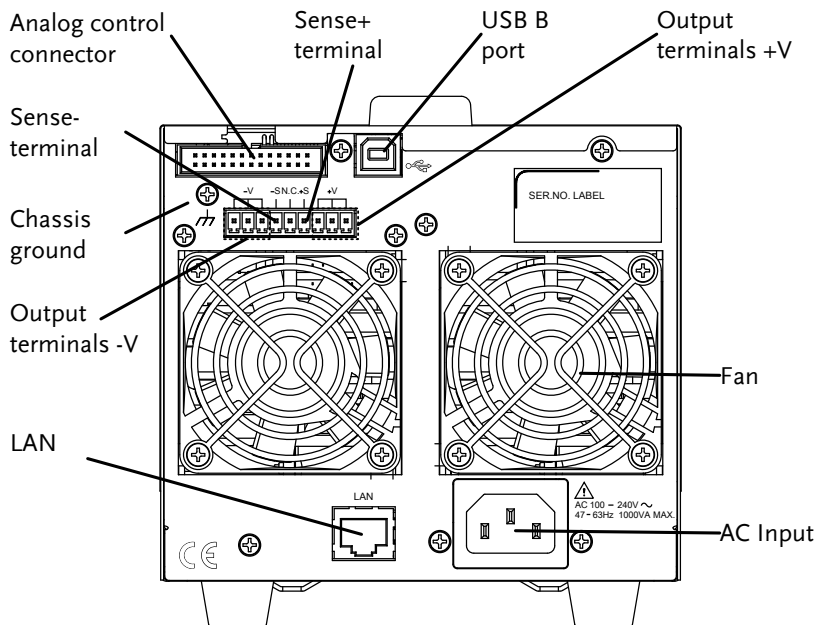

1080W: PSW 250-13.5, 800-4.32

360W: PSW 250-4.5, 800-1.44

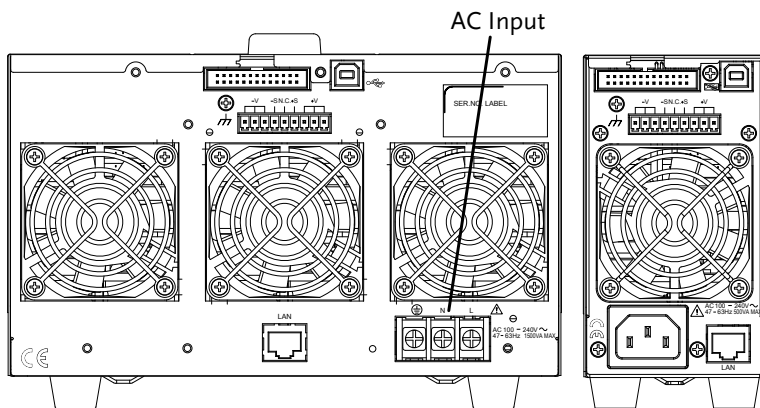

Analog Control Connector



Standard 26 pin MIL connector (OMRON XG4 IDC plug).

The analog control connector is used to monitor current and voltage output, machine status (OVP, OCP, OHP (OTP) etc.), and for analog control of the current and voltage output.

Use an OMRON XG5 IDC socket as the mating socket.

Output Terminals (30, 40, 80, 160 volt models)



Positive (+) and negative (-) output terminals.



Chassis ground

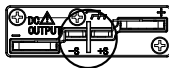

Sense (-S) and Sense (+S) terminals.

Output Terminals (250, 800 volt models)

The 250 and 800 volt models use a 9 pin connector and a plug for the output and sense terminal connections. The plug is a MC420-38109Z plug by DECA SwitchLab Inc. This plug is also available separately (GW part number PSW-012).

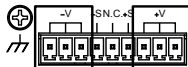

Positive (V+) and negative (V-) output terminals (3 of each).

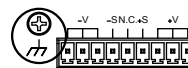

Chassis ground

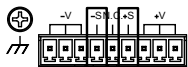

Sense (-S) and Sense (+S) terminals.

USB B port

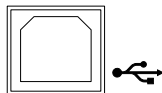

The USB B port is used for remote control.

Fans

Temperature controlled fans

Ethernet Port

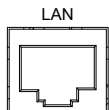

The ethernet port is used for remote control and digital monitoring from a PC.

Line Voltage Input

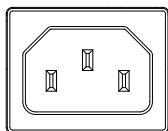

Type I: PSW 30-36/40-27/80-13.5/
160-7.2/250-4.5, 800-1.44

(Type I/TypeII)

Type II: PSW 30-72/40-54/80-27/
160-14.4/250-9, 800-2.88

- Voltage Input: 100~240 VAC
- Line frequency: 50Hz/60 Hz (Automatically switchable)

Line Voltage Input

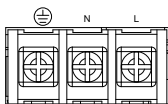

Type III:
PSW 30-108/40-81/80-40.5/
160-21.6/250-13.5/800-4.32

(Type III)

- Voltage Input: 100~240 VAC
- Line frequency: 50Hz/60 Hz (Automatically switchable)

Configuration Settings

Configuration of the PSW power supplies is divided into five different configuration settings: Normal Function, USB/GPIB, LAN, Power ON Configuration, Calibration Settings and System Settings. Power ON Configuration differs from the other settings in that the settings used with Power ON Configuration settings can only be set during power up. The other configuration settings can be changed when the unit is already on. This prevents some important configuration parameters from being changed inadvertently. Power On Configuration settings are numbered F-90 to F-95 and the other configuration settings are numbered F-00 to F-61 and F-88 to F-89.

Setting Normal Function Settings

The normal function settings (F-01~F-61, F-88~F-89) can be easily configured with the Function key.

- Ensure the load is not connected.
- Ensure the output is off.



Note

Function setting F-89 (Show Version) can only be viewed, not edited.

Configuration settings F-90~F-95 cannot be edited in the Normal Function Settings. Use the Power On Configuration Settings. See page 22 for details.

Steps

1. Press the Function key. The function key will light up.

Function



2. The display will show F-01 on the top and the configuration setting for F-01 on the bottom.

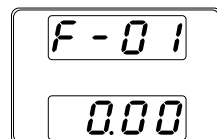

3. Rotate the voltage knob to change the F setting.

Range F-00~ F-61, F-88~F-89



4. Use the current knob to set the parameter for the chosen F setting.



5. Press the Voltage knob to save the configuration setting. Conf will be displayed when successful.

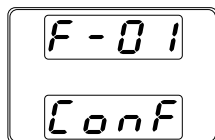

Exit

Press the Function key again to exit the configuration settings. The function key light will turn off.

Function



Setting Power On Configuration Settings

Background

The Power On configuration settings can only be changed during power up to prevent the configuration settings being inadvertently changed.

- Ensure the load is not connected.
- Ensure the power supply is off.

Steps

1. Hold the Function key whilst turning the power on.
2. The display will show F-90 on the top and the configuration setting for F-90 on the bottom.

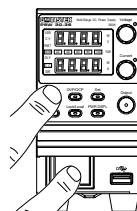

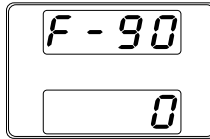

3. Rotate the voltage knob to change the F setting.

Range F-90~ F-95

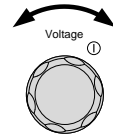

4. Use the current knob to set the parameter for the chosen F setting.

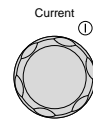

5. Press the Voltage knob to save the configuration setting. Conf will be displayed when successful.

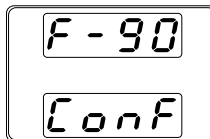
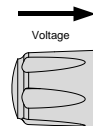

Exit

Cycle the power to save and exit the configuration settings.

Configuration Table

Please use the configuration settings listed below when applying the configuration settings.

Normal Function		
Settings	Setting	Setting Range
Output ON delay time	F-01	0.00s ~ 99.99s
Output OFF delay time	F-02	0.00s ~ 99.99s
V-I mode slew rate select	F-03	0 = CV high speed priority 1 = CC high speed priority 2 = CV slew rate priority 3 = CC slew rate priority
Rising voltage slew rate	F-04	0.01V/s ~ 60.00V/s (PSW 30-XX) 0.01V/s ~ 80.00V/s (PSW 40-XX) 0.1V/s ~ 160.0V/s (PSW 80-XX) 0.1V/s ~ 320.0V/s (PSW 160-XX) 0.1V/s ~ 500.0V/s (PSW 250-XX) 1V/s ~ 1600V/s (PSW 800-XX)
Falling voltage slew rate	F-05	0.01V/s ~ 60.00V/s (PSW 30-XX) 0.01V/s ~ 80.00V/s (PSW 40-XX) 0.1V/s ~ 160.0V/s (PSW 80-XX) 0.1V/s ~ 320.0V/s (PSW 160-XX) 0.1V/s ~ 500.0V/s (PSW 250-XX) 1V/s ~ 1600V/s (PSW 800-XX)
Rising current slew rate	F-06	0.01A/s ~ 72.00A/s (PSW 30-36) 0.1A/s ~ 144.0A/s (PSW 30-72) 0.1A/s ~ 216.0A/s (PSW 30-108) 0.01A/s ~ 54.00A/s (PSW 40-27) 0.1A/s ~ 108.0A/s (PSW 40-54) 0.1A/s ~ 162.0A/s (PSW 40-81) 0.01A/s ~ 27.00A/s (PSW 80-13.5) 0.01A/s ~ 54.00A/s (PSW 80-27) 0.01A/s ~ 81.00A/s (PSW 80-40.5) 0.01A/s ~ 14.40A/s (PSW 160-7.2) 0.01A/s ~ 28.80A/s (PSW 160-14.4) 0.01A/s ~ 43.20A/s (PSW 160-21.6) 0.001A/s ~ 9.000A/s (PSW 250-4.5) 0.01A/s ~ 18.00A/s (PSW 250-9)

		0.01A/s ~ 27.00A/s (PSW 250-13.5)
		0.001A/s ~ 2.880A/s (PSW 800-1.44)
		0.001A/s ~ 5.760A/s (PSW 800-2.88)
		0.001A/s ~ 8.640A/s (PSW 800-4.32)
		0.01A/s ~ 72.00A/s (PSW 30-36)
		0.1A/s ~ 144.0A/s (PSW 30-72)
		0.1A/s ~ 216.0A/s (PSW 30-108)
		0.01A/s ~ 54.00A/s (PSW 40-27)
		0.1A/s ~ 108.0A/s (PSW 40-54)
		0.1A/s ~ 162.0A/s (PSW 40-81)
		0.01A/s ~ 27.00A/s (PSW 80-13.5)
		0.01A/s ~ 54.00A/s (PSW 80-27)
Falling current slew rate	F-07	0.01A/s ~ 81.00A/s (PSW 80-40.5)
		0.01A/s ~ 14.40A/s (PSW 160-7.2)
		0.01A/s ~ 28.80A/s (PSW 160-14.4)
		0.01A/s ~ 43.20A/s (PSW 160-21.6)
		0.001A/s ~ 9.000A/s (PSW 250-4.5)
		0.01A/s ~ 18.00A/s (PSW 250-9)
		0.01A/s ~ 27.00A/s (PSW 250-13.5)
		0.001A/s ~ 2.880A/s (PSW 800-1.44)
		0.001A/s ~ 5.760A/s (PSW 800-2.88)
		0.001A/s ~ 8.640A/s (PSW 800-4.32)
		0.000Ω ~ 0.833Ω (PSW 30-36)
		0.000Ω ~ 0.417Ω (PSW 30-72)
		0.000Ω ~ 0.278Ω (PSW 30-108)
		0.000Ω ~ 1.481Ω (PSW 40-27)
		0.000Ω ~ 0.741Ω (PSW 40-54)
		0.000Ω ~ 0.494Ω (PSW 40-81)
		0.000Ω ~ 5.926Ω (PSW 80-13.5)
		0.000Ω ~ 2.963Ω (PSW 80-27)
Internal resistance setting	F-08	0.000Ω ~ 1.975Ω (PSW 80-40.5)
		0.000Ω ~ 22.222Ω (PSW 160-7.2)
		0.000Ω ~ 11.111Ω (PSW 160-14.4)
		0.000Ω ~ 7.407Ω (PSW 160-21.6)
		0.00Ω ~ 55.55Ω (PSW 250-4.5)
		0.00Ω ~ 27.77Ω (PSW 250-9)
		0.00Ω ~ 18.51Ω (PSW 250-13.5)
		0.0Ω ~ 555.5Ω (PSW 800-1.44)
		0.0Ω ~ 277.8Ω (PSW 800-2.88)
		0.0Ω ~ 185.1Ω (PSW 800-4.32)
Bleeder circuit control	F-09	0 = OFF, 1 = ON, 2 = AUTO

Buzzer ON/OFF control	F-10	0 = OFF, 1 = ON
Measurement Average Setting	F-17	0 = Low, 1 = Middle, 2 = High
Lock Mode	F-19	0 = Panel lock: allow output off 1 = Panel lock: allow output on/off
USB/GPIB settings		
Front panel USB State	F-20	0 = Absent, 1 = Mass Storage
Rear panel USB State	F-21	0 = Absent, 2 = USB-CDC, 3 = GPIB-USB adapter
Rear panel USB mode	F-22	0 = Disable, 1 = USB Host, 2 = Auto detect speed, 3 = Full speed only
GPIB address	F-23	0~30
LAN settings		
MAC Address-1	F-30	0x00~0xFF
MAC Address-2	F-31	0x00~0xFF
MAC Address-3	F-32	0x00~0xFF
MAC Address-4	F-33	0x00~0xFF
MAC Address-5	F-34	0x00~0xFF
MAC Address-6	F-35	0x00~0xFF
LAN	F-36	0 = Disable, 1 = Enable
DHCP	F-37	0 = Disable, 1 = Enable
IP Address-1	F-39	0~255
IP Address-2	F-40	0~255
IP Address-3	F-41	0~255
IP Address-4	F-42	0~255
Subnet Mask-1	F-43	0~255
Subnet Mask-2	F-44	0~255
Subnet Mask-3	F-45	0~255
Subnet Mask-4	F-46	0~255
Gateway-1	F-47	0~255
Gateway-2	F-48	0~255
Gateway-3	F-49	0~255
Gateway-4	F-50	0~255
DNS address -1	F-51	0~255
DNS address -2	F-52	0~255
DNS address-3	F-53	0~255
DNS address-4	F-54	0~255
Sockets active	F-57	0 = Disable, 1 = Enable
Web Server active	F-59	0 = Disable, 1 = Enable
Web password active	F-60	0 = Disable, 1 = Enable

Web setting password	F-61	0000~9999
System Settings		
Factory Set Value	F-88	0 = Disable 1 = Return to factory settings
Show Version	F-89	0, 1 = PSW version 2, 3 = PSW build year 4, 5 = PSW build month/day 6, 7 = Keyboard CPLD version 8, 9 = Analog-Control CPLD version A, B = Reserved C, D = Kernel build year E, F = Kernel build month/day G, H = Test command version I, J = Test command build year K, L = Test command build month/day M, N = USB Driver version.
Power On Configuration Settings*		
CV Control	F-90	0 = Panel control (local) 1 = External voltage control 2 = External resistance control (Ext-R \searrow 10k Ω = Vo, max) 3 = External resistance control (Ext-R \triangle 10k Ω = 0)
CC Control	F-91	0 = Panel control (local) 1 = External voltage control 2 = External resistance control (Ext-R \searrow 10k Ω = Io, max) 3 = External resistance control (Ext-R \triangle 10k Ω = 0)
Power-ON Output	F-92	0 = OFF at startup 1 = ON at startup T001 ~ T010 = Run test script TXX at start up
Master/Slave	F-93	0 = Master/Local 1 = Master/Parallel1 2 = Master/Parallel2 3 = Slave/Parallel 4 = Slave/Series (Only 30V, 40V, 80V, 160V models)

External Out Logic	F-94	0 = High ON, 1 = Low ON
Power Switch trip	F-95	0 = Enable , 1 = Disable
Calibration Settings*		
Calibration	F-00	0000 ~ 9999



*Note

Power On and Calibration settings can only be set during power up.

REMOTE CONTROL

This chapter describes basic configuration of IEEE488.2 based remote control. For a command list, refer to the programming manual, downloadable from GW Instek website, www.gwinstek.com

Interface Configuration	30
USB Remote Interface.....	30
Configure GPIB Interface	30
Configure Ethernet Connection	32
Web Server Configuration	32
Sockets Server Configuration	33
USB Remote Control Function Check.....	34
Using Realterm to Establish a Remote Connection.....	35
Web Server Remote Control Function Check	38
Socket Server Function Check.....	38
Socket Server Examples	44
Visual Basic Example.....	44
C++ Example	45
LabVIEW Example	47
Command Syntax	48
Command List	52
Status Register Overview	101
Introduction to the Status Registers.....	101
The Status Registers	102
Questionable Status Register Group.....	103
Operation Status Register Group	105
Standard Event Status Register Group.....	107
Status Byte Register & Service Request Enable Register	109
Error List	111
Command Errors	111
Execution Errors	115
Device Specific Errors.....	117
Query Errors	118

Interface Configuration

USB Remote Interface

USB configuration	PC side connector	Type A, host
	PSW side connector	Rear panel Type B, slave
	Speed	1.1/2.0 (full speed/high speed)
	USB Class	CDC (communications device class)

Panel operation 1. Connect the USB cable to the rear panel USB B port.

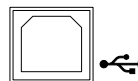

2. Press the Function key to enter the Normal configuration settings. Page 21

Set the following USB settings:

F-22 = 2 Set the rear panel USB port to USB-CDC.

Configure GPIB Interface

To use GPIB, the optional GPIB to USB (GUG-001) adapter must be used. The GPIB to USB adapter must be connected before the PSW is turned on. Only one GPIB address can be used at a time.

- Configure GPIB
1. Ensure the PSW is off before proceeding.
 2. Connect the USB cable from the rear panel USB B port on the PSW to the USB A port on the GPIB to USB adapter.

3. Connect a GPIB cable from a GPIB controller to the GPIB port on the adapter.

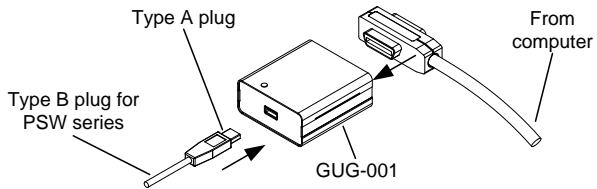

4. Turn the PSW on.
5. Press the Function key to enter the Page 21 Normal configuration settings.

Set the following GPIB settings:

- F-22 = 1 Set the real panel USB port to USB Host.
F-23 = 0~30 Set the GPIB address (0~30)
-

- GPIB constraints
- Maximum 15 devices altogether, 20m cable length, 2m between each device
 - Unique address assigned to each device
 - At least 2/3 of the devices turned On
 - No loop or parallel connection

Configure Ethernet Connection

The Ethernet interface can be configured for a number of different applications. Ethernet can be configured for basic remote control or monitoring using a web server or it can be configured as a socket server.

The PSW series supports both DHCP connections so the instrument can be automatically connected to an existing network or alternatively, network settings can be manually configured.

Ethernet
configuration
Parameters

For details on how to configure the Ethernet settings, please see the configuration table on page 24.

MAC Address (display only)	LAN
DHCP	IP Address
Subnet Mask	Gateway
DNS Address	Sockets Active
Web Server Active	Web Password Active
Web set password	0000~9999 (default 0000)

Web Server Configuration

Configuration

This configuration example will configure the PSW as a web server and use DHCP to automatically assign an IP address to the PSW.

1. Connect an Ethernet cable from the network to the rear panel Ethernet port.

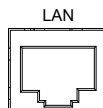

2. Press the Function key to enter the Page 21 Normal configuration settings.

Set the following LAN settings:

F-36 = 1	Enable LAN
F-37 = 1	Turn DHCP to enable
F-59 = 1	Turn the web server on



Note

It may be necessary to cycle the power or refresh the web browser to connect to a network.

Sockets Server Configuration

Configuration This configuration example will configure the PSW sockets server.

The following configuration settings will manually assign the PSW an IP address and enable the socket server. By default, the socket server port number is 2268 and cannot be configured.

1. Connect an Ethernet cable from the network to the rear panel Ethernet port.

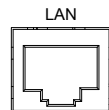

2. Press the Function key to enter the Page 21 Normal configuration settings.

3. Set the following LAN settings:

F-36 = 1	Enable LAN
F-37 = 0	Disable DHCP
F-39 = 172	IP Address part 1 of 4
F-40 = 16	IP Address part 2 of 4
F-41 = 5	IP Address part 3 of 4
F-42 = 133	IP Address part 4 of 4
F-43 = 255	Subnet Mask part 1 of 4

F-44 = 255	Subnet Mask part 2 of 4
F-45 = 128	Subnet Mask part 3 of 4
F-46 = 0	Subnet Mask part 4 of 4
F-43 = 172	Gateway part 1 of 4
F-44 = 16	Gateway part 2 of 4
F-45 = 21	Gateway part 3 of 4
F-46 = 101	Gateway part 4 of 4
F-57 = 1	Enable Sockets



Note

The socket function is only available for firmware version V1.12 or above. See the user manual to check your firmware version number.

USB Remote Control Function Check

Functionality check

Invoke a terminal application such as Realterm. The PSW will appear as a COM port on the PC.

To check the COM port No, see the Device Manager in the PC. For WinXP; Control panel → System → Hardware tab.



Note

If you are not familiar with using a terminal application to send/receive remote commands via a USB connection, please page 35(Using Realterm to Establish a Remote Connection) for more information.

Run this query command via the terminal after the instrument has been configured for USB remote control (page 30).

*idn?

This should return the Manufacturer, Model number, Serial number, and Firmware version in the following format.

GW-INSTEK,PSW-XXX-X,TW123456,01.00.20110101

Manufacturer: GW-INSTEK
Model number : PSW-3036
Serial number : TW123456
Firmware version : 01.00.20110101

Using Realterm to Establish a Remote Connection

Background Realterm is a terminal program that can be used to communicate with a device attached to the serial port of a PC or via an emulated serial port via USB.

The following instructions apply to version 2.0.0.70. Even though Realterm is used as an example to establish a remote connection, any terminal program can be used that has similar functionality.



Note

Realterm can be downloaded on Sourceforge.net free of charge.

For more information please see
<http://realterm.sourceforge.net/>

- Operation**
1. Download Realterm and install according to the instructions on the Realterm website.
 2. Connect the PSW via USB (page 30).
 3. Go to the Windows device manager and find the COM port number for the connection. For example, go to the Start menu > Control Panel > Device Manager

Double click the *Ports* icon to reveal the connected serial port devices and the COM port for the each connected device.

The baud rate, stop bit and parity settings can be viewed for the virtual COM port by right-clicking connected device and selecting the *Properties* option.

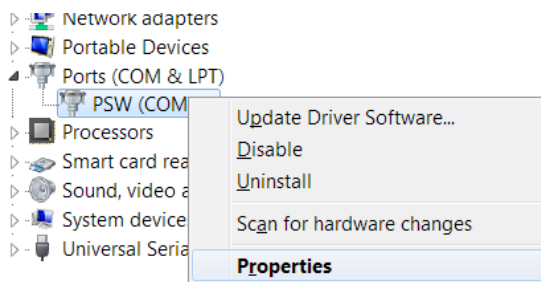

4. Start Realterm on the PC as an administrator.
Click:
Start menu>All Programs>RealTerm>realterm

Tip: to run as an administrator, you can right click the Realterm icon in the Windows Start menu and select the *Run as Administrator* option.

5. After Realterm has started, click on the *Port* tab.

Enter the *Baud*, *Parity*, *Data bits*, *Stop bits* and *Port* number configuration for the connection.

The *Hardware Flow Control*, *Software Flow Control* options can be left at the default settings.

Press *Open* to connect to the PSW.

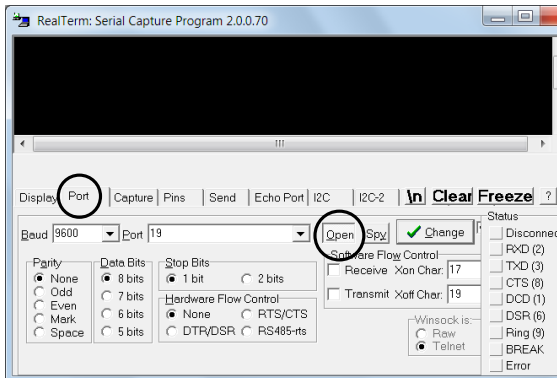

6. Click on the *Send* tab.

In the *EOL* configuration, check on the *+CR* and *+LF* check boxes.

Enter the query:

**idn?*

Click on *Send ASCII*.

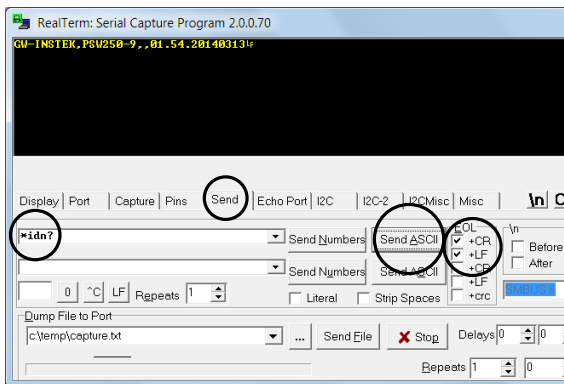

7. The terminal display will return the following:
GW-INSTEK,PSW-XXX-X,TW123456,01.00.20110101
 (manufacturer, model, serial number, version)
8. If Realterm fails to connect to the PSW, please check all the cables and settings and try again.

Web Server Remote Control Function Check

Functionality check Enter the IP address of the power supply in a web browser after the instrument has been configured as a web server (page 32).

`http:// XXX.XXX.XXX.XXX`

The web browser interface appears.

Socket Server Function Check

Background To test the socket server functionality, National Instruments Measurement and Automation Explorer can be used. This program is available on the NI website, www.ni.com, via a search for the VISA Run-time Engine page, or “downloads” at the following URL,
<http://www.ni.com/visa/>

Requirements Firmware: V1.12
 Operating System: Windows XP, 7

Functionality check 1. Start the NI Measurement and Automation Explorer (MAX) program. Using Windows, press:

Start>All Programs>National Instruments>Measurement & Automation



2. From the Configuration panel access;

My System>Devices and Interfaces>Network Devices

3. Click *Create New...*

4. Select *Visa TCP/IP Resource*.

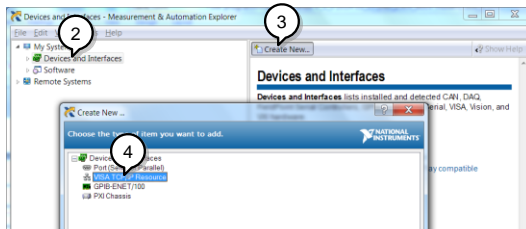

5. Select *Manual Entry of Raw Socket* from the popup window.
6. Click *Next*.

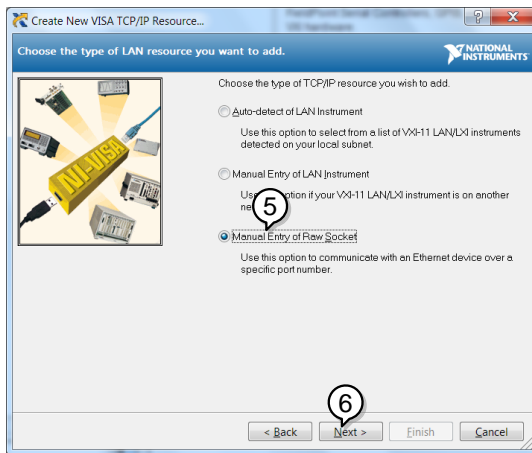

7. Enter the IP address and the port number of the PSW. The port number is fixed at 2268.
8. Click the Validate button. A popup box will appear when successful.
9. Click *Next*.

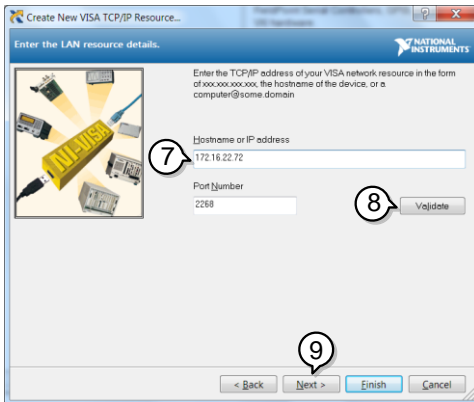

10. Next configure the Alias (name) of the PSW connection. In this example the Alias is: PSW_DC1

11. Click finish.

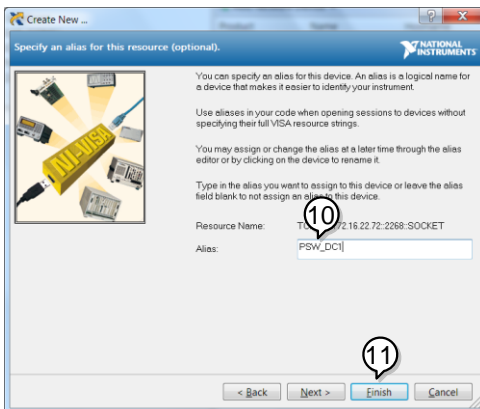

12. The IP address of the PSW will now appear under Network Devices in the configuration panel. Select this icon now.

13. Press *Open VISA Test Panel*.

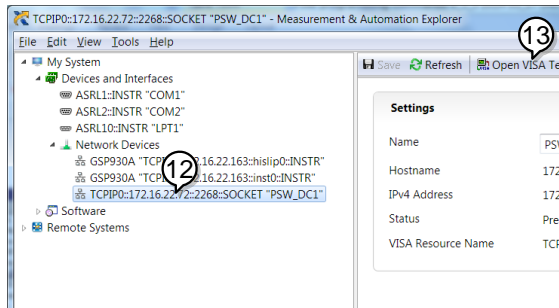

14. Click *Configuration* icon.

15. In the *I/O Settings* tab, select the *Enable Termination Character* check box. Ensure *Line Feed - \n* is selected as the line feed character.

16. Click *Apply Changes*.

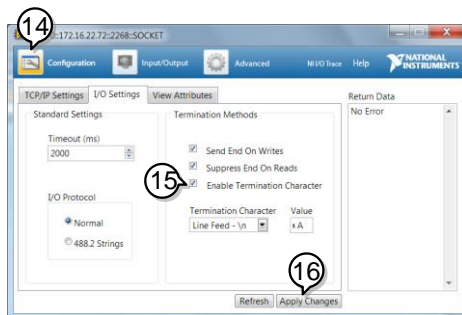

17. Click the *Input/Output* icon.

18. Ensure **IDN? \n* is selected in the *Select or Enter Command* dropdown text box.

19. Click the *Query* button.

20. The **IDN?* query should be returned to the buffer area:
 GW-INSTEK,PSW250-9,,01.54.20140313\n

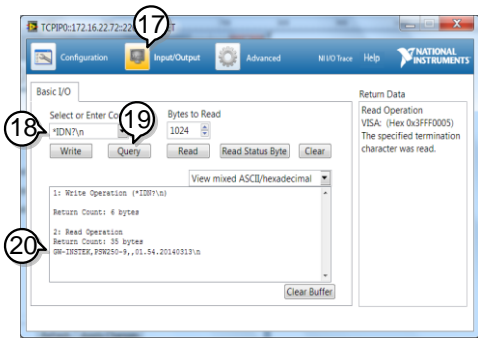

 **Note**

For further details, please see the following programming examples.

Socket Server Examples

Visual Basic Example

Background The following visual basic programming example uses the VISA COM 3.0 Type Library. The example will connect to the PSW using the IP address of 172.15.5.133 over port 2268. The program will send the *IDN? to the PSW, print the return string and then close the connection.

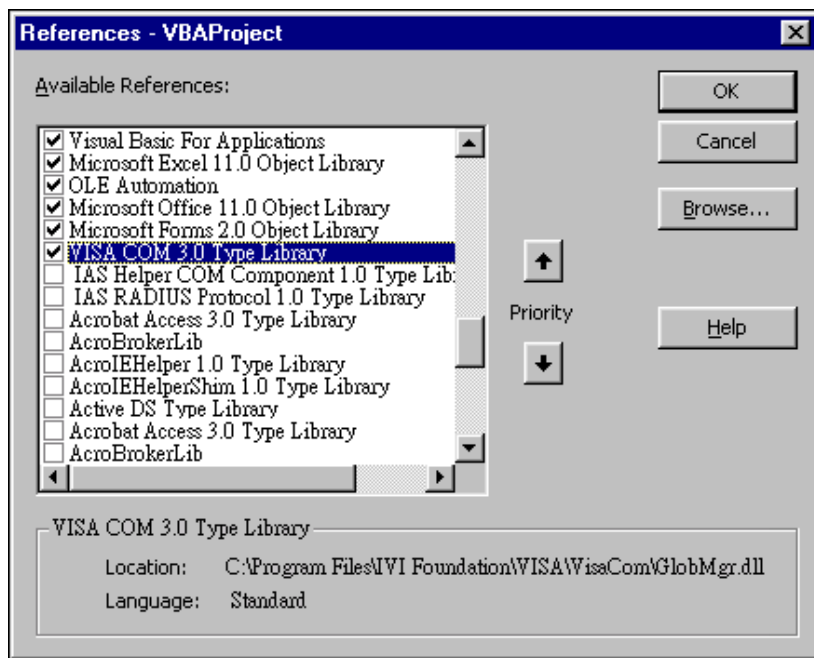

```

'Create VISA ResourceManager object
Dim rm As New VisaComLib.ResourceManager
Dim accessMode As VisaComLib.accessMode
Dim serial As String
Dim timeOut As Integer
Dim optionString As String
Dim psw As VisaComLib.IMessage
Dim pswcom As VisaComLib.FormattedIO488
Dim pswsfc As VisaComLib.IAsyncMessage

Private Sub CommandButton1_Click()
    accessMode = VisaComLib.accessMode.NO_LOCK

    timeOut = 0

    optionString = ""

    'Connect to the PSW
    Set psw = rm.Open("TCPIP0::172.16.5.133::2268::SOCKET", _
        accessMode, _
        timeOut, _
        optionString)
    Set pswsfc = psw
    pswsfc.TerminationCharacterEnabled = True

    'Query the System Identify Name
    psw.WriteString ("*IDN?" & vbCrLf)

    Worksheets("Sheet1").Cells(1, 5) = psw.ReadString(256)

    'Close the communication
    psw.Close
End Sub

```

C++ Example

Background The following program creates a connection to the PSW and sets the voltage to 3.3 volts and the current 1.5 amps. The voltage and current reading is then read back and the connection is closed.



Note

Add visa32.lib to the project library when building the following sample program.

```
#include "stdio.h"
#include "string.h"
#include "visatype.h"
#include "visa.h"
#define IPAddr "172.16.20.181"
int main(int argc, char* argv[])
{
    ViSession defaultRm, instr;
    // Create VISA ResourceManager object
    ViStatus status = viOpenDefaultRM(&defaultRm);
    if (status < VI_SUCCESS)
    {
        // Initialization error
        return -1;
    }
    ViChar rsc[256];
    sprintf(rsc, "TCPIP0::%s::2268::SOCKET", IPAddr);
    ViAccessMode accessMode = VI_NO_LOCK;
    ViUInt32 timeout = 0;
    // Connect the device
    viOpen(defaultRm, rsc, accessMode, timeout, &instr);
    /* Set the timeout for message-based communication */
    status = viSetAttribute(instr, VI_ATTR_TMO_VALUE, 5000);
    status = viSetAttribute(instr, VI_ATTR_TERMCHAR, 10);
    status = viSetAttribute(instr, VI_ATTR_TERMCHAR_EN, VI_TRUE);
    ViUInt32 count;
    // Set the Voltage to 3.3, Current to 1.5
    ViBuf buf = (ViBuf)":volt 3.3::curr 1.5\n";
    viWrite(instr, buf, (ViUInt32)strlen((ViPChar)buf), &count);

    // Query the Voltage, and Current
    buf = (ViBuf)":apply?\n";
    status = viWrite(instr, buf, (ViUInt32)strlen((ViPChar)buf), &count);
    ViChar result[257];
    status = viRead(instr, (ViPBuf)result, 256, &count);
    if (status=VI_SUCCESS_TERM_CHAR)
    {
        result[count] = 0;
        printf("Voltage(V), Current(A)= %s\n", result);
    }else
        printf("Error\n");

    // Close the device
    viClose(instr);
    viClose(defaultRm);

    return 0;
}
```

LabVIEW Example

Background The following picture shows a LabVIEW programming example for the PSW.

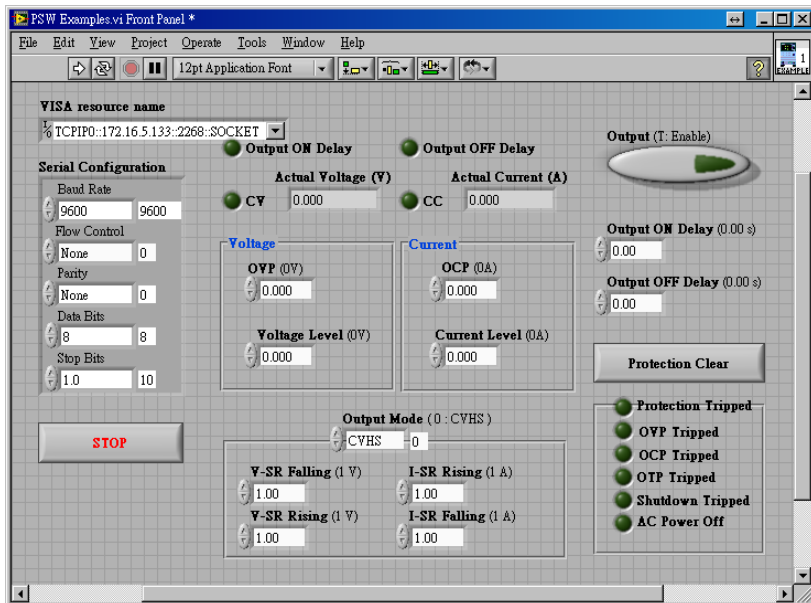

Command Syntax

Compatible Standard	IEEE488.2	Partial compatibility
	SCPI, 1999	Partial compatibility

Command Structure SCPI commands follow a tree-like structure, organized into nodes. Each level of the command tree is a node. Each keyword in a SCPI command represents each node in the command tree. Each keyword (node) of a SCPI command is separated by a colon (:).

For example, the diagram below shows an SCPI sub-structure and a command example.

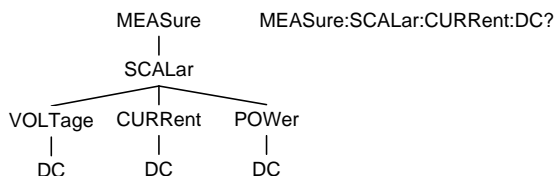

Command types There are a number of different instrument commands and queries. A command sends instructions or data to the unit and a query receives data or status information from the unit.

Command types

Simple A single command with/without a parameter

Example *IDN?

Query	A query is a simple or compound command followed by a question mark (?). A parameter (data) is returned.
Example	meas:curr:dc?

Compound	<p>Two or more commands on the same command line. Compound commands are separated with either a semi-colon (;) or a semi-colon and a colon (;:).</p> <p>A semi-colon is used to join two related commands, with the caveat that the last command must begin at the last node of the first command.</p> <p>A semi-colon and colon are used to combine two commands from different nodes.</p>
Example	meas:volt:dc?::meas:curr:dc?

Command Forms	<p>Commands and queries have two different forms, long and short. The command syntax is written with the short form of the command in capitals and the remainder (long form) in lower case.</p> <p>The commands can be written in capitals or lower-case, just so long as the short or long forms are complete. An incomplete command</p>
---------------	---

will not be recognized.

Below are examples of correctly written commands.

Long form STATUS:OPERation:NTRansition?
 STATUS:OPERATION:NTRANSITION?
 status:operation:ntransition?

Short form STAT:OPER:NTR?
 stat:oper:ntr?

Square Brackets

Commands that contain square brackets indicate that the contents are optional. The function of the command is the same with or without the square bracketed items, as shown below.

Both "DISPlay:MENU[:NAME]?" and "DISPlay:MENU?" are both valid forms.

Command Format

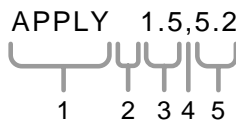

1. Command header
2. Space
3. Parameter 1
4. Comma (no space before/after comma)
5. Parameter 2

Parameters

Type	Description	Example
<Boolean>	Boolean logic	0, 1
<NR1>	integers	0, 1, 2, 3
<NR2>	decimal numbers	0.1, 3.14, 8.5
<NR3>	floating point	4.5e-1, 8.25e+1
<NRf>	any of NR1, 2, 3	1, 1.5, 4.5e-1

<block data> Definitive length arbitrary block data. A single decimal digit followed by data. The decimal digit specifies how many 8-bit data bytes follow.

Message Terminator LF Line feed code

Command List

Abort Command	ABORt	55
Apply Command	APPLy	56
Display Commands	DISPlay:MENU[:NAME]	57
	DISPlay[:WINDow]:TEXT:CLEar	57
	DISPlay[:WINDow]:TEXT[:DATA]	58
	DISPlay:BLINK	58
Initiate Command	INITiate[:IMMediate]:NAME	60
Measure Commands	MEASure[:SCALar]:ALL[:DC]	61
	MEASure[:SCALar]:CURREnt[:DC]	61
	MEASure[:SCALar]:VOLTAge[:DC]	61
	MEASure[:SCALar]:POWER[:DC]	62
Output Commands	OUTPut:DELAy:ON	63
	OUTPut:DELAy:OFF	63
	OUTPut:MODE	64
	OUTPut[:STATe][:IMMediate]	64
	OUTPut[:STATe]:TRIGgered	65
	OUTPut:PROTEction:CLEar	65
	OUTPut:PROTEction:TRIPped	65
Sense Command	SENSe:AVERAge:COUNt	66
Status Commands	STATus:OPERation[:EVENt]	67
	STATus:OPERation:CONDition	67
	STATus:OPERation:ENABle	67
	STATus:OPERation:PTRansition	68
	STATus:OPERation:NTRansition	68
	STATus:QUEStionable[:EVENt]	68
	STATus:QUEStionable:CONDition	69

	STATus:QUEStionable:ENABle.....	69
	STATus:QUEStionable:PTRAnsiTion.....	69
	STATus:QUEStionable:NTRAnsiTion.....	69
	STATus:PRESet.....	70
Source	[SOURce:]CURRent[:LEVel][:IMMediate]	
Commands	[:AMPLitude]	71
	[SOURce:]CURRent[:LEVel]:TRIGgered[:AMPLitude]	72
	[SOURce:]CURRent:PROTection[:LEVel].....	72
	[SOURce:]CURRent:PROTection:STATe.....	73
	[SOURce:]CURRent:SLEW:RISing.....	73
	[SOURce:]CURRent:SLEW:FALLing.....	74
	[SOURce:]RESistance[:LEVel][:IMMediate]	
	[:AMPLitude]	75
	[SOURce:]VOLTage[:LEVel][:IMMediate]	
	[:AMPLitude]	76
	[SOURce:]VOLTage[:LEVel]:TRIGgered[:AMPLitude]	76
	[SOURce:]VOLTage:PROTection[:LEVel].....	77
	[SOURce:]VOLTage:SLEW:RISing.....	77
	[SOURce:]VOLTage:SLEW:FALLing.....	78
Trigger	TRIGger:TRANsient[:IMMediate]	79
Commands	TRIGger:TRANsient:SOURce.....	79
	TRIGger:OUTPut[:IMMediate]	80
	TRIGger:OUTPut:SOURce.....	80
	Trigger Command Examples.....	80
System	SYSTem:BEEPer[:IMMediate].....	83
Commands	SYSTem:CONFigure:BEEPer[:STATe].....	83
	SYSTem:CONFigure:BLEeder[:STATe].....	84
	SYSTem:CONFigure:BTrip[:IMMediate]	84
	SYSTem:CONFigure:BTrip:PROTection.....	85
	SYSTem:CONFigure:CURRent:CONTRol.....	85
	SYSTem:CONFigure:VOLTage:CONTRol.....	86
	SYSTem:CONFigure:MSLave.....	86
	SYSTem:CONFigure:OUTPut:EXTernal[:MODE].....	87
	SYSTem:CONFigure:OUTPut:PON[:STATe].....	87
	SYSTem:COMMunicate:ENABle.....	88
	SYSTem:COMMunicate:GPIB[:SELF]:ADDRess.....	89
	SYSTem:COMMunicate:LAN:IPADDRess.....	89
	SYSTem:COMMunicate:LAN:GATEway.....	90
	SYSTem:COMMunicate:LAN:SMASK.....	90

SYSTem:COMMunicate:LAN:MAC 90
 SYSTem:COMMunicate:LAN:DHCP 91
 SYSTem:COMMunicate:LAN:DNS..... 91
 SYSTem:COMMunicate:LAN:HOSTname 91
 SYSTem:COMMunicate:LAN:WEB:PACTive 92
 SYSTem:COMMunicate:LAN:WEB:PASSword 92
 SYSTem:COMMunicate:RLState 93
 SYSTem:COMMunicate:USB:FRONt:STATe..... 93
 SYSTem:COMMunicate:USB:REAR:STATe..... 94
 SYSTem:COMMunicate:USB:REAR:MODE..... 94
 SYSTem:ERRor..... 94
 SYSTem:KEYLock:MODE..... 95
 SYSTem:KLOCK..... 95
 SYSTem:INFormation 95
 SYSTem:PRESet 96
 SYSTem:VERSIon 96

**Common
Commands**

*CLS 97
 *ESE 97
 *ESR 98
 *IDN 98
 *OPC 98
 *RST 99
 *SRE 99
 *STB 99
 *TRG 100
 *TST 100
 *WAI 100

Abort Command

ABORt55

ABORt



Description	The ABORt command will cancel any triggered actions.
-------------	--

Syntax	ABORt
--------	-------

APPLy Command

APPLy56

APPLy

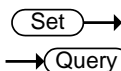

Description The APPLy command is used to set both the voltage and current. The voltage and current will be output as soon as the function is executed if the programmed values are within the accepted range. An execution error will occur if the programmed values are not within accepted ranges.

The Apply command will set the voltage/current values but these values will not be reflected on the display until the Output is On or if the DISPlay:MENU:NAME 3 (set menu) command is used.

Syntax APPLY {<voltage>|MIN|MAX}[,<current>|MIN|MAX]}

Query Syntax APPLy?

Parameter	<voltage>	<NRf> 0% ~ 105% of the rated output voltage.
	<current>	<NRf> 0% ~ 105% of the rated output current.
	MIN	0 volts/0 amps
	MAX	Maxium value for the present range.

Return parameter <NRf> Returns the voltage and current.

Example APPL 5.05,1.1

Sets the voltage and current to 5.05V and 1.1A.

Query Example APPL?

+5.050, +1.100

Returns voltage (5.05V) and current (1.1A) setting.

Display Commands

DISPlay:MENU[:NAME]	57
DISPlay[:WINDow]:TEXT:CLEAr	57
DISPlay[:WINDow]:TEXT[:DATA]	58
DISPlay:BLINK	58

DISPlay:MENU[:NAME]

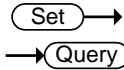

Description	The DISPlay MENU command selects a screen menu or queries the current screen menu.	
Syntax	DISPlay:MENU[:NAME] <NR1>	
Query Sytax	DISPlay:MENU[:NAME]?	
Parameter/ Return parameter	<NR1>	Description
	0	Measurement-Voltage / Measurement-Current
	1	Measurement-Voltage / Measurement-Power
	2	Measurement-Power / Measurement-Current
	3	Set Menu
	4	OVP / OCP Menu
	5~99	Not Used.
	100~199	F-00~99 Menu.

Example DISP:MENU:NAME 0
 Sets the display to the Voltage/Current display screen.

DISPlay[:WINDow]:TEXT:CLEAr



Description Clears the text on the main screen from the DISPlay[:WINDow]:TEXT[:DATA] command.

Syntax DISP[ay]:WINDow]:TEXT:CLEar

Set →

DISP[ay]:WINDow]:TEXT[:DATA]

→ Query

Description Sets or queries the data text that will be written to the display. Writing to the display will overwrite data that is currently on the screen. Overwriting a display area with a shorter string may or may not overwrite the screen. The string must be enclosed in quotes: "STRING". Only ASCII characters 20H to 7EH can be used in the <string>.

Syntax DISP[ay]:WINDow]:TEXT[:DATA] <string>

Query Syntax DISP[ay]:WINDow]:TEXT[:DATA]?

Parameter/
Return parameter <string> ASCII character 20H to 7EH can be used to in the string parameter. The string must be enclosed in quotes: "STRING"

Example DISP:WIND:TEXT:DATA "STRING"
Writes STRING to the display.

Query Example DISP:WIND:TEXT:DATA?
"STRING"
Returns the text data string on the screen.

Set →

DISP[ay]:BLINK

→ Query

Description Turns blink on or off for the display.

Syntax DISP[ay]:BLINK { 0 | 1 | OFF | ON }

Query Syntax DISP[ay]:BLINK?

Parameter	0	<NR1>Turns blink OFF
	OFF	Turns blink OFF
	1	<NR1> Turns blink ON
	ON	Turns blink ON

Return parameter	0	<NR1>Turns blink OFF
	1	<NR1>Turns blink ON

Example DISP:BLIN 1
 Turns blink ON.

Initiate Command

INITiate[:IMMEDIATE]:NAME60

INITiate[:IMMEDIATE]:NAME



Description	<p>The INITiate command starts the TRANSient or OUTPut trigger.</p> <p>See the trigger commands on page 79 for usage details.</p>
Syntax	INITiate[:IMMEDIATE]:NAME {TRANSient OUTPut}
Parameter	<p>TRANSient Starts the TRANSient trigger.</p> <p>OUTPut Starts the OUTPut trigger.</p>
Example	<p>INITiate:NAME TRANient</p> <p>Starts the TRANSient trigger.</p>

Measure Commands

MEASure[:SCALar]:ALL[:DC].....	61
MEASure[:SCALar]:CURRent[:DC]	61
MEASure[:SCALar]:VOLTage[:DC]	61
MEASure[:SCALar]:POWer[:DC]	62

MEASure[:SCALar]:ALL[:DC] → Query

Description	Takes a measurement and returns the average output current and voltage	
Syntax	:MEASure[:SCALar]:ALL[:DC]?	
Return parameter	"+0.0000,+0.0000"	<voltage>,<current> Returns the voltage (V) and current (A), respectively.

MEASure[:SCALar]:CURRent[:DC] → Query

Description	Takes a measurement and returns the average output current	
Syntax	MEASure[:SCALar]:CURRent[:DC]?	
Return parameter	<NRf>	Returns the current in amps.

MEASure[:SCALar]:VOLTage[:DC] → Query

Description	Takes a measurement and returns the average output voltage.	
Syntax	MEASure[:SCALar]:VOLTage[:DC]?	
Return	<NRf>	Returns the voltage in volts.

MEASure[:SCALar]:POWer[:DC]

→ Query

Description	Takes a measurement and returns the average output power.
Syntax	MEASure[:SCALar]:POWer[:DC]?
Return	<NRf> Returns the power measured in watts.

Output Commands

OUTPut:DElay:ON.....	63
OUTPut:DElay:OFF.....	63
OUTPut:MODE.....	64
OUTPut[:STATe][:IMMediate].....	64
OUTPut[:STATe]:TRIGgered.....	65
OUTPut:PROTection:CLEar.....	65
OUTPut:PROTection:TRIPped.....	65

OUTPut:DElay:ON

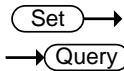

Description	Sets the Delay Time in seconds for turning the output on. The delay is set to 0.00 by default.	
Syntax	OUTPut:DElay:ON <NRf>	
Query Syntax	OUTPut:DElay:ON?	
Parameter	<NRf>	0.00~99.99 seconds, where 0=no delay.
Return parameter	<NRf>	Returns the delay on time in seconds until the output is turned on.

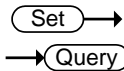

OUTPut:DElay:OFF

Description	Sets the Delay Time in seconds for turning the output off. The delay is set to 0.00 by default.	
Syntax	OUTPut:DElay:OFF <NRf>	
Return Syntax	OUTPut:DElay:OFF?	
Parameter	<NRf>	0.00~99.99 seconds, where 0=no delay.
Return parameter	<NRf>	Returns the delay off time in seconds until the output is turned off.

Set →

→ Query

OUTPut:MODE

Description	Sets the PSW output mode. This is the equivalent to the F-03 (V-I Mode Slew Rate Select) settings.	
Syntax	OUTPut:MODE {<NR1> CVHS CCHS CVLS CCLS}	
Return Syntax	OUTPut:MODE?	
Parameter	0	CV high speed priority
	CVHS	CV high speed priority
	1	CC high speed priority
	CCHS	CC high speed priority
	2	CV slew rate priority
	CVLS	CV slew rate priority
	3	CC slew rate priority
	CCLS	CC slew rate priority
Return parameter	<NR1>	Returns the output mode.

Set →

→ Query

OUTPut[:STATe][:IMMediate]

Description	Turns the output on or off.	
Syntax	OUTPut[:STATe][:IMMediate] { OFF ON 0 1 }	
Query Syntax	OUTPut[:STATe][:IMMediate]?	
Parameter	0	<NR1> Turns the output off.
	OFF	Turns the output off.
	1	<NR1> Turns the output on.
	ON	Turns the output on.
Return parameter	<NR1>	Returns output status of the instrument.

OUTPut[:STATe]:TRIGgered (Set) → → (Query)

Description	Turns the output on or off when a software trigger is generated.	
Syntax	OUTPut[:STATe]:TRIGgered { OFF ON 0 1 }	
Query Syntax	OUTPut[:STATe]:TRIGgered?	
Parameter	0	<NR1>Turns the output off when a software trigger is generated.
	OFF	Turns the output off when a software trigger is generated.
	1	<NR1>Turns the output on when a software trigger is generated.
	ON	Turns the output on when a software trigger is generated.
Return parameter	<NR1>	Returns output trigger status of the instrument.

OUTPut:PROTEction:CLEAr (Set) →

Description	Clears over-voltage, over-current and over-temperature (OVP, OCP, OTP) protection circuits. It also clears the shutdown protection circuit. The AC failure protection cannot be cleared.	
Syntax	OUTPut:PROTEction:CLEAr	

OUTPut:PROTEction:TRIPped → (Query)

Description	Returns the state of the protection circuits (OVP, OCP, OTP).	
Query Syntax	OUTPut:PROTEction:TRIPped?	
Return parameter	0	<NR1>Protection circuits are not tripped.
	1	<NR1>Protection circuits are tripped.

Sense Command

SENSe:AVERAge:COUNT66

SENSe:AVERAge:COUNT

Set →

→ Query

Description	Determines the level of smoothing for the average setting. This is the equivalent to the F-17 function setting.	
Syntax	SENSe:AVERAge:COUNT {<NR1> LOW MIDDLE HIGH}	
Query Syntax	SENSe:AVERAge:COUNT?	
Parameter	0 LOW	Low level of smoothing.
	1 MIDDLE	Middle level of smoothing.
	2 HIGH	High level of smoothing.
Return parameter	<NR1>	Returns the level of smoothing.
	0	Low level of smoothing.
	1	Middle level of smoothing.
	2	High level of smoothing.
Example	SENSe:AVERAge:COUNT 1 Sets the level of smoothing to middle.	

Status Commands

STATus:OPERation[:EVENT]	67
STATus:OPERation:CONDition	67
STATus:OPERation:ENABle	67
STATus:OPERation:PTRansition	68
STATus:OPERation:NTRansition	68
STATus:QUEStionable[:EVENT]	68
STATus:QUEStionable:CONDition	69
STATus:QUEStionable:ENABle	69
STATus:QUEStionable:PTRansition	69
STATus:QUEStionable:NTRansition	69
STATus:PRESet	70

STATus:OPERation[:EVENT] → (Query)

Description	Queries the Operation Status Event register and clears the contents of the register.
Syntax	STATus:OPERation[:EVENT]?
Return	<NR1> Returns the bit sum of the Operation Status Event register.

STATus:OPERation:CONDition → (Query)

Description	Queries the Operation Status register. This query will not clear the register.
Syntax	STATus:OPERation:CONDition?
Return	<NR1> Returns the bit sum of the Operation Condition register.

(Set) →

STATus:OPERation:ENABle → (Query)

Description	Sets or queries the bit sum of the Operation Status Enable register.
-------------	--

Syntax STATus:OPERation:ENABLE <NRf>

Query Syntax STATus:OPERation:ENABLE?

Parameter <NRf> 0 ~ 32767

Return parameter <NR1> 0 ~ 32767

Set →

→ Query

STATus:OPERation:PTRansition

Description Sets or queries the bit sum of the positive transition filter of the Operation Status register.

Syntax STATus:OPERation:PTRansition <NRf>

 STATus:OPERation:PTRansition?

Parameter <NRf> 0 ~ 32767

Return parameter <NR1> 0 ~ 32767

Set →

→ Query

STATus:OPERation:NTRansition

Description Sets or queries the bit sum of the negative transition filter of the Operation Status register.

Syntax STATus:OPERation:NTRansition <NRf>

Query Syntax STATus:OPERation:NTRansition?

Parameter <NRf> 0 ~ 32767

Return parameter <NR1> 0 ~ 32767

→ Query

STATus:QUESTionable[:EVENT]

Description Queries the bit sum of the Questionable Status Event register. This query will also clear the contents of the register.

Query Syntax STATus:QUESTionable[:EVENT]?

Parameter <NRf> 0 ~ 32767

Return parameter <NR1> 0 ~ 32767

STATus:QUEStionable:CONDition → **Query**

Description	Queries the status (bit sum) of the Questionable Status register. This query will not clear the register.
Query Syntax	STATus:QUEStionable:CONDition?
Parameter	<NRf> 0 ~ 32767
Return parameter	<NR1> 0 ~ 32767

Set →
 → Query

STATus:QUEStionable:ENABle

Description	Sets or queries the bit sum of the Questionable Status Enable register.
Syntax	STATus:QUEStionable:ENABle <NRf>
Query Syntax	STATus:QUEStionable:ENABle?
Parameter	<NRf> 0 ~ 32767
Return parameter	<NR1> 0 ~ 32767

Set →
 → Query

STATus:QUEStionable:PTRansition

Description	Sets or queries the bit sum of the positive transition filter of the Questionable Status register.
Syntax	STATus:QUEStionable:PTRansition <NRf>
Return Syntax	STATus:QUEStionable:PTRansition?
Parameter	<NRf> 0 ~ 32767
Return parameter	<NR1> 0 ~ 32767

Set →
 → Query

STATus:QUEStionable:NTRansition

Description	Sets or queries the negative transition filter of the Questionable Status register.
-------------	---

Syntax	STATus:QUEStionable:NTRansition <NRf>	
Query Syntax	STATus:QUEStionable:NTRansition?	
Parameter	<NRf>	0 ~ 32767
Return parameter	<NR1>	0 ~ 32767

STATus:PRESet



Description This command resets the ENABLE register, the PTRansition filter and NTRansition filter on the Operation Status and Questionable Status Registers. The registers/filters will be reset to a default value.

Default Register/Filter Values	Setting
QUEStionable Status Enable	0x0000
QUEStionable Status Positive Transition	0x7FFF
QUEStionable Status Negative Transition	0x0000
Operation Status Enable	0x0000
Operation Status Positive Transition	0x7FFF
Operation Status Negative Transition	0x0000

Summary: The Questionable Status Enable registers and the Operation Status Enable registers are both reset to 0.

The Questionable Status and Operation Status Positive Transition filters are all set high (0x7FFF) and the Negative Transition filters are all set low (0x0000). I.e., only positive transitions will be recognized for the Questionable Status and Operation Status registers.

Syntax STATus:PRESet

Source Commands

[SOURce:]CURRent[:LEVel][:IMMediate]	
[:AMPLitude]	71
[SOURce:]CURRent[:LEVel]:TRIGgered[:AMPLitude]	72
[SOURce:]CURRent:PROTection[:LEVel]	72
[SOURce:]CURRent:PROTection:STATe	73
[SOURce:]CURRent:SLEW:RISing	73
[SOURce:]CURRent:SLEW:FALLing	74
[SOURce:]RESistance[:LEVel][:IMMediate]	
[:AMPLitude]	75
[SOURce:]VOLTag[:LEVel][:IMMediate]	
[:AMPLitude]	76
[SOURce:]VOLTag[:LEVel]:TRIGgered[:AMPLitude]	76
[SOURce:]VOLTag:PROTection[:LEVel]	77
[SOURce:]VOLTag:SLEW:RISing	77
[SOURce:]VOLTag:SLEW:FALLing	78

[SOURce:]CURRent[:LEVel][:IMMediate] (Set) →
 [:AMPLitude] ← (Query)

Description	Sets or queries the current level in amps. For externally set current levels (from the analog control connector) the set current level is returned.						
Syntax	[SOURce:]CURRent[:LEVel][:IMMediate][:AMPLitude] {<NRf> MIN MAX}						
Query Syntax	[SOURce:]CURRent[:LEVel][:IMMediate][:AMPLitude]? [MIN MAX]						
Parameter/Return	<table border="0"> <tr> <td style="background-color: #e0e0e0;"><NRf></td> <td>0~105% of the rated current output level.</td> </tr> <tr> <td style="background-color: #e0e0e0;">MIN</td> <td>Minimum current level.</td> </tr> <tr> <td style="background-color: #e0e0e0;">MAX</td> <td>Maximum current level.</td> </tr> </table>	<NRf>	0~105% of the rated current output level.	MIN	Minimum current level.	MAX	Maximum current level.
<NRf>	0~105% of the rated current output level.						
MIN	Minimum current level.						
MAX	Maximum current level.						
Example	<p>SOUR:CURR:LEV:IMM:AMPL? MAX</p> <p>37.800</p> <p>Returns the maximum possible current level in amps.</p>						

[SOURce:]CURRent[:LEVel]:TRIGgered [Set] →
[:AMPLitude] → [Query]

Description	Sets or queries the current level in amps when a software trigger has been generated.	
Syntax	[SOURce:]CURRent[:LEVel]:TRIGgered[:AMPLitude] {<NRf> MIN MAX}	
Query Syntax	[SOURce:]CURRent[:LEVel]:TRIGgered[:AMPLitude]? [MIN MAX]	
Parameter/Return	<NRf>	0%~105% of the rated current output in amps.
	MIN	Minimum current level.
	MAX	Maximum current level.

Example SOUR:CURR:LEV:TRIG:AMPL? MAX
37.800
Returns the maximum possible current level in amps.

[SOURce:]CURRent:PROTection[:LEVel] [Set] →
→ [Query]

Description	Sets or queries the OCP (over-current protection) level in amps.	
Syntax	[SOURce:]CURRent:PROTection[:LEVel] {<NRf> MIN MAX}	
Query Syntax	[SOURce:]CURRent:PROTection[:LEVel]? [MIN MAX]	
Parameter/Return	<NRf>	OCP range in Amps.
	MIN	Minimum current level.
	MAX	Maximum current level.

Example SOUR:CURR:PROT:LEV? MIN
+3.600
Returns the minimum possible current level in amps.

[SOURce:]CURRent:PROTection:STATe



Description	Turns OCP (over-current protection) on or off.	
Syntax	[SOURce:]CURRent:PROTection:STATe {0 1 OFF ON}	
Query Syntax	[SOURce:]CURRent:PROTection:STATe?	
Parameter/Return	0	<NR1> Turns the buzzer off.
	OFF	Turns the OCP off.
	1	<NR1> Turns the OCP on.
	ON	Turns the OCP on.
Return parameter	<Bool>	Returns the protection status (0 or 1).
Example	SOUR:CURR:PROT:STAT OFF Turns OCP off.	

[SOURce:]CURRent:SLEW:RISing



Description	Sets or queries the rising current slew rate. This is only applicable for CC slew rate priority mode.	
Syntax	[SOURce:]CURRent:SLEW:RISing {<NRf> MIN MAX}	
Query Syntax	[SOURce:]CURRent:SLEW:RISing? [MIN MAX]	
Parameter/Return	<NRf>	0.01A/s ~ 72.00A/s (PSW 30-36) 0.1A/s ~ 144.0A/s (PSW 30-72) 0.1A/s ~ 216.0A/s (PSW 30-108) 0.01A/s ~ 54.00A/s (PSW 40-27) 0.1A/s ~ 108.0A/s (PSW 40-54) 0.1A/s ~ 162.0A/s (PSW 40-81) 0.01A/s ~ 27.00A/s (PSW 80-13.5) 0.01A/s ~ 54.00A/s (PSW 80-27) 0.01A/s ~ 81.00A/s (PSW 80-40.5) 0.01A/s ~ 14.40A/s (PSW 160-7.2) 0.01A/s ~ 28.80A/s (PSW 160-14.4) 0.01A/s ~ 43.20A/s (PSW 160-21.6) 0.001A/s ~ 9.000A/s (PSW 250-4.5) 0.01A/s ~ 18.00A/s (PSW 250-9)

		0.01A/s ~ 27.00A/s (PSW 250-13.5)
		0.001A/s ~ 2.880A/s (PSW 800-1.44)
		0.001A/s ~ 5.760A/s (PSW 800-2.88)
		0.001A/s ~ 8.640A/s (PSW 800-4.32)
	MIN	Minimum rising current slew rate.
	MAX	Maximum rising current slew rate.

Example SOUR:CURR:SLEW:RIS 72
 Sets the rising current slew rate to 72A/s.

[SOURce:]CURRent:SLEW:FALLing



Description Sets or queries the falling current slew rate. This is only applicable for CC slew rate priority mode.

Syntax [SOURce:]CURRent:SLEW:FALLing
 {<NRF>|MIN|MAX}

Query Syntax [SOURce:]CURRent:SLEW:FALLing? [MIN|MAX]

Parameter/Return	NRF	0.01A/s ~ 72.00A/s (PSW 30-36)
		0.1A/s ~ 144.0A/s (PSW 30-72)
		0.1A/s ~ 216.0A/s (PSW 30-108)
		0.01A/s ~ 54.00A/s (PSW 40-27)
		0.1A/s ~ 108.0A/s (PSW 40-54)
		0.1A/s ~ 162.0A/s (PSW 40-81)
		0.01A/s ~ 27.00A/s (PSW 80-13.5)
		0.01A/s ~ 54.00A/s (PSW 80-27)
		0.01A/s ~ 81.00A/s (PSW 80-40.5)
		0.01A/s ~ 14.40A/s (PSW 160-7.2)
		0.01A/s ~ 28.80A/s (PSW 160-14.4)
		0.01A/s ~ 43.20A/s (PSW 160-21.6)
		0.001A/s ~ 9.000A/s (PSW 250-4.5)
		0.01A/s ~ 18.00A/s (PSW 250-9)
		0.01A/s ~ 27.00A/s (PSW 250-13.5)
		0.001A/s ~ 2.880A/s (PSW 800-1.44)
0.001A/s ~ 5.760A/s (PSW 800-2.88)		
0.001A/s ~ 8.640A/s (PSW 800-4.32)		
MIN	Minimum falling current slew rate	

	MAX	Maximum falling current slew rate
Example	<p>SOUR:CURR:SLEW:FALL 1</p> <p>Sets the falling current slew rate to 1A/s.</p>	
	[SOURce:]RESistance[:LEVel][:IMMEDIATE] [:AMPLitude]	
Description	Sets or queries the internal resistance in ohms.	
Syntax	[SOURce:]RESistance[:LEVel][:IMMEDIATE][:AMPLitude] {<NRF> MIN DEF MAX ?}	
Query Syntax	[SOURce:]RESistance[:LEVel][:IMMEDIATE][:AMPLitude]? [MIN MAX]	
Parameter/Return	<NRF>	Resistance in ohms: 0.000Ω ~ 0.833Ω (PSW 30-36) 0.000Ω ~ 0.417Ω (PSW 30-72) 0.000Ω ~ 0.278Ω (PSW 30-108) 0.000Ω ~ 1.481Ω (PSW 40-27) 0.000Ω ~ 0.741Ω (PSW 40-54) 0.000Ω ~ 0.494Ω (PSW 40-81) 0.000Ω ~ 5.926Ω (PSW 80-13.5) 0.000Ω ~ 2.963Ω (PSW 80-27) 0.000Ω ~ 1.975Ω (PSW 80-40.5) 0.000Ω ~ 22.222Ω (PSW 160-7.2) 0.000Ω ~ 11.111Ω (PSW 160-14.4) 0.000Ω ~ 7.407Ω (PSW 160-21.6) 0.00Ω ~ 55.55Ω (PSW 250-4.5) 0.00Ω ~ 27.77Ω (PSW 250-9) 0.00Ω ~ 18.51Ω (PSW 250-13.5) 0.0Ω ~ 555.5Ω (PSW 800-1.44) 0.0Ω ~ 277.8Ω (PSW 800-2.88) 0.0Ω ~ 185.1Ω (PSW 800-4.32)
	MIN	Minimum internal resistance in ohms
	MAX	Maximum internal resistance in ohms
Example	<p>SOUR:RES:LEV:IMM:AMPL 0.1</p> <p>Sets the internal resistance to 100mΩ.</p>	

[SOURce:]VOLTage[:LEVel][:IMMEDIATE]
[:AMPLitude] (Set) →
→ (Query)

Description	Sets or queries the voltage level in volts.	
Syntax	[SOURce:]VOLTage[:LEVel][:IMMEDIATE][:AMPLitude] {<NRf> MIN MAX}	
Query Syntax	[SOURce:]VOLTage[:LEVel][:IMMEDIATE][:AMPLitude]? [MIN MAX]	
Parameter/Return	<NRf>	0~105% of the rated output voltage in volts.
	MIN	Minimum voltage level
	MAX	Maximum voltage level

Example SOUR:VOLT:LEV:IMM:AMPL 10
 Sets the voltage level to 10 volts.

[SOURce:]VOLTage[:LEVel]:TRIGgered
[:AMPLitude] (Set) →
→ (Query)

Description	Sets or queries the voltage level in volts when a software trigger has been generated.	
Syntax	[SOURce:]VOLTage[:LEVel]:TRIGgered[:AMPLitude] {<NRf> MIN MAX}	
Query Syntax	[SOURce:]VOLTage[:LEVel]:TRIGgered[:AMPLitude]? [MIN MAX]	
Parameter/Return	<NRf>	0%~105% of the rated voltage output in volts.
	MIN	Minimum current level.
	MAX	Maximum current level.

Example SOUR:VOLT:LEV:TRIG:AMPL 10
 Sets the voltage level to 10 volts when a software trigger is generated.

[SOURce:]VOLTage:PROTection[:LEVel]





Description	Sets or queries the overvoltage protection level.	
Syntax	[SOURce:]VOLTage:PROTection[:LEVel] {<NRf> MIN MAX}	
Query Syntax	[SOURce:]VOLTage:PROTection[:LEVel]? [MIN MAX]	
Parameter/Return	<NRf>	OVP range in volts.
	MIN	Minimum OVP level
	MAX	Maximum OVP level
Example	SOUR:VOLT:PROT:LEV MAX Sets the OVP level to its maximum.	

[SOURce:]VOLTage:SLEW:RISing

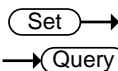

Description	Sets or queries the rising voltage slew rate. This is only applicable for CV slew rate priority mode.	
Syntax	[SOURce:]VOLTage:SLEW:RISing {<NRf> MIN MAX}	
Query Syntax	[SOURce:]VOLTage:SLEW:RISing? [MIN MAX]	
Parameter/Return	<NRf>	0.01V/s ~ 60.00V/s (PSW 30-XX) 0.01V/s ~ 80.00V/s (PSW 40-XX) 0.1V/s ~ 160.0V/s (PSW 80-XX) 0.1V/s ~ 320.0V/s (PSW 160-XX) 0.1V/s ~ 500.0V/s (PSW 250-XX) 1V/s ~ 1600V/s (PSW 800-XX)
	MIN	Minimum rising voltage slew rate.
	MAX	Maximum rising voltage slew rate.
Example	SOUR:VOLT:SLEW:RIS MAX Sets the rising voltage slew rate to its maximum.	



[SOURce:]VOLTage:SLEW:FALLing

Description	Sets or queries the falling voltage slew rate. This is only applicable for CV slew rate priority mode.	
Syntax	[SOURce:]VOLTage:SLEW:FALLing {<NRf> MIN MAX}	
Query Syntax	[SOURce:]VOLTage:SLEW:FALLing? [MIN MAX]	
Parameter/Return	<NRf>	0.01V/s ~ 60.00V/s (PSW 30-XX) 0.01V/s ~ 80.00V/s (PSW 40-XX) 0.1V/s ~ 160.0V/s (PSW 80-XX) 0.1V/s ~ 320.0V/s (PSW 160-XX) 0.1V/s ~ 500.0V/s (PSW 250-XX) 1V/s ~ 1600V/s (PSW 800-XX)
	MIN	Minimum voltage falling slew rate.
	MAX	Maximum voltage falling slew rate.

Example SOUR:VOLT:SLEW:FALL MIN
Sets the falling voltage slew rate to its minimum.

Trigger Commands

The trigger commands generate and configure software triggers.

TRIGger:TRANSient[:IMMEDIATE]	79
TRIGger:TRANSient:SOURce.....	79
TRIGger:OUTPut[:IMMEDIATE]	80
TRIGger:OUTPut:SOURce.....	80
Trigger Command Examples.....	80

TRIGger:TRANSient[:IMMEDIATE]



Description	Generates a software trigger for the transient trigger system. On a trigger, sets the voltage & current. Refer to the :CURR:TRIG and VOLT:TRIG commands on page 72 and 76, respectively.
Syntax	TRIGger:TRANSient[:IMMEDIATE]
Related Commands	[SOURce:]CURRent[:LEVel]:TRIGgered[:AMPLitude] [SOURce:]VOLTage[:LEVel]:TRIGgered[:AMPLitude]



TRIGger:TRANSient:SOURce



Description	Sets or queries the trigger source for the transient system.	
Syntax	TRIGger:TRANSient:SOURce {BUS IMMEDIATE}	
Query Syntax	TRIGger:TRANSient:SOURce?	
Parameter/Return	BUS	Internal software trigger. Waits for the *TRG (or IEEE 488.1 “get” group execute trigger) command to start the trigger.
	IMMEDIATE	Starts the trigger immediately. (default)
Example	TRIG:TRAN:SOUR BUS Sets the trigger source as BUS.	

TRIGger:OUTPut[:IMMediate] (Set) →

Description Generates a software trigger for the output trigger system. On a trigger, sets the output state. Refer to the :OUTP:TRIG command on page 65.

Syntax TRIGger:OUTPut[:IMMediate]

Related commands OUTPut[:STATe]:TRIGgered

TRIGger:OUTPut:SOURce (Set) →
→ (Query)

Description Sets or queries the trigger source for the output system.

Syntax TRIGger:OUTPut:SOURce [BUS | IMMEDIATE]

Query Syntax TRIGger:OUTPut:SOURce?

Parameter/Return	BUS	Internal software trigger. Waits for the *TRG (or IEEE 488.1 “get” group execute trigger) command to start the trigger.
	IMMEDIATE	Starts the trigger immediately. (default)

Example TRIG:OUTP:SOUR BUS
Sets the trigger source of the output system as BUS.

Trigger Command Examples

1. The transient system for the trigger in immediate mode.

Example 1 TRIG:TRAN:SOUR IMM
CURR:TRIG MAX
VOLT:TRIG 5

INIT:NAME TRAN

<==The current changes to the maximum, and the voltage changes to 5V.

2. The transient system for the trigger in BUS mode.

Example 2

TRIG:TRAN:SOUR BUS

CURR:TRIG MAX

VOLT:TRIG 5

INIT:NAME TRAN

TRIG:TRAN (or *TRG)

<==The current changes to the maximum, and the voltage changes to 5V.

3. The output system for the trigger in immediate mode.

Example 3

TRIG:OUTP:SOUR IMM

OUTP:TRIG 1

INIT:NAME OUTP

<==The output changes to ON.

4. The output system for the trigger in BUS mode.

Example 4

TRIG:OUTP:SOUR BUS

OUTP:TRIG 1

INIT:NAME OUTP

TRIG:OUTP (or *TRG)

<==The output changes to ON.

System Function Command

SYSTem:BEEPer[:IMMediate]	83
SYSTem:CONFigure:BEEPer[:STATe]	83
SYSTem:CONFigure:BLEEder[:STATe]	84
SYSTem:CONFigure:BTRip[:IMMediate]	84
SYSTem:CONFigure:BTRip:PROTEction	85
SYSTem:CONFigure:CURRent:CONTRol	85
SYSTem:CONFigure:VOLTAge:CONTRol	86
SYSTem:CONFigure:MSLave	86
SYSTem:CONFigure:OUTPut:EXTernal[:MODE]	87
SYSTem:CONFigure:OUTPut:PON[:STATe]	87
SYSTem:COMMunicate:ENABle	88
SYSTem:COMMunicate:GPIB[:SELF]:ADDRes	89
SYSTem:COMMunicate:LAN:IPADdress	89
SYSTem:COMMunicate:LAN:GATEway	90
SYSTem:COMMunicate:LAN:SMASk	90
SYSTem:COMMunicate:LAN:MAC	90
SYSTem:COMMunicate:LAN:DHCP	91
SYSTem:COMMunicate:LAN:DNS	91
SYSTem:COMMunicate:LAN:HOSTname	91
SYSTem:COMMunicate:LAN:WEB:PACTive	92
SYSTem:COMMunicate:LAN:WEB:PASSword	92
SYSTem:COMMunicate:RLSTATe	93
SYSTem:COMMunicate:USB:FRONt:STATe	93
SYSTem:COMMunicate:USB:REAR:STATe	94
SYSTem:COMMunicate:USB:REAR:MODE	94
SYSTem:ERRor	94
SYSTem:KEYLock:MODE	95
SYSTem:KLOCK	95
SYSTem:INFormation	95
SYSTem:PRESet	96
SYSTem:VERSion	96

Set →

→ Query

SYSTem:BEEPer[:IMMediate]

Description This command causes an audible tone to be generated by the instrument. The duration time is specified in seconds.

Syntax SYSTem:BEEPer[:IMMediate]
{<NR1>|MINimum|MAXimum}

Query Syntax SYSTem:BEEPer[:IMMediate]? [MINimum|MAXimum]

Parameter	<NR1>	0 ~ 3600 seconds.
	MINimum	Sets the beeper time to the minimum (0 seconds)
	MAXimum	Sets the beeper time to the maximum (3600 seconds)

Return parameter <NR1> Returns the remaining beeper duration time in seconds or returns the maximum or minimum beeper time in seconds (for the [MINimum | MAXimum] query parameters).

Example 1

```
SYST:BEEP 10
**after a 2 second wait**
SYST:BEEP?
>8
```

The first command turns the beeper on for 10 seconds. After 2 seconds the SYST:BEEP? query returns the remaining beeper time (8 seconds).

Example 2

```
SYST:BEEP? MAX
>3600
```

Returns the maximum settable beeper time in seconds.

Set →

→ Query

SYSTem:CONFigure:BEEPer[:STATe]

Description Sets or queries the buzzer state on/off.

Syntax	SYSTem:CONFigure:BEEPer[:STATe] {OFF ON 0 1}	
Query Syntax	SYSTem:CONFigure:BEEPer[:STATe]?	
Parameter	0	<NR1> Turns the buzzer off.
	OFF	Turns the buzzer off.
	1	<NR1> Turns the buzzer on.
	ON	Turns the buzzer on.
Return parameter	<Boolean>	Returns the buzzer status.

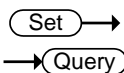

SYSTem:CONFigure:BLEeder[:STATe]

Description	Sets or queries the status of the bleeder resistor.	
Syntax	SYSTem:CONFigure:BLEeder[:STATe]	
Query Syntax	{OFF ON AUTO 0 1 2} SYSTem:CONFigure:BLEeder[:STATe]?	
Parameter	0	<NR1> Turns the bleeder resistor off.
	OFF	Turns the bleeder resistor off.
	1	<NR1> Turns the bleeder resistor on.
	ON	Turns the bleeder resistor on.
	2	<NR1> Turns the AUTO mode on.
	AUTO	Turns the AUTO mode on.
Return parameter	<NR1>	Returns bleeder resistor status.

SYSTem:CONFigure:BTRip[:IMMEDIATE]

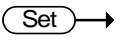

Description	Trips the power switch trip (circuit breaker) to turn the unit off (shut down the power).	
Syntax	SYSTem:CONFigure:BTRip[:IMMEDIATE]	

SYSTEM:CONFigure:BTrip:PROTection



Description	Enables/Disables the power switch trip (circuit breaker) when the OVP or OCP protection settings are tripped. This setting only applies after power has been reset.	
Syntax	SYSTEM:CONFigure:BTrip:PROTection {OFF ON 0 1}	
Query Syntax	SYSTEM:CONFigure:BTrip:PROTection?	
Parameter	0	<NR1> Disables the power switch trip for OVP or OCP.
	OFF	Disables the power switch trip for OVP or OCP.
	1	<NR1> Enables the power switch trip for OVP or OCP.
	ON	Enables the power switch trip for OVP or OCP.
Return parameter	<Boolean>	Returns power switch trip setting.

SYSTEM:CONFigure:CURRENT:CONTROL



Description	Sets or queries the CC control mode (local control (panel), external voltage control, external resistance control). This setting is applied only after the unit is reset.	
Syntax	SYSTEM:CONFigure:CURRENT:CONTROL { 0 1 2 3 }	
Query Syntax	SYSTEM:CONFigure:CURRENT:CONTROL?	
Parameter/Return	<NR1>	Description
	0	Local (Panel) control
	1	External voltage control
	2	External resistance control; 10kΩ = Io max, 0kΩ = Io min.

3 External resistance control; 10kΩ = I_o min, 0kΩ = I_o max.

Set →

→ Query

SYSTem:CONFigure:VOLTage:CONTROL

Description Sets or queries the CV control mode (local control, external voltage control, external resistance control). This setting is applied only after the unit is reset.

Syntax SYSTem:CONFigure:VOLTage:CONTROL { 0 | 1 | 2 | 3 }

Query Syntax SYSTem:CONFigure:VOLTage:CONTROL?

Parameter/Return	<NR1>	Description
	0	Local (Panel) control
	1	External voltage control
	2	External resistance control; 10kΩ = V _o max, 0kΩ = V _o min.
	3	External resistance control; 10kΩ = V _o min, 0kΩ = V _o max.

Set →

→ Query

SYSTem:CONFigure:MSLave

Description Sets or queries the unit operation mode. This setting is only applied after the unit has been reset.

Syntax SYSTem:CONFigure:MSLave { 0 | 1 | 2 | 3 | 4 }

Query Syntax SYSTem:CONFigure:MSLave?



Note

Series mode is only supported for 30V, 40V, 80V and 160V models.

Parameter/Return	<NR1>	Description
	0	Master/Local
	1	Master/Parallel 1 (2 units)
	2	Master/Parallel 2 (3 units)
	3	Slave/Parallel
	4	Slave/Series

Set →

SYSTEM:CONFigure:OUTPut:EXTernal[:MODE] → Query

Description Sets the external logic as active high or active low. This setting is only applied after the unit has been reset.

Syntax SYSTEM:CONFigure:OUTPut:EXTernal[:MODE]

Query Syntax SYSTEM:CONFigure:OUTPut:EXTernal[:MODE]?

Parameter		
	0	Active high
	HIGH	Active high
	1	Active low
	LOW	Active low

Return Parameter		
	0	<boolean>Active high
	1	<boolean>Active low

Set →

SYSTEM:CONFigure:OUTPut:PON[:STATE] → Query

Description Sets the unit to turn the output ON/OFF at power-up. This setting is only applied after the unit has been reset.

Syntax SYSTEM:CONFigure:OUTPut:PON[:STATE]
{OFF|ON|0|1}

Query Syntax SYSTEM:CONFigure:OUTPut:PON[:STATE]?

Parameter	0	Output off at power up
	OFF	Output off at power up
	1	Output on at power up
	ON	Output on at power up
Return Parameter	0	Output off at power up
	1	Output on at power up

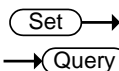

SYSTem:COMMunicate:ENABLE

Description	Enables/Disables LAN, GPIB or USB remote interfaces as well as remote services (Sockets, Web Server). This setting is applied only after the unit is reset.	
Syntax	SYSTem:COMMunicate:ENABLE <mode>,<interface>	
Query Syntax	SYSTem:COMMunicate:ENABLE? <interface>	
Parameter	<mode>	
	OFF	Turns the selected mode off.
	0	Turns the selected mode off.
	ON	Turns the selected mode on.
	1	Turns the selected mode on.
	<interface>	
	GPIB	Select GPIB
	USB	Select USB
	LAN	Select LAN
	SOCKETs	Select Sockets
WEB	Select the web server	
Return Parameter	0	The selected mode is off.
	1	The selected mode is on.

Example	SYST:COMM:ENAB 1,USB Turns the USB interface on.
Query Example	SYST:COMM:ENAB? USB 1 Queries the USB state, returns 1 (USB is on).

SYSTEM:COMMunicate:GPIB[:SELF]:ADDRess
 →
 →

Description	Sets or queries the GPIB address. This setting is applied only after the unit is reset.
Syntax	SYSTEM:COMMunicate:GPIB[:SELF]:ADDRess <NR1>
Query Syntax	SYSTEM:COMMunicate:GPIB[:SELF]:ADDRess?
Parameter/Return	<NR1> 0~30
Example	SYST:COMM:GPIB:SELF:ADDR 15 Sets the GPIB address to 15.

SYSTEM:COMMunicate:LAN:IPADdress
 →
 →

Description	Sets or queries LAN IP address. This setting is applied only after the unit is reset.
Syntax	SYSTEM:COMMunicate:LAN:IPADdress <string>
Query Syntax	SYSTEM:COMMunicate:LAN:IPADdress?
Parameter/Return	<string> LAN IP address in string format ("address") Applicable ASCII characters: 20H to 7EH
Example	SYST:COMM:LAN:IPAD "172.16.5.111" Sets the IP address to 172.16.5.111.

SYSTEM:COMMunicate:LAN:GATEway



Description	Sets or queries the Gateway address. This setting is applied only after the unit is reset.
Syntax	SYSTEM:COMMunicate:LAN:GATEway <string>
Query Syntax	SYSTEM:COMMunicate:LAN:GATEway?
Parameter/Return	<string> Gateway address in string format ("address") Applicable ASCII characters: 20H to 7EH
Example	SYST:COMM:LAN:GATE "172.16.0.254" Sets the LAN gateway to 172.16.0.254.

SYSTEM:COMMunicate:LAN:SMASK



Description	Sets or queries the LAN subnet mask. This setting is applied only after the unit is reset.
Syntax	SYSTEM:COMMunicate:LAN:SMASK <string>
Query Syntax	SYSTEM:COMMunicate:LAN:SMASK?
Parameter/Return	<string> Subnet mask in string format ("mask") Applicable ASCII characters: 20H to 7EH
Example	SYST:COMM:LAN:SMASK "255.255.0.0" Sets the LAN mask to 255.255.0.0.

SYSTEM:COMMunicate:LAN:MAC

Description	Returns the unit MAC address as a string. The MAC address cannot be changed.
Query Syntax	SYSTEM:COMMunicate:LAN:MAC?
Return parameter	<string> Returns the MAC address in the following format "FF-FF-FF-FF-FF-FF"

Example SYST:COMM:LAN:MAC?
 02-80-AD-20-31-B1
 Returns the MAC address.

Set →

SYSTEM:COMMunicate:LAN:DHCP

→ Query

Description Turns DHCP on/off. Queries the DHCP status.
 This setting is applied only after the unit is reset.

Syntax SYSTem:COMMunicate:LAN:DHCP {OFF| ON | 0 | 1}

Query Syntax SYSTem:COMMunicate:LAN:DHCP?

Parameter	0	DHCP off
	OFF	DHCP off
	1	DHCP on
	ON	DHCP on

Return parameter	0	<boolean>DHCP off
	1	<boolean>DHCP on

Set →

SYSTEM:COMMunicate:LAN:DNS

→ Query

Description Sets or queries the DNS address. This setting is
 applied only after the unit is reset.

Syntax SYSTem:COMMunicate:LAN:DNS <string>

Query Syntax SYSTem:COMMunicate:LAN:DNS?

Parameter/Return	<string>	DNS in string format ("mask") Applicable ASCII characters: 20H to 7EH
------------------	----------	--

Example SYST:COMM:LAN:DNS "172.16.1.252"
 Sets the DNS to 172.16.1.252.

SYSTEM:COMMunicate:LAN:HOSTname

→ Query

Description Queries the host name.

Query Syntax	SYSTem:COMMunicate:LAN:HOSTname?
Return Parameter	<string> Host name in string format
Query Example	SYST:COMM:LAN:HOST? P-160054 Returns the host name (P-160054).

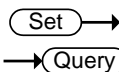

SYSTem:COMMunicate:LAN:WEB:PACTive

Description	Sets or queries whether the web password is on or off. This setting is applied only after the unit is reset.
Syntax	SYSTem:COMMunicate:LAN:WEB:PACTive {OFF ON 0 1}
Query Syntax	SYSTem:COMMunicate:LAN:WEB:PACTive?
Parameter	0 Web password off OFF Web password off 1 Web password on ON Web password on
Return parameter	0 <boolean> Web password off 1 <boolean> Web password on

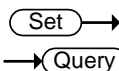

SYSTem:COMMunicate:LAN:WEB:PASSword

Description	Sets or queries the web password. This setting is applied only after the unit is reset.
Syntax	SYSTem:COMMunicate:LAN:WEB:PASSword <NR1>
Query Syntax	SYSTem:COMMunicate:LAN:WEB:PASSword?
Parameter/Return	<NR1> 0 ~ 9999
Example	SYST:COMM:LAN:WEB:PASS 1234 Set the web password as 1234.

Set →

→ Query

SYSTem:COMMunicate:RLSTate

Description	Sets or queries the control state of the instrument.	
Note	Only applicable for software version 1.60 or above.	
Syntax	SYSTem:COMMunicate:RLSTate {LOCAL REMote RWLock}	
Query Syntax	SYSTem:COMMunicate:RLSTate ?	
Parameter	LOCAL	Sets the instrument to front panel control.
	REMote	Sets the instrument to remote interface control.
	RWLock	Disables the front panel keys and only allows the instrument to be controlled via the remote interface.
Return parameter	LOC	The instrument is set to front panel control.
	REM	The instrument is set to remote interface control.
	RWL	The front panel keys are disabled. The instrument can only be controlled via the remote interface.
Example	SYST:COMM:RLST: LOC Sets the instrument to front panel control.	

SYSTem:COMMunicate:USB:FRONT:STATe

→ Query

Description	Queries the front panel USB-A port state.	
Query Syntax	SYSTem:COMMunicate:USB:FRONT:STATe?	
Return parameter	0	<NR1>Absent
	1	<NR1>Mass Storage

SYSTem:COMMunicate:USB:REAR:STATe → Query

Description	Queries the rear panel USB-B port state.	
Query Syntax	SYSTem:COMMunicate:USB:REAR:STATe?	
Return parameter	0	<NR1>Absent
	1	<NR1>USB-CDC
	2	<NR1>GPIB-USB (GUG-001)

Set →

SYSTem:COMMunicate:USB:REAR:MODE → Query

Description	Sets or queries the rear panel USB-B port mode. This command is the equivalent to the F-22 configuration setting.	
Syntax	SYSTem:COMMunicate:USB:REAR:MODE {0 1 2 3}	
Query Syntax	SYSTem:COMMunicate:USB:REAR:MODE?	
Parameter/ Return parameter	0	Disable
	1	USB Host
	2	Auto detect speed
	3	Full speed only

Example SYST:COMM:USB:REAR:MODE 1
 Sets the rear panel USB-B port mode to USB Host.

SYSTem:ERRor → Query

Description	Queries the error queue. The last error message is returned. A maximum of 32 errors are stored in the error queue.	
Query Syntax	SYSTem:ERRor?	
Paramter/Return	<NR1>,<string>	Returns an error code followed by an error message as a string. The string is returned as "string".

Example SYSTem:ERRor?
 -100, "Command error"

Set →

SYSTem:KEYLock:MODE

→ Query

Description Sets or queries the key lock mode. This setting is the equivalent of the F-19 function setting.

Syntax SYSTem:KEYLock:MODE {0|1}

Query Syntax SYSTem:KEYLock:MODE?

Parameter /	0	Panel lock: allow output off.
Return parameter	1	Panel lock: allow output on/off.

Set →

SYSTem:KLOCK

→ Query

Description Enables or disables the front panel key lock.

Syntax SYSTem:KLOCK { OFF | ON | 0 | 1 }

Query Syntax SYSTem:KLOCK?

Parameter	0	Panel keys unlocked
	OFF	Panel keys unlocked
	1	Panel keys locked
	ON	Panel keys locked
Return parameter	0	<boolean>Panel keys unlocked
	1	<Boolean>Panel keys locked

SYSTem:INFormation

→ Query

Description Queries the system information. Returns the machine version, build date, keyboard CPLD version and analog CPLD version.

Query Syntax SYSTem:INFormation?

Return Parameter <block data> Definite length arbitrary block response data.

Query Example SYST:INF?
 #3212MFRS GW-INSTEK,Model PSW80-13.5,SN
 TW0123456789,Firmware-Version 01.43.20130424,
 Keyboard-CPLD 0x30c,AnalogControl-CPLD
 0x421,Kernel-BuiltON 2013-3-22,TEST-Version
 01.00,TEST-BuiltON 2011-8-1,MAC 02-80-ad-20-31-b1

Returns the system information as a block data.

SYSTem:PRESet (Set) →

Description Resets all the settings to the factory default settings. See page 120 for details.

Syntax SYSTem:PRESet

SYSTem:VERsion → (Query)

Description Returns the version of the SCPI specifications that the unit complies with.

Query Syntax SYSTem:VERsion?

Return <1999.0> Always returns the SCPI version: 1999.0.

IEEE 488.2 Common Commands

*CLS	97
*ESE	97
*ESR	98
*IDN	98
*OPC	98
*RST	99
*SRE	99
*STB	99
*TRG	100
*TST	100
*WAI	100

*CLS



Description The *CLS command clears the Standard Event Status, Operation Status and Questionable Status registers. The corresponding Enable registers in each of the above registers are not cleared.

If a <NL> newline code immediately precedes a *CLS command, the Error Que and the MAV bit in the Status Byte Register is also cleared.

Syntax *CLS

*ESE

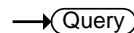
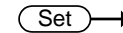

Description Sets or queries the Standard Event Status Enable register.

Syntax *ESE <NR1>

Query Syntax *ESE?

Parameter <NR1> 0~255

Return parameter <NR1> Returns the bit sum of the Standard Event Status Enable register.

***ESR** → Query

Description Queries the Standard Event Status (Event) register. The Event Status register is cleared after it is read.

Query Syntax *ESR?

Return parameter <NR1> Returns the bit sum of the Standard Event Status (Event) register and clears the register.

***IDN** → Query

Description Queries the manufacturer, model name, serial number, and firmware version of the PSW.

Query Syntax *IDN?

Return parameter <string> Returns the instrument identification as a string in the following format:
 GW-INSTEK,PSW-3036,TW123456,01.00.20110101
 Manufacturer: GW-INSTEK
 Model number : PSW-3036
 Serial number : TW123456
 Firmware version : 01.00.20110101

***OPC** Set →
→ Query

Description The *OPC command sets the OPC bit (bit0) of the Standard Event Status Register when all current commands have been processed.
 The *OPC? Query returns 1 when all the outstanding commands have completed.

Syntax	*OPC
Query Syntax	*OPC?
Return parameter	1 Returns 1 when all the outstanding commands have completed.

***RST** (Set) →

Description Performs a device reset. Configures the unit to a known configuration (default settings). This known configuration is independent of the usage history.

Syntax	*RST
--------	------

***SRE** (Set) →
→ (Query)

Description Sets or queries the Service Request Enable register. The Service Request Enable register determines which registers of the Status Byte register are able to generate service requests.

Syntax	*SRE <NR1>
--------	------------

Query Syntax	*SRE?
--------------	-------

Parameter	<NR1> 0~255
-----------	-------------

Return parameter	<NR1> Returns the bit sum of the Service Request Enable register.
------------------	---

***STB** → (Query)

Description Queries the bit sum of the Status Byte register with MSS (Master summary Status).

Query Syntax	*STB?
--------------	-------

Return parameter	<NR1> Returns the bit sum of the Status Byte register with the MSS bit (bit 6).
------------------	---

***TRG** (Set) →

Description The *TRG command is able to generate a “get” (Group Execute Trigger). If the PSW cannot accept a trigger at the time of the command, an error message is generated (-211, “Trigger ignored”).

Syntax *TRG

***TST** → (Query)

Description Executes a self test.

Query Syntax *TST?

Return parameter	0	Returns “0” if there are no errors.
	<NR1>	Returns an error code <NR1> if there is an error.

***WAI** (Set) →

Description Prevents any other commands or queries from being executed until all outstanding commands have completed.

Syntax *WAI

Status Register Overview

To program the PSW power supply effectively, the Status registers need to be understood. This chapter explains in detail how the Status registers are used and how to configure them.

Introduction to the Status Registers

Overview

The status registers are used to determine the status of the power supply. The status registers maintain the status of the protection conditions, operation conditions and instrument errors.

The PSW Series have a number of register groups:

- Questionable Status Register Group
- Standard Event Status Register Group
- Operation Status Register Group
- Status Byte Register
- Service Request Enable Register
- Service Request Generation
- Error Queue
- Output Buffer

The next page shows the structure of the Status registers.

The Status Registers

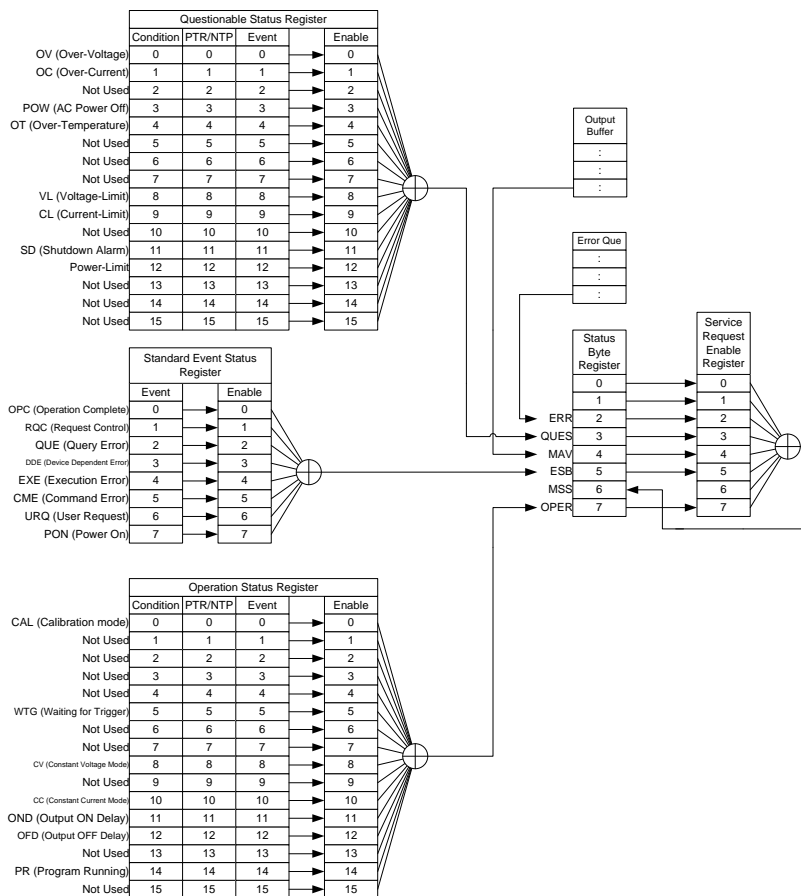

Questionable Status Register Group

Overview

The Questionable Status Register Group indicates if any protection modes or limits have been tripped.

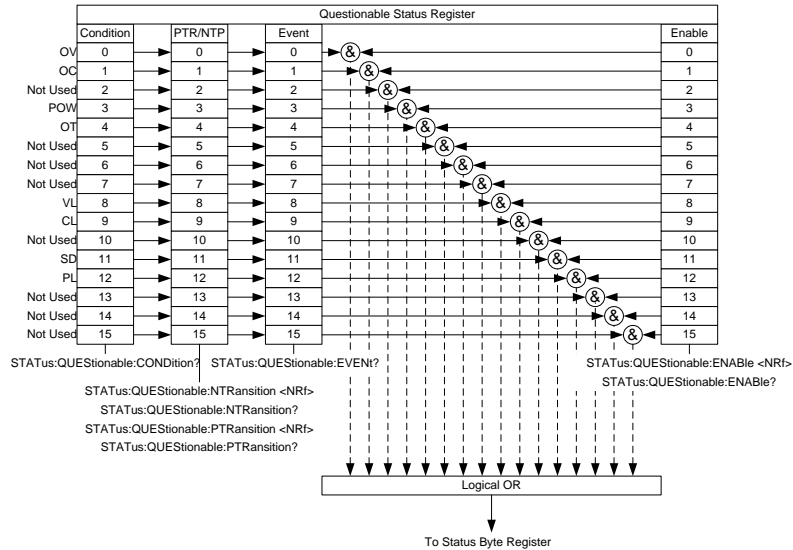

Bit Summary	Event	Bit #	Bit Weight
OV (Over-Voltage)	Over voltage protection has been tripped	0	1
OC (Over-Current)	Over current protection has been tripped	1	2
POW (AC Power Off)	AC power switch is off	3	8

OT (Over Temperature)	4	16
Over temperature protection has been tripped		
VL (Voltage Limit)	8	256
Voltage limit has been reached		
CL (Current Limit)	9	512
Current limit has been reached		
SD (Shutdown Alarm)	11	2048
PL (Power-Limit)	12	4096

Condition Register The Questionable Status Condition Register indicates the status of the power supply. If a bit is set in the Condition register, it indicates that the event is true. Reading the condition register does not change the state of the condition register.

PTR/NTR Filters The PTR/NTR (Positive/Negative transition) register determines the type of transition conditions that will set the corresponding bit in the Event Registers. Use the Positive transition filter to view events that change from false to positive, and use the negative transition filter to view events that change from positive to negative.

Positive Transition	0→1
Negative Transition	1→0

Event Register The PTR/NTR Register will dictate the type of transition conditions will set the corresponding bits in the Event Register. If the Event Register is read, it will be cleared to 0.

Enable Register The Enable register determines which Events in the Event Register will be used to set the QUES bit in the Status Byte Register.

Operation Status Register Group

Overview

The Operation Status Register Group indicates the operating status of the power supply.

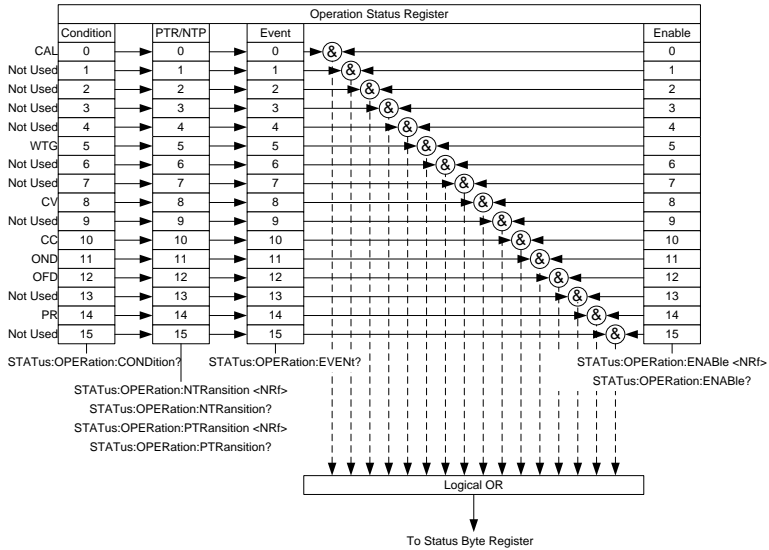

Bit Summary	Event	Bit #	Bit Weight
	CAL (Calibration mode)	0	1
	Indicates if the PSW is in calibration mode.		
	WTG (Waiting for trigger)	5	32
	Indicates if the PSW is waiting for a trigger.		
	CV (Constant voltage mode)	8	256
	Indicates if the PSW is in CV mode.		

CC (Constant current mode)	10	1024
Indicates if the PSW is in CC mode.		
OND (Output ON Delay)	11	2048
Indicates if Output ON delay time is active		
OFD (Output OFF Delay)	12	4096
Indicates if Output OFF delay time is active		
PR (Program Running)	13	8192
Indicates if a Test is running		

Condition Register The Operation Status Condition Register indicates the operating status of the power supply. If a bit is set in the Condition register, it indicates that the event is true. Reading the condition register does not change the state of the condition register.

PTR/NTR Filters The PTR/NTR (Positive/Negative transition) register determines the type of transition conditions that will set the corresponding bit in the Event Registers. Use the Positive transition filter to view events that change from false to positive, and use the negative transition filter to view events that change from positive to negative.

Positive Transition	0→1
Negative Transition	1→0

Event Register The PTR/NTR Register will dictate the type of transition conditions will set the corresponding bits in the Event Register. If the Event Register is read, it will be cleared to 0.

Enable Register The Enable register determines which registered Events in the Event Register will be used to set the OPER bit in the Status Byte Register.

Standard Event Status Register Group

Overview The Standard Event Status Register Group indicates if any errors have occurred. The bits of the Event register are set by the error event queue.

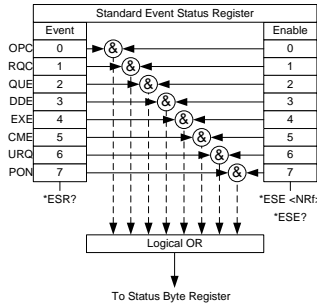

Bit Summary	Event	Bit #	Bit Weight
	OPC (Operation complete)	0	1
	The OCP bit is set when all selected pending operations are complete. This bit is set in response to the *OPC command.		
	RQC (Request control)	1	2
	QUE (Query Error)	2	4
	The Query Error bit is set in response to an error reading the Output Queue. This can be caused by trying to read the Output Queue when there is no data present.		

DDE (Device Dependent Error)	3	8
------------------------------	---	---

Device specific error.

EXE (Execution Error)	4	16
-----------------------	---	----

The EXE bit indicates an execution error due to one of the following: illegal command parameter, parameter out of range, invalid parameter, the command didn't execute due to an overriding operation condition.

CME (Command Error)	5	32
---------------------	---	----

The CME bit is set when a syntax error has occurred. The CME bit can also be set when a <GET> command is received within a program message.

URQ (User Request)	6	64
--------------------	---	----

PON (Power On)	7	128
----------------	---	-----

Indicates the power is turned on.

Event Register	Any bits set in the event register indicate that an error has occurred. Reading the Event register will reset the register to 0.
----------------	--

Enable Register	The Enable register determines which Events in the Event Register will be used to set the ESB bit in the Status Byte Register.
-----------------	--

Status Byte Register & Service Request Enable Register

Overview

The Status Byte register consolidates the status events of all the status registers. The Status Byte register can be read with the *STB? query and can be cleared with the *CLS command.

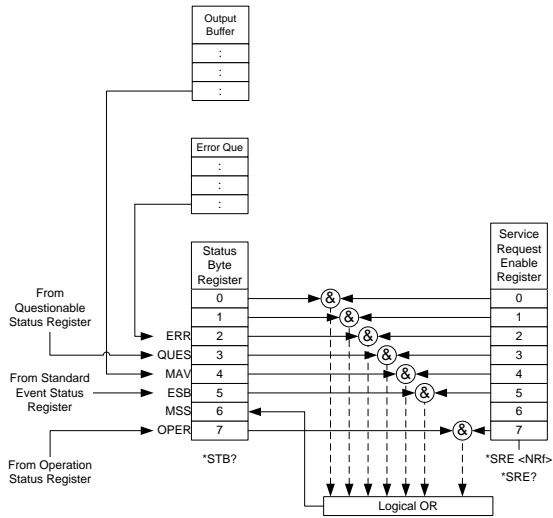

Bit Summary	Event	Bit #	Bit Weight
	ERR (Error Event/Queue)	2	4
	If data is present in the Error queue, the ERR bit will be set.		
	QUES (Questionable Status Register)	3	8
	The summary bit for the Questionable Status Register group.		

MAV (Message Available) This is set when there is data in the Output Queue waiting to be read.	4	16
--	---	----

(ESB) Event Summary Bit. The ESB is the summary bit for the Standard Event Status Register group.	5	32
---	---	----

MSS Bit The MSS Bit is the summary of the Status Byte Register and Service Request register (bits 1-5, 7). This will be set to 1.	6	64
--	---	----

OPER (Operation Status Register) OPER bit is the summary bit for the Operation Status Register Group.	7	128
--	---	-----

Status Byte Register	Any bits set in the Status byte register acts as a summary register for all the three other status registers and indicates if there is a service request, an error in the Error Queue or data in the Output Queue. Reading the Status Byte register will reset the register to 0.
----------------------	---

Service Request Enable Register	The Service Request Enable Register controls which bits in the Status Byte Register are able to generate service requests.
---------------------------------	--

Error List

Command Errors

Overview

An <error/event number> in the range [-199 , -100] indicates that an IEEE 488.2 syntax error has been detected by the instrument's parser. The occurrence of any error in this class shall cause the command error bit (bit 5) in the event status register (IEEE 488.2, section 11.5.1) to be set. One of the following events has occurred:

- An IEEE 488.2 syntax error has been detected by the parser. That is, a controller-to-device message was received which is in violation of the IEEE 488.2 standard. Possible violations include a data element which violates the device listening formats or whose type is unacceptable to the device.
- An unrecognized header was received. Unrecognized headers include incorrect device-specific headers and incorrect or unimplemented IEEE 488.2 common commands.

Events that generate command errors shall not generate execution errors, device-specific errors, or query errors; see the other error definitions in this chapter.

Error Code	Description
-100 Command Error	This is the generic syntax error for devices that cannot detect more specific errors. This code indicates only that a Command Error as defined in IEEE 488.2,11.5.1.1.4 has occurred.
-102 Syntax error	An unrecognized command or data type was encountered; for example, a string was received when the device does not accept strings.
-103 Invalid separator	The parser was expecting a separator and encountered an illegal character; for example, the semicolon was omitted after a program message unit, MEAS:VOLT:DC?:MEASCURR:DC?
-104 Data type error	The parser recognized a data element different than one allowed; for example, numeric or string data was expected but block data was encountered.
-108 Parameter not allowed	More parameters were received than expected for the header; for example, the KLOCK command only accepts one parameter, so receiving SYSTem:KLOCK 1,0 is not allowed.
-109 Missing parameter	Fewer parameters were received than required for the header; for example, the KLOCK command requires one parameter, so receiving KLOCK is not allowed.
-111 Header separator error	A character which is not a legal header separator was encountered while parsing the header; for example, no white space followed the header, thus APPL5,1 is an error.

-112 Program mnemonic too long	The header contains more than twelve characters (see IEEE 488.2, 7.6.1.4.1).
-113 Undefined header	The header is syntactically correct, but it is undefined for this specific device; for example, *XYZ is not defined for any device.
-114 Header suffix out of range	The value of a numeric suffix attached to a program mnemonic, see Syntax and Style section 6.2.5.2, makes the header invalid.
-115 Unexpected number of parameters	The number of parameters received does not correspond to the number of parameters expected. This is typically due to an inconsistency with the number of instruments in the selected group.
-120 Numeric data error	This error, as well as errors -121 through -129, are generated when parsing a data element which appears to be numeric, including the nondecimal numeric types. This particular error message should be used if the device cannot detect a more specific error.
-121 Invalid character in number	An invalid character for the data type being parsed was encountered; for example, an alpha in a decimal numeric or a "9" in octal data.
-128 Numeric data not allowed	A legal numeric data element was received, but the device does not accept one in this position for the header.
-131 Invalid suffix	The suffix does not follow the syntax described in IEEE 488.2, 7.7.3.2, or the suffix is inappropriate for this device.

-141 Invalid character data	Either the character data element contains an invalid character or the particular element received is not valid for the header.
-148 Character data not allowed	A legal character data element was encountered where prohibited by the device.
-151 Invalid string data	A string data element was expected, but was invalid for some reason (see IEEE 488.2, 7.7.5.2); for example, an END message was received before the terminal quote character.
-158 String data not allowed	A string data element was encountered but was not allowed by the device at this point in parsing.
-160 Block data error	This error, as well as errors -161 through -169, is generated when parsing a block data element. This particular error message should be used if the device cannot detect a more specific error.
-161 Invalid block data	A block data element was expected, but was invalid for some reason (see IEEE 488.2, 7.7.6.2); for example, an END message was received before the length was satisfied.
-168 Block data not allowed	A legal block data element was encountered but was not allowed by the device at this point in parsing.
-178 Expression data not allowed	A legal expression data was encountered but was not allowed by the device at this point in parsing.

Execution Errors

Overview An <error/event number> in the range [-299 , -200] indicates that an error has been detected by the instrument's execution control block. The occurrence of any error in this class shall cause the execution error bit (bit 4) in the event status register (IEEE 488.2, section 11.5.1) to be set. One of the following events has occurred:

- A <PROGRAM DATA> element following a header was evaluated by the device as outside of its legal input range or is otherwise inconsistent with the device's capabilities.
- A valid program message could not be properly executed due to some device condition.

Execution errors shall be reported by the device after rounding and expression evaluation operations have taken place. Rounding a numeric data element, for example, shall not be reported as an execution error. Events that generate execution errors shall not generate Command Errors, device-specific errors, or Query Errors; see the other error definitions in this section.

Error Code	Description
-200 Execution error	This is the generic syntax error for devices that cannot detect more specific errors. This code indicates only that an Execution Error as defined in IEEE 488.2, 11.5.1.1.5 has occurred.

-201 Invalid while in local	Indicates that a command is not executable while the device is in local due to a hard local control (see IEEE 488.2, 5.6.1.5); for example, a device with a rotary switch receives a message which would change the switches state, but the device is in local so the message can't be executed.
-203 Command protected	Indicates that a legal password-protected program command or query could not be executed because the command was disabled.
-211 Trigger ignored	Indicates that a GET, *TRG, or triggering signal was received and recognized by the device but was ignored because of device timing considerations; for example, the device was not ready to respond. Note: a DT0 device always ignores GET and treats *TRG as a Command Error.
-213 Init ignored	Indicates that a request for a measurement initiation was ignored as another measurement was already in progress.
-220 Parameter error	Indicates that a program data element related error occurred. This error message should be used when the device cannot detect the more specific errors described for errors -221 through -229.
-221 Settings conflict	Indicates that a legal program data element was parsed but could not be executed due to the current device state (see IEEE 488.2, 6.4.5.3 and 11.5.1.1.5.).

-222 Data out of range	Indicates that a legal program data element was parsed but could not be executed because the interpreted value was outside the legal range as defined by the device (see IEEE 488.2, 11.5.1.1.5.).
-224 Illegal parameter value	Used where exact value, from a list of possible, was expected.

Device Specific Errors

Overview An <error/event number> in the range [-399 , -300] or [1 , 32767] indicates that the instrument has detected an error which is not a command error, a query error, or an execution error; some device operations did not properly complete, possibly due to an abnormal hardware or firmware condition. These codes are also used for self-test response errors. The occurrence of any error in this class should cause the device-specific error bit (bit 3) in the event status register (IEEE 488.2, section 11.5.1) to be set. The meaning of positive error codes is device-dependent and may be enumerated or bit mapped; the <error message>string for positive error codes is not defined by SCPI and available to the device designer.

Note that the string is not optional; if the designer does not wish to implement a string for a particular error, the null string should be sent (for example, 42,""). The occurrence of any error in this class should cause the device-specific error bit (bit 3) in the event status register (IEEE 488.2, section 11.5.1) to be set. Events that generate device-specific errors shall not generate command errors, execution

errors, or query errors; see the other error definitions in this section.

Error Code	Description
-310 System error	Indicates that some error, termed “system error” by the device, has occurred. This code is device-dependent.
-320 Storage fault	Indicates that the firmware detected a fault when using data storage. This error is not an indication of physical damage or failure of any mass storage element.

Query Errors

Overview An <error/event number> in the range [-499 , -400] indicates that the output queue control of the instrument has detected a problem with the message exchange protocol described in IEEE 488.2, chapter 6. The occurrence of any error in this class shall cause the query error bit (bit 2) in the event status register (IEEE 488.2, section 11.5.1) to be set. These errors correspond to message exchange protocol errors described in IEEE 488.2, section 6.5. One of the following is true:

- An attempt is being made to read data from the output queue when no output is either present or pending;
- Data in the output queue has been lost.

Events that generate query errors shall not generate command errors, execution errors, or device-specific errors; see the other error definitions in this section.

Error Code	Description
-400 Query error	This is the generic query error for devices that cannot detect more specific errors. This code indicates only that a Query Error as defined in IEEE 488.2, 11.5.1.1.7 and 6.3 has occurred.

A PPENDIX

PSW Default Settings

The following default settings are the factory configuration settings for the power supply (Function settings/Test settings).

Initial Settings	Default Setting	
Output	Off	
LOCK	0 (Disabled)	
Voltage	0V	
Current	0A	
OVP	Maximum	
OCP	Maximum	
Normal Function Settings	Setting	Default Setting
Output ON delay time	F-01	0.00s
Output OFF delay time	F-02	0.00s
V-I mode slew rate select	F-03	0 = CV high speed priority
Rising voltage slew rate	F-04	60.00V/s (PSW 30-XX) 80.00V/s (PSW 40-XX) 160.0V/s (PSW 80-XX) 320.0V/s (PSW 160-XX) 500.0V/s (PSW 250-XX) 1600V/s (PSW 800-XX)
Falling voltage slew rate	F-05	60.00V/s (PSW 30-XX) 80.00V/s (PSW 40-XX) 160.0V/s (PSW 80-XX) 320.0V/s (PSW 160-XX) 500.0V/s (PSW 250-XX) 1600V/s (PSW 800-XX)

Rising current slew rate	F-06	72.00A/s (PSW 30-36)
		144.0A/s (PSW 30-72)
		216.0A/s (PSW 30-108)
		54.00A/s (PSW 40-27)
		108.0A/s (PSW 40-54)
		162.0A/s (PSW 40-81)
		27.00A/s (PSW 80-13.5)
		54.00A/s (PSW 80-27)
		81.00A/s (PSW 80-40.5)
		14.40A/s (PSW 160-7.2)
		28.80A/s (PSW 160-14.4)
		43.20A/s (PSW 160-21.6)
		9.000A/s (PSW 250-4.5)
		18.00A/s (PSW 250-9)
		27.00A/s (PSW 250-13.5)
		2.880A/s (PSW 800-1.44)
		5.760A/s (PSW 800-2.88)
8.640A/s (PSW 800-4.32)		
Falling current slew rate	F-07	72.00A/s (PSW 30-36)
		144.0A/s (PSW 30-72)
		216.0A/s (PSW 30-108)
		54.00A/s (PSW 40-27)
		108.0A/s (PSW 40-54)
		162.0A/s (PSW 40-81)
		27.00A/s (PSW 80-13.5)
		54.00A/s (PSW 80-27)
		81.00A/s (PSW 80-40.5)
		14.40A/s (PSW 160-7.2)
		28.80A/s (PSW 160-14.4)
		43.20A/s (PSW 160-21.6)
		9.000A/s (PSW 250-4.5)
		18.00A/s (PSW 250-9)
		27.00A/s (PSW 250-13.5)
		2.880A/s (PSW 800-1.44)
		5.760A/s (PSW 800-2.88)
8.640A/s (PSW 800-4.32)		
Internal resistance setting	F-08	0.000Ω
Bleeder circuit control	F-09	1 = ON
Buzzer ON/OFF control	F-10	1 = ON

Measurement Average Setting	F-17	0 = Low
Lock Mode	F-19	0 = Panel lock: allow output off
USB/GPIB setting		
Rear Panel USB Mode	F-22	2 = USB CDC
GPIB address	F-23	8
LAN setting		
LAN	F-36	1 = Enable
DHCP	F-37	1 = Enable
Sockets active	F-57	1 = Enable
Web Server active	F-59	1 = Enable
Web password active	F-60	1 = Enable
Web setting password	F-61	0000
Power On Configuration		
CV Control	F-90	0= Panel control (local)
CC Control	F-91	0= Panel control (local)
Power-ON Output	F-92	0 = OFF at startup
Master/Slave	F-93	0 = Master/Local
External Out Logic	F-94	0= High ON
Power Switch trip	F-95	0 = Enable

Error Messages & Messages

The following error messages or messages may appear on the PSW screen during operation.

Error Messages	Description
Err 001	USB Mass Storage is not present
Err 002	No (such)file in USB mass storage
Err 003	Empty memory location
Err 004	File access error
Err 901	Keyboard CPLD error
Err 902	Analog CPLD error
Err 920	The ADC is over range for calibration
Err 921	The DAC is over range for calibration
Err 922	Point invalid for calibration

Messages	Description
MSG 001	External control of output. Output off (F-94=0, High=on)
MSG 002	External control of output. Output off (F-94=1, Low=on)
MSG 003	F-93 is not zero. Unable to calibrate.
LOCK F-19	F-19 is not zero. Unable to turn the output on.

LED Display Format

Use the following table to read the LED display messages.

0	1	2	3	4	5	6	7	8	9	A	B	C	D
0	1	2	3	4	5	6	7	8	9	A	b	C	d
E	F	G	H	I	J	K	L	M	N	O	P	Q	R
E	F	G	H	I	J	K	L	M	N	O	P	Q	R
S	T	U	V	W	X	Y	Z	()	+	-	,	
S	T	U	V	W	X	Y	Z	()	+	-	,	

INDEX

Accessories	10	symbol.....	4
Caution symbol	4	LED conversion.....	123
Cleaning the instrument.....	5	List of features.....	9
Configuration		Messages	123
normal function settings		Model differences	8
operation	21	Rear panel diagram	17
overview.....	21	Remote control.....	29
power on configuration operation	22	Command list.....	52
table.....	24	Command syntax.....	48
Connector plug manufacturer .	19	Error list	111
DECA SwitchLab.....	19	GPIB configuration.....	30
Display format	123	Status registers	101
Disposal instructions.....	6	USB configuration.....	30
EN61010		Remote control function check	34
pollution degree	6	Realterm.....	35
Environment		Service operation	
safety instruction.....	5	about disassembly	5
Error messages.....	123	Socket server examples	
Ethernet		C++	45
interface.....	32	LabVIEW.....	47
sockets	33	Visual basic.....	44
web server.....	32	Socket server function check	38
Front panel diagram	14	Warning symbol	4
Ground		Web server function check	38