

Programmable High Precision Dual Output DC Power Supply

PPH-1503D

Quick Start Guide

GW INSTEK PART NO. 82PH31503DM01



ISO-9001 CERTIFIED MANUFACTURER

GW INSTEK

Copyright Statement

This manual contains proprietary information, which is protected by copyright. All rights are reserved. No part of this manual may be photocopied, reproduced or translated to another language without prior written consent of Good Will company.

The information in this manual was correct at the time of printing. However, Good Will continues to improve products and reserves the rights to change specification, equipment, and maintenance procedures at any time without notice.

Table of Contents

OVERVIEW	2
Front Panel	3
Rear Panel	6
Load and DVM Connection	7
BASIC OPERATION	9
Source Function	9
DVM	16
Pulse Current Measurement	18
Long integration	22
Current Sink Function	26
External Relay Control	27
Sequence Function	30
Main Specifications	31

VERVIEW

This quick start guide is for those users who are not very familiar with the usage of this instrument. It provides a way of quickly understanding this device. For details about functions such as system settings, saving & recalling features and remote control instructions, please refer to the PPH-1503D user manual.

This quick start guide contains the following content:

Introduction	Introduces the instrument panels and main features.
Operation	Describes the display interface and the functions of the interface keys.
Overview	<p>The PPH-1503D is a high-precision, compact, dual output, multifunction, programmable DC power supply with flexible operating configurations. In addition to the basic power supply functionality, it is also able to measure pulse current, the average current over long periods of time and other functions such as battery simulation.</p> <p>The PPH-1503D is designed for testing the power consumption of battery powered wireless communication devices (e.g. cell phones). Such devices often have large load variations within a short time span. The high precision power supply has excellent voltage stability during pulsed loads and is capable of simultaneously measuring the pulse current, even for very short pulses. In</p>

In addition, the power supply is able to sink current, allowing it to simulate the characteristics of a discharged rechargeable battery for testing chargers and charge control circuits.

Front Panel

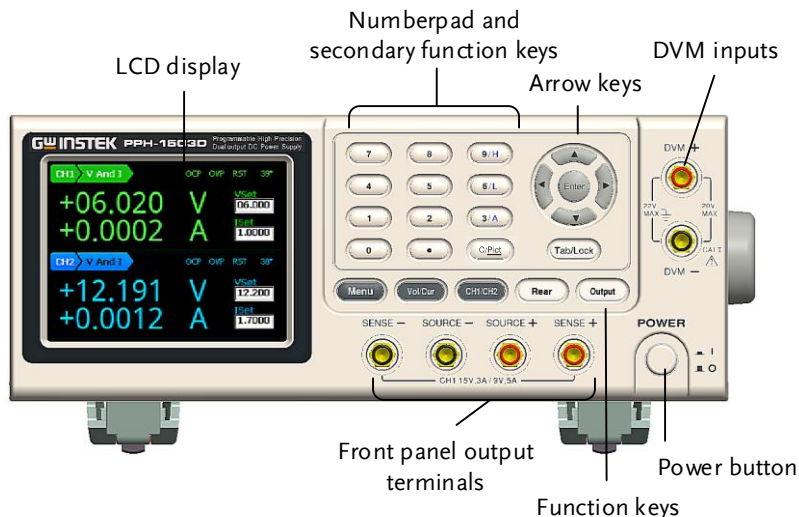

Display Interface LCD Display



Voltmeter Indicators	Displays the output voltage with up to 5 digits of resolution. The default units are Volts (V).
Ammeter Indicator	Displays the output current with up to 5 digits of resolution, depending on the current range (CH1:5A/500mA/5mA; CH2:1.5A/5mA/ AUTO). The current range is selectable between A and mA.
Setting Display	Displays the voltage and current settings.
Parameter Settings Display	Displays the parameter settings. For details on setting parameters, see page 9.

Status Display Display the current status of the instrument.

Function Display Displays the unit functions. There four functions:

Basic power supply function (V AND I);
Pulse current meter function (PULSE);
Long integration current measurement function (LONG INT);
Digital Voltmeter function (DVM).

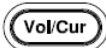
Function Keys

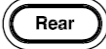
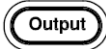
Menu key		Menu key to enter or exit from system settings.
Voltage and Current Setting key		Voltage and Current setting toggle switch. See page 12 for operation details.
CH1/CH2 Toggle Switch		CH1 and CH2 setting toggle switch.
CH1 Front and Rear output toggle key		Front and rear output toggle switch. The key will be lit when the output is set to the rear outputs.
Output key		The Output key turns the output on or off. The Output key will light up when the output is on. It has no affect when DVM is activated.

Tab /LOCK key

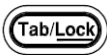

The Tab key is used to toggle between various parameters. The Lock key is used to disable all the panel keys except for the Output key. Pressing the Lock key for at least 2 seconds will turn the panel lock on or off. The Lock key can also be used to exit from remote control mode. When the panel lock is active the Lock key will light up.

Number pad

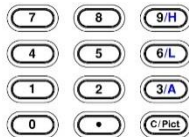

a. The number pad is used to enter various parameters and values. The Clear key can be used to clear set parameters. Pressing the C/Pict key for at least 2 seconds will take a screenshot.

b. H/L/A Pulse current measurement shortcut keys. These short cut keys only work in the Pulse current measurement main menu.

H: High measurement mode
L: Low measurement mode
A: Average measurement mode

Directional keys and Enter key



The directional keys are used for parameter and menu selection as well for fine adjustment of the current/voltage settings.

The Enter key is used to confirm the selection of any settings or parameters and to exit after a setting is complete.

Power Button

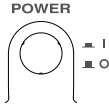

Turns the power on or off.

On:

Off:

Rear Panel

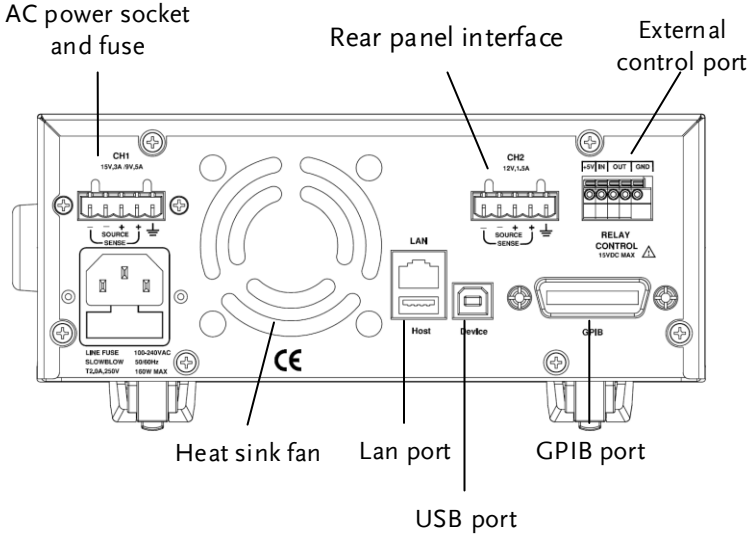

Terminals

AC input socket (contains the line fuse)

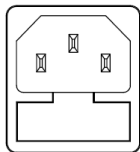

LINE FUSE 100-240VAC
SLOWBLOW 50/60Hz
T2.0A,250V 160W MAX

The AC input accepts 100 to 240 ± 10% VAC. The frequency is 50Hz/60Hz;
Fuse: 2A slow-blow type

USB port



USB

USB device port for remote

GPIB port

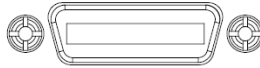

GPIB slave port for remote control. Abides to IEEE488.2 (SCPI) protocol.

LAN & Host port

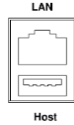

LAN and USB Host port for remote control.

CH1/CH2 rear panel output interface

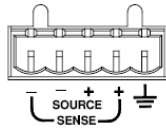

A total of 5 ports: 1 positive output terminals, 1 negative output terminals, a Sense+ terminal, a Sense- terminal and a ground terminal.

Relay control interface

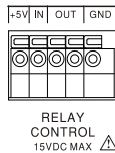

A total of 5 ports: A +5V input terminal, a ground terminal, a logic level input terminal and 2 CH1/CH2 terminals for relay control.

Load and DVM Connection

Recommended Cables	Model	Specification	Usage
	GTL-117	1kV	Front panel DVM input
	GTL-204A	10A	Front panel Source terminal
	GTL-203A	3A	Front panel Sense terminal

Front panel wiring Use the GTL-204A cables for the front panel source connections.

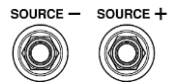

Use the GTL-203A cables for the sense connections.

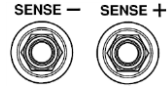

Use the GTL-117 cables for the DVM connections.

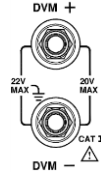

Rear panel connections

Insert the wires into the appropriate terminal according to the labels printed under the terminals.

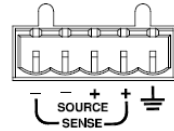

Note

For safety considerations, please keep in mind that the wiring must be equivalent to the wiring on the front terminals.

BASIC OPERATION

Source Function

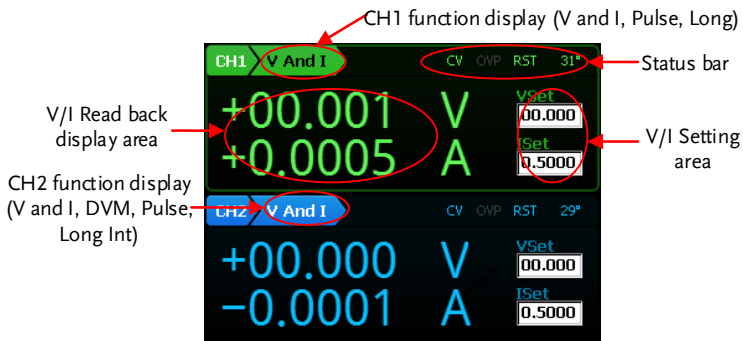

Note

- Under the Source interface:
Press the Tab key to toggle between "Function Setting", "VSet" and "ISet". CH1 has three functions: V and I / Pulse / Long Int. CH2 has 4 functions: V and I / DVM / Pulse / Long Int. Press the Enter key to enter the corresponding channel's parameter settings. The arrow keys can be used to switch to the secondary parameters. Press the Menu key to exit the parameter settings.
- When "Function Setting" is selected (displayed font is black), press the arrow keys to switch between the different "Function Setting".

Parameter Description	<p>CH1 and CH2 operate as a basic power supply with the ability to simultaneously display V/I settings and readback values. The output from CH1 can be toggled between the front and rear outputs using the Rear key. When the Rear key is lit, it indicates that the rear panel output is activated and that the front panel output is off. Both outputs can't be activated at the same time.</p>
IntRate	<p>The data sampling period derived from the number of power line cycles.</p> <p>The setting range is: 0.1PLC to 10.00PLC (power line cycles)</p> <p>1PLC = 16.7ms(60Hz)/20ms(50Hz).</p> <p>*PLC stands for power line cycles.</p>
AverRead	<p>Readback refresh rate. This will display the average number count.</p>
CurrRange	<p>The current range selection. Ch1 has three settings: 5A, 500mA and 5mA. CH2 has three settings: 5A, 5mA and Auto.</p>
LimMode	<p>Current limiting mode. There are 4 settings for the current limiting mode: Limit, Trip, LimitRelay and Trip Relay.</p> <p>The Limit settings will limit the current. When the current reaches the setting value, the current remains constant, as in CC mode.</p> <p>The Trip setting will turn the output</p>

off when the current limit has been reached.

See page 27 for details on the Limit Relay and Trip Relay settings.

RelayControl The relay control settings have 2 configurations: Zero/One.

The Zero setting means that if the output from the Relay control interface OUT port is low, the external relays will energize.

The One setting is just the opposite of the Zero setting.

See page 27 for further details.

Resistance The Setting range for battery resistance simulation is 0.000Ω ~ 1.000Ω and the setting resolution is 0.001Ω.



Note. This feature is only for CH1.

O.V.P The overvoltage settings have a setting range of 1.00~16.00V (CH1)/ 1.00~13.00V (CH2), OFF or Auto.

RecallSetup There are 6 sets of save/recall memories. Rst/ SAV0 to SAV4

Output Range	Voltage	CH1: 0.000V~15.000V CH2: 0.000V~12.000V
	Current	CH1: 0.0000A~3.0000A (0V~15V) 0.0000A~5.0000A (0V~9V) CH2: 0.0000A~1.5000A

Parameter
Settings

Voltage

Press the *Vol/Cur* key and the voltage setting on the LCD is activated. The corresponding number will turn black on white background.



(a) Use the number pad (keys: 0~9, . , Clear) to set the voltage value. Press the *Enter* key to confirm.

(b) Step Setting:

Press the left and right arrow

keys (← →) to fine tune the voltage setting at the digit level (The corresponding number will turn black on white background).

Press the up and down arrow

keys (↑ ↓) to adjust the selected digit. Press the *Enter* key to complete the setting.

Current





Press the *Vol/Cur* key and the current setting on the LCD is activated. The corresponding number will turn black in white background.



The input method is similar to inputting the voltage.

- IntRate** Press the *Enter* key to bring up the CH1 parameter setting bar. The default setting is Intrate. Press the *Enter* key to enter the desired parameter. Press the *Enter* key to complete the setting. The parameter range is from 0.01 to 10.00PCL. Press the arrow keys to set the other parameters for the setting.
- AverRead** Press the arrow keys to toggle to AverRead item. Press the *Enter* key to enter the desired parameter. Press the *Enter* key to complete the setting. The parameter range is from 01 to 10 samples. Press the arrow keys to select the other parameters for the setting.
- CurrRange** Press the arrow keys to toggle to CurrRange item. Press the *Enter* key and then press the up and down arrow keys to select the desired current range. Press the *Enter* key to complete the setting. Press the arrow keys to select the other parameters for the setting.
- LimMode** Press the arrow keys to toggle to LimitMode. Press the *Enter* key and then press the up and down arrow keys to set the current limited mode. Press the *Enter* key to complete the setting. Press the arrow keys to select the other parameters for the setting.

- RelayControl Press the arrow keys to toggle to RelayControl. Press the *Enter* key and then press the up and down arrow keys to set the desired initial state of relay control. Press the *Enter* key to complete the setting. Press the arrow keys to select the other parameters for the setting.
- Resistance Press the Arrow keys to toggle to Resistance. Press the *Enter* key and then press numeric keys to enter parameters (Range: 0.000 to 1.000 Ω). Press the *Enter* key to complete the setting. Press the arrow keys to select the other parameters for the setting. This feature is only for CH1.
- O.V.P Press the arrow keys to select O.V.P. Press Enter key and down arrow key to select the desired OVP State. There are three states: Off / On / Auto. If the On state is selected, you will need to enter the OVP value. Press the *Enter* key again to complete the setting. The input parameter range is from 1.00 to 16.00V (CH1)/ 1.00 to 13.00V (CH2). There is no need to set the OVP value for both the Off and Auto states. When Auto is selected, the OVP function will activate if the output value is higher than the setting value by 0.8V.
-

Operation	REAR / FRONT	Press the <i>Rear</i> key will toggle the output between the front and rear terminals for CH1. When the Rear key is lit, it indicates that the rear panel output is activated for CH1. When the Rear key is not lit, it indicates that the front panel output for CH1 is activated.
	Output	Press the <i>Output</i> key to turn the output on. When the output is on, the Output key will light up. When the output is off, the Output key will not be lit.
Status Description	CV/CC	CV appears in green (CH1) or in blue (CH2)  CC appears in red 
	O.V.P	OVP will appear in green (CH1) or in blue (CH2) when the OVP has not been tripped.  When the OVP has tripped, the output will be turned off and a small prompt window appears. When the OVP protection has not been activated, it will be greyed-out. 
	RST	Displays the power-on state setting 

DVM



Description The PPH-1503D has a separate digital voltmeter with a measurement range of 0~+20VDC.



Note: DVM and CH2 have a common ground design. So when using the DVM- terminal, it can't be shorted with the negative output of CH2. In addition, when using the voltage meter, the power supply must be properly grounded.

Parameter Description	Intrate	<p>Sets the reading rate of DVM measurements based on the number of PLCs. The setting range is: 0.1PLC to 10. 1PLC=16.7ms(60Hz) / 20ms(50Hz).</p> <p>*PLC stands for Power Line Cycle</p>
	AverRead	<p>The number of samples used to calculate the average.</p> <p>Normally the unit will display measurement results onto the screen as soon as they are captured.</p> <p>However when more stable results are needed, averaging can be used. The AverRead function collects several samples of data and then performs an averaging operation on the data before displaying the averaged result on the screen.</p>

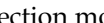
Parameter Settings	IntRate	Press <i>Enter</i> key to bring up the CH1 parameter setting column. The default setting is IntRate. Press the <i>Enter</i> key and then press numeric keys to enter parameters (Range: 0.01 to 10.00). Press the <i>Enter</i> key to complete the setting. Press the <i>Tab</i> key to select the other parameter for settings.
	AverRead	Press the arrow keys to select AverRead item. Press the <i>Enter</i> key and then press numeric keys to enter parameters (Range: 1 to 10). Press the <i>Enter</i> key to complete the setting. Press the <i>Tab</i> key to select the other parameter for settings.

Operation	Press CH1 / CH2 key to switch to the CH2 setting. Press the <i>Tab</i> key to switch to the function selection mode (V and I is changed from  to ). Press the right arrow key to go to DVM mode (). After switching to the DVM mode, the device is synchronized to start measuring. When voltage is measured, it doesn't affect the operation of the power supply. The output can be turned on or off by pressing the <i>Output</i> button.
-----------	---

Pulse Current Measurement

Description Changes in the load current allow us to measure the pulse current.

There are three ways that pulse current can be measured:

1. Measuring the peak current over a single cycle (High Measurement).
2. Measuring the trough current over a single cycle (Low Measurement).
3. Measuring the average current over a single cycle (Average Measurement).

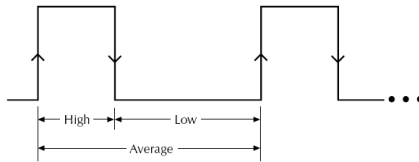

The high and average measurements are triggered by the rising edge of the pulse current and are performed for the time specified for the measurement.

Low measurement is triggered by the falling edge of the pulse current.

 **Note:** Pulse current measurement is only valid up to 5A (CH1) and 1.5A (CH2).

Parameter Description

IntTime

- Integration Time.
- The integration measurement time can be set to automatic or to one of the manual settings (High Time, Low Time and Aver Time).
- When the integration measurement time is set to

automatic mode, the system will measure the peaks and troughs of the pulse current and will automatically set an appropriate integration time. The automatic Integration time can automatically detect pulses in the 80us to 833ms range.

- The manual time range setting is 33us to 833333us. The default units are in microseconds (us).



Note

- IntTime setting automatically becomes 33.3 microseconds (us) in mode (Pulse current digitization)

TrigDelay

- Trigger Delay
- When a pulse is detected, there will be a 25us code execution delay time. Measurement will begin from after the trigger delay time. The trigger delay setting range is: 0~0.10000s, with a resolution of 0.00001s



Note

- The setting range for TrigDelay is 0~5 sec.(s)in mode (Pulse current digitization)

AverRead

- Average Reading Count: Reads back the average number of displayed values.
- This parameter is only applicable for pulse current measurement. The average number range can set from 1 ~ 100 with a resolution of 1.

- | | |
|-----------|--|
| TrigLevel | <ul style="list-style-type: none"> • Trigger Level. • To avoid false pulse measurements, the trigger level can be set close to the current amplitude. All noise and transient currents that are below the trigger level will be ignored. The trigger level has a setting range of 0~5A (CH1), 0~1.5A (CH2) with a resolution of 5mA. The setting unit for the trigger level is in amps (A). This setting is only valid for pulse measurements. |
|-----------|--|
-

Parameter
Settings

IntTime

Press the *Enter* key to enter the Pulse current measurement menu. The IntTime setting is first parameter of the menu. Press the *Enter* key to select the parameter. Press the down arrow key to set the type of Integration Time. High Time, Low Time and AverTime options are available for selection. Press the up arrow key to decide to set the integration time automatically or manually set. When manually setting is select, use the number pad to directly select a time setting. Press *Enter* key to complete the setting.

The time range can be set between 33us and 833333us. The setting units are in microseconds (us).

TrigDelay	Press the arrow keys to select TrigDelay. Press the <i>Enter</i> key to set the parameter. Press the <i>Enter</i> key again to complete the setting. The TrigDelay has a settable range of 0~0.10000s. The setting units are in seconds (s).
TrigLevel	Press the arrow keys to select TrigLevel. Press the <i>Enter</i> key to set the parameter. Press the <i>Enter</i> key again to complete the setting. The TrigLevel parameter has a settable range of 0~5.000A (CH1), 0~1.500A (CH2). The setting units are in amperes (A).
AverRead	Use the arrow keys to select AverRead. Press the <i>Enter</i> key to set the parameter. Press the <i>Enter</i> key again to complete the setting. The AverRead setting has a settable range of 1~00.

Panel Operation	Output	Press the <i>Output</i> key. When the Output key is lit, pulse current measurement is active. When no pulse current is detected, NO PULSE will be displayed in green on the LCD screen. The unit will wait until the next pulse is detected. The measurement settings can be edited during measurement. The H, L, A keys on the keypad can be used to quickly switch between measurement modes.
-----------------	--------	---

Long integration

Description The long current integration measurement function measures the mean (average) current over a single or multiple current pulses. This can extend the measurement time for long integration to a maximum of 60s. The long integration time period must be a full period or integer multiples of a complete period of the measured pulse current.

If the line frequency is 60Hz, then a single integration cycle is 16.7ms, if the frequency is 50Hz, then a single integration cycle must be 20ms. When this feature is used, the current range is set to 5A for CH1 and to 1.5A for CH2.

Parameter Description	IntTime	<ul style="list-style-type: none">• Integration time• The integration time can be set manually or automatically by the operator. For manual settings, the integration time can be set to a maximum of 60 seconds. For a line frequency of 60Hz the minimum integration time is 850mS with a step resolution of 16.7mS. For a line frequency of 50Hz, the minimum integration time is 840mS with a step resolution of 20mS.• When the integration time is set to Auto Time, the system will automatically measure the time between two adjacent rising edges and an appropriate integration time is set for the peak and trough. If there are more than two pulses, the integration time must be set manually.
------------------------------	----------------	---

- TrigEdge
- Trigger edge
 - Pulse edges are used to trigger long integration measurement. Regardless of whether a rising or falling edge is used as a trigger, a pulse must first be detected before measurement can start. Measurement can also start without an edge trigger. When TrigOnNeither is selected, measurement starts as soon as the output is turned on.
- TrigLevel
- Trigger level.
 - When the rising or falling edge trigger is selected for long integration current measurement, a pulse must first be detected. The trigger level refers to minimum pulse level required for a pulse to be detected. For example if the trigger level is set to 2A, pulses that are $\leq 2A$ will be detected. Pulses $< 2A$ will be ignored. The trigger level range is 0~5A. This setting only applies to long current integration measurements.

	Timeout	<ul style="list-style-type: none">• Pulse timeout• When long integration measurement is selected and the unit doesn't detect a pulse after a certain amount of time (pulse timeout time), the "No Pulse" message will be displayed on the LCD. This function is only applicable if rising or falling edge is selected as the edge trigger; the Trig On Neither trigger setting has no pulse timeout. The pulse timeout has a range of 1~63 seconds.
Parameter Settings	IntTime	<p>Press the <i>Enter</i> key to enter the Long integration measurement menu. The IntTime setting is first parameter of the menu. Press the <i>Enter</i> key to select the parameter. Press the up arrow key to decide to set the integration time automatically or manually set. When manually setting is select, use the number pad to directly select a time setting. Press <i>Enter</i> key to complete the setting.</p> <p>The time range is 850mS to 60S (50Hz) and 840mS to 60S (60Hz). The default unit is seconds (S).</p>
	TrigEdge	<p>Use the arrow keys to select TrigEdge. Press the <i>Enter</i> key to enter the menu. Use the up and down arrow keys to select the type of trigger. Press the <i>Enter</i> key again to complete the setting. The interface will display the selected trigger.</p>

	TrigLevel	Press the arrow keys key to select TrigLevel. Press the <i>Enter</i> key to set the parameter. Press the <i>Enter</i> key again to complete the setting. The trigger level setting range is 0~5A (CH1)/0~1.5A(CH2). The default unit is amps (A.)
	Timeout	Press the <i>Enter</i> key to select Timeout. Press the <i>Enter</i> key to set the parameter. Press the <i>Enter</i> key again to complete the setting. The time range is 1~63s. The default unit is seconds (s).

Operation	Output	Press the <i>Output</i> key to activate the pulse current measurement. When no pulse current is detected, NO PULSE will be displayed on the LCD screen. The unit will wait until the next pulse is detected.
-----------	--------	--

Current Sink Function

Function Description When the test circuit is an active circuit, and the manifested voltage in the test circuit is greater than the output voltage of the power supply, the power supply will automatically dissipate current from the external power supply. When this function is in the normal operating state, the power supply outputs the setting voltage, which is equivalent to a constant voltage load rather than constant current load.

The current dissipation from the power supply output flows from the positive terminal out to the negative terminal. The amount of current sunk is not controlled from the power supply.

Connection Connect the positive terminal of the external power supply to the positive terminal on the high-speed power supply. Connect the negative terminal of the external power supply to the negative terminal on the high-speed power supply.

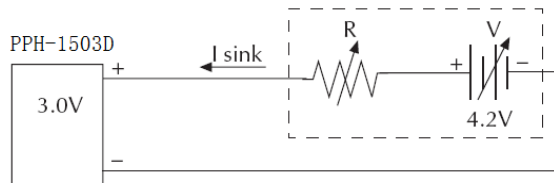

Conditions To protect the high-speed power supply when operating as a current sink, the following two conditions must be met:

1. Ensure that the voltage of the external power supply is greater than the output of the high-speed power supply voltage by 0.3V~2.5V. The voltage difference depends on the

high-speed power supply voltage output and the load conditions.

- To ensure that the power supply output voltage is within certain range, the current draw must be less than limit value. See the formula in the Table below for the details.

CH1	
Programmed Supply Voltage	Maximum allowable sink current
0 ~ 4V	3.5A
4 ~ 15V	$3.5A - (0.25A/V) * (V_{set} - 4V)$

CH2	
Programmed Supply Voltage	Maximum allowable sink current
0 ~ 5V	2.0A
5 ~ 12V	$2.0A - (0.1A/V) * (V_{set} - 5V)$

External Relay Control

Function Description When the Relay control feature is turned on, it is synced to the current limit of the power supply. The external relay control is divided into two different types, a limit relay and a trip relay.

The limit relay is used in conjunction with CC mode. When the constant current setting value is reached, the relay control signal will go high and will return back to the low level when the current level goes back below the constant current setting.

The trigger relay is used in conjunction with CC mode. When the constant current setting value is reached, the relay control signal will go high and the output is disabled. When the output goes back on and the current is less than the current setting value, the relay control signal will back to the low

level.

Rear Panel Control Interface

The rear panel control interface has five terminals, +5V, IN (The state of the Trip or Trip Relay output is used as the signal input), OUT (CH1 & CH2 controls signal output) and GND (connected to the chassis ground or earth ground), respectively.

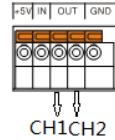

Wiring Method

A thin screwdriver or similar tool will need to be inserted into the release mechanism (highlighted in orange in the figure above) to open the terminals. Insert an exposed wire into the terminal and release the mechanism to lock the wire into place.

Schematic Diagram for Relay Control

Limit Relay:

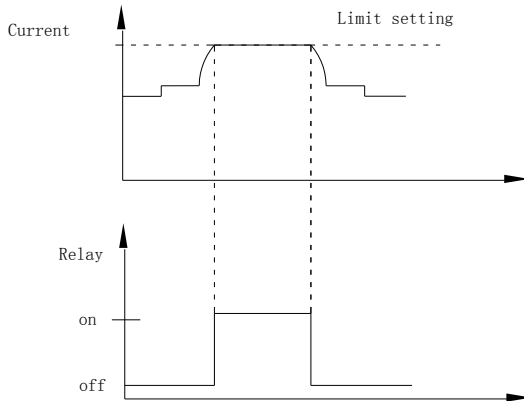

Trip Relay:

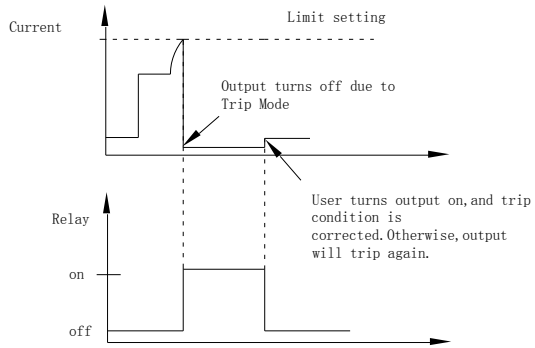

External Relay Connection

There are two ways to connect an external relay to the unit:

Using the +5VDC relay output to drive an external relay. Ensure the current doesn't exceed 150mA.

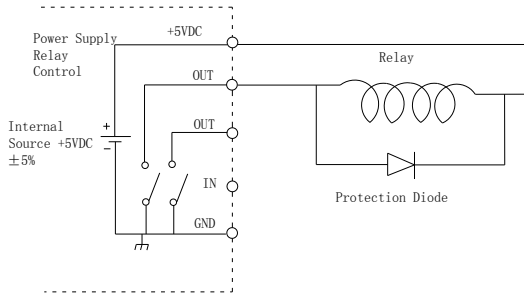

Warning

Do not short the 5VDC terminal to the chassis, earth or to the control port GND, otherwise it may damage the unit.

Using an external power source to drive the external relay. The voltage of the source cannot exceed 15V and the current cannot exceed 150mA.

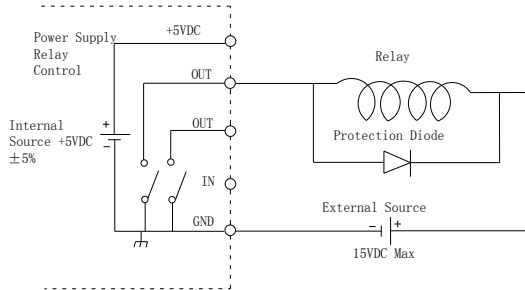

Sequence Function

Description This function can be used for practical applications when different voltage waveforms are required to be output. Users can edit the output waveform according to their needs. The amplitude range of the output waveform is the output voltage range of power supply. The setting range for output waveform duration is 0.001s ~ 3600s and the resolution is 0.001s. This feature is applicable to CH1.

Parameter Overview	NCycle	Cycle number, 0 represents an infinite loop. 1 represents a 2 cycle period. 2 represents a cycle with 2 periods, and so on. The range is from 0 to 9999.
	Steps	Sets the number of parameter which can set. The range is 1 to 1,000.

Parameter Setting	NCycle	After entering the Sequence interface, this parameter is selected by default. Press the arrow keys to set the parameter or use the numeric keypad pad to set parameters directly.
	Steps	Press the <i>Tab</i> key to select Steps. Press the arrow keys to set the parameters or use numeric keypad to set the parameters directly.
	V/I/T Setting	Press the <i>Tab</i> key to select the Voltage / Current / Time setting area.

No	V	A	S
1	1.000	2.0000	2.000
2	1.000	0.5000	0.100
3	1.000	0.5000	0.100

Press the up and down arrow keys to select the desired Step setting. Press the *Enter* key to input voltage value. Press the right arrow key to input the current value. Press the right arrow key to enter the duration and press the *Enter* key to complete the Step settings. Press the arrow keys to continue to set other specific parameters for the Steps setting.

Main Specifications

The specifications apply under the following conditions: The PPH-1503D is powered on for at least 30 minutes, within +18°C~+28°C.

DC GENERAL	MEASUREMENT TIME CHOICES	0.01 ~ 10PLC,0.01PLC/step	
	AVERAGE READINGS	1~10	
DC VOLTAGE	OUTPUT VOLTAGE	CH1:0~15V	CH2:0~12V
OUTPUT	OUTPUT ACCURACY	± (0.05%+10mV)	
	PROGRAMMING RESOLUTION	2.5mV	

(23°C±5°C)	READBACK ACCURACY	± (0.05%+3mV)	
	READBACK RESOLUTION	1mV	
	OUTPUT VOLTAGE RISING TIME	0.2ms (10% ~ 90%)	
	OUTPUT VOLTAGE FALLING TIME	0.3ms (90% ~ 10%)	
	LOAD REGULATION	0.01%+2mV	
	LINE REGULATION	0.5mV	
	RECOVERY TIME(1000%LOAD CHANGE)	<40us (<100mV, Rear) <50us (<100mV, Front) <80us (<20mV)	
	RIPPLE AND NOISE	3mV rms (0~1MHz) 8mVpp(20Hz~ 20MHz)	
	DC CURRENT (23°C±5°C)	OUTPUT CURRENT	CH1:0~5A (0~9V), 0~3A(9~15V) CH2:0~1.5A
		SOURCE COMPLIANCE ACCURACY	1.5A&5A range:±(0.16%+5mA) 500mA range: ±(0.16%+0.5mA) 5mA range: ±(0.16%+5uA)
PROGRAMMED SOURCE RESOLUTION		CH1: 5A range:1.25mA 500mA range:0.125mA 5mA range:1.25uA CH2: 1.5A range:1.25mA	
READBACK ACCURACY		CH1: 5A range: ±(0.2%+400uA) 500mA range: ±(0.2%+100uA) 5mA range: ±(0.2%+1uA) CH2:1.5A range:±(0.2%+400uA) 5mA range: ±(0.2%+1uA)	
READBACK RESOLUTION		1.5A & 5A range: 100uA 500mA range: 10uA 5mA range: 0.1uA	
CURRENT SINK CAPACITY		CH1: 0~4V: 3.5A 4~15V:3.5A derate (0.25A/V) CH2: 0~5V: 2A 5~12V: 2A derate(0.1A/V)	
LOAD REGULATION		0.01%+1mA	
LINE REGULATION		0.5mA	
DVM		INPUT VOLTAGE RANGE	0 ~ 20VDC
		INPUT IMPEDANCE	20MΩ
	MAXIMUM INPUT VOLTAGE	-3V, +22V	
	READING ACCURACY	± (0.05%+3mV)	
	READING RESOLUTION	1mV	

可编程高精度双输出直流电源供应器

PPH-1503D

快速操作手册

固纬料号: **82PH31503DM01**



ISO-9001 CERTIFIED MANUFACTURER

GW INSTEK

版权声明

这本手册包含所有权信息是受到版权保护的。版权属固纬电子实业股份有限公司拥有。手册的任何章节不得在固纬电子实业股份有限公司未授权之下做出任何之复制、重组或是翻译成其它之语言。

这本手册的所有信息在印制之前已经完全校正过。但因固纬电子实业股份有限公司不断地改善产品质量，固纬电子实业股份有限公司有权在未来修改产品之规格、特性及保养维修步骤，不必事前通知。

目录

简介	2
前面板	3
后面板	5
负载及 DVM 的连接	6
基本操作	8
Source 功能	8
DVM 功能	12
脉冲电流测量	13
长积分电流测量	16
吸纳电流吸收功能	19
外部继电器控制	20
Sequence 功能	22
主要规格	23

简介

本指南是为了给那些不是很熟悉此仪器使用而提供的一个快速了解的途径。如需要了解详细的内容，诸如系统设置、保存呼叫功能、远程指令操作等，请参照说明书。

此手册包含以下主要内容：

简介 机器面板说明、主要功能介绍

操作 显示界面和按键功能说明

总述 PPH-1503D 为一款可编程高精度双输出直流电源供应器，轻便，可调，多功能工作配置。除了具有基本电源的功能外，还具有脉冲电流测量、长时间电流平均测量及电池仿真等功能。PPH-1503D 专为电池供电的无线通信设备(例如蜂窝电话)的测试而优化设计的，这类设备往往在极短的时间内会出现较大的负载变化。该电源在脉冲负载变化过程中具有出色的电压稳定性，并且能够同时能测量相应的负载电流，即使负载电流是很短的脉冲也能测量。此外，电源还能够吸纳电流(Sink)，从而表现出可充电电池的特性，可用于测试充电器和充电器控制电路等。

前面板

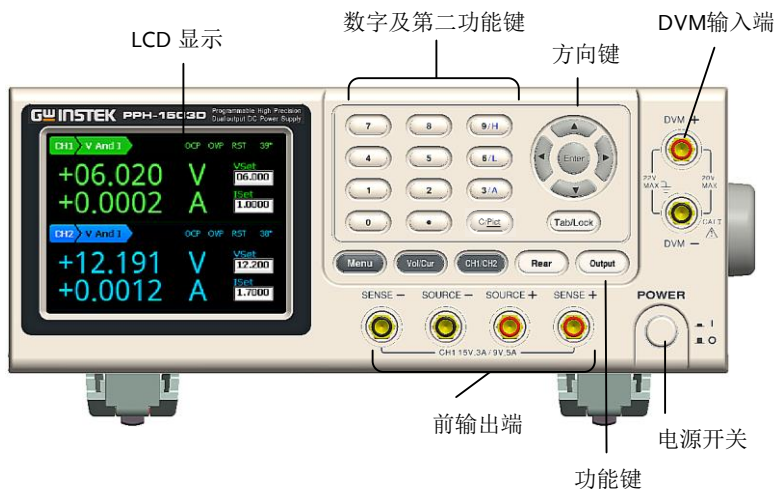

显示界面 LCD 显示区域

电压表头 显示输出电压，显示 5 位，默认单位为 V。

电流表头 显示输出电流，显示 5 位，数值单位根据电流量程 (CH1:5A/500mA/5mA; CH2:1.5A/5mA/AUTO) 的不同在 A 和 mA 之间切换。

设定显示 显示设定的电压/电流值。

设定参数显示 显示相关参数的设定值，设定操作请参见第 8 页

状态显示 显示当前的整机状态

功能显示 显示本机当前所用的功能，具体有四种功能：
基本电源功能(V AND I)；
脉冲电流测量功能(PULSE)；
电流长积分测量功能(LONG INT)；
数字电压表功能(DVM)。

控制面板

菜单键

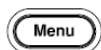

进入系统设定

电压电流设定切换键

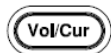

按此键即可切换电压和电流间的设定环境，输入方式请见第 10 页。

CH1/CH2 切换键

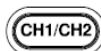

按此键即可切换 CH1 和 CH2 间的设定环境。

CH1 前后输出切换键

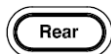

前后输出切换，Rear 灯亮起表示后面板输出。

输出键

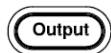

电压输出 ON/OFF 键，灯亮起表示输出打开，处于 ON 状态。DVM 时不受其影响。

换行/LOCK 键

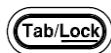

Tab 键：用于各种参数之间的切换

Lock 按键锁定键：灯亮起已锁定，此时只有 Output 键有效，Lock 键长按(约 2 秒左右)才能解锁。此外它还可以解除远程控制。

数字键

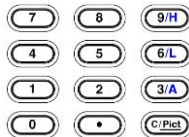

a. 数字键用于设定各个参数值，Clear 键可用于清除正在设定的参数值，Pict 键是长按时用于截屏 (screenshot)。

b. H/L/A 是 Pulse 电流测量功能的测量模式快捷键，只在 Pulse 电流测量主界面下才能有效。H 是高电平测量模式，L 是低电平测量模式，A 是平均测量模式。

方向及确认键



方向键是用来进行参数选择及菜单选择和电压/电流微调选择的。
Enter 是确定键，进入参数设定或设定完退出均可按此键

电源开关

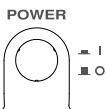

打开 或 关闭 主供电线路开关

后面板

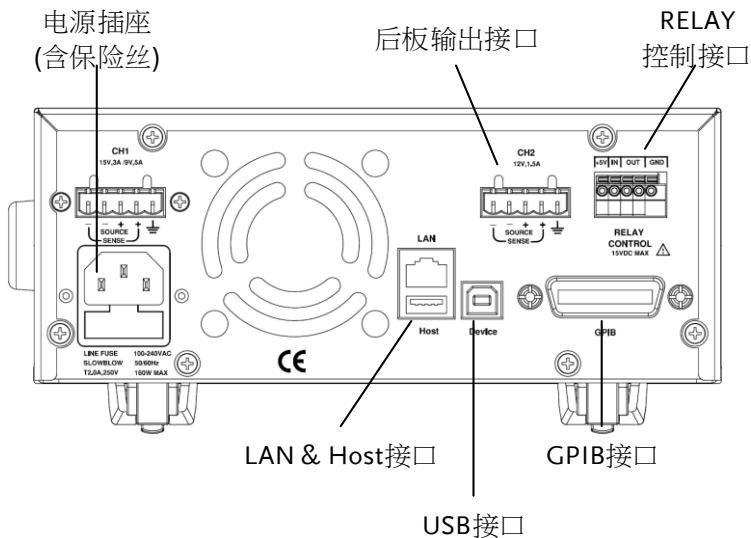

电源插座
(含保险丝)

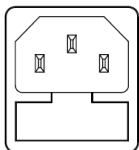

LINE FUSE 100-240VAC
SLOWBLOW 50/60Hz
T2,0A,250V 160W MAX

电源线插座接受电压 100~240 ± 10%VAC，频率为 50Hz/60Hz；保险丝采用 2A 慢熔型。

Device 接口



基于远程控制指令的 USB Device 从属接口。

GPIB 接口

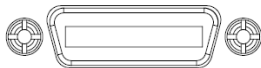

基于远程控制指令的 GPIB 从属接口，符合 IEEE-488.2 (SCPI) 协议。

LAN & Host 接口



基于远程控制的 LAN 从属接口及 USB Host 接口。

CH1/CH2 后板输出接口

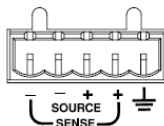

共有 5 个端口，包含电源输出正/负端，Sense+/-端，一个大地端。

RELAY 控制接口

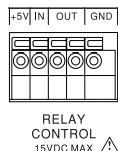

共有 5 个端口，一个+5V 输出端，一个 GND 端，一个逻辑电平输入端，两个为 CH1/CH2 继电器控制端

负载及 DVM 的连接

标准附线	型号	规格	用途
	GTL-117	1kV	DVM
	GTL-204A	10A	Source
	GTL-203A	3A	Source

前面板接线

插入 GTL-204A 电线



插入 GTL-203A 电线。

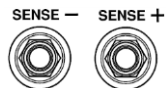

插入 GTL-117 电线。

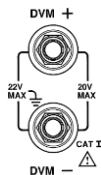

后面板接线

依照输出端口下之印字，插入自配电线。

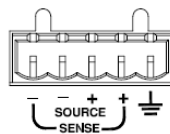

注意

为安全考虑，自配电线在规格需等同于前端配线。

基本操作

Source 功能



提示

- 在此 Source 界面下：按动 Tab 键，可在“功能”、“VSet”、“ISet”之间切换。CH1 的功能有 V and I/Pulse/LongInt 共 3 种，CH2 的功能有 V and I/DVM/Pulse/Long Int 供 4 种。按动 Enter 键即可进入相应通道之如下参数设定，方向键辅助作设定参数间切换，按动 Menu 键则退出参数设定。
- 选中“功能”时（显示字体为黑色），按动方向键，可在不同“功能”间切换。







描述

CH1 和 CH2 具有基本电源的功能，能同时显示 V/I 的设定和回读值。CH1 分前后输出，有 Rear 键做切换，Rear 灯亮表示由后板输出，前后面板不能同时输出。

参数说明	IntRate	数据采样周期，获取一次测量值的时间。 设定范围为 0.01PLC~10.00PLC。 1PLC=16.7ms(60Hz)/20ms(50Hz)。
	AverRead	回读刷新频率，显示值的平均次数，
	CurrRange	电流量程选择。CH1 有 5A/500mA/5mA 三种选择。CH2 有 5A/5mA/ Auto (自动)三种选择。
	LimMode	限流模式，有 Limit/Trip/LimitRelay/ TripRelay 四种。Limit 是当电流达到设定值时 就以恒流方式输出；Trip 是当电流达 到设定值时就关断输出；LimitRelay 和 TripRelay 详情请见第 20 页
	RelayControl	继电器控制设定，有 Zero/One 两个 状态，Zero: 是指 Relay 控制接口中 的 OUT 端口输出为低电位，外部继 电器将吸合；One: 同 Zero 相反。详 情请见第 21 页。
	Resistance	仿真电池内阻设定，设定范围是 0.000 Ω ~1.000 Ω ，设定分辨率是 0.001 Ω 。  提醒：仅 CH1 具有此功能
	O.V.P	过压保护设定，设定范围是 1.00~16.00V(CH1)/1.00~13.00V(CH2)或 OFF 或 Auto。
	RecallSetup	调取已有的设定，可调取 Rst/SAV0~SAV4 共 6 个设定。
输出范围	额定电压	CH1: 0.000V~15.000V CH2: 0.000V~12.000V

额定电流	CH1: 0.0000A~3.0000A (0V~15V) 0.0000A~5.0000A (0V~9V) CH2: 0.0000A~1.5000A	
参数设定	电压	按 <i>Vol/Cur</i> 键, LCD 上电压设定区被激活, 对应的数字会变成黑底白字。 
	(a) 数字键(0~9, ., Clear)输入, 按 <i>Enter</i> 键确认。	
	(b) 步进式输入: 按方向键中的左右键()选择需要微调的高低位(相应位会变成黑底白字), 按方向键中的上下键()增减设定值, 设定完按 <i>Enter</i> 键确认即可。	
	电流	按 <i>Vol/Cur</i> 键, LCD 上电流设定区被激活, 对应的数字会变成黑底白字。 
	输入方式同电压一致。	
	IntRate	按 <i>Enter</i> 键, 弹出 CH1 参数设定栏, 默认选中 <i>IntRate</i> 项, 按 <i>Enter</i> 键, 输入要设定的参数, 按 <i>Enter</i> 键即可。输入参数范围为 00.01~10.00, 按方向键可选择其它参数进行设定
	AverRead	按方向键选中 <i>AverRead</i> 项, 按 <i>Enter</i> 键, 输入要设定的参数, 按 <i>Enter</i> 键即可。输入参数范围为 01~10, 按方向键可选择其它参数进行设定

	CurrRange	按方向键选中 CurrRange 项，按 <i>Enter</i> 键，按上下键选择所需的量程，按 <i>Enter</i> 键即可。按方向键可选择其它参数进行设定。
	LimMode	按方向键选中 LimitMode 项，按 <i>Enter</i> 键，按上下键选择所需的限流模式，按 <i>Enter</i> 键即可。按方向键可选择其它参数设定。
	RelayControl	按方向键选中 RelayControl 项，按 <i>Enter</i> 键，按上下键选择所需的继电器初始状态，按 <i>Enter</i> 键即可。按方向键可选择其它参数进行设定。
	Resistance	按方向键选中 Resistance 项，按 <i>Enter</i> 键，输入参数，按 <i>Enter</i> 键即可。输入参数范围为 0.000~1.000 Ω ，按方向键可选择其它参数进行设定。此参数仅 CH1 有效。
	O.V.P	按方向键选中 O.V.P 项，按 <i>Enter</i> 键，按向下方向键选择需要的 OVP 状态，有 Off/On/Auto 三个状态。选中 On 状态时，输入 OVP 值，按 <i>Enter</i> 键即可。输入参数范围为 1.00~16.00V(CH1)/1.00~13.00V(CH2)。Off/Auto 两个状态无需设定 OVP 的值。Auto 时为自动过压保护功能，输出值比设定值高 0.8V 就会启动 OVP 功能。
操作	REAR / FRONT	按 <i>Rear</i> 键切换 CH1 前后输出， <i>Rear</i> 灯亮表示 CH1 后板输出；否则为前板输出。

	Output	按 <i>Output</i> 键输出，当输出灯亮时输出就打开；灯灭时输出就关闭。	
状态说明	CV/CC	恒压时显示绿色(CH1)或蓝色(CH2)CV	CH1 CH2  
		恒流时显示为红色 CC	
	O.V.P	过压保护未启动时显示绿色(CH1)和蓝色(CH2)O.V.P	CH1 CH2  
		启动过压保护时输出将关闭并小窗口提示	
		关闭 O.V.P 保护功能时显示为灰色	
	RST	显示开机初始状态的设定。	



DVM 功能

描述 1503D 电源上有一个附加的数字电压表，测量的电压范围是 0~+20VDC。

 **注意：**DVM 和 CH2 是共地设计，所以在使用时 DVM-不能和 CH2 的输出负极短接，同时使用电压表时电源必须接地良好。

参数说明 **Intrate** 测量频率，获取一次测量值的时间。设定范围为 0.01PLC~10.00PLC。
1PLC=16.7ms(60Hz) / 20ms(50Hz)。

*PLC 全称为 Power Line Cycle setting

	AverRead	显示值的平均次数，实测值的显示需要进行平均计算
参数设定	IntRate	按 <i>Enter</i> 键,跳出 CH1 参数设定栏,默认选中 <i>Intrate</i> 项,按 <i>Enter</i> 键,采用数字键输入参数(参数范围为 00.01~10.00),按 <i>Enter</i> 键即可。按方向键可选择其它参数进行设定。
	AverRead	按方向键选中 <i>AverRead</i> 项,按 <i>Enter</i> 键,输入参数,按 <i>Enter</i> 键即可。输入参数范围为 01~10。按 <i>Tab</i> 键可选择其它参数进行设定。
操作	按 CH1/CH2 键切换至 CH2 的设定,按 <i>Tab</i> 键切换至功能选择模式(V And I 由  变成 ),按方向键的右键切换至 DVM 模式 ()。切换至 DVM 后,机器即同步开始测量。进行电压测量时,不影响电源的运行。按 <i>Output</i> 键可正常开启或关闭。	

脉冲电流测量

描述

测量由于负载的脉冲式变化导致的脉冲电流。有三种方式:

1. 波峰值测量(High Measurement): 测量脉冲电流单个周期内的波峰值;
2. 波谷值测量(Low Measurement): 测量脉冲电流单个周期内的波谷值;
3. 平均值测量(Average Measurement): 测量脉冲电流单个周期内的平均值。

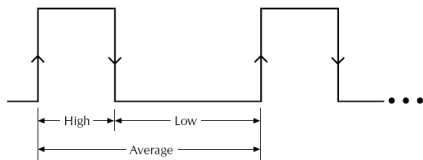

波峰值测量和平均值测量都以脉冲电流的上升沿来触发的，并按设定的时间进行测量；波谷值测量时脉冲电流的下降沿来触发的，并按设定的时间进行测量。

 **注意：**该功能只在电流 5A 量程 (CH1) 和 1.5A 量程 (CH2) 有效。

参数说明

- IntTime**
- **Integration Time**，积分时间。三种测量方式的积分时间均可以自动设定 (Auto time)或是用户手动设定 (High Time, Low Time, Average Time)。
 - 自动设定积分时间时，系统自动测量被选中的脉冲电流的波峰和波谷的周期并自动设定一个合适的积分时间。自动设定积分时间时能自动侦测 80us ~833ms 范围内的脉冲。
 - 手动设定的时间范围是 33us~833333 us，输入数字时默认的单位是毫秒(us)。

 **提醒** 电流数字量化输出模式 (Pulse current digitization) 时 IntTime 设定自动变为 33.3 微秒 (uS)。

- TrigDelay**
- **Trigger Delay**，触发延时。当脉冲被侦测到时，会有 25us 的代码执行时间。测量会在触发延时结束后才开始计时进行。触发延时设定范围为 0~0.10000S，分辨率为 0.00001S。



电流数字化输出模式 (Pulse current digitization) 时 TrigDelay 设定范围是 0~5 秒 (S).

- | | |
|-----------|--|
| AverRead | <ul style="list-style-type: none">• Average Readings Count, 回读显示值的平均次数。此参数的设定仅在电流脉冲测量功能中有效。平均次数的设定范围为 1~100, 分辨率为 1。 |
| TrigLevel | <ul style="list-style-type: none">• Trigger Level, 触发电平。为避免错误的脉冲被侦测到, 可以将触发电平设置接近于实际电流的大小。所有低于设定的触发电平的电流噪音或是其他的瞬变电流都将被忽略。触发电平的设定范围是 0~5A(CH1)、0~1.5A(CH2), 分辨率为 5mA。输入数字时默认的单位是安培(A)。此设定只对脉冲测量有效 |

参数设定

- | | |
|-----------|--|
| IntTime | 按 <i>Enter</i> 键打开 Pulse 电流测量菜单, 首次进入菜单, 默认选择在 IntTime 项, 按 <i>Enter</i> 键即可进入参数, 按向下方向键选中积分时间的类型, 如 High Time、Low Time、Aver Time。按向上方向键选择手动设定积分时间还是自动设定。用数字键盘直接输入积分时间即可, 完成设定后按 <i>Enter</i> 键退出该参数设定。设定的时间范围是 33us~833333us, 默认的单位是微秒(us)。 |
| TrigDelay | 按方向键选中 TrigDelay 项, 按 <i>Enter</i> 键, 输入参数, 按 <i>Enter</i> 键即可。输入的时间范围是 0~0.10000s, 默认的单位是秒(s) |

	TrigLevel	按方向键选中 TrigLevel 项，按 <i>Enter</i> 键，输入参数，按 <i>Enter</i> 键即可。输入的触发电平范围是 0~5.000A(CH1)、0~1.500A(CH2)，默认单位是安培(A)。
	AverRead	按方向键选中 AverRead 项，按 <i>Enter</i> 键，输入参数，按 <i>Enter</i> 键即可。设定范围是 1~100。

面板操作	Output	按 <i>Output</i> 键，当该键点亮时开始脉冲电流测量。当识别不到脉冲时在 LCD 上会显示绿色的 NO PULSE 字样，并继续等待及识别下一个脉冲电流。在测量中可直接修改测量参数。切换脉冲电流的测量方式，可按数字键盘区的 H、L、A 做快捷切换。
------	--------	--

长积分电流测量

描述	电流长积分测量功能是对单个或是多个脉冲电流做平均测量。测量时间可长达 60s，时间周期必须是被测电流脉冲的一个完整周期或是整数个完整周期。一个积分周期的时间，如果工频为 60Hz，那么一个积分周期就是 16.7ms，如果工频为 50Hz，那么一个积分周期就是 20ms。此功能运行时 CH1 电流为 5A 量程，CH2 为 1.5A 量程。
----	--

参数说明	IntTime	<ul style="list-style-type: none">• 积分时间。• 可以由用户设定自动或手动，交流输入频率为 60Hz 时，范围是 850ms~60S，步长为 16.7ms；频率为 50Hz 时，范围是 840ms~60s，步长为 20ms。• 自动(Auto Time)时，系统就会自动测量相邻两个上升沿之间的时间，并合理的设定一个包含波峰波谷的时间进行长积分测量。若想测量时间能包含两个或多个脉冲，就必须采用手动设定积分时间。
	TrigEdge	<ul style="list-style-type: none">• 触发沿。• 脉冲边沿可触发长积分测量，无论上升沿还是下降沿均可以触发测量，一旦选择上升沿或是下降沿触发，必须要发现符合要求的脉冲才可以开始测量。也可以不用边沿触发来触发测量，即 TrigOnNeither，选择此项就可以不用边沿触发来控制测量，只要 Output 打开就开始测量。
	TrigLevel	<ul style="list-style-type: none">• 触发电平。• 在一个上升沿或下降沿的脉冲边沿触发开始一个长积分测量之前，首先必须发现脉冲。触发电平指的是能被发现的最低脉冲电平。例如，如果触发电平设置为 2A，$\geq 2A$ 的脉冲会被发现。$< 2A$ 的电流脉冲被忽略。触发电平的范围是 0~5A。此设定只对长积分测量有效。

- Timeout
- 脉冲超时。
 - 当长积分测量功能被选中，在一定的时间(脉冲超时)内未识别到脉冲，就会在 LCD 上显示“NO PULSE”。此功能只适用于触发沿中的上升沿和下降沿，对于 Trig On Neither 来说是不存在脉冲超时的问题。脉冲超时的范围为 1~63 秒(s)。
-

参数设定

- IntTime 按 *Enter* 键打开 Long integration 电流测量菜单，默认首次选择在 IntTime 参数项，按 *Enter* 键即可进入该参数项进行设置。按向上方向键选择采用人工设定 IntTime 还是自动设定，选中人工设定 IntTime 时，采用数字键盘直接设定参数，按 *Enter* 键即可完成设置。设定的范围是：850ms~60s(50Hz)，840ms~60s(60Hz)，默认的单位是秒(s)。
- TrigEdge 按方向键选中 TrigEdge 项，按 *Enter* 键进入，按上下方向键选中触发类型，按 *Enter* 键即可完成设置。界面会显示所选的出发类型。
- TrigLevel 按方向键选中 TrigLevel 项，按 *Enter* 键，输入参数，按 *Enter* 键即可完成设定。设定的触发电平范围是：0~5A (CH1) / 0~1.5A(CH2)，默认的单位是安培(A)。
- Timeout 按 *Enter* 键选中 TimeOut 项，按 *Enter* 键，输入参数，按 *Enter* 键即可完成设定。设定的时间范围是：1~63S，默认的单位是秒(S)。

操作	Output	按 <i>Output</i> 键，开始脉冲电流测量。当识别不到脉冲时在 LCD 上会显示 NO PULSE 字样，并继续等待及识别下一个脉冲电流。
----	--------	--

吸纳电流吸收功能

功能描述	当外挂的测试电路是个有源电路，且被测电路体现出来的电压比高速电源的输出电压大时，高速电源会自动从外部电源吸收电流。此功能正常状态下在高速电源上显示的是设定的输出电压，即相当于一个恒压负载而不是恒流负载。吸收的电流从高速电源的输出正端进入，从输出负端流出，吸收的电流不受高速电源控制。
------	---

连接方式	外挂电源的正端接高速电源的输出正端，外挂电源的负端接高速电源的输出负端。具体见下图：
------	--

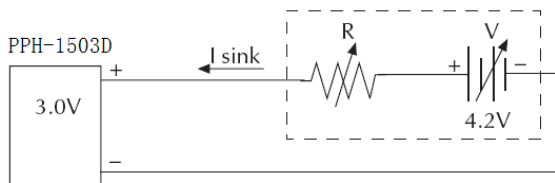

使用条件	为保障高速电源安全地工作在吸收电流状态下，需要满足下面两个条件： <ol style="list-style-type: none"> 1. 确保外挂电源的电压高于高速电源的输出电压，高出的电压约在 0.3V~2.5V 之间，根据高速电源的输出电压的大小而有所不同，且每台高速电源在相同的条件下也有轻微的差异； 2. 确保电源输出电压在一定范围内，吸收的电流不能大于限定值；具体见如下公式。
------	---

CH1	
Programmed Supply Voltage	Maximum allowable sink current
0 ~ 4V	3.5A
4 ~ 15V	$3.5A - (0.25A/V) * (V_{set} - 4V)$

CH2	
Programmed Supply Voltage	Maximum allowable sink current
0 ~ 5V	2.0A
5 ~ 12V	$2.0A - (0.1A/V) * (V_{set} - 5V)$

外部继电器控制

功能描述

当继电器控制功能被打开时，此功能是和电流的限流模式同步的，分为 Limit Relay 和 Trip Relay。Limit Relay 是电流为恒流(Limit)时，当电流达到设定值，内部的 Relay 控制信号就会置高电平，在 OUT 端口输出低电平，以便让继电器吸合；当电流回到小于设定值时，内部的继电器控制信号从高电平回到低电平，在 OUT 端口输出高电平，让继电器断开。

Trip Relay 是电流为触发(Trip)时，当电流达到设定值，电源输出关闭，内部的继电器控制信号置高电平，在 OUT 端口输出低电平，外部继电器产生吸合动作；当电源输出被再次打开且电流未达到设定值时，内部的继电器控制信号从高电平回到低电平，在 OUT 端口输出高电平，外部继电器断开。

后板控制接口

接口中有 5 个端子，为 +5V，IN(Trip 及 Trip Relay 状态时输出打开信号输入端)，OUT(CH1 控制信号输出和 CH2 控制信号输出)，GND(与外壳或大地相连)。

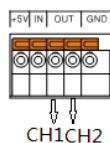

继电器控制信号 示意图
Limit Relay:

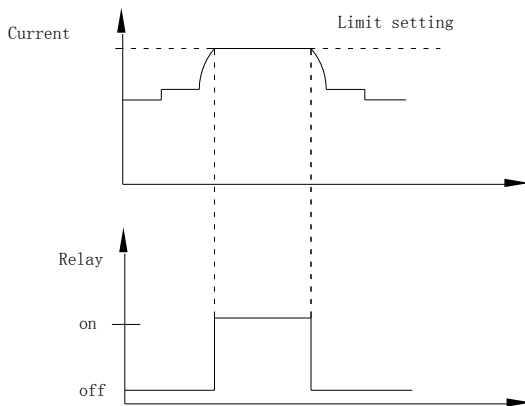

Trip Relay:

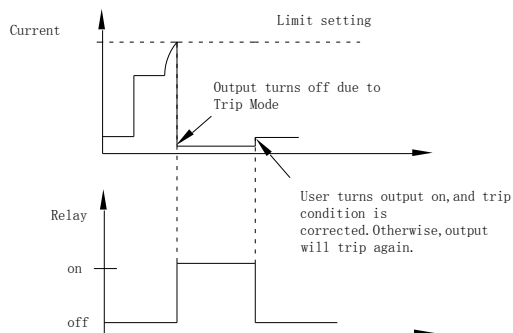

外部继电器供电 方式 方法一：用本机提供的+5VDC 电源来驱动，注意电流不能超过 150mA。

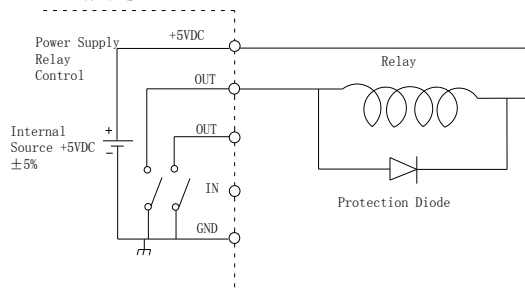



警告

在使用电源内部 5VDC 时不能将其短接到外壳、大地及控制端口的 GND 端，否则将会损坏机器。

方法二：采用外部的电源来驱动，外部电源的电压最大不能超过 15VDC，电流不能超过 150mA。

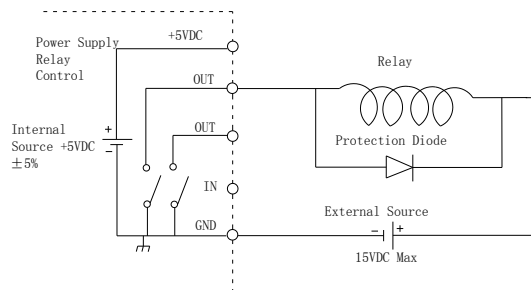

Sequence 功能

描述 在实际应用中需要输出不同的电压波形时，可采用该功能。用户可以根据自己的需求编辑输出波形。输出波形的幅度范围为电源的输出电压/电流范围，输出波形持续时间的设定范围为 0.001S~3600S，分辨率为 0.001S。此功能仅 CH1 具有。

参数说明 **NCycle** 循环次数，0 代表无限循环，1 代表循环一个周期，2 代表循环两个周期，以此类推。范围是 0~9999。

Steps 设定的参数组数，范围是 1~1000。

参数设定 **NCycle** 进入 Sequence 界面后，按方向键进行参数的设定或是采用数字键盘直接设定参数；

Steps 按 *Tab* 键选中 Steps 项，按方向键进行参数的设定或是采用数字键盘直接设定参数。

V/I/T 设定 按 *Tab* 键选中参数电压/电流/时间设定区域

No	V	A	S
1	1.000	2.0000	2.000
2	1.000	0.5000	0.100
3	1.000	0.5000	0.100

按上下键选中要设定的 Step，按 *Enter* 键，输入电压值，按方向键的右键，输入电流值，按方向键的右键，输入持续的时间，按 *Enter* 键即可完成该 Step 的设定，按上下键可继续设定其他的 Steps 的具体参数设定

主要规格

PPH-1503D 的规格应用在热机 30 分钟后，温度在 $+18^{\circ}\text{C} \sim +28^{\circ}\text{C}$ 。

DC GENERAL	MEASUREMENT TIME CHOICES	0.01 ~ 10PLC,0.01PLC/step
	AVERAGE READINGS	1~10
DC VOLTAGE OUTPUT ($23^{\circ}\text{C} \pm 5^{\circ}\text{C}$)	OUTPUT VOLTAGE	CH1: 0~15V CH2: 0~12V
	OUTPUT ACCURACY	$\pm (0.05\%+10\text{mV})$
	PROGRAMMING RESOLUTION	2.5mV
	READBACK ACCURACY	$\pm (0.05\%+3\text{mV})$
	READBACK RESOLUTION	1mV
	OUTPUT VOLTAGE RISING TIME	0.2ms (10% ~ 90%)
	OUTPUT VOLTAGE FALLING TIME	0.3ms (90% ~ 10%)
	LOAD REGULATION	0.01%+2mV
	LINE REGULATION	0.5mV
	RECOVERY TIME(100%LOAD CHANGE)	<40us (<100mV, Rear) <50us (<100mV, Front) <80us (<20mV)

	RIPPLE AND NOISE	3mV rms(0~1MHz) 8mVpp(20Hz~ 20MHz)
DC CURRENT (23°C±5°C)	OUTPUT CURRENT	CH1: 0~5A (0~9V), 0~3A(9~15V) CH2: 0~1.5A
	SOURCE COMPLIANCE ACCURACY	1.5A&5A range:±(0.16%+5mA) 500mA range: ±(0.16%+0.5mA) 5mA range: ±(0.16%+5uA)
	PROGRAMMED SOURCE RESOLUTION	CH1: 5A range: 1.25mA 500mA range: 0.125mA 5mA range:1.25uA CH2: 1.5A range:1.25mA
	READBACK ACCURACY	CH1: 5A range: ±(0.2%+400uA) 500mA range: ±(0.2%+100uA) 5mA range: ±(0.2%+1uA) CH2: 1.5A range:±(0.2%+400uA) 5mA range: ±(0.2%+1uA)
	READBACK RESOLUTION	1.5A&5A range: 100uA 500mA range: 10uA 5mA range: 0.1uA
	CURRENT SINK CAPACITY	CH1:0~4V: 3.5A 4~15V: 3.5A derate (0.25A/V) CH2: 0~5V: 2A 5~12V: 2A derate (0.1A/V)
	LOAD REGULATION	0.01%+1mA
	LINE REGULATION	0.5mA
DVM	INPUT VOLTAGE RANGE	0 ~ 20VDC
	INPUT IMPEDANCE	20MΩ
	MAXIMUM INPUT VOLTAGE	-3V, +22V
	READING ACCURACY	± (0.05%+3mV)
	READING RESOLUTION	1mV