

Dual Measurement Multimeter

GDM-8261A

USER MANUAL

REV. F



ISO-9001 CERTIFIED MANUFACTURER

GW INSTEK

This manual contains proprietary information, which is protected by copyrights. All rights are reserved. No part of this manual may be photocopied, reproduced or translated to another language without prior written consent of Good Will company.

The information in this manual was correct at the time of printing. However, Good Will continues to improve products and reserves the right to change specifications, equipment, and maintenance procedures at any time without notice.

Good Will Instrument Co., Ltd.

No. 7-1, Jhongsing Rd., Tucheng Dist., New Taipei City 236, Taiwan (R.O.C.).

Table of Contents

SAFETY INSTRUCTIONS	6
Safety Symbols	6
Safety Guidelines	7
GETTING STARTED	10
GDM-8261A Characteristics	11
Front Panel Overview	13
Rear Panel Overview	19
Set Up	21
BASIC MEASUREMENT	24
Basic Measurement Overview	26
AC/DC Voltage Measurement	28
AC/DC Current Measurement	33
2W/4W Resistance Measurement	35
Diode Test	38
Continuity Test	39
Temperature Measurement	43
DUAL MEASUREMENT	49
Dual Measurement	49
ADVANCED MEASUREMENT	55
Advanced Measurement Overview	56
dBm/dB/W Measurement	58
Max/Min Measurement	61
Relative Value Measurement	62
Hold Measurement	64
Compare Measurement	65
Math Measurement	68
SYSTEM/DISPLAY CONFIGURATION	74
Refresh Rate Setting	76
View Serial Number	76

Select Beeper Setting	77
Trigger Setting	78
Filter Setting	81
Display Setting	85
Measurement Configuration Settings	86
ADC Setting.....	90
Frequency / Period Settings	95
Identification Settings	98
STORE/RECALL	99
Store Measurement Record	100
Recall Measurement Record.....	101
Save Instrument Settings	102
Recall Instrument Settings	103
SCANNER (OPTIONAL)	105
GDM-SC1A Scanner Specifications	106
Scanner Installation	106
How To Thermocouple Measurement	117
Setup Scan	119
Run Scan	126
DIGITAL I/O	129
Digital I/O Terminal Configuration	130
REMOTE CONTROL	136
Configure Interface.....	138
Web Control Interface	165
Command Syntax	169
Command Set.....	170
FAQ	216
APPENDIX.....	218
Firmware Version	219
Fuse Replacement	220
Menu Tree	222
Status system	224

Specifications..... 225

INDEX **235**

S SAFETY INSTRUCTIONS

This chapter contains important safety instructions that you must follow when operating the GDM-8261A and when keeping it in storage. Read the following before any operation to insure your safety and to keep the GDM-8261A in the best possible condition.

Safety Symbols

These safety symbols may appear in this manual or on the GDM-8261A.



WARNING

Warning: Identifies conditions or practices that could result in injury or loss of life.



CAUTION

Caution: Identifies conditions or practices that could result in damage to the GDM-8261A or to other property.



DANGER High Voltage



Attention Refer to the Manual



Protective Conductor Terminal



Earth (ground) Terminal



Do not dispose electronic equipment as unsorted municipal waste. Please use a separate collection facility or contact the supplier from which this instrument was purchased.

Safety Guidelines

General Guideline



CAUTION

- Make sure that the voltage input level does not exceed DC1000V/AC750V.
- Make sure the current input level does not exceed 10A.
- Do not place any heavy object on the GDM-8261A.
- Avoid severe impact or rough handling that can lead to damaging the GDM-8261A.
- Do not discharge static electricity to the GDM-8261A.
- Use only mating connectors, not bare wires, for the terminals.
- Do not block or obstruct the cooling fan vent opening.
- Do not perform measurement at the source of a low-voltage installation or at building installations (Note below).
- Do not disassemble the GDM-8261A unless you are qualified as service personnel.
- Make sure that the Sense LO terminal to COM port is limited to 100Vpk, the Sense HI to Sense LO terminals are limited to 200Vpk and the COM port to earth is limited to 500Vpk.

(Note) EN 61010-1:2010 specifies the measurement categories and their requirements as follows. The GDM-8261A falls under category II 600V.



- Measurement category IV is for measurement performed at the source of low-voltage installation.
- Measurement category III is for measurement performed in the building installation.
- Measurement category II is for measurement performed on the circuits directly connected to the low voltage installation.

Power Supply



WARNING

- AC Input voltage: 100/120/220/240 V AC $\pm 10\%$, 45Hz to 66Hz / 360Hz to 440Hz
 - The power supply voltage should not fluctuate more than 10%.
 - Connect the protective grounding conductor of the AC power cord to an earth ground, to avoid electrical shock.
-

<p>Fuse</p>  <p>WARNING</p>	<ul style="list-style-type: none"> • Fuse type: 0.315AT 100/120VAC 0.125AT 220/240 VAC • Make sure the correct type of fuse is installed before power up. • To avoid risk of fire, replace the fuse only with the specified type and rating. • Disconnect the power cord before fuse replacement. • Make sure the cause of a fuse blowout is fixed before fuse replacement.
<p>Cleaning the GDM-8261A</p>	<ul style="list-style-type: none"> • Disconnect the power cord before cleaning. • Use a soft cloth dampened in a solution of mild detergent and water. Do not spray any liquid into the GDM-8261A. • Do not use chemicals or cleaners containing harsh material such as benzene, toluene, xylene, and acetone.
<p>Operation Environment</p>	<ul style="list-style-type: none"> • Location: Indoor, no direct sunlight, dust free, almost non-conductive pollution (Note below) • Temperature: Full accuracy for 0°C to 55°C. • Humidity: Full accuracy to 80% RH at 40°C
<p>(Note) EN 61010-1:2010 specifies the pollution degrees and their requirements as follows. The GDM-8261A falls under degree 2. Pollution refers to “addition of foreign matter, solid, liquid, or gaseous (ionized gases), that may produce a reduction of dielectric strength or surface resistivity”.</p> <ul style="list-style-type: none"> • Pollution degree 1: No pollution or only dry, non-conductive pollution occurs. The pollution has no influence. • Pollution degree 2: Normally only non-conductive pollution occurs. Occasionally, however, a temporary conductivity caused by condensation must be expected. • Pollution degree 3: Conductive pollution occurs, or dry, non-conductive pollution occurs which becomes conductive due to condensation which is expected. In such conditions, equipment is normally protected against exposure to direct sunlight, precipitation, and full wind pressure, but neither temperature nor humidity is controlled. 	
<p>Storage Environment</p>	<ul style="list-style-type: none"> • Location: Indoor • Temperature: -40°C to 70°C
<p>Disposal</p> 	<p>Do not dispose this instrument as unsorted municipal waste. Please use a separate collection facility or contact the supplier from which this instrument was purchased. Please make sure discarded electrical waste is properly recycled to reduce environmental impact.</p>

Power cord for the United Kingdom

When using the GDM-8261A in the United Kingdom, make sure the power cord meets the following safety instructions.

NOTE: This lead / appliance must only be wired by competent persons



WARNING: THIS APPLIANCE MUST BE EARTHED

IMPORTANT: The wires in this lead are coloured in accordance with the following code:

Green/ Yellow: Earth

Blue: Neutral

Brown: Live (Phase)



As the colours of the wires in main leads may not correspond with the coloured marking identified in your plug/appliance, proceed as follows:

The wire which is coloured Green & Yellow must be connected to the Earth terminal marked with either the letter E, the earth symbol \oplus or coloured Green/Green & Yellow.

The wire which is coloured Blue must be connected to the terminal which is marked with the letter N or coloured Blue or Black.

The wire which is coloured Brown must be connected to the terminal marked with the letter L or P or coloured Brown or Red.

If in doubt, consult the instructions provided with the equipment or contact the supplier.

This cable/appliance should be protected by a suitably rated and approved HBC mains fuse: refer to the rating information on the equipment and/or user instructions for details. As a guide, a cable of 0.75mm^2 should be protected by a 3A or 5A fuse. Larger conductors would normally require 13A types, depending on the connection method used.

Any exposed wiring from a cable, plug or connection that is engaged in a live socket is extremely hazardous. If a cable or plug is deemed hazardous, turn off the mains power and remove the cable, any fuses and fuse assemblies. All hazardous wiring must be immediately destroyed and replaced in accordance to the above standard.

GETTING STARTED

This chapter describes the GDM-8261A in a nutshell, including an Overview of its main features and front / rear panel introduction. After going through the Overview, follow the Power-up sequence to properly setup the GDM-8261A.

Please note the information in this manual was correct at the time of printing. However as GW Instek continues to improve its products, changes can occur at any time without notice. Please see the GW Instek website for the latest information and content.



Characteristics	GDM-8261A Characteristics.....	11
Panel Overview	Accessories	12
	Front Panel Overview.....	13
	Measurement Keys (upper row).....	14
	Measurement Keys (lower row)	17
	Rear Panel Overview	19
Setup	Tilt Stand	21
	Power Up	22

GDM-8261A Characteristics

The GDM-8261A is a portable, dual-display digital multimeter suitable for a wide range of applications, such as production testing, research, and field verification.

Performance	<ul style="list-style-type: none">• High DCV accuracy: 0.0035%• High current range: 10A• High Voltage range: 1000V• High ACV frequency response: 300kHz
Features	<ul style="list-style-type: none">• 6 ½ digits• Multi functions: ACV, DCV, ACI, DCI, 2W/4W R, Hz, Temp, Continuity, Diode test, MAX/MIN, REL, dBm, Hold, MX+B, 1/X, REF%, dB, Compare, Statistics.• Manual or Auto ranging• AC true RMS
Interface	<ul style="list-style-type: none">• Voltage/Resistance/Diode/Temperature input• Current input• 4W sense input• USB device/RS232/GPIB(optional)/LAN(optional) for remote control• 9-pin digital I/O• 16 channel scanner (optional)
Software	<ul style="list-style-type: none">• Excel ADD-In, RS-232C/USB Interface Supported• LabVIEW Driver

Accessories

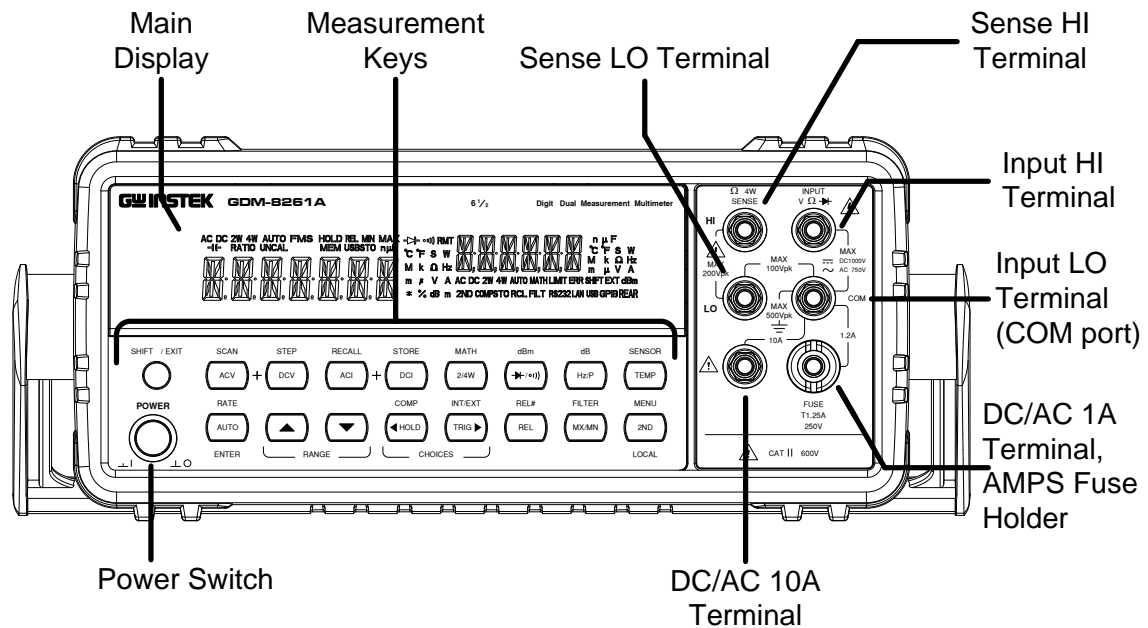

Standard Accessories	Part number	Description
	CD-ROM	UM, Software, Driver
	82DM-8261AM*1	Quick Start Guide
	GTL-207A	Test leads
	GTL-247	USB Cable, USB 2.0, A-A type, 1.8M
	GDM-01	Calibration key (for firmware upgrade)
Optional Accessories	Part number	Description
	GDM-SC1A	Scanner Card, 16+2 Channels
	GDM-82G1	GPIB card for GDM-8261A
	GDM-82L1	LAN card for GDM-8261A
	 Note	Only GPIB or LAN card can be installed at the same time.
	GTL-108A	4W Type test lead, Approx. 1100mm
	GTL-232	RS-232C Cable, 9-pin Female to 9-pin, null Modem for Computer, Approx. 2000mm
	GTL-205A	Temperature Probe Adapter with Thermal Coupling (K-type)
	GTL-248	GPIB Cable, Approx. 2000mm
	GRA-422	Rack Mount Kit (19" 2U)
	GDM-TL1	<ul style="list-style-type: none"> ▪ Test lead probes with CAT IV 600V sheath x 2 ▪ Fine tip probes x 2 ▪ SMT Grabbers x 2 ▪ Mini Grabber x 1
	GSC-014	Soft carrying case for DMM accessory
	GRA-436	Rack Mount Kit (19", 2U) for two sets

Front Panel Overview

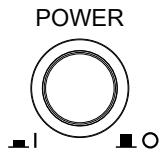

Power Switch



Turns On  or Off  the main power. For the power up sequence, see page 22.

Main Display

Shows measurement results and parameters.
For display configuration details, see page 84 (light setting).

DC/AC 1A Terminal
AMPS Fuse Holder

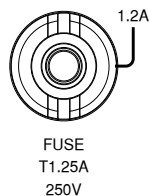



As a fuse, protects the instrument from over-current. Rating: T1.25A, 250V.(This terminal accepts DC/AC current input)
For the fuse replacement procedure, see page 221.
DC: 100 μ A~1A
AC:1mA~1A
For details see page 33.

Sense LO Terminal

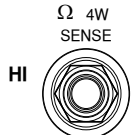

Accepts LO sense line in 4W resistance measurement. For details, see page 35

Sense HI Terminal		Accepts HI sense line in 4W resistance measurement. For details, see page 35.
-------------------	---	---

Input LO Terminal		Accepts ground (COM) line in all measurements except the sense line in 4W Resistance (page 35). The maximum withstand voltage between this terminal and earth is 500Vpk.
-------------------	---	---

Input HI Terminal		Used as an input port for all measurements except for DC/AC Current measurements.
-------------------	---	---

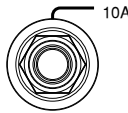
DC/AC 10A Terminal		Accepts DC/AC Current input. For DCI or ACI details, see page 33.
--------------------	---	--

Measurement Keys (upper row)

SHIFT/EXIT		<p>The Shift key is used to select the secondary functions assigned to each front panel key. When pressed, the SHIFT indicator appears in the display.</p> <p>As the Exit key, it gets out of the parameter configuration mode and goes back to the measurement result display mode.</p>
------------	---	--

ACV		Measures AC Voltage (page 28).
-----	---	--------------------------------

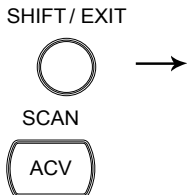
SHIFT → ACV (SCAN)		Starts the optional scan measurement (page 117).
--------------------	---	--

DCV		Measures DC Voltage (page 28).
-----	---	--------------------------------

SHIFT → DCV (STEP)	SHIFT/EXIT ○ STEP DCV	→	Starts the step measurement (page 117) using the optional scanner.
ACI	ACI		Measures AC Current (page 33).
SHIFT → ACI (RECALL)	SHIFT/EXIT ○ RECALL ACI	→	Recalls a normal measurement result, standard deviation measurement readings (page 101) or scan measurement results (page 127).
DCI	DCI		Measures DC Current (page 33).
SHIFT → DCI (STORE)	SHIFT/EXIT ○ STORE DCI	→	Stores a measurement result (page 100).
2/4W (Resistance)	2/4W		Measures 2-wire or 4-wire Resistance (page 34).
SHIFT → 2/4W (MATH)	SHIFT/EXIT ○ MATH 2/4W	→	Enters the Math measurement mode (page 68).
→ /•) (Diode/ Continuity)	→ /•)		Tests Diode (page 38) or Continuity (page 39).
SHIFT → → /•) (dBm)	SHIFT/EXIT ○ dBm → /•)	→	Measures dBm (page 58).
Hz/P (Frequency/ Period)	Hz/P		Measures Frequency or Period (page 41).

SHIFT + Hz/P
(dB)

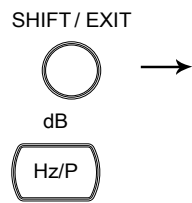

Measures dB (page 59).

TEMP
(Temperature)



Measures Temperature (page 43).

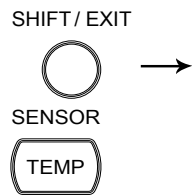

SHIFT + TEMP
(SENSOR)





Selects the type of thermocouple used in the Temperature measurement (page 44).



Measurement Keys (lower row)

<p>AUTO/ENTER</p>		<p>As the AUTO key, selects the measurement range automatically.</p> <p>As the Enter key, confirms the entered value.</p>
-------------------	---	---



<p>SHIFT → AUTO (RATE)</p>	<p>SHIFT/EXIT</p>  → 	<p>Selects the measurement update rate: Slow, Medium, or Fast (page 26).</p>
--------------------------------	--	--

<p>Up/Down</p>	  	<p>Selects the parameter in various occasions: higher (▲) or lower (▼).</p>
----------------	--	---

<p>HOLD</p>		<p>Activates the Hold function (page 64).</p>
-------------	--	---

<p>SHIFT → HOLD (COMPare)</p>	<p>SHIFT/EXIT</p>  → 	<p>Activates the Compare measurement (page 65).</p>
-----------------------------------	--	---

<p>TRIG (Trigger)</p>		<p>Triggers sample acquisition manually (page 78).</p>
-----------------------	---	--

<p>SHIFT → TRIG (Int/Ext Trigger)</p>	<p>SHIFT/EXIT</p>  → 	<p>Selects the Internal or the External trigger source (page 78).</p>
---	--	---

<p>Left/Right</p>	  	<p>Selects parameters in various menus: left (◀) or right (▶).</p>
-------------------	--	--

<p>REL</p>		<p>Measures the Relative value (page 62).</p>
------------	---	---

SHIFT → REL
(RELative base)

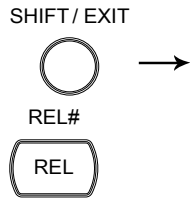

Manually sets the reference value for the Relative value measurement (page 62).

MX/MN
(MAX/ MIN)



Measures the Maximum or the Minimum value (page 61).

SHIFT → MX/MN
(FILTER)

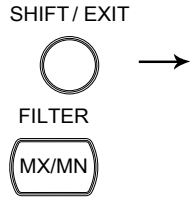

Selects the digital filter type for the signal sampling (page 81).

2nd (Display) /
LOCAL



As the 2nd key, selects the measurement item on the 2nd display (page 49). Pressing and holding for more than 1 second turns off the 2nd display.

As the Local key, releases the remote control and returns the instrument to local panel operation (page 138).

SHIFT → 2nd
(Menu)

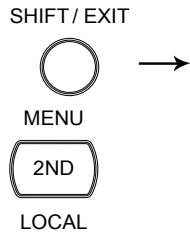

Enters the configuration mode for; System Settings, Measurement Settings, ADC Settings, Frequency/Period Settings, I/O Settings, TX TERM Settings and Scanner Settings.

Rear Panel Overview

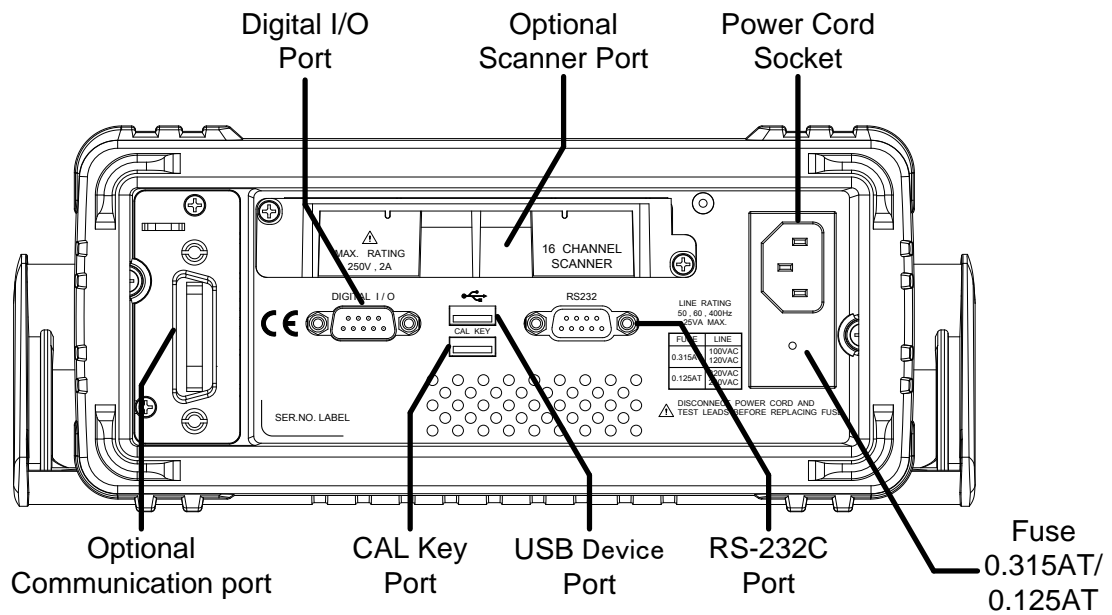

Power Cord Socket

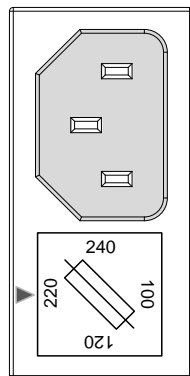

Accepts the power cord. AC 100/120/220/240V $\pm 10\%$, 45Hz~66Hz, 360Hz~440Hz.

For power on sequence, see page 22.

Fuse Socket

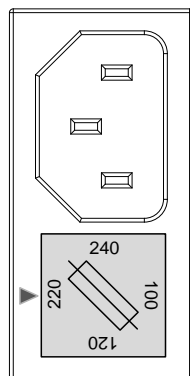

Holds the main fuse:
100/120 VAC: 0.315AT
220/240 VAC: 0.125AT

For fuse replacement details, see page 220.

RS-232C port

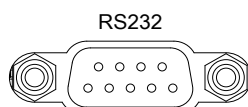

Accepts an RS-232C cable for remote control; DB-9 male connector.

For remote control details, see page 139.

USB device port

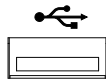

Accepts a USB device cable for remote control; Type A, female connector.

For remote control details, see page 138.

CAL key port

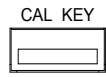

Reserved for internal purposes such as firmware updates and calibration.

Digital I/O port

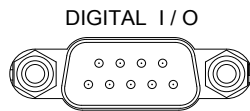

Accepts a digital I/O cable for the Hi/Lo limit tests; DB-9 pin, female connector.

For digital I/O details, see page 130.

Optional slot x1

Accepts the optional 16 channel scanner module. For scanner details, see page 105.

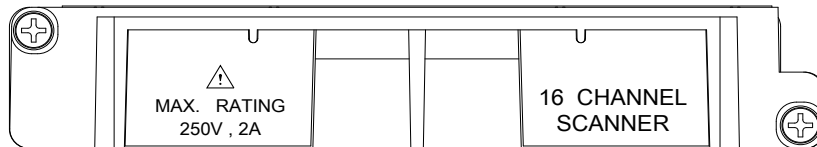

Optional Communication port

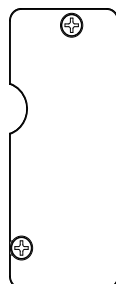

Accepts an optional GPIB or Ethernet card.

Set Up

Tilt Stand

Tilt stand steps

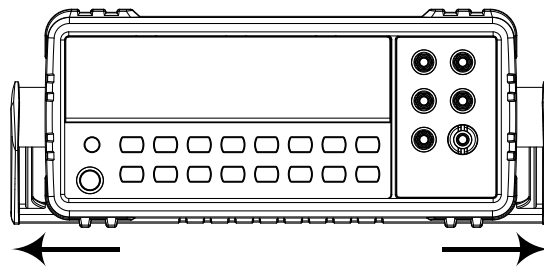

Pull out the handle sideways and rotate it.

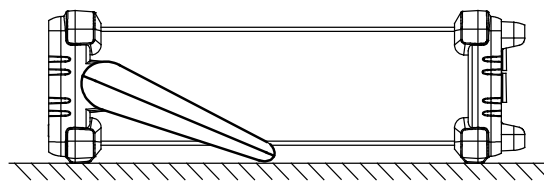

Place the unit horizontally,

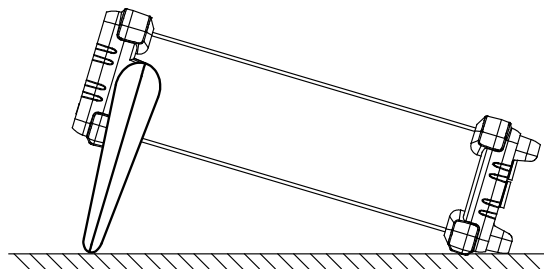

Or in the tilt stand position.

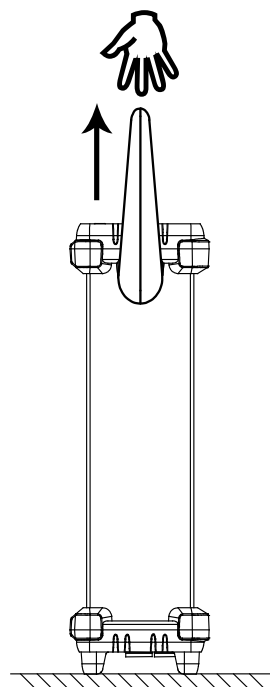

Place the handle vertically for hand carry.

Power Up

Steps

1. Ensure the correct line voltage is lined up with the arrow on the fuse holder. If not, see page 220 to set the line voltage and fuse.

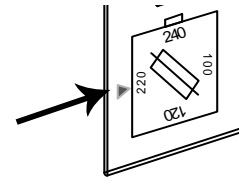

2. Connect the power cord to the AC Voltage input.

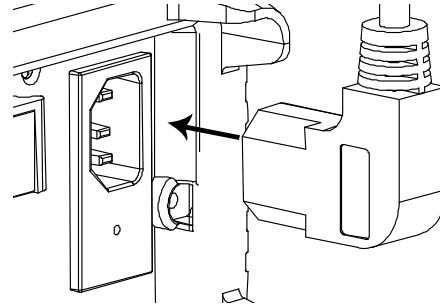

Make sure the ground connector on the power cord is connected to a safety ground. This will affect the measurement accuracy.

3. Push to turn on the main power switch on the front panel.

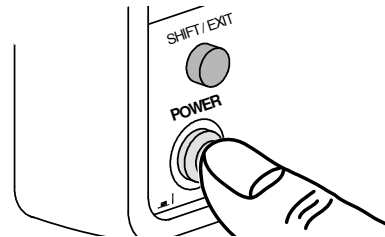

4. The display shows the model name and the version for a few seconds.
Example: GDM-8261A, V1.00

8261A V 1.00

5. Followed by the default measurement settings.

PARA:DEF RECALL

6. And the interface I/O settings.

R5232 1/0

7. Then the default setting appears.
Example: DCV, Auto, 100mV range

DC AUTO S
0048095 m V
*

BASIC MEASUREMENT

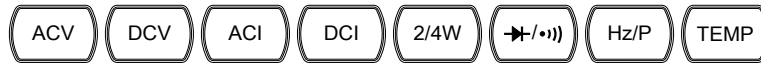

Overview	Basic Measurement Overview	26
	Refresh Rate.....	26
	Reading Indicator	27
	Manual/Automatic Triggering	28
Voltage	AC/DC Voltage Measurement	28
	Select Voltage Range.....	29
	Voltage Conversion Table	31
	Crest Factor Table	32
Current	AC/DC Current Measurement.....	33
	Select Current Range	34
Resistance	2W/4W Resistance Measurement	35
	Select Resistance Range	36
Diode	Diode Test.....	38
Continuity	Continuity Test.....	39
	Set Continuity Threshold	40
Frequency/ Period	Frequency/Period Measurement	41
	Select Frequency/Period Voltage Range	42

continued next page

Temperature	Temperature Measurement	43
	Select Thermocouple Type.....	44
	Set Reference Junction Temperature (T-CUP).....	45
	Select Temperature Sensor Type.....	46
	Set User RTD.....	47

Basic Measurement Overview

Background Basic measurement refers to the eight types of measurements assigned to the upper row keys on the front panel.



Measurement type	ACV	AC Voltage
	DCV	DC Voltage
	ACI	AC Current
	DCI	DC Current
	2/4W	2-wire and 4-wire Resistance
	→/•))	Diode/Continuity
	Hz/P	Frequency/Period
	TEMP	Celsius/Fahrenheit Temperature

Advanced measurement Advanced measurement (page 55) mainly refers to the operation using the result obtained from one or more of the basic measurements.

Refresh Rate

Background Refresh rate defines how frequently the GDM-8261A captures and updates measurement data. A faster refresh rate yields a lower accuracy and resolution. A slower refresh rate yields a higher accuracy and resolution. Consider these tradeoffs when selecting the refresh rate.

For DC measurements, the frequency of the refresh rate depends on the rate settings (S, M, F) and the ADC speed settings (Accurate, Quick) (page 94).



For AC measurements, the refresh rate (S, M, F) is directly tied to the AC bandwidth settings (page 88).

For further details, please see the specifications.

Refresh Rate	Function	S	M	F
(Readings/s)	Continuity / Diode	100	200	300
	DCV/DCI/100Ω~ 100MΩ (Accurate)	5	60	240
	DCV/DCI/100Ω~ 100MΩ (Quick)	30	600	2400
	ACV/ACI	1.2 (sec/reading)	3.38	30
	Frequency / Period	1	10	100

Selection steps

1. Press the Shift key followed by the AUTO (RATE) key. The refresh rate switches to the next.

SHIFT / EXIT  → 
2. The refresh rate indicator shows **S→M→F→S** the current status.

Reading Indicator

Background

The reading indicator * next to the 1st display flashes according to the refresh rate setting.

1.000078 *^v

Manual/Automatic Triggering

Automatic triggering (default) The GDM-8261A triggers according to the refresh rate. See the previous page for refresh rate setting details.

Manual triggering Press the Trig key to trigger measurement manually. The trigger must be set to external (EXT) for manual triggering. See page 78.



AC/DC Voltage Measurement

Voltage type	AC	0 ~ 750V
	DC	0 ~ 1000V

1. Activate ACV/DCV Press the ACV (AC Voltage) key or DCV (DC Voltage) key.



2. ACV/DCV mode display appears

AC AUTO S

004.8095 m V *



100mV

AC or DC + V	Indicates AC, DC voltage
AUTO	Indicates Automatic range selection
100mV	2nd display shows the Voltage range

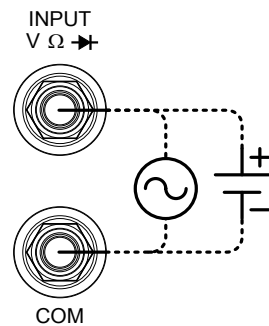
3. Connect the test lead and measure Connect the test lead between the V and the COM port. The display updates the reading.



Select Voltage Range

Auto range	To turn the automatic range selection On/Off, press the AUTO key.																						
Manual range	Press the Up or the Down key to select the range. The AUTO indicator turns Off automatically. If the appropriate range is unknown, select the highest range.	 																					
Selection list	<table border="1"> <thead> <tr> <th>Range</th> <th>Resolution</th> <th>Full scale @ slow rate</th> </tr> </thead> <tbody> <tr> <td>100mV</td> <td>0.1μV</td> <td>119.9999mV</td> </tr> <tr> <td>1V</td> <td>1μV</td> <td>1.199999V</td> </tr> <tr> <td>10V</td> <td>10μV</td> <td>11.99999V</td> </tr> <tr> <td>100V</td> <td>100μV</td> <td>119.9999V</td> </tr> <tr> <td>750V (AC)</td> <td>1mV</td> <td>750.000V</td> </tr> <tr> <td>1000V (DC)</td> <td>1mV</td> <td>1000.000V</td> </tr> </tbody> </table>		Range	Resolution	Full scale @ slow rate	100mV	0.1μV	119.9999mV	1V	1μV	1.199999V	10V	10μV	11.99999V	100V	100μV	119.9999V	750V (AC)	1mV	750.000V	1000V (DC)	1mV	1000.000V
Range	Resolution	Full scale @ slow rate																					
100mV	0.1μV	119.9999mV																					
1V	1μV	1.199999V																					
10V	10μV	11.99999V																					
100V	100μV	119.9999V																					
750V (AC)	1mV	750.000V																					
1000V (DC)	1mV	1000.000V																					
Note:	For more detailed parameters, see the specifications on page 224.																						

DC Voltage Range Note: DC voltages with AC components cannot be accurately measured if the DC+AC component exceed the ADC dynamic range for the selected DC range. Any voltage exceeding the ADC dynamic range will be clipped at the upper/lower range limit. Under these conditions the range that is chosen with the Auto range function may be too small.

Example:

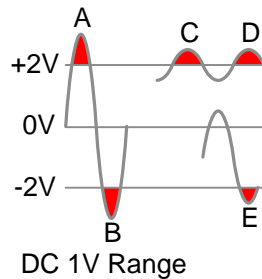

A,B: Input exceeds the ADC dynamic range.

C,D: The DCV offset causes the input to exceed the upper ADC dynamic range.

E: The DCV offset causes the input to exceed the lower ADC dynamic range.





The DC voltage range should be manually selected when any of the following conditions are true:

1. When DCV measurement is used.
2. When the signals being measured contain both DC and AC components.
3. When the amplitude of the AC component in the measured signal is higher or lower than the dynamic range of the range being currently selected by auto-range function.

DCV Voltage Range Selection List	DCV Range	ADC Dynamic Range
	DC100mV	max±200mV
	DC1V	max±2V
	DC10V	max±20V
	DC100V	max±200V
	DC1000V	max±1000V

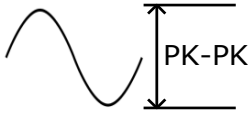
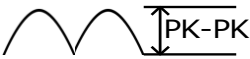
Voltage Conversion Table

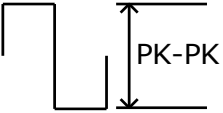
This table shows the relationship between AC and DC reading in various waveforms.

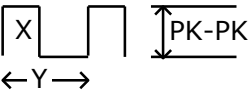
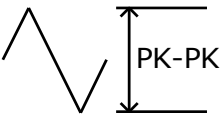





Waveform	Peak to Peak	AC (True RMS)	DC
Sine 	2.828	1.000	0.000
Rectified Sine (full wave) 	1.414	0.435	0.900
Rectified Sine (half wave) 	2.000	0.771	0.636
Square 	2.000	1.000	0.000
Rectified Square 	1.414	0.707	0.707
Rectangular Pulse 	2.000	$2K$ $K = \sqrt{(D - D^2)}$ $D = X/Y$	$2D$ $D = X/Y$
Triangle Sawtooth 	3.464	1.000	0.000

Crest Factor Table

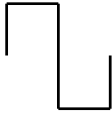
Background Crest factor is the ratio of the peak signal amplitude to the RMS value of the signal. It determines the accuracy of AC measurement.

If the crest factor is less than 3.0, voltage measurement will not result in error due to dynamic range limitations at full scale.

If the crest factor is more than 3.0, it usually indicates an abnormal waveform as seen from the below table.

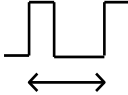
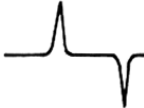
Waveform	Shape	Crest factor
Square wave		1.0
Sine wave		1.414
Triangle sawtooth		1.732
Mixed frequencies		1.414 ~ 2.0
SCR output 100% ~ 10%		1.414 ~ 3.0
White noise		3.0 ~ 4.0
AC Coupled pulse train		>3.0
Spike		>9.0

AC/DC Current Measurement

Background The GDM-8261A has two input ports for current measurement. A 1A terminal for current less than 1.2A and a 10A port for measurements up to 10A.

The GDM-8261A also features a “Current Input Port Auto-Detect” feature (default, off). For details, see page 89.

Current type	AC	0 ~ 10A
	DC	0 ~ 10A

1. Activate ACI/DCI Press the ACI (AC Current) key or the DCI (DC Current) key.  or 

2. ACI/DCI mode display appears



AC or DC + A	Indicates AC or DC Current (Note: AC = true RMS)
AUTO	Indicates Automatic range selection
10A	2nd display shows the Current range

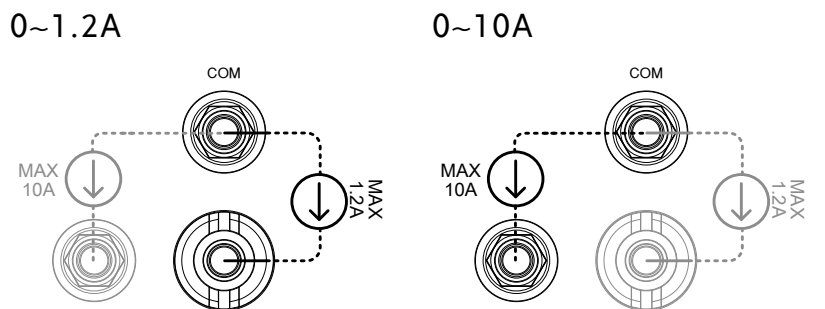

3. Connect the test lead and measure Connect the test lead between the 10A terminal and COM port or DC/AC 1A terminal and COM port, depending on the current.

For current $\leq 1.2A$ use the 1A terminal; For current up to 10A use the 10A port. The display updates the reading.



Select Current Range

Auto range To turn the automatic range selection On/Off, press the AUTO key. 

Manual range Press the Up or the Down key to select the range. AUTO indicator turns Off automatically. If the appropriate range is unknown, select the highest range.  

Selection list	Range	Resolution	Full scale @ slow rate
	100 μ A(DC only)	0.1nA	119.9999 μ A
	1mA	1nA	1.199999mA
	10mA	10nA	11.99999mA
	100mA	0.1 μ A	119.9999mA
	1A	1 μ A	1.199999A
	10A	10 μ A	10.00000A

DC Current Range Note: DC currents with AC components cannot be accurately measured if the DC+AC component exceed the ADC dynamic range for the selected DC range. Any current exceeding the ADC dynamic range will be clipped at the upper/lower range limit. Under these conditions the range that is chosen with the Auto range function may be too small.

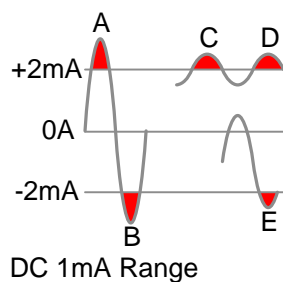

A,B: Input exceeds the ADC dynamic range.

C,D: The DCI offset causes the input to exceed the upper ADC dynamic range.



E: The DCI offset causes the input to exceed the lower ADC dynamic range.

The DC current range should be manually selected when the following conditions are true:

1. When DCI measurement is used.
2. When the signals being measured contain both DC and AC components.
3. When the amplitude of the AC component in the measured signal is higher or lower than the dynamic range of the range being currently selected by auto-range function.

DCI Current Range Selection List	DCI Range	ADC Dynamic Range
	DC 100uA	max±2mA
	DC 1mA	max±2mA
	DC 10A	max±40mA
	DC 100A	max±200mA
	DC 1A	max±1.2A
	DC 10A	max±10A

2W/4W Resistance Measurement

Measurement type	2-wire	Uses the standard V-COM ports. Recommended for measuring resistances larger than 1kΩ.
	4-wire	Compensates the test lead effect using the 4W compensation ports, in addition to the standard V-COM ports. Recommended for measuring sensitive resistances smaller than 1kΩ.
1. Activate resistance measurement	For 2-wire resistance measurement, press the 2W/4W key once.	
	For 4-wire resistance measurement, press the 2W/4W key twice.	 

2. 2W/4W
resistance mode
display appears



2W or 4W + Ω Indicates 2W or 4W Resistance mode

AUTO Indicates Automatic range selection

1K 2nd display shows the Resistance range

3. Connect the
test lead and
measure

Connect the test lead. For 2-wire resistance, use the Ω (V) and the COM port. For 4-wire resistance, use the Ω (V) and the COM port, plus the 4W sense, and LO port for sensing. The display updates the reading.

2W connection

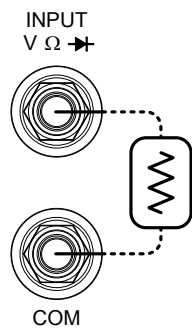

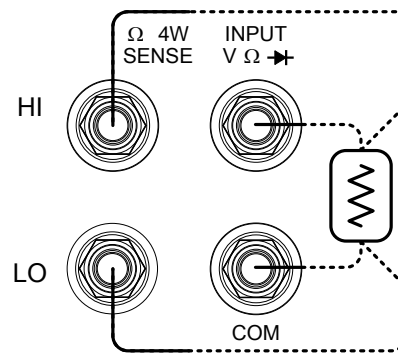

4W connection



Select Resistance Range

Auto range To turn the automatic range selection On/Off, press the AUTO key. 



Manual range Press the Up or the Down key to select the range. AUTO indicator turns Off automatically. If the range is unknown, select the highest range.  

Selection list	Range	Resolution	Full scale @ slow rate
	100Ω	0.1mΩ	119.9999Ω
	1kΩ	1mΩ	1.199999kΩ
	10kΩ	10mΩ	11.99999kΩ
	100kΩ	100mΩ	119.9999kΩ
	1MΩ	1Ω	1.199999MΩ

	10M Ω	10 Ω	11.99999M Ω
	100M Ω	100 Ω	119.99999M Ω
Note	For more detailed range, see the specifications at page 224.		

Diode Test

Background Diode test checks the forward bias characteristics of a diode by running a constant forward bias current, approx. 1mA, through the DUT.

1. Activate diode test Press the  key once. 

2. Diode mode display appears 

 + V Indicates Diode test

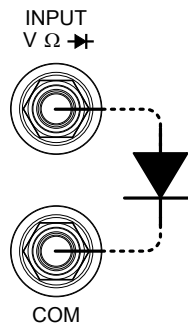

DIODE 2nd display shows the title

3. Connect the test lead and measure Connect the test lead between the  and COM port; Anode-V, Cathode-COM. The display updates the reading.



Continuity Test

Background Continuity test checks that the resistance in the DUT is low enough to be considered continuous (of conductive nature).

1. Activate continuity test Press the  key twice.  

2. Continuity mode display appears

S

OPEN

Ω

* + Ω

Ω

CONT

Ω

Indicates Continuity test

CONT 2nd display shows the title

3. Connect the test lead and measure Connect the test lead between the Ω and the COM port. The display updates the reading.

INPUT
V Ω

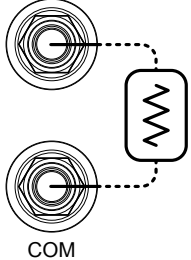



COM



Set Continuity Threshold

Background	Continuity threshold defines the maximum resistance allowed in the DUT when testing the continuity.	
Threshold Range	0 ~ 1000Ω, 1Ω resolution, 10Ω default	
1. Activate threshold setting	<ol style="list-style-type: none"> 1. Press the Shift key, the 2nd key, the Right key. The measurement menu appears. 	
	<ol style="list-style-type: none"> 2. Press the Down key, the Right key, the Enter key. The continuity threshold setting appears. 	
2. Edit threshold	<ol style="list-style-type: none"> 1. Move the cursor (the flashing digit) using the Left/Right key. 	
	<ol style="list-style-type: none"> 2. Change the value using the Up/Down key. 	
Range: 1 ~ 1000Ω, 1Ω resolution, default 10Ω		
3. Go back to the default display	<ol style="list-style-type: none"> Press the Enter key to confirm the edited threshold. Press the Exit key to go back to the default display. 	

Note When Beep setting is activated, per the test result, either PASS (resistance lower than the threshold) or FAIL (resistance higher than the threshold), the beeper will sound off in accordance with its setting. Refer to the page 77 for details of beeper setting.

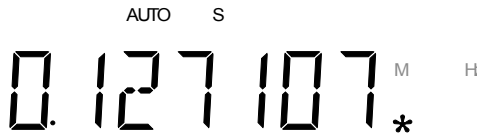

Frequency/Period Measurement

1. Activate frequency/period measurement	To measure Frequency, press the Hz/P key once.	
	To measure the Period, press the Hz/P key twice.	 

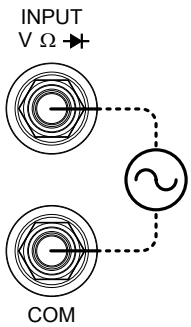

2. Frequency (Period) mode display appears			
	Hz (S)	Indicates Frequency (period) measurement	
	AUTO	Indicates Automatic range selection	
	FREQ (PERIOD)	2nd display shows the measurement mode (PERIOD)	

3. Connect the test lead and measure	Connect the test lead between the V and the COM port. The display updates the reading.	
		<p>INPUT V Ω</p> <p>COM</p>

Select Frequency/Period Voltage Range

Frequency/Period mode To select between period/frequency voltage range, press the 2nd key twice.  

Auto range To turn the automatic range selection On/Off, press the AUTO key. 

Manual range Press the Up or the Down key to select the range. AUTO indicator turns Off automatically. If the appropriate range is unknown, select the highest range.  

Range	Frequency	3Hz~300kHz
	Period	3.3 μ s ~333.3ms
	Voltage Range	100mV~750V



Temperature Measurement

Background The GDM-8261A can measure temperature using either thermocouples or RTD sensors. For thermocouples, the GDM-8261A accepts a thermocouple input and calculates the temperature from the voltage fluctuation. The thermocouple type and reference junction temperature are also considered.

For RTD sensors, the GDM-8261A calculates voltage based on the resistance of the chosen RTD.

1. Activate temperature measurement

For Celsius units, press the TEMP key once. 

For Fahrenheit units, press the TEMP key twice.  

2. Temperature mode display appears



°C Indicates Temperature measurement

TYPE J 2nd display shows the thermocouple/RTD type

3. Connect the test lead and measure

Connect the sensor lead between the V and the COM port for thermocouple and 2W RTD measurements. For 4W RTD measurements, also connect the sense HI and LO ports to the sensor. The display updates the reading.

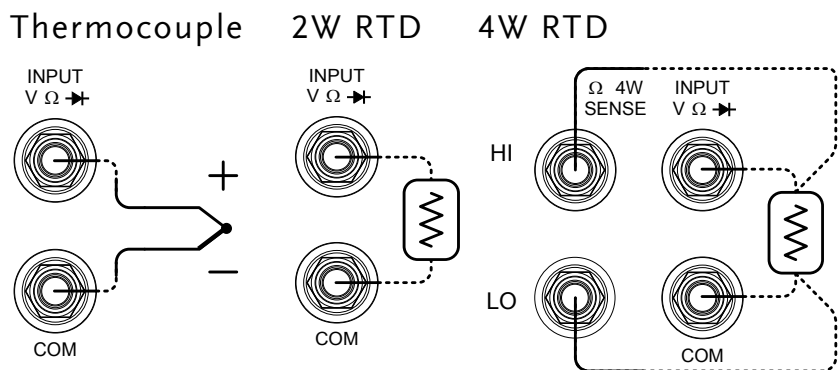

Range RTD: -200°C ~ +600°C (sensor dependent)
 Thermocouple: -210°C ~ +1820°C (sensor dependent)

Select Thermocouple Type

Background The GDM-8261A accepts thermocouple inputs and calculates the temperature from the voltage difference of two dissimilar metals. Thermocouple type and reference junction temperature are also considered.

Parameter	Thermocouple	Range	Resolution
	E	-200 to +1000°C	0.002 °C
	J	-210 to +1200°C	0.002 °C
	T	-200 to +400°C	0.002 °C
	K	-200 to +1372°C	0.002 °C
	N	-200 to +1300°C	0.003 °C
	R	-50 to +1768°C	0.01 °C
	S	-50 to +1768°C	0.01 °C
	B	+350 to +1820°C	0.01 °C

1. Open sensor selection menu Press the Shift key, then the TEMP (Sensor) key. The sensor selection menu appears on the display.

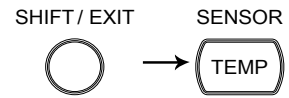

T-CUP LEVEL 1

2. Select sensor type Press the Left and Right arrow keys and select T-CUP (thermocouple).



T-CUP ↔ 2WRTD ↔ 4WRTD

3. Select sensor Press the Down key twice. The sensor selection menu appears on the display.



TYPE J SENSOR

4. Select sensor type Press the Up/Down key. The thermocouple type switches to the next one.



U ↔ K ↔ N ↔ R ↔ S ↔ T ↔ B ↔ E

5. Confirm and go back to the default display

Press the Enter key to confirm.
Press the Exit key to go back to the default display.

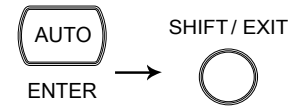

Set Reference Junction Temperature (T-CUP)

Background

When a thermocouple is connected to the GDM-8261A, the temperature difference between the thermocouple lead and the GDM-8261A input terminal should be taken into account and be cancelled; otherwise an erroneous temperature might be added.

Type	Range	Resolution
SIM (simulated)	0 ~ +50°C	0.01°C

The terminal temperature is manually defined by the user.
Default value: 23.00

1. Open reference junction menu

Press the Shift key, then the TEMP (Sensor) key. The sensor selection menu appears on the display.

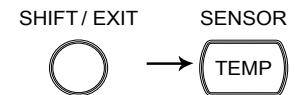

T-CUP LEVEL 1



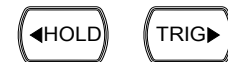



Press the Left and Right arrow keys and select T-CUP (thermocouple).



Press Down, Right arrow key and then Down again. The reference junction selection menu appears on the display.





23.00 SIM

2. Edit reference temperature Use the Left/Right key to move the cursor, and use the Up/Down key to change the value.  
 
 Default: 23.00
- Press the Enter key to confirm the value, or the Exit key to cancel. The display goes back to the previous menu.  ENTER (confirm)
 SHIFT/EXIT  (cancel)



Select Temperature Sensor Type

Background The GDM-8261A supports a number of thermocouple types as well as 2 or 4 wire RTD. It is important to specify the type of temperature sensor used.

Parameter	RTD type	Range	Resolution
	All (based on PT100)	-200~600°C	0.001°C

1. Open sensor selection menu Press the Shift key, then the TEMP (Sensor) key. The sensor selection menu appears on the display.  → 

T-CUP LEVEL 1

2. Select sensor type Press the Left and Right arrow keys to highlight the 2WRTD or 4WRTD sensor type. Press the down key to go to the next menu level.  
 → 

T-CUP ↔ 2WRTD ↔ 4WRTD

3. Select sensor Press the Up and Down keys to highlight the RTD sensor type.
 RTD Type: PT 100, PT 3916, PT 385, F 100, D 100, USER



PT 100 TYPE

4. Confirm and go back to the default display Press the Enter key to confirm.
 Press the Exit key to go back to the default display.

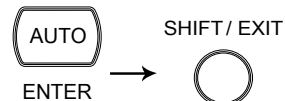

Set User RTD

Background The USER setting allows any custom RTD sensor coefficients to be used. The USER setting can configure the alpha, beta and delta coefficients, as defined by the Callendar–Van Dusen equation.

Coefficient range	
Alpha	0.000000~10.000000
Beta	0.000000~10.000000
Delta	0.000000~10.000000

1. Open sensor selection menu Press the Shift key, then the TEMP (Sensor) key. The sensor selection menu appears on the display.

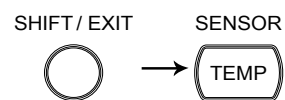

T-CUP LEVEL 1

2. Select sensor type Press the Left and Right arrow keys and select 2WRTD or 4WRTD



T-CUP ⇄ 2WRTD ⇄ 4WRTD

Press the Down key twice. The RTD selection menu appears on the display.



Use the Up/Down keys to select USER.



USER TYPE

3. Open USER type menu

Press Enter. The alpha coefficient menu appears on the display.



0000385 ALPHA

4. Edit coefficient values

Use the Left/Right key to move the cursor, and use the Up/Down key to change the coefficient value.

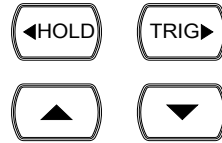

Default: 0.00385

Press the Enter key to confirm the value and move onto to the next coefficient.

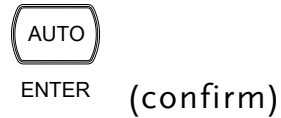

Default: Alpha 0.00385, Beta 00.10863, Delta 1.49990

Press the Exit key to cancel at any time. The display goes back to the previous menu.



DUAL MEASUREMENT

Dual Measurement

Background

The dual measurement mode allows you to use the 2nd display to show another item, thus viewing two different measurement results at once.

When the multimeter is used in dual measurement mode, both displays are updated from either a single measurement or from two separate measurements.

If the primary and secondary measurement modes have the same range, rate and rely on the same fundamental measurement, then a single measurement is taken for both displays; such as ACV and frequency/period measurements.

If the primary and secondary displays use different measurement functions, ranges or rates, then separate measurements will be taken for each display. For example, ACV and 2W/4W resistance measurements.

Example Dual Measurement Applications

Combination

Applications

DCV ACV

- Measure DC signals that have AC components*.
For example:
Measure the DC offset and AC noise from an amplifier output.
Measure the DC output voltage and ripple from a DC power supply.
- * Ripple or the AC noise frequency must be within the DMM's measurable AC bandwidth for the noise to be measured.

Amplifier Output

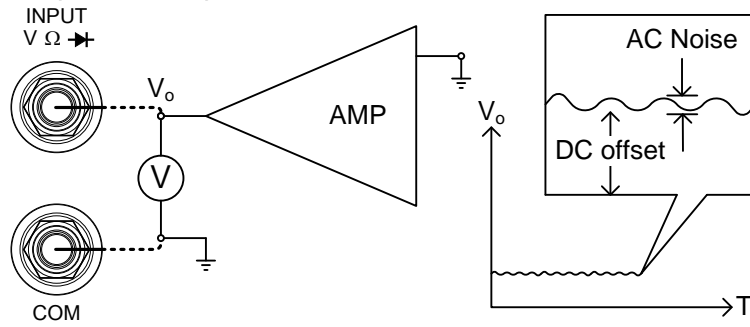

DC Power Supply Output

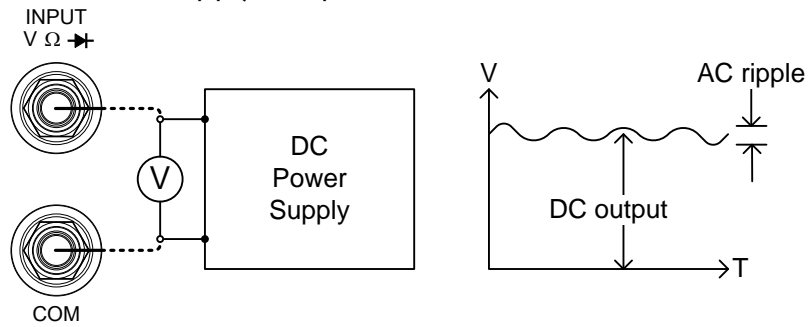

- DCV DCI • Monitor the voltage and current present on a component in a circuit or the output voltage and current of a DC power supply.

Monitor Voltage and Current

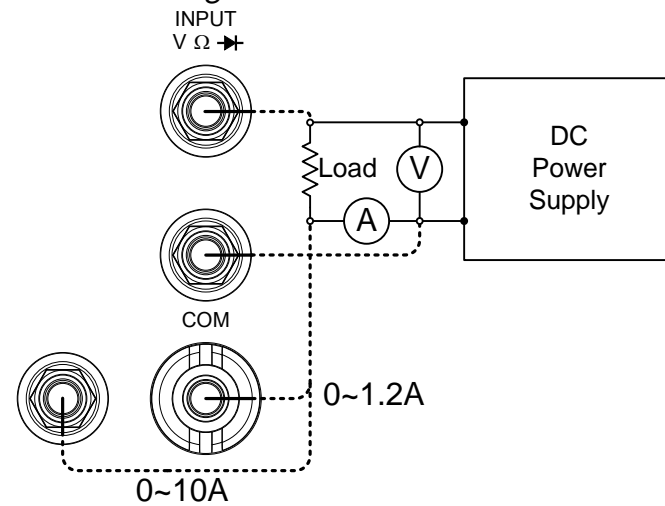

- ACV Hz • Measure the frequency response of devices such as amplifiers or buffers*.

* The frequencies of the amplifier output must be within the DMM's measurable AC bandwidth for the amplitude at a spot frequency to be measured accurately.

Frequency Response

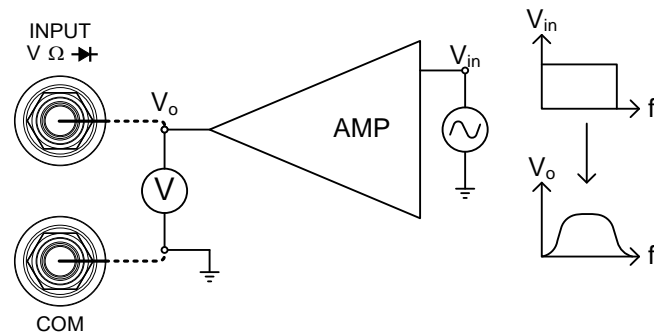

The following table shows the available measurement combinations.

1st Display ^[2]	2nd Display ^[2]					
	ACV	DCV	ACI	DCI	Hz/P	2W/4W ^[1]
ACV	•	•	•	•	•	—
DCV	•	•	•	•	•	—
ACI	•	•	•	•	•	—
DCI	•	•	•	•	•	—
Hz/P	•	•	•	•	•	—
2W/4W ^[1]	—	—	—	—	—	•

- Note**
- [1] 2W/4W measurements in combination with other measurements are possible but may not be practical as the measurement accuracy is not guaranteed.
 - [2] When two different measurements are taken, there is a switching delay between the first measurement and the second measurement.

1st Measurement item setting Choose a basic measurement from the above table. Example: press the ACI key. Page 24
Example: ACI

2nd Measurement item setting

Press the 2nd key, then the target item (example: ACV). The display updates the measurement result. (example: ACI + ACV)

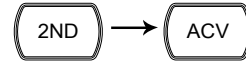

1st Display Shows the primary measurement result

2nd Display Shows the secondary measurement result

2ND Indicates that dual measurement is active

Editing 1st or 2nd measurement item settings

After the secondary measurement function has been activated, the rate, range and measurement item can be edited for either the primary or secondary display. Note however, it is more practical to configure the first or second measurement items before activating dual measurement mode.

1. Select active display

Toggle whether the primary or secondary display is the active display by pressing the 2ND key:

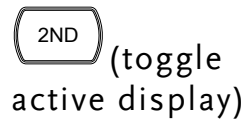

Primary display: 2ND is not visible on the display

Secondary display: 2ND is visible on the display

Do not hold the 2ND key. This will turn the dual measurement off.

2. Edit active display settings

Edit the range, rate or measurement item for the active display in the same way as for single measurement operation. See the Basic Measurement chapter for details. Page 24

Turn Off 2nd Measurement

To turn Off the 2nd measurement, press and hold the 2nd key for more than 1 second.

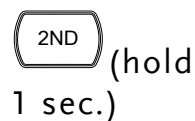

Connect the test leads and measure

When using the dual measurement function, the connection method and number of test leads required depends on the measurement combination. Use the connect diagrams below as guide when taking dual measurements.

Voltage and Frequency/Period Measurement

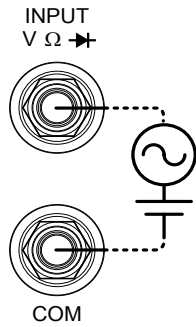

2W/4W Resistance Measurement

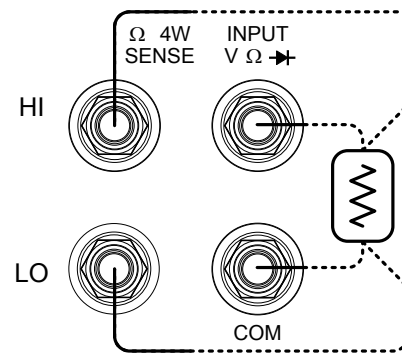

Voltage/Frequency/Period and Current Measurement

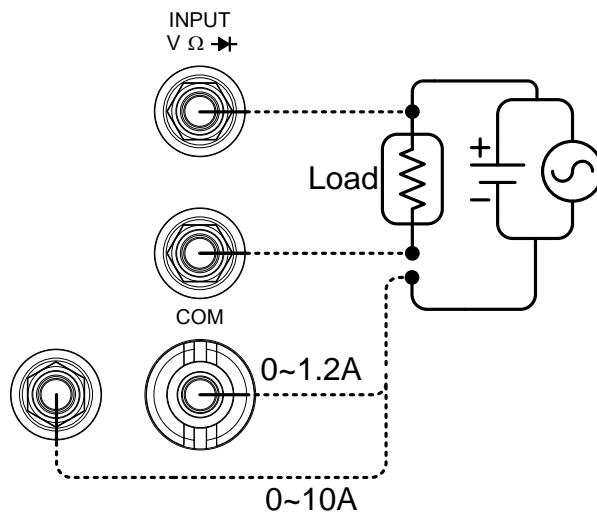

Note: DC Current measurements will be displayed as a negative value as the polarity of the current leads has been reversed.

Please take into account the resistance of the test leads and internal resistance of the current connection as it is in series with the test circuit.

The above measuring configuration is used to measure the voltage present on the resistance under test and the current through the resistance under test when using the DCI/DCV or ACI/ACV dual measurement function.

ADVANCED MEASUREMENT



Overview	Advanced Measurement Overview56
	Refresh Rate56
	Reading Indicator57
	Common Attribute: Manual/Automatic Triggering .57
<hr/>	
dBm/dB	dBm/dB/W Measurement58
	Measure dBm/W58
	Measure dB59
<hr/>	
Max/Min	Max/Min Measurement.....61
<hr/>	
Relative	Relative Value Measurement 62
<hr/>	
Hold	Hold Measurement64
<hr/>	
Compare	Compare Measurement65
<hr/>	
Math	Measure MX+B.....68
	Measure 1/X.....70
	Measure Percentage70
	Statistics Calculations71

Advanced Measurement Overview

Background Advanced measurement mainly refers to the type of measurement which uses the result obtained by one of the basic measurements: ACV, DCV, ACI, DCI, 2/4W, Diode/Continuity, Frequency/Period, and Temperature.



Advanced Measurement	Basic Measurement					→/•/•)
	AC/DCV	AC/DCI	2/4W	Hz/P	TEMP	
dB	●	—	—	—	—	—
dBm	●	—	—	—	—	—
Max/Min	●	●	●	●	●	—
Relative	●	●	●	●	●	—
Hold	●	●	●	●	●	—
Compare	●	●	●	●	●	—
Math	●	●	●	●	●	—

Refresh Rate

Background Refresh rate defines how frequently the GDM-8261A captures and updates measurement data. A faster refresh rate yields a lower accuracy and resolution. A slower refresh rate yields a higher accuracy and resolution. Consider these tradeoffs when selecting the refresh rate.

For DC measurements, the frequency of the refresh rate depends on the rate settings (S, M, F) and the ADC speed settings (Accurate, Quick) (page 94).

For AC measurements, the refresh rate (S, M, F) is directly tied to the AC bandwidth settings (page 88).

For further details, please see the specifications.

Refresh Rate (Readings/s)	Function	S	M	F
	Continuity / Diode	100	200	300
	DCV/DCI/100Ω~ 100MΩ (Accurate)	5	60	240
	DCV/DCI/100Ω~ 100MΩ (Quick)	30	600	2400
	ACV/ACI	1.2 (sec/reading)	3.38	30
	Frequency/Period	1	10	100

Selection steps

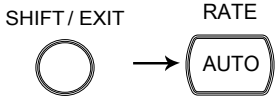
1. Press the Shift key followed by the AUTO (RATE) key. The refresh rate switches to the next. 
2. The refresh rate indicator shows **S→M→F→S** the current status.

Reading Indicator

Background The reading indicator * next to the 1st display flashes according to the refresh rate when the captured data is updated on the display.

0048095_{m v}
*

Common Attribute: Manual/Automatic Triggering

Automatic triggering (default) The GDM-8261A triggers according to the refresh rate. See the previous page for refresh rate setting details.

Manual triggering Press the Trig key to trigger the measurement manually. The trigger must be set to external (EXT) for manual triggering. See page 78. 

dBm/dB/W Measurement

Applicable to ACV DCV

Background Using the ACV or DCV measurement result, the GDM-8261A calculates the dB, dBm or W value based on a reference resistance value in the following way.

dBm	$10 \times \log_{10} (1000 \times V_{\text{reading}}^2 / R_{\text{ref}})$
-----	---

dB	$\text{dBm} - \text{dBm}_{\text{ref}}$
----	--

W	$V_{\text{reading}}^2 / R_{\text{ref}}$
---	---

Parameters	Vreading	Input Voltage, ACV or DCV
	Rref	Reference resistance simulating an output load
	dBmref	Reference dBm value

Measure dBm/W

Activate dBm Press the Shift key followed by the  key. The 1st display shows dBm, and the 2nd display shows the reference resistance.

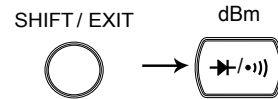

dBm result appears



dBm	Indicates dBm measurement
-----	---------------------------

600Ω	2nd display indicates the reference resistance
------	--

Select reference resistance To change the reference resistance, press the Up/Down key. The new resistance appears in the 2nd display. The following is the resistance list.



2	4	8	16	50	75	93
110	124	125	135	150	250	300
500	600	800	900	1000	1200	8000

View result in Watts When the reference resistance is less than 50Ω, it is possible to calculate the watt value. If the reference resistance is greater than 50Ω then this step can be ignored.

To calculate the power, press the Shift key followed by the $\rightarrow/(\cdot)$ key again.

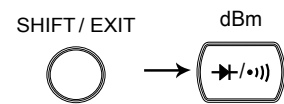

Watt result appears

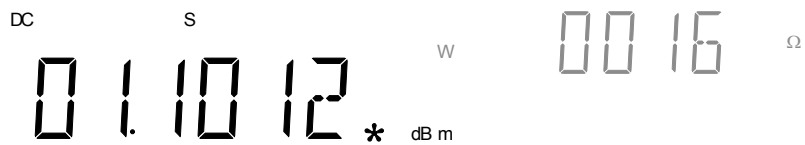

W Indicates W measurement
16Ω 2nd display indicates the reference resistance

Deactivate dBm/W measurement

To cancel the dBm/W measurement, press the Shift key followed by the $\rightarrow/(\cdot)$ key, or simply activate another measurement.

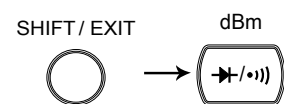

Measure dB

Background dB is defined as [dBm-dBmref]. When the dB measurement is activated, the GDM-8261A calculates the dBm using the reading at the first moment and stores it as dBmref.

Activate dB

Press the Shift key followed by the Hz/P key. The 1st display shows dB, and the 2nd display shows the current Voltage reading.

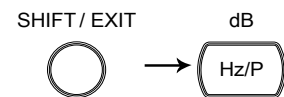

dB result appears ^{DC} ^S --00.617 mV
016.1812 * dB

dB Indicates dB measurement

-00.617mV Indicates the present Voltage reading

dBmref Press the 2nd key to see the dBm ref value.



Deactivate dB measurement To cancel the dB measurement, press the Shift key followed by the Hz/P key, or simply activate another measurement.

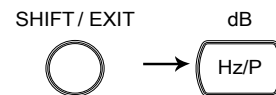

Max/Min Measurement

Applicable to		
Background	Maximum and Minimum measurement stores the highest (maximum) or lowest (minimum) reading and shows it on the 1 st display when the 2 nd key is pressed.	
1. Activate Max/Min	For Max measurement, press the MX/MN key once.	
	For Min measurement, press the MX/MN key twice.	
2. Max (Min) result is activated		
	MIN (MAX)	Indicates Min (Max) measurement is activated
	1V	2nd display shows the Min (Max) range
View Max (Min) value	Press the 2 nd key to view the Max (Min) value.	
Max (Min) measurement appears		
	2nd display	Indicates that the Max (Min) value is displayed on the 1st display
	1st display	Shows the Max (Min) value at full scale
Deactivate Max/Min measurement	To cancel the Max/Min measurement, press the MX/MN key for 2 seconds, or simply activate another measurement.	(hold for 2 seconds)

Relative Value Measurement

Applicable to



Background

Relative measurement stores a value, typically the data at the moment, as the reference. The following measurement is shown as the delta between the reference. The reference value will be cleared upon exit.

1. Activate Relative measurement

Press the REL key. The measurement reading at the moment becomes the reference value.



2. Relative measurement display appears



REL Indicates Relative value measurement

2nd display Shows the measurement range.

1st display Shows the delta between the current measurement data and the reference value

View reference (REL) value

Press the 2nd key to view the reference (REL) value.



Reference (REL) measurement display appears



2nd display Indicates that the reference (REL) value is displayed on the 1st display

1st display Shows the reference (REL) value at full scale

Manually set the reference value

1. To set the reference (REL) value manually, press the Shift key followed by the REL key. The setting appears.

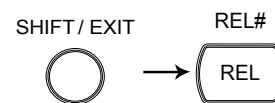

0.9364 13 v REL

REL Indicates Relative measurement

1st display Shows the reference value (to full scale)

2nd display Indicates Relative value modification

2. Use the Left/Right key to move the flashing point (cursor), and use the Up/Down key to change the value.

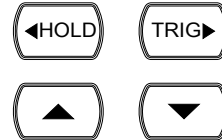

3. Press the Enter key to confirm the value, or the Exit key to cancel. The display switches to measurement.

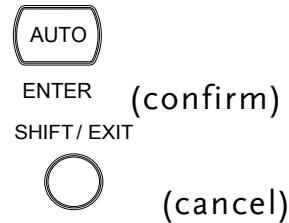

Deactivate Relative measurement To cancel the Relative measurement, press the REL key again, or simply activate another measurement.



Hold Measurement

Applicable to ACV DCV ACI DCI 2/4W Hz/P TEMP

Background The Hold Measurement function retains the current measurement data and updates it only when it exceeds the set threshold (as a percentage of the retained value).

1. Activate Hold measurement Press the Hold key. ◀HOLD

2. Hold measurement display appears

AC S HOLD

10776 10.* V

1 0 / 0

HOLD Indicates Hold measurement

2nd display Shows the Hold threshold

1st display Shows the measurement data.

3. Select hold threshold Select the hold threshold using the Up/Down key. The 2nd display changes accordingly. ▲ ▼

Range 0.01%, 0.1%, 1%, 10%

Deactivate Hold measurement To cancel the Hold measurement, press the Hold key for 2 seconds, or simply activate another measurement. ◀HOLD

Compare Measurement

Applicable to



Background

Compare measurement checks and updates if the measurement data stays between the upper (high) and lower (low) limit specified.

1. Activate Compare measurement

Press the Shift key, then the Hold (Comp) key.

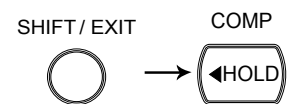

2. High limit setting



1st display Shows the high limit value

2nd display Indicates high limit setting

1. Use the Left/Right key to move the cursor (flashing point) between high/low setting, digits, and decimal point.

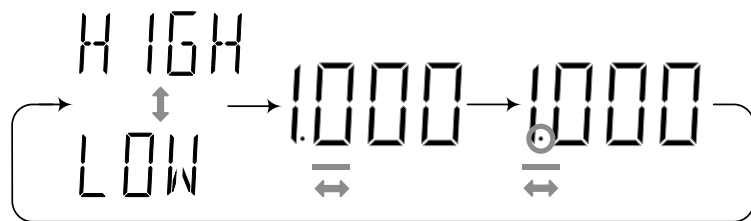

2. Change the parameter using the Up/Down key.



3. Press the Enter key to confirm editing and move to the low limit setting.



3. Low limit setting



1st display Shows the low limit value

2nd display Indicates low limit setting

- Use the Left/Right key to move the cursor (flashing point) between high/low setting, digits, and decimal point.

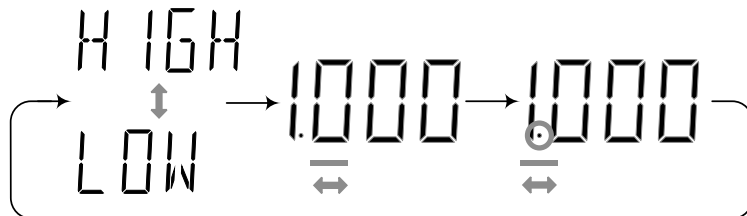

- Change the parameter using the Up/Down key.

- Press the Enter key to confirm editing. The compare measurement starts right away.

4. Compare measurement appears



COMP Indicates Compare mode

2nd display Shows the compare measurement result: Pass, High, or Low.

5. Result	High	If the 2nd display shows High, the result is above the High limit. HIGH
		Digital I/O: FAIL Out (Pin 6) and HIGH Limit FAIL Out (Pin 7) are activated.
	Low	If the 2nd display shows Low, the result is below the Low limit. LOW
		Digital I/O: FAIL Out (Pin 6) and LOW Limit FAIL Out (Pin 8) are activated.
	Pass	If the 2nd display shows Pass, the result is staying between the High and the Low limit. PASS
		Digital I/O: PASS Out (Pin 5) is activated.

Digital I/O The Compare measurement result comes out from the rear panel Digital I/O terminal. For the terminal details, see page 130.

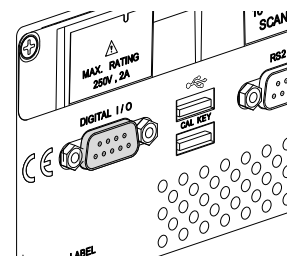

Deactivate Compare measurement To cancel the Compare measurement, press the Shift key followed by the Hold (Comp) key, or simply activate another measurement.

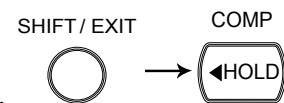

! Note When Beep setting is activated, per the test result, either PASS (measurement within the set high and low limits) or FAIL (measurement higher or lower than the set high or low limits), the beeper will sound off in accordance with its setting. Refer to the page 77 for details of beeper setting.

Math Measurement

Applicable to	<div style="display: flex; justify-content: space-around; align-items: center;"> <div style="border: 1px solid black; border-radius: 10px; padding: 2px 5px;">ACV</div> <div style="border: 1px solid black; border-radius: 10px; padding: 2px 5px;">DCV</div> <div style="border: 1px solid black; border-radius: 10px; padding: 2px 5px;">ACI</div> <div style="border: 1px solid black; border-radius: 10px; padding: 2px 5px;">DCI</div> <div style="border: 1px solid black; border-radius: 10px; padding: 2px 5px;">2/4W</div> <div style="border: 1px solid black; border-radius: 10px; padding: 2px 5px;">Hz/P</div> <div style="border: 1px solid black; border-radius: 10px; padding: 2px 5px;">TEMP</div> </div>					
Background	Math measurement runs four types of mathematical operations, MX+B, 1/X, Percentage and Stats, based on the other measurement results.					
Math type	MX+B	Multiplies the reading (X) by the factor (M) and adds/subtracts offset (B).				
	1/X	Inverse. Divides 1 by the reading (X).				
	Percentage	Runs the following equation.				
		$\frac{(\text{Reading}X - \text{Reference})}{\text{Reference}} \times 100\%$				
	Stats	Performs standard deviation calculations on measurement data.				

Measure MX+B

1. Activate MX+B Press the Shift key followed by the 2/4W (Math) key. The MX+B setting appears.

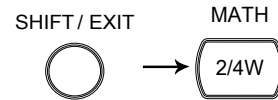

2. Set the factor (M)





MX+B

1st display Shows the factor (M)

2nd display Indicates MX+B (The letter M flashes)

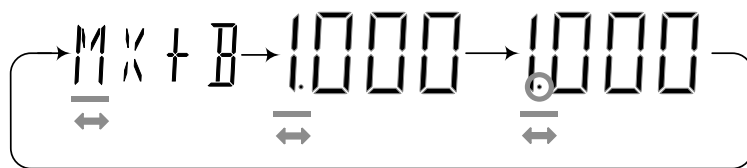
1. Use the Left/Right key to move the cursor (flashing point) between the factor, digits, and decimal point.



2. Change the parameter using the Up/Down key.  



3. Press the Enter key to confirm editing and move to offset setting. 

3. Set the offset (B)





1st display Shows the offset (B)

2nd display Indicates MX+B (The letter B flashes)

1. Use the Left/Right key to move the cursor (flashing point) between the offset, digits and decimal point.  



2. Change the parameter using the Up/Down key.  

3. Press the Enter key to confirm the editing. The MX+B measurement result appears. 

4. View MX+B



1st display Shows the calculated result

2nd display Indicates MX+B

MATH Indicates Math operation

Measure 1/X

1. Activate 1/X

Press the Shift key, the 2/4W (Math) key, the Down key twice. The 1/X setting appears.

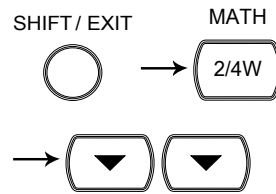

INVERSE

1/X

2. View 1/X

Press the Enter key to view the 1/X measurement result.



AC AUTO S
01.13870 * V

1/X
MATH

1st display Shows the 1/X value

2nd display Indicates 1/X

MATH Indicates Math operation

Measure Percentage

1. Activate Percentage

Press the Shift key, the 2/4W (Math) key, the Up key twice. The Reference setting appears. The Percentage is calculated as:

$$\frac{[\text{Reading} - \text{Reference}]}{\text{Reference}} \times 100\%$$

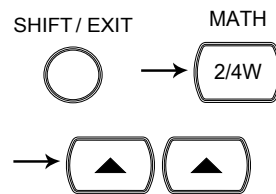

2. Set the reference number

0.00000000

REF 0/0

1st display Shows the reference number

2nd display Indicates Percentage setting

1. Use the Left/Right key to move the cursor (flashing point) between the digits and decimal point. 

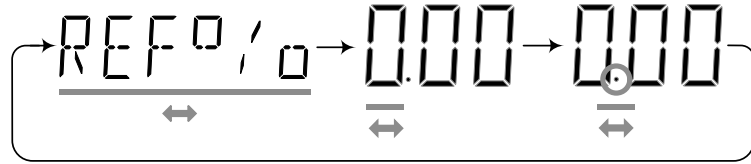

2. Change the parameter using the Up/Down key. 

3. Press the Enter key to confirm editing. 

3. View Percentage



1st display	Shows the calculated result
2nd display	Indicates the Percentage measurement
MATH	Indicates Math operation

Statistics Calculations

Background The Analyze Stats menu allows you to make statistical calculations on a continuous or user-defined number of measurement counts. The measurements supported include, Maximum, Minimum, Average and Standard deviation.

Number of counts	User Defined	2~100,000 counts
	Continuous	9,999,999 count

1. Activate Statistics

Press the Shift key, the 2/4W (Math) key, the Up key. The Analyze Stats setting menu appears.

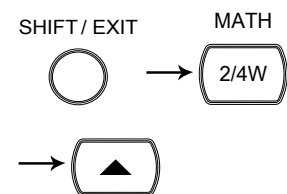

ANALYZE

STATS

2. Set Count

Press the Enter key to set the number of measurements (counts) that will be used for the Stats function. The Count menu appears.



CONTINU

COUNT

1st display Shows the count number as continuous

2nd display Indicates the count setting

2a. Continuous count

1. To set the count to Continuous and to start measurement, press Enter when CONTINU is displayed on the 1st display.
2. Measurement starts automatically.



2b. User-defined count

1. To set a user-defined count number, press the Left key followed by Up when CONTINU is displayed on the screen. The Count setting menu will appear.

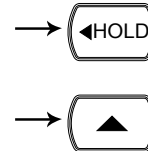

00000002

COUNT

1st display Shows the count number (2~100,000)

2nd display Indicates the count setting

2. Use the Left/Right key to move the flashing point (cursor), and use the Up/Down key to change the count number.

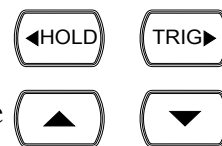

3. Press the Enter key to confirm editing and to start measurement.



3. View Data



1st display	Shows the current count number/measurement
2nd display	Indicates the count measurement mode.
MATH	Indicates Math operation

Press the 2nd key to cycle through the different statistical data measurements.



COUNT	Indicates the current measurement count
MIN	Indicates the minimum data value
MAX	Indicates the maximum data value
AVG	Indicates the mean (average) value
STDEV	Indicates the standard deviation of the data

Stop/Restart Measuring

Press the SHIFT key for 2 seconds to stop or restart measuring.



(hold for 2 seconds)

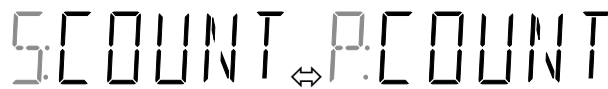

S:	Indicates the measurement has started
P:	Indicates the measurement has stopped

Exit

Press the SHIFT key and the 2/4W key to exit.

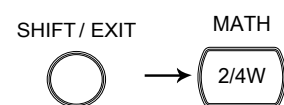

SYSTEM/DISPLAY CONFIGURATION



Refresh Rate	Refresh Rate Setting 76
	View Serial Number 76
	Select Beeper Setting 77
Trigger	Manual/Automatic Triggering 78
	Use External Trigger 78
	Set Trigger Delay 80
Filter Settings	Digital Filter Overview 81
	Digital Filter Setting 82
	Analog Filter Settings 84
Display	Display Light Setting 85
Measurement Configuration Settings	D-Shift Settings 86
	Input Resistance Setting 87
	AC Bandwidth Setting 88
	Current Input Port Auto-Detect Setting 89
ADC Settings	Auto-Zeroing 90
	Auto-Gain 92
	ADC Speed Setting 94
Frequency/Period settings	Input Port Selection 95
	Gate Time Setting 97

Identification Settings	Changing the Identification String	98
-------------------------	--	----

Refresh Rate Setting

Background Refresh rate defines how frequently the GDM-8261A captures and updates the measurement data. A faster refresh rate yields a lower accuracy and resolution. Slower refresh rates yield a higher accuracy and resolution. Consider this trade-off when selecting the refresh rate.

The refresh rate settings are individually set for all measurement modes except for ACV/ACI measurements. ACV/ACI use the same refresh rate settings.

Display/Range	<div style="display: flex; justify-content: space-between; align-items: center;"> AC S 10A </div> <div style="text-align: center; font-size: 2em; font-family: monospace;"> 0 1.13870 * </div> <div style="text-align: center; margin-top: 5px;"> S 6 ½ digits </div> <hr/> <div style="text-align: center;"> M 5 ½ digits </div> <hr/> <div style="text-align: center;"> F 4 ½ digits </div>
---------------	---

Refresh rate selection Press the Shift key followed by the AUTO (Rate) key. The refresh rate indicator switches to the next rate setting.

SHIFT/EXIT

→

RATE



Refresh Rate **S→M→F→S**

View Serial Number

Background View the serial number using the System menu.

Panel operation

- Press the Shift key, the 2nd (Menu) key, followed by the down key. Then press the left key repeatedly until the S/N menu appears.

SHIFT/EXIT



→

MENU

→ 

→ 



S/N LEVEL2

2. Press the Down key. The serial number is shown on the display. 

SN: AB 000000

1st display Shows 2 characters (AA~ZZ).



2nd display Shows 6 numbers (000000~99999).

3. Press the Enter key or the Exit key to go back to the previous display.  or 

Select Beeper Setting

Background Beeper setting defines how the GDM-8261A notifies the continuity test result to the user. When the Beeper setting is off it will also turn the keypad sound off.

Beeper parameter	Pass	Beeps when the test result is pass
	Fail	Beeps when the test result is fail
	Off	Beep function is turned Off

1. Activate beeper setting menu
1. Press the Shift key followed by the 2nd (Menu) key. The system menu appears.  → 



SYSTEM LEVEL1

2. Press the Down key. The beep menu appears. 



BEEP LEVEL2

3. Press the Down key. The beep setting appears. 

PASS LEVEL3

2. Select the beep setting To change the setting, press the Up/Down key.  

Beeper type: Pass (beep when pass), Fail (beep when fail, default), Off (beep off)

3. Go back to the default display Press the Enter key to confirm. Press the Exit key to go back to the default display.  → 

Trigger Setting

Manual/Automatic Triggering

Automatic triggering (default) The GDM-8261A triggers according to the refresh rate. See the previous page for refresh rate setting details.

Manual triggering Press the Trig key to trigger measurement manually. See below for details. 

Use External Trigger

Background The GDM-8261A uses the internal trigger by default, for example to count the frequency and the period. Using an external trigger allows customized triggering conditions.

Signal connection Connect the external trigger signal to the Digital I/O port located on the rear panel.

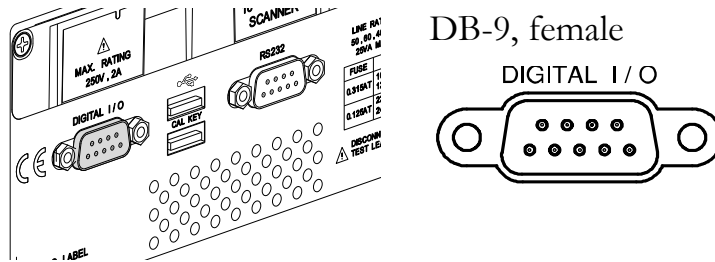

Digital I/O pin assignment

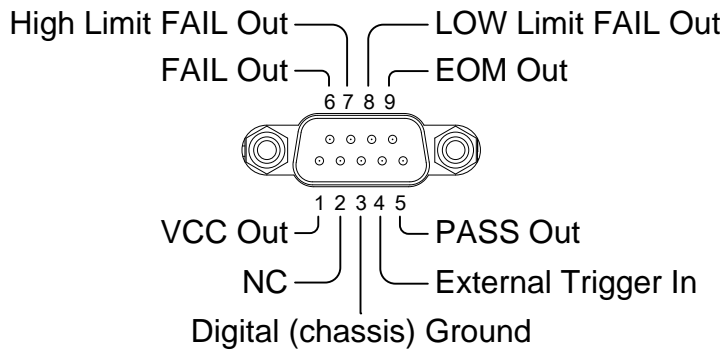

1. Activate external trigger

Press the Shift key followed by the Trig (Int/Ext) key. The EXT indicator appears on the display.

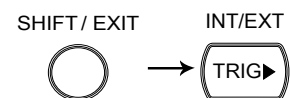

PERIOD

EXT

2. Start trigger

Press the Trig key to start triggering manually. The * indicator turns On.



AC AUTO S

054.5527 m V *

Reading indicator The reading indicator * does not flash before triggering (can be on or off). After triggering, the indicator flashes according to the external signal trigger timing.





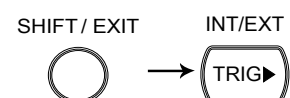

Exit external trigger

Press the Shift key followed by the Trig key. The EXT indicator disappears and the trigger goes back to internal mode.

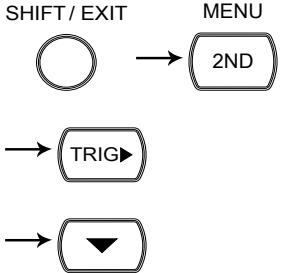

Set Trigger Delay

Background Trigger delay defines the time delay between triggering and measurement start. The default is set at 10ms.

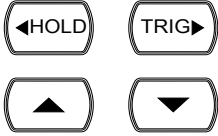
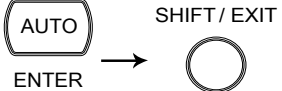
Panel operation	<p>1. Press the Shift key, the 2nd (Menu) key, the Right key, the Down key. The delay menu appears.</p>	
		
	<p>2. Press the Down key. The delay setting appears.</p>	
		
	<p>3. Move the flashing point (cursor) using the Left/Right key. Change the value using the Up/Down key.</p>	
	<p>4. Press the Enter key to confirm editing and press the Exit key. The display goes back to previous mode.</p>	
	<p>Range 0 ~ 9999ms, 1ms resolution</p>	

Filter Setting

Digital Filter Overview

Filter basics The GDM-8261A's internal digital filter converts the analog input signal into digital format before passing it to internal circuits for processing. The filter affects the amount of noise included in the measurement result.

Filter type The digital filter averages a specific number of input signal samples to generate one reading. The filter type defines the averaging method. The following diagrams highlight the differences between the Moving and Repeating filter using 4 samples per reading.

Moving (default) The Moving filter takes in one new sample and discards the oldest sample per reading. This is the default behavior when the digital filter is not specified, and is recommended for most applications except for the optional scanner operation (page 105).

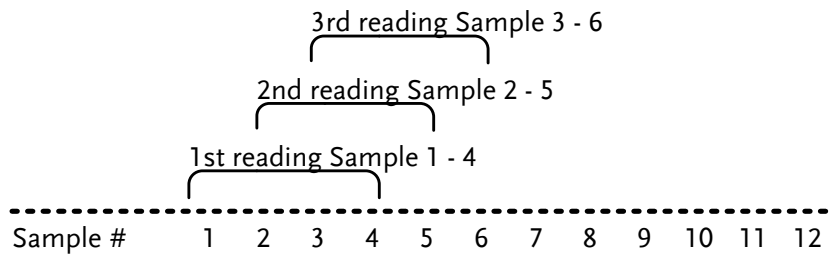

Repeating The Repeating filter renews a whole group of samples per reading. This method is recommended when using the optional scanner (page 105).

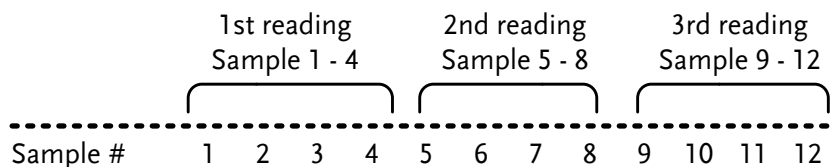

Filter count Filter count defines the number of samples to be averaged per reading. More samples offer low noise but a long delay. Less samples offer high noise but a short delay.

Range 2 ~ 100

Filter window Filter window defines the threshold for when the digital filter data is updated again. When the AD data falls in the range between TH and TL, the filter keeps processing. When the AD data falls out of the range between TH and TL, the filter will restart. When measuring unstable signals, appropriately setting the filter window can improve the measurement speed.

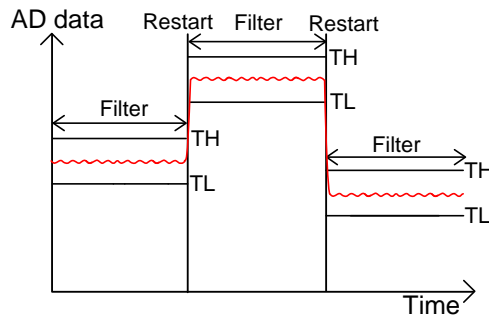

TH: Threshold High, TL: Threshold Low

Filter window Formula Previous data*(1-window) < threshold < previous data*(1+window). There are 5 windows range settings that can be chosen: 10%, 1%, 0.1%, 0.01% and none

Digital Filter Setting

Turn on Filter

1. Press the Shift key followed by the MX/MN (Filter) key.

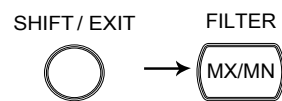



CNT: 0 10





MOV

1st display Shows the filter count

2nd display Shows the filter type (flashing)

2. Select the filter type using the Up/Down key.  



MOV ↔ REP ↔ MOV

3. Move the cursor to filter count using the Left/Right key. Change the value using the Up/Down key.  
 

CNT: 0 10



Set Filter Window threshold

4. Press the Enter key to confirm editing. 

5. Select the Window threshold using the Up/Down key. The display changes accordingly.  

10 / 0 WINDOW

Range None, 0.01%, 0.1%, 1%, 10%

6. Press the Enter key to confirm editing. The Filter indicator appears on the display. 

DC S 100 mV
 0048095 m V FLT

FILT Indicates manual Filter setting

Turn off Filter

Press the Shift key followed by the MX/MN (Filter) key. The Filter indicator will disappear from the display.

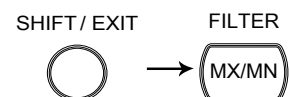

Analog Filter Settings

Background

The analog filter is a single order low pass filter that can be turned on to attenuate the AC components from a DC signal. This will effectively eliminate the AC component from influencing the automatic range settings.

For example, the analog filter can be turned on to attenuate the AC components of a DC signal that has a superimposed AC voltage with a magnitude that is higher than the measurable range of the DC signal.

The Analog filter setting is off by default. The cutoff frequency for the analog filter is at 500Hz (-3dB).



Note

The analog filter can only be used with DCV and DCI measurements.

Panel operation

1. Press the Shift key followed by the 2nd (Menu) key. The Level 1 menu appears.
 

2. Press the right key twice until Set ADC appears.
 

SET ADC

LEVEL 1

3. Press down once to enter the Set ADC menu on level 2.
 

4. Press the left key until the A-Filter setting is shown.
 

5. Press the Down key to turn the A-Filter on or off.
 

ON

A-FILT

1st display Shows the A-FILT setting

- Press the Enter key to confirm your selection. Press the Exit key to go back to the default display.

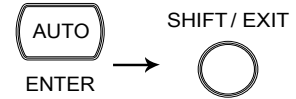

Display Setting

Display Light Setting

Background The display light setting adjusts the brightness of the display reading. Use light 3 or more (brighter) when working indoor; use light 2 or 1 (darker) when working outdoor under the sun.

Level 5 (brightest) ~ 1 (darkest), default = 3

- Press the Shift key followed by the 2nd (Menu) key. The system menu appears.

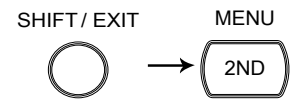

SYSTEM LEVEL 1

- Press the Down key, then the Right key twice. The light menu appears.

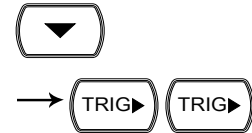





LIGHT LEVEL 2

- Press the Down key. The light level setting appears.



LIGHT 3 LEVEL 3

1st display Shows the current display light level



- | | |
|---|---|
| 4. Select the level using the Up/Down key. |   |
| 5. Press the Enter key to confirm your selection. Press the Exit key to go back to the default display. |  SHIFT/EXIT
 |

Measurement Configuration Settings



D-Shift Settings

Background The D-Shift setting automatically shifts the decimal point depending on the measurement. If D-Shift is turned off, the measured readings will be displayed at the full 6 ½ digits with a fixed decimal place. The D-Shift setting is on by default.

D-Shift On, Off (default, On)

- | | | |
|-----------------|--|---|
| Panel operation | 1. Press the Shift key, the 2nd (Menu) key followed by the Right key. The MEAS menu appears. |  SHIFT/EXIT
 MENU
 |
|-----------------|--|---|

MEAS	LEVEL 1
------	---------

- | | |
|---|--|
| 2. Press the down key, followed by the right key twice to enter the D-SHIFT menu. | 
  |
|---|--|

D-SHIFT	LEVEL 2
---------	---------

- | | |
|---|---|
| 3. Press the Down key. The D-Shift setting appears. |  |
|---|---|

ON

SHIFT

1st display Shows the D-Shift setting

4. Select the setting using the Up/Down keys.



5. Press the Enter key to confirm your selection. Press the Exit key to go back to the default display.

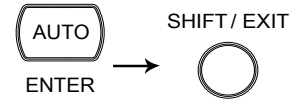

Input Resistance Setting

Background

The 0.1V and 1V DC voltage ranges can be set to an input resistance of 10MΩ or 10GΩ. This setting is only applicable for DC Voltage only.

Input Resistance 10MΩ, 10GΩ (default = 10M)

Panel operation

1. Press the Shift key, the 2nd (Menu) key followed by the Right key. The MEAS menu appears.

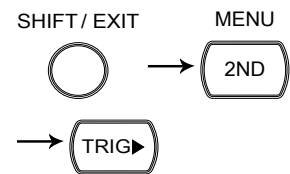

MEAS

LEVEL 1

2. Press the down key followed by the right key three times. The Input Resistance menu appears.

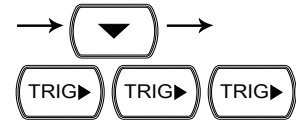

INPUT R

LEVEL 2

3. Press the Down key. The input resistance setting appears.



10M

IN R

1st display Shows the input resistance setting

4. Select the setting using the Up/Down keys.



5. Press the Enter key to confirm your selection. Press the Exit key to go back to the default display.

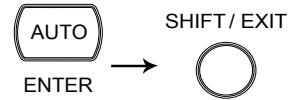

AC Bandwidth Setting

Background

Sets the AC Bandwidth (filter) setting for AC measurements. The Slow, Medium, Fast (S, M, F) rate settings are directly tied to the AC bandwidth settings.

Rate	Digits	Input Frequency	Readings/s
S	6 1/2	3 Hz – 300 kHz	1.2 (sec/reading)
M	5 1/2	20 Hz – 300 kHz (default)	3.38
F	4 1/2	200 Hz – 300 kHz	30

Panel operation

1. Press the Shift key, the 2nd (Menu) key followed by the Right key. The MEAS menu appears.

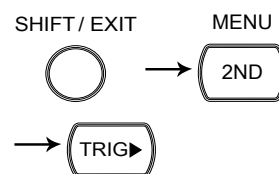

MEAS

LEVEL 1

2. Press the down key followed by the left key twice. The AC Bandwidth menu appears.

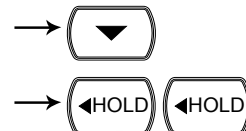



AC BW



LEVEL 2

3. Press the Down key. The input bandwidth setting appears. 



1st display Shows the bandwidth setting

4. Select the setting using the Up/Down keys.  

5. Press the Enter key to confirm your selection. Press the Exit key to go back to the default display.  

Current Input Port Auto-Detect Setting



Background

The Current Input Port Auto-Detect setting will allow the DMM to detect whether current is applied to the 1A or 10A input ports and enables it to set the correct range when Auto range is on.

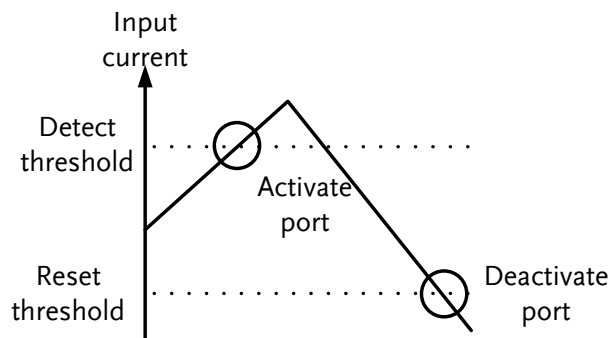
The Current detect feature works by activating the input port only when a certain Detect Threshold is reached and deactivating the input port when the input current dips below a certain Reset Threshold.



I-DET On, Off (default = On)

- Panel operation 1. Press the Shift key followed by the 2nd (Menu) key. The system menu appears.  

SYSTEM LEVEL 1

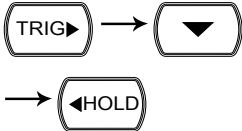
2. Press the Right key, then the down key. Press the left key. The Current detect menu appears.
- 

1 -- DET LEVEL 2

3. Press the Down key. The input current detect setting appears.
- 

OFF 1 -- DET

1st display Shows the current detect setting

4. Select the setting using the Up/Down keys.
- 

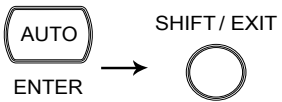
5. Press the Enter key to confirm your selection. Press the Exit key to go back to the default display.
- 

ADC Setting

Auto-Zeroing

Background The Auto Zeroing (A-Zero) function can be used in resistance, TC, RTD, DCV and DCI measurements.

Auto zeroing is used to prevent measurements from drifting by taking offset measurements.

Setting Off, On (default=On)

Theory The combined offset from the input buffer, A/D driver and ADC is called the total offset. Due to temperature variations inside the GDM-8261A, the offsets for the

Buffer, A/D driver and ADC vary over time, and thus the total offset will also vary over time.

Auto Zero deducts this total offset from the measured signal to obtain a more accurate reading. If Auto Zero is turned off, this total offset will not be deducted from the measured signal.

Auto zero works in the following manner:

Internally, the DMM will periodically short the Buffer's Hi and Lo input to obtain a total offset. The frequency at which the offset is obtained depends on the sample rate.

The diagram below shows how the total offset is obtained.

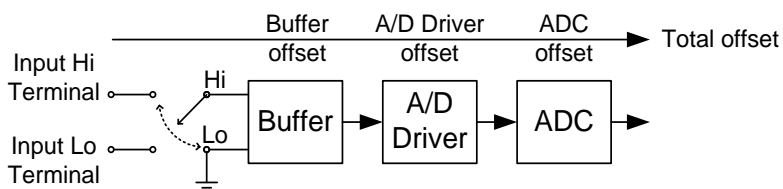

Applicable Measurement Mode, Rate and Speed settings	Mode	Rate	Accuracy	Speed	Quick Speed
	DCV,	S		✓	✓
	DCI,	M		✓	
	4W/2W	F		✓	

Mode	Rate	
TC, RTD, S		These four measurement modes don't support either accuracy or quick speed.
Diode, Cont	M	

Panel operation

1. Press the Shift key followed by the 2nd (Menu) key. Press the right key twice. The ADC setting menu appears.

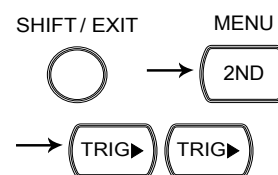

SET ADC LEVEL 1

2. Press the Down key twice. The A-Zero setting appears.



ON
A-ZERO

1st display Shows A-Zero setting

3. Select the setting using the Up/Down key.

▲

▼

4. Press the Enter key to confirm your selection. Press the Exit key to go back to the default display.

AUTO
ENTER

→

SHIFT/EXIT

Auto-Gain

Background The Auto-Gain (A-GAIN) setting performs auto gain correction of the internal amplifiers.

	Setting	Off, On (default=On)		
Applicable Measurement Mode, Rate and Speed settings	Mode	Rate	Accuracy	Speed
	DCV, DCI, 4W/2W, Resistance	S	✓	✓
		M	✓	
		F	✓	

	Mode	Rate	
	TC, RTD, Diode, Cont	S M	These four measurement modes don't support either accuracy or quick speed.

Panel operation

1. Press the Shift key followed by the 2nd (Menu) key. Press the right key twice to choose the SET ADC menu.

SHIFT/EXIT

→

MENU
2ND

→

TRIG▶

TRIG▶

SET ADC
LEVEL 1

2. Press the Down key and then the Left key twice to choose A-GAIN. Press the Down key. The A-GAIN setting appears.

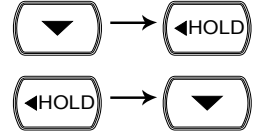

ON A-GAIN

1st display Shows A-Zero setting

3. Select the setting using the Up/Down key.



4. Press the Enter key to confirm your selection. Press the Exit key to go back to the default display.

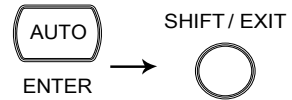

5. A-Zero and A-Gain have an identical time interval of 5 seconds. As can be seen in the diagram below, Auto-Gain correction is performed once after A-Zero has been performed twice.

Example
Mode: DCV
Rate: Slow
Accuracy Speed:
650ms

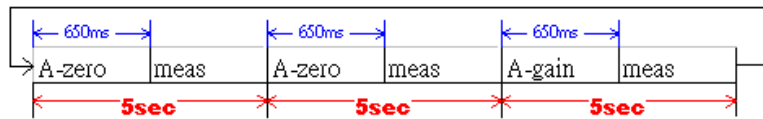

Mode	Rate	Accuracy Speed	Quick Speed
DCV, DCI, 4W/2W	S	650ms	495ms
	M	217ms	
	F	70ms	

Mode	Rate	Below four measurement modes don't support either accuracy or quick speed.
TC, RTD,	S	800ms
	M	184ms
Diode, Cont	S	140ms
	M	80ms

ADC Speed Setting

Background The analog to digital converters have a Quick and Accurate Speed setting. The ADC Speed settings only apply to DCV, DCI or 2/4W resistance measurements. The ADC Speed settings can only be set if DCV, DCI or 2/4W mode is active.

Setting Quick, Accurate (default=Accurate)

Speed/Rate Settings The Speed settings depend on the operating mode and the rate settings.

Function	Rate	Digits	Readings/s	
			Accurate	Quick
DCV, DCI, 2/4W (100Ω ~100MΩ)	S	6 ½	5	30
	M	5 ½	60	600
	F	4 ½	240	2400

All speeds need A-Zero=off, A-Gain=off, fixed range and Trigger Delay=0.

Panel operation 1. Ensure a DC related measurement function is selected. DCV page 28
DCI page 33
2/4W page 34

2. Press the Shift key followed by the 2nd (Menu) key. Press the right key twice. The SET ADC menu appears.

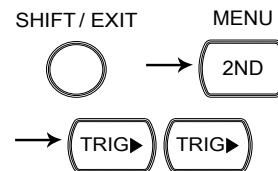

SET ADC

LEVEL 1

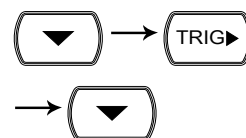

3. Press the Down key, the right key and then the down key. The Speed settings menu appears.





ACCUR

SPEED

1st display Shows the Speed setting

4. Use the Up/Down keys to select either ACCUR or QUICK.  

5. Press the Enter key to confirm your selection. Press the Exit key to go back to the default display.  → 

Frequency / Period Settings

Input Port Selection

Background The INJACK settings set which input port is used for frequency or period measurements.

Setting VOLT, 1A, 10A

- Panel operation** 1. Press the Shift key followed by the 2nd (Menu) key. Press the right key three times. The Frequency/Period menu appears.

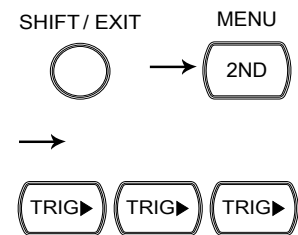

HZ/P LEVEL1

2. Press the Down key twice. The INJACK setting appears.



VOLT INJACK

1st display Indicates which input port is assigned as the input port.

3. Select the input using the Up/Down key.



4. Press the Enter key to confirm your selection. Press the Exit key to go back to the default display.

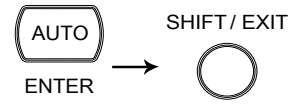

Gate Time Setting

Background The gate time settings determine the accuracy of the frequency and period measurements. The gate time settings are the equivalent to the Fast, Medium and Slow rate settings.

Setting 10ms, 100ms, 1000ms

Rate Settings The gate time settings are analogous to the rate settings.

Function	Digits	Rate	Readings/s	Gate time
Frequency,	6 ½	Slow	1	1000ms
Period	5 ½	Med.	10	100ms
	4 ½	Fast	100	10ms

Panel operation

1. Press the Shift key followed by the 2nd (Menu) key. Press the right key three times. The Hz/P menu appears.

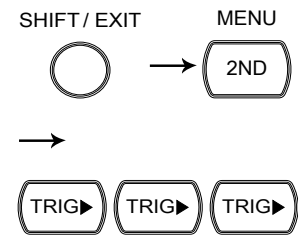

HZ/P

LEVEL1

2. Press the Down key, the right key and then the down key. The gate time settings menu appears.

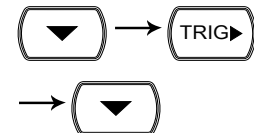

100ms

GTIMER

1st display Shows the gate time setting

3. Select the gate time using the Up/Down key.



4. Press the Enter key to confirm your selection. Press the Exit key to go back to the default display.

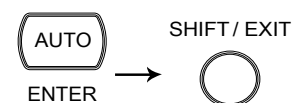

Identification Settings

Changing the Identification String

Background The *IDN? query returns the manufacturer, model number, serial number and system firmware version number. When LANG is set to COMP, a user defined manufacturer and model number is returned with the *IDN? query. Please see the SYSTem:IDNStr command on page 209 for details.

Setting NORM, COMP

- Panel operation** 1. Press the Shift key followed by the 2nd (Menu) key. The System menu appears.

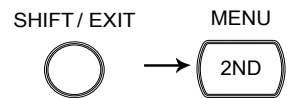

SYSTEM LEVEL 1

2. Press the Down followed by the Left key. The LANG menu appears. Press the Down key to enter the LANG menu.

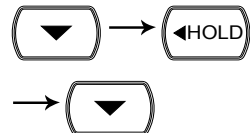

NORM LANG

1st display Indicates the LANG setting.

3. Select NORM or COMP using the Up/Down key.



4. Press the Enter key to confirm your selection. Press the Exit key to go back to the default display.

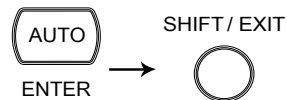

STORE/RECALL

The GDM-8261A can store and recall measurement history (for up to 9999 counts) as well as the instrument settings. For storing and recalling measurement results using the Scanner, see page 105.

STORE RECALL



Store Measurement Record	100
Recall Measurement Record	101
Save Instrument Settings	102
Recall Instrument Settings	103

Store Measurement Record

Background The GDM-8261A can log up to 9999 measurement results (counts) which can be stored and recalled later for analysis. Basic measurement statistics such as Maximum, Minimum, Average value as well as Standard Deviation are also recorded with the data.

Note: Previously recorded measurements will be erased every time the store function is used or if power is reset.

Data count 2 ~ 9999

Not applicable to Store/recall measurement history is not applicable to the Diode/Continuity tests \rightarrow (•••).

Store step

1. Press the Shift key followed by the DCI (Store) key. The store menu appears.

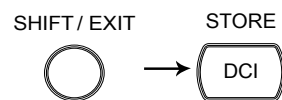

2. Move the cursor using the Left/Right key. Change the data count using the Up/Down key.

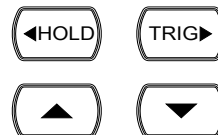

3. Press the Enter key to confirm editing and to go back to the previous display.



STO Indicates the measurement history is stored

Recall Measurement Record

Background The GDM-8261A can recall previously recorded measurement results for observation and analysis. The Standard Deviation, Maximum Value, Minimum Value and Average Value can also be viewed.

Not applicable to Store/recall measurement history is not applicable to the Diode/Continuity tests \rightarrow (•)).

Recall stored record Press the Shift key, then the ACI (Recall) key. The stored measurement record appears.

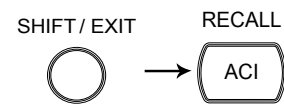

1st display Shows the stored measurement result

2nd display Shows the reading count

RCL Indicates the data has been recalled

View each reading Change the reading count using the Up/Down key.



View Max/Min/Average Switch to the Standard Deviation/Average/Maximum/Minimum value of the recorded data using the Right key. Use the left key to go back.



Save Instrument Settings

Background The GDM-8261A can save up to 5 instrument settings. The settings can save the state, function, I/O and range. Upon powering up, the current instrument setting is displayed.

Parameter	Save (1-5), Del-All
Saved Parameters	<ul style="list-style-type: none"> • Main display parameters • 2nd display parameters • Filter settings • Beep settings • I/O settings • System Delay Time • Backlight (Light) settings • Math settings • Auto-Zero settings • Auto-Gain settings • Scanner settings • Settings for each function • Continuity threshold • TCO settings • D-Shift • Bandwidth • Gate time • RTD settings • Input Resistance • Input Jack • I-DET • TX TERM

Set Instrument Setting

1. Press the Shift key followed by the 2nd (Menu) key. The SYSTEM menu appears.

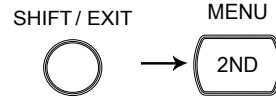

SYSTEM LEVEL 1

2. Press the Down key followed by the Right key three times. The Save menu appears.

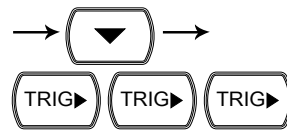

SAVE LEVEL 2

3. Press the Down key to enter the Save menu.



PARAM. 1 SAVE

1st display Shows the memory number

4. Select the memory number using the Up/Down key or select Del-All to delete the save settings in memory.
- 

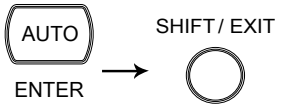
5. Press the Enter key to confirm your selection. Press the Exit key to go back to the default display.
- 

Note The current instrument settings have been saved. To enable the settings at power up, follow the instructions in the next section.

Recall Instrument Settings

Background The Recall function enables saved settings or default settings to be recalled at the next power up or immediately.

Parameter Recall (0-5), 0 = recall default settings
 P-ON: recall at next power up
 Now: recall right away

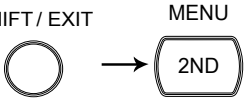
- Recall Instrument Setting** 1. Press the Shift key followed by the 2nd (Menu) key. The SYSTEM menu appears.
- 

SYSTEM LEVEL 1

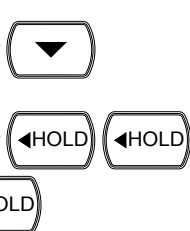

2. Press the Down key followed by the Left key three times. The Recall menu appears.
- 



RECALL LEVEL 2

3. Press the Down key to enter the Recall menu. 

PARA: 5 RECALL

1st display Shows the memory number

4. Select the memory number using the Up/Down key.  

5. Press the Enter key to confirm your selection. Press the Exit key to go back to Recall menu.  → 

6. Select the Now or P-ON option using the Up/Down key.  

NOW RECALL

7. Press the Enter key to confirm your selection. 

S **SCANNER (OPTIONAL)**

The optional scanner, GDM-SC1A, lets you effectively measure multiple channels connected to a single GDM-8261A DMM.

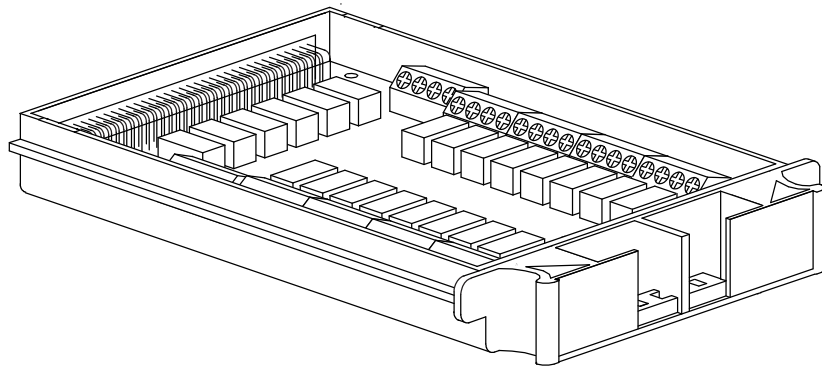
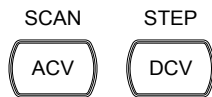

Installation	GDM-SC1A Scanner Specifications 106
	Configure Scanner..... 106
	Select Channel Group and Enable Scanner 108
	Temperature Sensor Calculation..... 110
	Connect Wires 111
	Insert Scanner 114
	Scanner Configuration Record..... 116
<hr/>	
How To Thermocouple Measurement	Scanner Card architecture 117
	Thermocouple measurement..... 118
<hr/>	
Setup	Overview 119
	Setup Simple Scan 120
	Setup Advanced Scan 122
	Use External Trigger 125

Run	Overview	126
	Run Scan/Step	126
	Recall Scan/Step Result	127
	Setup and Run Monitoring.....	127

GDM-SC1A Scanner Specifications

2-wire channel	16 pairs	Maximum current	2Arms (ch17, ch18)
4-wire channel	8 pairs	Resistance	2/4 wire
Single wire channel	N/A	Cold junction	Temperature Sensors (Analog)
Maximum voltage	250Vrms	Connection	Screw terminal

Scanner Installation

Configure Scanner

- Open Scanner cover
1. Take off four screws from the bottom panel of the scanner.

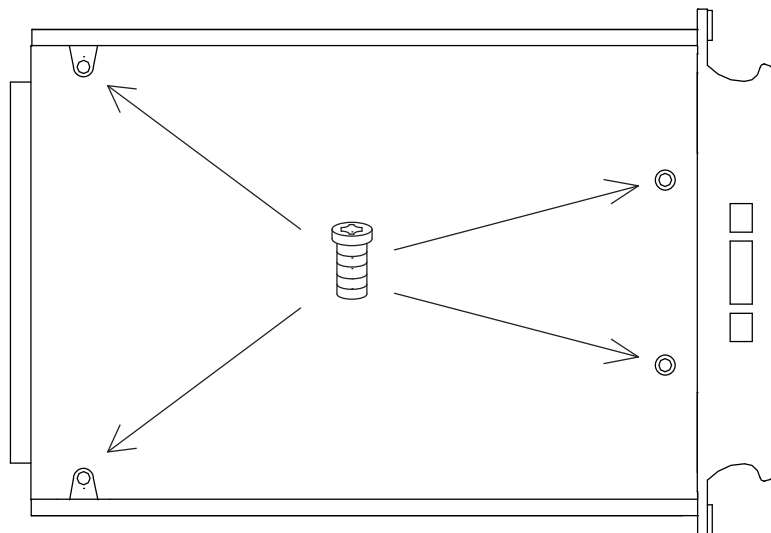

2. Remove the top panel.

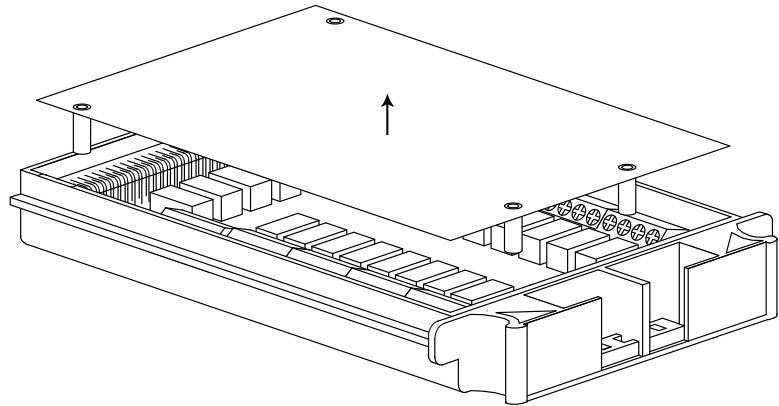

3. Note the connection terminals.

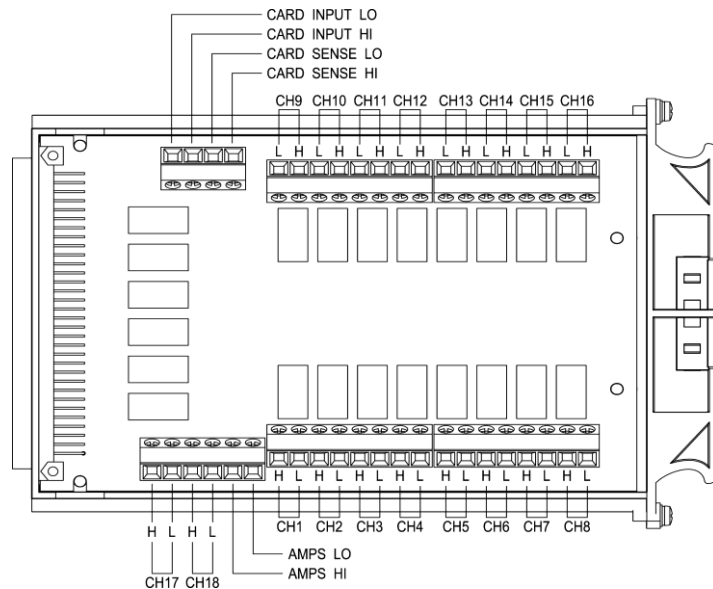

Overview

16 general purpose channels are available, 8 on the left row, 8 on the right row. Current (ACI, DCI) measurement uses 2 extra channels. All channels are fully isolated (Hi and Lo).

Scan/Step connection

Refer to the below table for measurement and test line connections.

Item	No. of wires	No. of channels
DCV, ACV Diode/Continuity Period/Frequency	2 wires (H, L)	16 (CH1 ~ 16)
DCI, ACI	2 wires (H, L)	2 (CH17, 18) Maximum current : 2A

Temperature simulation	2 wires (H, L)	16 (CH1 ~ 16) for temperature
Cold junction (Separate Chapter)	2 wires (H, L)	15 (CH2 ~ 16) for temperature, CH1 for Cold junction
2W Resistance Temp. 2W RTD	2 wires (H, L)	16 (CH1 ~ 16)
4W Resistance Temp. 4W RTD	4 wires (Input H, L + Sense H, L)	8 pairs (CH1 [input] & 9 [sense], 2 & 10, ... 8 & 16)

Select Channel Group and Enable Scanner

Background 16 channels are available for the scanner when using the GDM-8261A.

Group1 CH101 ~ 118

Select group (Jumper J8) (Preset MASTER) Set the jumper J8 in the center of the board to the MASTER configuration. Move the jumper to the right (pins 2-3) to select CH1xx (101 ~ 118). The GDM-8261A does not support the SLAVE operation mode with the optional scanner.

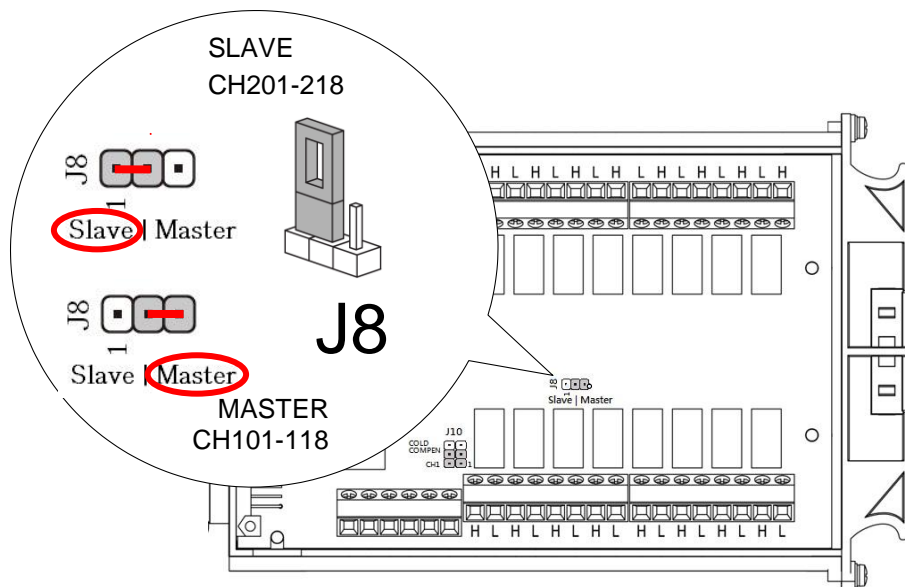

Enable scanner (Jumper J9) (Preset accordingly. Move the jumper up to disable the scanner, Enabled)

Set the jumper J9 on the rear side of the board and down to enable the scanner.

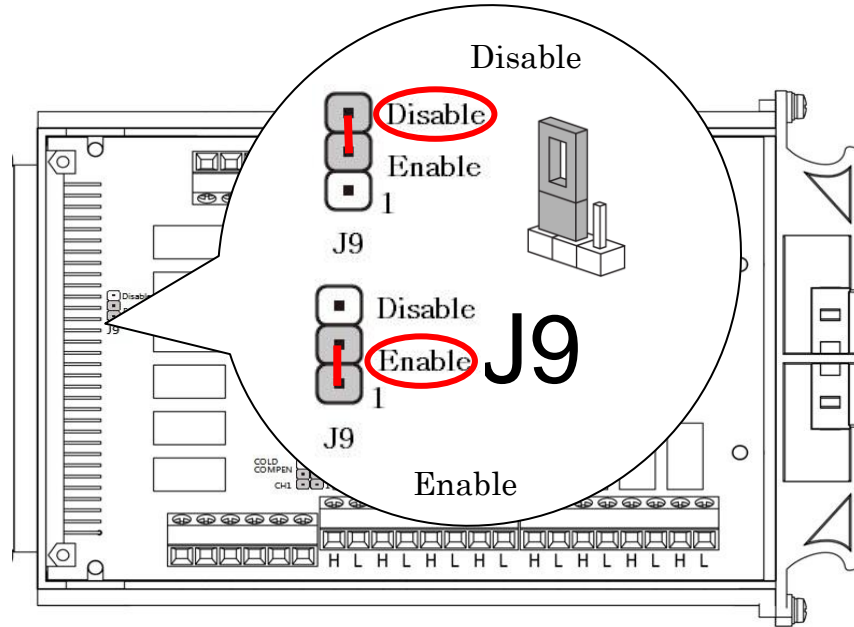

Enable cold junction points (Jumper J10) (Preset Disabled)

Set the jumper J10 on the Bottom left of the board accordingly. Move the jumper (COLD COMPEN) for selecting CH1 to Enable the Cold Junction, or down(CH1) for selecting CH1 to Disabled the Cold Junction.

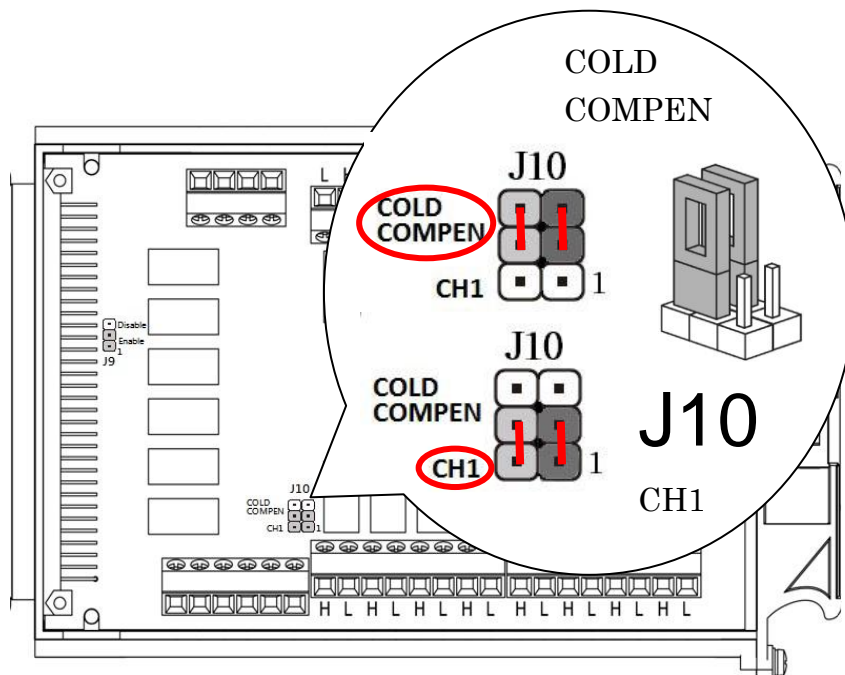



Note

Do Not set the jumpers horizontally as the figure below shown, which will Not enable the target functions.

Erroneous example

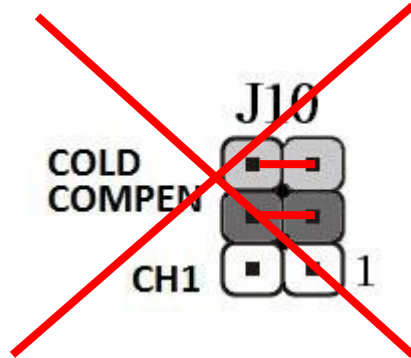

Temperature Sensor Calculation

Overview The temperature sensor provides a positive slope output of 10 mV / °C

Equation The temperature sensor voltage output (Vout) calculates given temperature (Ta):

$$T_a = (V_{out} - V_{offs}) / T_c \quad (\text{Equation})$$

where

- Vout is the temperature sensor voltage output for a given temperature
- Ta is the given temperature °C
- Tc is the temperature coefficient 10mV/ °C
- Voffs is the temperature sensor voltage offset = 500mV

Example

The temperature sensor voltage 0.785V

$$T_a = (0.785 - 0.5) / 0.01 = 28.5^\circ\text{C}$$

The calculates given temperature 28.5°C

Connect Wires

Wire selection Make sure the wires have at least the same Voltage and Current capacity as the maximum ratings in the measurement. When measuring TC, it has the possibility that CH1 is being regarded as cold junction. In order to prevent conflicts, it is suggested initiating from CH2 for wiring.

Connection 1. Turn the screw left (loose) using the screw driver and insert the wire. Turn the screw right (tight) and secure the connection.

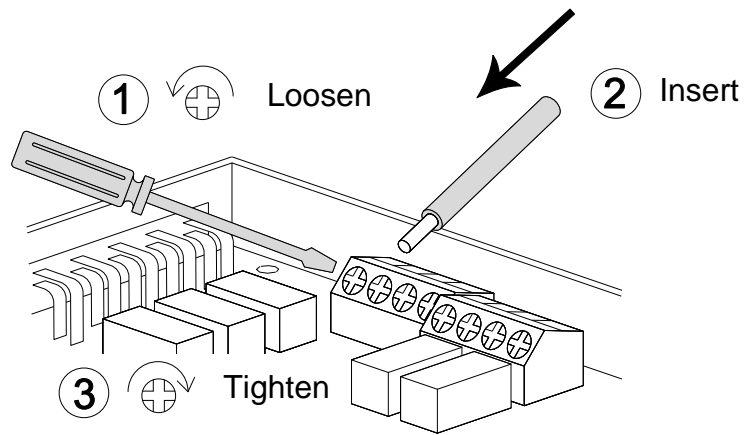

- Route the wires as shown below via the two openings (left and right) at the front cover.

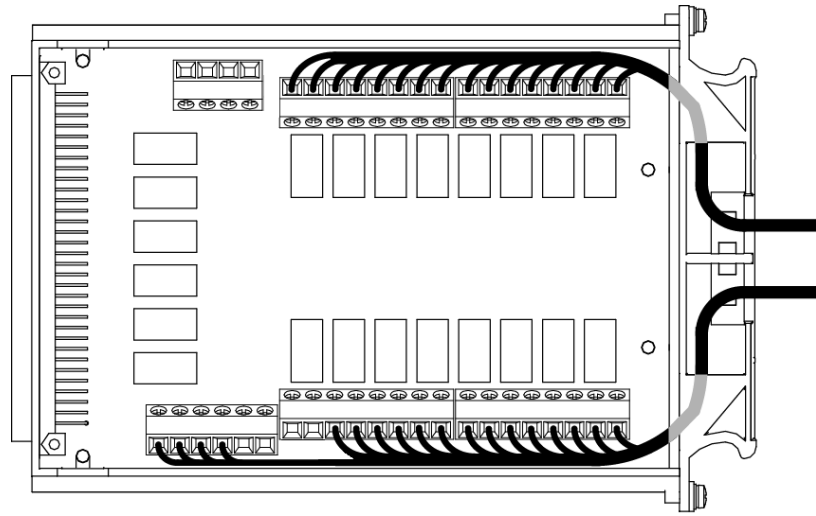

Note

When using thermocouple measurement, The temperature sensor inside the scanner box. Move the J10 JUMP to cold compensation, and the CH1 value is switched to the temperature sensor value. You can use this temperature as a cold junction compensation.

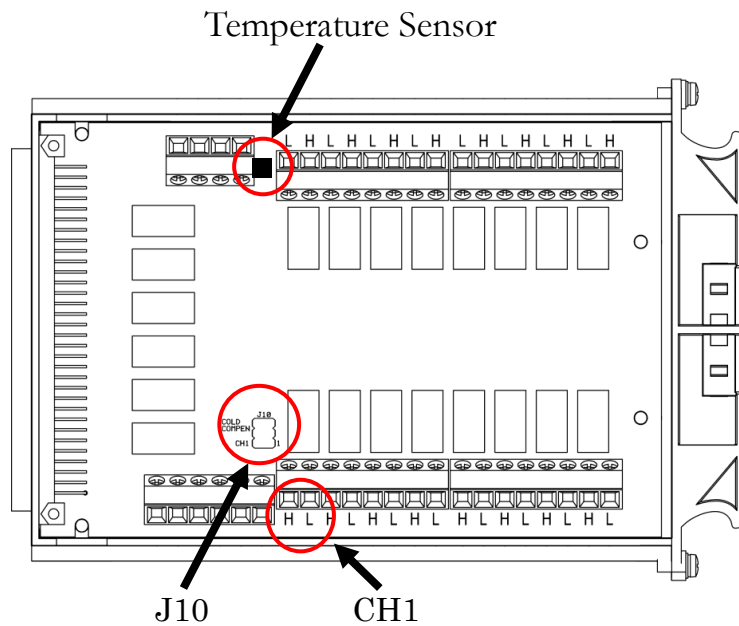

When J10 JUMP is set to cold compensation, CH1 original connection external signal will lose its function, Change to the temperature sensor

3. Tightly bundle the wires with cable ties which go through the bottom holes at the front cover as the following figures shown.

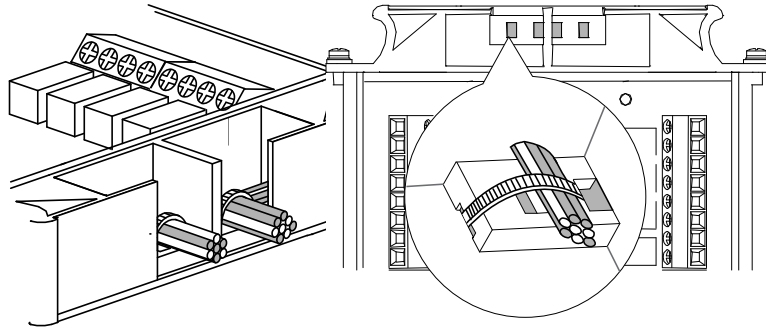

4. Close the top cover and tighten the screw from the bottom.

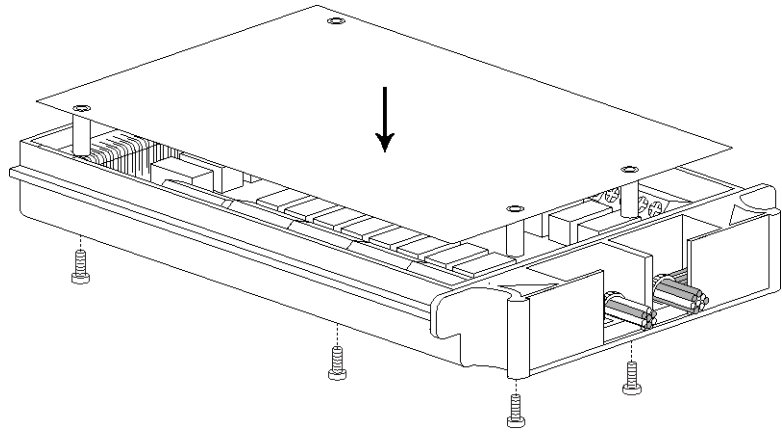

Configuration Record

Print out the configuration record list on page 116, fill in the details, and keep it with the GDM-8261A.

Insert Scanner

Power Off

Turn the Power Off and take out the power cord.

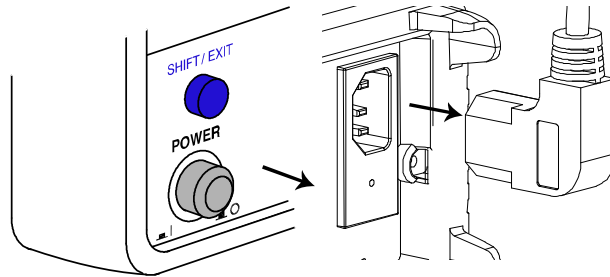

Open the
GDM-8261A rear
panel slot

Take off the two screws on the slot corners to remove the optional slot cover. Keep the screws for later reuse.

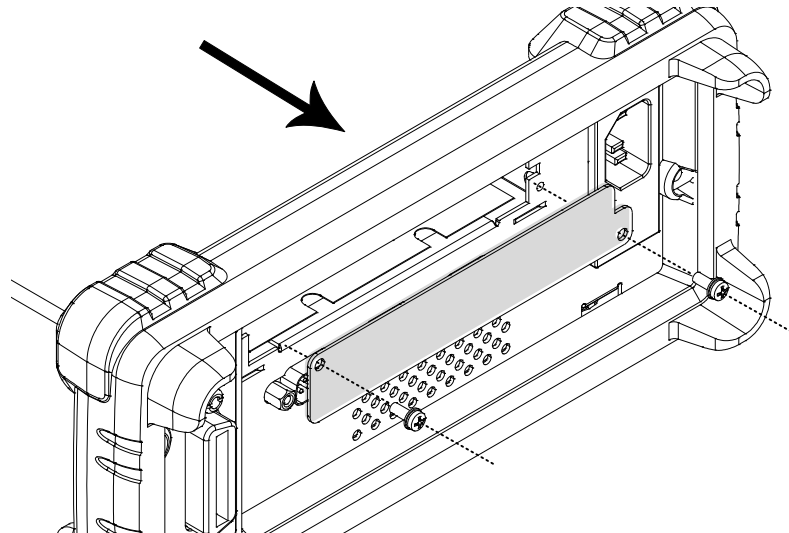

Insert the scanner

Insert the scanner bottom-side-up (already configured according to the procedures on page 106) into the slot. Close the cover by tightening the screws.

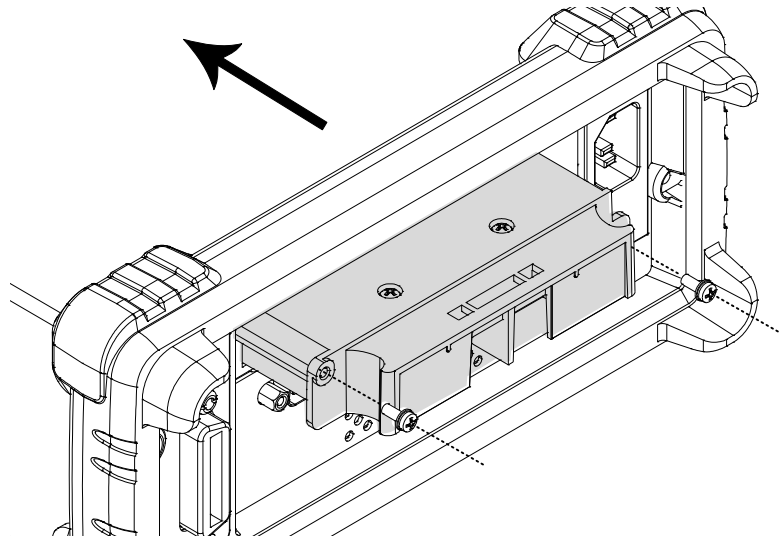

Power On

Connect the power cord and turn On the power.

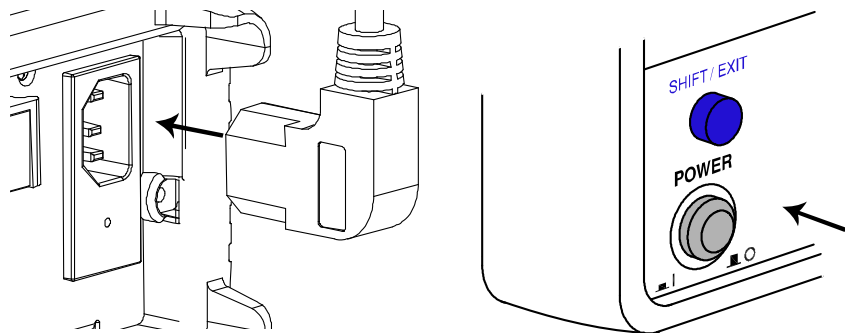

CAUTION

Do not input voltages exceeding 250Vrms to the front input terminals while the scanner module is installed.



WARNING

Do not connect any leads to the front input terminals while the scanner is active. Input signals scanned by the scan module also appear on the front terminals.

Scanner Configuration Record

Channel	Wire color		Measurement type	Note
CH1	H	L		
CH2	H	L		
CH3	H	L		
CH4	H	L		
CH5	H	L		
CH6	H	L		
CH7	H	L		
CH8	H	L		
CH9	H	L		
CH10	H	L		
CH11	H	L		
CH12	H	L		
CH13	H	L		
CH14	H	L		
CH15	H	L		
CH16	H	L		
CH17	H	L		
CH18	H	L		
CARD INPUT	H	L		
CARD SENSE	H	L		
AMPS	H	L		

How To Thermocouple Measurement

Basic work Thermocouples consist of two spot-welded wires of different metals or alloys. The thermoelectric effect at the contact surface is used to measure temperatures. A relatively small thermoelectric voltage is caused, which depends on the temperature difference between the measuring point and the connecting terminals. The resulting voltage is a function of temperature. As the temperature changes, the voltage changes. The thermocouple voltage is equal to the temperature function

Reference junctions A reference junction is the cold junction in a thermocouple circuit which is held at a stable, known temperature. It is at the cold junction where dissimilar wire connections must be made. As long as the temperature of the cold junction is known, can factor in the reference temperature to calculate the actual temperature reading at the thermocouple.

standard reference temperature The standard reference temperature is the ice point (0°C). The ice point can be precisely controlled and the National Bureau of Standards uses it as the fundamental reference for its voltage-to-temperature conversion tables. However, other known temperatures can be used.

Scanner Card architecture

Background The GDM-SC1A incorporates a temperature sensor (TMP235) in the box, which combines a direct thermocouple measurement with a reference junction compensation using a temperature IC to effectively compensate the temperature for the cold junction to calculate the actual temperature reading of the thermocouple.

Thermocouple measurement

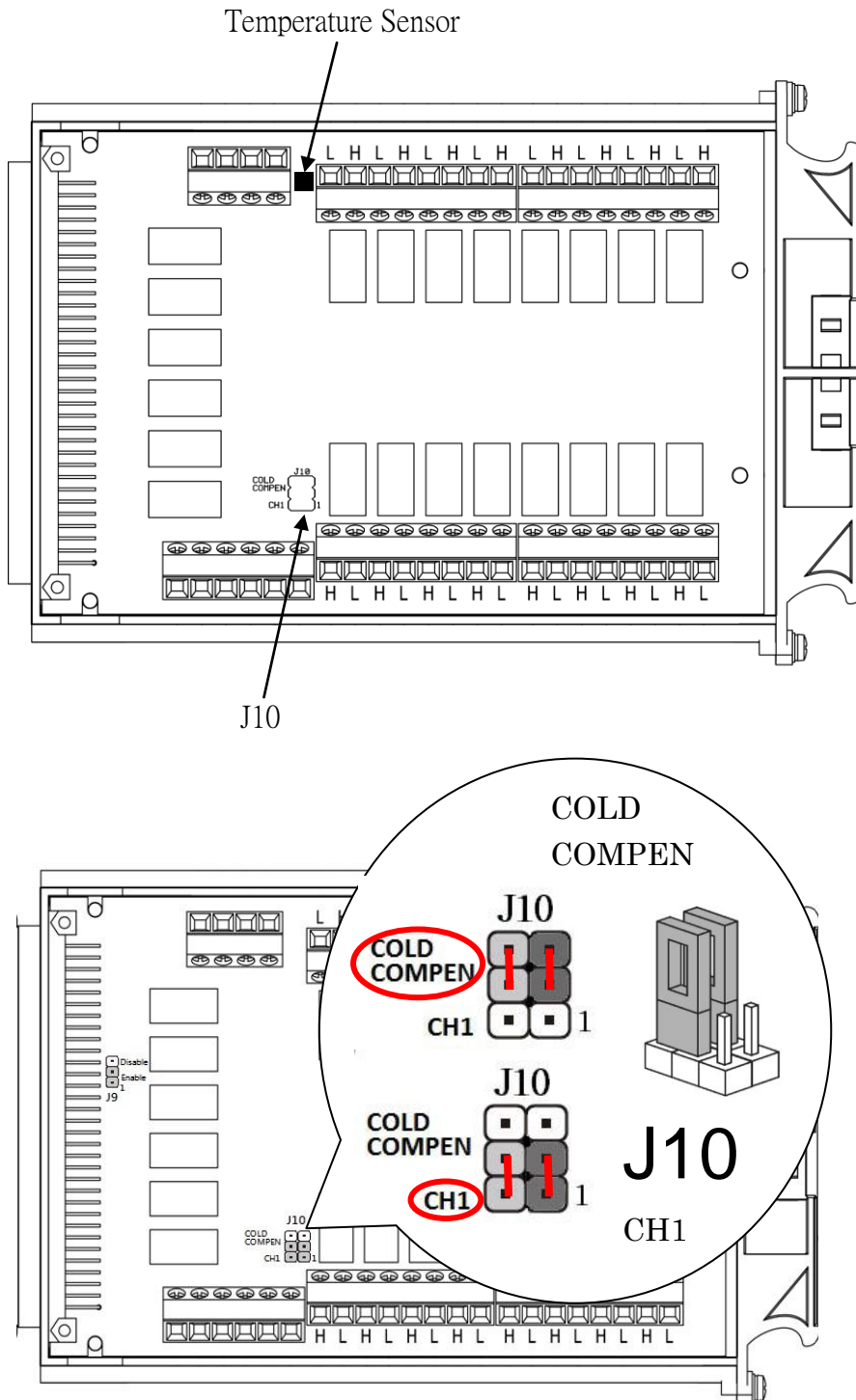

J10 is preset to CH1, please switch J10 to COLD COMPEN when cold junction compensation.

It is recommended to start with CH2 when wiring.

Setup Scan

Overview

Scan type	Simple	Sets the scanned channel range, loop count, and timer length. All channels have a common measurement item.
	Advanced	In addition to the above Simple Scan settings, the advanced mode has custom settings for each channel, such as measurement item, range, and rate.
Timer setting	Sets the duration between each scan loop (Scan operation) or between each scanned channel (Step operation).	
Count setting	Sets the number of scan operations.	
Trigger setting	Internal (Continuous)	The GDM-8261A keeps triggering continuously until the scan reaches the end of the loop count. Then it goes into the idle mode.
	External (Manual)	The GDM-8261A stays in the idle mode by default. The trigger timing is manually controlled by the user from the front panel using the Trig key.
Scan operation	Scan	<p>Measures all specified channel ranges (Channel MIN~MAX) for each trigger event. Timer settings (page 121) are applied between each scan for the whole channel range.</p> <p>Trigger delay settings are applied between each channel in each scan. For more detail about trigger delay setting, please refer to page 80.</p>

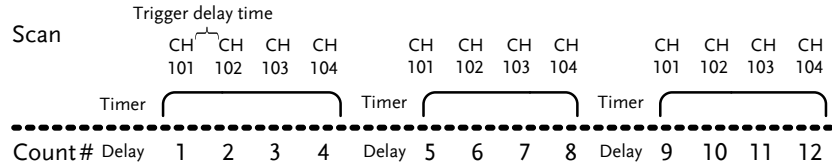

Example: Scan channels 1~4 with a count setting of 12.

Step Measures a single channel in the specified range (Channel MIN~MAX) at each trigger event. Timer settings (page 121) apply for each channel.

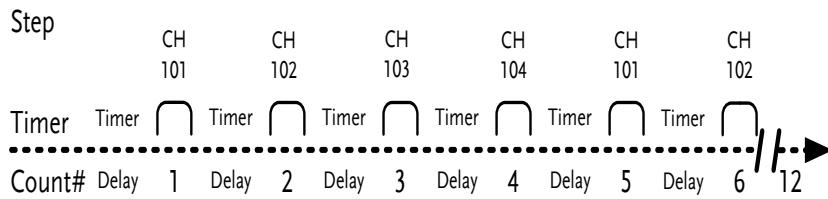

Example: Step through channel 1~4 with a count of 12.

Monitor Selects just one channel and continuously measures it.

Setup Simple Scan

Ensure the scanner has been installed before trying to configure the scanner (page 106).

Panel operation

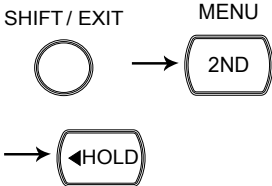
1. Press the Shift key, the 2nd key (MENU), the Left key. The Scan menu appears.
 

SCAN LEVEL 1

2. Press the Down key. The Simple Scan menu appears.
 

SIMPLE LEVEL 2

3. Press the Down key again. The Starting (Minimum) channel setting appears.



CHAN: 101

MIN CH

4. Move the cursor to the channel using the Left/Right key, and change the value using the Up/Down key.



Range 101 ~ 118

5. When finished, press the Enter key. The End (Maximum) channel setting appears.



ENTER

CHAN: 118

MAX CH

6. Move the cursor to the channel using the Left/Right key, and change the value using the Up/Down key.



Range 101 ~ 118, (must be equal to or greater than the Start (Min) channel)

7. When finished, press the Enter key. The Timer setting appears.



ENTER

00 10ms

TIMER

8. Move the cursor to the time setting using the Left/Right key, and change the value using the Up/Down key.



Range 1ms ~ 9999ms

9. Press the Enter key. The loop (step) Count setting appears.



CNT:0 18

COUNT

10. Move the cursor to the count number using the Left/Right key, and change the value using the Up/Down key.

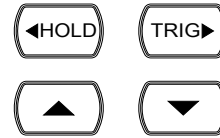

Range 1 ~ 999

11. Press the Enter key followed by the Exit key. The setting is stored and the display goes back to the normal mode.

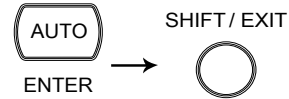

Setup Advanced Scan

- Panel operation 1. Press the Shift key, the 2nd key (MENU), the Left key. The Scan menu appears.

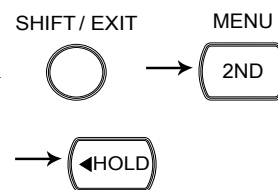

SCAN

LEVEL 1

2. Press the Down key followed by the Right key. The Advanced Scan menu appears.

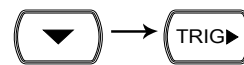

ADV'AN

LEVEL 2

3. Press the Down key. The Starting (Minimum) channel setting appears.



CHAN: 101

MIN CH

4. Move the cursor to the channel using the Left/Right key, and change the value using the Up/Down key.

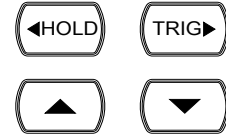

Range 101 ~ 118

5. When finished, press the Enter key. The End (Maximum) channel setting appears.



CHAN: 118

MAX CH

6. Move the cursor to the channel using the Left/Right key, and change the value using the Up/Down key.

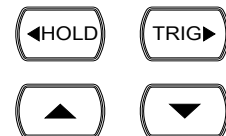

Range 101 ~ 118 (must be greater than or equal to the Start (Min) channel)

7. When finished, press the Enter key. The Timer setting appears.



00 10ms

TIMER

8. Move the cursor to the timer setting using the Left/Right key, and change the value using the Up/Down key.

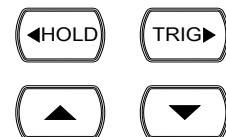

Range 1ms ~ 9999ms

9. When finished, press the Enter key. The Count setting appears.



CNT:0 18
COUNT

Range 1 ~ 999

10. Move the cursor to the count number using the Left/Right key, and change the value using the Up/Down key.
- ◀HOLD

TRIG▶
- ▲

▼

11. When finished, press the Enter key. The channel setting appears.
- AUTO

ENTER

12. The Minimum (first) scanned channel appears. The default setting is CH101.

DC AUTO S
CH 101

CH.
SET
m
V
*

13. Set the measurement conditions.

- To select measurement item, press the target key.

ACV

~

TEMP

- To select Auto range, press the AUTO key.

RATE

AUTO

- To manually select the range, press the Up/Down key.

▲

▼

14. When finished, press the Right key to confirm the edit and to move to the next channel.
- TRIG▶

15. When all channel configurations are completed, press the Exit key followed by the ACV or DCV key. The display goes back to the default mode.
- SHIFT / EXIT

→

SCAN

ACV
-
- SHIFT / EXIT

→

STEP

DCV

Use External Trigger

Background The GDM-8261A uses the internal trigger by default. Using an external trigger allows customized triggering.

Signal connection Connect the external trigger signal to the Digital I/O port located on the rear panel.

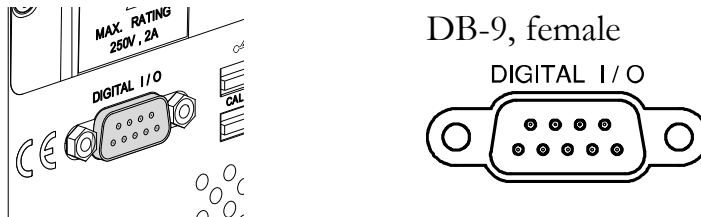

Digital I/O pin assignment

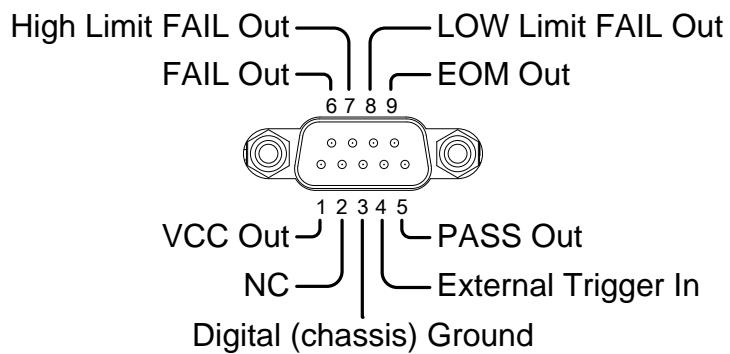



Pin4 External Trigger Input pin

Activate external trigger Press the Shift key followed by the Trig key. The EXT indicator appears on the display.  

Start trigger Press the Trig key to start triggering manually. The reading indicator (*) turns On. 

Reading indicator The reading indicator * stays On before triggering. After triggering, the indicator flashes according to the external signal trigger timing.

Exit external trigger Press the Shift key followed by the Trig key. The EXT indicator disappears and the trigger goes back to the internal mode.  

Run Scan

Overview

Scan operation type	Scan	Measures all the specified channel ranges at each trigger event. The timer settings (page 121) apply to each scan.
	Step	Measures a single channel in the specified range at each trigger event. The timer settings (page 121) apply to each channel.
	Monitor	Continuously measures one channel.

Run Scan/Step

Activate Scan/Step

1. Press the Shift key followed by the ACV key (Scan) or DCV key (Step).

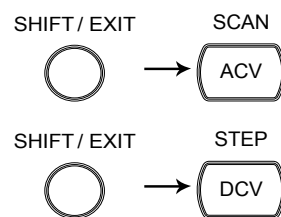

2. The STO indicator turns On. The Scan (Step) starts running and the data is recorded. After running the predefined count, the Scan (Step) stops running.

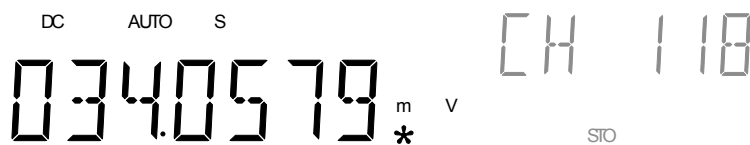

Retrigger/Restart Scan

To run the Scan (Step) again, press the Trig key. The previous data is overwritten by the new Scan.



Abort Scan/Step

To abort Scan/Step or to go back to the normal display, press the Shift key followed by the ACV key (Scan) or DCV key (Step) again.

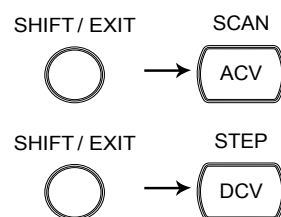

Recall Scan/Step Result

- Panel operation 1. After the Scan/Step is completed, the data is stored internally. Press the Shift key followed by the ACI (Recall) key.

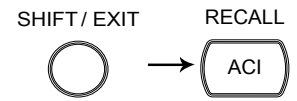

2. The first channel appears. (example: channel 101)

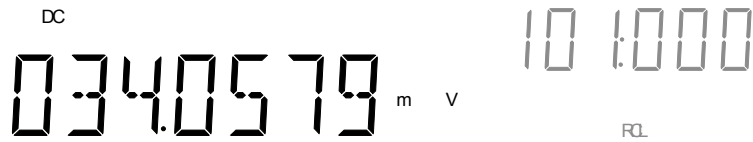

3. To view the Standard Deviation/Min/ Max/Average data, press the Left and Right keys.

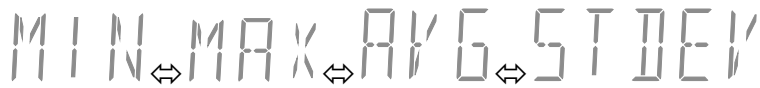

4. To move to the next channel, press the Up/Down key.



5. Press the Exit key to get out from recall mode.



Setup and Run Monitoring

- Panel operation 1. Press the Shift key, the 2nd (Menu) key, the Left key. The Scan menu appears.

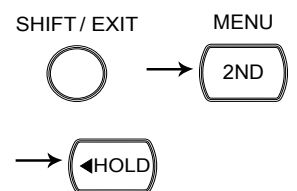

2. Press the Down key followed by the Left key twice. The Monitor Scan setting menu appears.

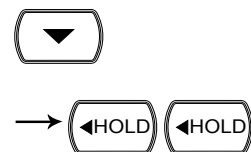

MONITOR

LEVEL2

3. Press the Down key. The channel selection appears.



CHAN: 101

MONITO

4. Move the cursor to the channel using the Left/Right key, and change the channel number using the Up/Down keys.



5. When finished, press the Enter key. The Monitoring starts.



ENTER

DC AUTO S
0340579 m V *

CH 101

STO

DIGITAL I/O

The rear panel Digital I/O terminal outputs the result of Compare measurements to external devices.

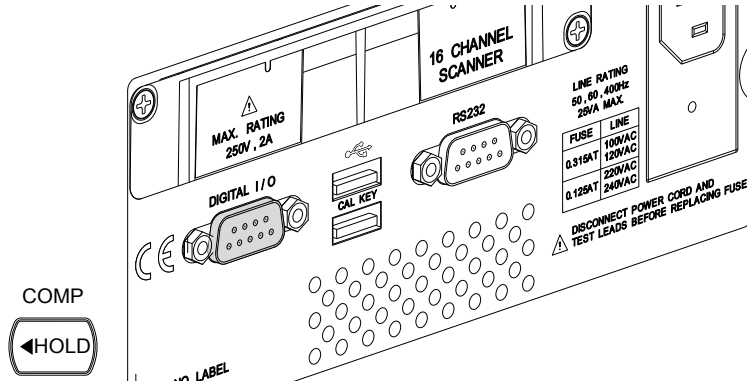

Terminal configuration	Digital I/O Terminal Configuration	130
Application	Application: Compare measurement	131
	Application: External trigger	134

Digital I/O Terminal Configuration

Background The digital I/O terminal outputs the result of Compare measurements to control external devices. By providing separate VCC power for the terminal, the outputs can also be used as a power source for TTL and CMOS circuits.

Pin assignment

Connector type: DB-9 female

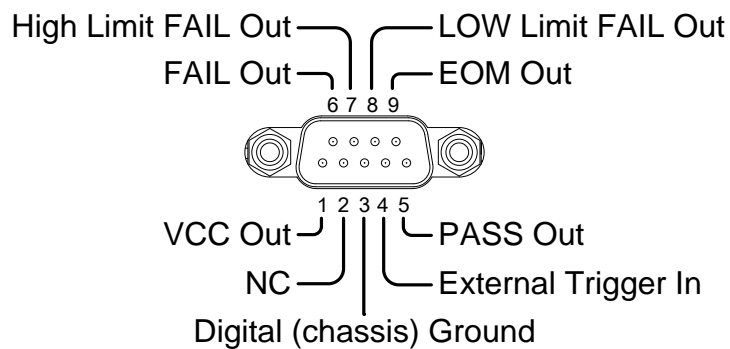
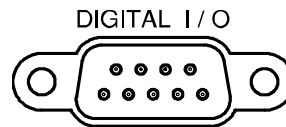

Pin1	VCC output, 5V. Serves as the unregulated max power source for the external device/logic. Without GPIB/LAN card: 4.5V/50mA With GPIB/LAN card: 4.0V/50mA
Pin2	NC (No Connection).
Pin3	Digital (chassis) Ground.
Pin4	External Trigger Input. Accepts external trigger signals. For using external signals, see page 125 (Scanner) or page 78 (Configuration).
Pin5-9	Pins 5-9 use open-collector outputs and thus require a pull-up resistor for each pin. The output resistor must have a minimum rating of 500Ω. All the outputs are active low.

Pins 5-9 output wiring diagram

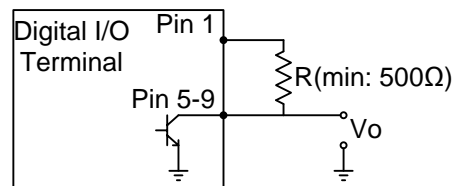

Pin5	PASS signal Output. Activates when the compare result is PASS.
Pin6	FAIL signal Output. Activates when the compare result is FAIL.
Pin7	HIGH Limit FAIL signal Output. Activates when the compare result is FAIL due to violating the HIGH Limit.
Pin8	LOW Limit FAIL signal Output. Activates when the compare result is FAIL due to violating the LOW Limit.
Pin9	EOM (End Of Measurement) signal Output. Activates when compare measurement is over. It is also available in other measurements.

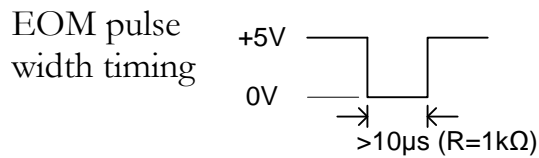

Application: Compare measurement

Applicable to ACV DCV ACI DCI 2/4W Hz/P TEMP

Background Compare measurement checks and updates if the measurement data stays between the upper (high) and lower (low) limit specified.

1. Activate Compare measurement Press the Shift key, then the Hold (Comp) key. SHIFT / EXIT COMP



2. High limit setting

1st display Shows the high limit value

2nd display Indicates high limit setting

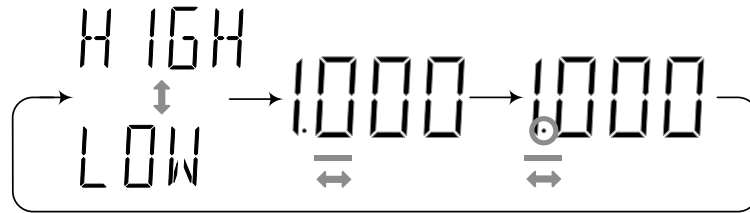
- Use the Left/Right key to move the cursor (flashing point) between high/low setting, digits, and decimal point. ◀HOLD TRIG▶



2. Change the parameter using the  /  key.
3. Press the Enter key to confirm editing and move to the low limit setting. 

3. Low limit setting



1st display Shows the low limit value

2nd display Indicates low limit setting

Set the low limit in the same way as in the high limit. Press the Enter key  to confirm editing. The compare measurement starts right away.

4. Compare measurement appears



COMP Indicates Compare mode

2nd display Shows the compare measurement result: Pass, High, or Low.

5. Result

High If the 2nd display shows High, the result is above the High limit. 

Digital I/O: FAIL Out (Pin 6) and HIGH Limit FAIL Out (Pin 7) are activated.

Low If the 2nd display shows Low, the result is below the Low limit. 

Digital I/O: FAIL Out (Pin 6) and LOW Limit FAIL Out (Pin 8) are activated.

Pass

If the 2nd display shows Pass, the result is staying between the High and the Low limit. **PASS**

Digital I/O: PASS Out (Pin 5) is activated.

Timing Diagram for pins 5-8 when the Compare function is activated

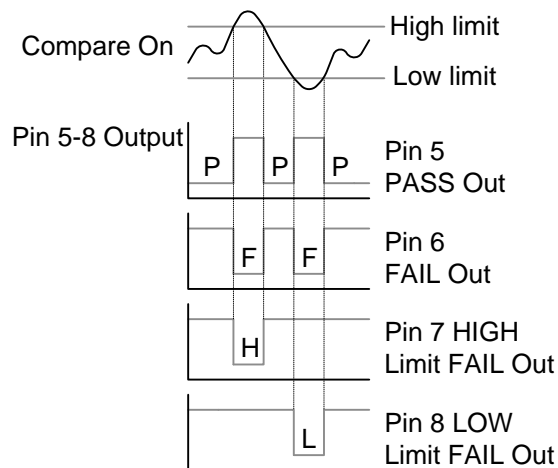

Deactivate Compare measurement

To cancel the Compare measurement, press the Shift key followed by the Hold (Comp) key, or simply activate another measurement.

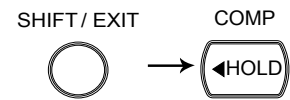

Application: External trigger

Background The GDM-8261A uses the internal trigger by default, for example to count the frequency and the period. Using an external trigger allows for customized triggering conditions.

Signal connection Connect the external trigger signal to the Digital I/O port located on the rear panel.

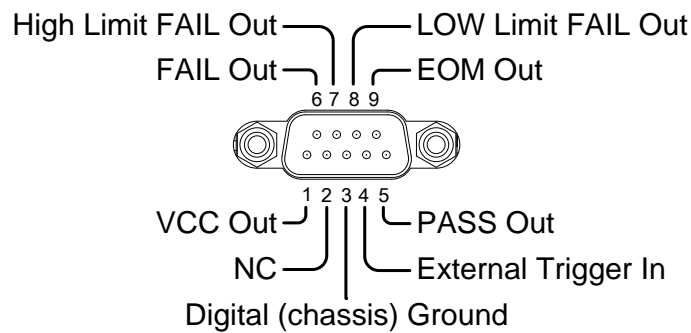

Pin4 External Trigger Input pin

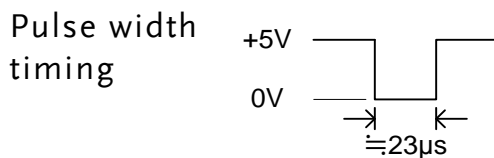
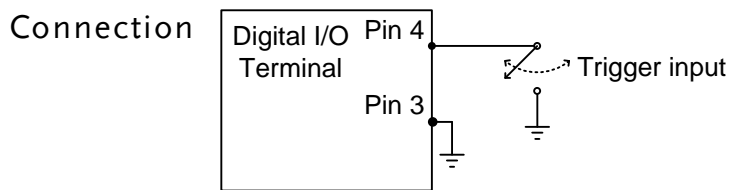

1. Activate external trigger

Press the Shift key followed by the Trig key. The EXT indicator appears on the display.

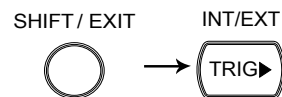



PERIOD

EXT

2. Start trigger Press the Trig key to start triggering manually. The * indicator turns On. 

AC AUTO S
054.5527 m V *

Reading indicator The reading indicator * stays On before triggering. After triggering, the indicator flashes according to the external signal trigger timing.

Exit external trigger Press the Shift key followed by the Trig key. The EXT indicator disappears and the trigger goes back to internal mode.  → 

REMOTE CONTROL

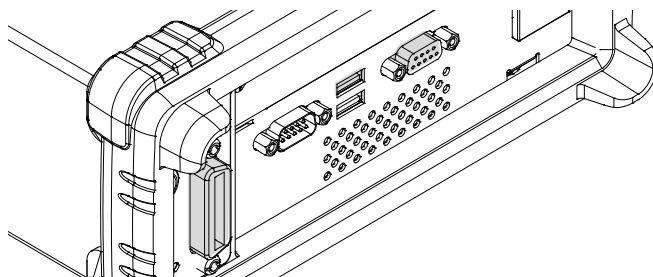

Interface	Overview 138 Configure USB Interface 138 Configure RS-232C Interface 139 Set the EOL Character 140 Set the Separation Character 141 Set the Return Format 142 Insert GPIB Card 144 Configure GPIB Interface 145 Insert Ethernet Card 147 Activate Ethernet Interface 148 Configure Ethernet Interface (RESET) 150 Configure Ethernet Interface to DHCP 151 Configure Ethernet IP 152 View MAC Address 158 Configure Telnet Port 159 Return to Initial Settings 160 View Web Password Settings 162 Remote Terminal Session (Telnet) 163
-----------	---

Web Control Interface	Web Control Interface 165
-----------------------	---------------------------------

Command Syntax and Command Set	Command Syntax 169 Command Set 170 CONFigure Commands 179 Secondary Display: CONFigure2 Commands 181 Measure Commands 184 SENSE Commands 187
--------------------------------	---

CALCulate Commands.....	201
TRIGger Commands	204
SYSTem Related Commands.....	207
STATus Report Commands	210
RS-232C Interface Commands.....	210
IEEE 488.2 Common Commands	210
ROUTE Commands	212

Configure Interface

Overview

Interface type	USB Device	USB 1.1 or 2.0, TypeA, female connector.
	RS-232C	D-sub 9 pin, male connector. Baud rate: 230400/115200/57600/38400/19200/9600. Data bits: 8, Parity: none, Stop bits: 1, Flow control: none.
	GPIB (optional)	24 Pin female GPIB port
	LAN (optional)	10BaseT/100BaseTx
Return to Local control mode	In order to switch back to the Local control mode (front panel operation), press the LOCAL key. 	

Configure USB Interface

USB device port configuration

- Press the Shift key, the 2nd (Menu) key, and then the left key repeatedly until the I/O configuration menu appears.

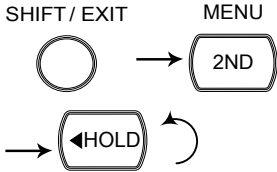

1 / 0
LEVEL 1
- Press the Down key and the left key repeatedly until the USB selection display appears.

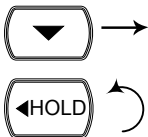

USB
LEVEL 2

3. Press the Down key. The USB ON/OFF selection appears.



4. Press the Up/Down key to select ON or OFF.

5. Press the Enter key followed by the Exit key. The USB setting is stored and the display goes back to the default display.

6. Connect the USB cable to the rear panel terminal (upper port).



Configure RS-232C Interface

Configuration step

1. Press the Shift key, the 2nd (Menu) key, and then the left key repeatedly until the I/O configuration menu appears.



2. Press the Down key and the left key repeatedly until the RS232 selection display appears.



3. Press Enter or Down to confirm RS232 selection.

4. Press the Down or UP keys repeatedly to select the baud rate.
 230400 ⇔ 115200 ⇔ 57600 ⇔ 38400 ⇔ 19200 ⇔ 9600



5. Press the Enter key followed by the Exit key. The RS-232 setting is stored and the display goes back to the default display.

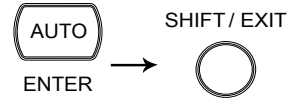

6. Connect the RS-232C cable to the rear panel terminal.

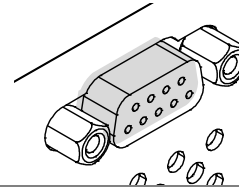

RS-232C pin assignment

Pin 2: RxD
 Pin 3: TxD
 Pin 5: GND
 Pin 1, 4, 6 ~ 9: No Connection

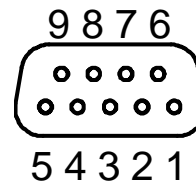

PC – GDM RS-232C Connection

A null-modem connection, in which transmit (TxD) and receive (RxD) lines are cross-linked, is required.

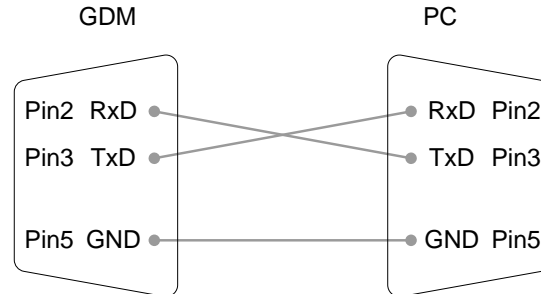

Set the EOL Character

Description

The TX TERM configuration menu can set the end-of-line (EOL) character for return messages. The GPIB and LAN's EOL character is fixed as CR+LF.



The EOL character that is sent from the PC to the DMM can be either CR, LF or CR+LF. The most common EOL character is CR+LF.

EOL CR, LF, CR+LF (default = CR+LF)

Configuration

1. Press the Shift key, the 2nd (Menu) key, the left key repeatedly until the TX TERM configuration menu appears.

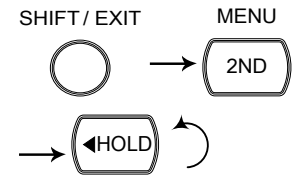

TX TERM

LEVEL 1

2. Press the Down key. The EOL menu appears.



EOL

LEVEL 2

3. Press the Down key. The EOL selection menu appears.



CR+LF

EOL

4. Press the Up/Down key to select the EOL character.



CR+LF ↔ CR ↔ LF

5. Press the Enter key followed by the Exit key. The EOL setting is stored and the display goes back to the default display.

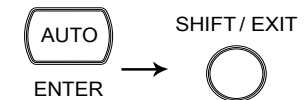

Set the Separation Character

Description

The TX TERM configuration menu can set the separation character for multiple return measurement values, the GPIB's separation character is fixed as a comma. While the separation character for LAN can be either CR+LF or a comma.

Configuration

1. Press the Shift key, the 2nd (Menu) key, the left key repeatedly until the TX TERM configuration menu appears.

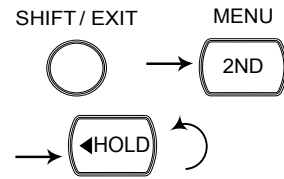

TX TERM LEVEL 1

2. Press the Down key and then the Right key. The SEP selection display appears.

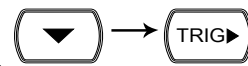

SEP LEVEL 2

3. Press the Down key. The SEP selection menu appears.



COMMA SEP

4. Press the Up/Down key to select the separation character.



EOL(CR+LF/LF/CR) ↔ COMMA

5. Press the Enter key followed by the Exit key. The SEP setting is stored and the display goes back to the default display.

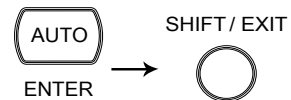

Set the Return Format

Description

When the VAL1?, VAL2?, TRACe:DATA? and FETCh? queries are used, the return measurement format can be configured in one of four ways: V (value), V+U (value, unit), V+C (value, count#), V+U+C (value, unit, count#). See page 205 and 205 for usage examples.

Note: The READ? query will not return values based on the return format settings, see page 204 for details.

Format	Description	Example
V	Value	+0.503E-4
V+U	Value, Unit	+0.503E-4, V DC
V+C	Value, Count#	+0.503E-4, +00001#
V+U+C	Value, Unit, Count#	+0.503E-4, V DC, +00001#

Configuration

1. Press the Shift key, the 2nd (Menu) key, the left key repeatedly until the TX TERM configuration menu appears.

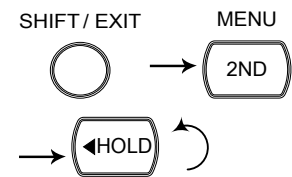

TX TERM

LEVEL 1

2. Press the Down key, the Left key. The FORMAT menu appears.

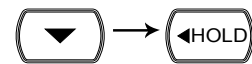

FORMAT

LEVEL 2

3. Press the Down key. The FORMAT selection menu appears.



V

FORMAT

4. Press the Up/Down key to select the Return format.



V ⇄ V+U+C ⇄ V+C ⇄ V+U

5. Press the Enter key followed by the Exit key. The return format setting is saved and the display goes back to the default display.

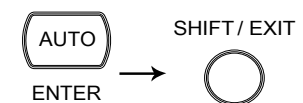

Insert GPIB Card

Power Off

Turn the Power Off and take out the power cord.

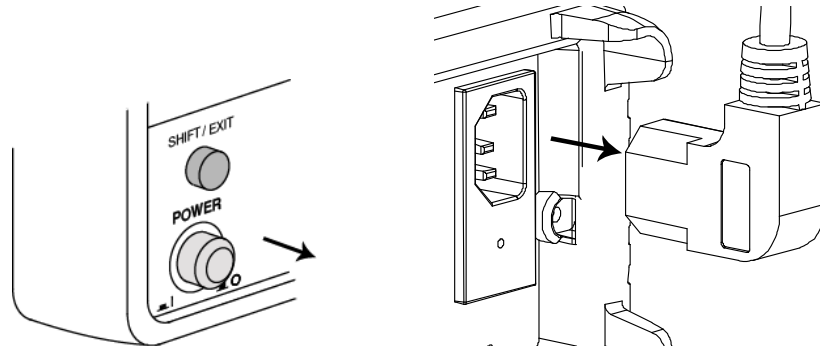

Open the GDM-8261A optional communication port

Take off the two screws on the slot corners to remove the optional communication port cover. Keep the screws for later reuse.

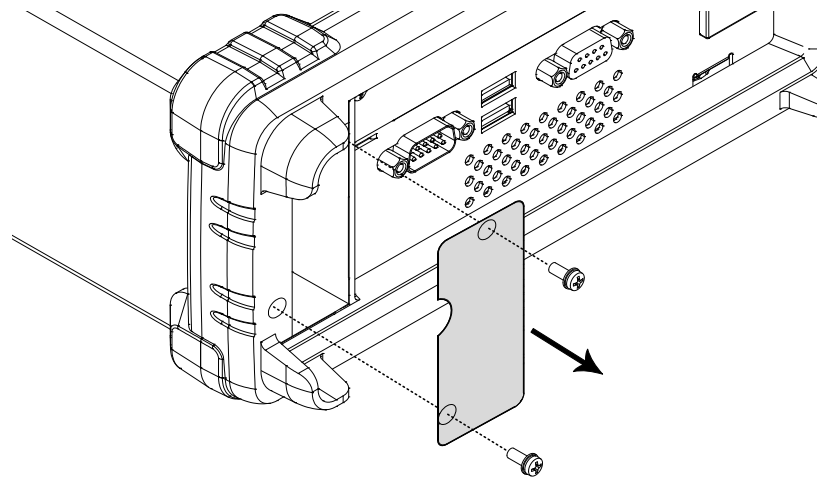

Insert the GPIB card

Insert the GPIB card into the slot. Close the cover by tightening the screws.

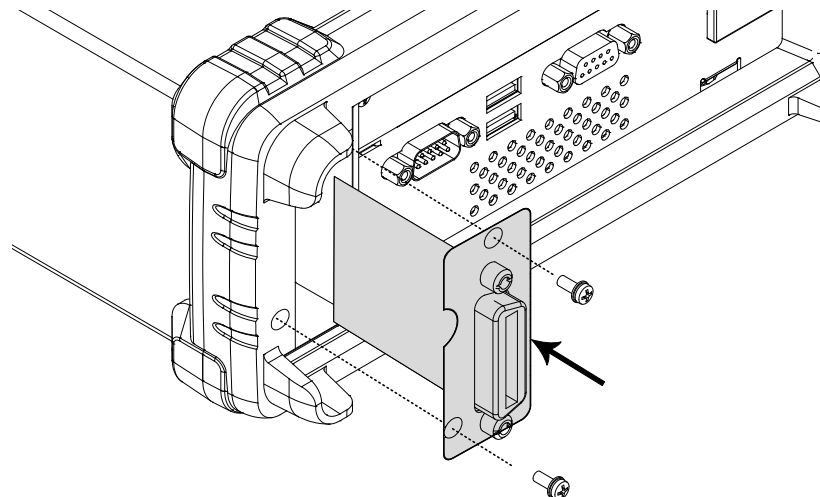

Power On

Connect the power cord and turn On the power.

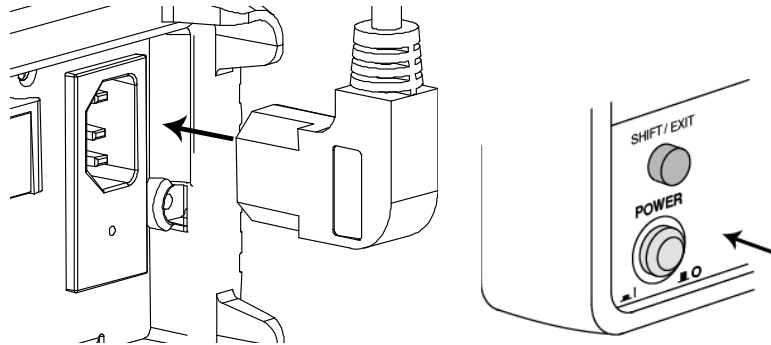

Configure GPIB Interface

GPIB port configuration

1. Press the Shift key, the 2nd (Menu) key, and then the left key repeatedly until the I/O configuration menu appears.

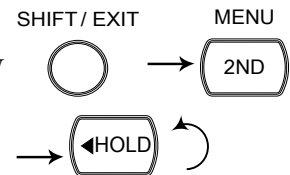

2. Press the Down key and the Left key repeatedly until the GPIB selection display appears.

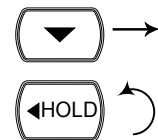

Note: The GPIB menu will be selectable only when the GPIB card is installed.



3. Press the Down key. The GPIB ON/OFF selection appears.



4. Press the Up/Down key to select ON or OFF.



5. To continue to the GPIB address configuration, press the Enter key. The GPIB address configuration menu appears.



1st display Shows the GPIB address.

2nd display Indicates GPIB address setting

6. Change the address using the Left/Right and Up/Down keys.

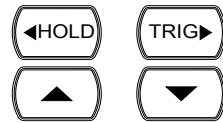

Range 0~30 (Default = 15)

7. Press the Enter key followed by the Exit key. The GPIB setting is stored and the display goes back to the default display.

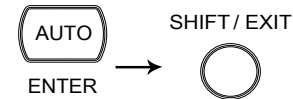

8. Connect the GPIB cable to the rear panel optional communication port after the GPIB card has been installed (page 140).

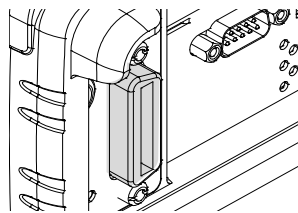

GPIB pin assignment

Pin	Signal	Pin	Signal
1	Data I/O 1	13	Data I/O 5
2	Data I/O 2	14	Data I/O 6
3	Data I/O 3	15	Data I/O 7
4	Data I/O 4	16	Data I/O 8
5	EOI	17	REN
6	DAV	18	Ground (DAV)
7	NRFD	19	Ground (NRFD)
8	NDAC	20	Ground (NDAC)

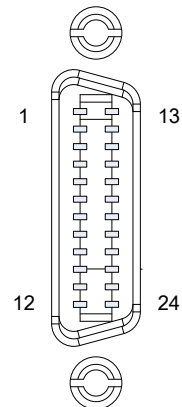

9	IFC	21	Ground (IFC)
10	SRQ	22	Ground (SRQ)
11	ATN	23	Ground (ATN)
12	SHIELD Ground	24	Single GND

Insert Ethernet Card

Power Off

Turn the Power Off and take out the power cord.

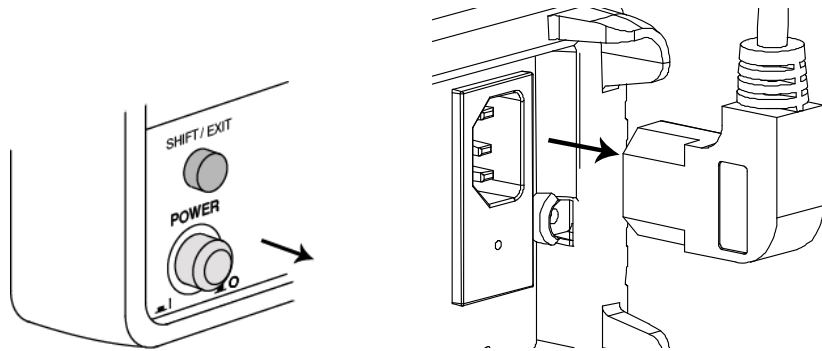

Open the GDM-8261A optional communication port

Take off the two screws on the slot corners to remove the optional communication port cover. Keep the screws for later reuse.

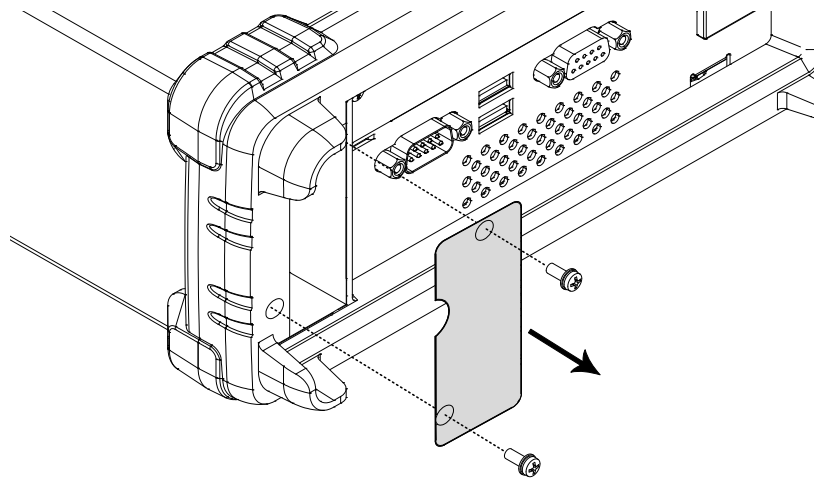

Insert the Ethernet card

Insert the Ethernet card into the slot. Close the cover by tightening the screws.

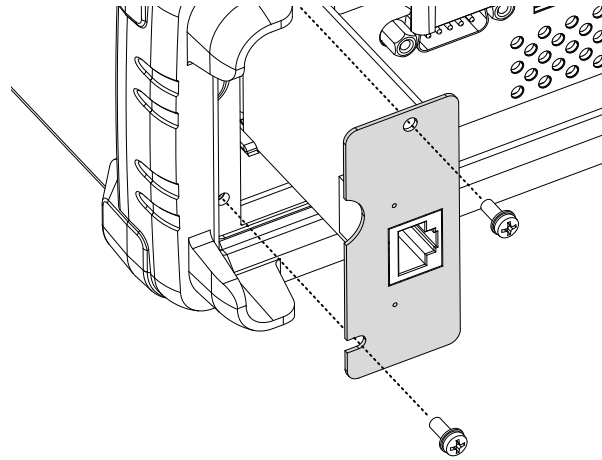

Power On

Connect the power cord and turn on the power.

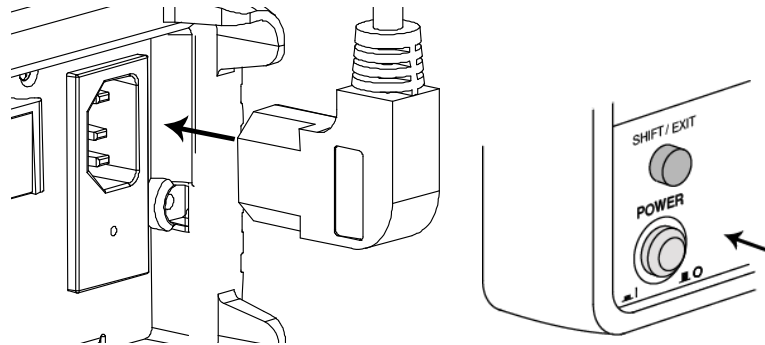

Initialize

Execute the INIT function to initialize the LAN settings, see page 160 for details.

Activate Ethernet Interface

Ethernet(LAN) port activation

1. Press the Shift key, the 2nd (Menu) key, and then the Left key repeatedly until the I/O configuration menu appears.

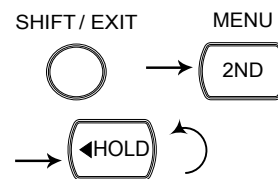

2. Press the Down key and the Left key repeatedly until LAN selection display appears.

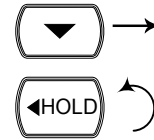

Note: The LAN menu will be selectable only when the LAN card is installed.



3. Press the Down key. The LAN ON/OFF selection appears.



4. Press the Up/Down key to select ON or OFF. ON will turn the LAN option on, OFF will turn the LAN option off.



Note: Ethernet configuration settings can only be edited when LAN is set to ON.

5. Press the Enter key followed by the Exit key. The Ethernet port is turned on/off and the display goes back to the previous display.

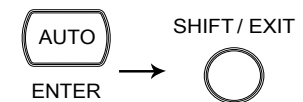

6. Connect the Ethernet cable to the rear panel Ethernet port after the Ethernet card has been installed (page 147).

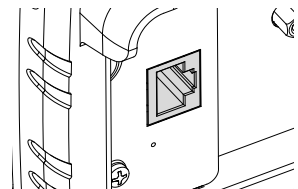

Configure Ethernet Interface (RESET)

Background

The RESET command is used to reset the Ethernet card when new settings have been made. When the DHCP, IP, subnet, gateway or DNS settings have been edited, use the RESET command to validate the changes and reset the Ethernet card to the new configuration settings. New Ethernet configuration settings are only updated after the Ethernet card has been reset.

Ethernet port configuration

1. Press the Shift key, the 2nd (Menu) key, the Left key repeatedly until the SET LAN configuration menu appears.

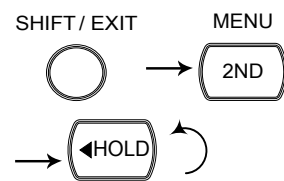

Note: SET LAN will only be available after LAN has been activated in the I/O menu, see page 148.



2. Press the Down key. The RESET selection display appears.



3. Press the Down key. The RESET YES/NO selection appears.

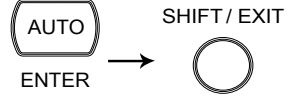

4. Press the Up/Down key to select YES or NO. YES will reset the Ethernet card, NO will cancel resetting the card.
- 

5. Press the Enter key followed by the Exit key. The Ethernet card will be reset after the exiting the menu system.
- 



Note

After the exiting the configuration menu, the Ethernet card will reset. Resetting the Ethernet card takes approximately 5 to 10 seconds.

The continuity icon (⋈) is used to indicate the status of the Ethernet card after it has been reset:

- ⋈ (flashing): indicates that the Ethernet card is resetting
- ⋈ (flashing → turns off): indicates that the Ethernet card has finished resetting.
- ⋈ (flashing → stays on): indicates that the Ethernet card has finished resetting when the continuity function is active (see page 39).

Configure Ethernet Interface to DHCP

Background

The GDM-8261A supports DHCP to have an IP address and other configuration parameters automatically assigned by a DHCP server. If the DHCP server is absent, the Ethernet card will automatically assign an IP address between 169.254.1.0 and 169.254.254.255 using AUTO-IP configuration.

1. DHCP Configuration

1. Press the Shift key, the 2nd (Menu) key, the Left key repeatedly until the SET LAN configuration menu appears.

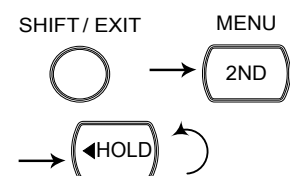

Note: SET LAN will only be available after LAN has been activated in the I/O menu, see page 148.

SET LAN LEVEL 1

2. Press the Down key and the Right key. The DHCP selection display appears.

DHCP LEVEL 2

3. Press the Down key. The DHCP ON/OFF selection appears.

OFF DHCP

4. Press the Up/Down key to select ON or OFF. ON will turn on DHCP, OFF will turn off DHCP.

5. Press the Enter key followed by the Exit key.

2. Reset LAN card

1. To make any changes take effect, set RESET to YES. See page 150 for details.

Configure Ethernet IP

Background

The GDM-8261A supports manually setting of the IP addresses, including the subnet mask, gateway and DNS.

1. Manual IP Configuration

1. Press the Shift key, the 2nd (Menu) key, and the Left key repeatedly until the SET LAN configuration menu appears.

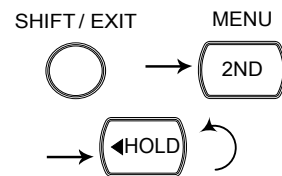

Note: SET LAN will only be available after LAN has been activated in the I/O menu, see page 148.

SET LAN LEVEL 1

2. Press the Down key and the Right key twice. The IP selection display appears.

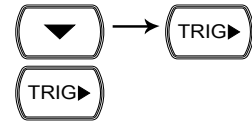

Note: The IP address can only be edited if DHCP is off.

IP LEVEL 2

3. Press the Down key. The IP address selection appears.



IP.1 169

IP.X.X.X.X
 ↑ ↑ ↑ ↑
 IP1 IP2 IP3 IP4

The IP address is divided in 4 groups; IP1:IP2:IP3:IP4. The cursor will be flashing on IP1 (indicated by “X”).

4. Use the Left/Right keys to move the cursor to the IP1 value and select a digit.



IP.X.X.X.X → 169 → 169

5. Press the Up/Down key to edit the selected digit.



169 → 168 → 167

6. Press the Enter key to confirm and automatically go onto IP2.



7. Repeat steps 4 to 6 for IP2, IP3 and IP4.

8. Press the Exit key to exit from the configuration menu.



2. Subnet Configuration

1. Press the Shift key, the 2nd (Menu) key, and the Left key repeatedly until the SET LAN configuration menu appears.

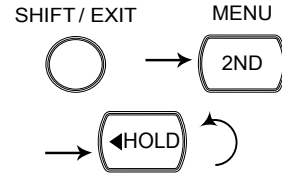

Note: SET LAN will only be available after LAN has been activated in the I/O menu, see page 148.



2. Press the Down key and the Right key repeatedly until the SUBNET selection display appears.

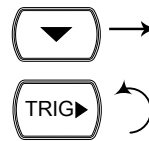



Note: The subnet mask can only be edited if DHCP is off.





3. Press the Down key. The SUBNET address selection appears.



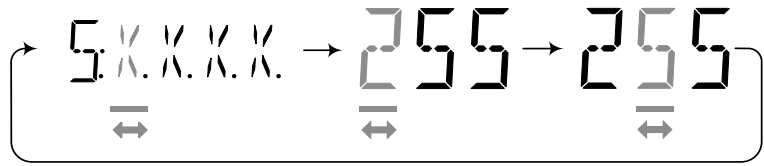

The subnet address is divided in 4 groups; S1:S2:S3:S4. The cursor will be flashing on S1 (indicated by “X”).

4. Use the Left/Right keys to move the cursor to the S1 value and select a digit.  

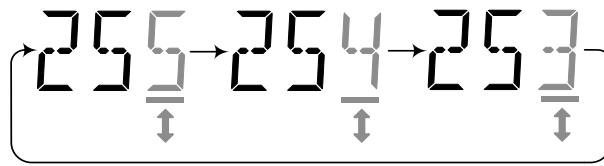

5. Press the Up/Down key to edit the selected digit.  





6. Press the Enter key to confirm and automatically go onto S2. 

7. Repeat steps 4 to 6 for S2, S3 and S4.

8. Press the Exit key to exit from the configuration menu. 

3. Gateway Configuration

1. Press the Shift key, the 2nd (Menu) key, and the Left key repeatedly until the SET LAN configuration menu appears.  →  → 

Note: SET LAN will only be available after LAN has been activated in the I/O menu, see page 148.

SET LAN LEVEL 1

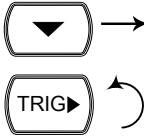
2. Press the Down key and the Right key repeatedly until the GATEWAY selection display appears.
- 

Note: The gateway can only be edited if DHCP is off.





3. Press the Down key. The GATEWAY address selection appears.
- 



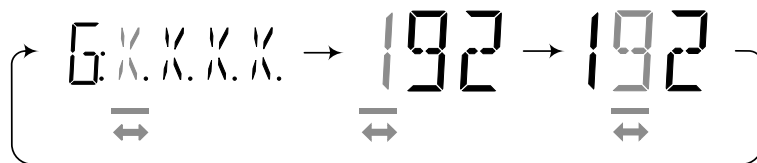

The gateway address is divided in 4 groups; G1:G2:G3:G4. The cursor will be flashing on G1 (indicated by “X”).

4. Use the Left/Right keys to move the cursor to the G1 value and select a digit.
- 

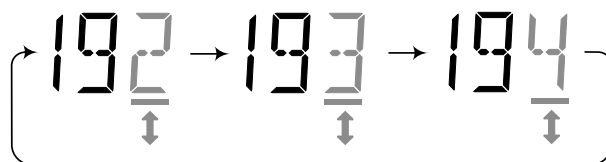

5. Press the Up/Down key to edit the selected digit.
- 



6. Press the Enter key to confirm and automatically go onto G2.
- 

7. Repeat steps 4 to 6 for G2, G3 and G4.

4. DNS Configuration

8. Press the Exit key to exit from the configuration menu.



1. Press the Shift key, the 2nd (Menu) key, and the Left key repeatedly until the SET LAN configuration menu appears.

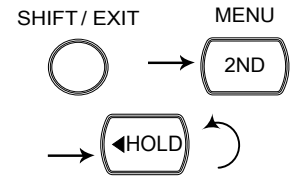

Note: SET LAN will only be available after LAN has been activated in the I/O menu, see page 148.



2. Press the Down key and the Right key repeatedly until the DNS selection display appears.

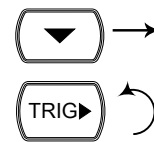

Note: The DNS address can only be edited if DHCP is off.



3. Press the Down key. The DNS address selection appears.

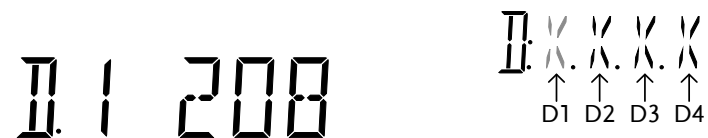



The DNS address is divided in 4 groups; D1:D2:D3:D4. The cursor will be flashing on D1 (indicated by “X”).

4. Use the Left/Right keys to move the cursor to the D1 value and select a digit.

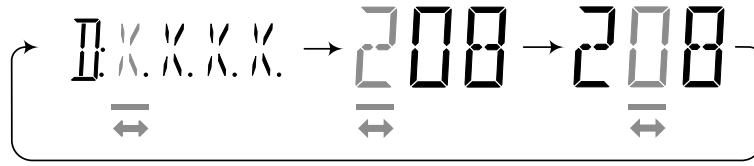



5. Press the Up/Down key to edit the selected digit.  



6. Press the Enter key to confirm and automatically go onto D2. 

7. Repeat steps 4 to 6 for D2, D3 and D4.

8. Press the Exit key to exit from the configuration menu. 

5. Reset LAN card

1. To make any changes take effect, set RESET to YES. See page 150 for details.

View MAC Address



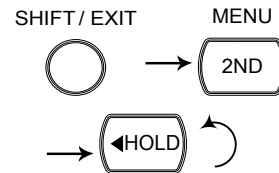

View MAC Address

1. Press the Shift key, the 2nd (Menu) key, and the Left key repeatedly until the SET LAN configuration menu appears.



Note: SET LAN will only be available after LAN has been activated in the I/O menu, see page 148.



2. Press the Down key and the Right key repeatedly until the MAC menu level appears.    

MAC LEVEL2

3. Press the Down key. The MAC address appears. 

1:00 1A66 000276

4. Press the Exit key to exit from the configuration menu. 

Configure Telnet Port

Background The GDM-8261A can set the telnet port used for virtual private networks. By default the telnet port is set to port 23.

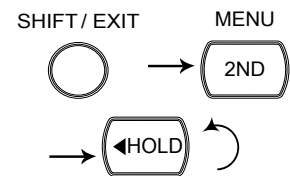

1. Telnet Port Configuration

1. Press the Shift key, the 2nd (Menu) key, and the Left key repeatedly until the SET LAN configuration menu appears.







Note: SET LAN will only be available after LAN has been activated in the I/O menu, see page 148.

SET LAN LEVEL 1

2. Press the Down key and then the Right key repeatedly until the TELNET selection display appears.  → 



TELNET LEVEL2

3. Press the Down key. The Telnet port appears. 

4. Change the telnet port using the Left/Right and Up/Down keys.  
 

Range 1~65535(Default = 23)

P:00023 TELNET

5. Press the Enter key followed by the Exit key to confirm and exit the configuration menu.  → 

Return to Initial Settings

Background

The INIT function is used to return the GDM-8261A back to the original LAN settings. This will also reset the web password back to 123456 if the password has been forgotten.

The INIT function should also be used after the Ethernet card is installed.

Default LAN settings

- DHCP: ON
- TELNET Port: 23
- TELNET timeout: 900 seconds
- WEB password: 123456
- UPNP: 6432
- Module name: G8261A-00000000
(where 00000000 is the serial number)

Return to Initial Settings

1. Press the Shift key, the 2nd (Menu) key, and the Left key repeatedly until the SET LAN configuration menu appears.

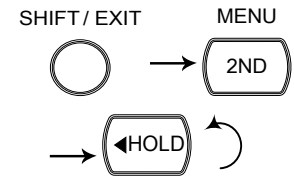

Note: SET LAN will only be available after LAN has been activated in the I/O menu, see page 148.



2. Press the Down key and then the Right key repeatedly until the INIT selection display appears.

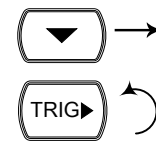

3. Press the Down key. The INIT NO/YES selection appears.



4. Press the Up/Down key to select NO or YES. YES will return the Ethernet settings back to the initial settings, NO will cancel returning to the initial settings.



5. Press the Enter key followed by the Exit key to confirm the settings and exit from the configuration menu.

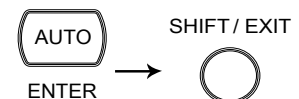



Note

If the GDM-8261A is returned to the initial settings, a reset is performed automatically (page 150) after exiting the configuration menu.

Resetting the Ethernet card takes approximately 5 to 10 seconds.

The continuity icon (···) is used to indicate the status of the Ethernet card after it has been reset:

- (flashing): indicates that the Ethernet card is resetting
- (flashing → turns off): indicates that the Ethernet card has finished resetting.
- (flashing → stays on): indicates that the Ethernet card has finished resetting when the continuity function is active (see page 39).

View Web Password Settings

Background

The web password is set to 123456 by default. Only the on/off setting of the web password can be viewed with the GDM-8261A. The web password can only be set from the web control page, see page 165 for details.

1. Web Password Configuration

1. Press the Shift key, the 2nd (Menu) key, and the Left key repeatedly until the SET LAN configuration menu appears.

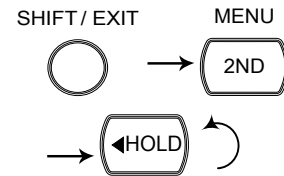

Note: SET LAN will only be available after LAN has been activated in the I/O menu, see page 148.



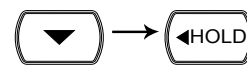

2. Press the Down key and then the Left key. The WEB PW selection display appears.





WEB PW LEVEL2

3. Press the Down key. The WEB PW ON/OFF selection appears. 

ON WEB PW

4. Press the Up/Down key to select ON or OFF. When set to ON a password is required to enter the browser control page, When set to OFF, a password is not required to enter the browser control page.  

5. Press the Enter key followed by the Exit key to confirm the settings and exit from the configuration menu.  → 



Note

The web password is set to 123456 by default. Setting INIT to YES will reset the password back to the default password if the password has been forgotten.

Remote Terminal Session (Telnet)

Background A terminal application can be used to remotely control the GDM-8261A via the telnet protocol.

- Operation**
1. Establish a connection via the Ethernet port. Page 147, 148
 2. Open a terminal program such as Hyper Terminal and enter the IP address and port number of the GDM-8261A.
-

-
3. Run this query via the terminal application:

*idn?

The command will return the instrument manufacturer, model number, serial number and firmware version in the following format:

>GWInstek,GDM8261A,00000000,1.0

4. See page 169 for more details on remote commands.
-

Web Control Interface

The web control interface is accessible with the optional Ethernet card. The web control interface allows remote access over LAN using a Java-enabled web browser.

The web control interface allows a web browser to modify parameter settings, remotely operate, control and monitor the GDM-8261A with a virtual front panel that mimics the GDM-8261A front panel interface.

Telnet parameters can also be edited by using the web control interface so that applets such as HyperTerminal or Telnet can be used to monitor measurement readings, control settings and run programs utilizing the same remote control command set used with the RS232 remote control.

Background Before trying to access the web browser control interface, please ensure your browser has JavaScript and Netbios enabled.

- 1. Connection**
1. Configure the LAN interface and connect the GDM-8261A to the LAN. Page 147, 148
 2. Enter the IP address of the GDM-8261A in the address field of the web browser.
 3. If WEB PW (web password) is set to ON, a dialog box will appear prompting for a password. Key in the password (default password:123456).
 4. The web control Welcome Page appears.

GW INSTEK Good Will Instrument Co., Ltd.

GDM-8261A 6 1/2 Digit Dual Measurement Multimeter

FEATURES
Ⓞ 6 1/2 Digit Display : 1,200,000 counts
Ⓞ DCV Basic Accuracy : 0.0035%
Ⓞ Dual Measurement with Vacuum Fluorescent Display (VFD)
Ⓞ 11 Measurement Functions & 10 Advanced Measurement Functions
Ⓞ High Resolution: Up to 100pA with DCI and 1nA with ACI Measurements
Ⓞ Temperature Measurement (RTD & Thermocouple) from -200°C ~ +1820°C
Ⓞ High Transmission Speed: Up to 2,400 readings/second through the USB interface
Ⓞ Standard Interfaces : USB, RS232C, Digital I/O
Ⓞ Optional Interfaces : GPIB or LAN
Ⓞ Optional Scanner Card : GDM-SC1 (Vx16ch, Ix2ch)
Ⓞ Free Various PC software : DMM Viewer, LabVIEW Driver

- Welcome Page
- Web Control
- View & Modify Configuration
- Contact us

GDM-8261A Welcome Page



Note

If the password dialog box or the Welcome Page fail to appear when WEB PW is set to ON, please ensure JavaScript and prompting for scripted windows are enabled in your web browser.

To show how to enable these settings, IE8 is used as an example:

To enable prompting for scripted windows, go to:

Tools>Internet Options>Security>Custom Level>Scripting>Allow websites to prompt for information using scripted windows>Enable

To enable JavaScript, go to:

Tools>Internet Options>Security>Custom Level>Scripting>Active scripting>Enable

2. Web Control

1. To start web control, click on the Web Control icon.



2. The virtual control panel appears.

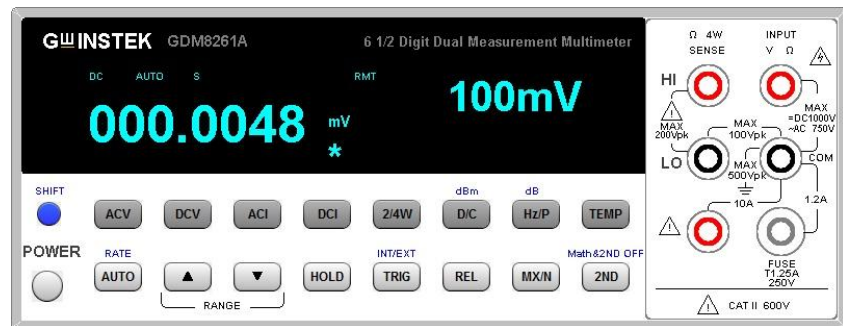

3. All the basic panel operations using the virtual control panel are nearly identical to using the actual GDM-8261A, with a few notable exceptions:

- The scan function is not accessible.
- Store/recall is not accessible.
- MX+B, 1/X, REF%, STATS and Compare is not accessible.
- Sensor is not accessible.
- The filter is not accessible.
- The configuration menu is not accessible.
- The shift key + 2nd key is used to turn off REL, MAX, MIN, Hold, dB, dBm and 2nd functions.

3. View and Modify LAN Configuration

The current Ethernet settings can be viewed and modified from the web control interface. Settings that cannot be edited using the GDM-8261A front panel, such as the web password, can be edited from the web control interface.

1. To edit or view the current configuration settings, click on the View & Modify Configuration icon.



2. The configuration settings appear.

Miscellaneous Settings

Name:	G8261A-00000000
Firmware Revision:	1.00
IP Address:	192.168.31.3
MAC Address:	00-1a-b6-00-02-74

IP Address Selection

Address Type:	DHCP/AutoIP ▾
Static IP Address:	192 . 168 . 0 . 1
Subnet Mask:	255 . 255 . 255 . 0
Default Gateway:	192 . 168 . 0 . 254
DNS:	0 . 0 . 0 . 0 , 0 . 0 . 0 . 0
<input type="button" value="Update Settings"/>	

General Configuration Settings

Module Name:	G8261A-00000000
UPnP port number:	6432
Telnet port number:	23
Telnet Timeout:	900 seconds(0 for no timeout)
<input type="button" value="Update Settings"/>	

Password Modify

Old Password:	<input type="text"/>	(3-6 characters alpha-numeric)
New Password:	<input type="text"/>	(3-6 characters alpha-numeric)
Confirm Password:	<input type="text"/>	
<input type="button" value="Modify"/>		

Restore Factory Defaults

Restore all options to their factory default states:	<input type="button" value="Restore Defaults"/>
--	---

3. The View & Modify Configuration page allows you to:
 - View the instrument name, firmware revision of the Ethernet card, IP address and MAC address.
 - Set the IP address to DHCP or static.
 - Configure the module host name, UPnP port number, telnet port number and telnet timeout time.
 - Modify the web password.
 - Restore the Ethernet card to the factory default settings (equivalent to the INIT function).

Command Syntax

The commands are partially compatible with IEEE488.2 (1992) and SCPI (1994) standard. Commands are NON-case sensitive.

Example command	CONF:VOLT:DC 10,MAX		1: Command Header
			2: Single space
	1	2 3 4 5	3: Parameter 1
			4: Comma (no space after comma)
			5: Parameter 2

Parameter example	Boolean	Boolean logic: 0 or 1. Used for On (1) or Off (0) command.
	NR1	Integer: 0, 1, 2, 3.....
	NR2	Decimal number: 0.0, 0.1, 0.2,....
	NR3	Floating point number: 4.5e-1, 8.5e+1,...
	NRf	Any NR1, NR2 or NR3 value.
	MIN, MAX	The GDM-8261A automatically translates to the Minimum (min) or Maximum (max) value available.
	DEF	Default setting value.

Automatic parameter range selection	The GDM-8261A automatically translates the command parameter into the closest available value.	
	Example 1	CONF:VOLT:DC 1 (Sets the measurement item to DC Voltage and the range to 1V).
	Example 2	CONF:VOLT:DC 2 (Sets the measurement item to DC Voltage and the range to 2V). There is no 2V range so the GDM-8261A selects the closest range, 10V.

Message Terminator (EOL)	Marks the end of a command line. The following messages are in accordance with IEEE488.2 standard.	
Remote Command	LF, CR, CR+LF	The most common EOL character is CR +LF
Return Message	User configurable (excluding GPIB) See page 140.	
Message Separator	EOL or ;	Command separator.
Square Brackets	[]	<p>Square brackets denote function commands or parameters that can be omitted from the command or query. For example the query, [SENSe:]UNIT? can be expressed in 2 valid forms:</p> <p>[SENSe:]UNIT? or UNIT?</p>

Command Set

CONFigure:VOLTage:DC.....	179
CONFigure:VOLTage:AC	179
CONFigure:CURRent:DC	179
CONFigure:CURRent:AC	179
CONFigure:RESistance	179
CONFigure:FRESistance	180
CONFigure:FREQuency	180
CONFigure:PERiod	180
CONFigure:CONTinuity.....	180
CONFigure:DIODe.....	180
CONFigure:TEMPerature:TCouple.....	180
CONFigure:TEMPerature:FRTD	180
CONFigure:TEMPerature:RTD	181
CONFigure:FUNction?.....	181
CONFigure:RANGe?	181
CONFigure:AUTO	181
CONFigure:AUTO?	181
CONFigure2:VOLTage:DC.....	181
CONFigure2:VOLTage:AC	182

CONFigure2:CURRent:DC.....	182
CONFigure2:CURRent:AC.....	182
CONFigure2:RESistance.....	182
CONFigure2:FRESistance.....	182
CONFigure2:FREQuency.....	183
CONFigure2:PERiod.....	183
CONFigure2:OFF.....	183
CONFigure2:FUNcTion?.....	183
CONFigure2:RANGe?.....	183
CONFigure2:AUTO.....	183
CONFigure2:AUTO?.....	183
MEASure:VOLTagE:DC?.....	184
MEASure:VOLTagE:AC?.....	184
MEASure:CURRent:DC?.....	184
MEASure:CURRent:AC?.....	184
MEASure:RESistance?.....	184
MEASure:FRESistance?.....	185
MEASure:FREQuency?.....	185
MEASure:PERiod?.....	185
MEASure:CONTinuity?.....	185
MEASure:DIODE?.....	185
MEASure:TEMPerature:TCouple?.....	185
MEASure:TEMPerature:FRTD?.....	186
MEASure:TEMPerature:RTD?.....	186
MEASure2:VOLTagE:DC?.....	186
MEASure2:VOLTagE:AC?.....	186
MEASure2:CURRent:DC?.....	186
MEASure2:CURRent:AC?.....	186
MEASure2:RESistance?.....	187
MEASure2:FRESistance?.....	187
MEASure2:FREQuency?.....	187
MEASure2:PERiod?.....	187
[SENSe:]TEMPerature:TCouple:TYPE.....	187
[SENSe:]TEMPerature:TCouple:TYPE?.....	187
[SENSe:]TEMPerature:RJUNction:SIMulated.....	188
[SENSe:]TEMPerature:RJUNction:SIMulated?.....	188
[SENSe:]TEMPerature:RTD:TYPE.....	188
[SENSe:]TEMPerature:RTD:TYPE?.....	188

[SENSe:]TEMPerature:RTD:ALPHA.....	188
[SENSe:]TEMPerature:RTD:ALPHA?	188
[SENSe:]TEMPerature:RTD:BETA	188
[SENSe:]TEMPerature:RTD:BETA?	188
[SENSe:]TEMPerature:RTD:DELTA.....	188
[SENSe:]TEMPerature:RTD:DELTA?	188
[SENSe:]TEMPerature:FRTD:TYPE	189
[SENSe:]TEMPerature:FRTD:TYPE?	189
[SENSe:]TEMPerature:FRTD:ALPHA	189
[SENSe:]TEMPerature:FRTD:ALPHA?	189
[SENSe:]TEMPerature:FRTD:BETA	189
[SENSe:]TEMPerature:FRTD:BETA?	189
[SENSe:]TEMPerature:FRTD:DELTA.....	189
[SENSe:]TEMPerature:FRTD:DELTA?	189
[SENSe:]DETEctor:RATE	189
[SENSe:]DETEctor:RATE?	189
[SENSe:]AVERage:TCONtrol	190
[SENSe:]AVERage:TCONtrol?	190
[SENSe:]AVERage:COUNt.....	190
[SENSe:]AVERage:COUNt?	190
[SENSe:]AVERage:WINDow	190
[SENSe:]AVERage:WINDow?	190
[SENSe:]AVERage:STATe.....	190
[SENSe:]AVERage:STATe?	190
[SENSe:]FILTer:STATe	191
[SENSe:]FILTer:STATe?	191
[SENSe:]FREQuency:APERture	191
[SENSe:]FREQuency:APERture?	191
[SENSe:]PERiod:APERture	191
[SENSe:]PERiod:APERture?	191
[SENSe:]FREQuency:INPutjack.....	191
[SENSe:]FREQuency:INPutjack?	191
[SENSe:]PERiod:INPutjack.....	191
[SENSe:]PERiod:INPutjack?	192
[SENSe:]DETEctor:BANDwidth	192
[SENSe:]DETEctor:BANDwidth?	192
[SENSe:]ZERO:AUTO	192
[SENSe:]ZERO:AUTO?	192

[SENSe:]GAIN:AUTO	192
[SENSe:]GAIN:AUTO?	192
[SENSe:]CONTInuity:THReshold.....	192
[SENSe:]CONTInuity:THReshold?	192
[SENSe:]CURRent:DETECT	192
[SENSe:]CURRent:DETECT?	193
[SENSe:]DIGital:SHIFt	193
[SENSe:]DIGital:SHIFt?.....	193
[SENSe:]UNIT.....	193
[SENSe:]UNIT?	193
[SENSe:]FUNctIon[1/2]?	193
[SENSe:]FUNctIon[1/2]	193
[SENSe:]VOLTagE:DC:RANGe.....	193
[SENSe:]VOLTagE:DC:RANGe?	194
[SENSe:]VOLTagE:AC:RANGe	194
[SENSe:]VOLTagE:AC:RANGe?	194
[SENSe:]CURRent:DC:RANGe	194
[SENSe:]CURRent:DC:RANGe?	194
[SENSe:]CURRent:AC:RANGe	194
[SENSe:]CURRent:AC:RANGe?	194
[SENSe:]RESistance:RANGe	194
[SENSe:]RESistance:RANGe?	194
[SENSe:]FREsistance:RANGe	195
[SENSe:]FREsistance:RANGe?	195
[SENSe:]FREQuency:VOLTagE:RANGe.....	195
[SENSe:]FREQuency:VOLTagE:RANGe?	195
[SENSe:]PERiod:VOLTagE:RANGe	195
[SENSe:]PERiod:VOLTagE:RANGe?	195
[SENSe:]VOLTagE:DC:RANGe:AUTO	195
[SENSe:]VOLTagE:DC:RANGe:AUTO?	195
[SENSe:]VOLTagE:AC:RANGe:AUTO	195
[SENSe:]VOLTagE:AC:RANGe:AUTO?	196
[SENSe:]CURRent:DC:RANGe:AUTO	196
[SENSe:]CURRent:DC:RANGe:AUTO?	196
[SENSe:]CURRent:AC:RANGe:AUTO	196
[SENSe:]CURRent:AC:RANGe:AUTO?	196
[SENSe:]RESistance:RANGe:AUTO	196
[SENSe:]RESistance:RANGe:AUTO?	196

[SENSe:]FREStance:RANGe:AUTO	196
[SENSe:]FREStance:RANGe:AUTO?	196
[SENSe:]FREQuency:VOLTage:RANGe:AUTO	197
[SENSe:]FREQuency:VOLTage:RANGe:AUTO?	197
[SENSe:]PERiod:VOLTage:RANGe:AUTO	197
[SENSe:]PERiod:VOLTage:RANGe:AUTO?	197
[SENSe:]VOLTage:DC:RESolution	197
[SENSe:]VOLTage:DC:RESolution?	197
[SENSe:]VOLTage:AC:RESolution	197
[SENSe:]VOLTage:AC:RESolution?	197
[SENSe:]CURRent:DC:RESolution	197
[SENSe:]CURRent:DC:RESolution?	198
[SENSe:]CURRent:AC:RESolution	198
[SENSe:]CURRent:AC:RESolution?	198
[SENSe:]RESistance:RESolution	198
[SENSe:]RESistance:RESolution?	198
[SENSe:]FREStance:RESolution	198
[SENSe:]FREStance:RESolution?	198
[SENSe:]CONTinuity:RESolution	198
[SENSe:]CONTinuity:RESolution?	198
[SENSe:]DIODE:RESolution	199
[SENSe:]DIODE:RESolution?	199
[SENSe:]TEMPerature:TCouple:RESolution	199
[SENSe:]TEMPerature:TCouple:RESolution?	199
[SENSe:]TEMPerature:FRTD:RESolution	199
[SENSe:]TEMPerature:FRTD:RESolution?	199
[SENSe:]TEMPerature:RTD:RESolution	199
[SENSe:]TEMPerature:RTD:RESolution?	199
[SENSe:]VOLTage:DC:NPLCycles	200
[SENSe:]VOLTage:DC:NPLCycles?	200
[SENSe:]CURRent:DC:NPLCycles	200
[SENSe:]CURRent:DC:NPLCycles?	200
[SENSe:]RESistance:NPLCycles	200
[SENSe:]RESistance:NPLCycles?	200
[SENSe:]FREStance:NPLCycles	201
[SENSe:]FREStance:NPLCycles?	201
CALCulate:FUNCTion	201
CALCulate:FUNCTion?	201

CALCulate:STATe	201
CALCulate:STATe?	201
CALCulate:MINimum?	201
CALCulate:MAXimum?	201
CALCulate:HOLD:REFerence.....	201
CALCulate:HOLD:REFerence?	202
CALCulate:REL:REFerence	202
CALCulate:REL:REFerence?	202
CALCulate:LIMit:LOWer	202
CALCulate:LIMit:LOWer?	202
CALCulate:LIMit:UPPer	202
CALCulate:LIMit:UPPer?	202
CALCulate:DB:REFerence	202
CALCulate:DB:REFerence?	202
CALCulate:DBM:REFerence	202
CALCulate:DBM:REFerence?	202
CALCulate:STORe:COUNT.....	203
CALCulate:STORe:COUNT?	203
CALCulate:AVERAge:COUNT.....	203
CALCulate:AVERAge:COUNT?	203
CALCulate:AVERAge:MINimum?	203
CALCulate:AVERAge:MAXimum?	203
CALCulate:AVERAge:AVERAge?	203
CALCulate:AVERAge:PTPeak?	203
CALCulate:AVERAge:SDEVIation?	203
CALCulate:MATH:MMFactor	204
CALCulate:MATH:MMFactor?	204
CALCulate:MATH:MBFactor	204
CALCulate:MATH:MBFactor?	204
CALCulate:MATH:PERCent.....	204
CALCulate:MATH:PERCent?	204
CALCulate:NULL:OFFSet.....	204
CALCulate:NULL:OFFSet?	204
READ?	204
VAL1?	205
VAL2?	205
TRIGger:SOURce	205
TRIGger:SOURce?	205

TRIGger:DElay	205
TRIGger:DElay?	205
TRIGger:AUTO	205
TRIGger:AUTO?	206
SAMPlE:COUNT	206
SAMPlE:COUNT?	206
TRIGger:COUNT	206
TRIGger:COUNT?	206
TRACe:DATA?	206
TRACe:CLear	206
SYSTem:BEEPer:STATe	207
SYSTem:BEEPer:STATe?	207
SYSTem:BEEPer:ERRor	207
SYSTem:BEEPer:ERRor?	207
SYSTem:ERRor?	207
SYSTem:VERSion?	207
SYSTem:DISPlay	207
SYSTem:DISPlay?	207
SYSTem:OUTPut:FORMat	207
SYSTem:OUTPut:FORMat?	208
SYSTem:OUTPut:EOF	208
SYSTem:OUTPut:EOF?	208
SYSTem:OUTPut:SEParate	208
SYSTem:OUTPut:SEParate?	208
SYSTem:SERial?	208
SYSTem:PARAmeter:SAVE	208
SYSTem:PARAmeter:LOAD	208
SYSTem:PARAmeter:LOAD?	208
SYSTem:SCPi:MODE	209
SYSTem:SCPi:MODE?	209
SYSTem:IDNStr	209
SYSTem:IDNStr?	209
STATus:QUEStionable:ENABle	210
STATus:QUEStionable:ENABle?	210
STATus:QUEStionable:EVENT?	210
STATus:PRESet	210
SYSTem:LOCAl	210
SYSTem:REMote	210

SYSTem:RWLock	210
*CLS	210
*ESE?	210
*ESE.....	210
*ESR?	211
*IDN?	211
*OPC?	211
*OPC	211
*PSC?	211
*PSC	211
*RST	211
*SRE?	211
*SRE	211
*STB?	211
*TRG.....	211
ROUTe:CLOSe.....	212
ROUTe:OPEN:ALL.....	212
ROUTe:MULTiple:OPEN	212
ROUTe:MULTiple:STATe?	212
ROUTe:MULTiple:CLOSe	212
ROUTe:FUNCTion	212
ROUTe:FUNCTion?	212
ROUTe:CHANnel	213
ROUTe:CHANnel?	213
ROUTe:COUNt.....	213
ROUTe:COUNt?	213
ROUTe:DELay.....	213
ROUTe:DELay?	213
ROUTe:STATe?	213
ROUTe:ADVance	214
ROUTe:ADVance?	214
ROUTe:SCAN:COUNt?	214
ROUTe:SCAN:FINal	214
ROUTe:SCAN:FINal?	214
ROUTe:SCAN:BOX.....	214
ROUTe:SCAN:BOX?	214
INPut:IMPedance:AUTO	214
INPut:IMPedance:AUTO?	214

	INITiate.....	214
	FETCh?.....	215
	DATA:POINts?.....	215

CONFigure Commands

CONFigure:VOLTage:DC

Sets measurement to DC Voltage on the first display and specifies range/resolution.

Parameter: [None] | [Range(<NRf> | MIN | MAX | DEF),Resolution(<NRf> | MIN | MAX | DEF)]

Example: CONF:VOLT:DC 1,MAX

Sets the voltage range to 1 volt and the resolution to the maximum.

CONFigure:VOLTage:AC

Sets measurement to AC Voltage on the first display and specifies range/resolution.

Parameter: [None] | [Range(<NRf> | MIN | MAX | DEF),Resolution(<NRf> | MIN | MAX | DEF)]

Example: CONF:VOLT:AC

Sets the AC voltage range and resolution to auto range.

CONFigure:CURRent:DC

Sets measurement to DC Current on the first display and specifies range/resolution.

Parameter: [None] | [Range(<NRf> | MIN | MAX | DEF),Resolution(<NRf> | MIN | MAX | DEF)]

Example: CONF:CURR:DC 10e-3,DEF

Sets the DC current range to 10mA using the default resolution.

CONFigure:CURRent:AC

Sets measurement to AC Current on the first display and specifies range/resolution.

Parameter: [None] | [Range(<NRf> | MIN | MAX | DEF),Resolution(<NRf> | MIN | MAX | DEF)]

Example: CONF:CURR:AC 10e-2,MAX

Sets the measurement mode to ACI with a 100mA range at the maximum resolution.

CONFigure:RESistance

Sets measurement to 2W Resistance on the first display and specifies range/resolution.

Parameter: [None] | [Range(<NRf> | MIN | MAX | DEF),Resolution(<NRf> | MIN | MAX | DEF)]

Example: CONF:RES 10e3,MIN

Sets the range to 10k Ω with the lowest resolution.

CONFigure:FRESistance

Sets measurement to 4W Resistance on the first display and specifies the range/resolution.

Parameter: [None] | [Range(<NRf> | MIN | MAX | DEF),Resolution(<NRf> | MIN | MAX | DEF)]

Example: CONF:FRES 10e3,MAX

Sets the measurement mode to 4W with a range of 10k Ω at the maximum resolution.

CONFigure:FREQuency

Sets measurement to Frequency on the first display and specifies range/resolution.

Parameter: [None] | [Range(<NRf> | MIN | MAX | DEF),Resolution(<NRf> | MIN | MAX | DEF)]

Example: CONF:FREQ MAX,MAX

Sets the frequency measurement range to max and the resolution to max.

CONFigure:PERiod

Sets measurement to Period on the first display and specifies the range/resolution.

Parameter: [None] | [Range(<NRf> | MIN | MAX | DEF),Resolution(<NRf> | MIN | MAX | DEF)]

Example: CONF:PER

Sets the DMM to period measurement using the previous range/resolution.

CONFigure:CONTInuity

Sets measurement to Continuity on the first display.

Parameter: None

CONFigure:DIODe

Sets measurement to Diode on the first display.

Parameter: None

CONFigure:TEMPerature:TCOuple

Sets measurement to Temperature thermocouple (T-CUP) on the first display.

Parameter: [None] | [Type(B | E | J | K | N | R | S | T)]

Example: CONF:TEMP:TCO J

Sets the measurement mode to TCO with a type J sensor.

CONFigure:TEMPerature:FRTD

Sets the measurement mode to 4W RTD measurement mode on the first display. Sets the sensor type.

Parameter: [None] | [Type(PT100 | D100 | F100 | PT385 | PT3916 | USER)]

Example: CONF:TEMP:FRTD PT100

Sets the sensor type to PT100 and sets the measurement mode to 4W RTD

CONFigure:TEMPerature:RTD

Sets the measurement mode to 2W RTD measurement mode on the first display. Sets the sensor type.

Parameter: [None] | [Type(PT100 | D100 | F100 | PT385 | PT3916 | USER)]

Example: CONF:TEMP:RTD PT100

Sets the sensor type to PT100 and sets the measurement mode to 2W RTD

CONFigure:FUNCTion?

Returns the current function on 1st display.

Return parameter: VOLT, VOLT:AC, CURR, CURR:AC, RES, FRES, FREQ, PER, TEMP:RTD, TEMP:FRTD, TEMP:TCO, DIOD, CONT

CONFigure:RANGe?

Returns the current range on 1st display.

Return Parameter:

DCV: 0.1(100mV), 1(1V), 10(10V), 100(100V), 1000(1000V)

ACV: 0.1(100mV), 1(1V), 10(10V), 100(100V), 750(750V)

ACI: 0.001 (1mA), 0.01(10mA), 0.1(100mA), 1(1A), 10(10A)

DCI: 0.0001 (100 μ A), 0.001 (1mA), 0.01(10mA), 0.1(100mA), 1(1A), 10(10A)

RES: 10E+1(100 Ω), 10E+2(1k Ω), 10E+3(10k Ω), 10E+4 (100k Ω), 10E+5(1M Ω), 10E+6(10M Ω), 10E+7(100M Ω)

CONFigure:AUTO

Sets Auto-Range on or off on the first display.

Parameter: ON | OFF

Example: CONF:AUTO ON

CONFigure:AUTO?

Returns the Auto-Range status of the function on the 1st display.

Return Parameter: 0|1, 1=Auto range, 0=Manual range

Secondary Display: CONFigure2 Commands

CONFigure2:VOLTage:DC

Sets measurement to DC Voltage on the second display and specifies range/resolution.

Parameter: [None] | [Range(<NRf> | MIN | MAX | DEF),Resolution(<NRf> | MIN | MAX | DEF)]

Example: CONF2:VOLT:DC 1,MAX

Sets the voltage range to 1 volt and the resolution to the maximum.

CONFigure2:VOLTage:AC

Sets measurement to AC Voltage on the second display and specifies range/resolution.

Parameter: [None] | [Range(<NRf> | MIN | MAX | DEF),Resolution(<NRf> | MIN | MAX | DEF)]

Example: CONF2:VOLT:AC

Sets the measurement mode to AC voltage.

CONFigure2:CURRent:DC

Sets measurement to DC Current on the second display and specifies range/resolution.

Parameter: [None] | [Range(<NRf> | MIN | MAX | DEF),Resolution(<NRf> | MIN | MAX | DEF)]

Example: CONF2:CURR:DC 10e-3,DEF

Sets the DC current range to 10mA using the default resolution on the second display.

CONFigure2:CURRent:AC

Sets measurement to AC Current on the second display and specifies range/resolution.

Parameter: [None] | [Range(<NRf> | MIN | MAX | DEF),Resolution(<NRf> | MIN | MAX | DEF)]

Example: CONF2:CURR:AC 10e-2,MAX

Sets the measurement mode to ACI with a 100mA range at the maximum resolution.

CONFigure2:RESistance

Sets measurement to 2W Resistance on the second display and specifies range/resolution.

Parameter: [None] | [Range(<NRf> | MIN | MAX | DEF),Resolution(<NRf> | MIN | MAX | DEF)]

Example: CONF2:RES 10e3,MIN

Sets the range to 10k Ω with the lowest resolution.

CONFigure2:FRESistance

Sets measurement to 4W Resistance on the second display and specifies the range/resolution.

Parameter: [None] | [Range(<NRf> | MIN | MAX | DEF),Resolution(<NRf> | MIN | MAX | DEF)]

Example: CONF2:FRES 10e3,MAX

Sets the measurement mode to 4W with a range of 10k Ω at the maximum resolution.

CONFigure2:FREQuency

Sets measurement to Frequency on the second display and specifies range/resolution.

Parameter: [None] | [Range(<NRf> | MIN | MAX | DEF),Resolution(<NRf> | MIN | MAX | DEF)]

Example: CONF2:FREQ MAX,MAX

Sets the frequency measurement range to max and the resolution to max.

CONFigure2:PERiod

Sets measurement to Period on the second display and specifies the range/resolution.

Parameter: [None] | [Range(<NRf> | MIN | MAX | DEF),Resolution(<NRf> | MIN | MAX | DEF)]

Example: CONF2:PER

Sets the DMM to period measurement using the previous range/resolution.

CONFigure2:OFF

Turns the second display function off.

Parameter: None.

CONFigure2:FUNcTION?

Returns the current function on the second display.

Return parameter: VOLT, VOLT:AC, CURR, CURR:AC, RES, FRES, FREQ, PER, NON

CONFigure2:RANGe?

Returns the range of the current function on the second display.

Return parameter:

DCV: 0.1(100mV), 1(1V), 10(10V), 100(100V), 1000(1000V)

ACV: 0.1(100mV), 1(1V), 10(10V), 100(100V), 750(750V)

ACI: 0.001 (1mA), 0.01 (10mA), 0.1 (100mA), 1 (1A), 10(10A)

DCI: 0.001 (1mA), 0.01 (10mA), 0.1 (100mA), 1 (1A), 10(10A)

RES: 10E+1 (100Ω) 10E+2 (1kΩ), 10E+3 (10kΩ), 10E+4 (100kΩ), 10E+5 (1MΩ), 10E+6 (10MΩ), 10E+7 (100MΩ)

CONFigure2:AUTO

Sets Auto-Range on or off on the 2nd display.

Parameter: ON | OFF

Example: CONF2:AUTO ON

CONFigure2:AUTO?

Returns the Auto-Range status of the function on the 2nd display.

Return Parameter: 0|1, 1=Auto range, 0=Manual range

Measure Commands

MEASure:VOLTage:DC?

Returns the DC voltage measurement on the first display.

Parameter: [None] | [Range(<NRf> | MIN | MAX | DEF),Resolution(<NRf> | MIN | MAX | DEF)]

Example: MEAS:VOLT:DC ?

>+0.488E-4

Returns the DC voltage measurement as 0.0488 mV.

MEASure:VOLTage:AC?

Returns the AC voltage measurement on the first display.

Parameter: [None] | [Range(<NRf> | MIN | MAX | DEF),Resolution(<NRf> | MIN | MAX | DEF)]

Example: MEAS:VOLT:AC ?

>+0.511E-3

Returns the AC voltage measurement as 0.511 mV.

MEASure:CURRent:DC?

Returns the DC current measurement on the first display.

Parameter: [None] | [Range(<NRf> | MIN | MAX | DEF),Resolution(<NRf> | MIN | MAX | DEF)]

Example: MEAS:CURR:DC ?

>+0.234E-4

Returns the DC current measurement as 0.0234 mA.

MEASure:CURRent:AC?

Returns the AC current measurement on the first display.

Parameter: [None] | [Range(<NRf> | MIN | MAX | DEF),Resolution(<NRf> | MIN | MAX | DEF)]

Example: MEAS:CURR:AC ?

> +0.387E-2

Returns the AC current measurement.

MEASure:RESistance?

Returns the 2W resistance measurement on the first display.

Parameter: [None] | [Range(<NRf> | MIN | MAX | DEF),Resolution(<NRf> | MIN | MAX | DEF)]

Example: MEAS:RES?

> +1.181372E+6

Returns the 2W measurement.

MEASure:FRESistance?

Returns the 4W resistance measurement on the first display.

Parameter: [None] | [Range(<NRf> | MIN | MAX | DEF),Resolution(<NRf>| MIN | MAX | DEF)]

Example: MEAS:FRES?

> +1.181372E+6

Returns the 4W measurement.

MEASure:FREQuency?

Returns the frequency measurement on the first display.

Parameter: [None] | [Range(<NRf> | MIN | MAX | DEF),Resolution(<NRf>| MIN | MAX | DEF)]

Example: MEAS:FREQ?

> +0.215029E+5

Returns the frequency (21.5 kHz).

MEASure:PERiod?

Returns the period measurement on the first display.

Parameter: [None] | [Range(<NRf> | MIN | MAX | DEF),Resolution(<NRf>| MIN | MAX | DEF)]

Example: MEAS:PER? MAX

Returns the period at the maximum range.

MEASure:CONTInuity?

Returns the continuity measurement on the first display.

Example: MEAS:CONT?

Returns the continuity.

MEASure:DIODE?

Returns the diode measurement on the first display.

Example: MEAS:DIOD?

Returns the diode measurement.

MEASure:TEMPerature:TCouple?

Returns the temperature for the selected thermocouple type on the first display.

Parameter:[NONE] | B | E | J | K | N | R | S | T

Example: MEAS:TEMP:TCO? J

> +0.26348E+2

Returns the temperature.

MEASure:TEMPerature:FRTD?

Returns the 4W RTD temperature for the selected sensor type on the first display.

Parameter:[NONE] | PT100 | D100 | F100 | PT385 | PT3916 | USER

Example: MEAS:TEMP:FRTD? PT100

> +0.20050E+5

Returns the temperature.

MEASure:TEMPerature:RTD?

Returns the 2W RTD temperature for the selected sensor type on the first display.

Parameter:[NONE] | PT100 | D100 | F100 | PT385 | PT3916 | USER

Example: MEAS:TEMP:RTD? PT100

> +0.20050E+5

Returns the temperature.

MEASure2:VOLTage:DC?

Returns the DC voltage measurement on the second display.

Parameter: [None] | [Range(<NRf> | MIN | MAX | DEF),Resolution(<NRf>| MIN | MAX | DEF)]

Example: MEAS2:VOLT:DC ?

>+0.488E-4

Returns the DC voltage measurement as 0.0488 mV.

MEASure2:VOLTage:AC?

Returns the AC voltage measurement on the second display.

Parameter: [None] | [Range(<NRf> | MIN | MAX | DEF),Resolution(<NRf>| MIN | MAX | DEF)]

Example: MEAS2:VOLT:AC ?

>+0.511E-3

Returns the AC voltage measurement as 0.511 mV.

MEASure2:CURRent:DC?

Returns the DC current measurement on the second display.

Parameter: [None] | [Range(<NRf> | MIN | MAX | DEF),Resolution(<NRf>| MIN | MAX | DEF)]

Example: MEAS2:CURR:DC ?

>+0.234E-4

Returns the DC current measurement as 0.0234 mA.

MEASure2:CURRent:AC?

Returns the AC current measurement on the second display.

Parameter: [None] | [Range(<NRf> | MIN | MAX | DEF),Resolution(<NRf>| MIN | MAX | DEF)]

Example: MEAS2:CURR:AC ?

> +0.387E-2

Returns the AC current measurement.

MEASure2:RESistance?

Returns the 2W resistance measurement on the second display.

Parameter: [None] | [Range(<NRf> | MIN | MAX | DEF),Resolution(<NRf>| MIN | MAX | DEF)]

Example: MEAS2:RES?

> +1.181372E+6

Returns the 2W measurement.

MEASure2:FRESistance?

Returns the 4W resistance measurement on the second display.

Parameter: [None] | [Range(<NRf> | MIN | MAX | DEF),Resolution(<NRf>| MIN | MAX | DEF)]

Example: MEAS2:FRES?

> +1.181372E+6

Returns the 4W measurement.

MEASure2:FREQuency?

Returns the frequency measurement on the second display.

Parameter: [None] | [Range(<NRf> | MIN | MAX | DEF),Resolution(<NRf>| MIN | MAX | DEF)]

Example: MEAS2:FREQ?

> +0.215029E+5

Returns the frequency (21.5 kHz).

MEASure2:PERiod?

Returns the period measurement on the second display.

Parameter: [None] | [Range(<NRf> | MIN | MAX | DEF),Resolution(<NRf>| MIN | MAX | DEF)]

Example: MEAS2:PER? MAX

Returns the period at the maximum range.

SENSE Commands

[SENSe:]TEMPerature:TCouple:TYPE

Sets thermocouple type.

Parameter: Type(B | E | J | K | N | R | S | T)

Example: SENS:TEMP:TCO:TYPE J

Sets the thermocouple to type J.

[SENSe:]TEMPerature:TCouple:TYPE?

Returns the thermocouple type.

Return parameter: B, E, J, K, N, R, S, T

[SENSe:]TEMPerature:RJUNction:SIMulated

Set temperature simulation value.

Parameter: <NRf> (0.00 ~ 50.00)

Example: SENS:TEMP:RJUN:SIM 25.00

Sets the thermocouple junction temperature to 25°C.

[SENSe:]TEMPerature:RJUNction:SIMulated?

Returns temperature simulation value.

Return parameter: <NR1> (+0000~+5000) ,where +0000=0.00°C,
+5000=50.00°C

[SENSe:]TEMPerature:RTD:TYPE

Sets the 2W RTD sensor type.

Return parameter: Type (PT100 | D100 | F100 | PT385 | PT3916 | USER)

Example: SENS:TEMP:RTD:TYPE PT100

Sets the 2W RTD sensor to PT100

[SENSe:]TEMPerature:RTD:TYPE?

Returns the 2W RTD sensor type.

Return parameter: PT100, D100, F100, PT385, PT3916, USER

[SENSe:]TEMPerature:RTD:ALPHa

Sets the 2W RTD Alpha coefficient.

Parameter: <NRf> (0~10)

Example: SENS:TEMP:RTD:ALPH 0.00385

[SENSe:]TEMPerature:RTD:ALPHa?

Returns the 2W RTD Alpha coefficient.

[SENSe:]TEMPerature:RTD:BETA

Sets the 2W RTD BETA coefficient.

Parameter: <NRf> (0~10)

Example: SENS:TEMP:RTD:BETA 0.00495

[SENSe:]TEMPerature:RTD:BETA?

Returns the 2W RTD BETA coefficient.

[SENSe:]TEMPerature:RTD:DELTA

Sets the 2W RTD DELTA coefficient.

Parameter: <NRf> (0~10)

Example: SENS:TEMP:RTD:DELT 0.0000568

[SENSe:]TEMPerature:RTD:DELTA?

Returns the 2W RTD DELTA coefficient.

[SENSe:]TEMPerature:FRTD:TYPE

Sets the 4W RTD sensor type.

Parameter: Type(PT100 | D100 | F100 | PT385 | PT3916 | USER)

Example: SENS:TEMP:FRTD:TYPE PT100

Sets the 4W RTD sensor to PT100

[SENSe:]TEMPerature:FRTD:TYPE?

Returns the 4W RTD sensor type.

Return parameter: PT100, D100, F100, PT385, PT3916, USER

[SENSe:]TEMPerature:FRTD:ALPHa

Sets the 4W RTD Alpha coefficient.

Parameter: <NRf> (0~10)

Example: SENS:TEMP:FRTD:ALPH 0.00385

[SENSe:]TEMPerature:FRTD:ALPHa?

Returns the 4W RTD Alpha coefficient.

[SENSe:]TEMPerature:FRTD:BETA

Sets the 4W RTD BETA coefficient.

Parameter: <NRf> (0~10)

Example: SENS:TEMP:FRTD:BETA 0.00495

[SENSe:]TEMPerature:FRTD:BETA?

Returns the 4W RTD BETA coefficient.

[SENSe:]TEMPerature:FRTD:DELTA

Sets the 4W RTD DELTA coefficient.

Parameter: <NRf> (0~10)

Example: SENS:TEMP:FRTD:DELT 0.0000568

[SENSe:]TEMPerature:FRTD:DELTA?

Returns the 4W RTD DELTA coefficient.

[SENSe:]DETECTOR:RATE

Sets the detection rate (sample rate)

Parameter: RATE(S | M | F)

Example: SENS:DET:RATE S

Sets the rate to slow (S).

[SENSe:]DETECTOR:RATE?

Returns the sample rate.

Return parameter: SLOW, MID, FAST

[SENSe:]AVERage:TCONtrol

Selects the digital filter.

Parameter: MOV | REP

Example: SENS: AVER: TCON MOV

Sets the digital filter to the Moving filter.

[SENSe:]AVERage:TCONtrol?

Returns the current digital filter type.

Return parameter: MOV (moving), REP (repeating)

[SENSe:]AVERage:COUNt

Sets the digital filter count.

Parameter: <NR1> (2 ~ 100) | MIN | MAX

Example: SENS: AVER: COUN 100

Sets the digital filter count number to 100.

[SENSe:]AVERage:COUNt?

Returns the digital filter count.

Return parameter: <NR1> (+002~+100)

[SENSe:]AVERage:WINDow

Selects a digital filter window

Parameters: 0.01 | 0.1 | 1 | 10 | NONE

Example: SENS: AVER: WIND 0.1

Sets the digital filter window to 0.1%

[SENSe:]AVERage:WINDow?

Return the current digital filter window value

Return parameters: 0.01, 0.1, 1, 10, NONE

[SENSe:]AVERage:STATe

Turns the digital filter On/Off.

Parameter: ON | OFF

Example: SENS: AVER: STAT ON

Turns the digital filter on.

[SENSe:]AVERage:STATe?

Returns the state of the digital filter (on or off).

Return parameter: 0|1, 0=OFF, 1=ON

[SENSe:]FILTEr:STATe

Turns the analog filter On/Off.

Parameter: ON | OFF

Example: SENS:FILT:STAT ON

Turns the analog filter on.

[SENSe:]FILTEr:STATe?

Returns the state of the analog filter (on or off).

Return parameter: 0|1, 0=OFF, 1=ON

[SENSe:]FREQUency:APERture

Sets the aperture time (gate time) for the frequency function (0.01=F, 0.1=M, 1=S).

Parameter: (0.01 | 0.1 | 1)

Example: SENS:FREQ:APER 0.01

Sets the gate time to 0.01 seconds.

[SENSe:]FREQUency:APERture?

Returns aperture time (gate time) for the frequency function.

[SENSe:]PERiod:APERture

Sets the aperture time (gate time) for the period function(0.01=F, 0.1=M, 1=S).

Parameter: <NRf>(0.01 | 0.1 | 1)

Example: SENS:PER:APER 0.1

Sets the gate time to 0.1 seconds for the period function.

[SENSe:]PERiod:APERture?

Returns the aperture time (gate time) for the period function.

[SENSe:]FREQUency:INPutjack

Assigns an input port for the frequency function.

Parameter: (0|1|2) 0=volt, 1=1A, 2=10A

Example: SENS:FREQ:INP 0

Sets the input jack to the Volt input port.

[SENSe:]FREQUency:INPutjack?

Returns the assigned input port used for the frequency function.

Return Parameter: VOLT, 1A, 10A

[SENSe:]PERiod:INPutjack

Assigns an input port for the period function.

Parameter: (0|1|2) 0=volt, 1=1A, 2=10A

Example: SENS:PER:INP 0

Sets the input jack to the Volt input port.

[SENSe:]PERiod:INPutjack?

Returns the assigned input port used for the period function.

Return Parameter: VOLT, 1A, 10A

[SENSe:]DETEctor:BANDwidth

Sets the AC bandwidth (AC filter).

Parameter: (3 | 20 | 200)

Example: SENS:DET:BAND 20

Sets the AC bandwidth to 20Hz.

[SENSe:]DETEctor:BANDwidth?

Returns the AC bandwidth.

[SENSe:]ZERO:AUTO

Sets the Auto zeroing mode to on, off or once only.

Parameter: ON | OFF | ONCE

Example: SENS:ZERO:AUTO ONCE

Sets the auto zeroing to once only.

[SENSe:]ZERO:AUTO?

Returns the Auto zero mode.

Return Parameter: 0|1, 1=ON, 0=OFF

[SENSe:]GAIN:AUTO

Sets the Auto gain mode to on, off or once only.

Parameter: ON | OFF | ONCE

Example: SENS:GAIN:AUTO OFF

Turns the Auto gain mode off.

[SENSe:]GAIN:AUTO?

Returns the Auto gain mode.

Return parameter: 0|1, 1=ON, 0=OFF

[SENSe:]CONTInuity:THReshold

Sets the continuity threshold in ohms.

Parameter: <NRf> (0 ~ 1000)

Example: SENS:CONT:THR 500

Sets the continuity threshold to 500

[SENSe:]CONTInuity:THReshold?

Returns the continuity threshold.

[SENSe:]CURRent:DETEct

Sets the current auto-detect mode on or off for the current functions.

Parameter: ON | OFF

Example: SENS:CURR:DET ON

Turns the current auto-detect on for the current function.

[SENSe:]CURRent:DETECT?

Returns the auto-detect status for the current functions.

Return Parameter: 0|1 1=ON, 0=OFF

[SENSe:]DIGital:SHIFt

Sets the Digital Shift function on or off.

Parameter: ON | OFF

Example: SENS:DIG:SHIF ON

Turn the digital shift function on.

[SENSe:]DIGital:SHIFt?

Returns the Digital Shift function status.

Return Parameter: 0|1 1=ON, 0=OFF

[SENSe:]UNIT

Sets the temperature unit.

Parameter: C|F

Example: SENS:UNIT C

Sets the temperature unit to °C.

[SENSe:]UNIT?

Returns the temperature unit.

[SENSe:]FUNCTion[1/2]?

Returns the function displayed on the first or second display.

Return parameter:

(display 1): VOLT, VOLT:AC, CURR, CURR:AC, RES, FRES, FREQ, PER,

TEMP:RTD, TEMP:FRTD, TEMP:TCO, DIOD, CONT

(display 2): VOLT, VOLT:AC, CURR, CURR:AC, RES, FRES, FREQ, PER, NON

[SENSe:]FUNCTion[1/2]

Sets the function for the first or second display.

Parameter:

(display1): "VOLT[:DC]", "VOLT:AC", "CURR[:DC]", "CURR:AC", "RES",

"FRES", "FREQ", "PER", "TEMP:RTD", "TEMP:FRTD", "TEMP:TCO",

"DIOD", "CONT"

(display2): "VOLT[:DC]", "VOLT:AC", "CURR[:DC]", "CURR:AC", "RES",

"FRES", "FREQ", "PER", "NON"

Example: SENS:FUNCT1 "VOLT:DC"

Sets the 1st display to the DCV function.

[SENSe:]VOLTage:DC:RANGe

Sets the DC Voltage measurement range.

Parameter: (<NRF> | MIN | MAX)

Example: SENS:VOLT:DC:RANG MIN

Set the DC voltage range to lowest range allowed.

[SENSe:]VOLTage:DC:RANGe?

Returns the DC Voltage measurement range.

Parameter: [None] | [MIN | MAX]

[SENSe:]VOLTage:AC:RANGe

Sets the AC Voltage measurement range.

Parameter: (<NRf> | MIN | MAX)

Example: SENS:VOLT:AC:RANG MIN

Set the AC voltage range to lowest range allowed.

[SENSe:]VOLTage:AC:RANGe?

Returns the AC Voltage measurement range.

Parameter: [None] | [MIN | MAX]

[SENSe:]CURRent:DC:RANGe

Sets the DC Current measurement range.

Parameter: Range(<NRf> | MIN | MAX)

Example: SENS:CURR:DC:RANG 10 e-2

Sets the DC current range to 100mA.

[SENSe:]CURRent:DC:RANGe?

Returns the DC Current measurement range.

Parameter: [None] | [MIN | MAX]

[SENSe:]CURRent:AC:RANGe

Sets the AC Current measurement range.

Parameter: Range(<NRf> | MIN | MAX)

Example: SENS:CURR:AC:RANG 10 e-2

Sets the AC current range to 100mA.

[SENSe:]CURRent:AC:RANGe?

Returns the AC Current measurement range.

Parameter: [None] | [MIN | MAX]

[SENSe:]RESistance:RANGe

Sets the 2W resistance measurement range.

Parameter: Range(<NRf> | MIN | MAX)

Example: SENS:RES:RANG 1000

Sets the resistance range to 1kΩ.

[SENSe:]RESistance:RANGe?

Returns the 2W resistance measurement range.

Parameter: [None] | [MIN | MAX]

[SENSe:]FRESistance:RANGe

Sets the 4W resistance measurement range.

Parameter: Range(<NRf> | MIN | MAX)

Example: SENS:FRES:RANG 1000

Sets the 4W resistance range to 1kΩ.

[SENSe:]FRESistance:RANGe?

Returns the 4W resistance measurement range.

Parameter: [None] | [MIN | MAX]

[SENSe:]FREQuency:VOLTage:RANGe

Sets the frequency measurement range.

Parameter: Range(<NRf> | MIN | MAX)

Example: SENS:FREQ:VOLT:RANG MIN

Sets the frequency to the minimum frequency range.

[SENSe:]FREQuency:VOLTage:RANGe?

Returns the frequency measurement range.

Parameter: [None] | [MIN | MAX]

[SENSe:]PERiod:VOLTage:RANGe

Sets the period measurement range.

Parameter: Range(<NRf> | MIN | MAX)

Example: SENS:PER:VOLT:RANG MIN

Sets the period to the minimum range.

[SENSe:]PERiod:VOLTage:RANGe?

Returns the period measurement range.

Return parameter: [None] | [MIN | MAX]

[SENSe:]VOLTage:DC:RANGe:AUTO

Sets the DC voltage Auto range on/off.

Parameter: ON | OFF

Example: SENS:VOLT:DC:RANG:AUTO ON

Turns Auto-range on for DC voltage measurements.

[SENSe:]VOLTage:DC:RANGe:AUTO?

Returns the DC voltage Auto-range settings.

Return parameter: 0|1, 0=OFF, 1=ON

[SENSe:]VOLTage:AC:RANGe:AUTO

Sets the AC voltage Auto range on/off.

Parameter: ON|OFF

Example: SENS:VOLT:AC:RANG:AUTO ON

Turns Auto-range on for AC voltage measurements.

[SENSe:]VOLTage:AC:RANGe:AUTO?
Returns the AC voltage Auto-range settings.
Return parameter: 0|1, 0=OFF, 1=ON

[SENSe:]CURRent:DC:RANGe:AUTO
Sets the DC Current Auto-range settings on/off.
Parameter: ON|OFF
Example: SENS:CURR:DC:RANG:AUTO OFF
Turns Auto-range off for DC current measurements.

[SENSe:]CURRent:DC:RANGe:AUTO?
Returns the DC current Auto-range settings.
Return parameter: 0|1, 0=OFF, 1=ON

[SENSe:]CURRent:AC:RANGe:AUTO
Sets the AC Current Auto-range settings on/off.
Parameter: ON|OFF
Example: SENS:CURR:AC:RANG:AUTO OFF
Turns Auto-range off for AC current measurements.

[SENSe:]CURRent:AC:RANGe:AUTO?
Returns the AC current Auto-range settings.
Return parameter: 0|1, 0=OFF, 1=ON

[SENSe:]RESistance:RANGe:AUTO
Sets the 2W resistance Auto-range settings on/off.
Parameter: ON|OFF
Example: SENS:RES:RANG:AUTO ON
Turns Auto-range on for 2W resistance measurements.

[SENSe:]RESistance:RANGe:AUTO?
Returns the 2W resistance Auto-range setting.
Return parameter: 0|1, 0=OFF, 1=ON

[SENSe:]FRESistance:RANGe:AUTO
Sets the 4W resistance Auto-range settings on/off.
Parameter: ON|OFF
Example: SENS:FRES:RANG:AUTO ON
Turns Auto-range on for 4W resistance measurements.

[SENSe:]FRESistance:RANGe:AUTO?
Returns the 4W resistance Auto-range setting.
Return parameter: 0|1, 0=OFF, 1=ON

[SENSe:]FREQUency:VOLTage:RANGe:AUTO
Sets the Frequency Auto-range settings on/off.
Parameter: ON|OFF
Example: SENS:FREQ:VOLT:RANG:AUTO ON
Turns the Auto-range on for the frequency function.

[SENSe:]FREQUency:VOLTage:RANGe:AUTO?
Returns the frequency Auto-range setting.
Return parameter: 0|1, 0=OFF, 1=ON

[SENSe:]PERiod:VOLTage:RANGe:AUTO
Sets the Period Auto-range settings on/off.
Parameter: ON|OFF
Example: SENS:PER:VOLT:RANG:AUTO OFF
Turns the Auto-range setting off for period measurements.

[SENSe:]PERiod:VOLTage:RANGe:AUTO?
Returns the Period Auto-range setting.
Return parameter: 0|1, 0=OFF, 1=ON

[SENSe:]VOLTage:DC:RESolution
Sets the DC Voltage measurement resolution. The resolution depends on the rate and range settings.
Parameter: Resolution(<NRf> | MIN | MAX)
Example: SENS:VOLT:DC:RES MAX
Sets the DC Voltage resolution to MAX.

[SENSe:]VOLTage:DC:RESolution?
Returns the DC Voltage resolution.
Parameter: [None] | [MIN | MAX]

[SENSe:]VOLTage:AC:RESolution
Sets the AC Voltage measurement resolution. The resolution depends on the rate and range settings.
Parameter: Resolution(<NRf> | MIN | MAX)
Example: SENS:VOLT:AC:RES MAX
Sets the AC Voltage resolution to MAX.

[SENSe:]VOLTage:AC:RESolution?
Returns the AC Voltage resolution.
Parameter: [None] | [MIN | MAX]

[SENSe:]CURRent:DC:RESolution
Sets the DC Current measurement resolution. The resolution depends on the rate and range settings.
Parameter: Resolution(<NRf> | MIN | MAX)
Example: SENS:CURR:DC:RES 0.01
Sets the DC Current resolution to 0.01

[SENSe:]CURRent:DC:RESolution?

Returns the DC Current resolution.

Parameter: [None] | [MIN | MAX]

[SENSe:]CURRent:AC:RESolution

Sets the AC Current measurement resolution. The resolution depends on the rate and range settings.

Parameter: Resolution(<NRf> | MIN | MAX)

Example: SENS:CURR:AC:RES 0.0001

Sets the AC Current resolution to 0.0001

[SENSe:]CURRent:AC:RESolution?

Returns the AC Current resolution.

Parameter: [None] | [MIN | MAX]

[SENSe:]RESistance:RESolution

Sets the 2W Resistance measurement resolution. The resolution depends on the rate and range settings.

Parameter: Resolution(<NRf> | MIN | MAX)

Example: SENS:RES:RES 0.01

Sets the 2W Resistance resolution to 0.01

[SENSe:]RESistance:RESolution?

Returns the 2W Resistance resolution.

Parameter: [None] | [MIN | MAX]

[SENSe:]FRESistance:RESolution

Sets the 4W Resistance measurement resolution. The resolution depends on the rate and range settings.

Parameter: Resolution(<NRf> | MIN | MAX)

Example: SENS:FRES:RES 0.01

Sets the 4W Resistance resolution to 0.01

[SENSe:]FRESistance:RESolution?

Returns the 4W Resistance resolution.

Parameter: [None] | [MIN | MAX]

[SENSe:]CONTInuity:RESolution

Sets the Continuity measurement resolution. The resolution depends on the rate and range settings.

Parameter: Resolution(<NRf> | MIN | MAX)

Example: SENS:CONT:RES 0.001

Sets the Continuity resolution to 0.001

[SENSe:]CONTInuity:RESolution?

Returns the Continuity measurement resolution.

Parameter: [None] | [MIN | MAX]

[SENSe:]DIODe:RESolution

Sets the Diode measurement resolution. The resolution depends on the rate and range settings.

Parameter: Resolution(<NRf> | MIN | MAX)

Example: SENS:DIOD:RES 0.1e-4

Sets the Diode resolution to 0.00001

[SENSe:]DIODe:RESolution?

Returns the Diode measurement resolution.

Parameter: [None] | [MIN | MAX]

[SENSe:]TEMPerature:TCouple:RESolution

Sets the thermocouple (T-CUP) measurement resolution. The resolution depends on the rate and range settings.

Parameter: Resolution(<NRf> | MIN | MAX)

Example: SENS:TEMP:TCO:RES MAX

Sets the thermocouple resolution to the maximum.

[SENSe:]TEMPerature:TCouple:RESolution?

Returns the thermocouple measurement resolution.

Parameter: [None] | [MIN | MAX]

[SENSe:]TEMPerature:FRTD:RESolution

Sets the 4W RTD measurement resolution. The resolution depends on the rate and range settings.

Parameter: Resolution(<NRf> | MIN | MAX)

Example: SENS:TEMP:FRTD:RES MAX

Sets the 4W RTD resolution to the maximum.

[SENSe:]TEMPerature:FRTD:RESolution?

Returns the 4W RTD measurement resolution.

Parameter: [None] | [MIN | MAX]

[SENSe:]TEMPerature:RTD:RESolution

Sets the 2W RTD measurement resolution. The resolution depends on the rate and range settings.

Parameter: Resolution(<NRf> | MIN | MAX)

Example: SENS:TEMP:RTD:RES MAX

Sets the 2W RTD resolution to the maximum.

[SENSe:]TEMPerature:RTD:RESolution?

Returns the 2W RTD measurement resolution.

Parameter: [None] | [MIN | MAX]

[SENSe:]VOLTage:DC:NPLCycles

Sets the integration time for DC Voltage measurements in PLCs (power line cycles). Where one PLC is equal to 16.6 milliseconds. For any <NRf> parameter, the DMM will automatically set the PLC to the closest acceptable PLC value (0.025, 0.1, 0.25, 1, 2, 12).

Parameter: NPLCycles(<NRf> | MIN | MAX)

Example: SENS:VOLT:DC:NPLC 12

Sets the integration time to 12 PLCs for DC Voltage.

[SENSe:]VOLTage:DC:NPLCycles?

Returns the integration time for DC Voltage measurement in PLCs (power line cycles). Where one PLC is equal to 16.6 milliseconds.

Return parameter: 0.025, 0.1, 0.25, 1, 2, 12

[SENSe:]CURRent:DC:NPLCycles

Sets the integration time for DC Current measurements in PLCs (power line cycles). Where one PLC is equal to 16.6 milliseconds. For any <NRf> parameter, the DMM will automatically set the PLC to the closest acceptable PLC value (0.025, 0.1, 0.25, 1, 2, 12).

Parameter: NPLCycles(<NRf> | MIN | MAX)

Example: SENS:CURR:DC:NPLC 2

Sets the integration time to 2 PLCs for DC Current.

[SENSe:]CURRent:DC:NPLCycles?

Returns the integration time for DC Current measurement in PLCs (power line cycles). Where one PLC is equal to 16.6 milliseconds.

Return parameter: 0.025, 0.1, 0.25, 1, 2, 12

[SENSe:]RESistance:NPLCycles

Sets the integration time for 2W resistance measurements in PLCs (power line cycles). Where one PLC is equal to 16.6 milliseconds. For any <NRf> parameter, the DMM will automatically set the PLC to the closest acceptable PLC value (0.025, 0.1, 0.25, 1, 2, 12).

Parameter: NPLCycles(<NRf> | MIN | MAX)

Example: SENS:RES:NPLC MIN

Sets the integration time to 0.025 PLCs for 2W resistance measurements.

[SENSe:]RESistance:NPLCycles?

Returns the integration time for 2W resistance measurements in PLCs (power line cycles). Where one PLC is equal to 16.6 milliseconds.

Return parameter: 0.025, 0.1, 0.25, 1, 2, 12

[SENSe:]FRESistance:NPLCycles

Sets the integration time for 4W resistance measurements in PLCs (power line cycles). Where one PLC is equal to 16.6 milliseconds. For any <NRf> parameter, the DMM will automatically set the PLC to the closest acceptable PLC value (0.025, 0.1, 0.25, 1, 2, 12).

Parameter: NPLCycles(<NRf> | MIN | MAX)

Example: SENS:FRES:NPLC MAX

Sets the integration time to the maximum for 4W resistance measurements.

[SENSe:]FRESistance:NPLCycles?

Returns the integration time for 4W resistance measurements in PLCs (power line cycles). Where one PLC is equal to 16.6 milliseconds.

Return parameter: 0.025, 0.1, 0.25, 1, 2, 12

CALCulate Commands

CALCulate:FUNCTion

Sets the Advanced function.

Parameter: OFF | MIN | MAX | HOLD | REL | COMP | DB | DBM | STORE | AVER | MXB | INV | REF

Example: CALC:FUNC REL

Sets the Advanced function to REL (relative)

CALCulate:FUNCTion?

Returns the current Advanced function.

CALCulate:STATe

Turns the Advanced function on/off.

Parameter: ON|OFF

Example: CALC:STAT OFF

Turns the Advanced function off.

CALCulate:STATe?

Returns the status of the Advanced function.

Return Parameter: 0 | 1, 1=ON, 0=OFF

CALCulate:MINimun?

Returns the minimum value from the Max/Min measurement.

CALCulate:MAXimun?

Returns the maximum value from the Max/Min measurement.

CALCulate:HOLD:REFerence

Sets the percentage threshold for the Hold function.

Parameter: <NRf> (0.01, 0.1, 1, 10)

Example: CALC:HOLD:REF 10

Sets the hold percentage to 10%.

CALCulate:HOLD:REFerence?

Returns the percentage threshold from the Hold function.

CALCulate:REL:REFerence

Sets the reference value for the relative function.

Parameter: <NRf> | MIN | MAX

Example: CALC:REL:REF MAX

Sets the reference value to the maximum allowed.

CALCulate:REL:REFerence?

Returns the reference value from the relative function.

CALCulate:LIMit:LOWer

Sets the lower limit of the compare function.

Parameter: <NRf> | MIN | MAX

Example: CALC:LIM:LOW 1.0

Sets the lower limit to 1.0

CALCulate:LIMit:LOWer?

Returns the lower limit of the compare function.

CALCulate:LIMit:UPPer

Sets the upper limit of the compare function.

Parameter: <NRf> | MIN | MAX

Example: CALC:LIM:UPP 1.0

Sets the upper limit to 1.0

CALCulate:LIMit:UPPer?

Returns the upper limit of the compare function.

CALCulate:DB:REFerence

Sets the reference value for the dB function.

Parameter: <NRf> | MIN | MAX

Example: CALC:DB:REF MAX

Sets the reference voltage for dB measurements to the maximum allowed.

CALCulate:DB:REFerence?

Returns the reference voltage from the dB function.

CALCulate:DBM:REFerence

Sets the resistance value for the dBm function.

Parameter: <NRf> | MIN | MAX

Example: CALC:DBM:REF MAX

Sets the resistance value for dBm measurements to the maximum allowed.

CALCulate:DBM:REFerence?

Returns the resistance value from the dBm function.

CALCulate:STORe:COUNT

Set the number of measurement counts that are recorded with the Store measurement function.

Parameter: <NR1> (2 ~ 9999) | MIN | MAX

Example: CALC:STOR:COUN 1000

Sets the number of counts to be recorded as 1000.

CALCulate:STORe:COUNT?

Returns the number of counts that are recorded with the Store measurement function.

Parameter: [None] | MIN | MAX

CALCulate:AVERAge:COUNT

Sets the total number of statistic counts.

Parameter: <NR1> (0, 2~100000) 0=continuous count, 2~100000=count

Example: CALC:AVER:COUN 0

Sets the count to continuous.

CALCulate:AVERAge:COUNT?

Returns the total number of recorded counts. The setting commands for this query are: CALCulate:STORe:COUNT, ROUTe:COUNT and CALCulate:AVERAge:COUNT.

Parameter: None | <NR1> (0~2) 0=Store, 1=Scan, 2=Stats

Example: CALC:AVER:COUN? 0

>+0010

Returns the total number of counts set for the Store function (10 counts).

CALCulate:AVERAge:MINimum?

Returns the minimum recorded value.

Parameter: None | <NR1>(0~2) 0=Store, 1=Scan, 2=Stats

CALCulate:AVERAge:MAXimum?

Returns the maximum recorded value.

Parameter: None | <NR1>(0~2) 0=Store, 1=Scan, 2=Stats

CALCulate:AVERAge:AVERAge?

Returns the average recorded value.

Parameter: None | <NR1> (0~2) 0=Store, 1=Scan, 2=Stats

CALCulate:AVERAge:PTPeak?

Returns the recorded peak to peak value (max value – min value).

Parameter: None | <NR1> (0|1|2) 0=Store, 1=Scan, 2=Stats

Return Parameter: <NRf>

CALCulate:AVERAge:SDEVIation?

Returns the recorded Standard Deviation.

Parameter: None | <NR1> (0~2) 0=Store, 1=Scan, 2=Stats

CALCulate:MATH:MMFactor

Sets the scale factor M for math measurements.

Parameter: <NRf> | MIN | MAX

Example: CALC:MATH:MMF MIN

Sets the scale factor M to the minimum allowed value.

CALCulate:MATH:MMFactor?

Returns the scale factor M used in the math measurement.

CALCulate:MATH:MBFactor

Sets the offset factor B for math measurements.

Parameter: <NRf> | MIN | MAX

Example: CALC:MATH:MBF MIN

Sets the offset factor B to the minimum allowed value.

CALCulate:MATH:MBFactor?

Returns the offset factor B used in the math measurement.

CALCulate:MATH:PERCent

Sets the reference value for the Percent function.

Parameter: <NRf> | MIN | MAX

Example: CALC:MATH:PERC MAX

Sets the reference value for the Percent function to the maximum.

CALCulate:MATH:PERCent?

Returns the reference value setting for the Percent function.

CALCulate:NULL:OFFSet

Sets the reference value for the relative function. This command is analogous to the CALCulate:REL:REference command.

Parameter: <NRf> | MIN | MAX

Example: CALC:NULL:OFFS MAX

Sets the reference value to the maximum allowed.

CALCulate:NULL:OFFSet?

Returns the reference value from the relative function. This query is analogous to the CALCulate:REL:REference? query.

TRIGger Commands

READ?

Returns 1st and 2nd display value. The Read query will not return the unit or count number of the reading.

VAL1?

Returns the 1st display reading in the unit format specified in the Configuration menu (Return Format, page 142) or from the SYSTem:OUTPut:FORMat command (page 207).

Example: SAMP:COUN 100

VAL1?

>+0.333E-4,V DC

>+0.389E-4,V DC

> etc, for 100 counts.

Queries 100 counts of stored samples from the 1st display.

VAL2?

Returns the 2nd display reading in the unit format specified in the Configuration menu (Return Format, page 142) or from the SYSTem:OUTPut:FORMat command (page 207).

Example: SAMP:COUN 100

VAL2?

>+0.345E-4,V DC

>+0.391E-4,V DC

> etc, for 100 counts.

Queries 100 counts of stored samples from the 2nd display.

TRIGger:SOURce

Selects the trigger source.

Parameter: INT | EXT

Example: TRIG:SOUR INT

Sets the trigger source as internal.

TRIGger:SOURce?

Returns current trigger source.

TRIGger:DELay

Sets the trigger delay in milliseconds

Parameter: <NRf>(0 ~ 9999) | MIN | MAX

Example: TRIG:DEL MAX

Sets the trigger delay to the maximum.

TRIGger:DELay?

Returns the trigger delay time in milliseconds.

Parameter: None | MIN | MAX

TRIGger:AUTO

Turns Trigger Auto mode on/off.

Parameters: ON | OFF

Example: TRIG:AUTO OFF

Turns the Trigger Auto mode off.

TRIGger:AUTO?

Returns the Trigger Auto mode.

Return parameter: 0|1, 0=OFF, 1=ON

SAMPle:COUNT

Sets the number of samples.

Parameter: <NR1>(1 ~ 9999) | MIN | MAX

Example: SAMP:COUNT 10

Sets the number of samples to 10.

SAMPle:COUNT?

Returns the number of samples.

Parameter: None | MIN | MAX

TRIGger:COUNT

Sets the number of trigger counts.

Parameter: <NR1>(1 ~ 9999) | MIN | MAX

Example: TRIG:COUNT 10

Sets the number of trigger counts to 10.

TRIGger:COUNT?

Returns the number of trigger counts.

Parameter: None | MIN | MAX

TRACe:DATA?

Returns the buffer contents of the last logged/recorded measurements.

TRACe:CLEAr

Clears the buffer contents.

SYSTEM Related Commands

SYSTEM:BEEP:STATE

Selects the beeper mode; no beep, beep on fail and beep on pass.

Parameter: <NR1>(0 | 1 | 2) 0=no beep, 2=fail, 1=pass

Example: SYST:BEEP:STAT 0

Turns the beeper off.

SYSTEM:BEEP:STATE?

Returns the beeper mode.

Return parameter: Beep on Pass | Beep on Fail | No Beep

SYSTEM:BEEP:ERROR

Sets the beeper to sound on an SCPI error.

Parameter: ON | OFF

Example: SYST:BEEP:ERR ON

Allows the beeper to sound when an SCPI error occurs.

SYSTEM:BEEP:ERROR?

Returns the beeper error mode.

Return parameter: 0|1, 0=OFF, 1=ON

SYSTEM:ERROR?

Returns the current system error, if any.

SYSTEM:VERSION?

Returns system version.

Return Parameter: X.XX.

SYSTEM:DISPLAY

Turns the Display on/off.

Parameter: ON | OFF

Example: SYST:DISP ON

Turns the display on.

SYSTEM:DISPLAY?

Returns the status of the display

Return parameter: 0|1, 0=OFF, 1=ON

SYSTEM:OUTPUT:FORMAT

Sets the output format for the VAL1?, VAL2?, TRACe:DATA? and FETC? queries. The measured value (V) can be set to be displayed with the measurement units (U) and/or with the count number (C).

Parameter: <NR1>(0 ~ 3) 0=V, 1=V+U, 2=V+C, 3=V+U+C

Example: SYST:OUTP:FORM 3

SYSTem:OUTPut:FORMat?

Returns the output format.

Return parameter: (0|1|2|3) (0=V, 1=V+U, 2=V+C, 3=V+U+C)

SYSTem:OUTPut:EOF

Sets the EOL character (CR+LF, LF, CR).

Parameter: <NR1>(0 | 1 | 2) (0=CR+LF, 1=LF, 2=CR)

Example: SYST:OUTP:EOF 0

Sets the EOL character as CR+LF.

SYSTem:OUTPut:EOF?

Returns the EOL character.

Return parameter: <NR1>(0 | 1 | 2) (0=CR+LF, 1=LF, 2=CR)

SYSTem:OUTPut:SEParate

Sets the command separation character.

Parameter: <Boolean>(0|1) (0=EOL, 1=,)

Example: SYST:OUTP:SEP 0

Sets the command separation character as the EOL character.

SYSTem:OUTPut:SEParate?

Returns the command separation character.

Return parameter: <Boolean>(0|1) (0=EOL, 1=,)

SYSTem:SERial?

Returns the serial number (eight characters/numbers)

SYSTem:PARAmeter:SAVE

Saves the system parameters into 1 of 5 memory slots.

Parameter: <NR1> (1~5)

Example: SYST:PAR:SAVE 1

Saves the system parameters to memory 1.

SYSTem:PARAmeter:LOAD

Load the system parameters from 1 of 6 memory locations.

Parameter: <NR1> (0~5) (0=Default settings, 1~5= memory number)

Example: SYST:PAR:LOAD 0

Loads the default system parameters.

SYSTem:PARAmeter:LOAD?

Returns the loaded system parameters.

Return parameter: <NR1> (0~5) (0=Default settings, 1~5= memory number)

SYSTem:SCPi:MODE

Sets the SCPI mode. The SCPI mode is used to determine whether the *IDN? query returns the “Normal” or “Compatible” identification string .

See the SYSTem:IDNStr command for details.

Parameter: NOR | COMP (NOR=Normal, COMP= Compatible)

Example: SYST:SCP:MODE NOR

Sets the SCPI mode to normal.

SYSTem:SCPi:MODE?

Returns the SCPI mode. The SCPI mode is used to determine whether the *IDN? query returns the “Normal” or “Compatible” identification string .

See the SYSTem:IDNStr command for details.

Return parameter: NORMAL | COMPATIBLE

SYSTem:IDNStr

Sets a user-defined identification string for the *IDN? query when the SYSTem:SCPi:MODE command is set to “Compatible”.

Parameter: <“manufacturer”>, <“model number”>

Example: SYST:IDNS “ADCDE”, “12345”

Sets the user-defined manufacturer as ABCDE and the model number as 12345.

SYSTem:IDNStr?

Returns the manufacturer and model number set with the SYSTem:IDNStr command.

Return parameter: manufacturer, model number

Example: SYST:IDNS?

>ABCDE, 12345

Returns the manufacturer as ABCDE and the model number as 12345.

STATus Report Commands

STATus:QUESTionable:ENABLE

Set bits in the Questionable Data Enable register.

STATus:QUESTionable:ENABLE?

Returns the contents of the Questionable Data Enable register.

STATus:QUESTionable:EVENT?

Returns the contents of the Questionable Data Event register.

STATus:PRESet

Clears the Questionable Data Enable register.

Example: STAT:PRES

RS-232C Interface Commands

SYSTem:LOCal

Enables local control (front panel control) and disables remote control.

SYSTem:REMote

Enables remote control and disables local control (front panel control)

SYSTem:RWLock

Enables remote control and disables local control (front panel control). This command is analogous to the SYSTem:REMote command.

IEEE 488.2 Common Commands

*CLS

Clears the Event Status register (Output Queue, Operation Event Status, Questionable Event Status, Standard Event Status)

*ESE?

Returns the ESER (Event Status Enable Register) contents.

Example: *ESE?

>130

Returns 130. ESER=10000010

*ESE

Sets the ESER contents.

Parameter: <NR1> (0~255)

Example: *ESE 65

Sets the ESER to 01000001

***ESR?**

Returns SESR (Standard Event Status Register) contents.

Example: *ESR?

>198

Returns 198. SESR=11000110

***IDN?**

Returns the manufacturer, model No., serial number and system version number.

Example: *IDN?

>GWInstek,GDM8261A,00000000,1.0

***OPC?**

“1” is placed in the output queue when all the pending operations are completed.

***OPC**

Sets operation complete bit (bit0) in SERS (Standard Event Status Register) when all pending operations are completed.

***PSC?**

Returns power On clear status.

Return parameter: <Boolean>(0|1) 0= don't clear, 1=clear

***PSC**

Clears power On status.

Parameter: <Boolean>(0|1) 0=don't clear, 1= clear

***RST**

Recalls default panel setup.

***SRE?**

Returns the SRER (Service Request Enable Register) contents.

***SRE**

Sets SRER contents.

Parameter: <NR1>(0~255)

Example: *SRE 7

Sets the SRER to 00000111.

***STB?**

Returns the SBR (Status Byte Register) contents.

Example:*STB?

>81

Returns the contents of the SBR as 01010001.

***TRG**

Manually triggers the GDM-8261A.

ROUTe Commands

ROUTe:CLOSe

Close a specified scanner channel.

Parameter: <NR1>(101~118)

Example: ROUT:CLOS 102

Closes channel 102.

ROUTe:OPEN:ALL

Opens all scanner channels.

ROUTe:MULTiple:OPEN

Enable all channels in a specified range. Channels that are not in the range are not affected.

Parameter: <NR1>(101~118)

Example: ROUT:MULT:OPEN 105,110

Channels 105 to 110 are enabled.

ROUTe:MULTiple:STATe?

Returns the status of all the scanner channels that are open.

Return parameter: 101 OFF, 102 ON, 103 ON etc.

ROUTe:MULTiple:CLOSe

Disable channels in a specified range.

Parameter: <NR1> (101~118)

Example: ROUT:MULT:CLOS 105,110

Disables channels 105~110.

ROUTe:FUNCTion

Enables scan related functions

Parameter: OFF | SCAN | STEP

Example: ROUT:FUNC SCAN

Enables the SCAN function.

ROUTe:FUNCTion?

Returns the Scan related function status.

ROUTe:CHANnel

Advanced configuration mode for the scanner channels. The channel function, voltage and Auto-range mode can be configured.

Parameter: Channel(<NR1>), Function(String), Range(<NRf>),
Auto Range(ON|OFF)

Function: 1(VOLT), 2(VOLT:AC), 3(CURR [DCI]), 4(CURR:AC [ACI]), 7(RES),
8(FREQ), 9(TEMP:TCO:C), 13(CONT), 14(PER), 15(TEMP:TCO:F),
16(FRES), 17(DIOD), 18(TEMP:RTD:C), 19(TEMP:FRTD:C),
20(TEMP:RTD:F), 21(TEMP:FRTD:F)

Range: <NRf>

Autorange: 0=Off, 1=On

Example: ROUT:CHAN 101,1,1,0

Sets channel 1 (101) to VOLT (1), 1V range (1) and disables Auto-range (0).

ROUTe:CHANnel?

Returns the advanced channel configuration settings of each channel. See the ROUTe:CHANnel command for return parameters.

Return parameter: Channel, Function, Range, Auto Range

Example: ROUT:CHAN? 101
> 101,VOLT,0.1,ON

Returns channel 101, function is VOLT with range at 0.1V and Auto range on.

ROUTe:COUNt

Set the number of counts for the scan.

Parameter: <NR1>(1 ~ 999) | MIN | MAX

Example: ROUT:COUN 50

Sets the scan count to 50 counts.

ROUTe:COUNt?

Returns the number of counts for the scan.

Parameter: None | MIN | MAX

ROUTe:DELAy

Set the Delay timer for the scan in milliseconds.

Parameter: <NR3> (0 ~ 9999) | MIN | MAX

Example: ROUT:DEL 100

Sets the delay time to 100 milliseconds.

ROUTe:DELAy?

Returns the Delay timer settings.

Parameter: None | MIN | MAX

ROUTe:STATe?

Queries whether the scanner box is installed or not.

Return parameter: Boolean(0|1) 0=not installed, 1=installed

ROUTe:ADVance

Turns the scanner Advanced mode on/off.

Parameter: ON|OFF

Example: ROUT:ADV OFF

Turns advanced scanner mode off.

ROUTe:ADVance?

Returns the advanced mode status (on/off).

Return parameter: <Boolean>(0|1) (0=OFF, 1=ON)

ROUTe:SCAN:COUNT?

Returns the current scan count number.

Return parameter: <NR1>(1~999)

ROUTe:SCAN:FINal

Configures the DMM to send a "SCAN OK" message at the completion of the scan.

Parameter: ON | OFF

Example: ROUT:SCAN:FIN ON

"SCAN OK" will be sent at the completion of the scan.

ROUTe:SCAN:FINal?

Returns the status of the ROUTe:SCAN:FINal command.

Return parameter: <Boolean>(0|1) (0=OFF, 1=ON)

ROUTe:SCAN:BOX

Sets type of scanner box (voltage/current).

Parameter: Volt | Curr

Example: ROUT:SCAN:BOX VOLT

Sets the scanner box type to voltage.

ROUTe:SCAN:BOX?

Returns the configured scanner box type.

Return parameter: VOLT | CURR

INPut:IMPedance:AUTO

Sets the Automatic input impedance for DCV mode.

Parameter: ON|OFF

Example: INP:IMP:AUTO ON

Turns the Automatic input impedance on.

INPut:IMPedance:AUTO?

Returns the Automatic input impedance mode.

Return parameter: <Boolean>(0|1) (0=OFF, 1=ON)

INITiate

Set the trigger system to wait-for-trigger mode and to store readings.

FETCh?

Transfer the stored readings to the output buffer.

DATA:POINts?

Returns the number of readings.

Parameter: None | <NR1> (0~2) 0=Store, 1=Scan, 2=Stats

For the following command sets, please refer to the status system diagram on page 224

STAT: QUES: EVEN?
STAT: QUES: ENAB
STAT: QUES: ENAB?
*ESR?
*ESE
*ESE?
*STB?
*SRE
*SRE?

FAQ

- I pressed the EXIT key but cannot get out of Scanner mode.
 - The GDM-8261A performance does not match the specifications.
-

I pressed the EXIT key but cannot get out of Scanner mode.

Press the Exit key, followed by the ACV (Scan) or DCV (Step) key.

The GDM-8261A performance does not match the specifications.

Make sure the device is powered On for at least 1 hour. This is necessary to stabilize the unit to match the specifications.

How can I achieve the fastest measurement speed

To achieve the fastest measurement speed, the DMM must use the internal trigger and must also be used in remote control mode using the USB interface. The following settings should also be set remotely:

1. The measurement mode and/or range settings applicable for the measurement. For example:

DCI:

CONF:CURR:DC 1 (see page 182)

SENS:CURR:DC:NPLC 0.025 (see page 200)

DCV:

CONF:VOLT:DC 1 (see page 179)

SENS:VOLT:DC:NPLC 0.025 (see page 200)

2W:

CONF:RES 1000 (see page 182)

SENS:RES:NPLC 0.025 (see page 200)

4W:

CONF:FRES 1000 (see page 182)

SENS:FRES:NPLC 0.025 (see page 201)







2. SYST: DISP OFF
 3. SYST: OUTP:FORM 0
 4. TRIG:DEL 0
 5. SENS: AVER: STAT OFF
 6. SAMP: COUN 2400
 7. VAL1 ?
-

If there is still a problem, please contact your local dealer or GWInstek at marketing@goodwill.com.tw.

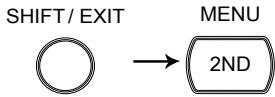
APPENDIX

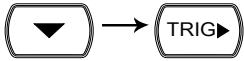
System Info	Firmware Version	219
Fuse Replacement	Replace AC Source Fuse	220
	Replace Input Current Fuse	221
Menu Tree	Menu Tree	222
Status system	Status system	224
Specifications	General	225
	DC Characteristics ^[3]	226
	AC Characteristics ^[1]	228
	Frequency and Period Characteristics	231
	Temperature Characteristics	232
	Dimensions	233
EC Declaration	Declaration of Conformity	234

Firmware Version

Background	Firmware version is available from the system menu.	
Firmware version	Shows the GDM-8261A firmware version number.	
View firmware version	1. Press the Shift key followed by the 2nd (Menu) key. The system menu appears.	
		
	2. Press the Down key followed by the Right key. The firmware version menu appears.	
		
	3. Press the Down key. The firmware version appears.	
		
	4. Press the Exit key to go back to the default display.	

Fuse Replacement

Replace AC Source Fuse

Steps

1. Take off the power cord and remove the fuse socket using a minus driver.

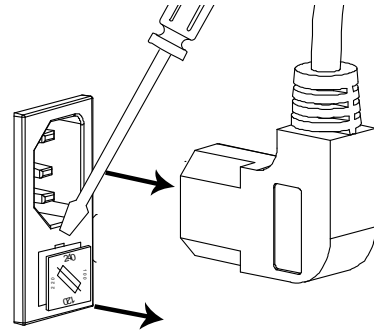

2. Replace the fuse in the holder.

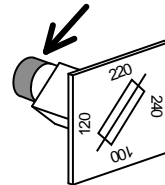

3. Ensure the correct line voltage is lined up with the arrow on the fuse holder. Insert the fuse socket.

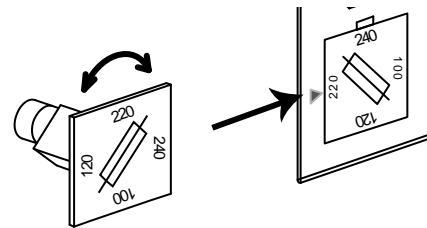

Rating

0.315AT, 100/120VAC; 0.125AT, 220/240VAC

Replace Input Current Fuse

- Step 1. Press the Fuse holder.

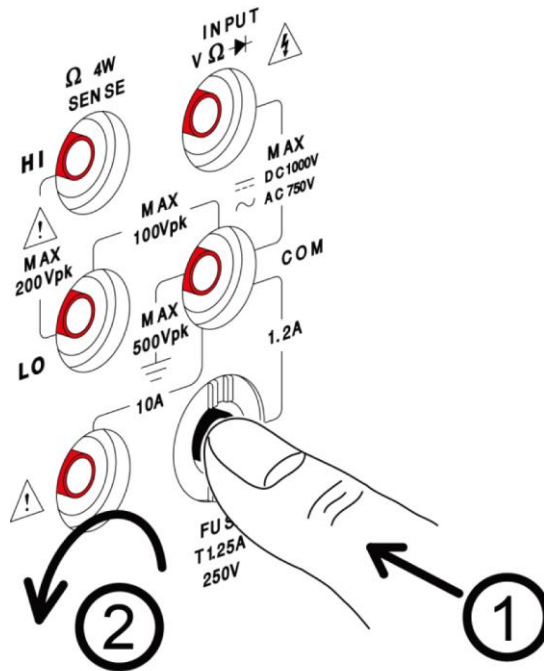

2. The fuse holder comes out. Replace the fuse inserted at the end of the holder.

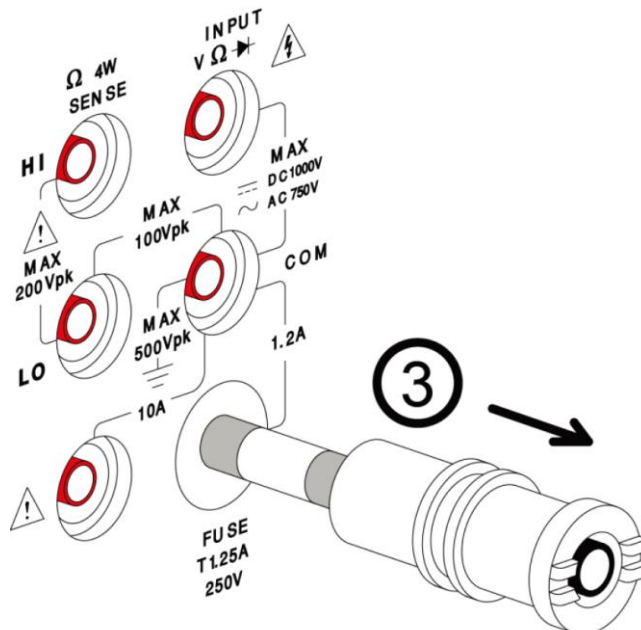

Rating T1.25A, 250V

Menu Tree

Menu Tree

Background The menu tree diagram shown on the next page represents the configuration menu that is accessed by pressing the Shift key and 2ND (Menu) key. The menu tree is arranged as a three-level tree structure.

Menu Tree Navigation

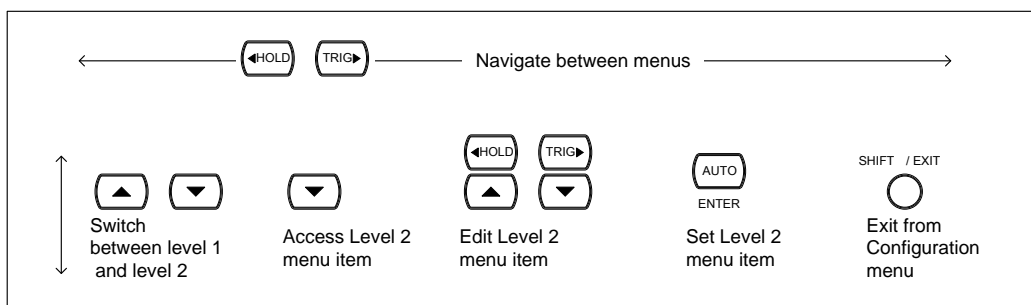

Continued next page.

Configuration Menu Tree

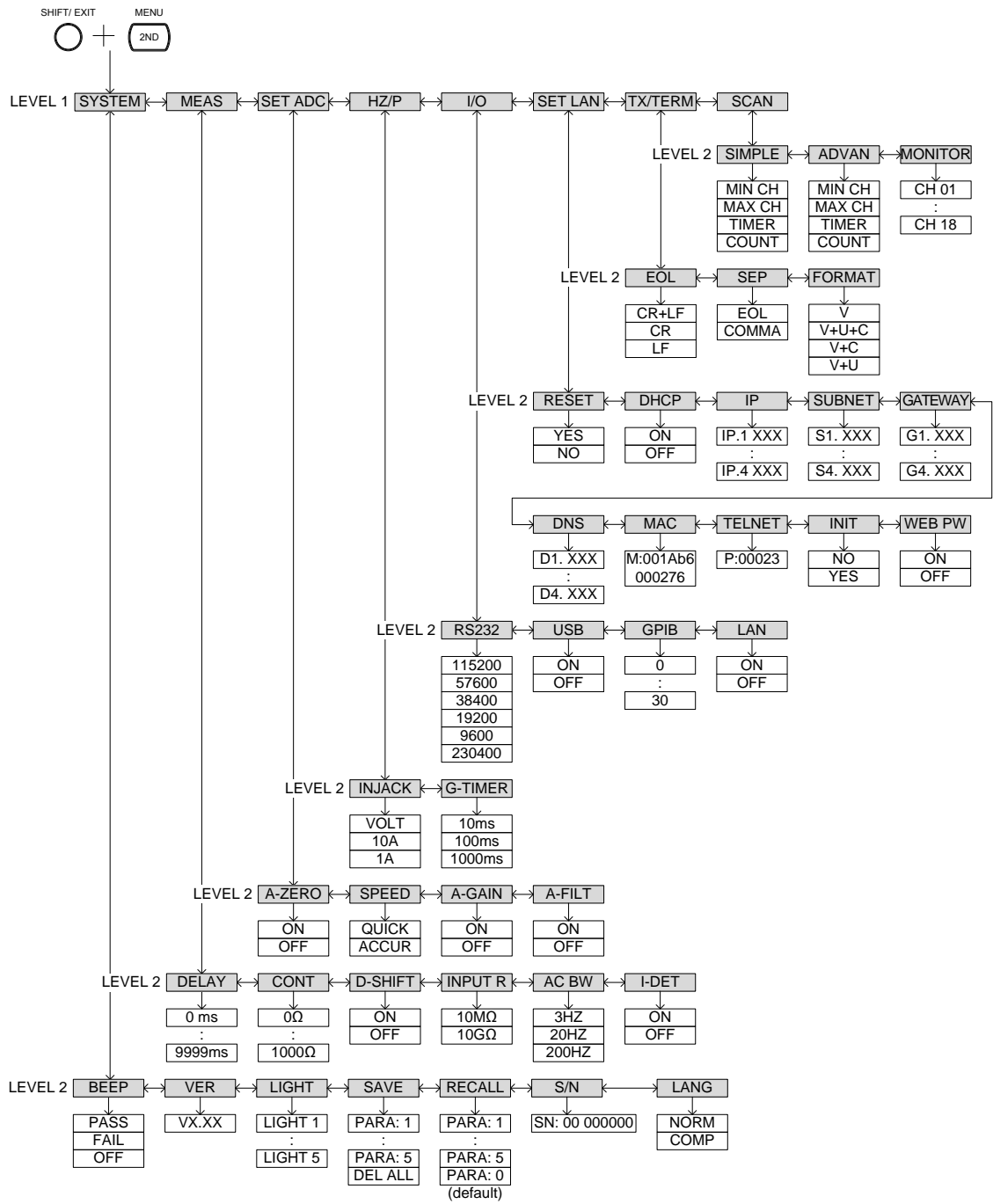

Status system

The diagram below is a description of the status system

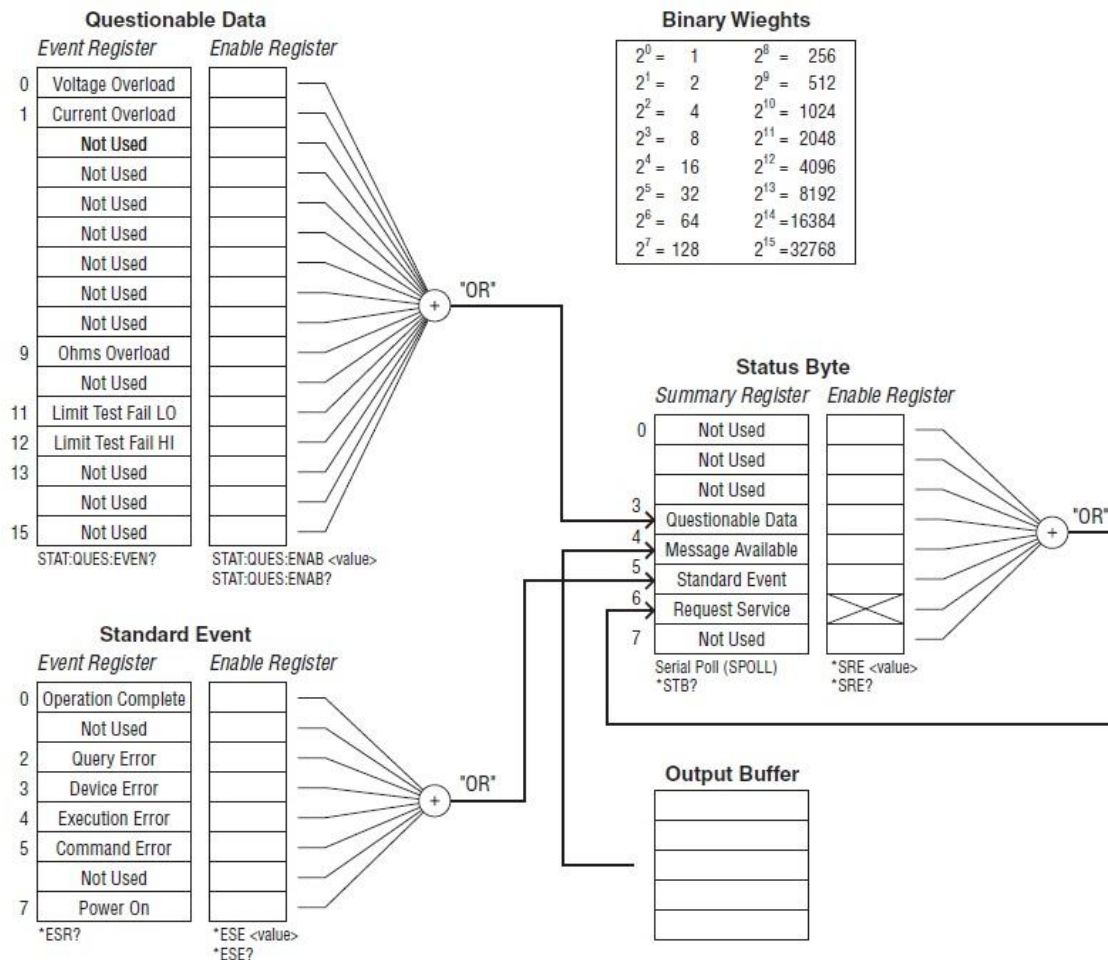

For the following command sets, please refer to the diagram above.

- STAT: QUES: EVEN?
- STAT: QUES: ENAB
- STAT: QUES: ENAB?
- *ESR?
- *ESE
- *ESE?
- *STB?
- *SRE
- *SRE?

Specifications

General



Note

- All specifications are ensured only under a single display.
- At least 1 hour of warm-up time is required before applying these specifications.
- Make sure that the Sense LO terminal to COM port is limited to 100V_{pk}, the Sense HI to Sense LO terminals are limited to 200V_{pk} and the COM port to earth is limited to 500V_{pk}. CAT II 600V. MAX DC1000V, AC 750V

Power Supply	100 V / 120 V / 220 V / 240 V ±10%
Power Line Frequency	45 Hz to 66 Hz and 360 Hz to 440 Hz
Operating Environment	Full accuracy for 0°C to 55°C, Full accuracy to 80% R.H. at 40°C
Storage Environment	-40°C to 70°C
Power Consumption	Max 25VA
Dimensions	265 mm (W) X 107 mm (H) X 350 mm (D)
Weight	Approximately 3.1 kg

DC Characteristics [3]

DC Voltage [1]

Range [4]	24 Hour 23°C±1°C	90 Day 23°C±5°C	1 Year 23°C±5°C	Temperature Coefficient/°C [6]
100.0000 mV	0.0030 + 0.0030	0.0040 + 0.0035	0.0050 + 0.0035	0.0005 + 0.0005
1.000000 V	0.0015 + 0.0004	0.0020 + 0.0005	0.0035 + 0.0005	0.0005 + 0.0001
10.00000 V	0.0020 + 0.0006	0.0030 + 0.0007	0.0048 + 0.0007	0.0005 + 0.0001
100.0000 V	0.0020 + 0.0006	0.0035 + 0.0006	0.0081 + 0.0006	0.0005 + 0.0001
1000.000 V	0.0025 + 0.0006	0.0044 + 0.0010	0.0090 + 0.0010	0.0005 + 0.0001

Accuracy Specifications: ± (% of reading + % of range)

Resistance [1] [4] [5] [9]

Range [4]	Test Current	24 Hour 23°C±1°C	90 Day 23°C±5°C	1 Year 23°C±5°C	Temperature Coefficient/°C [6]
100.0000 Ω	1 mA	0.0030 + 0.0030	0.008 + 0.004	0.010 + 0.004	0.0008 + 0.0005
1.000000 kΩ	1 mA	0.0020 + 0.0005	0.008 + 0.001	0.010 + 0.001	0.0008 + 0.0001
10.00000 kΩ	100µA	0.0020 + 0.0005	0.008 + 0.001	0.010 + 0.001	0.0008 + 0.0001
100.0000 kΩ	10µA	0.0020 + 0.0005	0.008 + 0.001	0.010 + 0.001	0.0008 + 0.0001
1.000000 MΩ	3.5µA	0.002 + 0.001	0.008 + 0.001	0.010 + 0.001	0.0010 + 0.0002
10.00000 MΩ	350nA	0.015 + 0.001	0.020 + 0.001	0.040 + 0.001	0.0030 + 0.0004
100.0000 MΩ	350 nA// 10 MΩ	0.300 + 0.010	0.800 + 0.010	0.800 + 0.010	0.1500 + 0.0002

Accuracy Specifications: ± (% of reading + % of range)

DC Current [1]

Range [4]	Burden Voltage	24 Hour 23°C±1°C	90 Day 23°C±5°C	1 Year 23°C±5°C	Temperature Coefficient/°C [6]
100.0000 µA	< 0.015 V	0.01 + 0.02	0.04 + 0.025	0.05 + 0.025	0.002 + 0.0030
1.000000 mA	< 0.15 V	0.007 + 0.005	0.030 + 0.005	0.05 + 0.005	0.002 + 0.0005
10.00000 mA	< 0.07 V	0.005 + 0.010	0.030 + 0.020	0.05 + 0.020	0.002 + 0.0020
100.0000m A	< 0.7 V	0.01 + 0.004	0.030 + 0.005	0.05 + 0.005	0.002 + 0.0005
1.000000 A	< 0.8 V	0.05 + 0.006	0.080 + 0.010	0.100 + 0.010	0.005 + 0.0010
10.00000 A	< 0.5 V	0.10 + 0.008	0.120 + 0.008	0.15 + 0.008	0.005 + 0.0008

Accuracy Specifications: ± (% of reading + % of range)

Continuity [2] [7]

Range [4]	Test Current	24 Hour 23°C±1°C	90 Day 23°C±5°C	1 Year 23°C±5°C	Temperature Coefficient/°C [6]
1000.000Ω	1 mA	0.002 + 0.030	0.008 + 0.030	0.010 + 0.030	0.001 + 0.002

Accuracy Specifications: ± (% of reading + % of range)

Diode Test [2] [7]

Range [4]	Test Current	24 Hour 23°C±1°C	90 Day 23°C±5°C	1 Year 23°C±5°C	Temperature Coefficient/°C [6]
1.000000 V	1 mA	0.002 + 0.010	0.008 + 0.020	0.010 + 0.020	0.001 + 0.002

Accuracy Specifications: ± (% of reading + % of range)

Measuring Characteristics

DC Voltage	Input Resistance	Range	
		0.1V	10MΩ or >10GΩ Selectable
		1V	10MΩ or >10GΩ Selectable
		10V	11.11MΩ ±1%
		100V	10.1MΩ±1%
		1000V	10.01MΩ±1%
		Input Bias	30pA (Typ, 25°C)
Input Protection 1000V on all ranges			

Measurement Method: Sigma-delta A/D Converter

Resistance	Max. Lead Resistance	10% of range per lead for 100Ω, 1 kΩ ranges. 1 kΩ per lead on all other ranges.
	Input Protection 1000 V on all ranges	

Measurement Method: Selectable 4-wire or 2-wire ohms. Current source referenced to LO input

DC Current	Shunt Resistor	100Ω for 100uA, 1mA. 5Ω for 10mA and 100 mA. 0.1Ω for 1A. 0.01Ω for 10A.
	Input Protection	Externally accessible 1.25A, 250 V fuse; Internal 12A, 600 V fuse

Reading Rate (Readings/sec) ^[8]	Continuity/ Diode	Rate	Digits	Rate	
		Slow	6 ½	100	
		Mid	5 ½	200	
		Fast	4 ¼	300	
	DCV, DCI, 2W/4W Resistance	Rate	Digits	Accurate	Quick
		Slow	6 ½	5	30
		Mid	5 ½	60	600
		Fast	4 ¼	240	2400

[1] For DCV/DCI/ 2/4WR measurement modes, to reach specifications accuracy, must be set in accuracy speed, slow rate, A-Filter off, A-Gain on, A-Zero on.

[2] For Diode/CONT/TCO/RTD measurement modes, to reach specifications accuracy, must be set in slow rate, A-Gain on, A-Zero on.

[3] Relative to calibration standards.

[4] 20% overrange on all ranges, except 1000 Vdc and 10A range.

[5] Specifications are for 4-wire ohms function, or 2-wire ohms using REL

function. Without REL function, add 0.2 Ω additional error in 2-wire ohms function.

[6] 0°C~18°C, 28°C~55°C

[7] Accuracy specifications are for the voltage measured at the input terminals only. 1mA test current is typical. Variation in the current source will create some variation in the voltage drop across a diode junction.

[8] All speeds need A-Zero=off, A-Gain=off, Fixed range and Trigger Delay=0.

[9] When measuring resistances higher than 500kΩ, please use shielded test cables to reduce noise interference.

AC Characteristics ^[1]

True RMS AC Voltage ^[4]

Range ^[3]	Frequency	24 Hour ^[2] 23°C±1°C	90 Day 23°C±5°C	1 Year 23°C±5°C	Temperature Coefficient/°C ^[9]
100.0000 mV	3Hz - 5Hz	1.00 + 0.03	1.00 + 0.04	1.00 + 0.04	0.100 + 0.004
	5Hz - 10Hz	0.35 + 0.03	0.35 + 0.04	0.35 + 0.04	0.035 + 0.004
	10Hz - 20kHz	0.04 + 0.03	0.05 + 0.04	0.06 + 0.04	0.005 + 0.004
	20kHz - 50kHz	0.10 + 0.05	0.11 + 0.05	0.12 + 0.05	0.011 + 0.005
	50kHz - 100kHz	0.55 + 0.08	0.60 + 0.08	0.60 + 0.08	0.060 + 0.008
	100kHz - 300kHz ^[6]	4.00 + 0.50	4.00 + 0.50	4.00 + 0.50	0.20 + 0.02
1.000000 V to 750.000 V	3Hz – 5Hz	1.00 + 0.02	1.00 + 0.03	1.00 + 0.03	0.100 + 0.003
	5Hz – 10Hz	0.35 + 0.02	0.35 + 0.03	0.35 + 0.03	0.035 + 0.003
	10Hz – 20kHz	0.04 + 0.02	0.05 + 0.03	0.06 + 0.03	0.005 + 0.003
	20kHz – 50kHz	0.10 + 0.04	0.11 + 0.05	0.12 + 0.05	0.011 + 0.005
	50kHz – 100kHz ^[5]	0.55 + 0.08	0.60 + 0.08	0.60 + 0.08	0.060 + 0.008
	100kHz – 300kHz ^[6]	4.00 + 0.50	4.00 + 0.50	4.00 + 0.50	0.20 + 0.02

Accuracy Specifications: ± (% of reading + % of range)

True RMS AC Current ^[4]

Range ^[3]	Frequency	24 Hour ^[2] 23°C±1°C	90 Day 23°C±5°C	1 Year 23°C±5°C	Temperature Coefficient/°C ^[9]
1.000000 mA	3Hz – 5Hz	1.00 + 0.04	1.00 + 0.04	1.0+0.04	0.1+0.006
	5Hz – 10Hz	0.30 + 0.04	0.30 + 0.04	0.3+0.04	0.035+0.006
	10Hz – 5kHz	0.10 + 0.04	0.10 + 0.04	0.1+0.04	0.015+0.006
	5kHz – 10kHz	0.2 + 0.25	0.2 + 0.25	0.2+0.25	0.03+0.006

10.00000 mA	3Hz – 5Hz	1.1 + 0.06	1.1 + 0.06	1.1+0.06	0.2+0.006
	5Hz – 10Hz	0.35 + 0.06	0.35 + 0.06	0.35+0.06	0.1+0.006
	10Hz – 5kHz	0.15 + 0.06	0.15 + 0.06	0.15+0.06	0.015+0.006
	5kHz – 10kHz	0.35 + 0.7	0.35 + 0.7	0.35+0.7	0.03+0.006
100.0000 mA	3Hz – 5Hz	1.0 + 0.04	1.0 + 0.04	1.0+0.04	0.1+0.006
	5Hz – 10Hz	0.3 + 0.04	0.3 + 0.04	0.3+0.04	0.035+0.006
	10Hz – 5kHz	0.1 + 0.04	0.1 + 0.04	0.1+0.04	0.015+0.006
	5kHz – 10kHz	0.2 + 0.25	0.2 + 0.25	0.2+0.25	0.03 + 0.006
1.000000 A	3Hz – 5Hz	1.0 + 0.04	1.0 + 0.04	1.0+0.04	0.1+0.006
	5Hz – 10Hz	0.3 + 0.04	0.3 + 0.04	0.3+0.04	0.035+0.006
	10Hz – 5kHz	0.1 + 0.04	0.1 + 0.04	0.1+0.04	0.015+0.006
	5kHz – 10kHz	0.35 + 0.7	0.35 + 0.7	0.35+0.7	0.03 + 0.006
10.00000 A	3Hz – 5Hz	1.1 + 0.06	1.1 + 0.06	1.10 + 0.06	0.1+0.006
	5Hz – 10Hz	0.35 + 0.06	0.35 + 0.06	0.35 + 0.06	0.035 + 0.006
	10Hz – 5kHz	0.15 + 0.06	0.15 + 0.06	0.15 + 0.06	0.015 + 0.006
	5kHz – 10kHz	0.35 + 0.7	0.35 + 0.7	0.35+0.7	0.03 + 0.006

Accuracy Specifications: \pm (% of reading + % of range)

Additional Crest Factor Errors (non-sine wave)^[7]

Crest Factor	Error (% of reading)
1-2	0.05%
2-3	0.15%
3-4	0.30%
4-5	0.40%

Additional Low Frequency Errors(% of reading)

Frequency	Slow	AC Filter	
		Medium	Fast
10Hz~20Hz	0	0.74	-
20Hz~40Hz	0	0.22	-
40Hz~100Hz	0	0.06	0.73
100Hz~200Hz	0	0.01	0.22
200Hz~1kHz	0	0	0.18
>1kHz	0	0	0

Measuring Characteristics

True RMS AC Voltage	Measurement Method:	AC-coupled True RMS – measures the ac component of input with up to 400 Vdc of bias on any range.	
	Crest Factor	Maximum 5:1 at full scale	
AC Filter Bandwidth	Slow	3 Hz – 300 kHz	
	Medium	20 Hz – 300 kHz	
	Fast	200 Hz – 300 kHz	
	Input Impedance:	1 MΩ ± 2%, in parallel with 100 pF	
	Input Protection:	750 Vrms on all ranges	
True RMS AC Current	Range	Shunt	Burden Voltage
	1mA	100Ω	<0.15V
	10mA	5Ω	<0.07V
	100mA	5Ω	<0.7V
	1A	0.1Ω	<0.8V
	10A	10mΩ	<0.5V
	Input Protection:	Externally accessible 1.25A, 250 V fuse Internal 12A, 250 V fuse	

Operating Characteristics ^[8]

Function	Rate	Digits	Readings/s ^[10]	AC Bandwidth
ACV,ACI	Slow	6 ½	1.2 (sec/reading)	3 Hz – 300 kHz
	Medium	5 ½	3.38	20 Hz – 300 kHz
	Fast	4 ½	30	200 Hz – 300 kHz

[1] Specifications are for 1-hour warm-up at 6 1/2 digits, Slow AC filter, sinewave input.

[2] Relative to calibration standards.

[3] 20% overrange on all ranges, except 750 Vac, 10A range.

[4] Specifications are for sinewave input >5% of range. For inputs from 1% to 5% of range and <50 kHz, add 0.1% of range additional error. For 50 kHz to 100 kHz, add 0.13% of range.

[5] 750 Vac range limited to 100 kHz

[6] Typically 30% of reading error at 1 MHz.

[7] For frequencies below 100 Hz, slow AC filter specified for sinewave input only.

[8] Additional settling delay required when input dc level varies.

[9] 0°C~18°C, 28°C~55°C

[10] All speeds need Fixed range and Trigger Delay=0.

Frequency and Period Characteristics

Frequency Period [3] [7]

Range [2]	Frequency	24 Hour [1] 23°C±1°C	90 Day 23°C±5°C	1 Year 23°C±5°C	Temperature Coefficient/°C [5]
100 mV to 750 V [4]	3Hz - 5Hz	0.1	0.1	0.1	0.005
	5Hz - 10Hz	0.05	0.05	0.05	0.005
	10Hz - 40Hz	0.03	0.03	0.03	0.001
	40Hz - 300kHz	0.006	0.01	0.01	0.001

Accuracy Specifications: ± % of reading

Measuring Characteristics

Frequency and Period	Measurement Method:	Reciprocal-counting technique. AC-coupled input using the ac voltage measurement function.
	Voltage Ranges	100 mVrms full scale to 750 Vrms. Auto or manual ranging.
Settling Considerations		Errors will occur when attempting to measure the frequency or period of an input following a dc offset voltage change. The input blocking RC time constant must be allowed to fully settle (up to 1 sec) before the most accurate measurements are possible.
Measurement Considerations		All frequency counters are susceptible to error when measuring low-voltage, low-frequency signals. Shielding inputs from external noise pickup is critical for minimizing measurement errors.

Operating Characteristics

	Function	Digits	Readings/s [6]
	Frequency,	6 ½	1
	Period	5 ½	10
		4 ½	100

[1] Relative to calibration standards.

[2] 20% overrange on all ranges, except 750 Vac.

[3] Input > 100 mV. For 10 mV to 100 mV inputs, multiply % of reading
error x10.

[4] 750 Vac range limited to 100 kHz

[5] 0°~18°C & 28°~55°C

[6] Need Fixed ACI/ACV range and Trigger Delay=0.

[7] To meet the specifications accuracy, *Slow rate* setting is needed.

Temperature Characteristics

(Display in °C, °F, Exclusive of probe errors.)

RTD ^[1] (Accuracy based on PT100):

(100Ω platinum [PT100], D100, F100,PT385, PT3916, or user type)

Range	Resolution	1 Year (23°C ±5°C)	Temperature Coefficient 0°-18°C & 28°-55°C
-200°C~ -100°C	0.001°C	0.09°C	0.004 °C / °C
-100°C~-20°C	0.001°C	0.08°C	0.005 °C / °C
-20°C~20°C	0.001°C	0.06°C	0.005 °C / °C
20°C~100 °C	0.001°C	0.08°C	0.005 °C / °C
100°C~300 °C	0.001°C	0.12°C	0.007 °C / °C
300°C~600 °C	0.001°C	0.22°C	0.009 °C / °C

Thermocouples ^[1] (Accuracy based on ITS-90):

Type	Range	Resolution	90 Day/1 Year (23°C±5°C)*	Temperature Coefficient 0°-18°C & 28°-55°C
E	-200 to +1000°C	0.002 °C	0.2 °C	0.03 °C / °C
J	-210 to +1200°C	0.002 °C	0.2 °C	0.03 °C / °C
T	-200 to +400°C	0.002 °C	0.3 °C	0.04 °C / °C
K	-200 to +1372°C	0.002 °C	0.3 °C	0.04 °C / °C
N	-200 to +1300°C	0.003 °C	0.4 °C	0.05 °C / °C
R	-50 to +1768°C	0.01 °C	1 °C	0.14 °C / °C
S	-50 to +1768°C	0.01 °C	1 °C	0.14 °C / °C
B	+350 to +1820°C	0.01 °C	1 °C	0.14 °C / °C

*Relative to simulated junction

Reading Rate ^[2]

(Readings/sec)	TCO/ RTD	Rate	Digits	Rate
		Slow	6 ½	10
		Mid	5 ½	60
		Fast	4 ¼	300

[1] Specifications do not include probe accuracy

[2] All speeds need A-Zero=off, A-Gain=off, Fixed range and Trigger Delay=0.

Dimensions

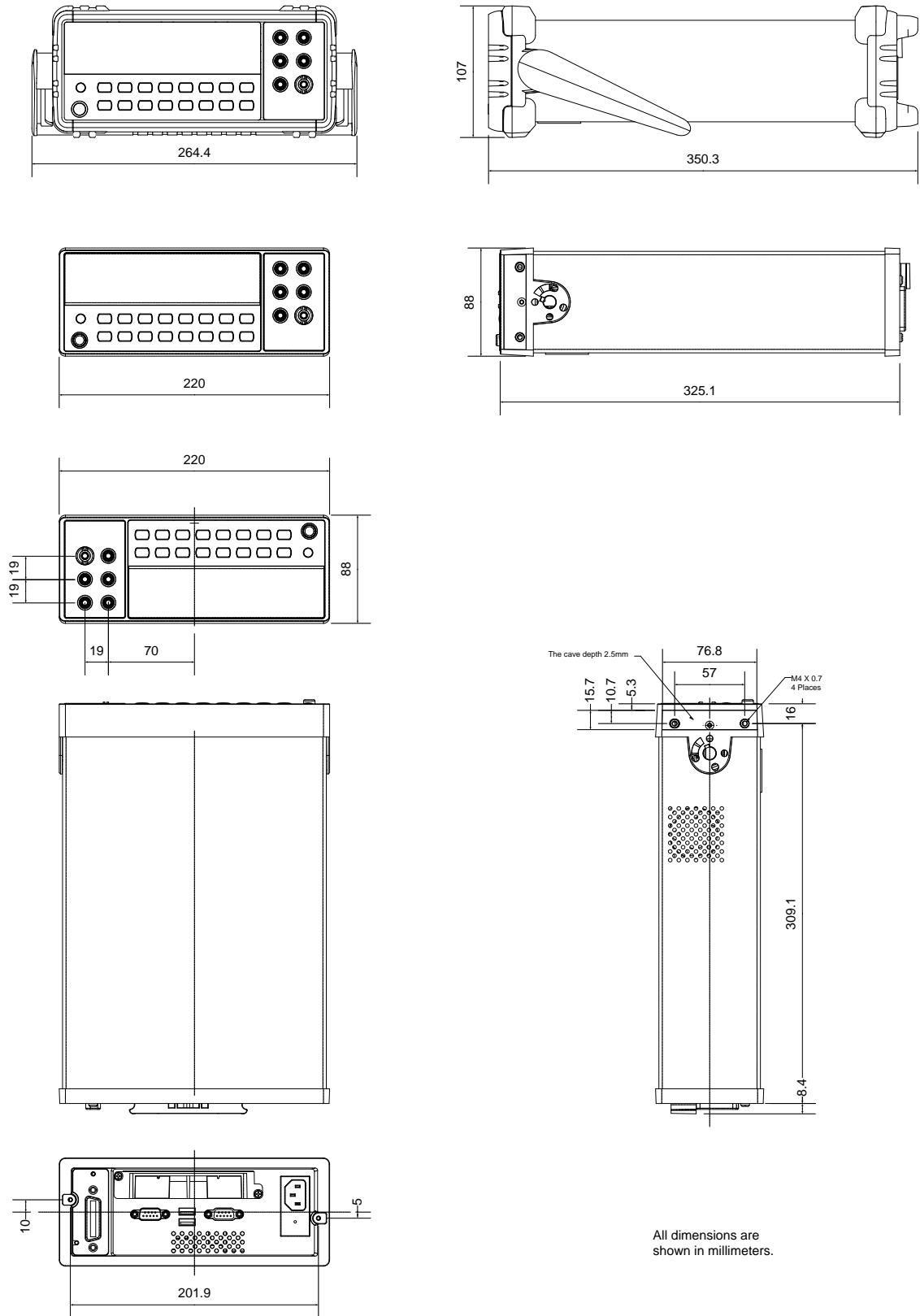

All dimensions are shown in millimeters.

Declaration of Conformity

We

GOOD WILL INSTRUMENT CO., LTD.

Declare that the below mentioned product

Type of Product: **Digital Multimeter**

Model Number: **GDM-8261A**

satisfies all the technical relations application to the product within the scope of council:

Directive: 2014/30/EU; 2014/35/EU; 2011/65/EU; 2012/19/EU

The above product is in conformity with the following standards or other normative documents::

⊙ **EMC**

EN 61326-1: EN 61326-2-1:	Electrical equipment for measurement, control and laboratory use -- EMC requirements (2013)	
Conducted & Radiated Emission EN 55011: 2009+A1:2010 Class A	Electrical Fast Transients EN 61000-4-4: 2012	
Current Harmonics EN 61000-3-2: 2014	Surge Immunity EN 61000-4-5: 2006	
Voltage Fluctuations EN 61000-3-3:2013	Conducted Susceptibility EN 61000-4-6: 2014	
Electrostatic Discharge EN 61000-4-2: 2009	Power Frequency Magnetic Field EN 61000-4-8: 2010	
Radiated Immunity EN 61000-4-3: 2006+A1:2008+A2:2010	Voltage Dip/ Interruption EN 61000-4-11: 2004	

⊙ **Safety**

Low Voltage Equipment Directive 2014/35/EU	
Safety Requirements	EN 61010-1: 2010 EN 61010-2-030: 2010

GOOD WILL INSTRUMENT CO., LTD.

No. 7-1, Jhongsing Road, Tucheng Dist., New Taipei City 236, Taiwan

Tel: +886-2-2268-0389 Fax: +866-2-2268-0639

Web: www.gwinstek.com Email: marketing@goodwill.com.tw

GOOD WILL INSTRUMENT (SUZHOU) CO., LTD.

No. 521, Zhujiang Road, Snd, Suzhou Jiangsu 215011, China

Tel: +86-512-6661-7177 Fax: +86-512-6661-7277

Web: www.instek.com.cn Email: marketing@instek.com.cn

GOOD WILL INSTRUMENT EURO B.V.

De Run 5427A, 5504DG Veldhoven, The Netherlands

Tel: +31(0)40-2557790 Fax: +31(0)40-2541194

Email: sales@gw-instek.eu

INDEX

A	
AC bandwidth	
setting	88
ADC speed	
setting	94
Analog filter	
setting	84
Auto-gain	
setting	92
Auto-zero	
setting	90
B	
Beeper	
setting	77
C	
Command IEE488.2 commands	210
Command set	
CALCulate commands	201
CONFigure commands	179
CONFigure2 commands	181
Measure commands	184
Remote commands	210
ROUTe commands	212
SENSe commands	187
STATus report commands	210
SYSTEM related commands	207
TRIGger commands	204
Command syntax	
configuration	
EOL	141
return format	142
separation character	142
overview	169
Compare value	
setting	65
Continuity	
setting	39
Crest factor	32
Current	
setting	33
Current auto-detect	
input port setting	89
D	
dB	
setting	58
Digital Filter Setting	82
Digital I/O	
Compare application	131
configuration	130
External trigger application	134
Diode test	
setting	38
Disposal instructions	8
D-Shift	
setting	86
Dual measurement	
applications	49
overview	49
E	
EN 61010	
measurement category	7
pollution degree	8
Environment	
operation	8
storage	8
Ethernet configuration	
activation	148
DHCP	151
DNS	157
Gateway	155
Initial settings	160
IP 152	
MAC address	158
Reset	150
Subnet	154
Telnet	159
Web password	162
Ethernet installation	147

<p>F</p> <p>FAQ216</p> <p>Firmware version219</p> <p>Frequency setting41</p> <p>Frequency/period gate time setting97 input port setting95</p> <p>Front panel overview13</p> <p>Fuse AC fuse replacement.....220 current fuse replacement.....221 safety instruction8</p> <p>G</p> <p>Getting Started chapter 10</p> <p> GPIB configuration 145</p> <p> GPIB installation..... 144</p> <p>I</p> <p>Indicator reading27</p> <p>Input resistance setting87</p> <p>L</p> <p>LAN installation 147</p> <p>LANG setting98</p> <p>Line voltage safety instruction7</p> <p>M</p> <p>Main features..... 11</p> <p>Math 1/X.....70 MX+B68 Percentage70 setting68 Standard deviation.....71 Statistics71</p> <p>Measurement keys overview 14</p> <p>Menu tree222</p> <p>Monitor channel..... 127</p>	<p>P</p> <p>Period setting 41</p> <p>R</p> <p>Rear panel overview 19</p> <p>Recall instrument settings 103</p> <p>Recall measurements..... 101</p> <p>Refresh rate 26, 56</p> <p>Refresh rate setting 76</p> <p>Relative value setting 62</p> <p>Remote terminal session telnet..... 163</p> <p>Resistance setting 35</p> <p>RS-232C configuration 139</p> <p>S</p> <p>Safety instruction fuse 8 Line voltage 7 symbol 6</p> <p>Save instrument settings 102</p> <p>Save parameters..... 102</p> <p>Scanner advanced settings..... 122 command set..... 212 installation 106 Overview 119 run scan 126 simple settings 120 step operation 126 triggering 125</p> <p>Scanner Configuration Record..... 116</p> <p>Serial number setting 76</p> <p>Service contact 217</p> <p>Specification conditions 216</p> <p>Specifications AC characteristics..... 228 measuring chacteristics 230</p>
--	--

Operating characteristics	230	setting.....	44
DC		Tilt stand	21
characteristics	226	Trigger	
measuring characteristics	227	delay	80
Dimensions	233	external	78
Frequency and Period		U	
characteristics	231	United Kingdom power cord	9
measuring characteristics	231	USB configuration	138
Operating characteristics	231	V	
General.....	225	Voltage	
Temperature characteristics	232	setting.....	28
Status system	224	W	
Store measurements	100	W	
T		setting.....	58
Table of contents	3	Waveform type voltage comparison	31
Temperature		Web control	
RTD setting.....	47	overview.....	165
setting	43, 46	Web control interface.....	165
Thermocouple			
junction setting.....	45		