

# D.C. Milli-Ohm Meter

GOM-802

---

## USER MANUAL

GW INSTEK PART NO. 82OM-80200MF1



ISO-9001 CERTIFIED MANUFACTURER

**GW INSTEK**

This manual contains proprietary information, which is protected by copyright. All rights are reserved. No part of this manual may be photocopied, reproduced or translated to another language without prior written consent of the Good Will company.

The information in this manual was correct at the time of printing. However, Good Will continues to improve products and reserves the right to change specifications, equipment, and maintenance procedures at any time without notice.

**Good Will Instrument Co., Ltd.**

**No. 7-1, Jhongsing Rd., Tucheng Dist., New Taipei City 236, Taiwan.**

# Table of Contents

<b>SAFETY INSTRUCTIONS</b> .....	<b>4</b>
Safety Symbols .....	4
Safety Guidelines .....	5
<b>GETTING STARTED</b> .....	<b>8</b>
GOM-802 Characteristics .....	9
Key Features .....	11
Front Panel Overview .....	12
Rear Panel Overview .....	16
Set Up .....	17
<b>MEASUREMENT</b> .....	<b>21</b>
Measurement Overview .....	22
Resistance Measurement .....	23
Compare Function.....	26
Temperature Measurement .....	32
Temperature Compensation.....	34
<b>HANDLER/SCAN/ INTERFACE</b> .....	<b>36</b>
Handler Overview .....	37
Scan Overview.....	38
Configure Interface .....	42
<b>FAQ</b> .....	<b>45</b>
<b>APPENDIX</b> .....	<b>46</b>
Fuse Replacement.....	47
Temperature Measurement .....	48
Specifications.....	51
Declaration of Conformity.....	54
<b>INDEX</b> .....	<b>55</b>

# S SAFETY INSTRUCTIONS

This chapter contains important safety instructions that you must follow when operating the GOM-802 or when keeping it in storage. Read the following before any operation to insure your safety and to keep the GOM-802 in the best possible condition.

## Safety Symbols

These safety symbols may appear in this manual or on the GOM-802.

---



WARNING

Warning: Identifies conditions or practices that could result in injury or loss of life.

---



CAUTION

Caution: Identifies conditions or practices that could result in damage to the GOM-802 or to other properties.

---



DANGER High Voltage

---



Attention Refer to the Manual

---



Protective Conductor Terminal

---



Earth (ground) Terminal

---



Do not dispose electronic equipment as unsorted municipal waste. Please use a separate collection facility or contact the supplier from which this instrument was purchased.

---

# Safety Guidelines

**General Guideline**



**CAUTION**

- Do not place any heavy objects on the GOM-802.
- Avoid severe impact or rough handling that leads to damaging the GOM-802.
- Do not discharge static electricity to the GOM-802.
- Use only mating connectors, not bare wires, for the terminals.
- Do not disassemble the GOM-802 unless you are qualified as service personnel.

(Note) EN 61010-1:2001 specifies the measurement categories and their requirements as follows. The GOM-802 falls under category I.

- Measurement category IV is for measurement performed at the source of low-voltage installation.
- Measurement category III is for measurement performed in the building installation.
- Measurement category II is for measurement performed on the circuits directly connected to the low voltage installation.
- Measurement category I is for measurements performed on circuits not directly connected to Mains.

**Power Supply**



**WARNING**

- AC Input voltage: 100V/ 120V/ 220V/230 V AC, 50/60Hz, 27VA, 22W
- The power supply voltage should not fluctuate more than 10%.
- Connect the protective grounding conductor of the AC power cord to an earth ground, to avoid electrical shock.

**Fuse**



**WARNING**

- Fuse type:

Line Voltage	Rating	Fuse
100V	90-110V	T0.3A 250V
120V	108-132V	T0.3A 250V
220V	198-242V	T0.25A 250V
230V	216-250V	T0.25A 250V

- Make sure the correct type of fuse is installed before power up.
- To avoid fire, only replace the fuse with the specified type and rating.
- Disconnect the power cord before fuse replacement.
- Make sure the cause of a fuse blowout is fixed before fuse replacement.

- 
- |                      |   |
|----------------------|---|
| Cleaning the GOM-802 | <ul style="list-style-type: none"> <li>• Disconnect the power cord before cleaning.</li> <li>• Use a soft cloth dampened in a solution of mild detergent and water. Do not spray any liquid into the GOM-802.</li> <li>• Do not use chemicals or cleaners containing harsh material such as benzene, toluene, xylene, and acetone.</li> </ul> |
|----------------------|---|
- 

- |                       |  |
|-----------------------|--|
| Operation Environment | <ul style="list-style-type: none"> <li>• Location: Indoor, no direct sunlight, dust free, almost non-conductive pollution (Note below)</li> <li>• Relative Humidity: &lt; 80%</li> <li>• Altitude: &lt; 2000m</li> <li>• Temperature: 0°C to 40°C (operation)</li> </ul> |
|-----------------------|--|
- 

(Note) EN 61010-1:2001 specifies the pollution degrees and their requirements as follows. The GOM-802 falls under degree 2.

Pollution refers to “addition of foreign matter, solid, liquid, or gaseous (ionized gases), that may produce a reduction of dielectric strength or surface resistivity”.

- Pollution degree 1: No pollution or only dry, non-conductive pollution occurs. The pollution has no influence.
  - Pollution degree 2: Normally only non-conductive pollution occurs. Occasionally, however, a temporary conductivity caused by condensation must be expected.
  - Pollution degree 3: Conductive pollution occurs, or dry, non-conductive pollution occurs which becomes conductive due to condensation which is expected. In such conditions, equipment is normally protected against exposure to direct sunlight, precipitation, and full wind pressure, but neither temperature nor humidity is controlled.
- 

- |                     |  |
|---------------------|--|
| Storage Environment | <ul style="list-style-type: none"> <li>• Location: Indoor</li> <li>• Temperature: -10°C to 70°C</li> </ul> |
|---------------------|--|
- 

#### Disposal



Do not dispose this instrument as unsorted municipal waste. Please use a separate collection facility or contact the supplier from which this instrument was purchased. Please make sure discarded electrical waste is properly recycled to reduce environmental impact.

## Power cord for the United Kingdom

When using the GOM-802 in the United Kingdom, make sure the power cord meets the following safety instructions.

---

NOTE: This lead / appliance must only be wired by competent persons



**WARNING: THIS APPLIANCE MUST BE EARTHED**

IMPORTANT: The wires in this lead are coloured in accordance with the following code:

Green/ Yellow: Earth

Blue: Neutral

Brown: Live (Phase)



As the colours of the wires in main leads may not correspond with the coloured marking identified in your plug/appliance, proceed as follows:

The wire which is coloured Green & Yellow must be connected to the Earth terminal marked with either the letter E, the earth symbol  $\oplus$  or coloured Green/Green & Yellow.

The wire which is coloured Blue must be connected to the terminal which is marked with the letter N or coloured Blue or Black.

The wire which is coloured Brown must be connected to the terminal marked with the letter L or P or coloured Brown or Red.

If in doubt, consult the instructions provided with the equipment or contact the supplier.

This cable/appliance should be protected by a suitably rated and approved HBC mains fuse: refer to the rating information on the equipment and/or user instructions for details. As a guide, a cable of  $0.75\text{mm}^2$  should be protected by a 3A or 5A fuse. Larger conductors would normally require 13A types, depending on the connection method used.

Any exposed wiring from a cable, plug or connection that is engaged in a live socket is extremely hazardous. If a cable or plug is deemed hazardous, turn off the mains power and remove the cable, any fuses and fuse assemblies. All hazardous wiring must be immediately destroyed and replaced in accordance to the above standard.

# G E T T I N G   S T A R T E D

This chapter describes the GOM-802 in a nutshell, including its main features as well as its front and rear panels. After going through the panel overview, follow the Power-up sequence before attempting to use the instrument.

Please note the information in this manual was correct at the time of printing. However as GW Instek continues to improve its products, changes can occur at any time without notice. Please see the GW Instek website for the latest information and content.



Characteristics	GOM-802 Characteristics.....	9
	Key Features.....	11
Panel Overview	Front Panel Overview .....	12
	Rear Panel Overview .....	16
Setup	Tilt Stand .....	17
	Power Up .....	18
	4 Wire Kelvin Connection.....	19
	Zeroing (Relative Function) .....	20



## GOM-802 Characteristics

GOM-802 is a high precision programmable DC Milli-ohm meter suitable for low resistance measurements of switches, relays, connectors, PCB tracks and a variety of other devices. With the easy-to-use features, superior performance, and automatic test interfaces, the GOM-802 is a dependable instrument for resistance measurements.



### Easy to Use Features

The GOM-802 includes an easy to use comparator function (HI-LO-GO) that is able to easily set upper and lower limits for pass/fail testing. The alarm buzzer can be used with the comparator function. The flexible handler interface can be used to monitor the status of the pass/fail testing.

The relative feature enables the GOM-802 to easily compensate for any stray resistance. Up to 20 different sets of HI-LO-GO settings can be stored to satisfy a number of different testing conditions. The GOM-802 is also able to recall the last test setting that was used every time it is turned on.

### Performance

The GOM-802 has nine selectable measurement ranges from 30m $\Omega$  to 3M $\Omega$ , a constant current source of 1 $\mu$ A to 1A, an accuracy of 0.05%, a 1 $\mu\Omega$  resolution and performs measurements using four wire Kelvin connections for accurate, consistent measurements.

The ability to choose between high measurement accuracy with 7 samples/sec (full scale at 30000) or high speed measurements with 30 samples/sec (full scale at 3000) allows the GOM-802 the flexibility to fulfill a number of different measurement roles.

---

Temperature Compensation	<p>Temperature Compensation (Optional):</p> <p>The optional temperature probe (PT-100) can be used to extrapolate the resistance of a DUT at a certain temperature. When the temperature coefficient and the required temperature (of the resistance measurement) is keyed in under TC mode, the GOM-802 will display the extrapolated measurement.</p>
Automatic Testing	<p>For automatic testing The GOM-802 has a handler interface designed for automatic testing. The handler interface outputs the status of PASS, FAIL, HI, LO, READY and EOT signals and inputs a trigger control signal. An RS-232 and GPIB option is also available for computer control applications.</p>
Applications	<ul style="list-style-type: none"><li>• Production testing for contact resistance of switches, relays, connectors, cables and printed circuit boards and other low resistance devices.</li><li>• Component testing of resistors, motors, fuses and heating elements.</li><li>• Incoming inspection and quality assurance testing.</li><li>• Conductivity evaluation for product design.</li></ul>

---

## Key Features

---

- 30,000 counts.
  - Measurement Range: 30m $\Omega$ ~3M $\Omega$ .
  - 0.05% accuracy.
  - Hi/Lo comparator and limit percentage setting with 20 memory sets.
  - REL, Actual and % value measurements.
  - Manual or Auto-ranging.
  - Continuous or Triggered measurement modes.
  - Temperature compensation and measurement.
  - Four-wire measurement method.
  - Auto-recall last setting on power-up.
  - Diode test.
  - Alarm setting for PASS/FAIL test result.
  - Sampling rate: 7 or 30 sampling/sec.
  - Standard interface: Scan/Handler, optional interfaces: RS-232 + GPIB.
-

# Front Panel Overview

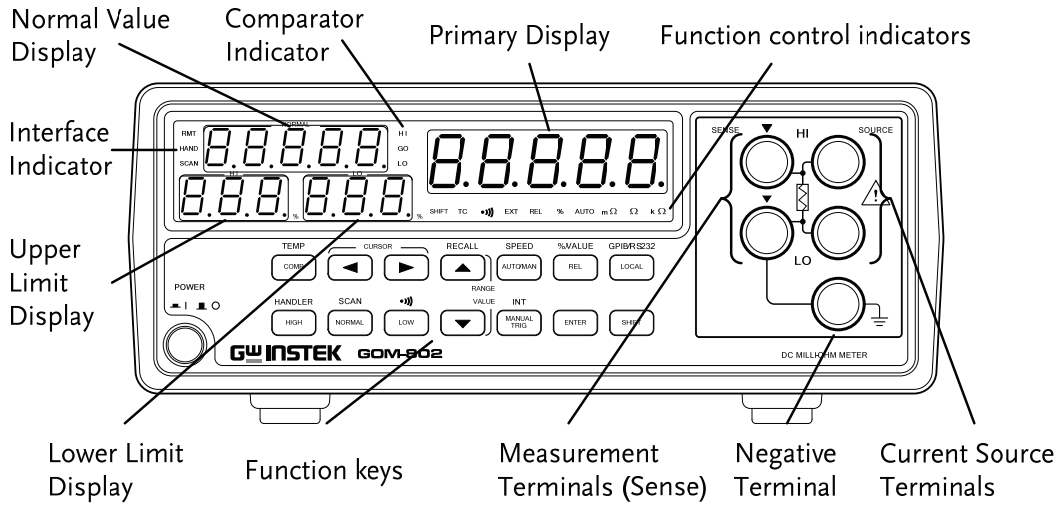

## Power Switch

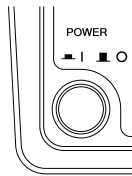

Turns On **I** or Off **O** the main power. For details about the power up sequence, see page 18.

## Primary Value Display



Shows the primary measurement results.

## Normal Display

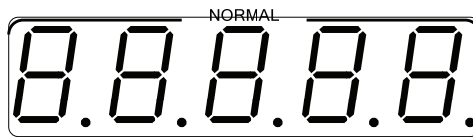

Shows the Normal (nominal) value setting.

## Comparator Indicators

HI  
GO  
LO

The comparator indicators indicate the status of comparison judgments.

HI: measurement exceeds the HI limit  
LO: measurement exceeds the LO limit  
GO: measurement is within the HI and LO limits.

Function Control Indicators    SHIFT   TC   ●))   EXT   REL   %   AUTO   mΩ   Ω   kΩ

Indicates when a function key is active.

Measurement Terminals

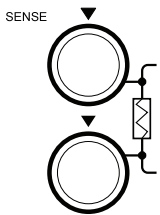

Sense HI and Sense LO terminals.

Current Source Terminals

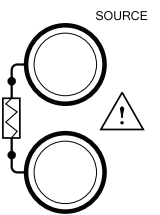

Current Source Terminals, Source HI and Source LO.

Negative Terminal

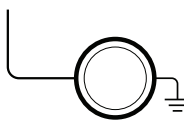

Negative Terminal. This terminal has the same potential as earth, but cannot be substituted for it.

**Function Keys**



The **COMP**<sup>TEMP</sup> key activates the comparator function. The secondary function turns on the temperature compensation function.

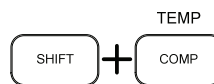

- Temperature compensation



The Cursor keys are used to edit parameters and navigate the menu tree.

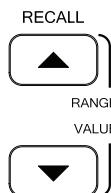

The Up/Down arrow keys are used to change the values and range of the different parameters.

The secondary function recalls previously saved settings.



- Recall settings



The **AUTO/MAN**<sup>SPEED</sup> key toggles the range between automatic and manual and toggles between 7 samples per second and 30 samples per second.

SHIFT + SPEED  
AUTOMAN

- Sample speed

%/VALUE  
REL

The REL<sup>0%</sup>VALUE key is used to perform a zero adjustment to the test leads or a DUT. Using the shift key will display the measured values as a percentage of the normal value.

SHIFT + %/VALUE  
REL

- Percentage values

GPIB/RS232  
LOCAL

The LOCAL<sup>GPIB/RS232</sup> key will switch the milliohm meter between local and remote mode.

The secondary function will set the I/O interface to GPIB or RS-232.

SHIFT + GPIB/RS232  
LOCAL

- GPIB/  
RS232 mode

HANDLER  
HIGH

Sets the High limit % values. The secondary function activates the Handler function.

SHIFT + HANDLER  
HIGH

- Handler mode

SCAN  
NORMAL

Sets the normal (Nominal) value for the comparator function.

SHIFT + SCAN  
NORMAL

- Scan function

•))  
LOW

Sets the lower % limit for the comparator function and turns the buzzer on for either a PASS or FAIL judgment or turns the buzzer off.

SHIFT + •))  
LOW

- Buzzer  
ON/OFF



Turns the external trigger on to allow the **MANUAL TRIG<sup>TRIG</sup>** key to be used as a manual trigger. The secondary function will set the trigger to internal.



- Turns the internal trigger ON/OFF



Enter key.



The SHIFT key is used to access the secondary functions.

Lower Limit Display (LO)



Displays the lower limit as a percentage.

Upper Limit Display (HI)

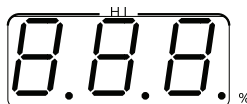

Displays the upper limit as a percentage.

Interface Indicator

- RMT**
- HAND**
- SCAN**

The interface indicator shows the status mode of the GOM-802. Remote mode (RMT), Handler mode (HAND) or Scan mode.

# Rear Panel Overview

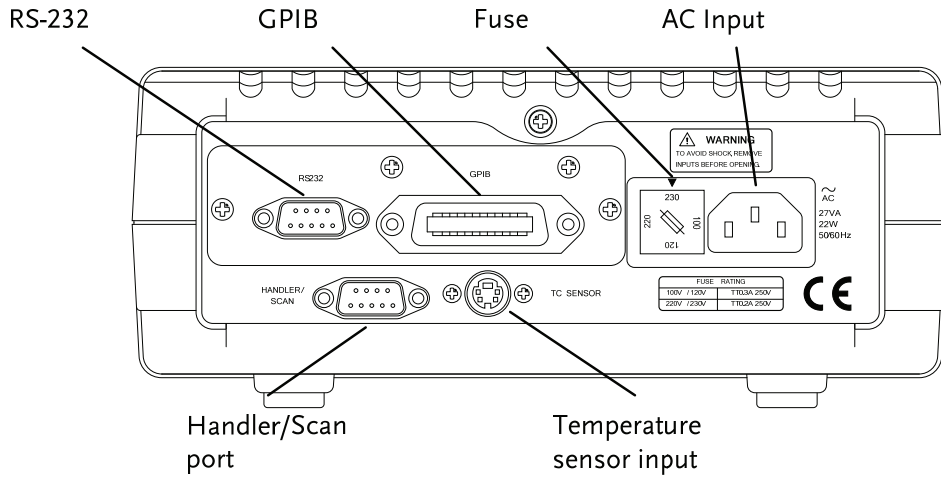

## AC Input

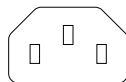

Accepts the power cord. AC 100/120V or 220/230V; 50/60Hz.

For the power on sequence, see page 18.

## Fuse Socket



Holds the main fuse:

100/120V: T0.3A 250V;

220/230V: T0.25A 250V;

For the fuse replacement details, see page 47.

## RS-232C port

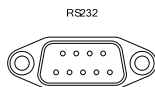

Accepts an RS-232C cable for remote control; DB-9 male connector.

For remote control details, see page 43.

## GPIB port

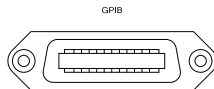

Accepts a GPIB cable for remote control (page 42).

## Handler / Scan port

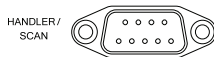

The Handler/Scan port is used to output pass/fail/high/low comparison results.

## Temperature Sensor



TC SENSOR

The temperature sensor input for the optional PT-100 temperature probe.



# Set Up

## Tilt Stand

---

### Steps

1. Pull handle base away from the casing.

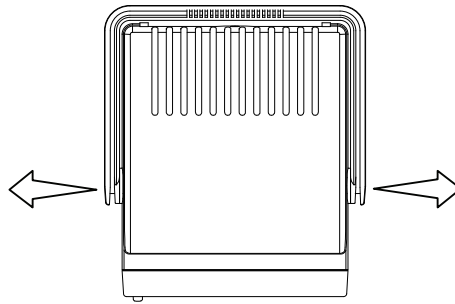

2. Turn handle into any of the preset positions.

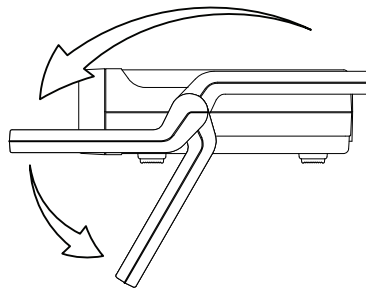

**Stand Position**

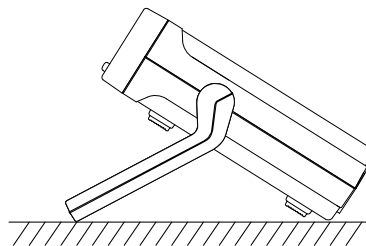

**Carry Position**

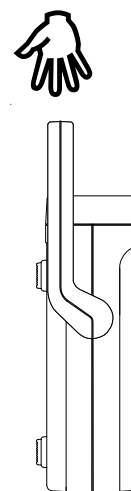

## Power Up

1. Ensure that the correct voltage is lined up with the arrow on the fuse cover on the rear panel.

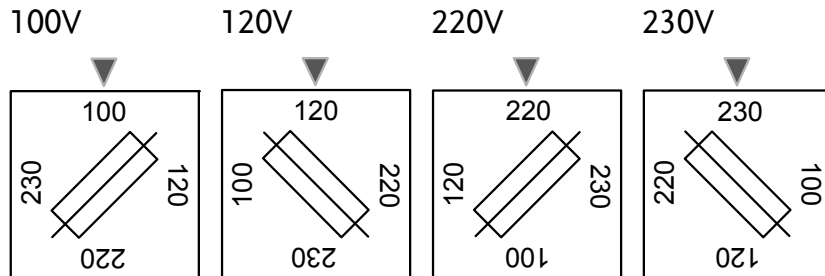

### Steps

2. Connect the power cord to the AC Voltage input.

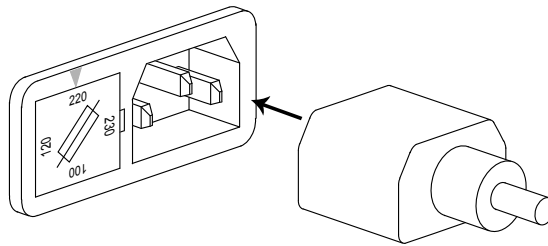

Ensure the ground connector of the power cord is connected to a safety ground. This will affect the measurement accuracy.

3. Press the main power switch on the front panel.

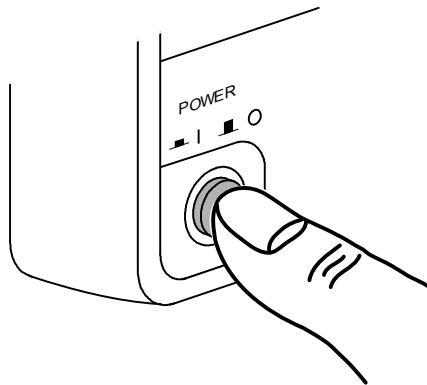

4. The display will light up and show the last setting used before the last shut down.

Example:  
Resistance  
measurement  
mode

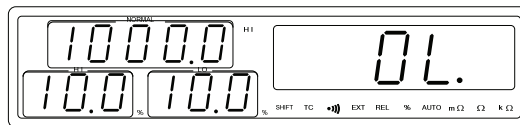
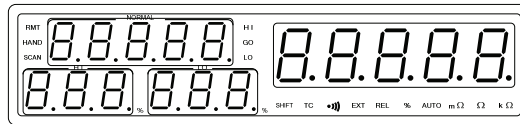

## 4 Wire Kelvin Connection

Background

The GOM-802 uses 4 wire Kelvin connections for accurate measurements.

Diagram

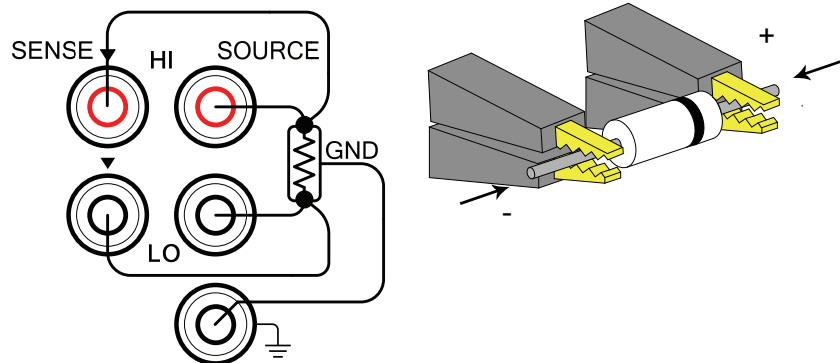

Description

Source HI	The Source HI carries the measuring current source. It is connected to the + side of the DUT.
Source LO	The Source LO terminal accepts the signal return current. Connects to the - side of the DUT.
Sense HI	Monitors the positive (+) potential.
Sense LO	Monitors the negative (-) potential.
GND	If the component has a large metallic area not connected to either terminal, connect it to ground to reduce noise.

## Zeroing (Relative Function)

### Background

The Relative function is used to perform a zero adjustment on the test leads.

After the Relative value is pre-set, each measurement that is displayed is equal to the actual value – relative preset value.

If the measured value minus the relative value is a negative, a minus sign is shown on the MSB (most significant bit). At low measurement speeds the minus sign will alternate with the displayed measurement.

### 1. Short the cables

Short the test cables together using a short thick copper wire if necessary.

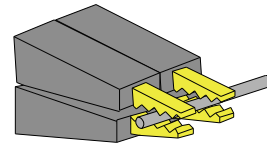
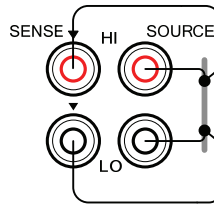

### 1. Set the Reference value

Press the **REL**<sup>%VALUE</sup> key.

%VALUE



### 2. Relative mode display appears

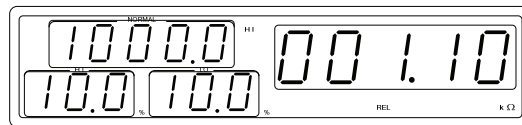

REL

Indicates the Relative function is active



Note

The Auto-range function will be disabled when using compare mode with the relative function.

# M EASUREMENT

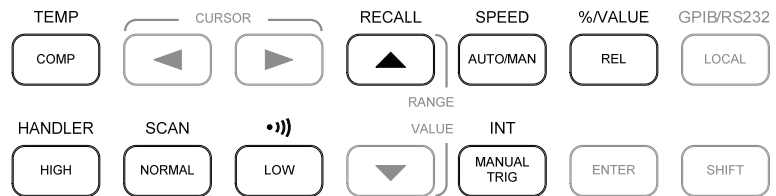

Overview	Measurement Overview.....	22
Resistance	Resistance Measurement .....	23
	Select the Resistance Range.....	24
Rate	Select Measurement Rate.....	25
Trigger	Using the Trigger Function .....	25
Compare	Compare Function.....	26
	Save Compare Settings .....	28
	Recall Compare Settings .....	29
Buzzer	Buzzer Function .....	30
Percentage	Display as Percentage .....	31
Relative	Relative Function.....	32
Temperature	Temperature Measurement .....	32
	Relative Function.....	33
Temperature Compensation	Temperature Compensation .....	34
	Select the Resistance Range.....	35
	Relative Function.....	35

# Measurement Overview

**Background** The Measurement chapter refers to the measurements listed below. For measurements using the Handler or Scan interfaces, see page 36.

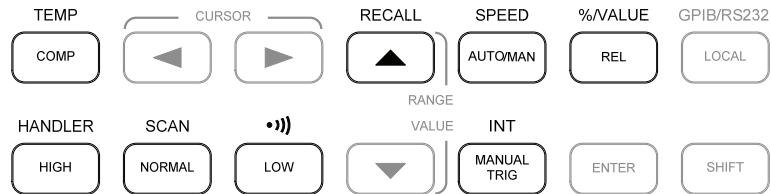

Measurement type	<b>COMP</b> <sup>TEMP</sup>	Comparison function
	<b>SHIFT</b> + <b>COMP</b> <sup>TEMP</sup>	Temperature sensor function
	<b>AUTO/MAN</b> <sup>SPEED</sup>	Auto-range ←→ Manual range
	<b>SHIFT</b> + <b>AUTO/MAN</b> <sup>SPEED</sup>	Measurement speed function
	<b>REL</b> <sup>%/VALUE</sup>	Relative function selector
	<b>SHIFT</b> + <b>REL</b> <sup>%/VALUE</sup>	Toggle Relative % or Value
	<b>HIGH</b> <sup>HANDLER</sup>	High comparison limit
	<b>SHIFT</b> + <b>HIGH</b> <sup>HANDLER</sup>	Handler function
	<b>NORMAL</b> <sup>SCAN</sup>	Normal (nominal) value
	<b>SHIFT</b> + <b>NORMAL</b> <sup>SCAN</sup>	Scan mode
	<b>LOW</b> <sup>•)))</sup>	Low comparison limit
	<b>SHIFT</b> + <b>LOW</b> <sup>•)))</sup>	Buzzer on/off
	<b>MANUAL TRIG</b> <sup>INT</sup>	Trigger settings
	<b>SHIFT</b> + <b>MANUAL TRIG</b> <sup>INT</sup>	Internal trigger setting

# Resistance Measurement

1. Select the Resistance function.

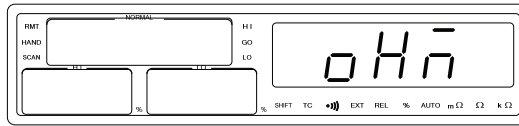

Press **SHIFT** + **COMP**<sup>TEMP</sup> to access the main function mode.

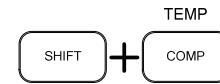

Press the Up and Down arrow keys to select resistance measurement mode (shown above).



There are three different modes:  
 $0Hn$  (resistance),  $0L$  (temperature) and  $tL$  (temperature compensation) mode.

Press **ENTER** to confirm



2. Resistance mode display appears.

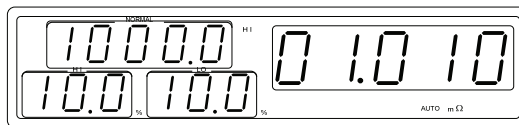

Auto	Indicates automatic ranging
mΩ	Milliohms
Ω	Ohms
kΩ	Kilo ohms

3. Connect the test lead and measure

4-wire resistance:  
 Use the SOURCE HI and the SOURCE LO port for measurement, and the SENSE HI, and SENSE LO port for sensing.

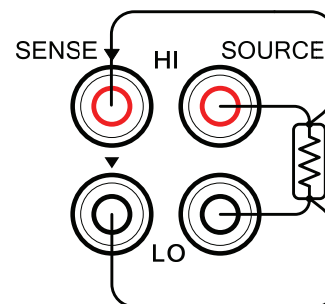



Note



When switching from a high range to a low range, please allow a moment for the circuits to settle before measuring.

## Select the Resistance Range

---

**Background** The resistance range can be used with normal resistance measurement as well as the temperature compensation function.

**Auto Range** Press the Up and Down arrow keys to manually select the resistance range.  

**Manual** Press the  key to use automatic ranging. 

Selection List	Range	Resolution (7 meas./s)
	30mΩ	1μΩ
	300mΩ	10μΩ
	3Ω	100μΩ
	30Ω	1mΩ
	300Ω	10mΩ
	3kΩ	100mΩ
	30kΩ	1Ω
	300kΩ	10Ω
	3MΩ	100Ω



Note

For detailed specifications, please see the specifications on page 51.



## Select Measurement Rate

**Background** The resistance measurement speed has 2 ranges: low and high. Low speed is the most accurate with 7 measurements/second and a full scale of 30,000 counts. High speed has 30 measurements/second with a full scale 3,000 counts.

The rate function is applicable to the resistance, temperature and temperature compensation measurements.

**1. Select Rate** Press the **SHIFT** + **AUTO/MAN**<sup>SPEED</sup> keys to switch between the LO and HI rates.

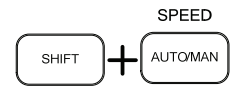

**LO rate** The low rate is shown with a full scale of 5 digits in the resistance measurement mode.

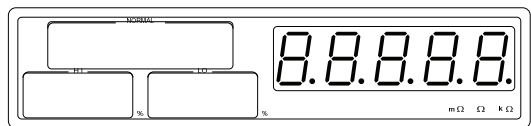

**HI rate** The high rate is shown with a full scale of 4 digits.

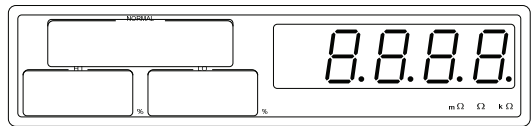

**Note**

For detailed specifications, please see the specifications on page 49.

## Using the Trigger Function

**Background** The GOM-802 can use internal or manual triggering for the resistance, temperature and temperature compensation measurement modes. External triggering is only supported with the Handler and Scan modes. By default the GOM-802 is in internal triggering mode.

**1. Select Manual Trigger** Press **MANUAL TRIG**<sup>INT</sup> to switch to manual triggering mode.

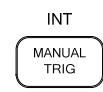

The EXT indicator will be lit when the manual trigger is active.

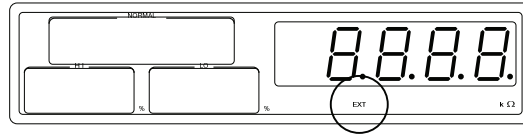

**2. Manually Triggering Measurements**

Press the **MANUAL TRIG<sup>INT</sup>** key each time you want to start a single measurement.



The EXT indicator will be lit when the manual trigger is active.

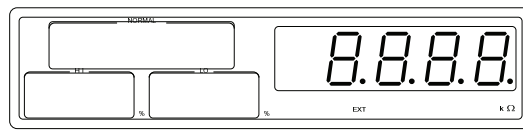

**Internal Triggering**

Press **SHIFT + MANUAL TRIG<sup>INT</sup>** to return the triggering mode back to internal mode.

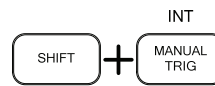

The EXT indicator will become cleared from the display.

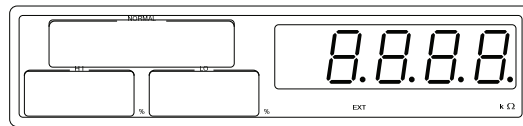

# Compare Function

**Background**

The compare function compares a measured value to a “Normal” value that has an upper (HI) and lower (LO) limit. The upper and lower limit is set as a percentage of the Normal value.

A measured value that falls within the upper and lower limits is considered a GO (pass), a value that falls below the lower limits is considered LO, and a value that falls over the upper limit is a HI.

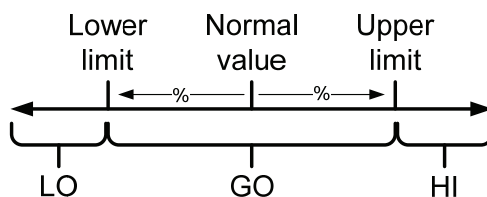

The GO, HI or LO indicators will light up for each measured value that is compared to the upper and lower limits.

1. Select the compare function

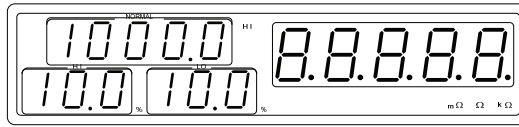

Press **COMP**<sup>TEMP</sup> to access the compare mode, as shown above.



2. Normal value setting

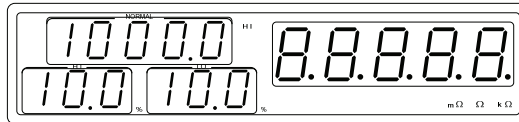

Press **NORMAL**<sup>SCAN</sup> to set NORMAL value setting.



Use the Left and Right arrow keys to select a digit. The selected digit will flash.



Use the Up and Down arrow keys to edit the value of the selected digit.



Range 33000~00000

Press **ENTER** to confirm the setting.



Note

After setting the Normal value, the HI and LO limits will be changed to reflect the new Normal value setting.

3. HI limit setting

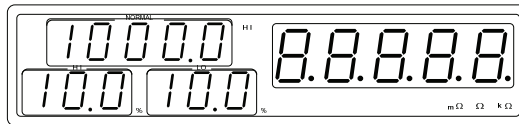



Press **HIGH**<sup>SCAN</sup> to set the HI percentage limit.



Use the Left and Right arrow keys to select a digit. The selected digit will flash.





Use the Up and Down arrow keys to edit the value of the selected digit.  

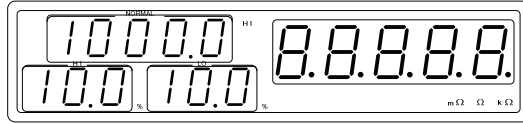

Range 000~999

Press **ENTER** to confirm the setting. 

**4. LO limit setting**



Press **LOW** to set the LO percentage limit. 

Use the Left and Right arrow keys to select a digit. The selected digit will flash.  

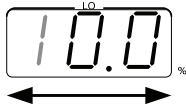

Use the Up and Down arrow keys to edit the value of the selected digit.  

Range 000~999

Press **ENTER** to confirm the setting. 

**Save Compare Settings**



**Background**

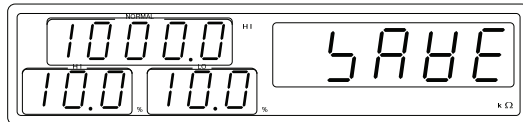

The save function saves the Normal, High and Low limit settings in memory. If these values are not saved, the settings will be lost after exiting Compare mode.

Up to 20 Normal, High, Low settings can be saved on the GOM-802.

**1. Select Save mode**



Press **SHIFT** + <sup>RECALL</sup> to access the RECALL/SAVE mode.  + 

Press the Up and Down arrow key to show "SAVE" in the main display, as shown above.  

Press enter to confirm.



2. Select memory location

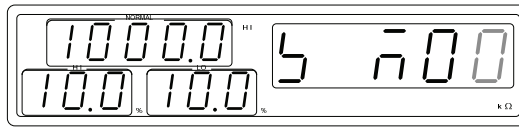

Use the Left and Right arrow keys to select a digit. The selected digit will flash.

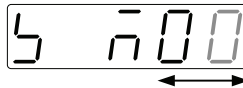

Use the Up and Down arrow keys to edit the value of the selected digit.

Range 00~19

Press **ENTER** to confirm the setting.



After saving the settings, the meter will return to the compare mode function.



Note

Pressing SHIFT before pressing ENTER will exit the Save mode.

## Recall Compare Settings

Background

The Recall function retrieves the Normal, High and Low limit settings from one of 20 memory locations. If these values are not saved, the settings will be lost after exiting Compare mode.

Up to 20 Normal, High, Low settings can be saved on the GOM-802.

1. Select Recall mode

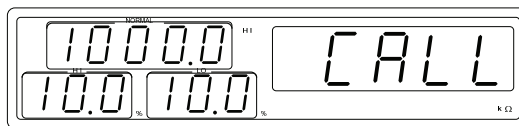

Press **SHIFT** + **▲**<sup>RECALL</sup> to access the RECALL/SAVE mode.



Press the Up and Down arrow key to show “CALL” in the main display, as shown above.



Press **ENTER** to confirm.



2. Select memory location

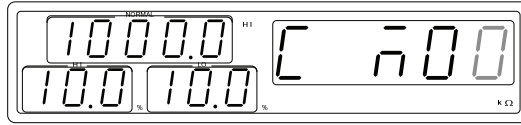

Use the Left and Right arrow keys to select a digit. The selected digit will flash.

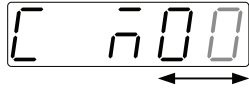

Use the Up and Down arrow keys to edit the value of the selected digit.

Range 00~19

Press **ENTER** to confirm the setting.



After saving the settings, the meter will return to the compare mode function.



Note

Pressing SHIFT before pressing ENTER will exit the Recall mode.

## Buzzer Function

Background

The buzzer function can make the buzzer sound when the compare test has passed (GO) or failed (NOGO). The buzzer settings are only applicable in Compare mode.

1. Select Buzzer Function

Press the **SHIFT** key and then press **LOW** key.



2. Buzzer function display appears

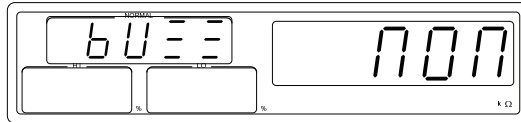

Press the Up and Down arrow key to choose the buzzer mode.



NON Buzzer function off

bF Buzz on Fail (No Go)

bP Buzz on Pass (Go)

Press **ENTER** to confirm the selection.





Note

Pressing SHIFT before pressing ENTER will exit the Buzzer function settings.

## Display as Percentage

**Background** In the compare function, the measured value can be displayed as a percentage of the Normal value rather than the actual value.

For example, if the Normal value is 20.000, and the actual value is 10.000, then as a percentage it would be displayed as 50.00%.

**1. Select Buzzer Function**

Press the **SHIFT** key and then press the **REL**<sup>%VALUE</sup>.



**2. Percentage display appears**

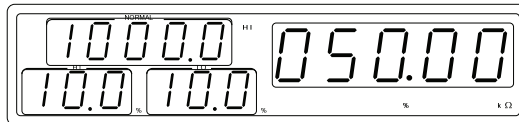

**3. Return to normal display**

Press the **SHIFT** key and then press the **REL**<sup>%VALUE</sup>.



Note

The Auto-range function will be disabled when using the percentage display.

## Relative Function

### Background

The Relative function is used to perform a zero adjustment on the test leads or the resistance of the DUT.

After the Reference value is pre-set, each measurement that is displayed is equal to the actual value – relative preset value.

If the measured value minus the relative value is a negative, a minus sign is shown on the MSB (most significant bit). At low measurement speeds the minus sign will alternate with the displayed measurement.

### 1. Set the Reference value

Press the **REL**<sup>%VALUE</sup> key.

%VALUE

REL

### 2. Relative mode display appears

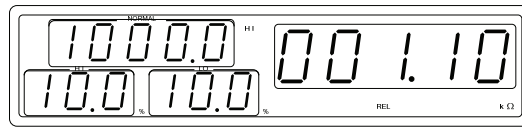

REL

Indicates the Relative function is active



Note

The Auto-range function will be disabled when using compare mode with the relative function.

## Temperature Measurement

### Background

The temperature measurement function uses the optional PT-100 temperature probe. The measured temperature is displayed on the NORMAL display. For more information on the optional PT-100 sensor, see the appendix on page 48.

There is only one range in when using the temperature function.

### 1. Select the Temperature function.

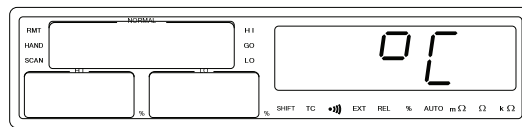

Press **SHIFT** + **COMP**<sup>TEMP</sup> to access the main function mode.

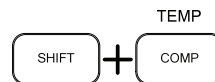



Press the Up and Down arrow keys to select the °C measurement mode (shown above).



There are three different modes:  
 $\square H \bar{n}$  (resistance),  $\square \bar{C}$  (temperature)  
 and  $\bar{t} \bar{C}$  (temperature compensation) mode.

Press **ENTER** to confirm



2. Temperature mode display appears.

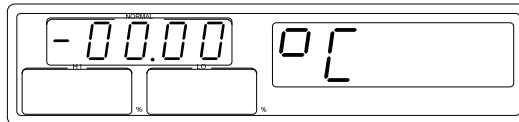

The temperature is displayed on the NORMAL display.

3. Temperature mode connection.

The temperature sensor uses the rear panel TC port for input.

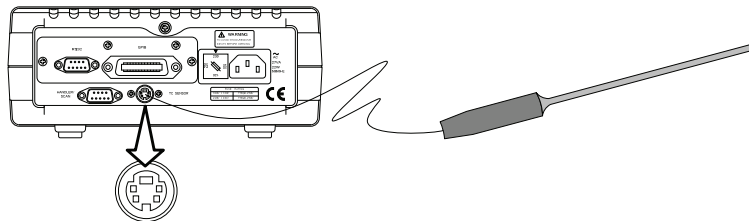

## Relative Function

Background

The Relative function can also be used with the temperature function. The temperature displayed is the temperature of the sensor minus the temperature of the sensor when the **REL**<sup>%VALUE</sup> key was pressed.

1. Set the Reference value

Press the **REL**<sup>%VALUE</sup> key.

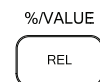

2. Relative mode display appears

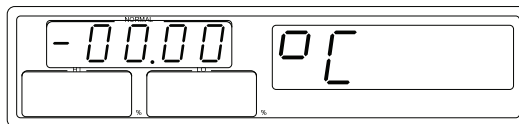

REL

Indicates the Relative function is active

# Temperature Compensation

**Background**

If the resistance of a DUT at a particular temperature is needed the compensation function can be used. This function can simulate the resistance of a DUT at a desired temperature. If the ambient temperature and the temperature coefficient of the DUT are known, it is possible to determine the resistance of a DUT at any temperature.

1. Select the Temperature compensation mode.

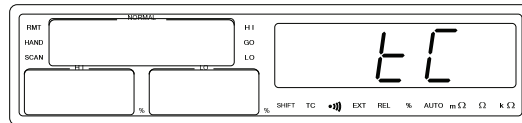

Press **SHIFT** + **COMP**<sup>TEMP</sup> to access the main function mode.



Press the Up and Down arrow keys to select the TC measurement mode (shown above).



There are three different modes:

$\square H \bar{n}$  (resistance),  $\square \bar{C}$  (temperature) and  $t \bar{C}$  (temperature compensation) mode.

Press **ENTER** to confirm.



2. Temperature compensation mode appears.

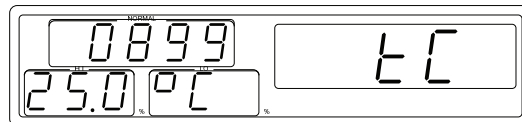

Edit the desired temperature and the temperature coefficient of the DUT. Use the Left and Right arrow keys to select a digit and use the Up and Down arrow keys to edit the digit.



Desired Temperature      0~99.9

Temperature Coefficient      0000~9999

Press **ENTER** to confirm the selection and start measurement.



3. Temperature compensation connection.

Sensor Connection:

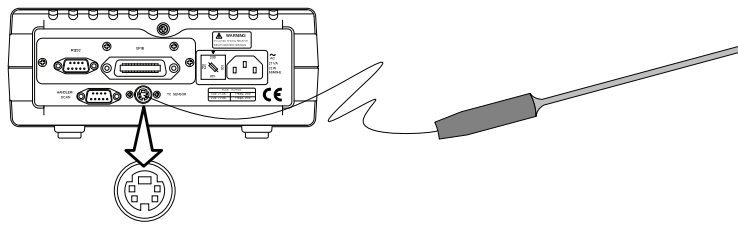

DUT connection

4 Wire:

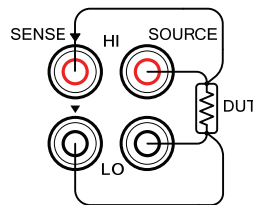

## Select the Resistance Range

Background

The resistance range can be selected when using the temperature compensation function.

Auto Range

Press the Up and Down arrow keys to manually select the resistance range



Manual

Press the **AUTO/MAN** key to use automatic ranging.



## Relative Function

Background

The Relative function can also be used with the temperature compensation function.

1. Set the Reference value

Press the **REL** <sup>%VALUE</sup> key.



2. Relative mode display appears

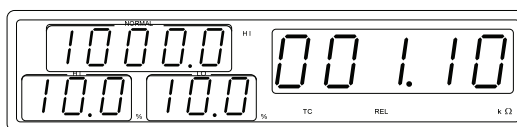

REL

Indicates the Relative function is active

# HANDLER/SCAN/ INTERFACE

---

Handler	Handler Overview .....	37
Scan	Scan Overview .....	38
	Scan Setup .....	38
	Scan Output .....	41
Interface	Configure Interface .....	42
	Configure GPIB Interface .....	42
	Configure RS-232 Interface .....	43
	Interface Function Check .....	44

---

# Handler Overview

**Background** The Handler Interface is used to help bin components based on the Go-NoGo comparator function test. There are 6 TTL outputs and one TTL input. The Handler interface can only be used with the resistance measurement and compare measurement modes.

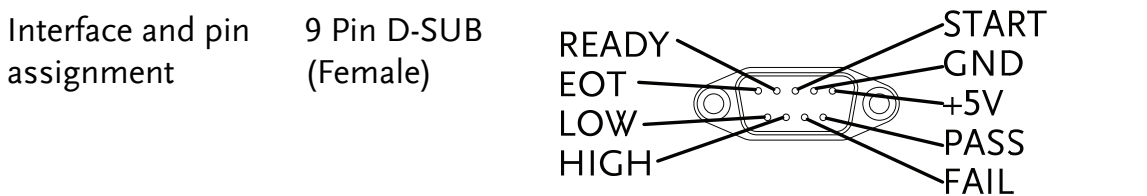

Pin Assignment	START	Start the trigger for a single measurement. Negative edge trigger.
	READY	High when the measurement has finished. The instrument is ready for the next trigger..
	EOT	High when the AD conversion has completed. The DUT is ready to be changed.
	LOW	High when the compare result is deemed LO.
	HIGH	High when the compare result is deemed HI.
	FAIL	High when the compare result is either HI or LO (fail).
	PASS	High when the compare result is GO (pass).



The output current from all the terminals and the +5V terminal cannot exceed 60mA.

# Scan Overview

**Background** The Scan function is used to automatically bin groups of up to 100 components. The scan function, unlike the handler interface must first be activated using the panel keys.

There are a total of 6 outputs as well as a GND and power (+5V) pin.

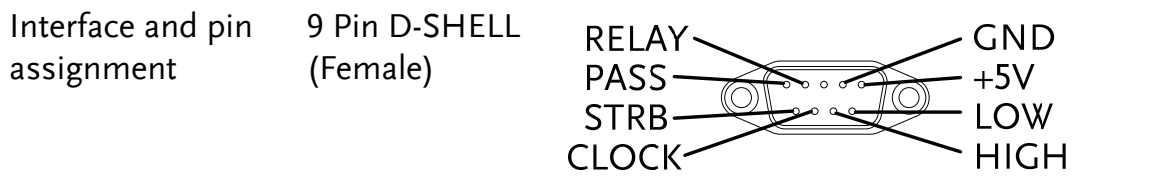

Pin Assignment	Relay	Controls the relay output.
	Pass	Pass signal. Indicates a GO compare result is GO (pass).
	Low	Low signal. Indicates a LO compare result.
	High	High signal. Indicates a HI compare result.
	Clock	The clock signal will pulse high when each group of output signals (Ready, Pass, Low, High) are ready. There are up to 100 groups of output signals
	STRB	After all (100) output groups are ready, the STRB signal will pulse high.

## Scan Setup

**Background** The scan function is accessed via the compare mode.

1. Select the compare function

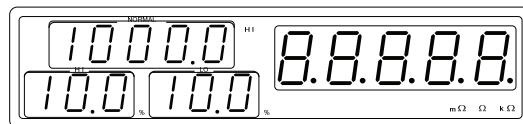

Press **COMP**<sup>TEMP</sup> to access the compare mode, as shown above.



2. Select the resistance function.

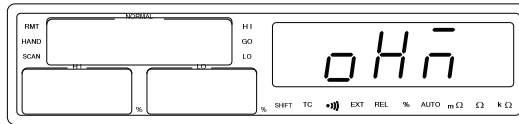

Press **SHIFT** + **COMP**<sup>TEMP</sup> to access the main function mode.

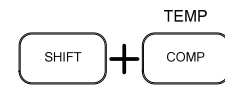

Press the Up and Down arrow keys to select the resistance measurement mode (shown above).



There are three different modes:  
 $0H\bar{n}$  (resistance),  $0\bar{L}$  (temperature) and  $t\bar{L}$  (temperature compensation) mode.

Press **ENTER** to confirm.



3. Resistance mode and Compare display appears.

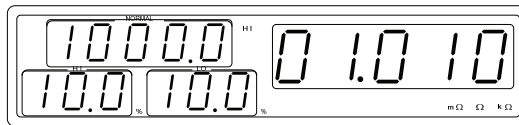

4. Resistance Range

Press the Up and Down arrow keys to manually select the resistance range.



5. Select the Scan mode.

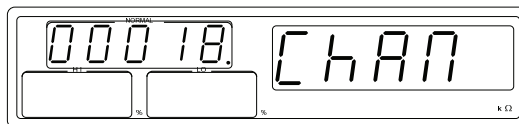

Press **SHIFT** + **NORMAL**<sup>SCAN</sup> to access the scan mode.



Press the Up and Down or Left and right arrow keys to select the number of counts.



Count range 0~100

Press **ENTER** to confirm.



6. Select the Delay time.

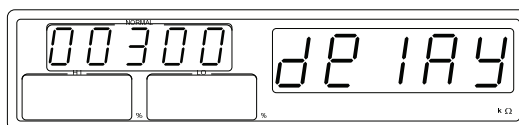

Press the Up and Down or Left and Right arrow keys to set the sweep delay time. Each count unit has a delay time of 16.2 ms.



Count units 30~30,000

Press **ENTER** to confirm.



7. The Ready Display appears

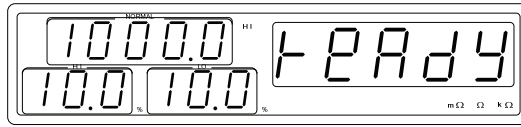

Note

After the Ready indicator is shown it is not possible to make any changes to the compare function or range.

8. Start the scan.

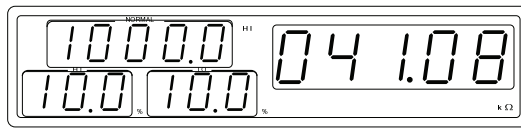

← result

Press the **MANUAL TRIG**<sup>INT</sup> key to start the sweep measurements.



The results will be displayed on screen and output through the scan port until finished.

9. View Results

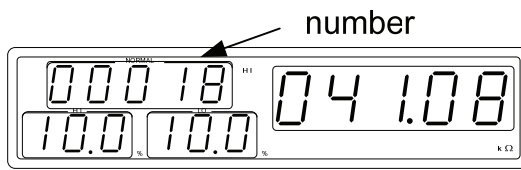

← result

Press the Up and Down arrow keys to cycle through each result. The measurement number will be displayed on the Normal display and the measurement on the main screen.



10. Exit Scan mode

Press **SHIFT** + **NORMAL**<sup>SCAN</sup> at any time to exit the scan mode.

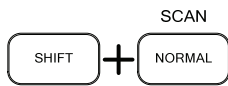



## Scan Output

**Background** The timing diagrams for the scan output under different conditions are shown below.

Ready message displayed...

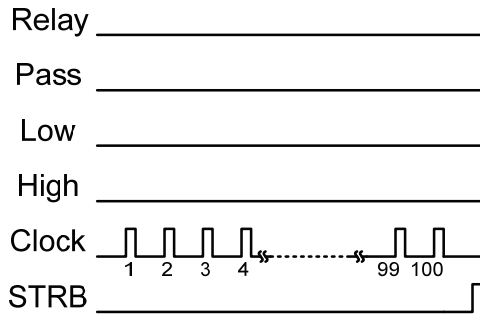

After the **MANUAL TRIG<sup>INT</sup>** key is pressed...

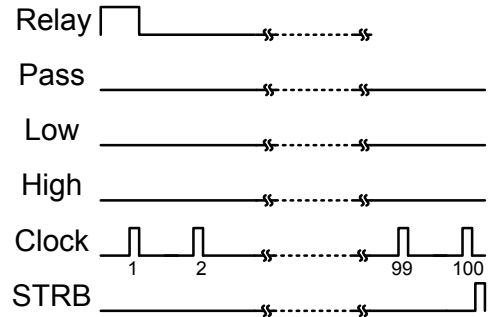

Scan channel 1. Delay time has elapsed.

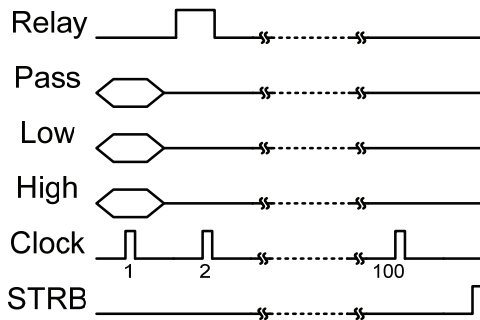

Scan channel n, delay time has elapsed.

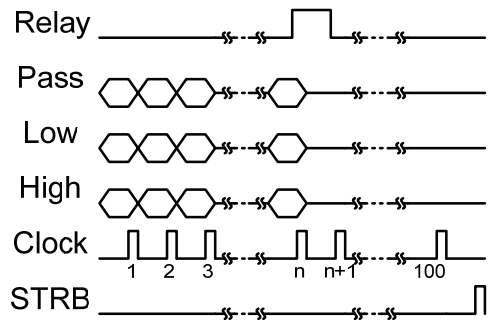

Scan Channel 100. Delay time has elapsed.

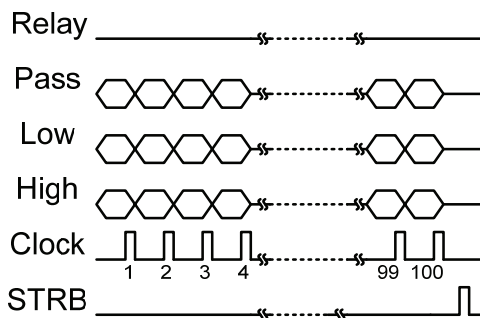

Scan output signal timing.

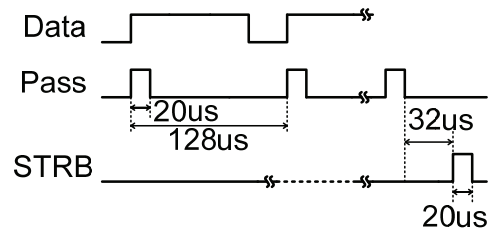

# Configure Interface

**Overview** The RS-232 and GPIB interfaces are factory installed options for remote control of the GOM-802. The remote control interfaces allow the GOM-802 to be programmed for automatic testing.

For more information on the remote control programming, please see the GOM-802 programming manual.

<b>Interface</b>	<b>GPIB</b>	24 pin female GPIB port
	<b>RS-232</b>	DB-9 male port

## Configure GPIB Interface

**Background** The GPIB interface is SCPI-1994, IEEE488.1 and IEEE488.2 compliant.

1. Select the GPIB address.

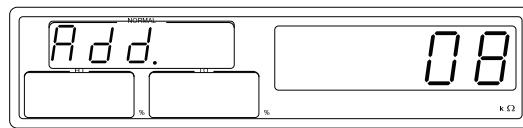

Press **SHIFT** + **LOCAL**<sup>GPIB/RS232</sup> to access the GPIB/RS232 settings.

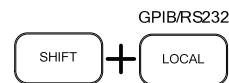

Press the Left or Right arrow key to enter the GPIB address settings.



Press the Up and Down arrow keys to set the GPIB address.



**GPIB Address 0~31**

Press **ENTER** to confirm. The display returns to the main display.



Connect one end of the GPIB cable to the computer and the other end to the GPIB port on the GOM-802.

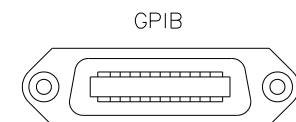

- GPIB Constrains**
- Maximum 15 devices altogether, 20m cable length, 2m between each device
  - Unique address assigned to each device
  - At least 2/3 of the devices turned on
  - No loop or parallel connection

## Configure RS-232 Interface

**Background** The GOM-802 uses an RS-232C connection for remote control. When connecting to a PC ensure the correct baud rate, parity, data bits, stop bit and data control settings are used.

<b>Settings</b>	Baud rate	1200, 2400, 4800, 9600
	Parity	None
	Data bits	8
	Stop bit	1
	Data flow control	None

1. Select the RS-232 baud rate

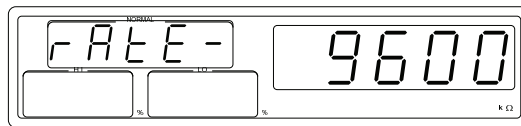

Press **SHIFT** + **LOCAL**<sup>GPIB/RS232</sup> to access the GPIB/RS232 settings.



Press the Up and Down arrow keys to set the baud rate.



Baud rate 1200, 2400, 4800, 9600

Press **ENTER** to confirm. The display goes back to the main display.



Connect the RS-232C cable to rear panel RS232 port.

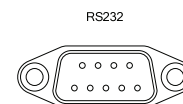

**RS-232C pin assignment**

- Pin 2: RxD
- Pin 3: TxD
- Pin 5: GND
- Pin 1, 4, 6 ~ 9: No Connection

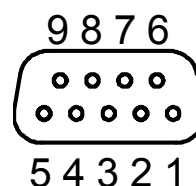

PC – GOM  
RS-232C  
Connection

The RS232 connection uses a Null-modem connection, in which transmit (TxD) and receive (RxD) lines are cross-linked.

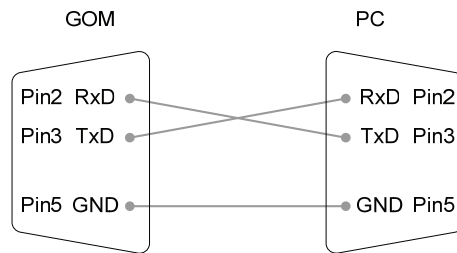

## Interface Function Check

Operation

Run this query from the terminal.

```
*idn?
```

This should return the Manufacturer, Model number, and Firmware version.

```
GW. Inc, GOM-802 , FW1.00
```

Function Check  
Errors

If you do not receive a proper response from the Meter, please check if the power is on, the GPIB address/RS232 baud rate is correct, and all cable connections are active.

# F AQ

---

- What are the different measurement speeds?
  - The GOM-802 performance does not match the specifications.
- 

## **What are the different measurement speeds?**

There are two measurement speeds for both resistance and temperature measurement. At 30,000 counts the measurement speed is 7 readings/s, at 3,000 counts the measurement speed is 30 readings/s.

---

## **The GOM-802 performance does not match the specifications.**

Make sure the device is powered on for at least 30 minutes, within +18°C~+28°C with a humidity not exceeding 80%. This is necessary to stabilize the unit to match the specifications.

---

If there is still a problem, please contact your local dealer or GWInstek at [marketing@goodwill.com.tw](mailto:marketing@goodwill.com.tw).

# APPENDIX

---

Fuse Replacement	Replace the AC source fuse.....	47
Temperature Measurement	Reference Temperature Table .....	48
	RTD Sensors Temperature .....	49
	Optional Platinum Sensor.....	49
Specifications	Resistance Measurement.....	51
	Temperature Measurement .....	52
	Temperature Correction Function .....	52
	Interface.....	53
	Environmental .....	53
	General .....	53
CE Declaration	Declaration of Conformity.....	54

# Fuse Replacement

## Replace the AC source fuse

---

### Steps

1. Remove the power cord.

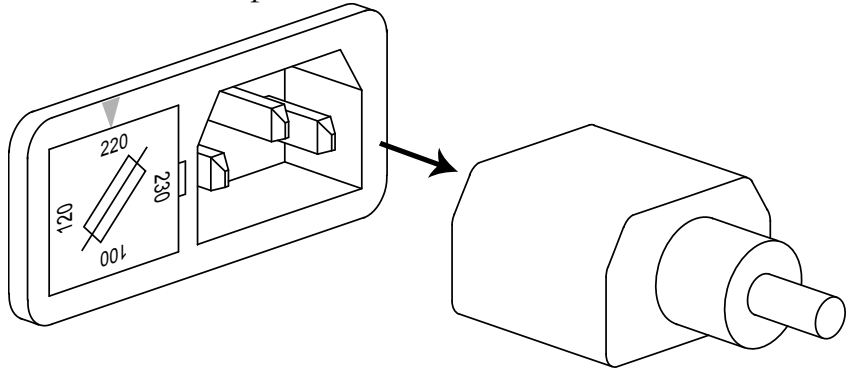

2. Remove the fuse socket using a flat screwdriver.

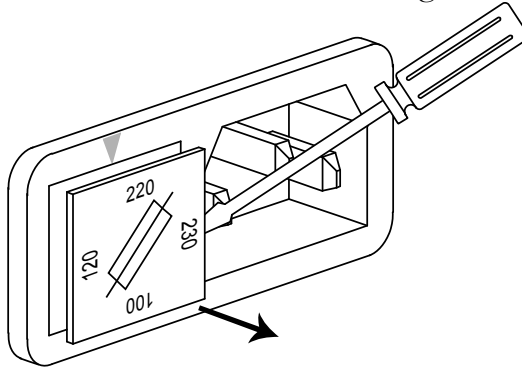

3. Replace the fuse in the holder.

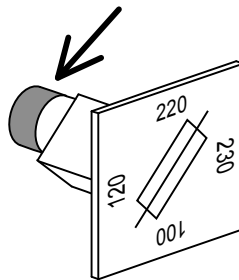

4. Ensure the correct line voltage is lined up with the arrow on the fuse holder. Insert the fuse socket.

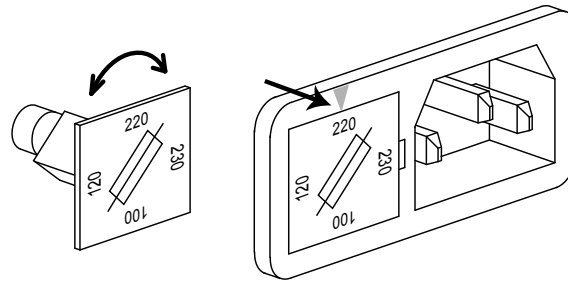

Rating	100V/120V	T*0.3A 250V
	220V/230V	T0.25A 250V

## Temperature Measurement

### Reference Temperature Table

**Overview**            The International Temperature Scale (ITS) is based on the  
**Background**        following table. The table has 17 fixed calibration points as  
of 1990.

Element	Type	Temperature		
		°K	°C	
(H <sub>2</sub> )	Hydrogen	Triple point	13.8033	-259.3467
(Ne)	Neon	Triple point	24.5561	248.5939
(O <sub>2</sub> )	Oxygen	Triple point	54.3584	218.7916
(Ar)	Argon	Triple point	83.8058	-189.3442
(Hg)	Mercury	Triple point	234.325	-38.8344
(H <sub>2</sub> O)	Water	Triple point	273.16	+0.01
(Ga)	Gallium	Melting point	302.9146	29.7646
(In)	Indium	Freezing point	429.7485	156.5985
(Sn)	Tin	Freezing point	505.078	231.928
(Zn)	Zinc	Freezing point	692.677	419.527
(Al)	Aluminum	Freezing point	933.473	660.323
(Ag)	Silver	Freezing point	1234.93	961.78
(Au)	Gold	Freezing point	1337.33	1064.18



## RTD Sensors

---

**Overview** Resistive Thermal Devices (RTDs) are commonly used as temperature sensors. RTDs change resistance linearly over a specific range of temperature. The table below shows some of the inherent features of RTDs compared to thermocouples.

Feature	Description
Accuracy	Higher accuracy
Resolution	0.1~1.0°C, higher resolution
Speed of response	Slower
Self-heating	Yes
Long term stability	Good
Output characteristics	Approx. 0.4ohm/°C, near linear

---

## Optional Platinum Sensor

---

**Introduction** The optional platinum sensor is a PT-100 sensor. The PT-100 sensor meets the German DIN43760: 1968 3 wire measurement specification.

These sensors are one of the most common temperature sensors used in industry. These sensors have a nominal resistance of 100Ω at 0°C.

The relationship between temperature and resistance for the PT-100 sensor can be described with the Gallendarvan Dusen equation shown below:

$$R_{RTD} = R_0 [1 + AT + BT^2 + CT^3 (T - 100)]$$

Where:  $R_{RTD}$  is the calculated resistance of the RTD.

$R_0$  is the known RTD resistance at 0°C.

$T$  is the temperature in °C

$A = \alpha [1 + (\delta/100)]$

$B = -1(\alpha)(\delta)(1e-4)$

$C = -1(\alpha)(\beta)(1e-8)$

The Alpha (A), Beta (B), Delta (D) values for the

PT-100 sensor are listed below:

Type	Standard	Alpha	Beta	Delta	$\Omega$ @ 0°C
PT-100	ITS90	0.003850	0.10863	1.49990	100 $\Omega$

Temperature  
Calculation Example

Example—Calculating the resistance of a PT-100 RTD at 100°C (T). The following  $R_0$  ( $\Omega$  at 0°C), alpha, beta, and delta values are used for the PT-100 RTD:

$$T=100^\circ\text{C}$$

$$R_0 (\Omega \text{ at } 0^\circ\text{C}) = 100\Omega$$

$$\text{Alpha}=0.003850$$

$$\text{Beta}=0.10863$$

$$\text{Delta}=1.49990$$

A, B, and C are calculated according to equations listed above:

$$A=0.00391$$

$$B=5.77e-7$$

$$C=4.18e-12$$

The resistance of the RTD at 100°C ( $R_{100}$ ) is then calculated as follows:

$$\begin{aligned} R_{100}: &= R_0[1+AT+BT^2+CT^3(T-100)] \\ &= 100\{1+[(0.00391)(100)]+[-5.77e-7)(100^2) \\ &\quad +[(-4.18E-12)(100^3)(100-100)]\} \\ &= 138.5\Omega \end{aligned}$$

## Specifications

### Conditions Background

The specifications are applicable under the following conditions:

- A 1-year calibration cycle.
- An operating temperature of 18 to 28 °C (64.4 to 82.4°F).
- Relative humidity not exceeding 80%.
- Accuracy is expressed as  $\pm$ (percentage of reading + digits).
- The instrument requires 30 minutes warm-up time to achieve rated accuracy.
- The power cord protective grounding conductor must be connected to ground.

### Resistance Measurement

30000 counts (speed : 7 readings/second)

Range	Resolution	Measuring Current	Accuracy	Open-Terminal Voltage
30m $\Omega$	1 $\mu\Omega$	1A approx.	0.1%+6*	~1.772V
300m $\Omega$	10 $\mu\Omega$	100mA	0.05%+6*	~1.772V
3 $\Omega$	100 $\mu\Omega$	100mA	0.05%+3	~1.772V
30 $\Omega$	1m $\Omega$	10mA	0.05%+2	~1.772V
300 $\Omega$	10m $\Omega$	1mA	0.05%+2	~1.772V
3k $\Omega$	100m $\Omega$	100 $\mu$ A	0.05%+2	~1.770V
30k $\Omega$	1 $\Omega$	100 $\mu$ A	0.05%+2	~4.570V
300k $\Omega$	10 $\Omega$	10 $\mu$ A	0.05%+2	~4.526V
3M $\Omega$	100 $\Omega$	1 $\mu$ A	0.05%+2	~4.148V

3000 counts Accuracy (speed: 30 readings/second)  $\pm 5$  counts \*\*

\*When the instrument is set to 30m $\Omega$  or 300m $\Omega$  ranges, the resistance value will be changed while connecting or disconnecting the test lead to the panel due to the different temperature between internal and external parts of the instrument. Therefore, please must wait 1 minute in order to obtain an accurate value after the test leads have been connected or disconnected.

\* When Kelvin clips are used to resume testing after a long period of time, please wait for a short time to stabilize the measurement.

\*\* In high speed mode, first ensure that the instrument has been grounded through the power cord.

Measurement	Four-terminal method.
Auto-ranging	Provided.
Over input range	“OL” indication
Maximum Applied voltage	30m~3Ω range: 30VpDC Other range: 100VpDC
Comparator	20 sets of comparator status can be selected.
Buzzer mode switchable	NON, PASS, FAIL

## Temperature Measurement

Temperature sensor (option)	Platinum resistor. Lead length: 1.5m approx.	
Range	Accuracy Speed: 7 readings/second	Accuracy Speed: 30 readings/second
-50.0°C ~ -10.0°C	0.3%+1.0°C	0.3%+3°C
-9.9°C ~ 39.9°C	0.3%+0.5°C	0.3%+2°C
40°C ~ 100°C	0.3%+1.0°C	0.3%+3°C

## Temperature Correction Function

Temperature correction range	0.0°C~39.9°C
Reference temperature range	0°C~99.9°C
Thermal coefficient range	±9999 ppm
Temperature range	Accuracy of temperature compensation for 3930 ppm/Cu wire, speed: 7 readings/second.*
0°C~39.9°C	0.3%+resistance measurement accuracy.
40°C~100°C	0.6%+resistance measurement accuracy.

\*The temperature coefficient for the other settings must be calculated individually according to different conditions.

\*If the temperature coefficient or the difference between the environmental temperature and the required temperature exceeds normal operation, after calculating the compensation, the variation to the reading value will be significant.

## Interface

Handler interface*	Signal: START TTL input Signal: LOW, HIGH, FAIL, PASS, EOT, READY total 6 TTL outputs. (This function is valid only under the resistance measurement mode and the compare mode is enabled.)
Scan*	Signal: READY, PASS, LOW, HIGH, CLOCK, STRB total 6 TTL outputs. (This function is valid only under the resistance measurement mode and the compare mode is enabled.)
RS-232+ GPIB (option)	IEEE488.1-1987, IEEE488.2-1992 and SCPI-1994 * The Scan and Handler interface use the same connector

## Environmental

Operation Environment	Indoor use, altitude up to 2000m. Ambient Temperature 0°C to 40°C. Relative Humidity 80% (Maximum). Installation category II Pollution Degree 2
Storage temperature	-10°C to 70°C.

## General

Power source	AC 100V/120V/220V/230V $\pm$ 10%, 50/60Hz, 27VA, 22W.
Accessories	Test Lead $\times$ 1, User manual $\times$ 1, Programmable manual $\times$ 1 (option), Temperature sensor (option) $\times$ 1
Dimension	251(W) $\times$ 91(H) $\times$ 291(D) mm
Weigh	Approx. 3 kg

# Declaration of Conformity

We  
**GOOD WILL INSTRUMENT CO., LTD.**  
 declare, that the below mentioned product  
 Type of Product: **DC Milliohm Meter**  
 Model Number: **GOM-802**  
 are herewith confirmed to comply with the requirements set out in the  
 Council Directive on the Approximation of the Law of Member States  
 relating to Electromagnetic Compatibility (2014/30/EU) and Low Voltage  
 Directive (2014/35/EU).  
 For the evaluation regarding the Electromagnetic Compatibility and Low  
 Voltage Directive, the following standards were applied:

## © EMC

<b>EN 61326-1:</b> EN 61326-2-1	Electrical equipment for measurement, control and laboratory use — EMC requirements (2013)
Conducted & Radiated Emission EN 55011: 2009+A1:2010 Class A	Electrical Fast Transients EN 61000-4-4: 2012
Current Harmonics EN 61000-3-2: 2006+A1: 2009+A2: 2009	Surge Immunity EN 61000-4-5: 2006
Voltage Fluctuations EN 61000-3-3: 2008	Conducted Susceptibility EN 61000-4-6: 2009
Electrostatic Discharge EN 61000-4-2: 2009	Power Frequency Magnetic Field EN 61000-4-8: 2010
Radiated Immunity EN 61000-4-3: 2006+A1: 2008+A2: 2010	Voltage Dip/ Interruption EN 61000-4-11: 2004

## © Safety

Low Voltage Equipment Directive 2014/35/EU	
<b>Safety Requirements</b>	EN 61010-1: 2010 / EN 61000-2-30:2010

GOOD WILL INSTRUMENT CO., LTD.

No. 7-1, Jhongsing Road, Tucheng Dist., New Taipei City 236, Taiwan

Tel: +886-2-2268-0389

Fax: +866-2-2268-0639

Web: [www.gwinstek.com](http://www.gwinstek.com)

Email: [marketing@goodwill.com.tw](mailto:marketing@goodwill.com.tw)

GOOD WILL INSTRUMENT (SUZHOU) CO., LTD.

No. 521, Zhujiang Road, Snd, Suzhou Jiangsu 215011, China

Tel: +86-512-6661-7177

Fax: +86-512-6661-7277

Web: [www.instek.com.cn](http://www.instek.com.cn)

Email: [marketing@instek.com.cn](mailto:marketing@instek.com.cn)

GOOD WILL INSTRUMENT EURO B.V.

De Run 5427A, 5504DG Veldhoven, The Netherlands

Tel: +31(0)40-2557790

Fax: +31(0)40-2541194

Email: [sales@gw-instek.eu](mailto:sales@gw-instek.eu)

# INDEX

Buzzer	
setting .....	30
Characteristics .....	9
Compare function	
setting .....	26
Declaration of conformity .....	54
Disposal instructions .....	6
EN 61010	
measurement category .....	5
pollution degree .....	6
Environment	
operation .....	6
storage .....	6
FAQ .....	45
Front panel overview .....	12
Fuse	
AC fuse replacement .....	47
safety instructions .....	5
Getting Started chapter .....	8
Handler	
overview .....	37
Interface	
GPIB	
setting .....	42
overview .....	42
RS-232	
setting .....	43
Overview	
measurement .....	22
Percentage	
setting .....	31
Power supply safety instructions .....	5
Power up .....	18
PT-100 sensor temperature calculation .....	49
Rate	
setting .....	25
Rear panel overview .....	16
Reference temperature table .....	48, 50
Relative function	
setting .....	32, 33
Resistance	
setting .....	23
Resistance measurement	
connection .....	19
Safety instruction	
Guidelines .....	5
Safety instructions	
fuse .....	5
power supply .....	5
symbol .....	4
Scan	
overview .....	38
setting .....	38
Service contact .....	45
Specifications .....	51
Table of contents .....	3
Temperature	
setting .....	32
Temperature compensation	
setting .....	34
Tilt stand .....	17
Trigger	
setting .....	25
United Kingdom power cord .....	7
Zeroing	
connection .....	20