

Digital Storage Oscilloscope

GDS-2000 Series

USER MANUAL

GW INSTEK PART NO. 82DS-22040ME1



ISO-9001 CERTIFIED MANUFACTURER

GW INSTEK

December 2010

This manual contains proprietary information, which is protected by copyrights. All rights are reserved. No part of this manual may be photocopied, reproduced or translated to another language without prior written consent of Good Will company.

The information in this manual was correct at the time of printing. However, Good Will continues to improve products and reserves the rights to change specification, equipment, and maintenance procedures at any time without notice.

Good Will Instrument Co., Ltd.
No. 7-1, Jhongsing Rd., Tucheng City, Taipei County 236, Taiwan.

Table of Contents

SAFETY INSTRUCTIONS	5
GETTING STARTED	10
GDS-2000 Series Overview	11
Appearance	14
Set Up	22
QUICK REFERENCE	26
Menu Tree / Operation Shortcuts	27
Default Settings	45
Built-in Help	46
MEASUREMENT	47
Basic Measurement	48
Automatic Measurement	55
Cursor Measurement	60
Math Operation	64
Go-NoGo Test	69
Program	78
CONFIGURATION	83
Acquisition	85
Display	91
Horizontal View	95
Vertical View (Channel)	102
Trigger	106
System Info / Language / Clock	116
SAVE/RECALL	119
File Format/Utility	120
Quick Save (HardCopy)	126

Save	128
Recall	137
PRINT OUT	146
REMOTE CONTROL CONFIG	149
Interface Configuration	150
BATTERY OPERATION	156
MAINTENANCE	158
Vertical Resolution Calibration	158
Probe Compensation	159
FAQ	161
APPENDIX	164
Fuse Replacement	164
GPIB Module Installation	165
GDS-2000 Specifications	166
Probe Specifications	169
INDEX	171

S SAFETY INSTRUCTIONS

This chapter contains important safety instructions that you must follow when operating GDS-2000 and when keeping it in storage. Read the following before any operation to insure your safety and to keep the best condition for GDS-2000.

Safety Symbols

These safety symbols may appear in this manual or on GDS-2000.



WARNING

Warning: Identifies conditions or practices that could result in injury or loss of life.



CAUTION

Caution: Identifies conditions or practices that could result in damage to GDS-2000 or to other properties.



DANGER High Voltage



Attention Refer to the Manual



Protective Conductor Terminal



Earth (ground) Terminal



Do not dispose electronic equipment as unsorted municipal waste. Please use a separate collection facility or contact the supplier from which this instrument was purchased.

Safety Guidelines

General Guideline



CAUTION

- Make sure the BNC input voltage does not exceed 300V peak.
- Never connect a hazardous live voltage to the ground side of the BNC connectors. It might lead to fire and electric shock.
- Do not place any heavy object on GDS-2000.
- Avoid severe impacts or rough handling that leads to damaging GDS-2000.
- Do not discharge static electricity to GDS-2000.
- Use only mating connectors, not bare wires, for the terminals.
- Do not block the cooling fan opening.
- Do not perform measurement at power source and building installation site (Note below).
- Do not disassemble GDS-2000 unless you are qualified.

(Measurement categories) EN 61010-1:2001 specifies the measurement categories and their requirements as follows. GDS-2000 falls under category II.

- Measurement category IV is for measurement performed at the source of low-voltage installation.
 - Measurement category III is for measurement performed in the building installation.
 - Measurement category II is for measurement performed on the circuits directly connected to the low voltage installation.
 - Measurement category I is for measurements performed on circuits not directly connected to Mains.
-

- Power Supply
- AC Input voltage: 100 ~ 240V AC, 48 ~ 63Hz
 - The power supply voltage should not fluctuate more than 10%.
 - Connect the protective grounding conductor of the AC power cord to an earth ground, to avoid electrical shock.
-

- Fuse
- Fuse type: T2A/250V
 - Make sure the correct type of fuse is installed before power up.
 - To ensure fire protection, replace the fuse only with the specified type and rating.
 - Disconnect the power cord before fuse replacement.
 - Make sure the cause of fuse blowout is fixed before fuse replacement.
-

- Cleaning GDS-2000
- Disconnect the power cord before cleaning.
 - Use a soft cloth dampened in a solution of mild detergent and water. Do not spray any liquid.
 - Do not use chemical containing harsh material such as benzene, toluene, xylene, and acetone.
-

- Operation Environment
- Location: Indoor, no direct sunlight, dust free, almost non-conductive pollution (Note below)
 - Relative Humidity: $\leq 80\%$, 40°C or below
 $\leq 45\%$, 41°C~50°C
 - Altitude: < 2000m
 - Temperature: 0°C to 50°C

(Pollution Degree) EN 61010-1:2001 specifies the pollution degrees and their requirements as follows. GDS-2000 falls under degree 2.

Pollution refers to “addition of foreign matter, solid, liquid, or gaseous (ionized gases), that may produce a reduction of dielectric strength or surface resistivity”.

- Pollution degree 1: No pollution or only dry, non-conductive pollution occurs. The pollution has no influence.
- Pollution degree 2: Normally only non-conductive pollution occurs. Occasionally, however, a temporary conductivity caused by condensation must be expected.
- Pollution degree 3: Conductive pollution occurs, or dry, non-conductive pollution occurs which becomes conductive due to condensation which is expected. In such conditions, equipment is normally protected against exposure to direct sunlight, precipitation, and full wind pressure, but neither temperature nor humidity is controlled.

Storage environment

- Location: Indoor
- Storage Temperature: $-10^{\circ}\text{C}\sim 60^{\circ}\text{C}$, no condensation-
- Relative Humidity: 93% @ 40°C
65% @ $41^{\circ}\text{C}\sim 60^{\circ}\text{C}$

Disposal



Do not dispose this instrument as unsorted municipal waste. Please use a separate collection facility or contact the supplier from which this instrument was purchased. Please make sure discarded electrical waste is properly recycled to reduce environmental impact.

Power cord for the United Kingdom

When using GDS-2000 in the United Kingdom, make sure the power cord meets the following safety instructions.

NOTE: This lead/appliance must only be wired by competent persons

 **WARNING: THIS APPLIANCE MUST BE EARTHED**

IMPORTANT: The wires in this lead are coloured in accordance with the following code:

Green/ Yellow:	Earth
Blue:	Neutral
Brown:	Live (Phase)



As the colours of the wires in main leads may not correspond with the colours marking identified in your plug/appliance, proceed as follows: The wire which is coloured Green & Yellow must be connected to the Earth terminal marked with the letter E or by the earth symbol  or coloured Green or Green & Yellow.

The wire which is coloured Blue must be connected to the terminal which is marked with the letter N or coloured Blue or Black.

The wire which is coloured Brown must be connected to the terminal marked with the letter L or P or coloured Brown or Red.

If in doubt, consult the instructions provided with the equipment or contact the supplier.

This cable/appliance should be protected by a suitably rated and approved HBC mains fuse: refer to the rating information on the equipment and/or user instructions for details. As a guide, cable of 0.75mm² should be protected by a 3A or 5A fuse. Larger conductors would normally require 13A types, depending on the connection method used.

Any moulded mains connector that requires removal /replacement must be destroyed by removal of any fuse & fuse carrier and disposed of immediately, as a plug with bared wires is hazardous if engaged in live socket. Any re-wiring must be carried out in accordance with the information detailed on this label.

GETTING STARTED

This chapter describes GDS-2000 in a nutshell, including its main features and front / rear panel introduction. After going through the overview, follow the Set Up section to properly set up operation environment.

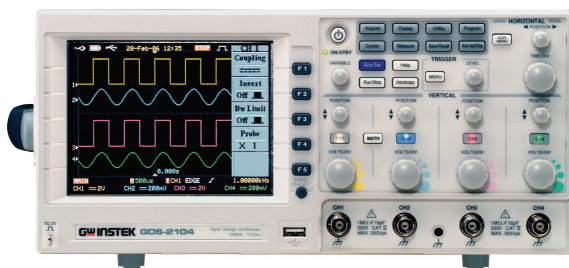

GDS-2000 series overview	Series lineup	11
	Main Features.....	12
	Package Contents	13
Appearance	GDS-2064/2104/2204 Front Panel.....	14
	GDS-2062/2102/2202 Front Panel.....	14
	Rear Panel	18
	Display	20
Set Up	Tilt stand.....	22
	Power up	23
	First Time Use.....	24

GDS-2000 Series Overview

Series lineup

GDS-2000 series consists of 6 models, divided into 2-channel and 4-channel versions.

Model name	Frequency bandwidth	Input channels	Ext. trigger input	Advanced delay trigger
GDS-2062	60MHz	2	Yes	Yes
GDS-2102	100MHz	2	Yes	Yes
GDS-2202	200MHz	2	Yes	Yes
GDS-2064	60MHz	4	No	No
GDS-2104	100MHz	4	No	No
GDS-2204	200MHz	4	No	No

The differences between 2 and 4 channel model appearance are in the horizontal key, trigger key, variable knob, and external trigger input layout.

2-Channel model

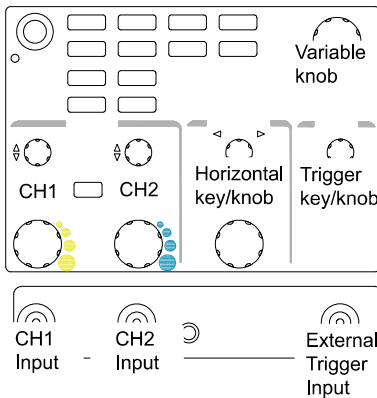

4-Channel model

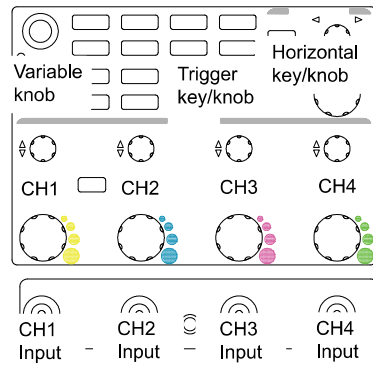

Main Features

- | | |
|-------------|---|
| Performance | <ul style="list-style-type: none">• High sampling rate: up to 1GS/S real-time, 25GS/s equivalent-time• Deep memory: 25k points record length• Minimum 10ns peak detection |
| Feature | <ul style="list-style-type: none">• Wide selection range: 60MHz to 200MHz bandwidth, 2 or 4 channels• Powerful display: 5.6 in. color TFT, wide viewing angle, 8x12 divisions waveform support• Battery operation• Automatic measurements: maximum 27 types• FFT analysis• Triggers: Edge, Video, Pulse Width• Advanced Delay trigger (for 2CH model only)• Program and play mode• Color printout of display contents• Go-No Go test• Built-in Help |
| Interface | <ul style="list-style-type: none">• USB host port: front and rear panel, to printers and storage devices• USB slave port, RS-232C port, GPIB port (option): for remote control• USB slave port for PC software connection• Calibration output• Go-No Go output• External trigger input (for 2CH model only) |

Package Contents

Check the contents before using GDS-2000.

Opening the box

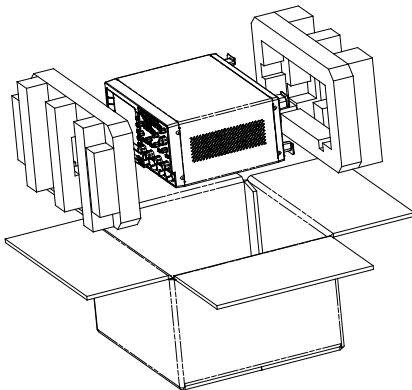

Contents

- Main unit
 - Probe set
 - GDS-2062: GTP-060A x 2
 - GDS-2064: GTP-060A x 4
 - GDS-2102: GTP-100A x 2
 - GDS-2104: GTP-100A x 4
 - GDS-2202: GTP-250A x 2
 - GDS-2204: GTP-250A x 4
 - Power cord
 - User manual (this document)
-

Note

- For detailed specification of probe, see page169.
- Program manual, PC software, and USB driver are downloadable from GWInstek website. Visit www.gwinstek.com , GDS-2000 corner.



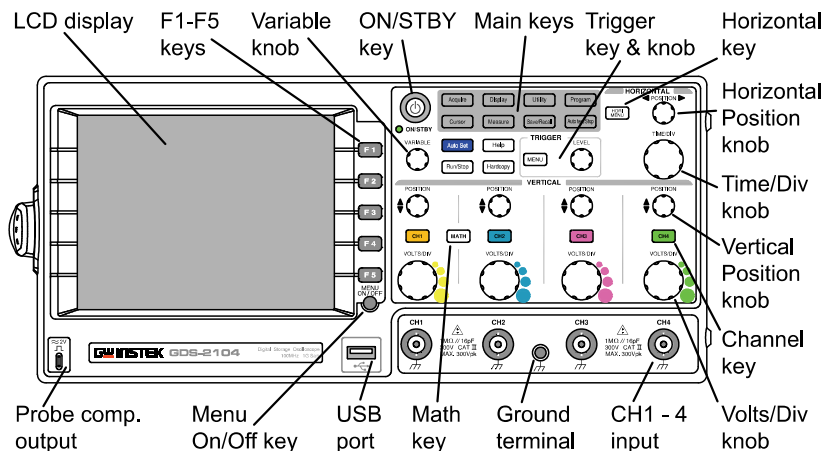

Appearance



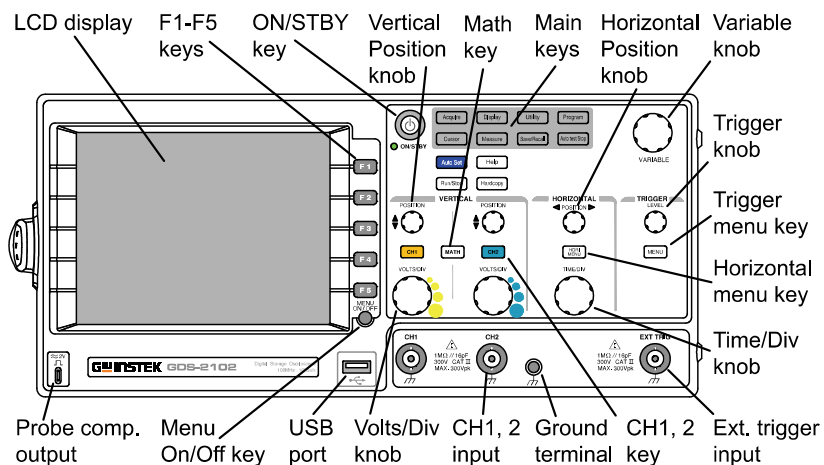



GDS-2064/2104/2204 Front Panel

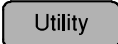
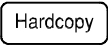
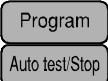

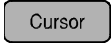
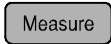
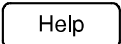
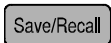

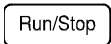

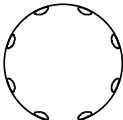

GDS-2062/2102/2202 Front Panel

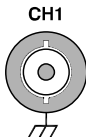

LCD display	TFT color, 320 x 234 resolution, wide angle view LCD display.
F1 ~ F5 function keys	 Activates the functions which appear on the left side of the LCD display.
Variable knob	VARIABLE  Increases/decreases value or moves to the next/previous parameter.
On/Standby key	 Switches between the power On state (green indicator) and standby state (red indicator). For power up sequence, see page23.
Acquire key	 Configures acquisition mode (page85).
Display key	 Configures display settings (page91).
Utility key	 Configures or shows hardcopy (page126), printer configuration (page146), interface (page150), system info (page116), date/time (page117), menu language (page116), Go-No Go (page69), calibration (page158), and probe compensation (page159).
Hardcopy key	 Prints out display image (page146) or transfers data to USB flash drive (page126).
Program key + Auto test key	 Edits, runs, and stops program operation (page78).

Cursor key		Configures and runs cursor measurements (page60).
Measure key		Configures and runs automatic measurements (page55).
Help key		Shows Help contents on the LCD display (page46).
Save/Recall key		Saves and recalls waveform, image, and panel setup (page119).
Auto Set key		Finds signals and sets the appropriate horizontal / vertical / trigger settings (page49).
Run/Stop key		Freezes (Stop) or continues (Run) signal acquisition (page50).
Trigger menu key		Configures trigger settings (page106).
Trigger knob	<p>LEVEL</p> 	Sets trigger level (page106).
Horizontal menu key		Configures horizontal view (page95).
Horizontal position knob	<p>◀ POSITION ▶</p> 	Sets the horizontal position of waveforms (page95).
Time/Div knob	<p>TIME/DIV</p> 	Selects the horizontal scale (page96).

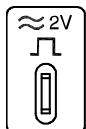
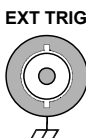
Vertical position knob		Sets the vertical position of waveforms (page102).
Channel menu key		Configures the vertical scale and coupling mode for each channel (page102).
Volts/Div knob		Selects the vertical scale (page102).
Input terminal		Accepts input signals. Input impedance: $1M\Omega \pm 2\%$.
Ground terminal		Accepts the DUT ground lead for common ground.
Math key		Configures and runs math operation (page64).
USB host port		TypeA, 1.1/2.0 compatible. Prints out display image (page146) or transfers data (page119).
Menu On/Off key		Shows or hides menu in the LCD display (page94).
Probe compensation output		Outputs 2Vp-p, square signal for probe compensation (page159) or demonstration. Can be used for generic purpose (page53) as well.
External trigger input		For 2ch model only. Accepts external trigger signal (page106). Input impedance: $1M\Omega \pm 2\%$.

Rear Panel

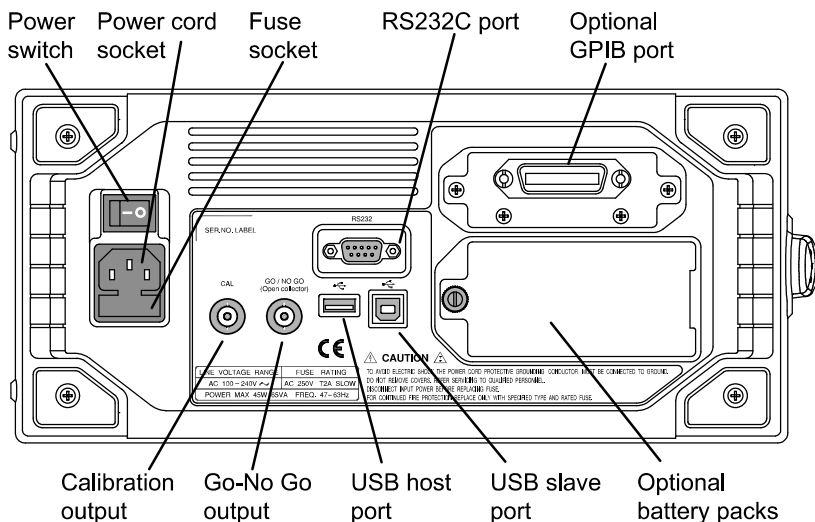

Power switch

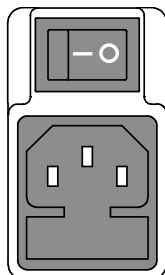

Power switch turns the main power On (I) / Off (O).

Power cord socket

Power cord socket accepts AC mains, 100 ~ 240V, 50/60Hz.

Fuse socket

Fuse socket holds AC main fuse, T2A/250V.

For power up sequence, see page23.
For fuse replacement procedure, see page164.

RS232C port

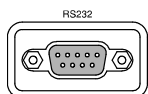

Accepts DB-9 RS-232C connector for remote control (page151).

GPIB port (optional)  Accepts 24 pin male GPIB connector for remote control (page153).

Battery packs (optional) Holds 2 packs of Li-Ion battery for portable usage (page156).

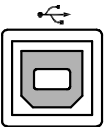
USB slave port  Accepts typeB connector for remote control (page150) or PC software connection. USB 1.1/2.0 full speed compatible.

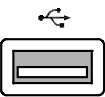
USB host port  Accepts typeA connector for display image printout (page146) or data transfer (page119). Simultaneous use with the front panel host port is not allowed. TypeA, 1.1/2.0 full speed compatible.

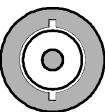
Go-No Go output  GO / NO GO (Open collector) Outputs Go-No Go test result (page69) as 10us pulse signal.

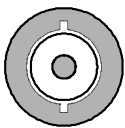
Calibration output  CAL Outputs the signal for vertical scale accuracy calibration (page158).

Display

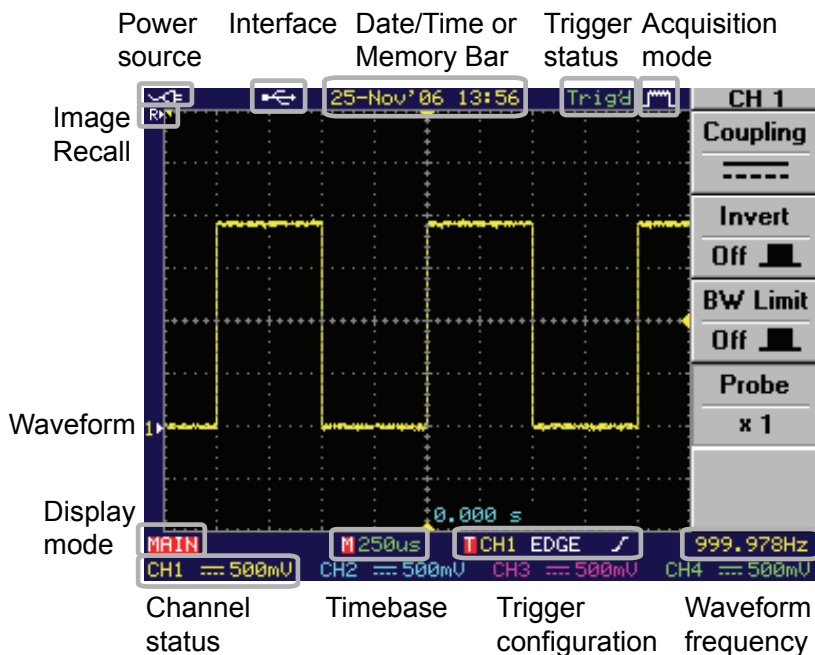











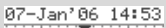





Waveforms	Shows input signal waveforms.	
	Channel 1: Yellow	Channel 2: Blue
	Channel 3: Pink	Channel 4: Green

Power source		AC main is the source.
		Battery (page156) is the source.
		AC main is the source: battery is installed as well.

Image recall		The "R" indicator shows that the display shows pre-recorded image, not signal waveform.
--------------	--	---

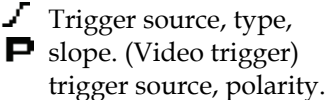
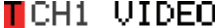
Interface	Shows the active interface for remote connection (page149) and PC software connection.
-----------	--

		USB
		RS-232C
		GPIB (optional)
Date/Time		Current date and time (page117).
Memory bar		The ratio and the position of the displayed waveform compared with the internal memory (page95).
Trigger status		Triggered.
		Not triggered, display not updated.
		Not triggered, display updated.
		Trigger stopped. Also appears in Run/Stop (page50).
For trigger details, see page106.		
Acquisition mode		Normal mode
		Peak detect mode
		Average mode
For acquisition details, see page85.		
Input signal frequency		Shows the input signal frequency.
		Indicates the frequency is less than 20Hz (lower frequency limit).
Trigger configuration		
		
For trigger details, see page106.		
Channel status		Channel 1, bw limit On, DC coupling, 500mV/Div
		Channel 1, bw limit Off, AC coupling, 500mV/Div
For channel details, see page102.		

Set Up

Tilt stand



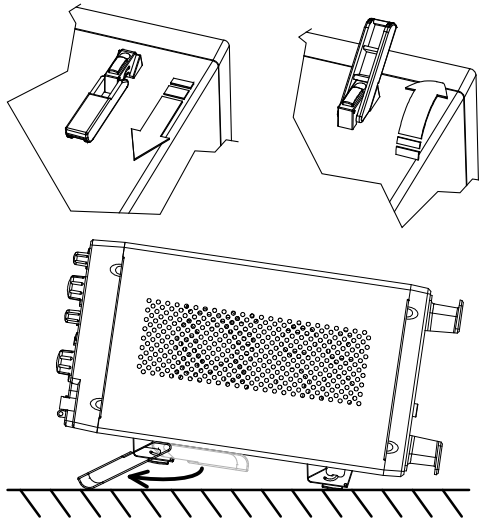

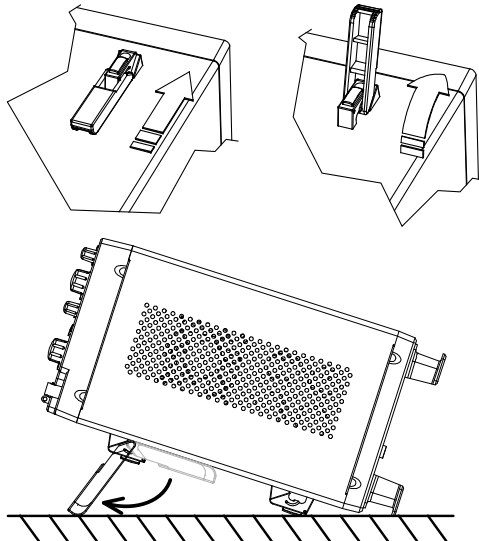

Low angle

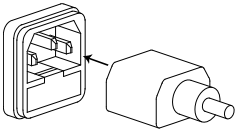
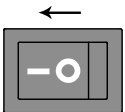

High angle



Power up

- | | | |
|------|---|---|
| Step | <ol style="list-style-type: none"> 1. Connect the power cord to the rear panel socket. (No need when using the battery). |  |
| | <ol style="list-style-type: none"> 2. Turn On the main power switch. I : On, O : Off. |  |
| | <ol style="list-style-type: none"> 3. The ON/STBY indicator on the front panel turns red. |  |
| | <ol style="list-style-type: none"> 4. Press the ON/STBY key. The indicator turns green and the display becomes active in 6 ~ 8 seconds. |  |
| | <ol style="list-style-type: none"> 5. The power icon on the upper left corner of the display shows the power source. When both AC mains and battery are available, AC mains is automatically selected. | <p>AC mains </p> <p>Battery </p> <p>AC mains (battery also installed) </p> |

Note GDS-2000 recovers the state right before the power OFF. The default setting can be recovered by pressing the Save/Recall key → F1 (Default Setup). For details, see page137.

First Time Use

Background This section describes how to connect a signal, adjust the scale, and compensate the probe. Before operating GDS-2000 in a new environment, run these steps to make sure the instrument is functionally stable and that you are comfortable operating it.

1. Power On Follow the procedure on the previous page.

2. Reset system Reset the system by recalling the factory setting. Press the Save/Recall key, then F1 (Default Setup). For factory setting details, see page45.

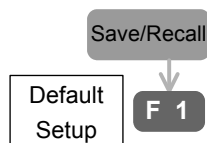

2. Connect probe Connect the probe to Channel1 input terminal and probe compensation signal output (2Vp-p, 1kHz square wave).

Set the probe attenuation to x10.

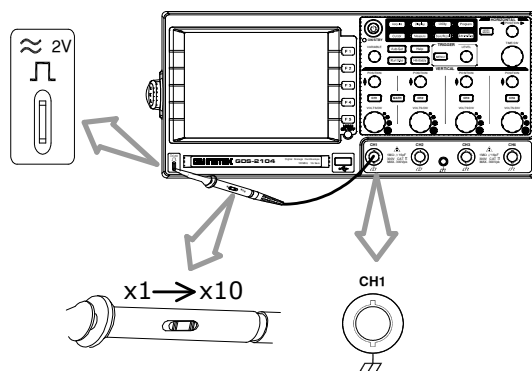

3. Capture signal (Auto Set) Press the Auto Set key. A square waveform appears on the center of the waveform. For Auto Set details, see page49.



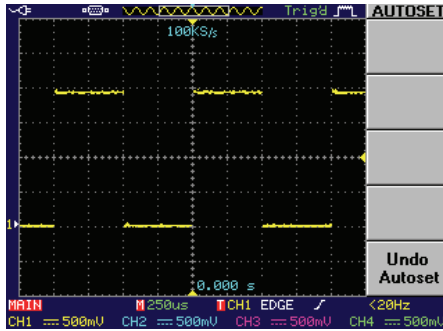

4. Select vector waveform

Press the Display key, then F1 (Type) twice to select the vector waveform.

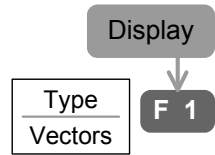
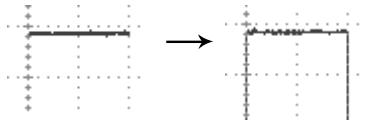

5. Compensate probe

Turn the adjustment point on the probe to make the square waveform edge flat.

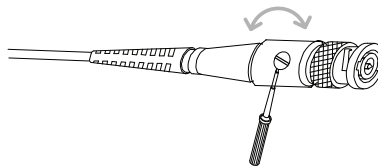
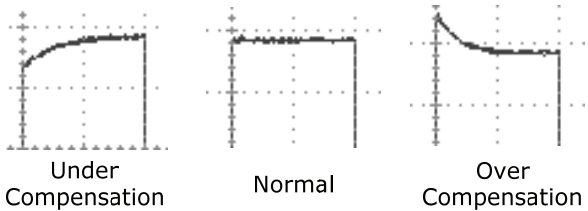

6. Start operation Continue with the other operations.

Measurement: page47 Configuration: page83

Remote control: page149



QUICK REFERENCE

This chapter describes GDS-2000 menu tree, shortcuts to major operations, built-in Help access, and default factory settings. Use them as a handy reference to get a quick access to the functionality.

Menu tree / shortcut	Convention27
	Acquire key27
	Auto Set key27
	Auto test/Stop key28
	CH1 ~ 4 key28
	Cursor key28
	Display key29
	Hardcopy key29
	Help key29
	Horizontal menu key29
	Math key (1/2)30
	Measure key (1/2)31
	Program key (1/2)32
	Run/Stop key32
	Save/Recall key (1/9)33
	Trigger key (1/5)37
	Utility key (1/9)39
Default setup	Default Settings45
Help	Built-in Help46

Menu Tree / Operation Shortcuts

Convention

- F1 = Press F1
- F1  = Press F1 repeatedly
- F1 ~ F4 = Select one from F1 to F4 and press it
- F1 → VAR  = Press F1, then use the Variable knob
- Auto Set = Press the function key itself (AutoSet in this case)

Acquire key

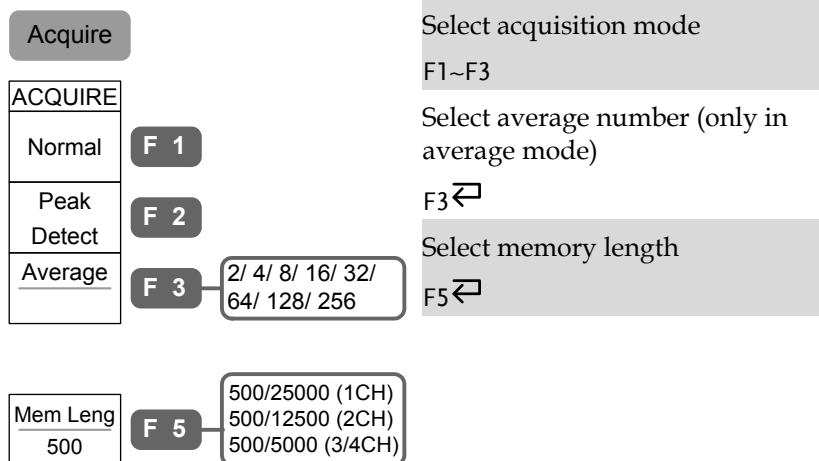

Auto Set key

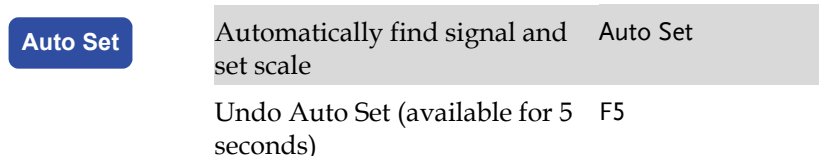

Auto test/Stop key

Auto test/Stop

→ See Program key (page32)





CH1 ~ 4 key

CH1		Select coupling mode F1 ←
Coupling -----	F 1 ~ / - - - - / ⇨	Turn waveform invert On/Off F2 ←
Invert Off ■	F 2 ~ On/ Off	Turn bandwidth limit On/Off F3 ←
BW Limit Off ■	F 3 ~ On/ Off	Select probe attenuation factor F4 ←
Probe x1	F 4 ~ x1/ x10/ x100	

Cursor key

Cursor		Select cursor source channel F1 ←
CURSORS		
Source CH1	F 1 ~ (4CH) CH1/ 2/ 3/ 4/ MATH (2CH) CH1/ 2/ MATH	Select active horizontal cursor F2 ←
Horizontal 	F 2 ~ /	Select active vertical cursor F3 ←
Vertical -----	F 3 ~ ----- / ----- ----- / -----	
T ₁ : -236.0us T ₂ : 160.0us Δ: 396.0us f: 2.525kHz	F 4	
V ₁ : 1.54V V ₂ : -460mV Δ: 2.00V	F 5	

Display key

Display	
DISPLAY	
Type	F 1 Vectors/ Dots
Dots	
Accumulate	F 2 On/ Off
Off 	
Refresh	F 3
Contrast	F 4
	
	F 5 

Select waveform display type

F1 

Waveform accumulation On/Off

F2 , F3 (display refresh when On)

Set display contrast

F4 → VAR 

Select display grid

F5 

Hardcopy key

Hardcopy

→ See Utility key (page39)

Help key

Help

Turn help mode On/Off Help

Horizontal menu key

HORI MENU	
Hor.MENU	
Main	F 1
Window	F 2
Window Zoom	F 3
Roll	F 4
XY	F 5

Select main (default) display

F1

Select Window mode and zoom

F2 → TIME/DIV , F3

Select windows roll mode

F4

Select XY mode

F5

Math key (1/2)

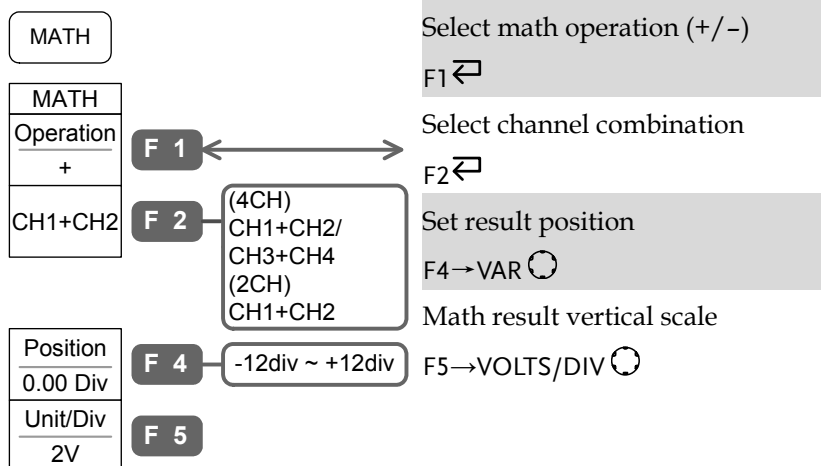

Math key (2/2)

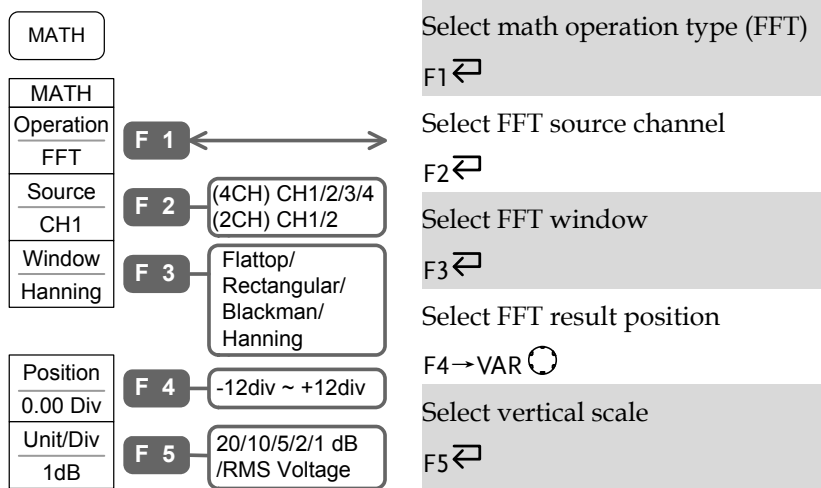

Measure key (1/2)

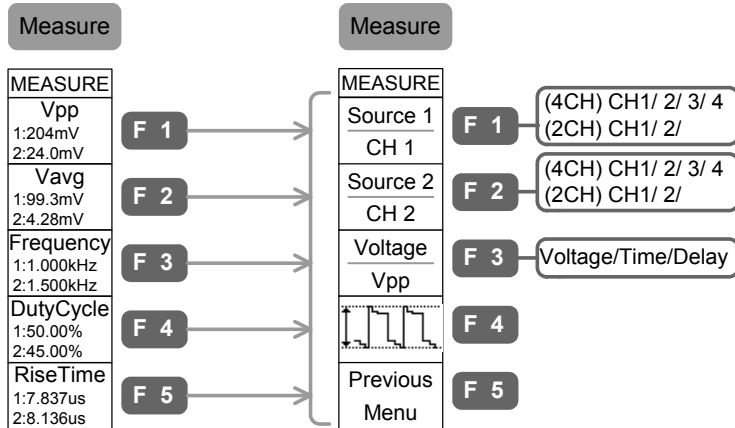

- Select source channel 1 F1 ←
- Select source channel 2 F2 ←
- Select measurement type F3 ←
- Select measurement item VAR or F4 ←
- Go back to previous menu F5

Measure key (2/2)

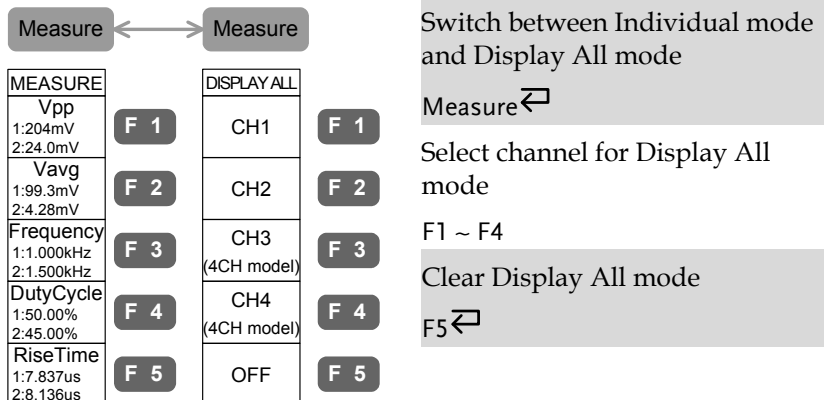

Switch between Individual mode and Display All mode

Measure ←

Select channel for Display All mode

F1 ~ F4

Clear Display All mode

F5 ←

Program key (1/2)

Program		Select Program Edit mode
PROGRAM		F1
▶ Edit	F 1	Select program step
Play		F2 → VAR
Step	F 2	Select edit item
01.	1 ~ 20	F3
Item	F 3	Save edited program
Menu	Menu/Time/Setup	F5
Save		
	F 5	

Program key (2/2)

Program		Auto test/Stop	Select Program Play mode
PROGRAM			F1
Edit	F 1	Select program loop count	
▶ Play		F2 → VAR	
Cycle	F 2	Select first step (From:)	
99	1 ~ 99	F3 → VAR	
▶ From: 1	F 3	Select last step (To:)	
To: 4	1 ~ 20 (From ≤ To)	F3 → VAR	
Start		Start /stop program running	
	F 5	F5 (start), Auto test/Stop (stop)	

Run/Stop key

Run/Stop	Freeze/unfreeze signal acquisition	Run/Stop
----------	------------------------------------	----------

Save/Recall key (1/9)

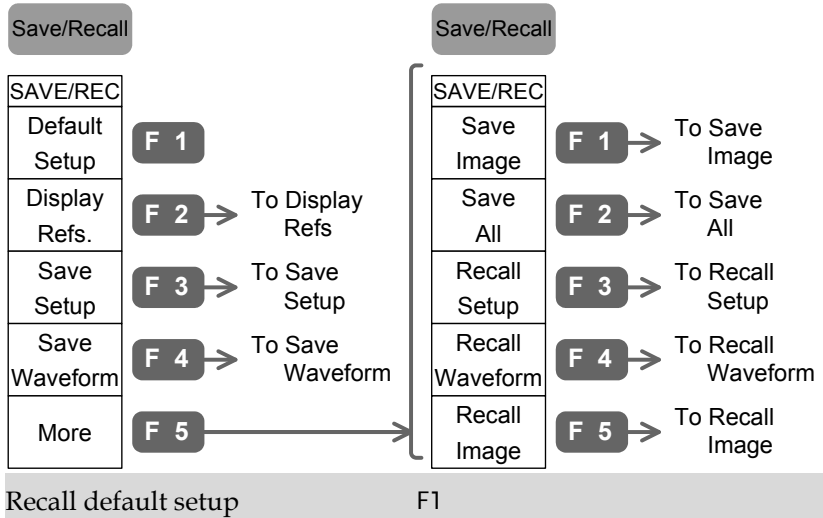

Save/Recall key (2/9)

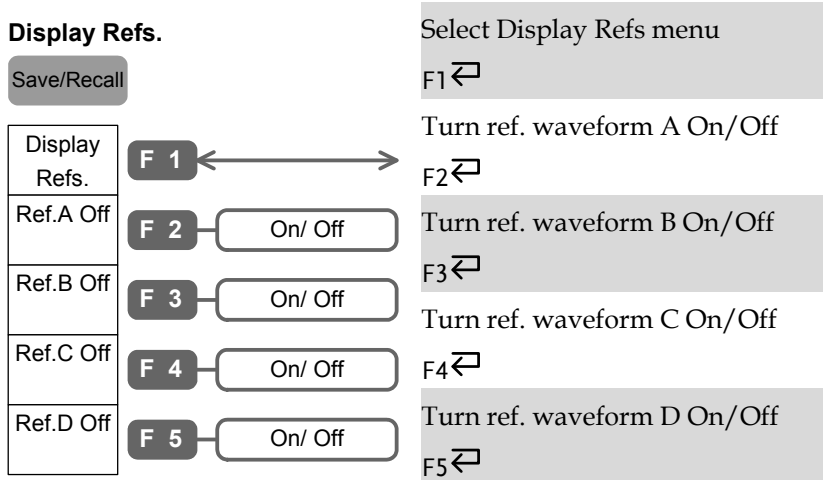

Save/Recall key (3/9)

Save Setup

Save/Recall

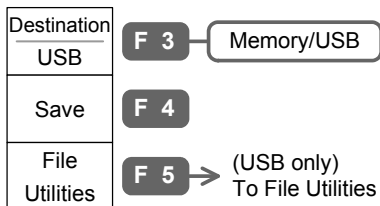
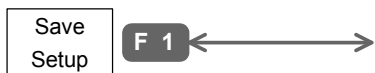

Select Save Setup menu

F1 ↵

Select destination

F3 ↵ → VAR ○

Save setup

F4

Go to USB flash drive contents edit mode

F5

Save/Recall key (4/9)

Save Waveform

Save/Recall

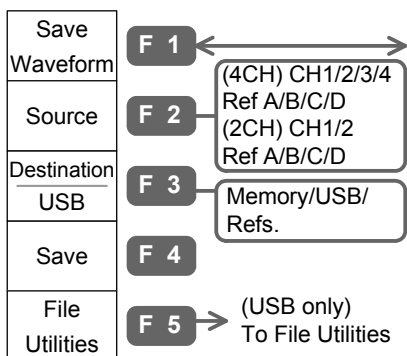

Select Save Waveform menu

F1 ↵

Select waveform source

F2 ↵

Select waveform destination

F3 ↵ → VAR ○

Save waveform

F4

Go to USB flash drive contents edit mode

F5

Save/Recall key (5/9)

Save All

Save/Recall

Save All	F 1	← →
Ink Saver Off	F 2	On/ Off
Destination USB	F 3	
Save	F 4	
File Utilities	F 5	(USB only) To File Utilities

Select Save All menu

F1 ↩

Turn ink saver On/Off

F2 ↩

Select destination

F3 ↩ → VAR

Save all

F4

Go to USB flash drive contents edit mode

F5

Save/Recall key (6/9)

Recall Setup

Save/Recall

Recall Setup	F 1	← →
Source USB	F 2	USB/Memory

Select Recall Setup menu

F1 ↩

Select setup source

F2 ↩ → VAR

Recall setup

F4

Go to USB flash drive contents edit mode

F5

Recall	F 4	
File Utilities	F 5	(USB only) To File Utilities

Save/Recall key (7/9)

Recall Waveform		Select Recall Waveform menu
Save/Recall		F1
Select waveform source		
Recall Waveform	F 1	F2 → VAR
Source USB	F 2 USB/Memory	Select waveform destination
Destination	F 3	F3 → VAR
Recall	F 4	Recall waveform
File Utilities	F 5 (USB only) To File Utilities	F4 Go to USB flash drive contents edit mode
		F5

Save/Recall key (8/9)

Recall Image		Select Recall Image menu
Save/Recall		F1
Select image source		
Recall Image	F 1	F2 → VAR
Source USB	F 2	Show or recall image
Ref Image On	F 3	F3
Recall	F 4	Recall image
File Utilities	F 5 To File Utilities	F4 Go to USB flash drive contents edit mode
		F5

Save/Recall key (9/9)

File Utilities

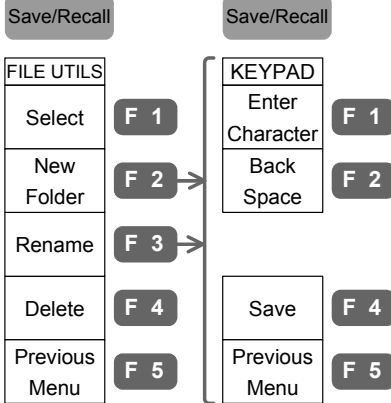

Select file/folder or enter into sub folder

VAR → F1

Create new folder or rename folder/file

F2, F3 (Enter new folder or rename menu)

VAR → F1 (Enter character)

F2 (Backspace)

F4 (Save new folder)

F5 (Go back to previous menu)

Delete folder/file

F4

Trigger key (1/5)

Video

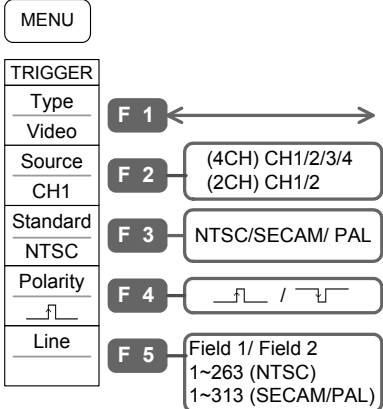

Select Video trigger type

F1

Select trigger source

F2

Select video standard

F3

Select video polarity

F4

Select video line

F5 → VAR

Trigger key (2/5)

Edge/Pulse		Select Edge/Pulse trigger type
MENU		F1 ↵
TRIGGER		Select trigger source
Type	F 1 ↔ F2 ↵	F2 ↵
Pulse		
Source	F 2 ↵	Select trigger mode
CH1	(4CH) CH1/2/3/4/Line (2CH) CH1/2/Ext/Line	F3 ↵
Mode	F 3 ↵	Select pulse trigger condition and pulse width
Auto	Auto/ Normal/ Single	F4 ↵ → VAR ⦿
When < 20.0ns	F 4 ↵	Go to slope/coupling menu
Slope / Coupling	F 5 →	F5
	>/ </ =/ ≠ 20ns~200us	
	To Slope/Coupling	

Trigger key (3/5)

(2CH Only)		Select Delay trigger type
MENU		F1 ↵
TRIGGER		Select time delay mode and delay length
Type	F 1 ↔ F2 → VAR ⦿	F2 → VAR ⦿
Delay		
By Time	F 2 ↵	Select event delay mode and event count
100ns	100ns~1.3ms	F3 → VAR ⦿
By Event	F 3 ↵	Select external trigger type and adjust trigger level (User type)
2	2 ~ 65000	F4 → VAR ⦿
Ext:	F 4 ↵	Go to slope/coupling menu
TTL	TTL: 1.48V/ ECL: -1.35V User: -12~+12V	F5
Slope/ Coupling	F 5 →	
	To Slope/Coupling	

Trigger key (4/5)

Slope/Coupling

MENU

TRIGGER

Slope



F 1 

Coupling

F 2 

Rejection
Off 

F 3 LF/ HF/ Off

Noise Rej
Off 

F 4 On/ Off

Previous
Menu

F 5

Select trigger slope type

F1 

Select trigger coupling mode

F2 

Select Frequency Rejection

F3 

Turn Noise Rejection On/Off

F4 

Go back to previous menu

F5

Trigger key (5/5)

Press the MENU key twice

MENU

TRIGGER

Holdoff
40.0ns

F 1 40ns~2.5s

Set to
Minimum

F 2

Set Holdoff time

F1 → VAR 

Set Holdoff time to minimum

F2

Turn Auto Level trigger On/Off

F5 



Auto Level
Off 

F 5 On/ Off

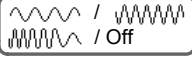
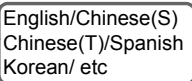
Utility key (1/9)

Utility		
UTILITY		
Hardcopy Menu	F 1 → To Hardcopy menu	Go to Hardcopy menu F1
Interface Menu	F 2 → To Interface menu	Go to Interface menu F2
Off 	F 3  / Off	Select buzzer sound F3 ↵
Language English	F 4 	Select language F4 ↵
More	F 5 ↔	Go to other menu F5 ↵

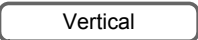
Utility key (2/9)

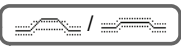
Utility		
UTILITY		
Self CAL Menu	F 1 	Start Vertical calibration F1→F1
System Info.	F 2	Show system information F2
Go-NoGo Menu	F 3 → To Go-NoGo menu	Go to Go-NoGo menu F3 ↵
NoGoWhen 	F 4 	Select NoGo condition F4 ↵
More	F 5 ↔	Go to other menu F5

Utility key (3/9)

Hardcopy

Utility

Hardcopy

H-COPY
Function Save All
Ink Saver Off 
Gray Portrait
Ratio 50%
Previous Menu

F 1 SaveImage/
SaveAll/ Printer

F 2 On/ Off

F 3 (Printer only)
Color Portrait/
Gray Portrait

F 4 (Printer only)
5 ~ 75

F 5

Select Hardcopy function

F1 ↩

Turn Ink Saver On/Off

F2 ↩

Select printout color (only in
printout mode)

F3 ↩

Select printout ratio (only in
printout mode)

F4 ↩

Run Hardcopy

Hardcopy

Utility key (4/9)

Interface

Utility

Type
RS232
Address
1
Baud Rate
9600
Stop Bit
2
Parity
None
Previous Menu

F 1 RS232/ USB/ GPIB

F 2 (GPIB only)
1 ~ 30

F 2 (RS232C only)
2400/ 4800/ 9600/
19200/ 38400

F 3 (RS232C only)
1/ 2

F 4 (RS232C only)
Odd/ Even/ None

F 5

Select interface

F1 ↩

Select GPIB address

F2 → VAR 

Select RS-232C baud rate

F2 ↩

Select RS-232C stop bit

F3 ↩

Select RS-232C parity

F4 ↩

Utility key (5/9)

Go-NoGo

Utility

Go-NoGo		
Template Edit	F 1	To Go-NoGo Template menu
Source CH1	F 2	(4CH) CH1/ 2/ 3/ 4 (2CH) CH1/ 2
Violating Stop	F 3	STOP / STOP+ \square Continue / Cont.+ \square
Go-NoGo Off	F 4	On/ Off
Ratio: 0	F 5	

Go to Go-NoGo template menu

F1

Select Go-NoGo source channel

F2 \leftarrow

Select violating condition

F3 \leftarrow

Start/Stop Go-NoGo test

F4 \leftarrow

Go-NoGo test result

F5

Utility key (6/9)

Go-NoGo Template

Utility

Template Max	F 1	Max/ Min/Auto
Source RefA	F 2	(Max/Min template) Max: Ref A/ W1~20 Min: Ref B/ W1~20
Source CH1	F 2	(Auto template) (4CH) CH1/ 2/ 3/ 4 (2CH) CH1/ 2
Position 3.00 Div	F 3	(Max/Min template) -12Div ~ +12Div
Tolerance 0.4%	F 3	(Auto template) 0.4% ~ 40%
Save & Create	F 4	0.04div ~ 4.0div
Previous Menu	F 5	

Select template

F1 \leftarrow

Select template source

F2 \leftarrow \rightarrow VAR \odot

Select template position or tolerance

F3 \leftarrow \rightarrow VAR \odot

Save and create template

F4







Go to previous menu

F5

Utility key (7/9)

Utility		Go to Probe Compensation menu
UTILITY		F1
ProbeComp Menu	F 1 → To Probe menu	Go to Time Set menu
Time Set Menu	F 2 → To Time set menu	F2
		Go to other menu
		F5 ↩
More	F 5 ← →	

Utility key (8/9)

Probe compensation		Select probe compensation signal
Utility		F1 ↩
ProbeComp		Set frequency for square wave
Wave Type	F 1 →  /  / 	F2 → VAR 
Frequency	F 2 → ( only) 1k ~ 100k	Set duty cycle for square wave
1 K		F3 → VAR 
Duty Cycle	F 3 → ( only) 5% ~ 95%	Default compensation signal frequency
50%		F4
Default	F 4	Go to previous menu
1k		F5
Previous Menu	F 5	

Utility key (9/9)

Time set

Utility

TIME SET	
Date	F 1
Time	F 1
Day 1	F 2
Hour 0	F 2
Save	F 4
Previous Menu	F 5

(Day/Month/Year)
Day: 1 ~ 31
Year: 2000 ~ 2037
Month: 1 ~ 12

(Hour/Minute)
Hour: 0 ~ 23
Minute: 0 ~ 59

Select date/time setting

F1 ↵

Select day/month/year

F2 ↵ → VAR ⌚

Select hour/minute

F2 ↵ → VAR ⌚

Save date/time setting

F4

Go to previous menu

F5



Default Settings

Here is the factory installed panel setting which appears when pressing the Save/Recall key→F1 (Default Setup).

Save/Recall

Default Setup

F 1

Acquisition	Mode: Normal	Memory length: 500
Channel	Scale: 2V/Div	CH1: On, CH2/3/4: Off
	Coupling: DC	Invert: Off
	BW limit: Off	Probe attenuation: x1
Cursor	Source: CH1	Horizontal: None
	Vertical: None	
Display	Accumulate: Off	Graticule: 
Go-NoGo	Go-No: Off	Source: CH1
	Violating: Stop	
Horizontal	Scale: 2.5us/Div	Mode: Main
Math	Type: + (Add)	Channel: CH1+CH2
	Position: 0.00 Div	Unit/Div: 2V
	Math Off	
Measure	Source1, 2: CH1, CH2	Type: VPP, Avg, Freq, Duty Cycle, Risetime
Program	Mode: Edit	Step: 1
Trigger	Type: Edge	Source: Channel1
	Mode: Auto	Slope: 
	Coupling: DC	Rejection: Off
	Noise Rejection: Off	
Utility	Square wave probe, 1k, 50% duty cycle	Hardcopy: save image, ink saver on
	Sound: Off	GPIB, Address 8

Built-in Help

The Help key shows help contents. When a functional key is pressed, simple explanations of its major functionalities appear on the display.

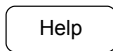

Applicable keys

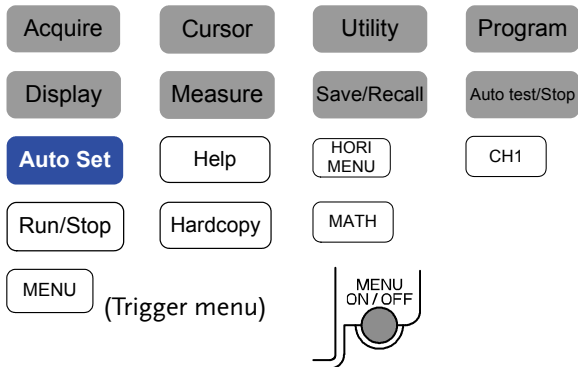

Panel operation

1. Press the Help key. The display changes to Help mode.



2. Press each key to access its help contents. (example: Acquire key)

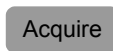

3. Use the Variable knob to scroll the Help contents up and down.

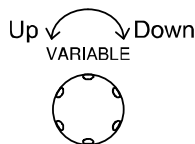

4. Press the Help key again to exit the Help mode.

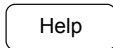

M EASUREMENT

Basic measurement	Channel activation	48
	Auto Set.....	49
	Run/Stop	50
	Horizontal position/scale	51
	Vertical position/scale	52
	Probe compensation signal	53
Automatic measurement	Measurement items	55
	Individual mode	57
	Display All mode.....	59
Cursor measurement	Use horizontal cursor	60
	Use vertical cursor	62
Math operation	Addition/Subtraction/Multiplication	65
	FFT	67
Go-NoGo test	Edit: Buzzer sound.....	70
	Edit: NoGo when.....	70
	Edit: Source signal	71
	Edit: Continue or stop after NoGo.....	71
	Edit: Template (boundary).....	72
	Run Go-NoGo test	76
Program	Edit program.....	79
	Run program.....	81

Basic Measurement

This section describes the basic operations required in capturing and viewing the input signal. For more detailed operations, see the following chapters.

- Measurements → from page47
- Configurations → from page83

Channel activation

Activate channel To activate an input channel, press the Channel key. The LED turns On and the input signal waveform appears on the display.

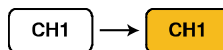

De-activate channel To disable the channel, press the Channel key again. If the display menu is different from the Channel menu, press twice (the first press shows the Channel menu).

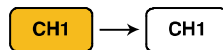

Default setup When the default setup is recalled (Save/Recall key → F1), Channel 1 automatically turns On. Channel 2, 3, and 4 becomes Off.

Auto Set The Auto Set (page49) does NOT automatically activate the channels to which input signals are connected.

Auto Set

Background Auto Set function automatically configures the panel settings to position the input signal to the best viewing condition. GDS-2000 automatically configures the following parameters.

- Horizontal scale
- Vertical scale
- Trigger source channel

Panel operation 1. Connect the input signal to GDS-2000 and press the Auto Set key.



2. The waveform appears in the center of the display.

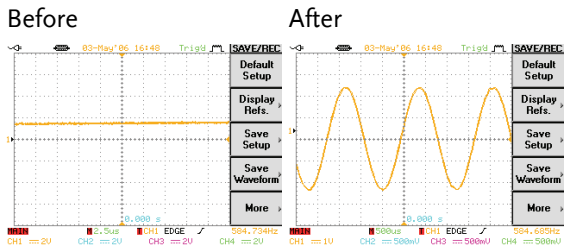

3. To undo Auto Set, press F5 (Undo). This feature is available for 5 seconds after Auto Set is activated.

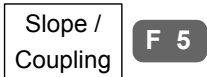

Limitation Auto Set does not work in the following situation.

- Input signal frequency is less than 20Hz
- Input signal amplitude is less than 30mV

Run/Stop

Background

By default, the waveform on the display is constantly updated (Run mode). Freezing the waveform by stopping signal acquisition (Stop mode) allows flexible observation and analysis. To enter the Stop mode, two methods are available: pressing the Run/Stop key or using the Single Trigger mode.

Stop mode icon When in Stop mode, the Stop icon appears at the top of the display.



Freeze waveform by Run/Stop key

1. Press the Run/Stop key once. The waveform and signal acquisition freezes. To unfreeze, press the Run/Stop key again.

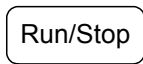

Freeze waveform by Single Trigger mode

2. In the Single Trigger mode, the waveform always stays in the Stop mode, and is updated only when the Run/Stop key is pressed. For details, see page106. Note: pressing the Run/Stop key only updates the waveform once – it does not switch to Run mode (continuous update).

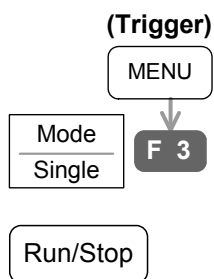

Waveform operation

The waveform can be moved or scaled in both Run and Stop mode, but in different manners. For details, see page95 (Horizontal position/scale) and page102 (Vertical position/scale).

Horizontal position/scale

For more detailed configuration, see page95.

Set horizontal position

The horizontal position knob moves the waveform left/right. As the waveform moves, the memory bar appears on the top of the display, indicating the portion of displayed waveform in the memory.

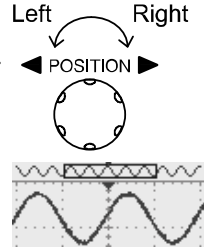

Stop mode In the Stop mode, the memory bar moves along with the waveform until it reaches the end of the memory.

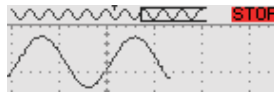

Select horizontal scale

To select the timebase (scale), turn the TIME/DIV knob; left (slow) or right (fast).

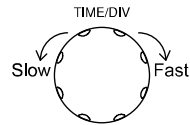

Range 1ns/Div ~ 10s/Div, 1-2-5 increment

The corresponding sampling rate appears on the upper side of the display. The timebase indicator appears on the lower side.

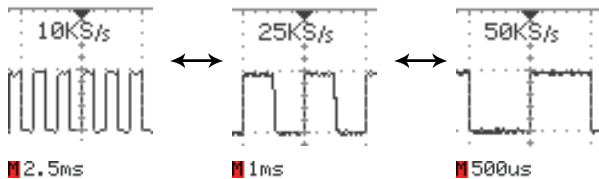

Stop mode In the Stop mode, the memory bar and waveform size changes according to the scale.

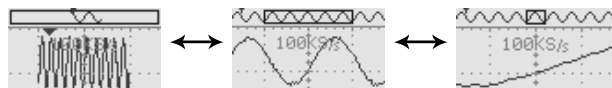

Vertical position/scale

For more detailed configuration, see page102.

Set vertical position

To move the waveform up or down, turn the vertical position knob for each channel.

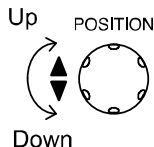

As the waveform moves, the vertical position of the cursor appears at the bottom left corner of the display.

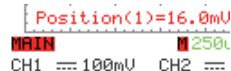

Run/Stop mode

The waveform can be moved vertically in both Run and Stop mode.

Select vertical scale

To change the vertical scale, turn the VOLTS/DIV knob; left (down) or right (up).

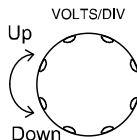

Range 2mV/Div ~ 5V/Div, 1-2-5 increment

The vertical scale indicator for each channel on the bottom left of the display changes accordingly.

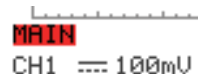

Stop mode

In Stop mode, the vertical scale setting can be changed but the shape of the waveform does not change until the next acquisition.

Probe compensation signal

Background

This section introduces how to use the probe compensation signal for general usage, in case the DUT signal is not available. For probe compensation details, see page159.

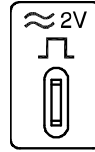

Note that the frequency accuracy and duty factor are not guaranteed. Therefore the signal should not be used for reference purpose.

Waveform type



Square waveform for probe compensation. 1k ~ 100kHz, 5% ~ 95%.



Demonstration signal to show the effect of peak detection. See page85 for peak detection mode details.



Demonstration signal to show the effect of long memory. See page87 for memory length details.

View compensation waveform

1. Connect the probe between the compensation signal output and Channel input.

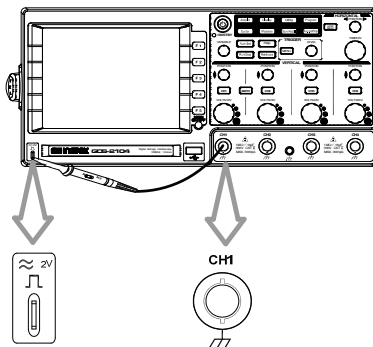

2. Press the Utility key.



3. Press F5 (More) twice.



4. Press F1 (Wave type) repeatedly to select the wave type.



5. (For square wave  only) To change the frequency, press F2 (Frequency) and use the Variable knob.

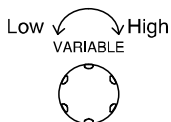
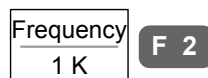

Range 1kHz ~ 100kHz

6. (For square wave  only) To change the duty cycle, press F3 (Duty Cycle) and use the Variable knob.

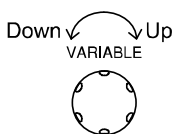
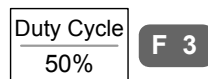

Range 5% ~ 95%

Probe compensation







For probe compensation details, see page159.







Automatic Measurement







Automatic measurement function measures and updates major items for Voltage, Time, and Delay type.



Measurement items







Overview	Voltage type	Time type	Delay type
	Vpp	Frequency	FRR
	Vmax	Period	FRF
	Vmin	RiseTime	FFR
	Vamp	FallTime	FFF
	Vhi	+Width	LRR
	Vlo	-Width	LRF
	Vavg	Dutycycle	LFR
	Vrms		LFF
	ROVShoot		
	FOVShoot		
	RPREShoot		
	FPREShoot		

Voltage measurement	Vpp		Difference between positive and negative peak voltage (=Vmax - Vmin)
	Vmax		Positive peak voltage
	Vmin		Negative peak voltage
	Vamp		Difference between global high and global low voltage (=Vhi - Vlo)
	Vhi		Global high voltage
	Vlo		Global low voltage

Vavg		Averaged voltage of the first cycle
Vrms		RMS (root mean square) voltage
ROVShoot		Rise overshoot voltage
FOVShoot		Fall overshoot voltage
RPREShoot		Rise preshoot voltage
FPREShoot		Fall preshoot voltage

Time measurement	Freq		Frequency of the waveform
	Period		Waveform cycle time (=1/Freq)
	Risetime		Rising time of the pulse (~90%)
	Falltime		Falling time of the pulse (~10%)
	+Width		Positive pulse width
	-Width		Negative pulse width
	Duty Cycle		Ratio of signal pulse compared with whole cycle =100x (Pulse Width/Cycle)

Delay measurement	FRR		Time between: Source 1 first rising edge and Source 2 first rising edge
	FRF		Time between: Source 1 first rising edge and Source 2 first falling edge

FFR		Time between: Source 1 first falling edge and Source 2 first rising edge
FFF		Time between: Source 1 first falling edge and Source 2 first falling edge
LRR		Time between: Source 1 first rising edge and Source 2 last rising edge
LRF		Time between: Source 1 first rising edge and Source 2 last falling edge
LFR		Time between: Source 1 first falling edge and Source 2 last rising edge
LFF		Time between: Source 1 first falling edge and Source 2 last falling edge

Individual mode

Individual mode shows five selected measurement items, two channels each, on the menu bar.

View
measurement
result

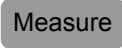
1. Press the Measure key. 
2. The measurement results for two selected channels appear on the menu bar, constantly updated. Press F1 ~ F5 to change the measurement item.

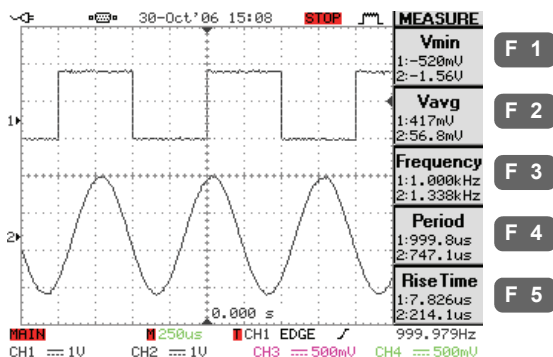

Select measurement item

- The selection menu appears. Press F1 (Source 1) repeatedly to select the first source channel.

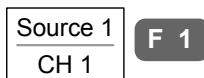

- Press F2 (Source 2) repeatedly to select the second source channel.

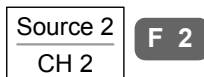

- Press F3 repeatedly to select the measurement type: Voltage, Time, and Delay.



- Use the Variable knob or press F4 repeatedly to select the measurement item.

VARIABLE

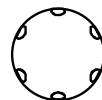

- Press F5 (Previous Menu) to confirm the item selection and to go back to the measurement results view.



Display All mode

Display All mode shows and updates all items from Voltage and Time type measurement.

View measurement result

1. Press the Measure key twice.

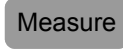
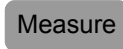

2. Press the channel for which the measurement results need to be observed.

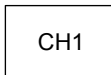

3. The results of Voltage and Time type measurement appear on the display.

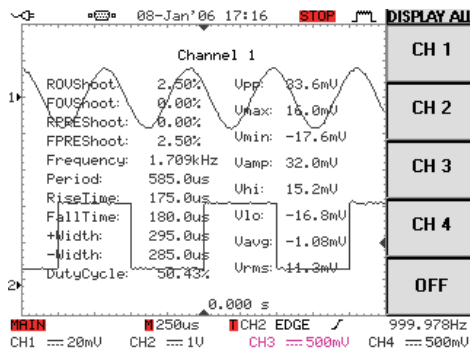

4. Press F5 (OFF) to clear the measurement results from the display.



Delay type

Delay type measurement is not available in this mode. Use the Individual measurement mode (page57) instead.

Cursor Measurement

Cursor line, horizontal or vertical, shows the position and value of the waveform and math operation result.

Use horizontal cursor

Panel operation/
Range

1. Press the Cursor key.

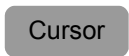

2. Press F1 (Source) repeatedly to select the source channel.

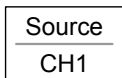

Range

4CH model CH1, 2, 3, 4, Math

2CH model CH1, 2, Math

3. Press F2 (Horizontal) repeatedly to activate the horizontal cursor.

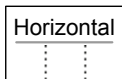

Range

⋮ ⋮ Horizontal cursor not activated

| ⋮ Left cursor movable, right cursor position fixed

⋮ | Right cursor movable, left cursor position fixed

| | Left and right cursor movable together

4. The cursor position information appears on F4 menu.

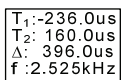

Parameter

- T₁ Time position of the left cursor
- T₂ Time position of the right cursor
- Δ The time distance between the left and right cursor
- f The time distance (Δ) converted to frequency

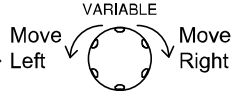
5. Use the Variable knob to move the cursor left or right. The F4 content changes accordingly.
- 

Example

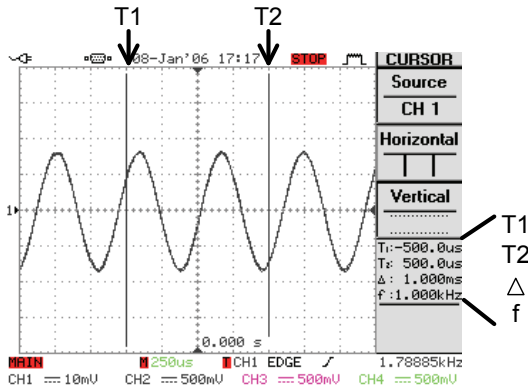

FFT Math

The FFT Math has different F4 content. For FFT math details, see page67.

f₁: 29.00kHz
 f₂: 78.50kHz
 Δ: 49.50kHz
 Div: 12.5kHz

F 4

- f₁ Frequency position of the left cursor
- f₂ Frequency position of the right cursor
- Δ The frequency distance between the left and right cursor
- Div The frequency distance per horizontal division

Use vertical cursor

Panel operation/
Range

1. Press the Cursor key.

Cursor

2. Press F1 (Source) repeatedly to select the source channel.

Source
CH1

F 1

Range

4CH model CH1, 2, 3, 4, Math

2CH model CH1, 2, Math

3. Press F2 (Vertical) repeatedly to activate the vertical cursor.

Vertical
.....
.....

F 3

Range

.....

Vertical cursor not activated

=====

Upper cursor movable, lower cursor position fixed

Lower cursor movable, upper cursor position fixed

=====

Upper and lower cursor movable together

4. The cursor position information appears on F5 menu.

V₁: 1.54V
V₂: -460mV
Δ : 2.00V

F 5

Parameter

V₁ Voltage level of the upper cursor

V₂ Voltage level of the lower cursor

Δ The voltage difference between the upper and lower cursor

- Use the Variable knob to move the cursor up or down. The F5 content changes accordingly.

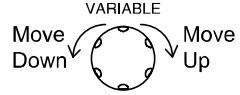

Example

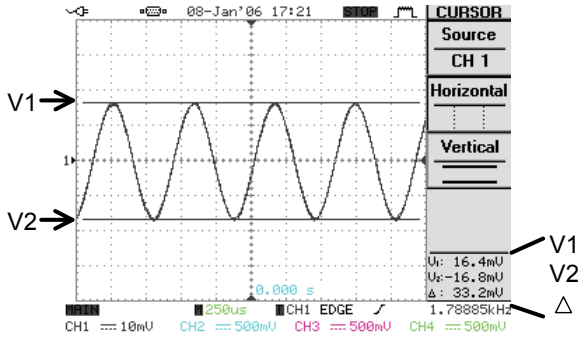

Note: FFT Math

The FFT Math has different F5 content. For FFT math details, see page67.

M ₁ : 83.6 dB
M ₂ : 3.66 dB
Δ : 80.0 dB

F 5

- M₁ Magnitude of the left cursor
- M₂ Magnitude of the right cursor
- Δ The frequency distance between the left and right cursor

Math Operation

Overview

Background Math operation runs addition, subtraction, multiplication, or FFT using the input signals and shows the result on the display. The resulted waveform characteristics can be measured using the cursors.

Addition (+) Adds amplitude of two signals.
 Channel pairs 4CH model: Channel 1 + 2, 3 + 4
 2CH model: Channel1 + 2

Subtraction (-) Extracts the amplitude difference between two signals.
 Channel pairs 4CH model: Channel 1 - 2, 3 - 4
 2CH model: Channel1 - 2

FFT Runs FFT calculation on a signal. Four types of FFT windows are available: Hanning, Flattop, Rectangular, and Blackman.
 Channel 4CH model: Channel 1, 2, 3, 4
 2CH model: Channel 1, 2

Hanning FFT window Frequency resolution Good
 Amplitude resolution Not good
 Suitable for.... Frequency measurement on periodic waveform

Flattop FFT window	Frequency resolution	Not good
	Amplitude resolution	Good
	Suitable for...	Amplitude measurement on periodic waveform

Rectangular FFT window	Frequency resolution	Very good
	Amplitude resolution	Bad
	Suitable for...	Single-shot phenomenon (this mode is the same as having no window at all)

Blackman FFT window	Frequency resolution	Bad
	Amplitude resolution	Very good
	Suitable for...	Amplitude measurement on periodic waveform

Addition/Subtraction/Multiplication

Panel operation

1. Activate the channel pairs.
4CH model: CH1&2, 3&4
2CH model: CH1&2

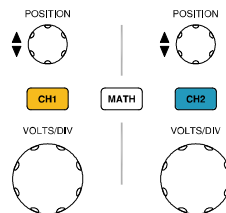

2. Press the Math key.



3. Press F1 (Operation) repeatedly to select addition (+), subtraction (-), or multiplication (x).



4. (For 4CH model only) press CH1+CH2 F 2 to select the channel pairs, 1&2 or 3&4.

5. The math measurement result appears on the display. The vertical scale (fixed) of math waveform appears in F5 (Unit/div).

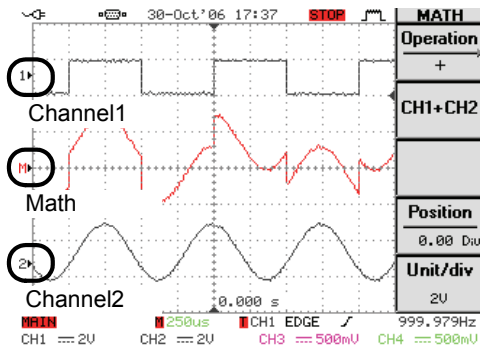

6. To move the math waveform vertically, press Position F 4 (Position) and use the Variable knob.

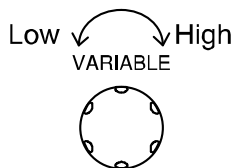

7. To clear the math result from the display, press the MATH key again.

FFT

Panel operation

1. Press the Math key.

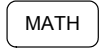

2. Press F1 (Operation) repeatedly to select FFT.



3. Press F2 repeatedly to select the source channel.

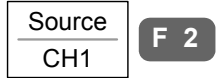

4. Press F3 repeatedly to select the FFT window type.



5. The FFT result appears. For FFT, the horizontal scale changes from time to frequency, and the vertical scale from voltage to dB.

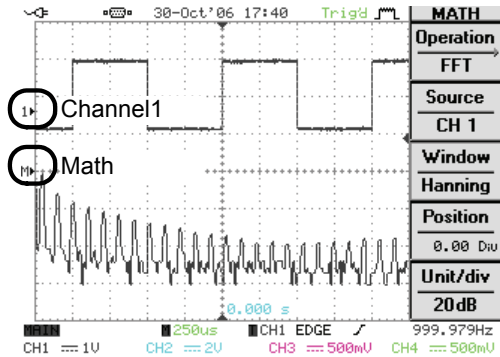

6. To move the FFT waveform vertically, press F4 (Position) and use the Variable knob.

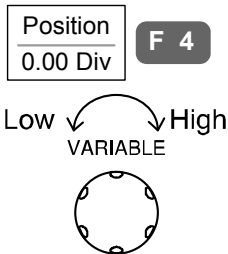

Range -12.00 Div ~ +12.00 Div

7. To select the vertical scale of FFT waveform, press F5 (Unit/Div) repeatedly. RMS Voltage can also be selected instead of dB.



Range 1, 2, 5, 10, 20 dB/Div

RMS Voltage

8. To clear the FFT result from the display, press the Math key again.



Go-NoGo Test

Overview

Background Go-NoGo test checks if a waveform fits inside the user-specified maximum and minimum amplitude boundary (template). The test result comes out in three ways: menu contents, buzzer sound, and pulse signal output from the rear panel terminal.

Test parameters	item	default setting	setup details
	Buzzer sound when the test fails (NoGo)	Off	page70
	NoGo criteria: in or out of the boundary	Out	page70
	Test signal	Channel 1	page71
	Test continue or stop when NoGo occurs	Stop	page71
	Boundary (template) – select minimum and maximum as separate waveforms or create both boundaries from a single waveform	Min/Max separately	page72

Default setting To recall the default setting, press the Save/Recall key, then press F1 (Default Setup). See page45 for details.

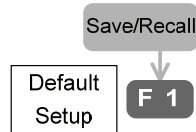

Edit: Buzzer sound

Panel operation

1. Press the Utility key.



2. Press F3 repeatedly to select the buzzer for test fail (NoGo) notification.

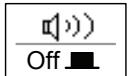

 High pitch

 Middle pitch

 Low pitch

Off  Sound Off

Note

The buzzer setting also affects the vertical resolution calibration (page158) – the buzzer notifies the completion of calibration.

Edit: NoGo when

1. Press the Utility key.



2. Press F5 (More).

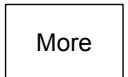





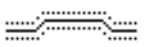

3. Press F4 (NoGo When) repeatedly to select the NoGo condition.



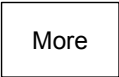

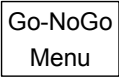

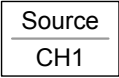

 NoGo when waveform is outside of the boundary

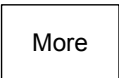

 NoGo when waveform is inside the boundary

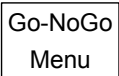
Edit: Source signal

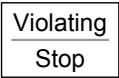
1. Press the Utility key. 
2. Press F5 (More).  
3. Press F3 (Go-NoGo Menu).  
4. Press F2 (Source) repeatedly to select the channel to be tested. (Note: the selected channel is automatically activated)  

Edit: Continue or stop after NoGo

1. Press the Utility key. 
2. Press F5 (More).  
3. Press F3 (Go-NoGo Menu).  
4. Press F3 (Violating) repeatedly to select whether to continue or stop test after the NoGo condition is met.  

Stop	The test stops when the NoGo condition is met. The buzzer does not sound.
Stop+ 	The test stops and the buzzer sounds when the NoGo condition is met.
Continue	The test continues even when the NoGo condition is met. The buzzer does not sound.
Continue+ 	The test continues even when the NoGo condition is met. The buzzer also sounds.

Note If the sound is turned Off in the buzzer setting (page70), the sound is not produced even when selecting Stop/Continue+ .

Edit: Template (boundary)

Background The NoGo template sets the upper and lower amplitude boundary. Two methods are available: Min/Max and Auto.

Min/Max Selects the upper boundary (Max) and lower boundary (Min) as separate waveforms, from the internal memory.

Advantage: The template shape and the distance (allowance) between the source signal are fully customizable.

Disadvantage: The waveforms (templates) have to be stored internally prior to this selection.

Auto Creates the upper and lower boundary together from an input signal, not from internally stored waveform.

Advantage: No need to store the waveforms prior to this selection.



Disadvantage: The template shape is proportional to the source signal. The distance (allowance) between the source signal and upper/lower template are always symmetrical.



Min/Max setting 1. Make sure the source signal, on which the templates are based, appears on the display.

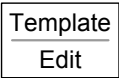

2. Press the Utility key. 

3. Press F5 (More).  

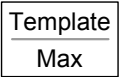
4. Press F3 (Go-NoGo Menu).  

5. Press F1 (Template Edit).  

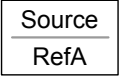
6. Press F1 (Template) repeatedly to select the upper (Max) or lower (Min) boundary template.  

7. Press F2 (Source). Use the Variable knob to select the template from internally stored waveform. For waveform store procedure, see page130.  



- Max (marked as waveform "A" in the display) Maximum boundary: RefA, W1 ~ 20 internal memory
- Min (marked as waveform "B" in the display) Minimum boundary: RefB, W1 ~ 20 internal memory

8. Press F3 (Position). Use the Variable knob to move the waveform amplitude level.

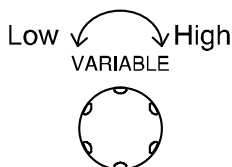

9. Repeat step 9, 10, 11 for the other template setting, Min or Max.



10. When the templates are set, press F4 (Save & Create) to save them.

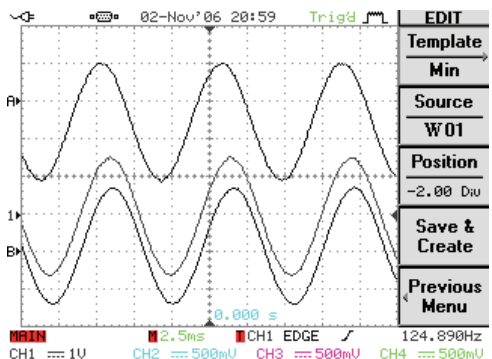

Auto setting

1. Make sure the source signal, on which the templates are based, appears on the display.

2. Press the Utility key.



3. Press F5 (More).



4. Press F3 (Go-NoGo Menu).



5. Press F1 (Template Edit).



6. Press F1 repeatedly to Auto position.



7. Press F2 repeatedly to select the signal channel on which the template is created.

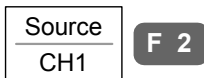

8. The template appears on the screen as waveform A (maximum) and waveform B (minimum). Use the Variable knob to set the tolerance range. The template in the display changes accordingly.

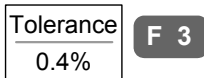
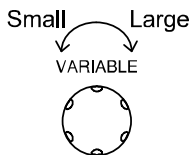

9. If necessary, press F3 (tolerance) repeatedly to select the tolerance unit: percentage (%) or division (div).



10. When the templates are set, press F4 (Save & Create) to save it.

Save & Create	F 4
------------------	------------

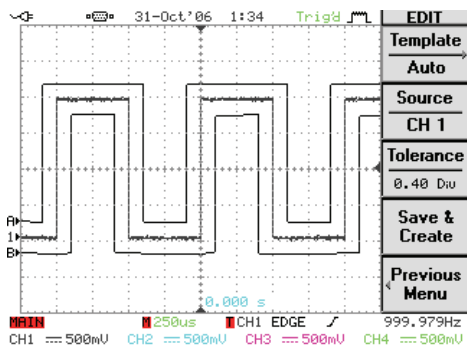

Run Go-NoGo test

This section assumes all Go-NoGo settings (page69) are completed.

Panel operation 1. Press the Utility key.

Utility

2. Press F5 (More).

More	F 5
------	------------

3. Press F3 (Go-NoGo Menu).

Go-NoGo Menu	F 3
-----------------	------------

4. Make sure the source signal and the templates (boundary) both appear on the display.

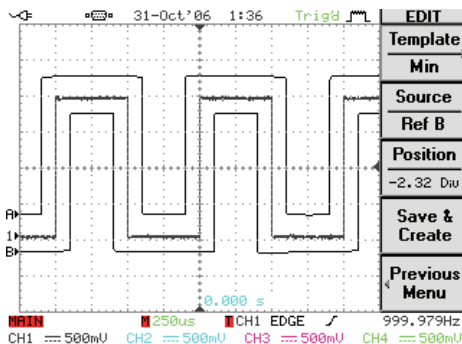

- Press F4 (Go-NoGo). The Go-NoGo test starts running and stops according to the continue/stop condition (page71). To stop the test manually, Press F4 again.



- The test results appear in F5 menu. The denominator (lower side) shows the number of completed test. The numerator (upper side) shows the number of failed test (NoGo).

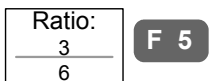

- The Go/NoGo terminal (open collector) on the rear panel sends out a 5Vpp, 10us pulse signal to external device every time the NoGo condition is met.

GO / NO GO
(Open collector)

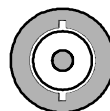

Program

Overview

Background Program function measures input signals using cursors or automatic measurement functions, in user-defined sequence, duration, loop count, and panel settings. This feature is useful for automated and repetitive measurement, such as in assembly line or quality inspection test.

Parameter	Program set	1 set
	Program step	Maximum 20 steps
	Measurement item	Cursor or Automatic measurement
	Time (duration) per step	1 ~ 99 seconds, or user activation
	Program loop	1 ~ 99 loops, the first and last step settable

- Programming step**
1. Show the target waveform on the display and decide the type of measurement that needs to be done: Horizontal/Vertical Cursor or Automatic measurement.
 2. Setup the other panel configurations: trigger, acquisition, horizontal/vertical scale, etc. Save the settings to the internal memory. See page129 for details.
 3. Edit the program (page79) using the internally stored panel setup.
 4. Run the program (page81).

Edit program

This section assumes that the panel setting is already defined and saved (step 1 and 2 in the previous page).

- Panel operation
1. Press the Program key. The display changes into program edit mode.

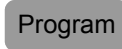

2. Press F1 (Edit/Play) to select the Edit side.

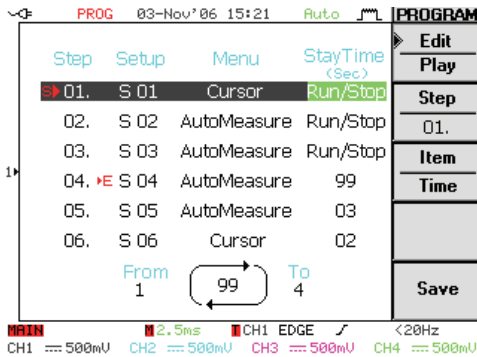

3. Press F2 (Step). Use the Variable knob to select the step that needs to be edited. The cursor on the display moves accordingly.

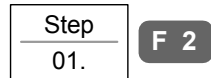

4. Press F3 (Item) repeatedly to select the three parameters for a step: panel setup, menu (Cursor or Automatic measurement), and time.

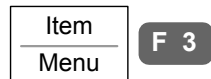

Setup	Selects the panel setup stored in the internal memory. S01 ~ S20. For panel setup store/recall details, see page129 (save) or page139 (recall).
Menu	Selects the measured item: Cursor or Automatic measurement.
Time	Sets the duration of the step, 1 ~ 99 seconds or user control (Run/Stop). When Run/Stop is selected, the program freezes at that step until the user presses the Run/Stop key.

- Continue the above for all program steps. When completed, press F5 (Save) to confirm and save the program.

A rectangular button with a thin black border and the word "Save" centered inside.A dark grey rounded rectangular button with a white border and the text "F 5" centered inside.

Run program

This section assumes that the program editing (see previous page) is completed.

- Panel operation
1. Press the Program key. The display changes into program mode.

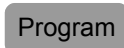

2. Press F1 (Edit/Play) repeatedly to select the Play side.

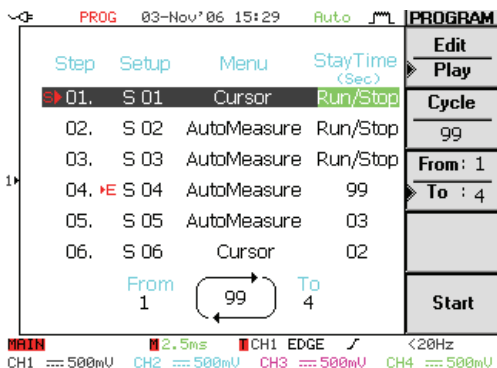

3. Press F2 (Cycle). Use the Variable knob to select the number of program loop: 1 ~ 99.

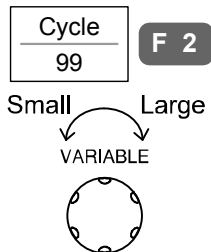

4. Press F3 (From/To) to select the From: side. Use the Variable knob to select the program start step: 1 ~ 20. The "S" mark appears in the selected step.

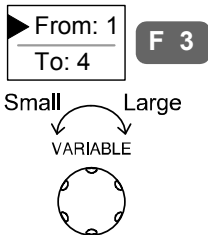

01. S 01 Cursor Run/Stop

5. Press F3 (From/To) to select the To: side. Use the Variable knob to select the program end step: 1 ~ 20. Note that the To: step must be larger or equal to the From: step. The "E" mark appears in the selected step.

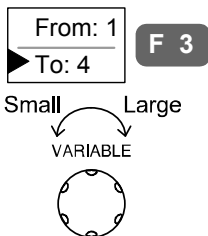

04. E S 04 AutoMeasure 99

6. Press F5 (Start). The display changes into program running mode and starts executing the first step.
7. The message "Press Run/Stop key to continue" on the bottom of the display shows the user has to activate the next step manually. Press the Run/Stop key to move to the next step.

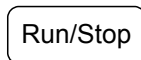

8. To stop the program manually, press the Auto test/Stop key. When all steps are completed, the program stops running.

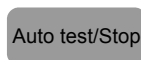

C ONFIGURATION

Acquisition	Select acquisition mode	85
	Select waveform memory length.....	87
	Real time vs Equivalent time sampling mode ..	90
Display	Select waveform drawing (vector/dot).....	91
	Accumulate waveform	92
	Set display contrast.....	93
	Freeze the waveform	93
	Select display grid.....	94
	Turn Off menu	94
Horizontal	Move waveform position horizontally.....	95
	Select horizontal scale	96
	Select waveform update mode.....	97
	Zoom waveform horizontally.....	99
	Show waveform in X-Y mode	100
Vertical (Channel)	Move waveform position vertically	102
	Select vertical scale.....	102
	Select coupling mode.....	103
	Invert waveform vertically	104
	Limit bandwidth.....	104
	Select probe attenuation level	105

Trigger	Trigger type overview	106
	Trigger parameter overview	107
	Use edge trigger	110
	Use advanced delay trigger (2CH model)	111
	Use video trigger	113
	Use pulse width trigger.....	114
<hr/>		
System	View system information	116
	Select menu language.....	116
	Set date and time	117

Acquisition

Acquisition process samples the analog input signals and converts them into digital format for internal processing.

Select acquisition mode

Panel operation 1. Press the Acquire key.

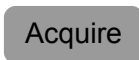



2. Select the acquisition mode from F1 (Normal) ~ F3 (Average). The acquisition icon on the top right corner of the display changes accordingly.

Normal	F 1
Peak Detect	F 2
Average 2	F 3

Range

Normal  All of the acquired data is used to draw the waveform.

Peak Detect  Only the minimum and maximum value pairs for each acquisition interval (bucket) are used. This mode is useful for catching abnormal glitches in the signal.

Average  Multiple acquired data are averaged. This mode is useful for drawing a noise-free waveform. To select the average number, press F3 repeatedly.
Average number: 2, 4, 8, 16, 32, 64, 128, 256

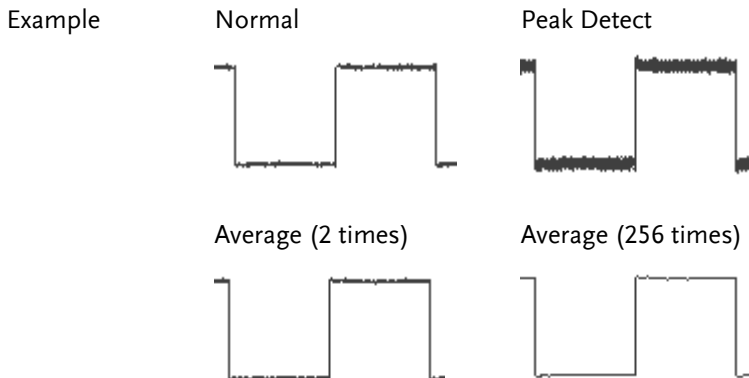

Peak detect effect using probe comp. waveform

1. One of the probe compensation waveforms can demonstrate peak detection mode. Connect the probe to the probe compensation output.

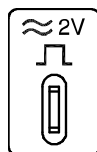

2. Press the Utility key.



3. Press F5 (More) twice.



4. Press F1 (Wave Type) and select the  waveform.



5. Press the Auto Set key. GDS-2000 positions the waveform in the center of the display.



6. Press the Acquire key.

Acquire

7. Press F2 (Peak Detect) or F1 (Normal) and see that in the Peak detection mode, spike noise is captured.

Normal

F 1

Peak
Detect

F 2

Peak Detect

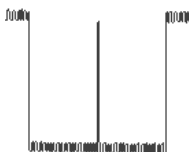

Normal

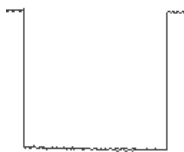

Select waveform memory length

Background

Memory length defines the amount of waveform data (points) included in each trigger event. Two modes are available: short and long.

Short mode

Each waveform includes fewer points and is updated rapidly. It is useful for observing the shape of fast-changing waveform such as Frequency Modulation.

Long mode

Each waveform includes more points and is updated relatively slowly. It is useful for observing the details of single-shot phenomenon such as spike noise.

Panel operation

1. Press the Acquire key.

Acquire

2. Press F5 (Mem Leng) to select the memory length (points), short or long.

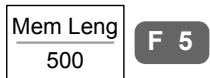

Range (memory point)	500	Short memory length; useful for catching high frequency signal.
	5000	Long memory length when three or four channels are active.
	12500	Long memory length when two channels are active.
	25000	Long memory length when only one channel is active.

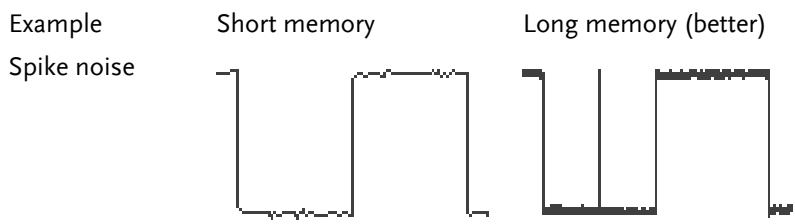
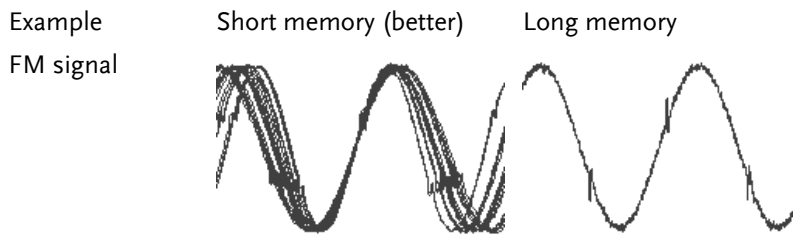

Note The display always shows 250 points (300 when the menu is turned Off) regardless of the memory length. In short memory length, all 500 points can be observed. In long memory length, either the memory points are condensed into 500 points (Real-time sampling mode) or all points can be observed (Equivalent-time sampling mode). For sampling mode details, see page90.

Long memory effect using probe comp. waveform

1. One of the probe compensation waveform can demonstrate long memory mode. Connect the probe to the output.

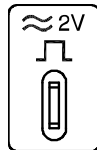

2. Press the Utility key.



3. Press F5 (More) twice.



4. Press F1 (Wave Type) and select the  waveform.



5. Press the Auto Set key. GDS-2000 positions the waveform in the center of the display. Set the horizontal scale to 2.5ms to observe the whole waveform shape.

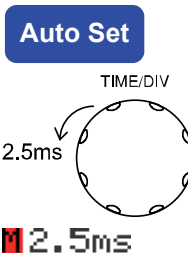

6. Press the Acquire key.

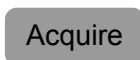

7. Press F5 (Mem Leng) repeatedly to switch between short and long memory length.

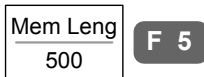

Short memory

Long memory



Real time vs Equivalent time sampling mode

Background GDS-2000 automatically switches between two sampling modes, Real-time and Equivalent-time, according to the number of active channel and sampling rate.

Parameter	Real-time sampling	One sampled data is used to reconstruct a single waveform. Short-time events might get lost if the sampling rate gets too high. This mode is used when the sampling rate is relatively low.
	Equivalent-time sampling	Multiple numbers of sampled data are accumulated to reconstruct a single waveform. Restores greater waveform details but takes longer to update the waveform. This mode is used when the sampling rate becomes higher.

Real-time / Equivalent-time sampling threshold

Input channel: ○ Activated
 ✕ Not activated
 — Does not matter

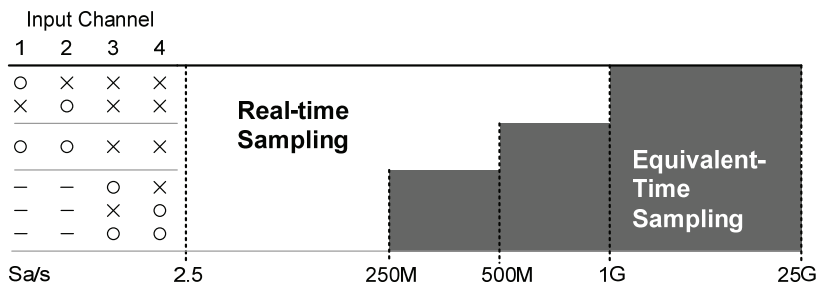

Display

Display menu defines how the waveforms and parameters appear on the main LCD display.

Select waveform drawing (vector/dot)

- Panel operation
1. Press the Display key. Display
 2. Press F1 (Type) repeatedly to select the waveform drawing. Type Dots F 1

Range	Dots	Only the sampled dots are displayed.
	Vectors	Both the sampled dots and the connecting line are displayed.

Example: Dots
(square wave)

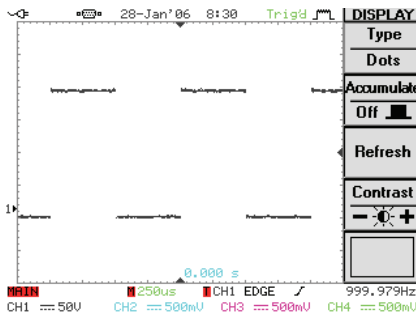

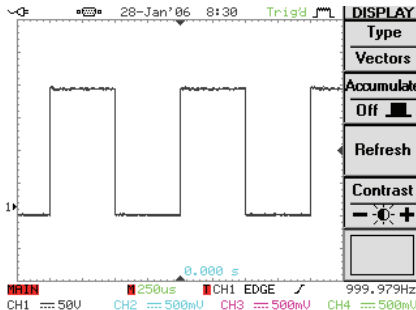

Example: Vectors
(square wave)



Accumulate waveform

Background Accumulation preserves the old waveform drawings and overwrites new waveforms on top of it. It is useful for observing waveform variation.

- Panel operation**
1. Press the Display key. 
 2. Press F2 (Accumulate) to turn On waveform accumulation. 
 3. To clear the accumulation and start over (refresh), press F3 (Refresh). 

Example

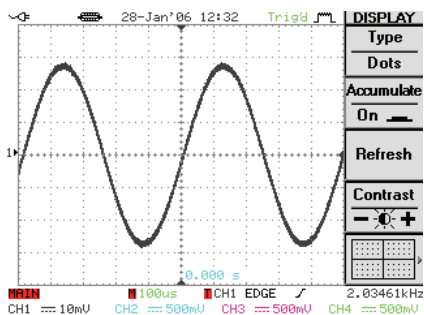

Accumulation On



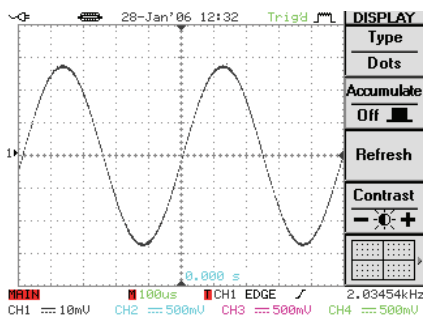

Accumulation Off

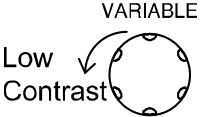

Set display contrast

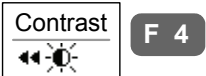
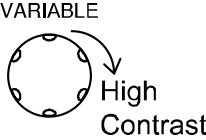

- Panel operation
1. Press the Display key.
 
 2. Press F4 (Contrast).
 
 - 3a. Turn the Variable knob left to lower the contrast (dark display).
 

 - 3b. Turn the Variable knob right to raise the contrast (bright display).
 



Freeze the waveform (Run/Stop)

For more details about Run/Stop mode, see page50.

- Panel operation
1. Press the Run/Stop key. To unfreeze the waveform, press the Run/Stop key again.
 
 2. The waveform and the trigger freezes. The trigger indicator on the top right of the display shows Stop.
 

Select display grid

Panel operation 1. Press the Display key.

Display

2. Press F5 (Grid type) repeatedly to select the grid.

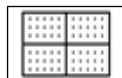

F 5

Range



Shows the full grid; X and Y axis for each division.



Shows only the center X and Y frame.



Shows only the outer frame.

Turn Off menu

Panel operation 1. Press the MENU ON/OFF key below F1 ~ F5.

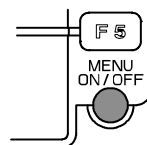

2. The menu disappears. The waveform points changes from 250 to 300.

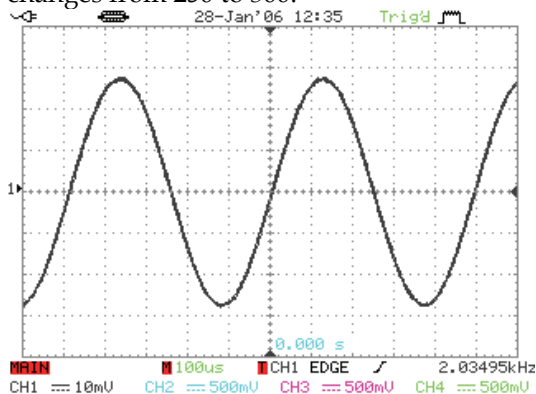

Horizontal View

This section describes how to set the horizontal scale, position, and waveform display mode.

Move waveform position horizontally

Panel operation

The horizontal position knob moves the waveform left/right. As the waveform moves, the memory bar appears on the top of the display indicating the portion of displayed waveform in the memory.

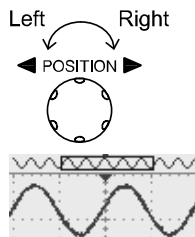

Run mode

In Run mode, the memory bar keeps its relative position in the memory since the entire memory is continuously captured and updated.

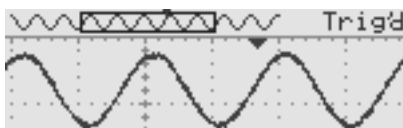

Stop mode

In Stop mode, the memory bar moves along with the waveform until it reaches the end of the memory.

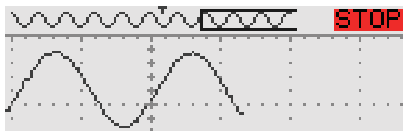

Select horizontal scale

Select horizontal scale To select the timebase (scale), turn the TIME/DIV knob; left (slow) or right (fast).

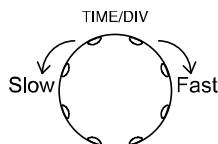

Range 1ns/Div ~ 10s/Div, 1-2-5 increment

The corresponding sampling rate appears on the upper side of the display. The timebase indicator appears on the lower side.

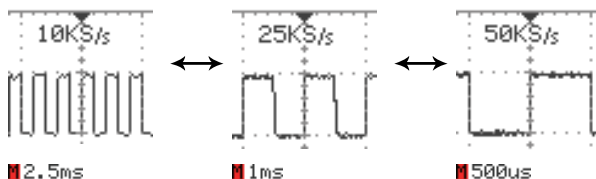

Run mode

In Run mode, the memory bar and waveform size keep their proportion. When the timebase becomes slower, it automatically switches to Scan mode (see the next page).

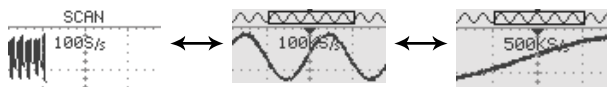

Stop mode

In Stop mode, the memory bar and waveform size changes according to the scale.

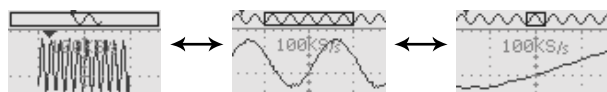

Select waveform update mode

Background The display update mode is switched automatically or manually according to timebase and trigger. The indicator on the bottom left of the display shows the current mode.

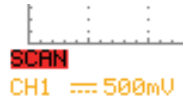

Main mode **MAIN** Updates the whole displayed waveform at once. Automatically selected when the timebase (sampling rate) is fast.
 Timebase $\leq 50\text{ms}/\text{div}$ ($\geq 500\text{Sa}/\text{s}$)
 Trigger all modes

Scan mode **SCAN** Updates the waveform gradually from the left side of the display to the right. The waveform position is fixed. Automatically selected when the timebase (sampling rate) is slow.
 Timebase $\geq 100\text{ms}/\text{div}$ ($\leq 250\text{Sa}/\text{s}$)
 Trigger Auto mode only

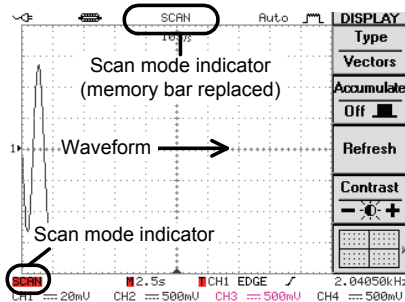

- Note**
- When the update mode switches from Main to Scan, GDS-2000 automatically selects the Auto trigger mode. See page106 for trigger details.
 - To view the signal peak clearly in Scan mode, turn on the Peak detection (page85).

Roll mode

ROLL Updates and moves the waveform gradually from the right side of the display to the left. Manually selected when the timebase (sampling rate) is slow.

Timebase $\geq 250\text{ms/div}$ ($\leq 100\text{Sa/s}$)

Trigger all modes

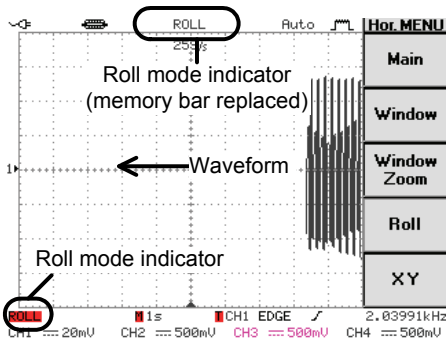

Select Roll mode manually

1. Press the Horizontal menu key.



2. Press F4 (Roll). The waveform starts scrolling from the right side of the display. The update mode indicator shows Roll mode.

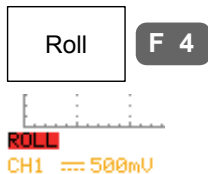

Note

The Roll mode locks the timebase to be at least 250ms/div (100Sa/s). If faster timebase or sampling rate is required, get out of the Roll mode by pressing F1 (Main).



Zoom waveform horizontally

Panel operation/
range

1. Press the Horizontal Menu key.



2. Press F2 (Window) key.



3. The WINDOW indicator, which shows the zoom range, appears on the bottom left corner of the display. Use the horizontal position knob to move the zoom range sideways, and TIME/DIV knob to change the zoom range width.

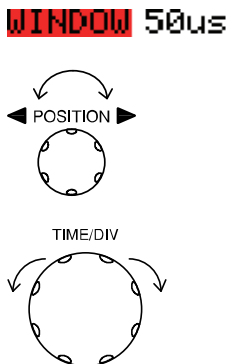

The width of the bar in the middle of the display is the actual zoomed area.

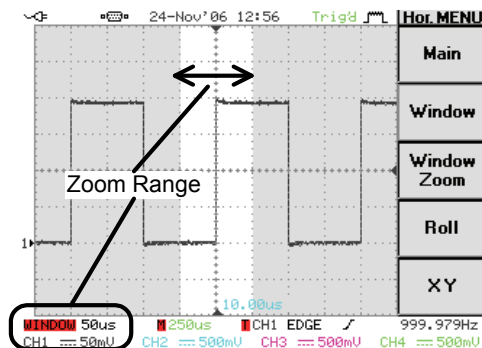

Zoom range 1ns ~ 1ms

- Press F3 (Window Zoom).
The specified range gets zoomed. The ZOOM indicator appears on the bottom left side of the display.

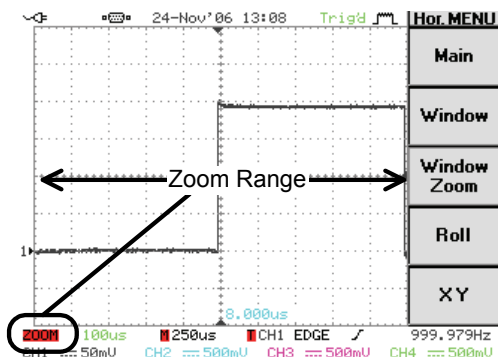
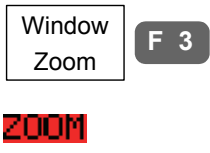

- To go back to the original view, press F1 (Main).



Show waveform in X-Y mode

Background

The X-Y mode compares the voltage of Channel 1 and Channel 2 waveforms in a single display. This mode is useful for observing the phase relationship between the two.

Panel operation

- Connect the signals to Channel 1 (X-axis) and Channel 2 (Y-axis).
- Make sure both Channel 1 and 2 are activated (LED On). Press the Channel key if necessary.

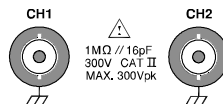

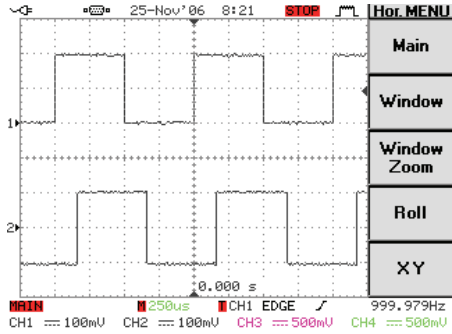

3. Press the Horizontal menu key.



4. Press F5 (XY). The display shows two waveforms in X-Y format; Channel 1 as X-axis, Channel 2 as Y-axis.

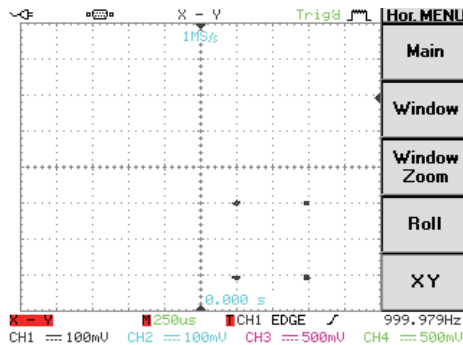
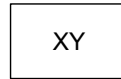

5. Horizontal Position knob and Time/Div knob are disabled under the X-Y mode. To move the waveform position, use the vertical position knob: Channel 1 knob moves the waveform horizontally, Channel 2 knob vertically.

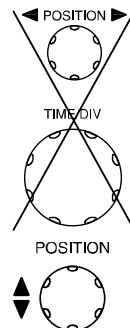

Vertical View (Channel)

This section describes how to set the vertical scale, position, and coupling mode.

Move waveform position vertically

Panel operation To move the waveform up or down, turn the vertical position knob for each channel.

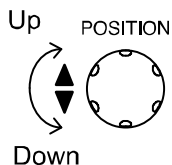

As the waveform moves, the vertical position of the cursor appears at the bottom left corner of the display.

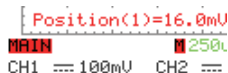

Run/Stop mode The waveform can be moved vertically in both Run and Stop mode.

Select vertical scale

Panel operation To change the vertical scale, turn the VOLTS/DIV knob; left (down) or right (up).

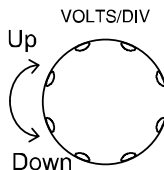

The vertical scale indicator on the bottom left of the display changes accordingly.

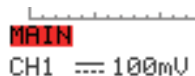

Range 2mV/Div ~ 5V/Div, 1-2-5 increments

Stop mode In Stop mode, the vertical scale setting can be changed but the waveform shape stays the same.

Invert waveform vertically

Panel operation 1. Press the Channel key.



2. Press F2 (Invert) to invert the waveform.



Example

CH2 (below) Invert Off

CH2 (below) Invert On

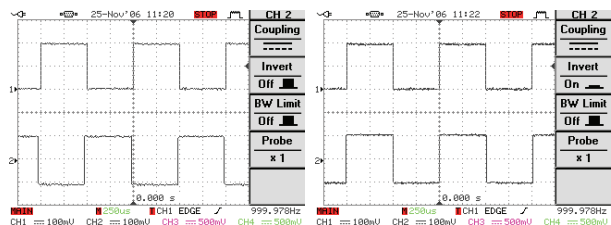

Limit bandwidth

Background

Bandwidth limitation puts the input signal into a 20MHz (-3dB) low-pass filter. This function is useful for cutting off high frequency noise to see the clear waveform shape.

Panel operation 1. Press the Channel key.



2. Press F3 (BW Limit) to turn Off the limitation.



3. The BW icon  appears in the channel indicator at the bottom of the display.

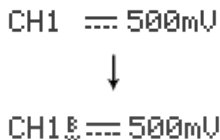

Example

BW Limit Off

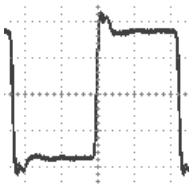

BW Limit On

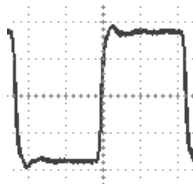

Select probe attenuation level

Background

A signal probe has an attenuation switch to lower the original DUT signal level to the oscilloscope input range, if necessary. The probe attenuation selection adjusts the vertical scale so that the voltage level on the display reflects the real value on DUT.

Panel operation

1. Press the Channel key.



2. Press F4 (Probe) repeatedly to select the attenuation level.

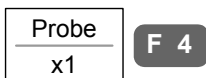

3. The voltage scale in the channel indicator changes accordingly. There is no change in the waveform shape.

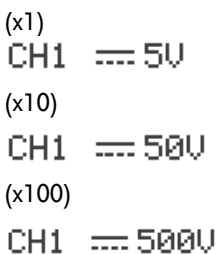

Range

x1, x10, x100

Note

The attenuation factor adds no influence on the real signal. It just changes the voltage scale on the display.

Trigger

Trigger configures the condition GDS-2000 captures the incoming signal.

Trigger type overview

Edge (+Delay) Triggers when the signal crosses an amplitude threshold in either positive or negative slope.
 (for 2CH models only) The advanced Delay trigger works in tandem with the edge trigger, by waiting for a specified time or number of event before the edge trigger starts. This method allows pinpointing a location in a long series of trigger events.

Note: when using the delay trigger, trigger source is limited to Channel 1 or 2.

Delay trigger example (by event)

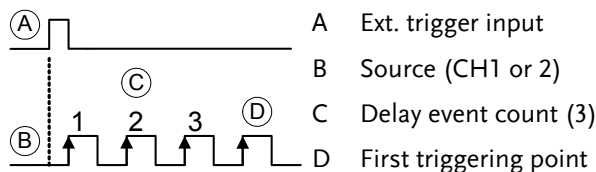

Delay trigger example (by time)

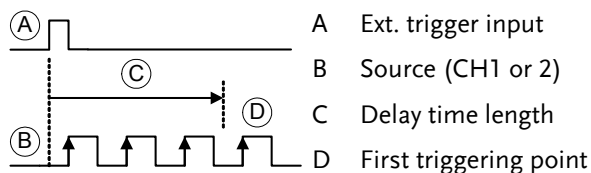

Video Extracts a sync pulse from a video format signal, and triggers on a specific line or field.

Pulse Triggers when the pulse width of the signal is too narrow or too wide compared to the setting.

Trigger parameter overview

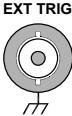
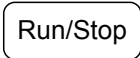
Trigger source	CH1 ~ 4	Channel 1 ~ 4 input signals	
	Line	AC mains signal	
	Ext	(For 2CH models only) external trigger input signal	
Trigger mode	Auto	GDS-2000 generates an internal trigger if there is no trigger event, to make sure waveforms are constantly updated regardless of trigger events. Select this mode especially when viewing rolling waveform at slower timebase.	
	Normal	GDS-2000 acquires waveform only when a trigger event occurs.	
	Single	GDS-2000 acquires waveform once when a trigger event occurs, then stop acquiring. Press the Run/Stop key to acquire waveform again.	
Auto level	When turning this function ON, GDS-2000 automatically adjusts the trigger level to the center amplitude of the waveform.		
Holdoff	The holdoff function defines the waiting period before GDS-2000 starts triggering again after a trigger point. The Holdoff function ensures a stable display.		





 Triggers on AC+DC component.

Frequency rejection	LF	Puts a high-pass filter and rejects the frequency below 50kHz.
	HF	Puts a low-pass filter and rejects the frequency above 50kHz.

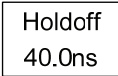

Noise rejection Rejects noise signal.

Setup Holdoff and Auto level

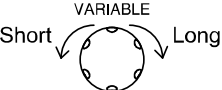
Background Holdoff function defines the waiting period before GDS-2000 starts triggering again after a trigger point. Auto level function automatically adjusts the trigger level to the center amplitude of the waveform.

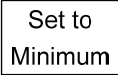

- Panel operation
1. Press the Trigger menu key twice.  
 2. To set the Holdoff time, press F1 (Holdoff) and use the Variable knob. The resolution depends on the horizontal scale.  

Range 40ns~2.5s

Pressing F2 (Set to Minimum) sets the Holdoff time to the minimum, 40ns.  

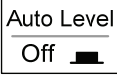

Note: The holdoff function is automatically disabled when the waveform update mode is in Roll or Scan mode (page97).

3. To turn Auto Level On/Off, press F5 (Auto Level).  

Use edge trigger

- Panel operation
- Press the Trigger menu key.

MENU

 - Press F1 repeatedly to select edge trigger. The edge trigger indicator appears at the bottom of the display.

Type
Edge

F 1



From left: channel, edge trigger, slope
 - Press F2 repeatedly to select the trigger source.

Source
CH1

F 2

 Range Channel 1 ~ 4, Line, Ext
 - Press F3 repeatedly to select the trigger mode.

Mode
Auto

F 3

 Range Auto, Normal, Single
 - Press F5 (Slope/coupling) to set trigger slope and coupling.

Slope /
Coupling

F 5

 - Press F1 (Slope) repeatedly to select the trigger slope, which also appears at the bottom of the display.

Slope

F 1

 Range Rising edge, falling edge
 - Press F2 (Coupling) repeatedly to select the trigger coupling.

Coupling

F 2

 Range DC, AC

8. Press F3 (Rejection) to select the frequency rejection mode.

Rejection
Off

F 3

Range LF, HF, Off

9. Press F4 (Noise Rej) to turn the noise rejection On/Off.

Noise Rej
Off

F 4

Range On, Off

10. Press F5 (Previous menu) to go back to the previous menu.

Previous Menu

F 5

Use advanced delay trigger (2CH model)

Panel operation 1. Make sure the edge trigger source is set to CH1 or CH2. If not, GDS-2000 automatically selects CH1 as the source.

2. Press F1 repeatedly to select Delay trigger.

Type
Delay

F 1

CH1 DELAY

From left: channel, delay trigger, slope

3. Press F2 (By time) or F3 (By event) and use the Variable knob to select the delay time or event after the first trigger condition.

By Time
100ns

F 2

By Event
2

F 3

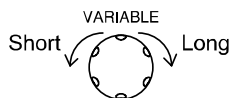

Range 100ns ~ 1.3ms (by time)
 2 ~ 65000 (by event)

4. Press F4 (Ext) repeatedly to select the threshold level for the external trigger input.

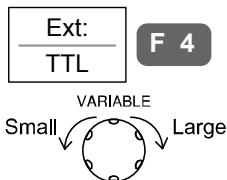

Range TTL (1.48V), ECL (1.35V),
 User (-12V ~ +12V)

5. Press F5 (Slope/Coupling) to set the slope and coupling condition for external trigger input signal. Note that this setting does not affect the trigger source signal (Channel 1 or 2).



Use video trigger

Panel operation

1. Press the Trigger menu key.



2. Press F1 repeatedly to select video trigger. The video trigger indicator appears at the bottom of the display.

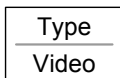

F 1

CH1 VIDEO P

From left: channel, video trigger, polarity

3. Press F2 repeatedly to select the trigger source channel.

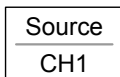

F 2

Range Channel 1 ~ 4

4. Press F3 repeatedly to select the video standard.

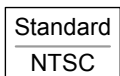

F 3

Range NTSC, PAL, SECAM

5. Press F4 repeatedly to select the video signal polarity.

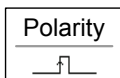

F 4

Range positive, negative

6. Press F5 repeatedly to select the video field line. Use the Variable knob to select the video line.

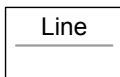

F 5

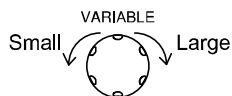

Field 1, 2

Video line NTSC: 1 ~ 262 (Even), 1 ~ 263 (Odd)
 PAL/SECAM: 1 ~ 312 (Even),
 1 ~ 313 (Odd)

Use pulse width trigger

Panel operation

1. Press the Trigger menu key.

MENU

2. Press F1 repeatedly to select pulse width trigger. The pulse width trigger indicator appears at the bottom of the display.

Type
Pulse

F 1

CH1 PULSE

From left: channel, pulse width trigger, slope

3. Press F2 repeatedly to select the trigger source.

Source
CH1

F 2

Range Channel 1 ~ 4, Line, Ext

4. Press F3 repeatedly to select the trigger mode.

Mode
Auto

F 3

Range Auto, Normal, Single

5. Press F4 repeatedly to select the pulse condition. Then use the Variable knob to set the pulse width.

When <
20.0ns

F 4

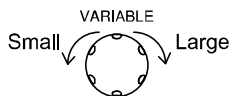

Condition >, <, =, ≠

Width 20ns ~ 200us

6. Press F5 to set trigger slope and coupling.

Slope /
Coupling

F 5

- 7. Press F1 (Slope) repeatedly to select the trigger slope, which also appears at the bottom of the display.

Slope

F 1

Range Rising edge, falling edge

- 8. Press F2 (Coupling) repeatedly to select the trigger coupling.

Coupling

F 2

Range DC, AC

- 9. Press F3 (Rejection) to select the frequency rejection mode.

Rejection
Off 

F 3

Range LF, HF, Off

- 10. Press F4 (Noise Rej) to turn the noise rejection On/Off.

Noise Rej
Off 

F 4

Range On, Off

- 11. Press F5 (Previous menu) to go back to the previous menu.







Previous
Menu

F 5

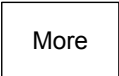
System Info / Language / Clock

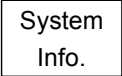
This section describes how to set the interface, beeper, language, time/date, and probe compensation signal.

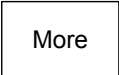

View system information

- Panel operation
1. Press the Utility key. 
 2. Press F5 (More).  
 3. Press F2 (System Info). The upper half of the display shows the system information in the following format.
 - Manufacturer name
 - Model name
 - Serial number
 - Firmware version 
 4. Press any other key (for example F5 (More) to go back to the waveform display mode.  





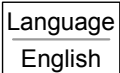

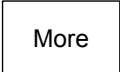

Select menu language

- Parameter
- The following is the list of menu language available by default. Language selection differs according to the region to which GDS-2000 is shipped.
- English
 - Chinese (traditional)
 - Chine (simplified)
 - Korean

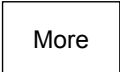
- Spanish
- Russian
- Dutch
- Italian
- Portuguese
- Japanese
- German
- Polish
- French

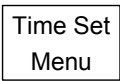
- Panel operation
1. Press the Utility key. 
 2. Press F4 (Language) repeatedly to select the language.  

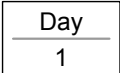
Set date and time

- Panel operation/
parameter
1. Press the Utility key. 
 2. Press F5 (More) twice.  
 
 3. Press F2 (Time Set Menu).  
 4. Press F2 (Year/ Month/ Date) repeatedly. Use the Variable knob to change the value.  

Year	2000 ~ 2037
Month	1 ~ 12
Day	1 ~ 31

5. Press F4 (Save) to confirm the value.



6. Press F1 (Date) to switch to the Time setting menu.



7. Press F2 (Hour/ Minute) repeatedly. Use the Variable knob to change the value.

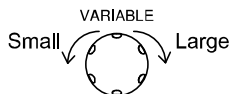
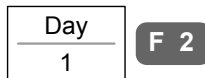

Hour 0 ~ 23

Minute 0 ~ 59

8. Press F4 (Save) to confirm the value.



9. Turn Off the display and turn it On again (power cycle).

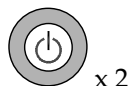

10. Make sure the date/time setting is correctly reflected at the top of the display.



SAVE/RECALL

File format / Utility	Display image file format	120
	Waveform file format	120
	Setup file format	122
	USB flash drive file utility.....	123
Save	File type/source/destination	128
	Save panel setting.....	129
	Save waveform	130
	Save All.....	134
Recall	File type/source/destination	137
	Recall default panel setting.....	137
	Recall waveform	139
	Recall waveform	140
	Recall waveform	142

File Format/Utility

Display image file format

Format	DSxxxx.bmp or Axxxx.bmp (Windows bitmap format)
Contents	The current display image in 234 x 320 pixels, color format. The background color can be inverted (Ink saver function).

Waveform file format

Format	DSxxxx.csv or Axxxx.csv (Comma-separated values format, can be opened in spreadsheet applications such as Microsoft Excel)	
Waveform type	CH1 ~ 4	Input channel signal
	Math	Math operation result (page64)
Storage location	W1 ~ W20	Waveform file stored in the internal memory. Stored waveforms can be copied to USB flash drive for transfer, or to Ref. A ~ D for showing on the display (W1 ~ W20 waveforms cannot be directly recalled on the display).
	Ref A ~ D	Reference waveform stored in the internal memory, separate from W1 ~ W20. From Ref A ~ D, waveforms can be recalled directly on the display with amplitude and frequency information. Useful for reference purpose in measurements.

Contents:
waveform data

The waveform data can be used for detailed analysis. It consists of horizontal and vertical position of the waveform for the entire memory length.

One division includes 25 points of horizontal and vertical data. The vertical point starts from the center line. The horizontal point starts from the leftmost waveform.

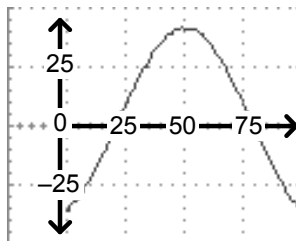

The time length or voltage level which each data point represents differs according to the vertical and horizontal scale. For example:

Vertical scale: 10mV/div (4mV per point)

Horizontal scale: 100us/div (4us per point)

Contents: other
data

The following information is also included in the waveform file.

- Memory length
- source channel
- vertical offset
- vertical scale
- coupling mode
- waveform last dot address
- date and time
- trigger level
- vertical position
- time base
- probe attenuation
- horizontal view
- horizontal scale
- sampling period
- sampling mode

Setup file format

Format	DSxxxx.set or Axxxx.set (proprietary format)	
	The setup file saves or recalls the following setting.	
Contents	Acquire	<ul style="list-style-type: none"> • mode • memory length
	Cursor	<ul style="list-style-type: none"> • source channel • cursor on/off • cursor location
	Display	<ul style="list-style-type: none"> • dots/vectors • accumulation on/off • grid type
	Measure	<ul style="list-style-type: none"> • item • source channel
	Utility	<ul style="list-style-type: none"> • hardcopy type • ink saver on/off • interface type • RS-232 config • buzzer type • GPIB address • Go-NoGo cond. • menu language
	Program	<ul style="list-style-type: none"> • step contents • loop count • start/stop steps
	Horizontal	<ul style="list-style-type: none"> • display mode • scale • position
	Trigger	<ul style="list-style-type: none"> • trigger type • source channel • trigger mode • video standard • video polarity • video line • pulse timing • slope/coupling
	Channel (vertical)	<ul style="list-style-type: none"> • vertical scale • vertical position • coupling mode • invert on/off • bandwidth limit on/off • probe attenuation
	Math	<ul style="list-style-type: none"> • operation type • source channel • vertical position • unit/div • FFT window

USB flash drive file utility

Background For USB flash drive, file deletion, folder creation, file/folder rename are available from the front panel. This feature is not available for internally stored files.

Panel operation 1. Connect the drive to the front or rear panel USB port. Note: Only one host connection, front or rear, is allowed at a time.

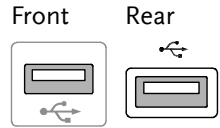

2. Press the Save/Recall key. Select any save or recall functionality, for example USB destination in Save Image function.



3. Press F5 (File Utilities). The display shows the USB flash drive contents, root directory.

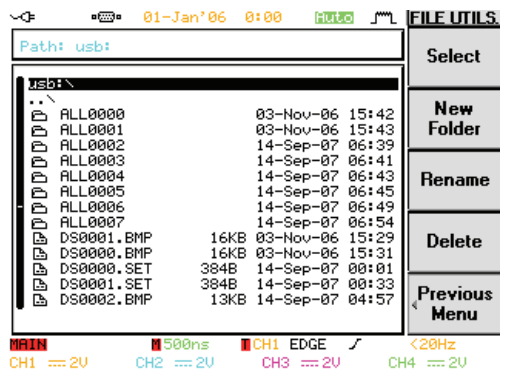

4. Use the Variable knob to move the cursor. Press F1 (Select) to go into the folder or go back to the previous directory level.

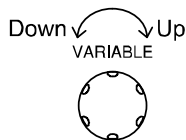

Go back to the root directory



Go back to the previous (higher) directory



Go into the folder



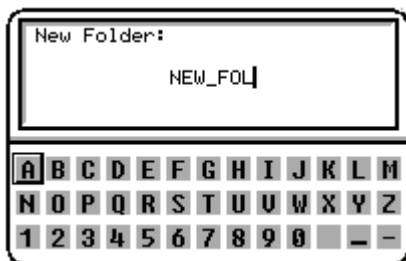
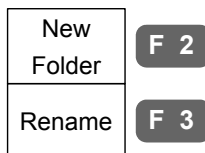

Create new folder / Rename file or folder

1. Move the cursor to the file or folder location and press F2 (New Folder) or F3 (Rename). The file/folder name and the character map appear on the display.

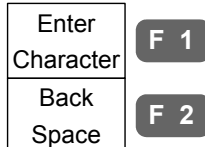
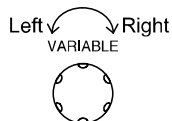



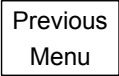



2. Use the Variable knob to move the pointer to the characters. Press F1 (Enter Character) to add a character or F2 (Back Space) to delete a character.

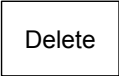

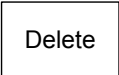
3. When editing is completed, press F4 (Save). A new folder or a new folder/file name is created.  
4. Press F5 (Previous Menu) to go back to the previous menu.  

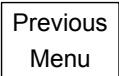
Delete folder/file

1. Move the cursor to the folder or file location and press F4 (Delete). A message appears at the bottom of the display, asking additional confirmation.
Press F4 again to confirm this process.  
2. If the file/folder still needs to be deleted, press F4 (Delete) again to complete deletion. To cancel deletion, press any other key.  
3. The USB flash drive content is updated. Press F5 (Previous Menu) to go back to Save/Recall menu.  

Quick Save (HardCopy)

Background

The Hardcopy key works as a shortcut for saving or printing out information.



Once set, subsequent file saving only requires pressing the Hardcopy key. Hardcopy key can be configured into three operations: save image, save all (image, waveform, setup), and printing.

The printing operation is described in page146.

Using the Save/Recall key can also save files but with more configurations. For details, see page128.



Functionality

- | | |
|--------------------|--|
| Save image (*.bmp) | Saves the current display image into a USB flash drive connected to the front or rear panel terminal. |
| Save all | <p>Saves the following items into a USB flash drive connected to the front or rear panel terminal.</p> <ul style="list-style-type: none"> • Current display image (*.bmp) • Current system setup (*.set) • Current waveform data (*.csv) • Last stored system setup (*.set) • Last stored waveform data (*.csv) |
| Print out | Prints out the display image to an external printer connected to USB port. For details, see page146. |

Panel operation

1. Connect the drive to the front or rear panel USB port.
Note: Only one host connection, front or rear, is allowed at a time.

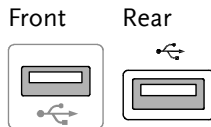

2. Press the Utility key.



3. Press F1 (Hardcopy Menu).



4. Press F1 (Function) repeatedly to select Save image or Save all.



5. To invert the color for the saved or printed display image, press F2 (Ink Saver) and turn On the Ink Saver.



Ink Saver On (normal)

Ink Saver Off (inverted)

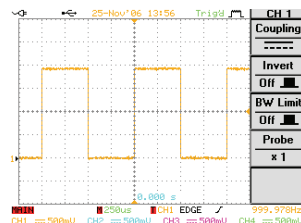
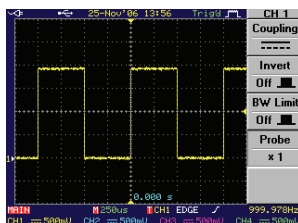

6. To save the image or folder, press the Hardcopy key.
The file or folder is saved to the root directory of the USB flash drive.

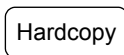

Save

File type/source/destination

Item	Source	Destination
Panel setup (DSxxxx.set)	<ul style="list-style-type: none"> • Front panel settings 	<ul style="list-style-type: none"> • Internal memory: S1 ~ S20 • External memory: USB
Waveform data (DSxxxx.csv)	<ul style="list-style-type: none"> • Channel 1 ~ 4 • Math operation result • Reference waveform A ~ D 	<ul style="list-style-type: none"> • Internal memory: Reference waveform A ~ D, W1 ~ W20 • External memory: USB
Display image (DSxxxx.bmp)	<ul style="list-style-type: none"> • Display image 	<ul style="list-style-type: none"> • External memory: USB
Save All	<ul style="list-style-type: none"> • Display image (Axxxx.bmp) • Waveform data (Axxxx.csv) • Front panel settings (Axxxx.set) 	<ul style="list-style-type: none"> • External memory: USB

Save panel setting

- Panel operation
- (For saving to an external USB flash drive) Connect the drive to the front or rear panel USB port.
Note: Only one host connection, front or rear, is allowed at a time.

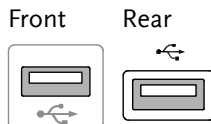

- Press the Save/Recall key.



- Press F3 (Save Setup). The display shows the available file destinations.

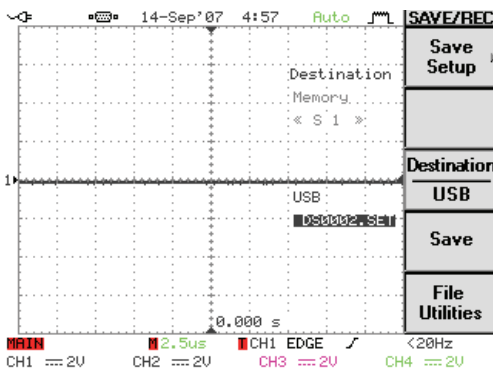

- Press F3 (Destination) repeatedly to select the saved location. Use the Variable knob to change the memory location (S1 ~ S20) or the file name (DSxxxx.set).

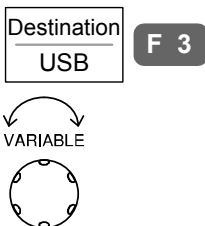

Memory Internal memory, S1 ~ S20

USB External flash drive, no practical limitation on the amount of file. When saved, the setup file is placed in the root directory.

5. Press F4 (Save) to confirm saving. When completed, a message appears at the bottom of the display.



Note  The file will not be saved if the power is turned Off or USB drive is taken out before the message.

USB file utility To edit USB flash drive contents (create/ delete/ rename files and folders), press F5. For details, see page123.



Save waveform

Panel operation 1. (For saving to an external USB flash drive) Connect the drive to the front or rear panel USB port.
Note: Only one host connection, front or rear, is allowed at a time.

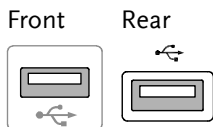

2. Press the Save/Recall key.
3. Press F4 (Save Waveform). The display shows the available source and destination options.

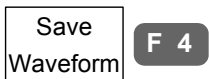
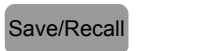

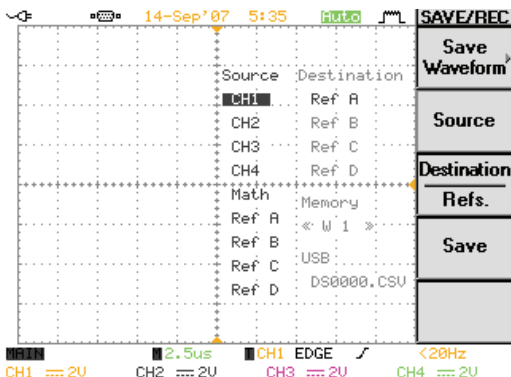

4. Press F2 (Source). Use the Variable knob to select the source signal.



- CH1 ~ CH2 Channel 1 ~ 2 signal
(2CH model)
- CH1 ~ CH4 Channel 1 ~ 4 signal
(4CH model)
- Math Math operation result
(page64)
- RefA ~ D Internally stored reference
waveforms A ~ D

5. Press F3 (Destination) repeatedly to select the file destination. Use the Variable knob to select the memory location or file name.



- Memory Internal memory, W1 ~ W20

- USB External flash drive, no practical limitation on the amount of file. When saved, the waveform file is placed in the root directory.
- Ref Internal reference waveform, A~D

6. Press F4 (Save) to confirm saving. When completed, a message appears at the bottom of the display.



Waveform save to RefA completed

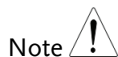

Note The file will not be saved if the power is turned Off or USB drive is taken out before the message.

USB file utility To edit USB flash drive contents (create/ delete/ rename files and folders), press F5. For details, see page123.



PC software (FreeWave) Saving waveform is also available through the proprietary PC software, downloadable from GWInstek website.



Save display image

Panel operation 1. Connect the drive to the front or rear panel USB port. Note: Only one host connection, front or rear, is allowed at a time.

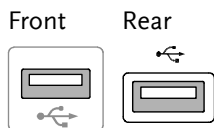

2. Press the Save/Recall key.



3. Press F5 (More).



4. Press F1 (Save Image). The display shows the available file destinations.

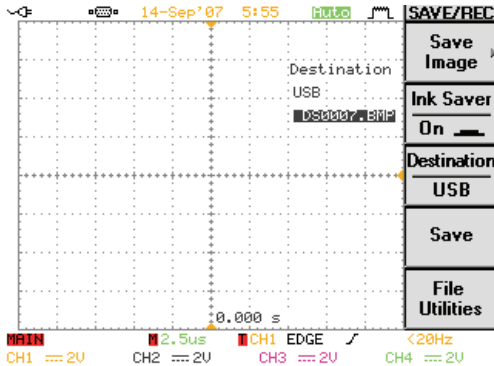

5. Press F2 (Ink Saver) repeatedly to invert the background color (On) or not (Off).



Ink Saver On (normal)

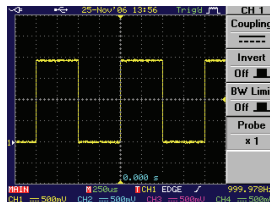

Ink Saver Off (inverted)

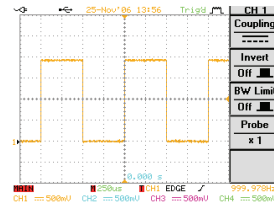

6. Press F3 (Destination). Use the Variable knob to select the file name.



USB External flash drive, no practical limitation on the amount of file. When saved, the image file is placed in the root directory.

7. Press F4 (Save) to confirm saving. When completed, a message appears at the bottom of the display.



Note  The file will not be saved if the power is turned Off or USB drive is taken out before the message.

USB file utility To edit USB flash drive contents (create/ delete/ rename files and folders), press F5. For details, see page123.



PC software (FreeWave) Saving display image is also available through proprietary PC software, downloadable from GWInstek website.



Save All

- Panel operation
1. Connect the drive to the front or rear panel USB port. Note: Only one host connection, front or rear, is allowed at a time.

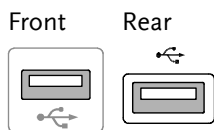

2. Press the Save/Recall key.



3. Press F5 (More).



- Press F2 (Save All). The display shows the available file destinations. The following files are saved, contained in a folder.



- | | |
|------------------------------|---|
| Setup file
(Axxxx.set) | Two types of setups are saved: the current panel setting and the last internally saved setting (one of S1 ~ S20). |
| Display image
(Axxxx.bmp) | The current display image in bitmap format. |
| Waveform data
(Axxxx.csv) | Two types of waveform data are saved: the currently active channel data and the last internally saved data (one of W1 ~ W20). |

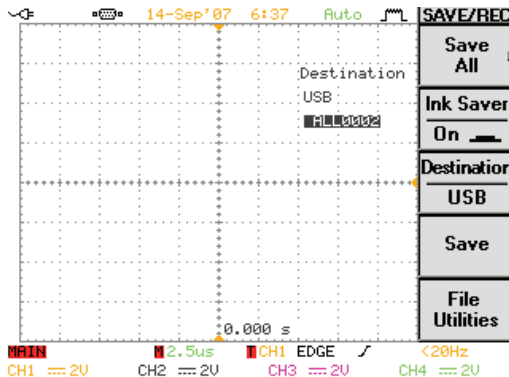

- Press F2 (Ink Saver) repeatedly to invert the background color (On) or not (Off) for the display image.



Ink Saver On (normal)

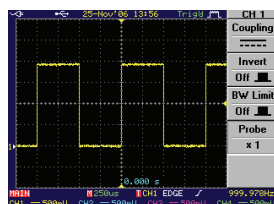

Ink Saver Off (inverted)

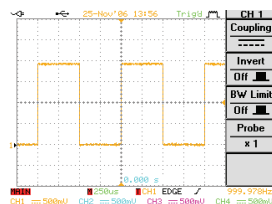

- Press F3 (Destination). Use the Variable knob to select the file name.



USB External flash drive, no practical limitation on the amount of file. When saved, the folder is placed in the root directory.

- Press F4 (Save) to confirm saving. When completed, a message appears at the bottom of the display.



Note  The file will not be saved if the power is turned Off or USB drive is taken out before the message.

- Together with the current setup/waveform/image, the last saved waveform file (one from W1 ~ W20) and setup file (one from S1 ~ S20) are also included in the folder.

USB file utility

To edit USB flash drive contents (create/ delete/ rename files and folders), press F5. For details, see page123.





Recall

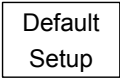

File type/source/destination

Item	Source	Destination
Default panel setup	<ul style="list-style-type: none"> Factory installed setting 	<ul style="list-style-type: none"> Current front panel
Reference waveform	<ul style="list-style-type: none"> Internal memory: A ~D 	<ul style="list-style-type: none"> Current front panel
Panel setup (DSxxx.set)	<ul style="list-style-type: none"> Internal memory: S1 ~ S20 External memory: USB 	<ul style="list-style-type: none"> Current front panel
Waveform data (DSxxx.csv)	<ul style="list-style-type: none"> Internal memory: W1 ~ W20 External memory: USB 	<ul style="list-style-type: none"> Reference waveform A ~ D
Display image (DSxxx.bmp)	<ul style="list-style-type: none"> External memory: USB 	<ul style="list-style-type: none"> Display

Recall default panel setting

- Panel operation
- Press the Save/Recall key. 
 - Press F1 (Default Setup). The factory installed setting is recalled and replaces the current panel setting.  

Setting contents The following is the default setting contents.

Acquisition	Mode: Normal	Memory length: 500
Channel	Scale: 2V/Div	CH1: On, CH2/3/4: Off
	Coupling: DC	Invert: Off
	BW limit: Off	Probe attenuation: x1
Cursor	Source: CH1	Horizontal: None
	Vertical: None	
Display	Type: Dots	Accumulate: Off
	Graticule: 	
Go-NoGo	Go-No: Off	Source: CH1
	NoGo when: 	Violating: Stop
Horizontal	Scale: 2.5us/Div	Mode: Main Timebase
Math	Type: + (Add)	Channel: CH1+CH2
	Position: 0.00 Div	Unit/Div: 2V
Measure	Source1, 2: CH1, CH2	Type: VPP, Freq, FRR
Program	Mode: Edit	Step: 1
Trigger	Type: Edge	Source: Channel1
	Mode: Auto	Slope: 
	Coupling: DC	Rejection: Off
	Noise Rejection: Off	
Utility	SaveImage, InkSaver Off	GPIB, Address 8
	Sound: Off	

Recall reference waveform on the display

Panel operation 1. The reference waveform must be stored in advance. See page for waveform store details.

2. Press the Save/Recall key. 

3. Press F2 (Display Refs). The reference waveform display menu appears. 

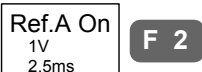
4. Select the reference waveform from F1 (Ref A) to F4 (Ref D) and press it. The waveform appears on the display and the period and amplitude of the waveform appears in the menu. 
 ↓
 

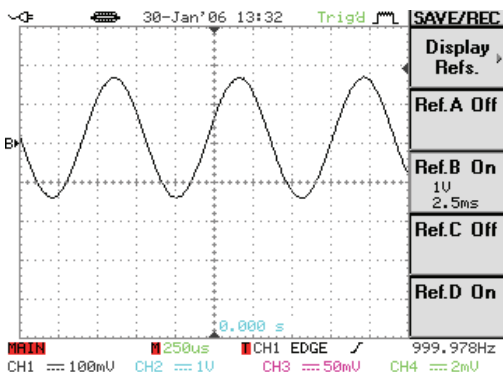

5. To clear the waveform from the display, press F1 ~ F4 key again. 

Recall panel setting

- Panel operation
- (For recalling from an external USB flash drive)
Connect the drive to the front or rear panel USB port.
Note: Only one host connection, front or rear, is allowed at a time.

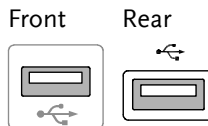

- Press the Save/Recall key.



- Press F5 (More).



- Press F3 (Recall Setup). The display shows the available file sources.

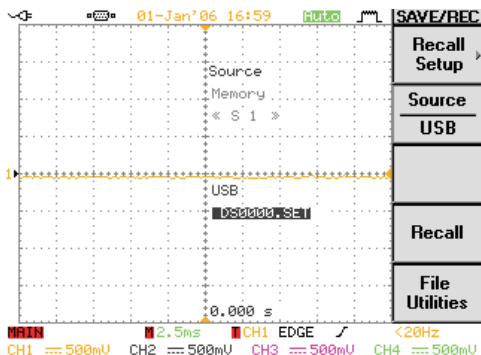

5. Press F2 (Source) repeatedly to select the file source, internal memory or external USB. Use the Variable knob to change the memory location (S1 ~ S20) or the file name (DSxxxx.set).

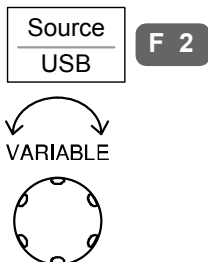

Memory Internal memory, S1 ~ S20

USB External flash drive, no practical limitation on the amount of file. The setup file must be placed in the root directory to be recognized.

6. Press F4 (Recall) to confirm recalling. When completed, a message appears at the bottom of the display.



```
Setup recalled from S 1
```

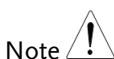

Note

The file will not be saved if the power is turned Off or USB drive is taken out before the message.

USB file utility

To edit USB flash drive contents (create/ delete/ rename files and folders), press F5. For details, see page123.



Recall waveform

- Panel operation
- (For recalling from an external USB flash drive) Connect the drive to the front or rear panel USB port. Note: Only one host connection, front or rear, is allowed at a time.

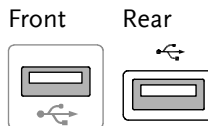

- Press the Save/Recall key.



- Press F5 (More).



- Press F4 (Recall Waveform). The display shows the available source and destination options.

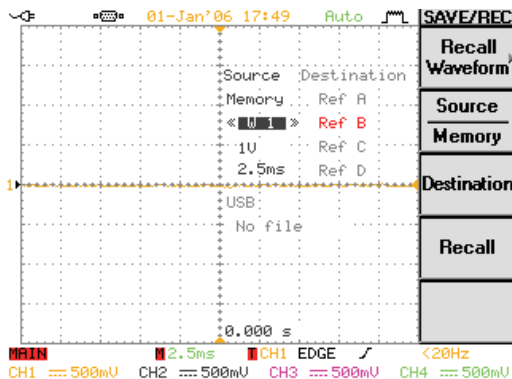

5. Press F2 (Source) repeatedly to select the file source, internal memory or external USB. Use the Variable knob to change the memory location (S1 ~ S20) or the file name (DSxxxx.csv).

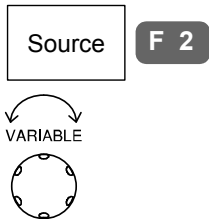

Memory	Internal memory, W1 ~ W20
USB	External flash drive, no practical limitation on the amount of file. The waveform file must be placed in the root directory to be recognized.

6. Press F3 (Destination). Use the Variable knob to select the memory location.

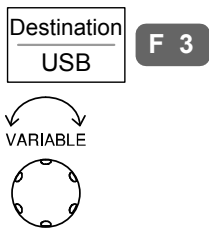

RefA ~ D	Internally stored reference waveforms A ~ D
----------	---

7. Press F4 (Save) to confirm recalling. When completed, a message appears at the bottom of the display.



Waveform recalled from W 1

Note 

The file will not be saved if the power is turned Off or USB drive is taken out before the message.

USB file utility To edit USB flash drive contents (create/ delete/ rename files and folders), press F5. For details, see page123.



Recall image

Panel operation

1. Connect the USB drive to the front or rear panel USB port.

Note: Only one host connection, front or rear, is allowed at a time.

Front



Rear



2. Press the Save/Recall key.

Save/Recall

3. Press F5 (More).

More

F 5

4. Press F5 (Recall Image). The display shows the available source options.

Recall Image

F 1

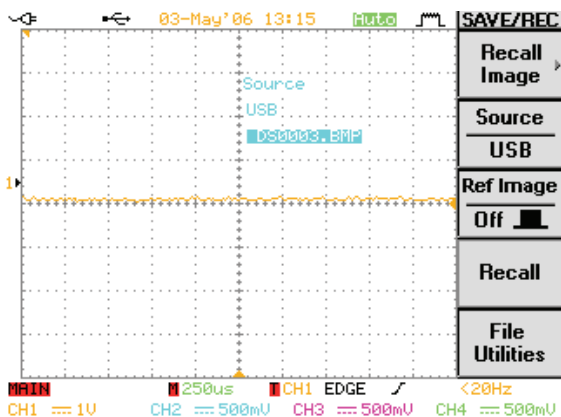

5. To select the source image file, press F2 (Source) and use the Variable knob.

Source
USB

F 2

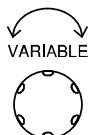

- To show the image on the display, press F3 (Ref Image) ON or F4 (Recall).



- The image appears on the display and the "R" indicator appears at the top left corner of the display.

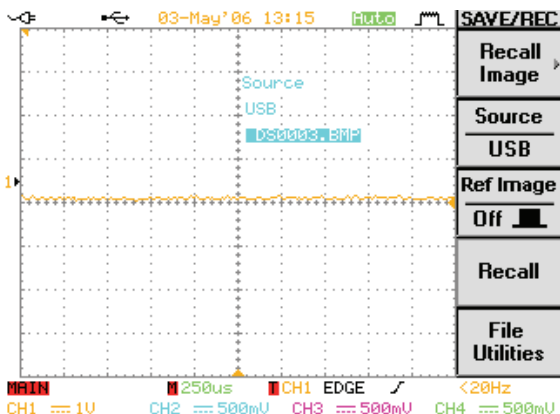

- To clear the image off the display, press F3 (Ref Image) OFF.



PRINT OUT

Display printout is also available using proprietary PC software, downloadable from GWInstek website.

Overview

Printout step Listed below are the steps that have to be followed when printing out the display image through USB connector.

1. Connect the printer to the USB host port
2. Configure the interface to printout mode
3. Configure the content and printout
4. Printout

1 Connect printer

1. Connect the printer to the USB host port, front or rear panel.

Front panel







Rear panel



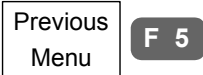

USB Note Using the front and rear USB host port at the same time is forbidden (Example: printer to the rear panel, storage device to the front panel).

2 Configure interface

- Panel operation
1. Press the Utility key. 
 2. Press F2 (Interface menu). 
 3. Press F1 (Type) repeatedly to select USB. 
 4. Press F5 (Previous menu). 
 5. Press F1 (Hardcopy menu). 
 6. Press F1 (Function) repeatedly to select Printer. 

3 Configure content

- Panel operation
1. Press the Utility key. 
 2. Press F1 (Hardcopy Menu). 
 3. Press F1 (Function) repeatedly to select Printer if it is not selected yet. 

- To invert the color for the saved or printed display image, press F2 (Ink Saver) and turn On the Ink Saver.



Ink Saver On (normal)

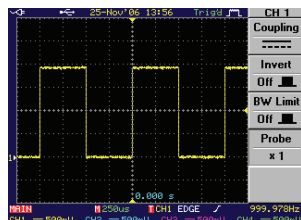

Ink Saver Off (inverted)

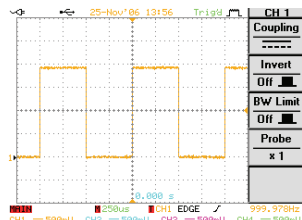

- To select black/white or color printing, press F3 (Portrait) repeatedly; Gray (b&w) or Color.



- To select the printed size, press F4 (Ratio). Use the Parameter knob to change the ratio with respect to the real display size.

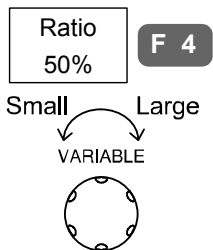

Range 10% ~ 100%

4 Printout

Press the Hardcopy key. The display image is printed out.

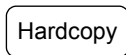

REMOTE CONTROL CONFIG





This chapter describes basic configuration of IEEE488.2 based remote control. For command list, refer to the programming manual downloadable from GWInstek website, www.gwinstek.com

Configuration	Configure USB interface	150
	Configure RS-232C interface.....	151
	Configure GPIB interface (optional)	153
	USB/RS-232C remote control software	155

Interface Configuration





Configure USB interface

USB configuration	PC side connector	Type A, host
	GDS-2000 side connector	Type B, slave
	Speed	1.1/2.0 (full speed)

- Panel operation
1. Press the Utility key. 
 2. Press F2 (Interface Menu). 
 3. Press F1 (Type) repeatedly to select USB. 
 4. The interface icon at the top of the display changes into USB type. 
 5. Connect the USB cable to the rear panel slave port. 
 6. When the PC asks for the USB driver, select gds2k_cdc.inf included in the FreeWave software package downloadable from GW website, www.gwinstek.com, GDS-2000 product corner. The driver file automatically sets GDS-2000 as serial port COM7.

Configure RS-232C interface

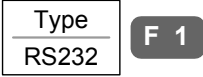
RS-232C configuration	Connector	DB-9, Male
	Baud rate	2400, 4800, 9600, 19200, 38400
	Parity	None, Odd, Even
	Data bit	8 (fixed)
	Stop bit	1, 2

- Panel operation
1. Press the Utility key. 
 2. Press F2 (Interface Menu). 
 3. Press F1 (Type) repeatedly to select RS-232C. 
 4. The interface icon at the top of the display changes into RS-232C type. 
 5. To change the baud rate, press F2 (Baud Rate) repeatedly. 

Range 2400, 4800, 9600, 19200, 38400
 6. To change the stop bit, press F3 (Stop Bit) repeatedly. 

Range 1, 2
 7. Data bit is fixed at 8.
 8. To change the parity, press F4 (Parity) repeatedly. 

Range None, Odd, Even

9. Connect the RS-232C cable to the rear panel port: DB-9 male connector. For functionality check see page155.

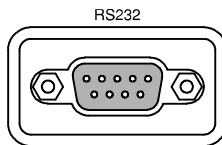

Pin assignment

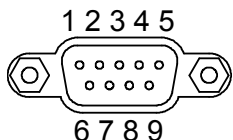

- 2: RxD (Receive data)
- 3: TxD (Transmit data)
- 5: GND
- 4, 6 ~ 9: No connection

PC connection

Use the Null Modem connection as in the below diagram.

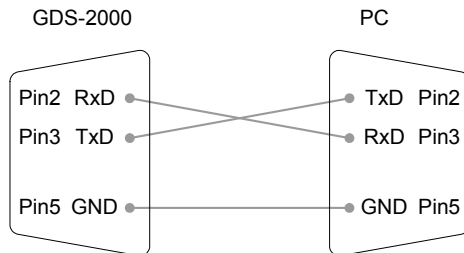

Configure GPIB interface (optional)

GPIB module installation

The optional GPIB module is available as a separate kit. Follow the instruction to install the module properly.

1. Turn Off the GDS-2000 power  switch.

2. Take off two screws and remove the rear panel GPIB module cover.

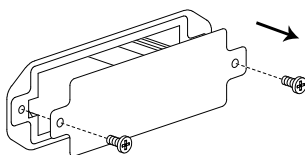

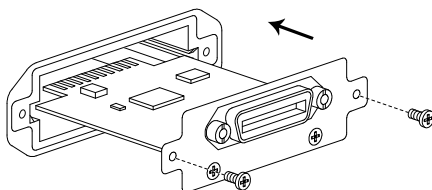

3. Insert the GPIB module and put the screws back.



4. Turn On the GDS-2000  power switch.

Configure GPIB

1. Press the Utility key. 
2. Press F2 (Interface Menu). 
3. Press F1 (Type) repeatedly to select GPIB. 

4. The interface icon at display top changes to GPIB.



5. Press F2 (Address). Use the Variable knob to change the GPIB address.

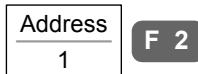

Range 1 ~ 30

6. Connect the GPIB cable to the rear panel port: 24-pin female connector.

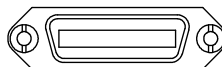

- GPIB constraints
- Maximum 15 devices altogether, 20m cable length, 2m between each device
 - Unique address assigned to each device
 - At least 2/3 of the devices turned On
 - No loop or parallel connection

Pin assignment

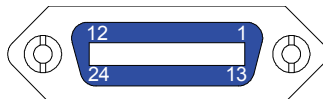

Pin1	Data line 1	Pin13	Data line 5
Pin2	Data line 2	Pin14	Data line 6
Pin3	Data line 3	Pin15	Data line 7
Pin4	Data line 4	Pin16	Data line 8
Pin5	EOI	Pin17	REN
Pin6	DAV	Pin18	Ground
Pin7	NRFD	Pin19	Ground
Pin8	NDAC	Pin20	Ground
Pin9	IFC	Pin21	Ground
Pin10	SRQ	Pin22	Ground
Pin11	ATN	Pin23	Ground
Pin12	Shield (screen)	Pin24	Signal ground

USB/RS-232C remote control software

Terminal application (USB/RS-232C)	<p>Invoke the terminal application such as MTTY (Multi-Threaded TTY). For RS-232C, set the COM port, baud rate, stop bit, data bit, and parity accordingly.</p> <p>To check the COM port No, see the Device Manager in the PC. For WinXP, Control panel → System → Hardware tab.</p>
Functionality check	<p>Run this query command via the terminal.</p> <pre>*idn?</pre> <p>This should return the Manufacturer, Model number, Serial number, and Firmware version in the following format.</p> <pre>GW, GDS-2064, 000000001, V1.00</pre>
PC Software (USB only)	<p>The proprietary PC software, downloadable from GWInstek website, can be used for remote control. This mode is available only for USB interface.</p>

BATTERY OPERATION

The optional battery allows portable operations such as field applications. Battery packs and related internal components are factory installed items: contact the service center for new installation.

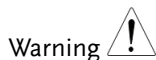

Never insert or remove the battery while the power is On.

- Battery insertion
1. Turn Off the power and take off the power cord.

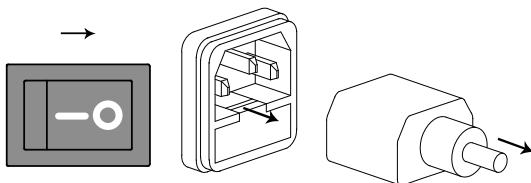

2. Open the rear panel battery pack cover.

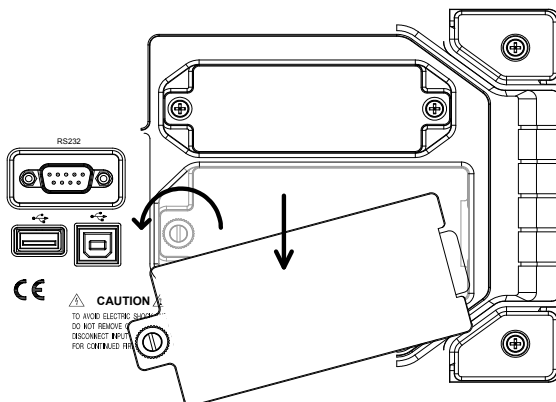

3. Insert the battery packs and close the cover.

4. Turn On the power and make sure the battery icon appears at the top left corner of the display.



Rating	Type	Li-Ion battery x 2, 11.1V average
	Running time	3 hours typical
	Charging time	8 hours typical when Power Off 16 hours typical when Power On

Battery status 1. To view the battery installation and recharge status, press the Utility key.



2. Press F5 (More).



3. Press F2 (System Info).

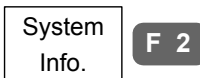

4. The battery status (output voltage and charging rate) appears on the lower half of the display.







	BATTERY INFORMATION	
	BAT. #1	BAT. #2
Voltage:	12.05V	12.04V
Capacity:	98%	94%

- Note
- When the battery is not in use for a long time, take them out to prolong the battery life.
 - Battery operation requires additional components that are factory installed. Merely inserting battery packs into standard GDS-2000 does not work. For new installation, contact Goodwill.

MAINTENANCE

Two types of maintenance operations are available: calibrate vertical resolution, and compensate the probe. Run these operations when using GDS-2000 in a new environment.

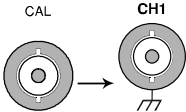
Vertical Resolution Calibration

- Panel operation
1. Press the Utility key. 
 2. Press F5 (More). 
 3. Press F1 (Self Cal Menu). 
 4. Press F1 (Vertical). 
 5. The buzzer sounds and the message "Set CAL to CH1, then press F5" appears at the bottom of the display.
 6. Connect the calibration signal from the rear panel CAL out to Channel1 input. 
 7. Press F5. 
(no menu item)

8. The calibration for Channel1 starts and ends automatically, in less than 5 minutes.

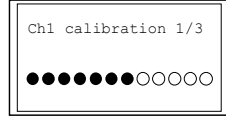

9. When finished, connect the calibration signal to Channel2 and press F5. Channel2 calibration starts.

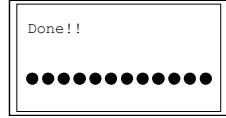

10. (for 4 Channel model only) Repeat the above step for Channel 3 and 4.
11. When the calibration for all channels is completed, the display goes back the default state.

Probe Compensation

- Panel operation
1. Connect the probe between Channel1 input and the probe compensation output (2Vp-p, 1kHz square wave) on the front panel. Set the probe attenuation to x10.

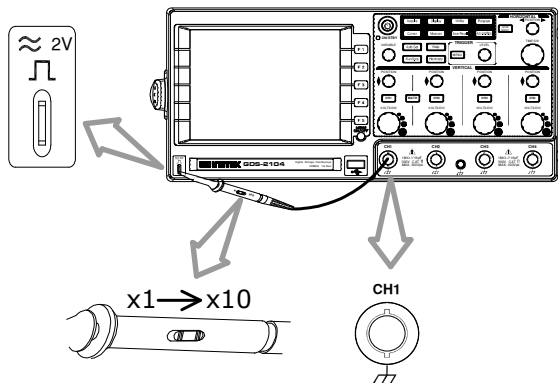

2. Press the Utility key.



3. Press F5 (More) twice.



x2

4. Press F1 (ProbeComp Menu).



5. Press F1 (Wavetype) repeatedly to select the standard square wave.



6. Press the Auto Set key. The compensation signal appears on the display.



7. Press the Display key, then F1 (Type) twice to select the vector waveform.

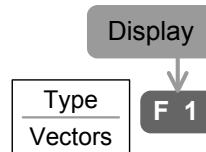
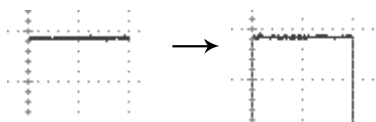

8. Turn the adjustment point on the probe until the signal edge becomes sharp.

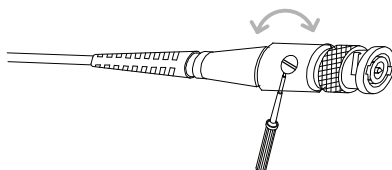
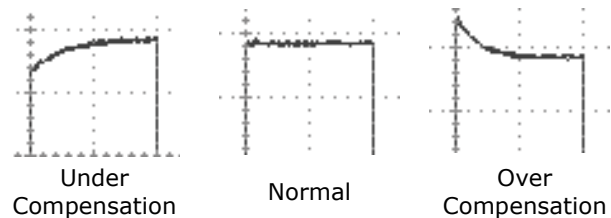

F AQ

- I pressed the Power (On/Standby) key on the front panel but nothing happens.
- I connected the signal but it does not appear on the display.
- I want to remove the (Measurement result / FFT result / Help contents) from the display.
- The waveform does not update (frozen).
- The probe waveform is distorted.
- Auto Set does not catch the signal well.
- I want to clean up the cluttered panel settings.
- The display image printout is too dark on the background.
- I want to install the optional battery pack.
I put the battery pack in but it is not working.
- The date and time setting are not correct.
- USB does not work.
- The accuracy does not match the specification.

I pressed the Power (On/Standby) key on the front panel but nothing happens.

Make sure you turned On the rear panel Power switch. For power up sequence, see page23.

I connected the signal but it does not appear on the display.

Make sure you have activated the channel by pressing the Channel key (the LED turns On).

I want to remove the (Measurement result / FFT result / Help contents) from the display.

To clear automatic measurement result, press the Measure key twice, then Press F4 (OFF). See page55 for details.

To clear FFT result, press the Math key twice. See page64 for details.

To clear Help result, press the Help key again. See page46 for details.

The waveform does not update (frozen).

Press the Run/Stop key to unfreeze the waveform. See page50 for details.

If this does not help, the trigger mode might be set to Single. Press the Trigger menu key, then F3 (Mode) to Auto. See page106 for trigger setting details.

The probe waveform is distorted.

You might need to compensate the probe. For details, see page159. Note that the frequency accuracy and duty factor are not specified for probe compensation waveform and therefore it should not be used for other reference purpose.

Auto Set does not catch the signal well.

Autoset function cannot catch signals under 30mV or 30Hz. Please use the manual operation. See page49 for Auto Set details.

I want to clean up the cluttered panel settings.

Recall the default settings by pressing Save/Recall key→F1. For default setting contents, see page45.

The display image printout is too dark on the background.

Use the Inksaver function which reverses the background color. For details, see page146.

I want to install the optional battery pack.

I put the battery pack in but it is not working.

The battery pack needs additional internal components to work properly. They are factory installed items: contact your dealer. For battery operation details, see page156.

The date and time setting are not correct.

For date and time setting details, please see page117. If it does not help, the internal battery controlling the clock might be worn out. Contact your dealer or GWInstek.

USB does not work.

Make sure you are not using the front and the rear USB host connector at the same time. Disconnect either of the USB device and try again.

The accuracy does not match the specification.

Make sure the device is powered On for at least 30 minutes, within +20°C~+30°C. This is necessary to stabilize the unit to match the specification.

For more information, contact your local dealer or GWInstek at www.gwinstek.com / marketing@goodwill.com.tw.

APPENDIX

Fuse Replacement

- Step 1. Take off the power cord and remove the fuse socket using a minus driver.

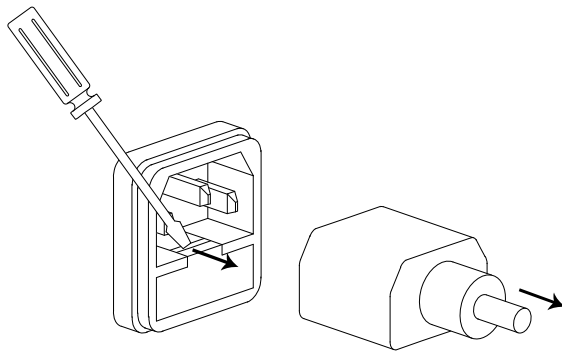

2. Replace the fuse in the holder.

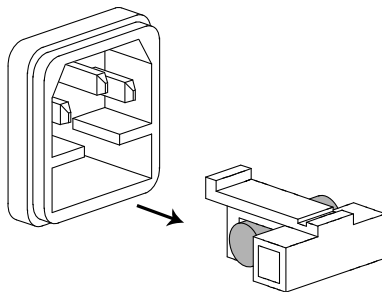

Rating T2A, 250V

GPIB Module Installation

For GPIB interface and remote control details, see page149.

- GPIB kit contents
- GPIB module
 - Programming manual (programming manual is also downloadable from GWInstek website).

Step

1. Turn Off the GDS-2000 power switch.

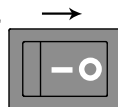

2. Take off two screws and remove the rear panel GPIB module cover.

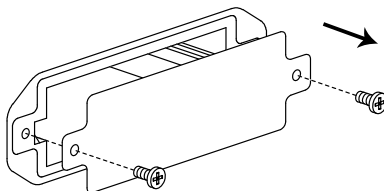

3. Insert the GPIB module and put the screws back.

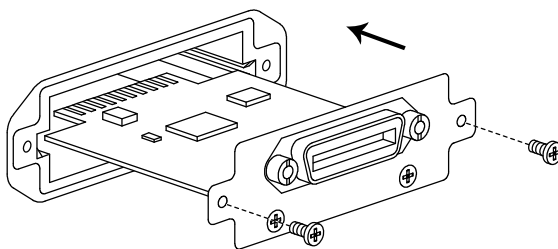

4. Turn On GDS-2000. Press the Utility key, then F2 (Interface) repeatedly. Make sure GPIB menu is selectable, and a GPIB icon appears on the top left corner of the display.

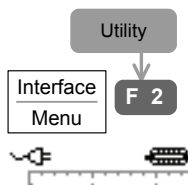

GDS-2000 Specifications

The specifications apply when GDS-2000 is powered on for at least 30 minutes under +20°C~+30°C.

Model-specific

GDS-2062	Channels	2
	Bandwidth	DC ~ 60MHz (-3dB)
	Rise time	5.8ns approx.
GDS-2064	Channels	4
	Bandwidth	DC ~ 60MHz (-3dB)
	Rise time	5.8ns approx.
GDS-2102	Channels	2
	Bandwidth	DC ~ 100MHz (-3dB)
	Rise time	3.5ns approx.
GDS-2104	Channels	4
	Bandwidth	DC ~ 100MHz (-3dB)
	Rise time	3.5ns approx.
GDS-2202	Channels	2
	Bandwidth	DC ~ 200MHz (-3dB)
	Rise time	1.75ns approx.
GDS-2204	Channels	4
	Bandwidth	DC ~ 200MHz (-3dB)
	Rise time	1.75ns approx.

Common

Vertical	Sensitivity	2mV/div~5V/Div (1-2-5 increments)
	Accuracy	± (3% x Readout +0.05div x Volts/div + 0.8mV)
	Input Coupling	AC, DC, Ground
	Input	1MΩ±2%, ~16pF
	Impedance	
	Polarity	Normal & Invert
	Maximum Input	300V (DC+AC peak), CAT II
	Math operation	+, -, FFT
	Offset Range	2mV/div~20mV/div: 0.5V 50mV/div~200mV/div: 5V 500mV/div~2V/div: 50V 5V/div: 300V
	Bandwidth Limit	20MHz (-3dB)

Trigger	Sources	CH1, CH2, Line, EXT (2ch model only), CH3, CH4 (4ch model only)
	Modes	Auto-Level, Auto, Normal, Single, TV, Edge, Pulse Width, Time-Delay, Event-Delay (2ch model only)
	Coupling	AC, DC, LFrej, HFrej, Noise rej
	Sensitivity	DC~25MHz: Approx. 0.5div or 5mV 25MHz~max: Approx. 1div or 10mV
	Holdoff	40ns ~ 2.5s
	External Trigger (2ch model only)	Range
	Sensitivity	DC~30MHz: ~50mV 30MHz~max: ~100mV
	Input Impedance	1MΩ±2%, ~16pF
	Maximum Input	300V (DC + AC peak), CAT II
Horizontal	Range	1ns/div~10s/div, 1-2-5 increment Roll mode: 250ms/div ~ 10s/div
	Modes	Main, Window, Window Zoom, Roll, Scan, X-Y
	Accuracy	±0.01%
	Pre-Trigger	20 div maximum
	Post-Trigger	1000 div
X-Y Mode	X-Axis Input	Channel 1
	Y-Axis Input	Channel 2
	Phase Shift	±3° at 100kHz
Signal Acquisition	Real-Time	1G Sa/s maximum
	Equivalent	25G Sa/s maximum
	Vertical Resolution	8 bits
	Record Length	25K Dots Maximum
	Acquisition	Normal, Peak Detect, Average
	Peak Detection	10ns
	Average	2, 4, 8, 16, 32, 64, 128, 256
Cursors and Measurement	Voltage	Vpp, Vamp, Vavg, Vrms, Vhi, Vlo, Vmax, Vmin, Rise Preshoot/ Overshoot, Fall Preshoot/ Overshoot
	Time	Freq, Period, Rise Time, Fall Time, Positive Width, Negative Width, Duty Cycle
	Delay	FRR, FRF, FFR, FFF, LRR, LRF, LFR, LFF
	Cursors	Voltage difference (ΔV) and Time difference (ΔT) between cursors

	Auto Counter	Resolution: 6 digits Accuracy: ±2% Signal source: All available trigger source except the Video trigger
Control Panel Function	Auto Set	Automatically adjust Vertical Volt/div, Horizontal Time/div, and Trigger level
	Save Setup	Internal memory: 20 sets USB Flash drive: unlimited
	Save Waveform	Internal memory: 20 sets USB Flash drive: unlimited
	Save display image	USB Flash drive: unlimited
Display	LCD	5.6 inch, TFT, brightness adjustable
	Resolution (dots)	234 (Vertical) x 320 (Horizontal)
	Graticule	8 x 10 divisions (menu On) 8 x 12 divisions (menu Off)
Interface	Go-No Go Output	5V max/ 10mA TTL open collector
	RS-232C	DTE DB 9-pin male
	GPIB (Optional)	IEEE488.2 24-pin female
	USB	Host: Flash drive, Printer Device: Remote control 2.0 full speed supported
Power Source	Line Voltage	100V~240V AC, 48Hz~63Hz
	Battery (Optional)	Li-Ion pack, 11.1V average 8 hours charge time (Power On) 3 hours operating time (depend on conditions)
Miscellaneous	Language Selection	English, Traditional Chinese, Simplified Chinese, others (depend on the region)
	On-Line Help	Available for most keys
	Real-Time Clock	Display: yy/mm/dd/hh/ss (time stamp for saved data)
Operation Environment	Ambient temperature 0 ~ 50°C Relative humidity ≤ 80%, 40°C or below ≤ 45%, 41°C~50°C	
Storage Environment	Storage Temperature: -10°C~60°C, no condensation- Relative humidity 93% @ 40°C 65% @ 41°C~60°C	
Dimensions	254 (D) x 142 (H) x 310 (W) mm	
Weight	Approx. 4.3kg	

Probe Specifications

Model-specific

GTP-060A	Applicable to Bandwidth Rise time	GDS-2062, GDS-2064 DC ~ 60MHz @ Position x 10 5.8ns
GTP-150A	Applicable to Bandwidth Rise time	GDS-2102, GDS-2104 DC ~ 150MHz @ Position x 10 2.3ns
GTP-250A	Applicable to Bandwidth Rise time	GDS-2202, GDS-2204 DC ~ 250MHz @ Position x 10 1.4ns

Common

Position x 10	Attenuation Ratio	10:1
	Input Resistance	10MΩ when used with 1MΩ input oscilloscope
	Input Capacitance	17pF approx.
	Compensation	10 ~ 35pF
	Range	
Position x 1	Maximum Input Voltage	500V CAT I, 300V CAT II (DC+Peak AC) Derating with frequency
	Attenuation Ratio	1:1
	Bandwidth	DC ~ 6MHz
	Rise Time	58ns
	Input Resistance	1MΩ when used with 1MΩ input oscilloscope
Operating Condition	Input Capacitance	47pF + oscilloscope capacitance
	Compensation	10 ~ 35pF
	Range	
	Maximum Input Voltage	300V CAT I, 150V CAT II (DC+Peak AC) Derating with frequency
	Temperature	-10°C ~ 55°C
Safety Standard	Relative Humidity	≤85% @35°C
		IEC 1010-1 CAT II

* Note: GW Instek reserves the right to change the probe model type (GTP-060A, GTP-150A, GTP-250A) at anytime without notice for probe types of similar specification.

Declaration of Conformity

We

GOOD WILL INSTRUMENT CO., LTD.

No. 7-1, Jhongsing Rd, Tucheng City, Taipei County 236. Taiwan.

GOOD WILL INSTRUMENT (SUZHOU) CO., LTD.

No. 69 Lushan Road, Suzhou New District Jiangsu, China.

declare that the below mentioned product

Type of Product: Digital Storage Oscilloscope

**Model Number: GDS-2062, GDS-2064, GDS-2102, GDS-2104,
GDS-2202, GDS-2204**

are herewith confirmed to comply with the requirements set out in the Council Directive on the Approximation of the Law of Member States relating to Electromagnetic Compatibility (2004/108/EC) and Low Voltage Equipment Directive (73/23/EEC & 93/68/EEC).

For the evaluation regarding the Electromagnetic Compatibility and Low Voltage Equipment Directive, the following standards were applied:

◎ EMC	
EN 61326-1 : Electrical equipment for measurement, control and laboratory use—	
EN 61326-2-1:	
EN 61326-2-2: EMC requirements (2006)	
Conducted & Radiated Emission CISPR 11: 2003+A1: 2004 +A2: 2006	Electrostatic Discharge IEC 1000-4-2: 2001
Current Harmonics EN 61000-3-2: 2006	Radiated Immunity IEC 1000-4-3: 2006+A1: 2007
Voltage Fluctuations EN 61000-3-3:1995+A1:2001+A2:2005	Electrical Fast Transients IEC 1000-4-4: 2004+Corr.1: 2006+Corr.2: 2007
=====	Surge Immunity IEC 1000-4-5: 2005
=====	Conducted Susceptibility IEC 61000-4-6: 2003+A1: 2004+A2: 2006
=====	Power Frequency Magnetic field IEC 61000-4-8: 1993+A1: 2000
=====	Voltage Dip/Interruption IEC 61000-4-11: 2004

Low Voltage Equipment Directive 73/23/EEC & amended by 93/68/EEC	
Safety Requirements	IEC/EN 61010-1: 2001

I NDEX

2-4 channel difference	11	coupling mode.....	103
AC coupling	103	menu tree	28
acquisition	85	cursor	60
menu tree	27	menu tree	28
addition.....	65	shortcut	28
menu tree	30	specification.....	167
auto level.....	109	cycle time measure.....	56
auto set.....	49	date setting.....	117
effect on channel.....	48	faq	163
exception.....	49	indicator.....	21
faq	162	menu tree	44
specification.....	168	DC coupling.....	103
auto template.....	75	default setup.....	137
auto trigger	107	contents	45
automatic measurement	57	effect on channel.....	48
faq	162	menu tree	33
menu tree	31	delay measure.....	56
overview	55	delay trigger.....	111
shortcut	31	menu tree	38
specification.....	167	display	93
average acquisition.....	85	contrast setting.....	93
average voltage measure	56	diagram	20
bandwidth limitation	104	grid setting.....	94
battery	156	menu tree	29
faq	163	save image	132
icon on power up.....	23	shortcut	29
specification.....	168	specification.....	168
blackman window	65	Disposal instructions	8
buzzer.....	70	dot waveform	91
menu tree	40	download information	13
calibration, vertical resolution	158	duty cycle measure	56
caution symbol.....	5	ECL	108
channel.....	48	edge trigger.....	110
faq	161	menu tree	38
menu tree	28	EN61010	170
shortcut	28	measurement category	6
status indicator	21	pollution degree	8
cleaning the instrument	7	environment	168

safety instruction.....	7	scale	96
equivalent time sampling.....	90	shortcut	29
external trigger	107	specification.....	167
input terminal	17	IEC 1010-1.....	169
specification.....	167	initialization.....	24
falling time measure.....	56	ink saver	
FFT.....	67	in display save	133
horizontal cursor	61	in hardcopy	127
menu tree.....	30	in save all	135
overview	64	input frequency indicator.....	21
vertical cursor.....	63	interface.....	150
file format	120	menu tree	41
firmware version	116	specification.....	168
flattop window	65	invert waveform	104
FM example.....	88	language selection	116
frequency measure	56	list of features	12
front panel diagram	14	long memory	88
fuse replacement.....	164	low voltage measure	55
safety instruction	7	math.....	64
generic purpose signal.....	53	faq	162
go-nogo.....	69	menu tree	30
how to configure.....	70	shortcut	30
how to run	76	memory length.....	87
menu tree	42	menu on/off.....	94
output specification.....	168	min/max template.....	73
output terminal.....	77	model difference	11
template menu tree	42	normal acquisition.....	85
GPIB	153	normal trigger	107
module installation	165	NTSC.....	108
ground		overshoot voltage measure.....	56
coupling	103	package contents.....	13
symbol.....	5	PAL.....	108
terminal.....	17	pc software download.....	13
hanning window	64	peak detect acquisition.....	85
hardcopy.....	126	peak voltage measure.....	55
menu tree	41	power on/off.....	23
shortcut	41	faq	161
help.....	46	safety instruction	7
faq.....	162	switch overview.....	18
high voltage measure.....	55	preshoot voltage measure.....	56
holdoff.....	109	printout	
horizontal	95	faq	163
basic operation.....	51	menu tree	41
cursor menu tree.....	28	probe	159
cursor operation.....	60	attenuation level	105
menu tree.....	29	attenuation menu tree.....	28
position.....	95		

- compensation menu tree 43
- compensation signal overview... 53
- faq 162
- memory length demonstration .. 89
- package list 13
- peak detect demonstration 86
- specification 169
- program 78
 - how to edit 79
 - how to run 81
 - menu tree 32
 - shortcut 32
- program manual download 13
- pulse time measure 56
- pulse width trigger 114
 - menu tree 38
- real time sampling 90
- rear panel diagram 18
- recall 137
 - default setup 137
 - menu tree 33
 - reference waveform 139
 - setup 140
 - shortcut 33
 - waveform 142
- rectangular window 65
- reference waveform
 - how to recall 139
 - menu tree 33
- remote control 149
 - interface configuration 150
- rising time measure 56
- roll mode 98
- RS-232C interface 151
- run/stop 50
 - faq 162
 - horizontal position 95
 - horizontal scale 96
- save 128
 - display image 132
 - menu tree 33
 - save all 134
 - setup 129
 - shortcut 33
 - specification 168
 - waveform 130
- scan mode 97
- SECAM 108
- serial number 116
- service operation
 - about disassembly 6
 - contact 163
- setup
 - default contents 45
 - file format 122
 - how to recall 140
 - how to save 129
 - menu tree 34
 - recall menu tree 35, 36
- short memory 88
- single trigger mode 107
 - faq 162
 - with run/stop 50
- spike noise example 88
- stop icon 50
- subtraction 65
 - menu tree 30
- system information 116
 - battery 157
- template for go-nogo 72
- tilt stand 22
- time setting 117
 - faq 163
 - indicator 21
 - menu tree 44
- trigger 106
 - delay 111
 - edge 110
 - menu tree 37
 - parameter 107
 - pulse width 114
 - shortcut 37
 - single trigger with run/stop 50
 - specification 167
 - status indicator 21
 - video 113
- TTL 108
- UK power cord 9
- USB
 - driver download 13
 - faq 163
 - file menu tree 37
 - file operation 123
 - PC software download 155
 - remote control interface 150
- utility

key overview	15	waveform	
menu tree	40	accumulation	92
shortcut	40	file contents	121
vector waveform	91	how to recall	142
vertical	102	how to save	130
basic operation	52	invert waveform	104
cursor menu tree	28	recall menu tree	35, 36
cursor operation	62	roll mode	98
position	102	scan mode	97
resolution calibration	158	x-y mode	100
scale	102	zoom mode	99
specification	166	waveform color	20
video line	108	x-y mode	100
video trigger	113	specification	167
menu tree	37	zoom waveform	99
warning symbol	5		