

Digital Storage Oscilloscope

GDS-1000 Series

USER MANUAL

GW INSTEK PART NO. 82DS-11020ME1



ISO-9001 CERTIFIED MANUFACTURER

GW INSTEK

February 2011 edition

This manual contains proprietary information, which is protected by copyright. All rights are reserved. No part of this manual may be photocopied, reproduced or translated to another language without prior written consent of Good Will Corporation.

The information in this manual was correct at the time of printing. However, Good Will continues to improve its products and therefore reserves the right to change the specifications, equipment, and maintenance procedures at any time without notice.

Good Will Instrument Co., Ltd.
No. 7-1, Jhongsing Rd., Tucheng Dist., New Taipei City 236, Taiwan (R.O.C).

Table of Contents

SAFETY INSTRUCTION	7
Safety Symbols	7
Safety Guidelines.....	8
Power cord for the United Kingdom.....	11
GETTING STARTED	12
Main Features	12
Panel Overview.....	13
Front Panel	13
Rear Panel.....	16
Display.....	17
Setting up the Oscilloscope.....	18
QUICK REFERENCE	20
Menu Tree and Shortcuts.....	20
Acquire key	20
Autoset key	21
CH1/2 key.....	21
Cursor key 1/2	21
Cursor key 2/2	22
Display key.....	22
Hardcopy key.....	23
Help key.....	23
Horizontal menu key.....	23
Math key 1/2.....	24
Math key 2/2.....	24
Measure key.....	25
Run/Stop key	25
Save/Recall key 1/9	26
Save/Recall key 2/9	26
Save/Recall key 3/9	27
Save/Recall key 4/9	27
Save/Recall key 5/9	28
Save/Recall key 6/9	28
Save/Recall key 7/9	29
Save/Recall key 8/9	29
Save/Recall key 9/9	30
Trigger key 1/4.....	30

Trigger key 2/4	31
Trigger key 3/4	31
Trigger key 4/4	32
Utility key 1/4	32
Utility key 2/4	33
Utility key 3/4	33
Utility key 4/4	33
Default Settings.....	34
Built-in Help.....	35

MEASUREMENT 36

Basic Measurements	36
Activating a channel.....	36
Using the Autoset	37
Running and stopping the trigger	38
Changing the horizontal position and scale.....	39
Changing the vertical position and scale	40
Using the probe compensation signal	41
Automatic Measurements.....	43
Measurement items.....	43
Automatically measuring the input signals.....	45
Cursor Measurements	46
Using the horizontal cursors	46
Using the vertical cursors	48
Math Operations	49
Overview.....	49
Adding or subtracting signals.....	50
Using the FFT function	51

CONFIGURATION..... 52

Acquisition	52
Selecting the acquisition mode	52
Real time vs Equivalent time sampling mode.....	54
Display	55
Selecting the vector or dot drawing.....	55
Accumulating the waveform.....	55
Adjusting the display contrast	56
Selecting the display grid.....	56
Horizontal View.....	57
Moving the waveform position horizontally	57
Selecting the horizontal scale.....	57
Selecting the waveform update mode	58

	Zooming the waveform horizontally.....	59
	Viewing waveforms in the X-Y mode	60
Vertical View (Channel)		61
	Moving the waveform position vertically.....	61
	Selecting the vertical scale	61
	Selecting the coupling mode	61
	Inverting the waveform vertically.....	62
	Limiting the waveform bandwidth	62
	Selecting the probe attenuation level	63
Trigger.....		64
	Trigger type.....	64
	Trigger parameter.....	64
	Configuring the edge trigger	67
	Configuring the video trigger	68
	Configuring the pulse width trigger	69
	Manually triggering the signal	71
Remote Control Interface		72
System Settings.....		73
	Viewing the system information	73
	Selecting the language	73
SAVE/RECALL.....		74
File Structures		74
	Display image file format	74
	Waveform file format	74
	Setup file format.....	76
	Using the SD card file utilities	77
Quick Save (HardCopy)		79
Save		81
	File type/source/destination.....	81
	Saving the panel settings	82
	Saving the waveform	83
	Saving the display image	84
	Saving all (panel settings, display image, waveform)	85
Recall		87
	File type/source/destination.....	87
	Recalling the default panel settings	87
	Recalling a reference waveform to the display	89
	Recalling panel settings	90
	Recalling a waveform	91
MAINTENANCE		93

Vertical Resolution Calibration	93
Probe Compensation	94

FAQ..... 96

The input signal does not appear in the display.	96
I want to remove some contents from the display.	96
The waveform does not update (frozen).....	96
The probe waveform is distorted.....	97
Autoset does not catch the signal well.....	97
I want to clean up the cluttered panel settings.....	97
The saved display image is too dark on the background....	97
The accuracy does not match the specifications.	97
The SD card slot does not accept my card.....	97

APPENDIX..... 99

Fuse Replacement	99
GDS-1000 Series Specifications	100
Model-specific specifications	100
Common specifications.....	101
Probe Specifications	103
GDS-1022/1042 Probe	103
GDS-1062/1102 Probe	103
Declaration of Conformity	104

INDEX..... 105

S SAFETY INSTRUCTION

This chapter contains important safety instructions that should be followed when operating and storing the oscilloscope. Read the following before any operation to ensure your safety and to keep best condition for the oscilloscope.

Safety Symbols

These safety symbols may appear in this manual or on the oscilloscope.



WARNING

Warning: Identifies conditions or practices that could result in injury or loss of life.



CAUTION

Caution: Identifies conditions or practices that could result in damage to the oscilloscope or to other objects or property.



DANGER High Voltage



Attention: Refer to the Manual



Protective Conductor Terminal



Earth (Ground) Terminal



Do not dispose electronic equipment as unsorted municipal waste. Please use a separate collection facility or contact the supplier from which this instrument was purchased.

Safety Guidelines

General Guideline



CAUTION

- Make sure the BNC input voltage does not exceed 300V peak.
- Never connect a hazardous live voltage to the ground side of the BNC connectors. It might lead to fire and electric shock.
- Do not place heavy objects on the oscilloscope.
- Avoid severe impacts or rough handling that may damage the oscilloscope.
- Avoid discharges of static electricity on or near the oscilloscope.
- Use only mating connectors, not bare wires, for the terminals.
- Do not block the cooling fan opening.
- Do not perform measurement at power source and building installation site (Note below).
- The oscilloscope should only be disassembled by a qualified technician.

(Measurement categories) EN 61010-1:2001 specifies the measurement categories and their requirements as follows. The GDS-1000 falls under category II.

- Measurement category IV is for measurement performed at the source of low-voltage installation.
 - Measurement category III is for measurement performed in the building installation.
 - Measurement category II is for measurement performed on the circuits directly connected to the low voltage installation.
 - Measurement category I is for measurements performed on circuits not directly connected to Mains.
-

- Power Supply
- AC Input voltage: 100 ~ 240V AC, 47 ~ 63Hz
 - The power supply voltage should not fluctuate more than 10%.
 - Connect the protective grounding conductor of the AC power cord to an earth ground.
-

- Fuse
- Fuse type: T1A/250V
 - To ensure fire protection, replace the fuse only with the specified type and rating.
 - Disconnect the power cord before replacing the fuse.
 - Make sure the cause of fuse blowout is fixed before replacing the fuse.
-

- Cleaning the oscilloscope
- Disconnect the power cord before cleaning the oscilloscope.
 - Use a soft cloth dampened in a solution of mild detergent and water. Do not spray any liquid into the oscilloscope.
 - Do not use chemical containing harsh products such as benzene, toluene, xylene, and acetone.
-

- Operation Environment
- Location: Indoor, no direct sunlight, dust free, almost non-conductive pollution (Note below)
 - Relative Humidity: $\leq 80\%$, 40°C or below
 $\leq 45\%$, 41°C~50°C
 - Altitude: < 2000m
 - Temperature: 0°C to 50°C

(Pollution Degree) EN 61010-1:2001 specifies the pollution degrees and their requirements as follows. the oscilloscope falls under degree 2.

Pollution refers to “addition of foreign matter, solid, liquid, or gaseous (ionized gases), that may produce a reduction of dielectric strength or surface resistivity”.

- Pollution degree 1: No pollution or only dry, non-conductive pollution occurs. The pollution has no influence.
- Pollution degree 2: Normally only non-conductive pollution occurs. Occasionally, however, a temporary conductivity caused by condensation must be expected.
- Pollution degree 3: Conductive pollution occurs, or dry, non-conductive pollution occurs which becomes conductive due to condensation which is expected. In such conditions, equipment is normally protected against exposure to direct sunlight, precipitation, and full wind pressure, but neither temperature nor humidity is controlled.

Storage environment

- Location: Indoor
- Storage temperature: $-10^{\circ}\text{C}\sim 60^{\circ}\text{C}$, no condensation-
- Relative Humidity: 93% @ 40°C
 $65\% @ 41^{\circ}\text{C} \sim 60^{\circ}\text{C}$

Disposal



Do not dispose this instrument as unsorted municipal waste. Please use a separate collection facility or contact the supplier from which this instrument was purchased. Please make sure discarded electrical waste is properly recycled to reduce environmental impact.

Power cord for the United Kingdom

When using the oscilloscope in the United Kingdom, make sure the power cord meets the following safety instructions.

NOTE: This lead/appliance must only be wired by competent persons

 **WARNING: THIS APPLIANCE MUST BE EARTHED**

IMPORTANT: The wires in this lead are coloured in accordance with the following code:

Green/ Yellow: Earth
Blue: Neutral
Brown: Live (Phase)



As the colours of the wires in main leads may not correspond with the colours marking identified in your plug/appliance, proceed as follows:
The wire which is coloured Green & Yellow must be connected to the Earth terminal marked with the letter E or by the earth symbol \oplus or coloured Green or Green & Yellow.

The wire which is coloured Blue must be connected to the terminal which is marked with the letter N or coloured Blue or Black.

The wire which is coloured Brown must be connected to the terminal marked with the letter L or P or coloured Brown or Red.

If in doubt, consult the instructions provided with the equipment or contact the supplier.

This cable/appliance should be protected by a suitably rated and approved HBC mains fuse: refer to the rating information on the equipment and/or user instructions for details. As a guide, cable of 0.75mm² should be protected by a 3A or 5A fuse. Larger conductors would normally require 13A types, depending on the connection method used.

Any moulded mains connector that requires removal /replacement must be destroyed by removal of any fuse & fuse carrier and disposed of immediately, as a plug with bared wires is hazardous if engaged in live socket. Any re-wiring must be carried out in accordance with the information detailed on this label.

G GETTING STARTED

The Getting started chapter introduces the oscilloscope's main features*, appearance, and set up procedure. *Firmware 1.16

Main Features

Model name	Frequency bandwidth	Input channels
GDS-1022	DC – 25MHz (–3dB)	2
GDS-1042	DC – 40MHz (–3dB)	2
GDS-1062	DC – 60MHz (–3dB)	2
GDS-1102	DC – 100MHz (–3dB)	2
Performance	<ul style="list-style-type: none"> • 250MSa/S real-time sampling rate • 25GS/s equivalent-time sampling rate • Up to 10ns peak detection 	
Feature	<ul style="list-style-type: none"> • 5.6 inch color TFT display • Saving and recalling setups and waveforms • 19 automatic measurements • Multi-language menu • Math operation: Add, Subtract, FFT • Edge, video, pulse width trigger • Compact size: (W) 310 x (D) 140 x (H) 142 mm 	
Interface	<ul style="list-style-type: none"> • SD card connector for saving and recalling data • Calibration output • External trigger input • SD card slave connector for remote control 	

Panel Overview

Front Panel

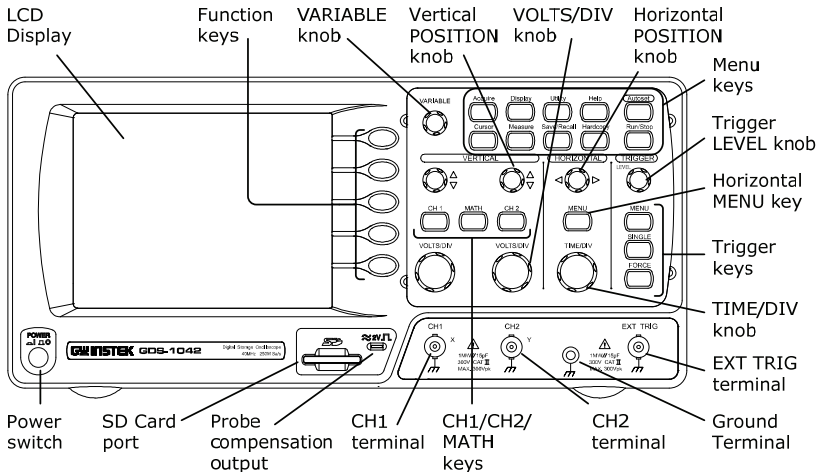

LCD display TFT color, 320 x 234 resolution, wide angle view LCD display.

Function keys: F1 (top) to F5 (bottom)  Activates the functions which appear in the left side of the LCD display.













Variable knob VARIABLE  Increases or decreases value and moves to the next or previous parameter.













Acquire key Acquire  Configures the acquisition mode (page52).

Display key Display  Configures the display settings (page55).

Cursor key Cursor  Runs cursor measurements (page46).

(Continued on next page)

Utility key		Configures the Hardcopy function (page79), shows the system status (page71), selects the menu language (page73), runs the self calibration (page93), and configures the probe compensation signal(page94).
Help key		Shows the Help contents on the display (page35).
Autoset key		Automatically configures the horizontal, vertical, and trigger settings according to the input signal (page37).
Measure key		Configures and runs automatic measurements (page43).
Save/Recall key		Saves and recalls image, waveform, or panel settings (page74).
Hardcopy key		Copies image, waveform, or panel settings to an SD card (page79).
Run/Stop key		Runs or stops triggering (page38).
Trigger level knob		Sets the trigger level (page64).
Trigger menu key		Configures the trigger settings (page64).
Single trigger key		Selects the single trigger mode (page71).
Trigger force key		Acquires the input signal once regardless of the trigger condition at the time (page71).
Horizontal menu key		Configures the horizontal view (page57).

Horizontal position knob		Moves the waveform horizontally (page57).
TIME/DIV knob	TIME/DIV 	Selects the horizontal scale (page57).
Vertical position knob		Moves the waveform vertically (page61).
CH1/CH2 key	CH 1 	Configures the vertical scale and coupling mode for each channel (page61).
VOLTS/DIV knob	VOLTS/DIV 	Selects the vertical scale (page61).
Input terminal	CH1 	Accepts input signals: $1M\Omega \pm 2\%$ input impedance, BNC terminal.
Ground terminal		Accepts the DUT ground lead to achieve a common ground.
MATH key	MATH 	Performs math operations (page49).
SD card connector		Facilitates transferring waveform data, display image, and panel settings (page74).
Probe compensation output	$\approx 2V_{p-p}$ 	Outputs a 2Vp-p, square signal for compensating the probe (page94) or demonstration.
External trigger input	EXT TRIG 	Accepts an external trigger signal (page64).
Power switch	POWER 	Powers the oscilloscope on or off.

Rear Panel

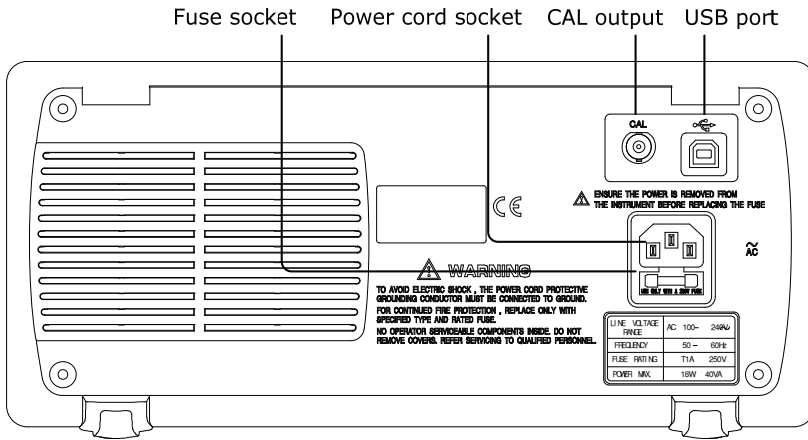

Power cord socket

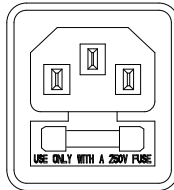

Power cord socket accepts the AC mains, 100 ~ 240V, 50/60Hz.

Fuse socket

Fuse socket holds the AC main fuse, T1A/250V.

For fuse replacement procedure, see page99.

USB slave port

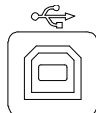

Accepts a type B (slave) male USB connector for remote controlling the oscilloscope (page72).

Calibration output



Outputs the calibration signal used in vertical scale accuracy calibration (page93).

Display

Waveform marker Waveform position Trigger status Acquisition

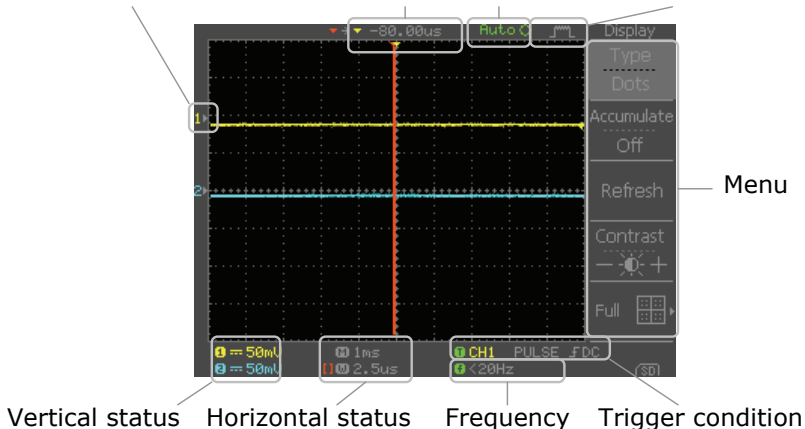

Waveforms	Channel 1: Yellow	Channel 2: Blue
Trigger status	Trig'd	A signal is being triggered
	Trig?	Waiting for a trigger condition
	Auto	Updating the input signal regardless of trigger conditions
	STOP	Triggering is stopped
	For trigger setting details, see page64.	
Input signal frequency	Updates the input signal frequency (the trigger source signal) in real-time. “< 20Hz” Indicates that the signal frequency is less than the lower frequency limit (20Hz) and thus not accurate.	
Trigger configuration	Shows the trigger source, type, and slope. In case of the Video trigger, shows the trigger source and polarity.	
Horizontal status	Shows the channel configurations: coupling mode, vertical scale, and horizontal scale.	
Vertical status		

Setting up the Oscilloscope

Background This section describes how to set up the oscilloscope properly including connecting a signal, adjusting the scale, and compensating the probe. Before operating the oscilloscope in a new environment, run these steps to make sure the oscilloscope is functionally stable.

Procedure

1. Connect the power cord.

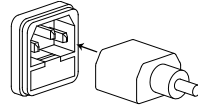

2. Press the power switch. The display will become active in approximately 10 seconds.



3. Reset the system by recalling the factory settings. Press the Save/Recall key, then *Default Setup*. For details of factory settings, see page 34.

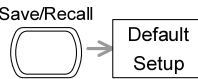

4. Connect the probe between the Channel1 input terminal and probe compensation signal output (2Vp-p, 1kHz square wave).
5. Set the probe attenuation to x10.

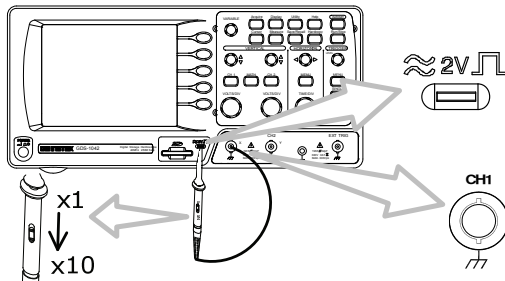

6. Press the Autoset key. A square waveform will appear in the center of the display. For details of the Autoset, see page37.



7. Press the Display key, then *Type* and select the vector waveform.

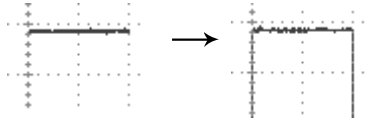
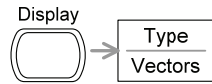

8. Turn the adjustment point on the probe to flatten the square waveform edge.

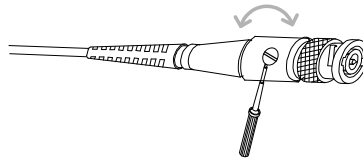
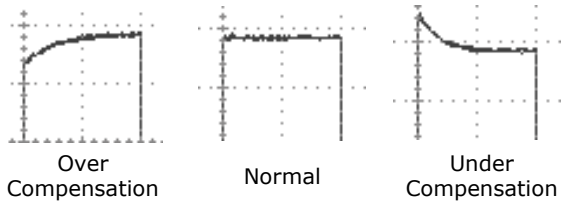



9. Setting up the oscilloscope is completed. You may continue with the other operations.

Measurements: page36 Configurations: page52

QUICK REFERENCE

This chapter lists the oscilloscope menu tree, operation shortcuts, built-in help coverage, and default factory settings. Use this chapter as a handy reference to access the oscilloscope functionalities.

Menu Tree and Shortcuts

- Normal = Press the functional key for “Normal”
- Average  = Repeatedly press the functional key for “Average”
- Normal ~ Average = Select a menu from “Normal” to “Average” and press its functionality key
- Normal → VAR  = Press the functionality key for “Normal”, and then use the Variable knob

Acquire key

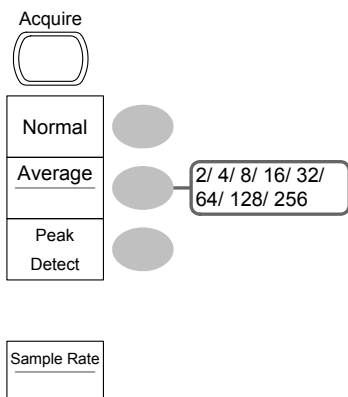

Select acquisition mode

Normal ~ Peak-Detect













Select average number

Average 











Autoset key

Autoset 	Automatically find signal and set scale	Autoset
--	---	---------











CH1/2 key

CH 1 		Turn channel on/off CH 1/2 
Coupling 	 	Select coupling mode Coupling 
Invert Off	 On/ Off	Invert waveform Invert 
BW Limit Off	 On/ Off (GDS-1102/1062)	Turn bandwidth limit on/off BW Limit 
Probe x1	 x1/ x10/ x100	Select probe attenuation factor Probe 

















Cursor key 1/2

Cursor 		Turn cursor on/off Cursor 
Source CH1	 CH1/ 2/ MATH	Move X1 cursor X1 → VAR 
X1 123.4us 212.0mV		Move X2 cursor X2 → VAR 
X2 22.9us 0.000V		Move both X1 and X2 cursor X1X2 → VAR 
X1X2 23.6us 11.9Hz 212.0mV		Switch to Y cursor X ↔ Y
X ↔ Y		

Cursor key 2/2

Cursor 		Turn cursor on/off Cursor 
Source CH1	 CH1/ 2/ MATH	Move Y1 cursor Y1 → VAR 
Y1 123.4mV		Move Y2 cursor Y2 → VAR 
Y2 12.9mV		Move both Y1 and Y2 cursor Y1Y2 → VAR 
Y1Y2 10.5mV		Switch to X cursor X ↔ Y
X ↔ Y		

Display key

Display 		Select waveform type Type 
Type Vectors	 Vectors/ Dots	Waveform accumulate On/Off Accumulate 
Accumulate Off	 On/ Off	Refresh accumulation Refresh
Refresh		Set display contrast Contrast → VAR 
Contrast -  +		Select display grid  
Full 	  /  / 	

Hardcopy key

Hardcopy

→ See Utility key (page32)



Help key

Help

Turn help mode on/off



Help ↩

Horizontal menu key

MENU



Main	●
Window	●
Window Zoom	●
Roll	●
XY	●

Select main (default) display

Main

Select window mode

Window → TIME/DIV 

Zoom in window mode

Window Zoom













Select window roll mode

Roll

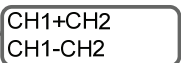

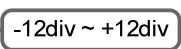

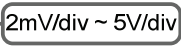







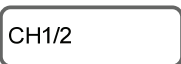

Select XY mode

XY

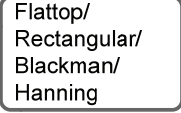
Math key 1/2

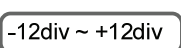
<p>MATH</p> 		Math on/off Math 
<p>Operation</p> <p style="text-align: center;">+</p>	  	Select math operation type (+/-) Operation 
<p>CH1+CH2</p>	 	Select addition/subtraction CH1+/-CH2 
<p>Position</p> <p>0.00 Div</p>	 	Set result position Position → VAR 
<p>Unit/Div</p> <p>2V</p>	 	Math result Volt/Div Unit/Div → VAR 

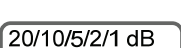
Math key 2/2

<p>MATH</p> 		Math on/off Math 
<p>Operation</p> <p style="text-align: center;">FFT</p>	  	Select math operation type (FFT) Operation 
<p>Source</p> <p style="text-align: center;">CH1</p>	 	Select FFT source channel Source 
<p>Window</p> <p style="text-align: center;">Hanning</p>	 	Select FFT window Window 
<p>Position</p> <p>0.00 Div</p>	 	Select FFT result position Position → VAR 
<p>Unit/Div</p> <p style="text-align: center;">1dB</p>	 	Select vertical scale Unit/Div 

Measure key

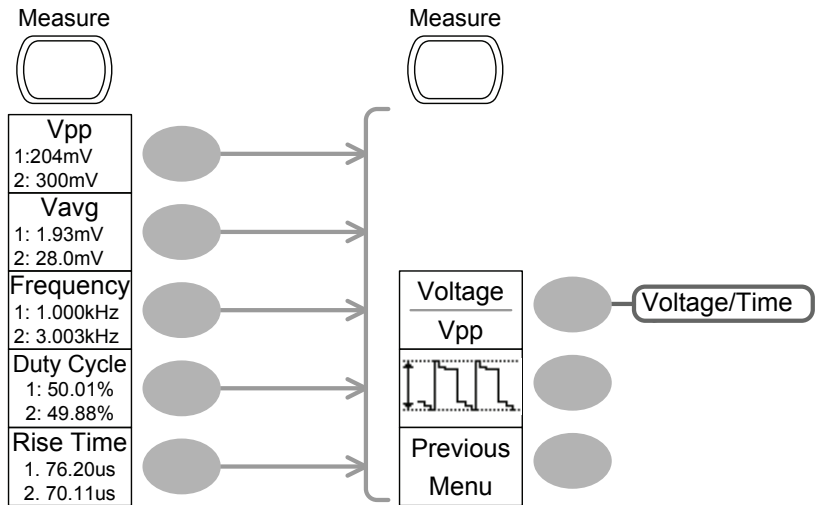

Turn on/off measurement	Measure
Select measurement type	Voltage/Time
Select measurement item	VAR or Icon
Go back to previous menu	Previous Menu

Run/Stop key

Run/Stop	Freeze/unfreeze waveform or trigger Run/Stop
----------	---

Save/Recall key 1/9

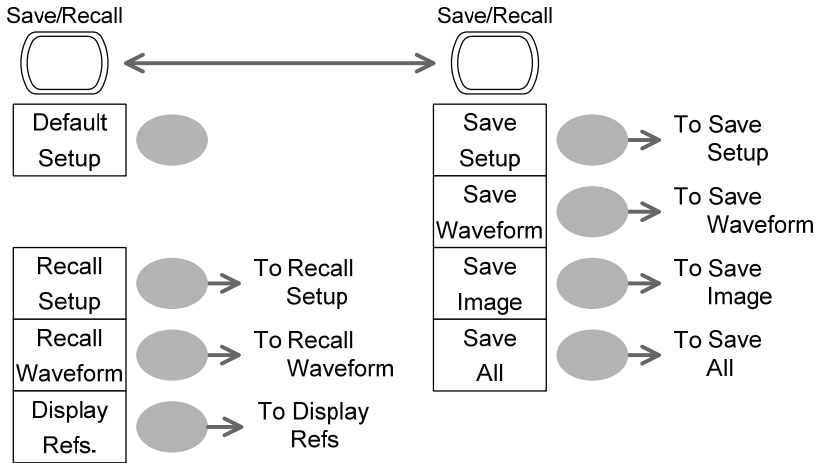

Switch to Save or Recall menu	Save/Recall
Recall default setup	Default Setup

Save/Recall key 2/9

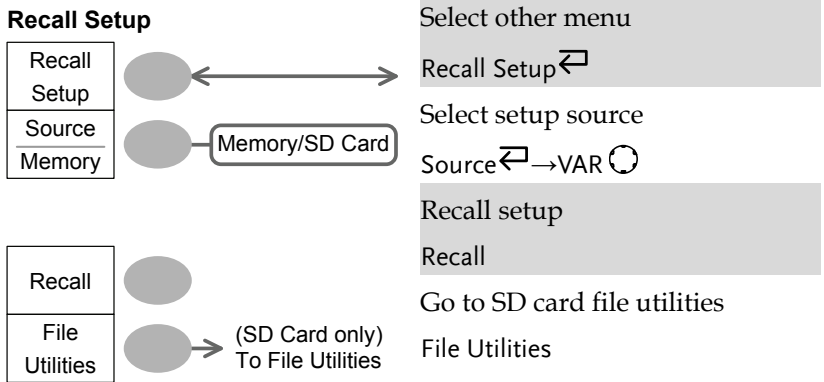

Save/Recall key 3/9

Recall Waveform

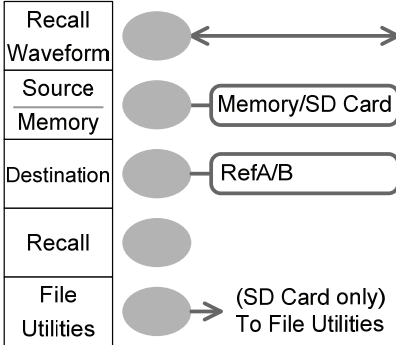

- Select other menu
- Recall Waveform
- Select waveform source
- Source → VAR
- Select waveform destination
- Destination → VAR
- Recall waveform
- Recall
- Go to SD card file utilities
- File Utilities

Save/Recall key 4/9

Display Refs.

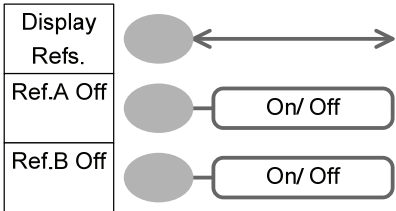

- Select other menu
- Display Refs.
- Turn ref. waveform A on/off
- Ref.A
- Turn ref. waveform B on/off
- Ref.B

Save/Recall key 5/9

Save Setup

Save Setup



Select other menu

Save Setup \leftarrow

Select destination

Destination \leftarrow → VAR \odot

Destination
Memory
Save
File Utilities

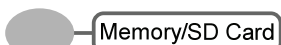

Save setup

Save

Go to SD card file utilities



File Utilities

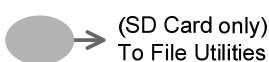

Save/Recall key 6/9

Save Waveform

Save Waveform



Select other menu

Save Waveform \leftarrow

Source

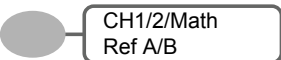

Select source

Source \leftarrow → VAR \odot

Destination
Memory

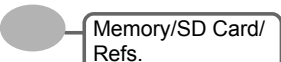

Select destination

Destination \leftarrow → VAR \odot

Save



Save waveform

Save

File Utilities

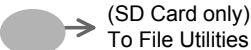

Go to SD card file utilities

File Utilities

Save/Recall key 7/9

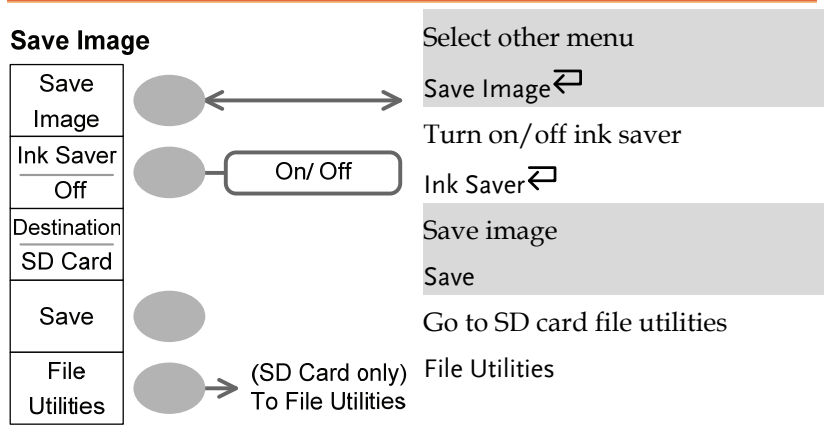

Save/Recall key 8/9

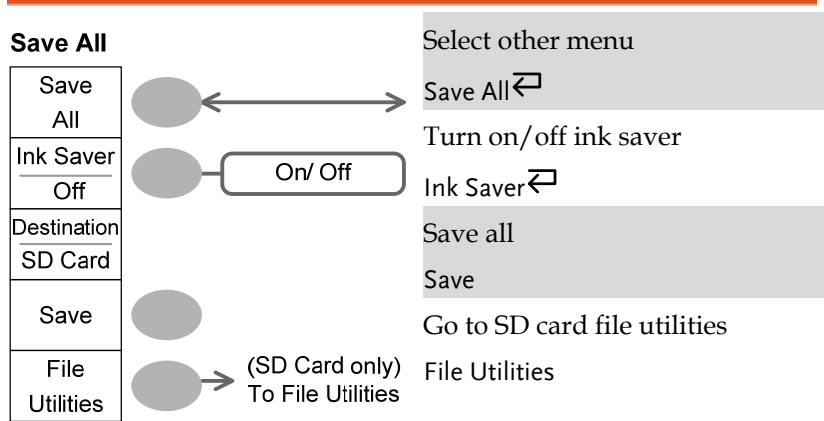

Save/Recall key 9/9

File Utilities

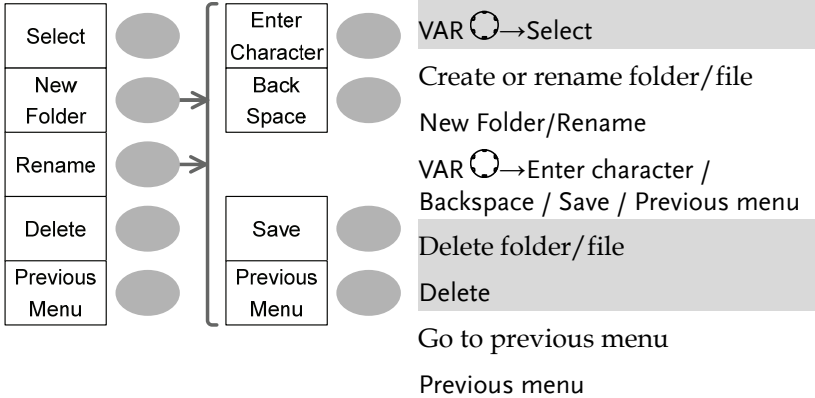

Trigger key 1/4

Video Trigger

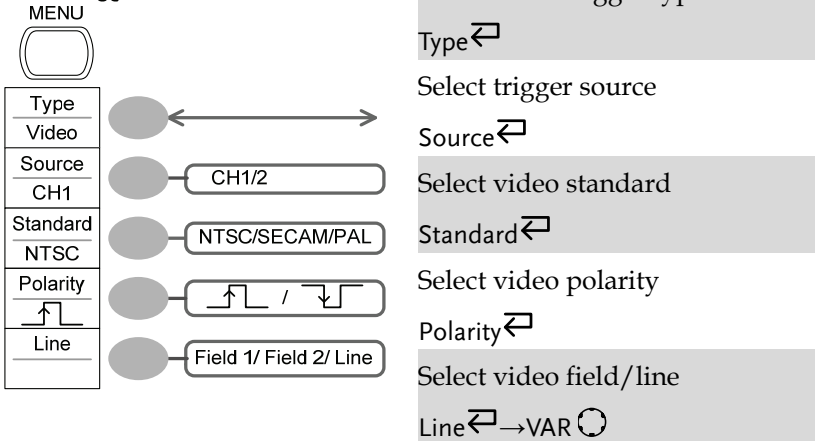

Trigger key 2/4

Edge Trigger

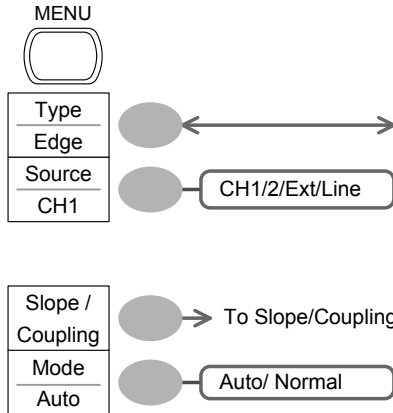

- Select edge trigger type
Edge ↵
- Select trigger source
Source ↵
- Go to slope/coupling menu (page32)
Slope/Coupling
- Select trigger mode
Mode ↵

Trigger key 3/4

Pulse Trigger

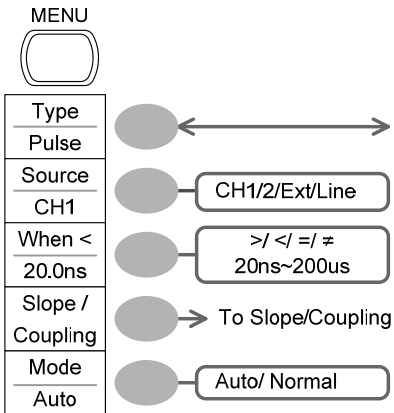

- Select pulse trigger type
Type ↵
- Select trigger source
Source ↵
- Select pulse trigger condition and pulse width
When ↵ → VAR ○
- Go to slope/coupling menu (page32)
Slope/Coupling
- Select trigger mode
Mode ↵

Trigger key 4/4

Coupling/Slope

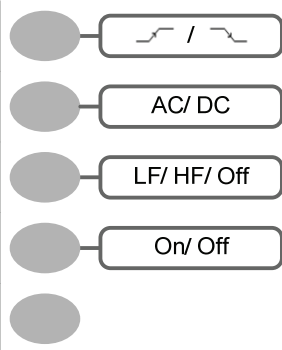
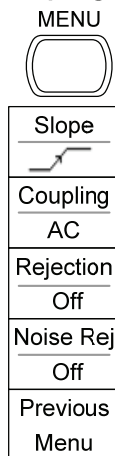

- Select trigger slope type
Slope
- Select trigger coupling mode
Coupling
- Select frequency rejection
Rejection
- Turn noise rejection on/off
Noise Rej
- Go back to previous menu
Previous Menu

Utility key 1/4

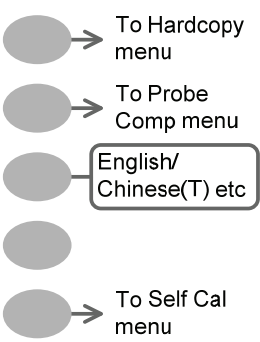
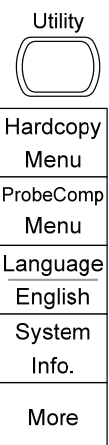

- Go to hardcopy menu
Hardcopy
- Go to probe compensation menu
ProbeComp
- Select language
Language
- Show system information
System Info.
- Go to self calibration menu
More

Utility key 2/4

Calibration

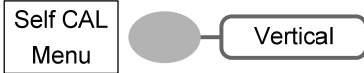

Enter self calibration

Self CAL

Go to previous menu

Previous Menu

Utility key 3/4

Hardcopy

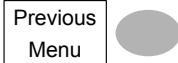
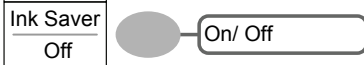
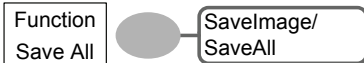

Select Hardcopy function

Function ↵

Turn on/off inksaver

Ink Saver ↵

Go to previous menu

Previous Menu ↵

Utility key 4/4

Probe compensation

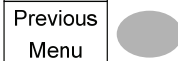
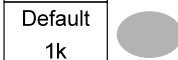

Select probe compensation signal

Wave Type ↵

Set frequency for square wave

Frequency → VAR ⌚

Set duty cycle for square wave

Duty Cycle → VAR ⌚

Go to previous menu

Previous Menu

Default Settings

Here are the factory installed panel settings which appear when pressing the Save/Recall key → *Default Setup*.

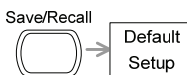

Acquisition	Mode: Normal	
Channel	Scale: 2V/Div	Invert: Off
	Coupling: DC	Probe attenuation: x1
	BW limit: Off	Channel 1 & 2: On
	(GDS-1102, GDS-1062)	
Cursor	Source: CH1	Cursor: Off
Display	Type: Vectors	Accumulate: Off
	Grid:	
Horizontal	Scale: 2.5us/Div	Mode: Main Timebase
Math	Type: + (Add)	Position: 0.00 Div
Measure	Item: Vpp, Vavg, Frequency, Duty Cycle, Rise Time	
Trigger	Type: Edge	Source: Channel1
	Mode: Auto	Slope:
	Coupling: DC	Rejection: Off
	Noise Rejection: Off	
Utility	Hardcopy: SaveImage, InkSaver Off	ProbeComp: Square wave, 1k, 50% duty cycle

Built-in Help

The Help key shows the contents of the built-in help support. When you press a function key, its descriptions appear in the display.



Applicable keys

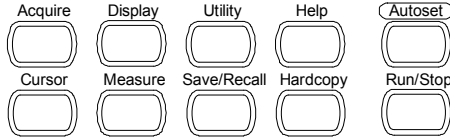

(Vertical)

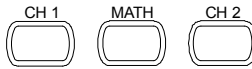

(Horizontal) (Trigger)

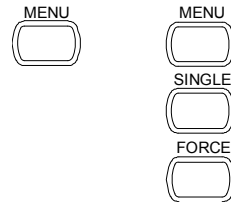

Procedure

1. Press the Help key. The display changes to the Help mode.



2. Press a functional key to access its help contents. (example: Acquire key)



3. Use the Variable knob to scroll the Help contents up and down.



4. Press the Help key again to exit the Help mode.



M EASUREMENT

The Measurement chapter describes how to properly observe a signal using the oscilloscope's basic functions, and how to observe a signal in a detailed manner using some of the advanced functions such as :

Automatic measurements, cursor measurements, and math operations.

Basic Measurements

This section describes the basic operations required in capturing and viewing an input signal. For more detailed operations, see the following chapters.

- Measurements → from page36
- Configurations → from page52

Activating a channel

Activating a channel

To activate an input channel, press the Channel key, CH1 or CH2. The channel indicator appears at the left side of the display and the channel icon changes accordingly.

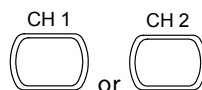

(Continued on next page)

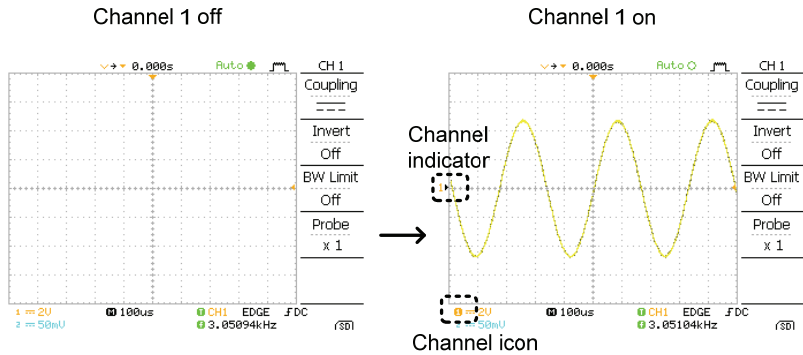

De-activating a channel

To de-activate the channel, press the Channel key twice (once if the channel menu is already selected).

Using the Autoset

Background

Autoset function automatically configures the panel settings to the best viewing conditions, in the following way.

- Selecting the horizontal scale
- Positioning the waveform horizontally
- Selecting the vertical scale
- Positioning the waveform vertically
- Selecting the trigger source channel
- Activating the channels

Procedure

1. Connect the input signal to the oscilloscope and press the Autoset key.
2. The waveform appears in the center of the display.



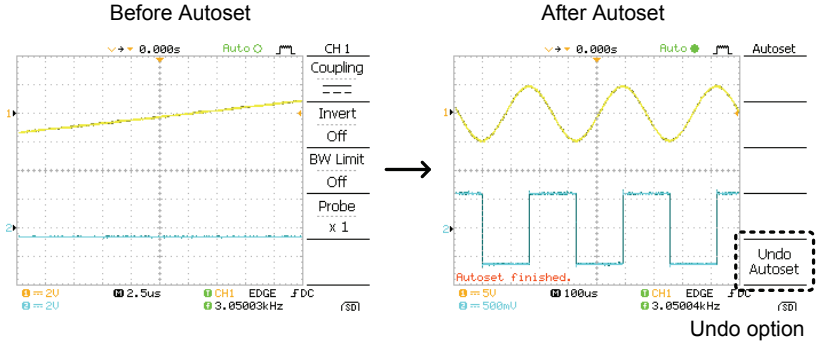

Undoing the Autoset To undo the Autoset, press *Undo* (available for 5 seconds).  

Adjusting the trigger level If the waveform is still unstable, try adjusting the trigger level up or down by using the Trigger Level knob. 

Limitation Autoset does not work in the following situation.

- Input signal frequency less than 20Hz
- Input signal amplitude less than 30mV

Running and stopping the trigger

Background In the trigger Run mode, the oscilloscope constantly searches for a trigger condition and updates the signal into the display when the condition is met.

In the trigger Stop mode, the oscilloscope stops triggering and thus the last acquired waveforms stay in the display. The trigger icon at the top of the display changes into Stop mode.

Pressing the Trigger Run/Stop key  switches between the Run and Stop mode.

(Continued on next page)

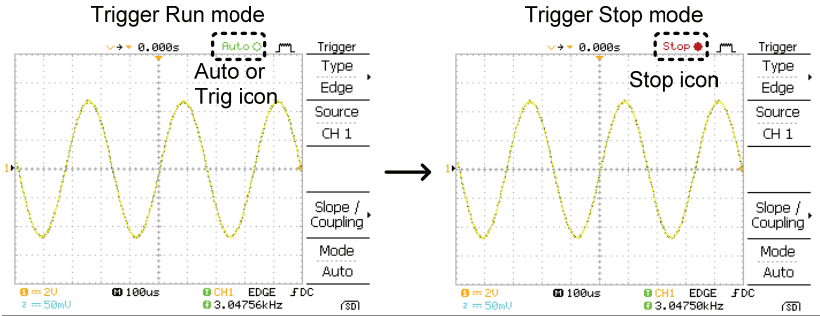

Waveform operation

Waveforms can be moved or scaled in both the Run and Stop mode. For details, see page57 (Horizontal position/scale) and page61 (Vertical position/scale).

Changing the horizontal position and scale

For more detailed configurations, see page57.

Setting the horizontal position

The horizontal position knob moves the waveform left or right.

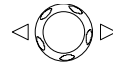

The position indicator moves along with the waveform and the distance from the center point is displayed as the offset in the upper side of the display.

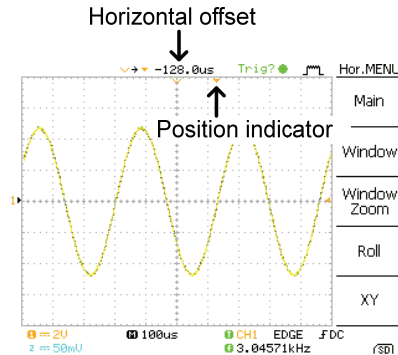

Selecting the horizontal scale

To select the timebase (scale), turn the TIME/DIV knob; left (slow) or right (fast).



Range 1ns/Div ~ 10s/Div, 1-2.5-5 increment

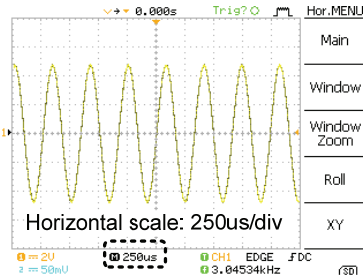
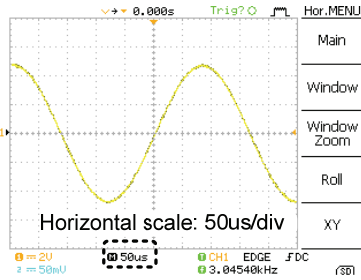

Changing the vertical position and scale

For more detailed configuration, see page61.

Set vertical position

To move the waveform up or down, turn the vertical position knob for each channel.



As the waveform moves, the vertical position of the cursor appears at the bottom left corner of the display.

Run/Stop mode The waveform can be moved vertically in both Run and Stop mode.

Select vertical scale

To change the vertical scale, turn the VOLTS/DIV knob; left (down) or right (up).



Range 2mV/Div ~ 5V/Div, 1-2-5 increments

The vertical scale indicator for each channel on the bottom left of the display changes accordingly.

Stop mode In Stop mode, the vertical scale setting can be changed but the waveform shape stays the same.

Using the probe compensation signal

Background This section introduces how to use the probe compensation signal for general usage, in case the DUT signal is not available or to get a second signal for comparison. For probe compensation details, see page94.



Note that the frequency accuracy and duty factor are not guaranteed. Therefore the signal should not be used for reference purpose.

Waveform type



Square waveform used for probe compensation. 1k ~ 100kHz, 5% ~ 95%.



Demonstration signal for showing the effects of peak detection. See page52 for peak detection mode details.

View the probe compensation waveform

1. Connect the probe between the compensation signal output and Channel input.

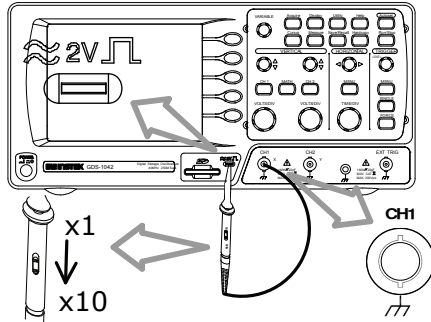

2. Press the Utility key.



3. Press *ProbeComp*.



4. Press Wave type repeatedly to select the wave type.

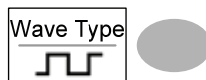

5. (For \square only) To change the frequency, press *Frequency* and use the Variable knob.

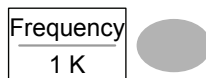

VARIABLE



Range 1kHz ~ 100kHz

6. (For \square only) To change the duty cycle, press *Duty Cycle* and use the Variable knob.

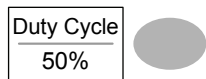

VARIABLE



Range 5% ~ 95%

Probe compensation















For probe compensation details, see page94.

Automatic Measurements

Automatic measurement function measures input signal attributes and updates them in the display.

Measurement items

Overview	Voltage type	Time type
	Vpp	Frequency
	Vmax	Period
	Vmin	RiseTime
	Vamp	FallTime
	Vhi	+Width
	Vlo	-Width
	Vavg	Dutycycle
	Vrms	
	ROVShoot	
	FOVShoot	
	RPREShoot	
	FPREShoot	
Voltage measurement items	Vpp	Difference between positive and negative peak voltage (=Vmax - Vmin)
	Vmax	Positive peak voltage.
	Vmin	Negative peak voltage.
	Vamp	Difference between global high and global low voltage (=Vhi - Vlo)
	Vhi	Global high voltage.

	Vlo		Global low voltage.
	Vavg		Averaged voltage of the first cycle.
	Vrms		RMS (root mean square) voltage.
	ROVShoot		Rise overshoot voltage.
	FOVShoot		Fall overshoot voltage.
	RPREShoot		Rise preshoot voltage.
	FPREShoot		Fall preshoot voltage.
Time measurement items	Freq		Frequency of the waveform.
	Period		Waveform cycle time (=1/Freq).
	Risetime		Rising time of the pulse (~90%).
	Falltime		Falling time of the pulse (~10%).
	+Width		Positive pulse width.
	-Width		Negative pulse width.
	Duty Cycle		Ratio of signal pulse compared with whole cycle =100x (Pulse Width/Cycle)

Automatically measuring the input signals

Viewing the measurement result

1. Press the Measure key.



2. The measurement results appear on the menu bar, constantly updated. Press the menu to change its measurement item.

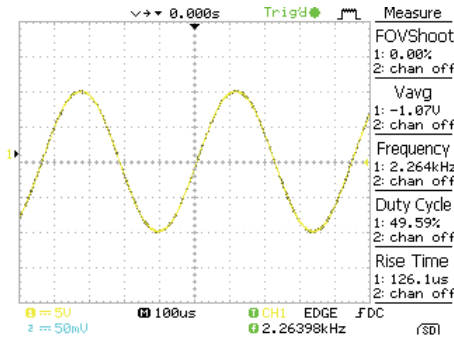

Selecting a measurement item

1. Press F3 repeatedly to select the measurement type: *Voltage* or *Time*.

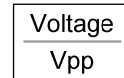

2. Use the Variable knob to select the measurement item.

VARIABLE

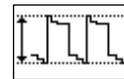

3. Press *Previous Menu* to confirm the item selection and to go back to the measurement results view.

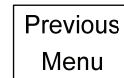

Cursor Measurements

Cursor line, horizontal or vertical, shows the precise position of the input waveforms or the math operation results. The horizontal cursor can track time, voltage and frequency, whilst the vertical cursor can track voltage.

Using the horizontal cursors

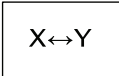
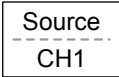
Procedure	<ol style="list-style-type: none"> Press the Cursor key. The cursors appear in the display.  Press $X \leftrightarrow Y$ to select the horizontal (X1&X2) cursor.  Press <i>Source</i> repeatedly to select the source channel.  <p style="margin-left: 40px;">Range CH1, 2, Math</p> The cursor measurement results will appear in the menu, F2 to F4.
-----------	---

Parameters	<table border="0"> <tr> <td style="padding-right: 20px;">X1</td> <td>Time/Voltage position of the left cursor. (relative to zero)</td> </tr> <tr> <td>X2</td> <td>Time/Voltage position of the right cursor. (relative to zero)</td> </tr> <tr> <td>X1X2</td> <td>The distance between the X1 and X2.</td> </tr> <tr> <td>-uS</td> <td>The time difference between X1 and X2.</td> </tr> <tr> <td>-Hz</td> <td>The time distance converted to frequency.</td> </tr> <tr> <td>-V</td> <td>The voltage difference. (X1-X2)</td> </tr> </table>	X1	Time/Voltage position of the left cursor. (relative to zero)	X2	Time/Voltage position of the right cursor. (relative to zero)	X1X2	The distance between the X1 and X2.	-uS	The time difference between X1 and X2.	-Hz	The time distance converted to frequency.	-V	The voltage difference. (X1-X2)
X1	Time/Voltage position of the left cursor. (relative to zero)												
X2	Time/Voltage position of the right cursor. (relative to zero)												
X1X2	The distance between the X1 and X2.												
-uS	The time difference between X1 and X2.												
-Hz	The time distance converted to frequency.												
-V	The voltage difference. (X1-X2)												

Moving the horizontal cursors	<p>To move the left cursor, press X1 and then use the Variable knob. </p>
-------------------------------	--

To move the right cursor, press X2 and then use the Variable knob.

X2 22.9us 0.000V



To move both cursors at once, press X1X2 and then use the Variable knob.

X1X2 23.6us 11.9Hz 212.0mV

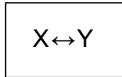
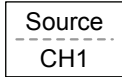

Using the vertical cursors

- | | | |
|-----------|---|---|
| Procedure | 5. Press the Cursor key. |  |
| | 6. Press X↔Y to select the vertical (Y1&Y2) cursor. |  |
| | 7. Press <i>Source</i> repeatedly to select the source channel. |  |
| | Range CH1, 2, Math | |
| | 8. The cursor measurement results will appear in the menu. | |

Parameters	Y1	Voltage level of the upper cursor
	Y2	Voltage level of the lower cursor
	Y1Y2	The voltage difference between the upper and lower cursor

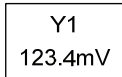
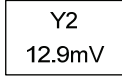
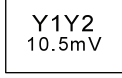
- | | | |
|-----------------------------|--|---|
| Moving the vertical cursors | To move the upper cursor, press Y1 and then use the Variable knob. |  |
| | To move the lower cursor, press Y2 and then use the Variable knob. |  |
| | To move both cursors at once, press Y1Y2 and then use the Variable knob. |  |







Math Operations

The Math operations can add, subtract, or perform FFT on the input waveforms. The resulted waveform can be measured using the cursors, and saved or recalled just like normal input signals.

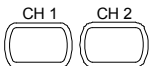
Overview

Addition (+)	Adds amplitude of CH1 & CH2 signals.		
Subtraction (-)	Extracts the amplitude difference between CH1 & CH2.		
FFT	Runs FFT calculation on a signal. Four types of FFT windows are available: Hanning, Flattop, Rectangular, and Blackman.		
Hanning FFT window	Frequency resolution	Good	
	Amplitude resolution	Not good	
	Suitable for....	Frequency measurement on periodic waveforms	
Flattop FFT window	Frequency resolution	Not good	
	Amplitude resolution	Good	
	Suitable for....	Amplitude measurement on periodic waveforms	
Rectangular FFT window	Frequency resolution	Very good	
	Amplitude resolution	Bad	
	Suitable for....	Single-shot phenomenon (this mode is the same as having no window at all)	
Blackman FFT window	Frequency resolution	Bad	
	Amplitude resolution	Very good	
	Suitable for....	Amplitude measurement on periodic waveforms	

Adding or subtracting signals

- | | | |
|-----------|---|---|
| Procedure | <ol style="list-style-type: none"> 1. Activate both CH1 and CH2. |  |
| | <ol style="list-style-type: none"> 2. Press the Math key. |  |
| | <ol style="list-style-type: none"> 3. Press <i>Operation</i> repeatedly to select addition (+) or subtraction (-). |  |
| | <ol style="list-style-type: none"> 4. The math measurement result appears in the display. |  |
| | <ol style="list-style-type: none"> 5. To move the math result vertically, press <i>Position</i> and use the Variable knob. |  |
| | | <p>VARIABLE</p>  |
| | <ol style="list-style-type: none"> 6. To clear the math result from the display, press the Math key again. |  |

Using the FFT function

Procedure

1. Press the Math key.



2. Press *Operation* repeatedly to select FFT.

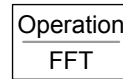

3. Press *Source* repeatedly to select the source channel.

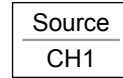

4. Press *Window* repeatedly to select the FFT window type.

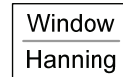

5. The FFT result appears. The horizontal scale changes from time to frequency, and the vertical scale from voltage to dB.

6. To move the FFT waveform vertically, press *Position* and use the Variable knob.

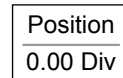

VARIABLE



Range -12.00 Div ~ +12.00 Div

7. To select the vertical scale of FFT waveform, press *Unit/Div* repeatedly.

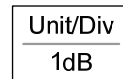

Range 1, 2, 5, 10, 20 dB/Div

8. To clear the FFT result from the display, press the Math key again.



C ONFIGURATION

The Configuration chapter describes how to configure panel settings to make measurements and observations suited to the application needs.

Acquisition

The acquisition process samples the analog input signals and converts them into digital format for internal processing. You may select the normal, average, or peak detect acquisition mode.

Selecting the acquisition mode

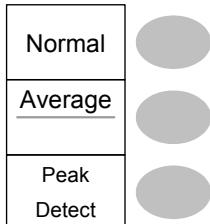
Procedure	<ol style="list-style-type: none"> 1. Press the Acquire key. 	
	<ol style="list-style-type: none"> 2. Select the acquisition mode between <i>Normal</i>, <i>Average</i> and <i>Peak Detect</i>. 	

Range	Normal	All of the acquired data is used to draw the waveform.
-------	--------	--

- Average Multiple data are averaged to form a waveform. This mode is useful for drawing a noise-free waveform. To select the number, press *Average* repeatedly.
Average number: 2, 4, 8, 16, 32, 64, 128, 256
- Peak detect To activate the Peak detect mode, press *Peak-Detect*. Only the minimum and maximum value pairs for each acquisition interval (bucket) are used. This mode is useful for catching abnormal glitches in the signal.

Peak detect effect using the probe comp. waveform

1. One of the probe compensation waveforms can demonstrate the peak detection mode. Connect the probe to the probe compensation output.



2. Press the Utility key.



3. Press *ProbeComp*.

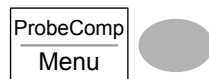

4. Press *Wave Type* and select the waveform.



5. Press the Autoset key. the oscilloscope positions the waveform in the center of the display.



6. Press the Acquire key.



7. Press *Normal*.



8. Press *Peak-Detect* and see that a spike noise is captured.

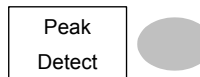

Example

The peak detect mode reveals the occasional glitch.

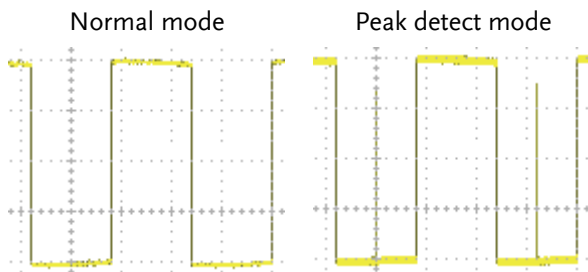

Real time vs Equivalent time sampling mode

Backgrounds The oscilloscope automatically switches between two sampling modes, Real-time and Equivalent-time, according to the number of active channels and sampling rate.



Real-time sampling One sampled data is used to reconstruct a single waveform. Short-time events might get lost if the sampling rate gets too high. This mode is used when the sampling rate is relatively low (250MSa/s or lower).

Equivalent-time sampling Multiple numbers of sampled data are accumulated to reconstruct a single waveform. Restores greater waveform details but takes longer to update the waveform. This mode is used when the sampling rate becomes higher than 250MSa/s. The maximum equivalent-time sampling rate is 25GSa/s.



Display

The Display section describes how to configure the display settings: drawing type, waveform accumulation, contrast adjustment, and grid settings.

Selecting the vector or dot drawing

Procedure	1. Press the Display key.	
	2. Press <i>Type</i> repeatedly to select the waveform drawing.	
Types	Dots	Only the sampled dots are displayed.
	Vectors	The sampled dots are connected by lines.

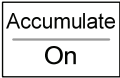
Accumulating the waveform



Background	Accumulation preserves the old waveform drawings and overwrites new waveforms on top of it. It is useful for observing waveform variation.	
Procedure	1. Press the Display key.	
	2. Press <i>Accumulate</i> to turn on the waveform accumulation.	
	3. To clear the accumulation and start it over (refresh), press <i>Refresh</i> .	

(Continued on next page)

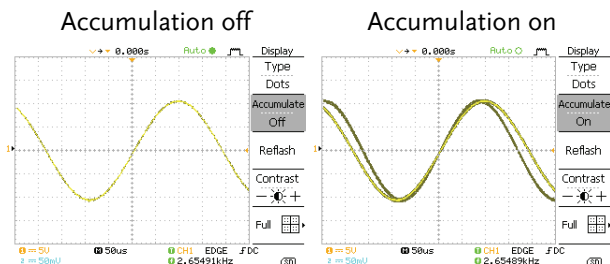

Example

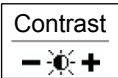



Adjusting the display contrast

- Procedure**
1. Press the Display key. 
 2. Press *Contrast*. 
 3. Turn the Variable knob left to lower the contrast (dark display) or right to raise the contrast (bright display). 

Selecting the display grid

- Procedure**
1. Press the Display key. 
 2. Press the grid icon repeatedly to select the grid. 

- Parameters**
-  Shows the full grid.
 -  Shows the outer frame and X/Y axis.
 -  Shows only the outer frame.

Horizontal View

The Horizontal view section describes how to configure the horizontal scale, position, waveform update mode, window zoom, and X-Y mode.

Moving the waveform position horizontally

Procedure The horizontal position knob moves the waveform left or right. The position indicator at the top of the display shows the center and current position.

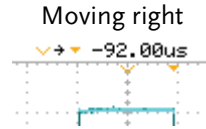
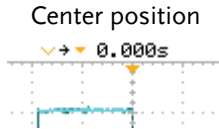
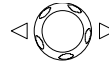

Selecting the horizontal scale

Select horizontal scale To select the timebase (scale), turn the TIME/DIV knob; left (slow) or right (fast).

TIME/DIV





Range 1ns/Div ~ 10s/Div, 1-2.5-5 increment

The timebase indicator at the bottom of the display updates the current horizontal scale.

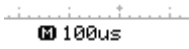

Selecting the waveform update mode

Background	The display update mode is switched automatically or manually according to the horizontal scale.	
Main mode	Updates the whole displayed waveform at once. The main mode is automatically selected when the horizontal scale (timebase) is fast. Horizontal scale $\leq 100\text{ms}/\text{div}$ Trigger All mode available	
Roll mode	Updates and moves the waveform gradually from the right side of the display to the left. The Roll mode is automatically selected when the horizontal scale (timebase). When in the Roll mode, an indicator appears at the bottom of the display. <div style="display: flex; justify-content: space-around; align-items: center;"> <div style="text-align: center;"> <p>Main mode</p>  <p>100us</p> </div> <div style="text-align: center;"> <p>Roll mode</p>  <p>250ms ROLL</p> </div> </div> Timebase $\geq 250\text{ms}/\text{div}$ ($\leq 100\text{Sa}/\text{s}$) Trigger Auto mode only	

Selecting the Roll mode manually

1. Press the Horizontal menu key.



2. Press *Roll*. The horizontal scale automatically becomes 250ms/div and the waveform starts scrolling from the right side of the display (If the oscilloscope is already in the Roll mode, there will be no change).

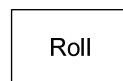

Zooming the waveform horizontally

Procedure/ range 1. Press the Horizontal Menu key.



2. Press *Window*.



3. Use the horizontal position knob to move the zoom range sideways, and TIME/DIV knob to change the zoom range width.

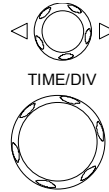

The width of the bar in the middle of the display is the actual zoomed area.

Zoom range 1ns ~ 1ms

4. Press *Window Zoom*. The specified range gets zoomed.

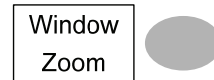

Example

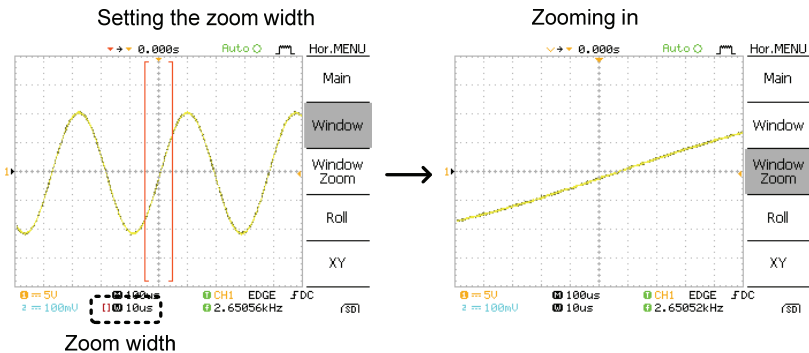

Viewing waveforms in the X-Y mode

Background The X-Y mode compares the voltage of Channel 1 and Channel 2 waveforms in a single display. This mode is useful for observing the phase relationship between the two waveforms.

Procedure

1. Connect the signals to Channel 1 (X-axis) and Channel 2 (Y-axis).
2. Make sure both Channel 1 and 2 are activated.
3. Press the Horizontal key.
4. Press XY. The display shows two waveforms in X-Y format; Channel 1 as X-axis, Channel 2 as Y-axis.

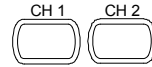
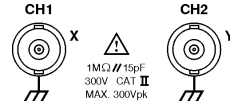

Adjusting the X-Y mode waveform

- | | |
|---------------------|--------------------|
| Horizontal position | CH1 Position knob |
| Horizontal scale | CH1 Volts/Div knob |
| Vertical position | CH2 Position knob |
| Vertical scale | CH2 Volts/Div knob |

Example

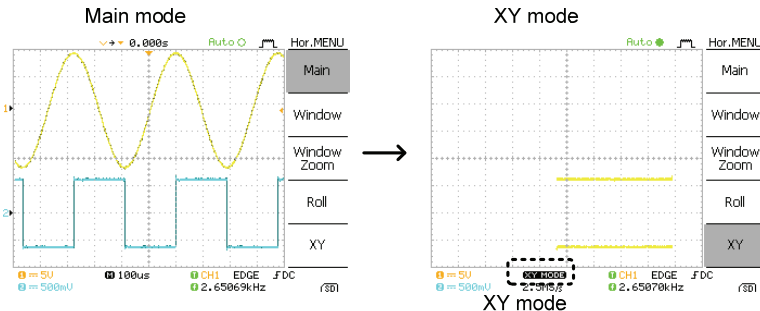

Vertical View (Channel)

The Vertical view section describes how to set the vertical scale, position, bandwidth limitation, coupling mode, and attenuation.

Moving the waveform position vertically

Procedure To move the waveform up or down, turn the vertical position knob for each channel. 



Selecting the vertical scale

Procedure To change the vertical scale, turn the VOLTS/DIV knob; left (down) or right (up). 

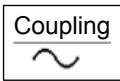

Range 2mV/Div ~ 5V/Div, 1-2-5 increments

Selecting the coupling mode

Procedure

1. Press the Channel key. 
2. Press *Coupling* repeatedly to select the coupling mode.  

Range

	<p>DC coupling mode. The whole portion (AC and DC) of the signal appears on the display.</p>
	<p>Ground coupling mode. The display shows only the zero voltage level as a horizontal line. This mode is useful for measuring the signal amplitude with respect to the ground level.</p>



AC coupling mode. Only the AC portion of the signal appears on the display. This mode is useful for observing AC waveforms mixed with DC signal.

Inverting the waveform vertically

Procedure

1. Press the Channel key.



2. Press *Invert*. The waveform becomes inverted (upside down) and the Channel indicator in the display shows a down arrow.

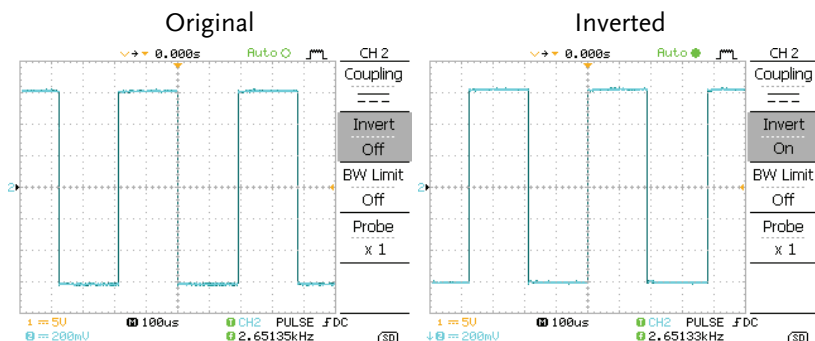
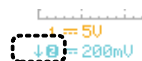
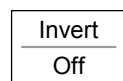

Limiting the waveform bandwidth

Background

Bandwidth limitation puts the input signal into a 20MHz (-3dB) low-pass filter. This function is useful for cutting off high frequency noise to see the clear waveform shape. This function is available only for GDS-1102 and GDS-1062.

Procedure

1. Press the Channel key.



2. Press *BW Limit* to turn on or off the limitation. When turned on, the BW indicator appears next to the Channel indicator in the display.

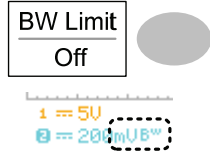

Example

BW Limit Off

BW Limit On

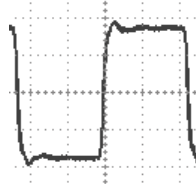
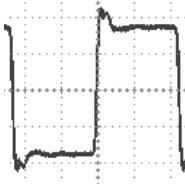

Selecting the probe attenuation level

Background

A signal probe has an attenuation switch to lower the original DUT signal level to the oscilloscope input range, if necessary. The probe attenuation selection adjusts the vertical scale so that the voltage level on the display reflects the real value, not the attenuated level.

Procedure

1. Press the Channel key.



2. Press *Probe* repeatedly to select the attenuation level.

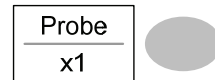

3. The voltage scale in the channel indicator changes accordingly. There is no change in the waveform shape.

Range

x1, x10, x100

Note

The attenuation factor adds no influence on the real signal; it only changes the voltage scale on the display.

Trigger

The Trigger function configures the conditions by which the oscilloscope captures the incoming signals.

Trigger type

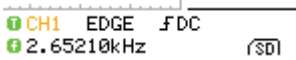
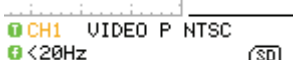
Edge	Triggers when the signal crosses an amplitude threshold in either positive or negative slope.	
Video	Extracts a sync pulse from a video format signal and triggers on a specific line or field.	
Pulse	Triggers when the pulse width of the signal matches the trigger settings.	
Indicators	<p style="text-align: center;">Edge/Pulse</p>  <p>(CH1, Edge, Rising edge, DC coupling)</p>	<p style="text-align: center;">Video</p>  <p>(CH1, Video, Positive polarity, NTSC standard)</p>

Trigger parameter

Trigger source	CH1, 2	Channel 1, 2 input signals
	Line	AC mains signal
	Ext	External trigger input signal
Trigger mode	Auto	The oscilloscope updates the input signal regardless of the trigger conditions (if there is no trigger event, the oscilloscope generates an internal trigger). Select this mode especially when viewing rolling waveforms at a slow timebase.

The Auto trigger status appears in the upper right corner of the display.

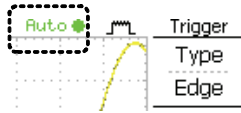

Single The oscilloscope acquires the input signals once when a trigger event occurs, then stops acquiring. Pressing the Single key triggers on the input signals again.





The Single trigger status appears in the upper right corner of the display.





Normal The oscilloscope acquires and updates the input signals only when a trigger event occurs.







The Normal trigger status appears in the upper right corner of the display.

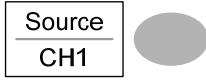
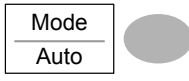

Video standard (video trigger)	NTSC	National Television System Committee
	PAL	Phase Alternative by Line
	SECAM	SEquential Couleur A Mémoire
Sync polarity (video trigger)		Positive polarity
		Negative polarity
Video line (video trigger)	Selects the trigger point in the video signal.	
	field	1 or 2
	line	1~263 for NTSC, 1~313 for PAL/SECAM
Pulse condition (pulse trigger)	Sets the pulse width (20ns ~ 200us) and the triggering condition.	

	>	Longer than	=	Equal to
	<	Shorter than	≠	Not equal to
Trigger slope		Triggers on the rising edge.		
		Triggers on the falling edge.		
Trigger coupling	AC	Triggers only on AC component.		
	DC	Triggers on AC+DC component.		
Frequency rejection	LF	Puts a high-pass filter and rejects the frequency below 50kHz.		
	HF	Puts a low-pass filter and rejects the frequency above 50kHz.		
Noise rejection	Rejects noise signals.			
Trigger level		Using the trigger level knob moves the trigger point up or down.		

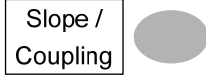
Configuring the edge trigger

- | | |
|-----------|---|
| Procedure | <ol style="list-style-type: none"> 1. Press the Trigger menu key. 
 2. Press <i>Type</i> repeatedly to select edge trigger. 
 3. Press <i>Source</i> repeatedly to select the trigger source. 
 <div style="margin-left: 40px;">Range Channel 1, 2, Line, Ext</div>
 4. Press <i>Mode</i> repeatedly to select the Auto or Normal trigger mode. To select the Single trigger mode, press the Single key. 
 
 <div style="margin-left: 40px;">Range Auto, Normal, Single</div>
 5. Press <i>Slope/coupling</i> to enter into the trigger slope and coupling selection menu. 
 6. Press <i>Slope</i> repeatedly to select the trigger slope, rising or falling edge. 
 <div style="margin-left: 40px;">Range Rising edge, falling edge</div>
 7. Press <i>Coupling</i> repeatedly to select the trigger coupling, DC or AC. 
 <div style="margin-left: 40px;">Range DC, AC</div> |
|-----------|---|

- 8. Press *Rejection* to select the frequency rejection mode.

Rejection
Off

 Range LF, HF, Off

- 9. Press *Noise Rej* to turn the noise rejection on or off.

Noise Rej
Off

 Range On, Off

- 10. Press *Previous* menu to go back to the previous menu.

Previous
Menu

Configuring the video trigger

- Procedure
- 1. Press the Trigger menu key.
 

 - 2. Press *Type* repeatedly to select video trigger. The video trigger indicator appears at the bottom of the display.

Type
Video

 - 3. Press *Source* repeatedly to select the trigger source channel.

Source
CH1

 Range Channel 1, 2

 - 4. Press *Standard* repeatedly to select the video standard.

Standard
NTSC

 Range NTSC, PAL, SECAM

 - 5. Press *Polarity* repeatedly to select the video signal polarity.

Polarity

Range positive, negative

6. Press *Line* repeatedly to select the video field line. Use the Variable knob to select the video line.

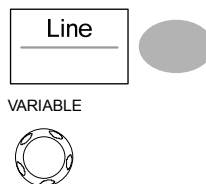

Field 1, 2

Video line NTSC: 1 ~ 262 (Even), 1 ~ 263 (Odd)
 PAL/SECAM: 1 ~ 312 (Even),
 1 ~ 313 (Odd)

Configuring the pulse width trigger

Procedure

1. Press the Trigger menu key.



2. Press *Type* repeatedly to select pulse width trigger. The pulse width trigger indicator appears at the bottom of the display.

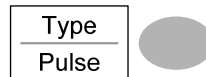

3. Press *Source* repeatedly to select the trigger source.

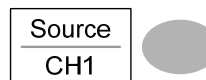

Range Channel 1, 2, Ext

4. Press *Mode* repeatedly to select the trigger mode, Auto or Normal. To select the Single trigger mode, press the Single key.

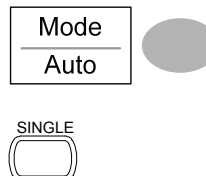

Range Auto, Normal, Single

5. Press *When* repeatedly to select the pulse condition. Then use the Variable knob to set the pulse width.

When <
20.0ns

Condition >, <, =, ≠

Width 20ns ~ 200us

VARIABLE

6. Press *Slope/Coupling* to set trigger slope and coupling.

Slope /
Coupling

7. Press *Slope* repeatedly to select the trigger slope, which also appears at the bottom of the display.

Slope

Range Rising edge, falling edge

8. Press *Coupling* repeatedly to select the trigger coupling.

Coupling
AC

Range DC, AC

9. Press *Rejection* to select the frequency rejection mode.

Rejection
Off

Range LF, HF, Off

10. Press *Noise Rej* to turn the noise rejection on or off.

Noise Rej
Off



Range On, Off

11. Press *Previous* menu to go back to the previous menu.

Previous
Menu

Manually triggering the signal

Note This section describes how to manually trigger the input signals when the oscilloscope does not capture them. This section applies to the Normal and Single trigger mode, since in the Auto trigger mode, the oscilloscope keeps updating the input signal regardless of the trigger conditions.

To acquire the signal regardless of trigger conditions	To acquire the input signal regardless of the trigger condition, press the Force key. The oscilloscope captures the signals once.	
In the Single trigger mode	Press the Single key to start waiting for the trigger condition. To break out of the Single mode, press the Run/Stop key. The trigger mode changes to the Normal mode.	 

Remote Control Interface

The Remote control interface section describes how to set up the USB interface for PC connection. The details of remote control commands are described in the GDS-1000 Programming Manual.

USB connection	PC side	Type A, host
	GDS-1000 side	Type B, slave
	Speed	1.1/2.0 (full speed)

Procedure

1. Connect the USB cable to the USB slave port.

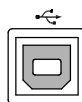



2. When the PC asks for the USB driver, select `dso_cdc_1000.inf` which is downloadable from the GW website, www.gwinstek.com, GDS-1000 product corner.
3. On the PC, activate a terminal application such as MTTY (Multi-Threaded TTY). To check the COM port No., see the Device Manager in the PC. For WindowsXP, select Control panel → System → Hardware tab.
4. Run this query command via the terminal application.
`*idn?`
 This command should return the manufacturer, model number, serial number, and firmware version in the following format.
 GW, GDS-1022, 000000001, V1.00
5. Configuring the command interface is completed. Refer to the programming manual for the remote commands and other details.

System Settings

The system settings show the oscilloscope’s system information and allow changing the language.

Viewing the system information

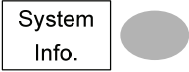
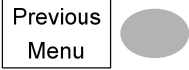
Procedure	<ol style="list-style-type: none"> 1. Press the Utility key. 	
	<ol style="list-style-type: none"> 2. Press <i>More</i>. 	
	<ol style="list-style-type: none"> 3. Press <i>System Info</i>. The upper half of the display shows the following information. <ul style="list-style-type: none"> • Manufacturer • Serial number • Model • Firmware version 	
	<ol style="list-style-type: none"> 4. Press any other key to go back to the waveform display mode. 	

Selecting the language

Parameter	<p>Language selection differs according to the region to which the oscilloscope is shipped.</p> <ul style="list-style-type: none"> • English • Chinese (simplified) • Chinese (traditional) • Others
-----------	--

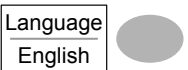
Procedure	<ol style="list-style-type: none"> 1. Press the Utility key. 	
	<ol style="list-style-type: none"> 2. Press <i>Language</i> repeatedly to select the language. 	

SAVE/RECALL

The save function allows saving display image, waveform data, and panel settings into the oscilloscope's internal memory or an external SD card. The recall function allows recalling the default factory settings, waveform data, and panel settings from the oscilloscope's internal memory or an external SD card.

File Structures

Three types of file are available: display image, waveform file, and panel settings.

Display image file format

Format	xxxx.bmp (Windows bitmap format)
Contents	The current display image in 234 x 320 pixels, color mode. The background color can be inverted (Ink saver function).

Waveform file format

Format	xxxx.csv (Comma-separated values format which can be opened in spreadsheet applications such as Microsoft Excel)	
Waveform type	CH1, 2	Input channel signal
	Math	Math operation result (page49)
Storage location	Internal memory	The oscilloscope's internal memory, which can hold 15 waveforms.

External SD card An SD card (2GB or less, FAT or FAT32 format) can hold practically unlimited number of waveforms.

Ref A, B The two reference waveforms are used as the buffer to recall a waveform in the display. You have to save a waveform into an internal memory or an SD card, then copy the waveform into the reference waveform slot (A or B), and then recall the reference waveform into the display.

Waveform data format

One division includes 25 points of horizontal and vertical data. The vertical point starts from the center line. The horizontal point starts from the leftmost waveform.

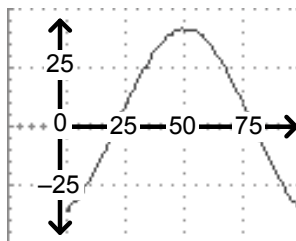

The time or amplitude represented by each data point depends on the vertical and horizontal scale. For example:

Vertical scale: 10mV/div (4mV per point)

Horizontal scale: 100us/div (4us per point)

Waveform file contents: other data







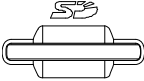

A waveform file also includes the following information.

- Memory length
- source channel
- vertical offset
- vertical scale
- coupling mode
- waveform last dot address
- date and time
- trigger level
- vertical position
- time base
- probe attenuation
- horizontal view
- horizontal scale
- sampling period
- sampling mode

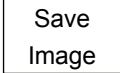
Setup file format

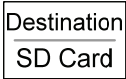
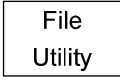
Format	xxxx.set (proprietary format)	
	A setup file saves or recalls the following settings.	
Contents	Acquire	<ul style="list-style-type: none"> • mode
	Cursor	<ul style="list-style-type: none"> • source channel • cursor on/off • cursor location
	Display	<ul style="list-style-type: none"> • dots/vectors • grid type • accumulation on/off
	Measure	<ul style="list-style-type: none"> • item
	Utility	<ul style="list-style-type: none"> • hardcopy type • ink saver on/off • language
	Horizontal	<ul style="list-style-type: none"> • display mode • position • scale
	Trigger	<ul style="list-style-type: none"> • trigger type • trigger mode • video polarity • pulse timing • source channel • video standard • video line • slope/coupling
	Channel (vertical)	<ul style="list-style-type: none"> • vertical scale • coupling mode • bandwidth limit on/off (GDS-1102, GDS-1062) • vertical position • invert on/off • probe attenuation
	Math	<ul style="list-style-type: none"> • operation type • vertical position • FFT window • source channel • unit/div

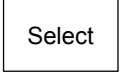
Using the SD card file utilities

Background	For the SD card inserted into the oscilloscope, file deletion, folder creation, file/folder rename are available from the front panel.	
SD Card restriction	The GDS-1000 series accept the following SD card. Size: 2GB or less Format: FAT or FAT32	
Procedure	<ol style="list-style-type: none"> 1. Insert an SD card to the card slot. 2. Press the Save/Recall key. Select any save or recall functionality, for example SD card destination in Save image function. 3. Press <i>File Utility</i>. The display shows the SD card contents. 4. Use the Variable knob to move the cursor. Press <i>Select</i> to go into the folder or go back to the previous directory level. 	  (Example)      VARIABLE   

SD card indicator When an SD card is inserted into the oscilloscope, an indicator appears at the right bottom corner of the display. (Unlock the SD card before file operations).

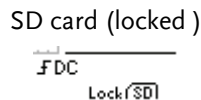
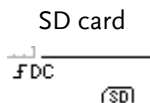

Creating a new folder / renaming a file or folder

1. Move the cursor to the file or folder location and press *New Folder* or *Rename*. The file/folder name and the character map will appear on the display.

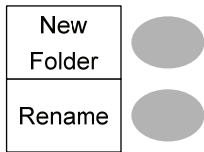

2. Use the Variable knob to move the pointer to the characters. Press *Enter* Character to add a character or *Back Space* to delete a character.

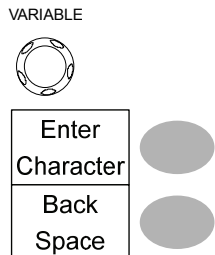

3. When editing is completed, press *Save*. The file/folder creation or rename will be completed.



Deleting a folder or file

1. Move the cursor to the folder or file location and press *Delete*. The message "*Press F4 again to confirm this process*" appears at the bottom of the display.
2. If the file/folder still needs to be deleted, press *Delete* again to complete the deletion. To cancel the deletion, press any other key.



Quick Save (HardCopy)

Background The Hardcopy key works as a shortcut for saving display image, waveform data, and panel settings into an SD card.

Hardcopy

Hardcopy key can be configured into two types of operation: save image and save all (image, waveform, setup).





Using the Save/Recall key can also save files with more option. For details, see page81.

Save/Recall

Functionalities

Save image (*.bmp)	Saves the current display image into an SD card.
Save all	Saves the following items into an SD card. <ul style="list-style-type: none"> • Current display image (*.bmp) • Current system settings (*.set) • Current waveform data (*.csv) • Last stored system settings (*.set) • Last stored waveform data (*.csv)

SD Card restriction The GDS-1000 series accept the following SD card.
 Size: 2GB or less
 Format: FAT or FAT32

- Procedure**
1. Insert an SD card to the slot. 
 2. Press the Utility key. 
 3. Press *Hardcopy Menu*. 
 4. Press *Function* repeatedly to select *Save Image* or *Save All*. 

5. To invert the color in the display image, press *Ink Saver* and turn on or off the Ink Saver.

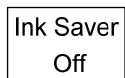

6. Press the Hardcopy key. The file or folder will be saved to the root directory of the SD card.



Save

This section describes how to save data using the Save/Recall menu.

File type/source/destination

Item	Source	Destination
Panel setup (xxx.set)	<ul style="list-style-type: none"> Panel settings 	<ul style="list-style-type: none"> Internal memory: S1 ~ S15 External memory: SD card
Waveform data (xxx.csv)	<ul style="list-style-type: none"> Channel 1, 2 Math operation result Reference waveform A, B 	<ul style="list-style-type: none"> Internal memory: W1 ~ W15 Reference waveform A, B External memory: SD card
Display image (xxx.bmp)	<ul style="list-style-type: none"> Display image 	<ul style="list-style-type: none"> External memory: SD card
Save All	<ul style="list-style-type: none"> Display image (xxx.bmp) Waveform data (xxx.csv) Panel settings (xxx.set) 	<ul style="list-style-type: none"> External memory: SD card

SD Card restriction

The GDS-1000 series accept the following SD card.
 Size: 2GB or less
 Format: FAT or FAT32

Saving the panel settings

Procedure

1. (For saving to an external SD card) Insert the card into the slot.

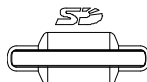

2. Press the Save/Recall key twice to recall the Save menu.

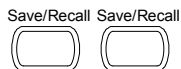

3. Press *Save Setup*.



4. Press *Destination* repeatedly to select the saved location. Use the Variable knob to change the internal memory location (S1 ~ S15).



VARIABLE



Memory Internal memory, S1 ~ S15

SD card External card, no practical limitation for the amount of file. When saved, the setup file will be placed in the root directory.

5. Press *Save* to confirm saving. When completed, a message appears at the bottom of the display.



Note 

The file will not be saved if the power is turned off or SD card is disconnected before completion.

File utilities

To edit SD card contents (create/ delete/ rename files and folders), press *File Utilities*. For details, see page77.



Saving the waveform

Procedure

1. (For saving to an external SD card) Insert the card into the slot.

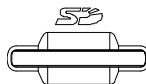

2. Press the Save/Recall key twice to recall the Save menu.



3. Press *Save Waveform*.

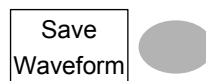

4. Press *Source*. Use the Variable knob to select the source signal.



VARIABLE



- CH1 ~ CH2 Channel 1 ~ 2 signal
- Math Math operation result (page49)
- RefA, B Internally stored reference waveforms A, B

5. Press *Destination* repeatedly to select the file destination. Use the Variable knob to select the memory location.

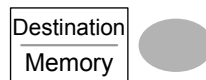

VARIABLE



- Memory Internal memory, W1 ~ W15
- SD card External card, no practical limitation for the amount of file. When saved, the waveform will be placed in the root directory.

Ref Internal reference waveform, A/B

6. Press *Save* to confirm saving. When completed, a message appears at the bottom of the display.





Note  The file will not be saved if the power is turned off or the SD card is disconnected before completion.

File utilities To edit SD card contents (create/ delete/ rename files and folders), press *File Utilities*. For details, see page77.

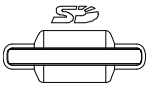
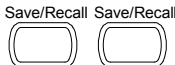

Saving the display image

Procedure

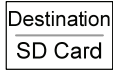
- (For saving to an external SD card) Insert the card into the slot. 
- Press the *Save/Recall* key twice to recall the *Save* menu. 
- Press *Save Image*. 
- Press *Ink Saver* repeatedly to invert the background color (on) or not (off). 
- Press *Destination*. 

SD card External card, no practical limitation on the amount of file. When saved, the image file will be placed in the root directory.

6. Press *Save* to confirm saving. When completed, a message appears at the bottom of the display.

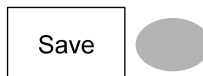

Note  The file will not be saved if the power is turned off or SD card is disconnected before completion.

File utilities To edit SD card contents (create/ delete/ rename files and folders), press *File Utilities*. For details, see page77.



Saving all (panel settings, display image, waveform)

Procedure

1. (For saving to an external SD card) Insert the card into the slot.

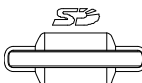

2. Press the *Save/Recall* key twice to recall the Save menu.



3. Press *Save All*. The following information will be saved.



Setup file (Axxx.set) Two types of setups are saved: the current panel setting and the last internally saved settings (one of S1 ~ S15).

Display image (Axxx.bmp) The current display image in the bitmap format.

Waveform data (Axxx.csv) Two types of waveform data are saved: the currently active channel data and the last internally saved data (one of W1 ~ W15).

4. Press *Ink Saver* repeatedly to invert the background color (on) or not (off) for the display image.
- Ink Saver

 Off
-

5. Press *Destination*.
- Destination

 SD Card

SD card External card, no practical limitation for the amount of file. When saved, the folder will be placed in the root directory.

6. Press *Save* to confirm saving. When completed, a message appears at the bottom of the display.
- Save
-

Note The file will not be saved if the power is turned off or SD card is disconnected before completion.

7. Together with the current setup/waveform/image, the last saved waveform file (one from W1 ~ W15) and setup file (one from S1 ~ S15) are also included in the folder.

File utilities To edit SD card contents (create/ delete/ rename files and folders), press *File Utilities*. For details, see page77.

File
 Utilities

Recall

File type/source/destination

Item	Source	Destination
Default panel setup	<ul style="list-style-type: none"> Factory installed setting 	<ul style="list-style-type: none"> Current front panel
Reference waveform	<ul style="list-style-type: none"> Internal memory: A, B 	<ul style="list-style-type: none"> Current front panel
Panel setup (DSxxxx.set)	<ul style="list-style-type: none"> Internal memory: S1 ~ S15 External memory: SD card 	<ul style="list-style-type: none"> Current front panel
Waveform data (DSxxxx.csv)	<ul style="list-style-type: none"> Internal memory: W1 ~ W15 External memory: SD card 	<ul style="list-style-type: none"> Reference waveform A, B

SD Card restriction

The GDS-1000 series accept the following SD card.
 Size: 2GB or less
 Format: FAT or FAT32

Recalling the default panel settings

Procedure

1. Press the Save/Recall key.



2. Press *Default Setup*. The factory installed setting will be recalled.

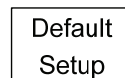



Setting contents

The following is the default panel setting contents.

Acquisition

Mode: Normal

Channel	Coupling: DC BW limit: Off (GDS-1102, GDS-1062)	Invert: Off Probe attenuation: x1
Cursor	Source: CH1 Vertical: None	Horizontal: None
Display	Type: Vectors Graticule: 	Accumulate: Off
Horizontal	Scale: 2.5us/Div	Mode: Main Timebase
Math	Type: + (Add) Position: 0.00 Div	Channel: CH1+CH2 Unit/Div: 2V
Measure	Item: Vpp, Vavg, Frequency, Duty cycle, Rise Time	
Trigger	Type: Edge Mode: Auto Coupling: DC Noise Rejection: Off	Source: Channel1 Slope:  Rejection: Off
Utility	SaveImage, InkSaver Off	

Recalling a reference waveform to the display

Procedure

1. The reference waveform must be stored in advance. See page 83 for details.

2. Press the Save/Recall key.



3. Press *Display Refs.* The reference waveform display menu appears.



4. Select the reference waveform, *Ref A* or *Ref B*, and press it. The waveform appears on the display and the period and amplitude of the waveform appears in the menu.

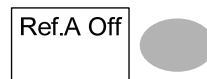

5. To clear the waveform from the display, press *RefA/B* again.

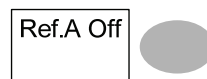

Recalling panel settings

Procedure

1. (For recalling from an external SD card) Insert the card into the slot.

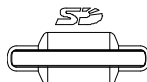

2. Press the Save/Recall key.



3. Press *Recall Setup*.



4. Press *Source* repeatedly to select the file source, internal or external memory. Use the Variable knob to change the memory.

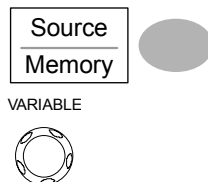

- Memory Internal memory, S1 ~ S15
- SD card External card, no practical limitation on the amount of file. The setup file must be placed in the root directory to be recognized.

5. Press *Recall* to confirm recalling. When completed, a message appears at the bottom of the display.



Note

The file will not be saved if the power is turned Off or SD card is disconnected before completion.

File utilities

To edit SD card contents (create/ delete/ rename files and folders), press *File Utilities*. For details, see page77.



Recalling a waveform

Procedure

1. (For recalling from an external SD card) Insert the card into the slot.

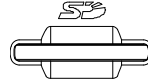

2. Press the Save/Recall key.



3. Press *Recall Waveform*. The display shows the available source and destination options.



4. Press *Source* repeatedly to select the file source, internal memory or external SD card. Use the Variable knob to change the memory location (W1 ~ W15).



VARIABLE



Memory

Internal memory, W1 ~ W15

SD card

External flash drive, no practical limitation on the amount of file. The waveform file must be placed in the root directory to be recognized.

5. Press *Destination*. Use the Variable knob to select the memory location.



VARIABLE



RefA, B

Internally stored reference waveforms A, B

6. Press *Recall* to confirm recalling. When completed, a message appears at the bottom of the display.

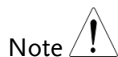
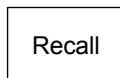

Note

The file will not be saved if the power is turned off or SD card is disconnected before completion.

File utilities

To edit SD card contents (create/ delete/ rename files and folders), press *File Utilities*. For details, see page77.

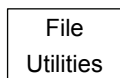

M AINTENANCE

Two types of maintenance operations are available: calibrating the vertical resolution, and compensating the probe. Run these operations when using the oscilloscope in a new environment.

Vertical Resolution Calibration

Procedure

1. Press the Utility key.



2. Press *More*.



3. Press *Self Cal Menu*.



4. Press *Vertical*. The message “Set CAL to CH1, then press F5” appears at the bottom of the display.



5. Connect the calibration signal between the rear panel CAL out terminal and the Channel1 input.

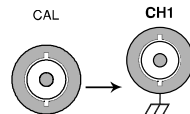

6. Press F5. The calibration automatically starts.

- The Channel1 calibration will complete in less than 5 minutes.

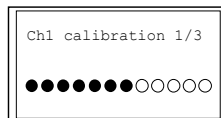

- When finished, connect the calibration signal to the Channel 2 input and repeat the procedure.



- The calibration is completed and the display goes back to the previous state.

Probe Compensation

Procedure

- Connect the probe between Channel1 input and the probe compensation output (2Vp-p, 1kHz square wave) on the front panel. Set the probe attenuation to x10.

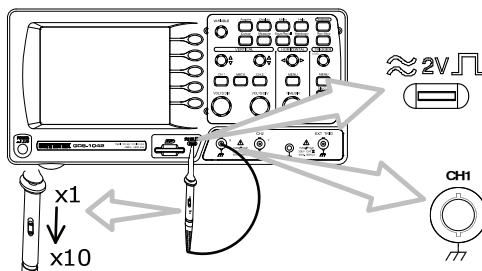

- Press the Utility key.



- Press *ProbeComp*.



- Press *Wavetype* repeatedly to select the standard square wave.

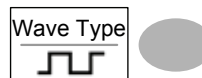

5. Press the Autoset key. The compensation signal will appear in the display.



6. Press the Display key, then *Type* to select the vector waveform.

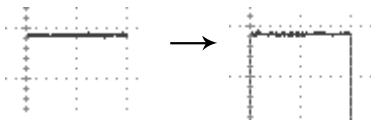
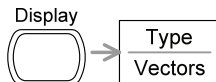

7. Turn the adjustment point on the probe until the signal edge becomes sharp.

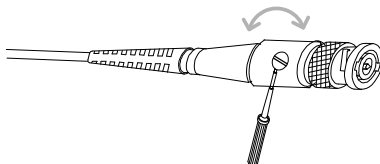
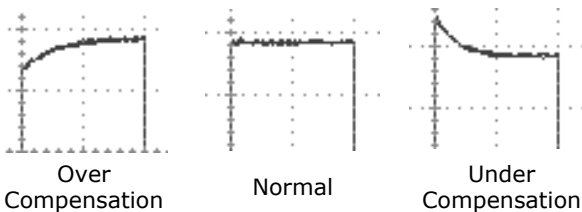

FAQ

- The input signal does not appear in the display.
- I want to remove some contents from the display.
- The waveform does not update (frozen).
- The probe waveform is distorted.
- Autoset does not catch the signal well.
- I want to clean up the cluttered panel settings.
- The accuracy does not match the specifications.
- The SD card slot does not accept my card.

The input signal does not appear in the display.

Make sure you have activated the channel. If not, press the CH key. If the signal still does not appear, press the Autoset key.

I want to remove some contents from the display.

To clear the math result, press the Math key twice (page49).

To clear the cursor, press the Cursor key again (page46).

To clear the Help contents, press the Help key again (page35).

The waveform does not update (frozen).

Press the Run/Stop key to unfreeze the waveform. See page38 for details. For trigger setting details, see page64.

The probe waveform is distorted.

You might need to compensate the probe. For details, see page94. Note that the frequency accuracy and duty factor are not specified for probe compensation waveform and therefore it should not be used for other reference purpose.

Autoset does not catch the signal well.

Autoset function cannot catch signals under 30mV or 30Hz. Please use the manual operation. See page37 for details.

I want to clean up the cluttered panel settings.

Recall the default settings by pressing the Save/Recall key \square Default Setting. For default setting contents, see page34.

The saved display image is too dark on the background.

Use the Inksaver function which reverses the background color. For details, see page84.

The accuracy does not match the specifications.

Make sure the device is powered on for at least 30 minutes, within +20°C~+30°C. This is necessary to stabilize the unit to match the specification.

The SD card slot does not accept my card.

Make sure it is a 1. Standard SD card (MMC and SDHC are not supported), 2. 2GB or less, and 3. FAT or FAT32 formatted.



It is recommended to use other SD card readers instead, e.g. San Disk, Kingston, Transcend, once the SD Card readers has an

unavailable compatibility to make accessing your data not that little bit easier.

For more information, contact your local dealer or GWInstek at www.gwinstek.com/ marketing@goodwill.com.tw.

APPENDIX

Fuse Replacement

- Procedure
1. Take off the power cord and remove the fuse socket using a minus driver.

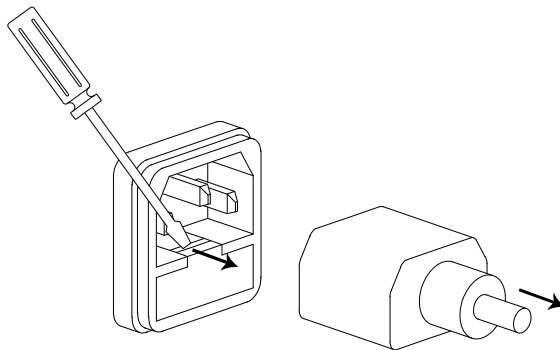

2. Replace the fuse in the holder.

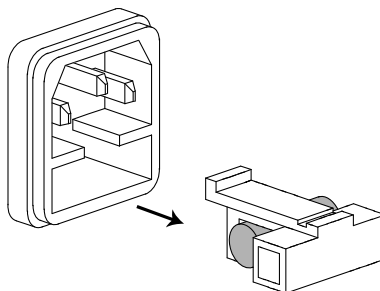

Ratings T1A, 250V

GDS-1000 Series Specifications

The specifications apply when the oscilloscope is powered on for at least 30 minutes under +20°C~+30°C.

Model-specific specifications

GDS-1022	Bandwidth (-3dB)	DC coupling: DC ~ 25MHz AC coupling: 10Hz ~ 25MHz
	Bandwidth Limit	None
	Trigger Sensitivity	Approx. 0.5div or 5mV
	External Trigger Sensitivity	~ 50mV
	Rise Time	< 14ns approx.
GDS-1042	Bandwidth (-3dB)	DC coupling: DC ~ 40MHz AC coupling: 10Hz ~ 40MHz
	Bandwidth Limit	None
	Trigger Sensitivity	0.5div or 5mV (DC ~ 25MHz) 1.5div or 15mV (25MHz~40MHz)
	External Trigger Sensitivity	~ 50mV
	Rise Time	< 8.75ns approx.
GDS-1062	Bandwidth (-3dB)	DC coupling: DC ~ 60MHz AC coupling: 10Hz ~ 60MHz
	Bandwidth Limit	20MHz (-3dB)
	Trigger Sensitivity	0.5div or 5mV (DC ~ 25MHz) 1.5div or 15mV (25MHz~60MHz)
	External Trigger Sensitivity	~ 50mV (DC~25MHz)
	Rise Time	< 5.8ns approx.
GDS-1102	Bandwidth (-3dB)	DC coupling: DC ~ 100MHz AC coupling: 10Hz ~ 100MHz
	Bandwidth Limit	20MHz (-3dB)
	Trigger Sensitivity	0.5div or 5mV (DC ~ 25MHz) 1.5div or 15mV (25MHz~100MHz)
	External Trigger Sensitivity	~ 50mV (DC~25MHz)
	Rise Time	< 3.5ns approx.

Common specifications

Vertical	Sensitivity	2mV/div~5V/Div (1-2-5 increments)
	Accuracy	± (3% x Readout +0.1div + 1mV)
	Bandwidth	See model-specific specifications
	Rise Time	See model-specific specifications
	Input Coupling	AC, DC, Ground
	Input Impedance	1MΩ±2%, ~15pF
	Polarity	Normal, Invert
	Maximum Input	300V (DC+AC peak), CAT II
	Math Operation	+, -, FFT
	Offset Range	2mV/div~50mV/div: ±0.4V 10mV/div~500mV/div: ±4V 1V/div~5V/div: ±40V
Trigger	Sources	CH1, CH2, Line, EXT
	Modes	Auto, Normal, Single, TV, Edge, Pulse
	Coupling	AC, DC, LF rej, HF rej, Noise rej
	Sensitivity	See model-specific specifications
External trigger	Range	DC: ±15V, AC: ±2V
	Sensitivity	See model-specific specifications
	Input Impedance	1MΩ±2%, ~16pF
	Maximum Input	300V (DC+AC peak), CATII
Horizontal	Range	1ns/div~10s/div, 1-2.5-5 increment Roll: 250ms/div – 10s/div
	Modes	Main, Window, Window Zoom, Roll, X-Y
	Accuracy	±0.01%
	Pre-Trigger	10 div maximum
	Post-Trigger	1000 div
X-Y Mode	X-Axis Input	Channel 1
	Y-Axis Input	Channel 2
	Phase Shift	±3° at 100kHz
Signal Acquisition	Real-Time	250M Sa/s maximum
	Equivalent	25G Sa/s maximum
	Vertical	8 bits
	Resolution	
	Record Length	4k points maximum
	Acquisition	Normal, Peak Detect, Average
	Peak Detection	10ns (500ns/div ~ 10s/div)
Average	2, 4, 8, 16, 32, 64, 128, 256	

Cursors and Measurement	Voltage	V _{pp} , V _{amp} , V _{avg} , V _{rms} , V _{hi} , V _{lo} , V _{max} , V _{min} , Rise Preshoot/ Overshoot, Fall Preshoot/ Overshoot
	Time	Freq, Period, Rise Time, Fall Time, + Width, – Width, Duty Cycle
	Cursors	Voltage difference (ΔV) and Time difference (ΔT) between cursors
	Auto Counter	Resolution: 6 digits, Accuracy: $\pm 2\%$ Signal source: All available trigger source except the Video trigger
Control Panel Function	Autoset	Automatically adjust Vertical Volt/div, Horizontal Time/div, and Trigger level
	Save/Recall	Up to 15 sets of measurement conditions and waveforms
Display	LCD	5.6 inch, TFT, brightness adjustable
	Resolution (dots)	234 (Vertical) x 320 (Horizontal)
	Graticule	8 x 10 divisions
	Display Contrast	Adjustable
Interface	USB Slave Connector	USB1.1 & 2.0 full speed compatible (printers and flash disk not supported)
	SD Card Slot	Image (BMP) and waveform data (CSV)
	Probe Compensation Signal	Frequency range 1kHz ~ 100kHz adjustable, 1kHz step
Power Source	Duty cycle	5% ~ 95% adjustable, 5% step
	Amplitude	2V _{pp} $\pm 3\%$
Operation Environment	Line Voltage	100V~240V AC, 47Hz~63Hz
	Power Consumption	18W, 40VA maximum
	Fuse Rating	1A slow, 250V
Storage Environment	Ambient temperature	0 ~ 50°C
	Relative humidity	$\leq 80\%$, 40°C or below $\leq 45\%$, 41°C~50°C
Dimensions	Storage temperature	-10°C~60°C, no condensation-
	Relative humidity	93% @ 40°C 65% @ 41°C~60°C
Weight		341.5 (W) x 162.3 (H) x 159 (D) mm Approx. 2.5kg

Probe Specifications

GDS-1022/1042 Probe

Applicable model & probe	GDS-1022, GDS-1042 GTP-060A-4	
Position x 10	Attenuation Ratio	10:1
	Bandwidth	DC ~ 60MHz
	Input Resistance	10MΩ when used with 1MΩ input
	Input Capacitance	30pF approx.
	Maximum Input Voltage	300V peak Derating with frequency
	Position x 1	Attenuation Ratio
Bandwidth		DC ~ 6MHz
Input Resistance		1MΩ when used with 1MΩ input
Input Capacitance		200pF approx.
Maximum Input Voltage		150V peak Derating with frequency
Operating Cond.		Temperature
	Relative Humidity	≤85% @35°C
Safety Standard	IEC 1010-1 CAT II	

GDS-1062/1102 Probe

Applicable model & probe	GDS-1062 GTP-060A-2	GDS-1102 GTP-100A-2
Position x 10	Attenuation Ratio	10:1
	Bandwidth	DC ~ 60MHz DC ~ 100MHz
	Input Resistance	10MΩ when used with 1MΩ input
	Input Capacitance	23pF approx. 17pF approx.
	Maximum Input Voltage	500V CAT I, 300V CAT II (DC+Peak AC) Derating with frequency
	Position x 1	Attenuation Ratio
Bandwidth		DC ~ 6MHz
Input Resistance		1MΩ when used with 1MΩ input
Input Capacitance		180pF approx. 47pF approx.
Maximum Input Voltage		300V CAT I, 150V CAT II (DC+Peak AC) Derating with frequency
Operating Cond.		Temperature
	Relative Humidity	≤85% @35°C
Safety Standard	IEC 1010-1 CAT II	

* Note: GW Instek reserves the right to change the probe model type (GTP-060A-2, GTP-060A-4, GTP-100A-2) at anytime without notice for probe types of similar specification.

Declaration of Conformity

We	
GOOD WILL INSTRUMENT CO., LTD.	
(1) No.7-1, Jhongsing Rd., Tucheng Dist., New Taipei City 236, Taiwan (R.O.C.)	
(2) No. 69, Lu San Road, Suzhou City (Xin Qu), Jiangsu Sheng, China	
declare, that the below mentioned product	
Type of Product: Digital Storage Oscilloscope	
Model Number: GDS-1022, GDS-1042, GDS-1062, GDS-1102	
are herewith confirmed to comply with the requirements set out in the Council Directive on the Approximation of the Law of Member States relating to Electromagnetic Compatibility (2004/108/EC) and Low Voltage Directive (2006/95/EC).	
For the evaluation regarding the Electromagnetic Compatibility and Low Voltage Directive, the following standards were applied:	
© EMC	
EN 61326-1: Electrical equipment for measurement, control and laboratory use -- EMC requirements (2006)	
Conducted Emission Radiated Emission EN 55011: Class A 1998 + A1:1999 + A2:2002	Electrical Fast Transients EN 61000-4-4: 2004
Current Harmonics EN 61000-3-2: 2000 + A2:2005	Surge Immunity EN 61000-4-5: 1995 + A1:2001
Voltage Fluctuations EN 61000-3-3: 1995 + A1:2001 + A2:2005	Conducted Susceptibility EN 61000-4-6: 1996 + A1:2001
Electrostatic Discharge EN 61000-4-2: 1995 + A1:1998 + A2:2001	Power Frequency Magnetic Field EN 61000-4-8: 1993 + A1:2001
Radiated Immunity EN 61000-4-3: 2002 + A1:2002	Voltage Dip/ Interruption EN 61000-4-11: 2004
© Safety	
Low Voltage Equipment Directive 2006/95/EC	
Safety Requirements IEC/EN 61010-1: 2001	

INDEX

AC coupling	62	cycle time measure	44
accumulating waveform	55	DC coupling	61
acquisition	52	declaration of conformity	104
menu tree	20	default setup	87
specification	101	contents	34
addition	50	menu tree	26
menu tree	24	display	56
amplitude measure	43	contrast setting	56
auto set	37	diagram	17
exception	38	grid setting	56
faq	97	menu tree	22
specification	102	shortcut	22
auto trigger	64	specification	102
automatic measurement	45	display image	
menu tree	25	faq	97
overview	43	file format	74
shortcut	25	save	84
specification	102	save menu tree	29
average acquisition	53	Disposal instructions	10
average voltage measure	44	dot waveform	55
bandwidth limitation	62	duty cycle measure	44
blackman window	49	edge trigger	67
calibration, vertical resolution	93	menu tree	31
caution symbol	7	EN61010	104
channel	36	measurement category	8
faq	96	pollution degree	10
menu tree	21	environment	102
shortcut	21	safety instruction	9
cleaning the instrument	9	equivalent time sampling	54
configure remote control	72	external trigger	64
coupling mode	61	input terminal	15
menu tree	21	falling time measure	44
cursor	46	FFT	51
faq	96	menu tree	24
horizontal operation	46	overview	49
menu tree	21	file format	74
shortcut	21	firmware version	73
specification	102	flattop window	49

force trigger.....	71	normal trigger.....	65
frequency		NTSC	65
cursor tracking.....	46	overshoot voltage measure.....	44
frequency measure.....	44	PAL.....	65
frequency rejection.....	66	peak detect acquisition.....	53
front panel diagram	13	peak to peak measure.....	43
fuse replacement.....	99	peak voltage measure.....	43
safety instruction.....	9	power on/off	
general purpose signal.....	41	safety instruction	9
ground		switch overview.....	16
coupling	61	preshoot voltage measure.....	44
symbol.....	7	probe.....	94
terminal.....	15	attenuation level	63
hanning window	49	attenuation menu tree.....	21
hardcopy.....	79	compensation menu tree.....	33
menu tree.....	33	compensation signal overview.....	41
shortcut	33	faq.....	97
help.....	35	peak detect demonstration.....	53
faq.....	96	pulse time measure	44
high voltage measure.....	43	pulse width trigger	69
horizontal	57	condition	65
basic operation.....	39	menu tree	31
cursor operation.....	46	real time sampling	54
menu tree	23	rear panel diagram.....	16
position.....	57	recall	87
scale.....	57	default setup.....	87
shortcut	23	menu tree	26
specification.....	101	reference waveform.....	89
IEC 1010-1.....	103	setup.....	90
ink saver		shortcut.....	26
in display save	84	waveform	91
in hardcopy.....	80	rectangular window	49
in save all	86	reference waveform	
input frequency indicator.....	17	menu tree	27
invert waveform	62	recall.....	89
language selection	73	remote control interface	72
list of features.....	12	rising time measure	44
low voltage measure	44	roll mode.....	58
math		root mean square measure.....	44
faq.....	96	run/stop.....	38
menu tree	24	faq.....	96
shortcut	24	save	81
model difference.....	12	display image	84
negative peak measure	43	menu tree	26
noise rejection	66	setup.....	82
normal acquisition.....	52	shortcut.....	26
		specification	102

waveform.....	83	shortcut.....	30
save all.....	85	specification.....	101
menu tree.....	29	status indicator.....	17
SD card		video.....	68
faq.....	98	UK power cord.....	11
file menu tree.....	30	USB for remote control.....	72
file operation.....	77, 79, 81, 87	utility	
SECAM.....	65	key overview.....	14
serial number.....	73	menu tree.....	32
service operation		shortcut.....	32
about disassembly.....	8	vector waveform.....	55
contact.....	98	vertical.....	61
setting up the oscilloscope.....	18	basic operation.....	40
setup		cursor operation.....	48
default contents.....	34	position.....	61
file format.....	76	resolution calibration.....	93
how to save.....	82	scale.....	61
recall.....	90	specification.....	101
recall menu tree.....	26	video line.....	65
save menu tree.....	28	video trigger.....	68
single trigger.....	71	menu tree.....	30
single trigger mode.....	65	voltage	
specifications.....	100	cursor tracking.....	46
faq.....	97	warning symbol.....	7
subtraction.....	50	waveform	
menu tree.....	24	file format.....	74
system information.....	73	invert waveform.....	62
time		recall.....	91
cursor tracking.....	46	recall menu tree.....	27
timebase indicator.....	57	roll mode.....	58
trigger.....	64	save.....	83
coupling.....	66	savemenu tree.....	28
edge.....	67	x-y mode.....	60
force.....	71	zoom mode.....	59
indicator.....	64	waveform accumulation.....	55
level knob.....	66	x-y mode.....	60
menu tree.....	30	specification.....	101
parameter.....	64	zoom waveform.....	59
pulse width.....	69		