

Spectrum Analyzer

GSP-818

Quick Start Guide

GW INSTEK PART NO.



ISO-9001 CERTIFIED MANUFACTURER

GW INSTEK

This manual contains proprietary information, which is protected by copyright. All rights are reserved. No part of this manual may be photocopied, reproduced or translated to another language without prior written consent of the Good Will company.

The information in this manual was correct at the time of printing. However, Good Will continues to improve products and reserves the right to change specification, equipment, and maintenance procedures at any time without notice.

Good Will Instrument Co., Ltd.
No. 7-1, Jhongsing Rd., Tucheng Dist., New Taipei City 236, Taiwan.

Table of Contents

SAFETY INSTRUCTIONS	4
USER NOTICE	9
Safety Precaution before Operation	9
Electro-static Discharge (ESD) Protection	10
First Time to Power on	11
GETTING STARTED	12
Front Panel Overview.....	13
Rear Panel	15
Front Panel Function Key	17
Parameter Input	20
User Interface	22
Build-in Help	24
Basic Measurement	24
APPENDIX	28
Specifications	28
Declaration of Conformity.....	34

S SAFETY INSTRUCTIONS

This chapter contains important safety instructions that you must follow when operating the GSP-818, and when keeping it in storage. Read the following before operating the GSP-818 to ensure your safety and to keep the GSP-818 in the best possible condition.

Safety Symbols

These safety symbols may appear in this manual or on the GSP-818.



Warning: Identifies conditions or practices that could result in injury or loss of life.



Caution: Identifies conditions or practices that could result in damage to the GSP-818 or to other properties.



DANGER High Voltage



Attention Refer to the Manual



Protective Conductor Terminal



Earth (ground) Terminal



Do not dispose electronic equipment as unsorted municipal waste. Please use a separate collection facility or contact the supplier from which this instrument was purchased.

Safety Guidelines

General Guideline



CAUTION

- Do not place any heavy object on the GSP-818.
- Avoid severe impact or rough handling that leads to damaging the GSP-818.
- Do not discharge static electricity to the GSP-818.
- Do not block or obstruct the cooling fan vent openings.
- Do not perform measurement at circuits directly connected to Mains (Note below).
- Do not disassemble the GSP-818 unless you are qualified as service personnel.
- The equipment is not for measurements performed for CAT II, III and IV.

(Measurement categories) EN 61010-1:2010 specifies the measurement categories and their requirements as follows. The GSP-818 falls under category I.

- Measurement category IV is for measurement performed at the source of low-voltage installation.
 - Measurement category III is for measurement performed in the building installation.
 - Measurement category II is for measurement performed on the circuits directly connected to the low voltage installation.
 - 0 is for measurements performed on circuits not directly connected to Mains.
-

Power Supply



WARNING

- AC Input voltage range: 100-240Vac;
Frequency: 50/60Hz
 - Connect the protective grounding conductor of the AC power cord to an earth ground, to avoid electrical shock.
-

Cleaning the
GSP-818

- Disconnect the power cord before cleaning.
 - Use a soft cloth dampened in a solution of mild detergent and water. Do not spray any liquid.
 - Do not use chemicals or cleaners containing harsh material such as benzene, toluene, xylene, and acetone.
-

Operation
Environment

- Location: Indoor, no direct sunlight, dust free, almost non-conductive pollution (Note below)
- Temperature: 0°C to 40°C
- Altitude: Up to 2000m
- Transient Overvoltage on the main supply is 2500V.

(Pollution Degree) EN 61010-1:2010 specifies the pollution degrees and their requirements as follows. THE GSP-818 falls under degree 2.

Pollution refers to “addition of foreign matter, solid, liquid, or gaseous (ionized gases), that may produce a reduction of dielectric strength or surface resistivity”.

- Pollution degree 1: No pollution or only dry, non-conductive pollution occurs. The pollution has no influence.
 - Pollution degree 2: Normally only non-conductive pollution occurs. Occasionally, however, a temporary conductivity caused by condensation must be expected.
 - Pollution degree 3: Conductive pollution occurs, or dry, non-conductive pollution occurs which becomes conductive due to condensation which is expected. In such conditions, equipment is normally protected against exposure to direct sunlight, precipitation, and full wind pressure, but neither temperature nor humidity is controlled.
-

Storage environment

- Location: Indoor
- Relative Humidity: < 80%
- Temperature: -20°C to 70°C

Disposal

Do not dispose this instrument as unsorted municipal waste. Please use a separate collection facility or contact the supplier from which this instrument was purchased. Please make sure discarded electrical waste is properly recycled to reduce environmental impact.

Power cord for the United Kingdom

When using the GSP-818 in the United Kingdom, make sure the power cord meets the following safety instructions.

NOTE: This lead/appliance must only be wired by competent persons



WARNING: THIS APPLIANCE MUST BE EARTHED

IMPORTANT: The wires in this lead are coloured in accordance with the following code:

Green/ Yellow:	Earth
Blue:	Neutral
Brown:	Live (Phase)



As the colours of the wires in main leads may not correspond with the coloured marking identified in your plug/appliance, proceed as follows:

The wire which is coloured Green & Yellow must be connected to the Earth terminal marked with either the letter E, the earth symbol ⊕ or coloured Green/Green & Yellow.

The wire which is coloured Blue must be connected to the terminal which is marked with the letter N or coloured Blue or Black.

The wire which is coloured Brown must be connected to the terminal marked with the letter L or P or coloured Brown or Red.

If in doubt, consult the instructions provided with the equipment or contact the supplier.

This cable/appliance should be protected by a suitably rated and approved HBC mains fuse: refer to the rating information on the equipment and/or user instructions for details. As a guide, a cable of 0.75mm² should be protected by a 3A or 5A fuse. Larger conductors would normally require 13A types, depending on the connection method used.

Any exposed wiring from a cable, plug or connection that is engaged in a live socket is extremely hazardous. If a cable or plug is deemed hazardous, turn off the mains power and remove the cable, any fuses and fuse assemblies. All hazardous wiring must be immediately destroyed and replaced in accordance to the above standard.

USER NOTICE

This chapter helps you in preparing the spectrum analyzer for use and provides the information to start using the spectrum analyzer correctly.

Safety Precaution before Operation

Check Power Supply

The analyzer is equipped with a three-wire power cord in accordance with international safety standards. The product must be grounded properly before being powered on, as floating or improper ground may cause damage to the instrument or personal injury.

Make sure the grounding conductor of the spectrum analyzer is grounded before turning on the instrument. After which the AC power cord can be connected. Do not use a non-ground power cord.

Allowed Variation Range of Supply Power Parameters

The spectrum analyzer is compatible with 100V~240V, 50Hz-60Hz AC power. The table below lists the power requirement to run the spectrum analyzer.

Power Supply Parameter	Compatible Range
Voltage	100 - 240 VAC
Frequency	50 - 60 Hz $\pm 10\%$
Power	22 W

To prevent or lower the risk of damage to the spectrum analyzer from power interference between instruments, especially from peak

pulses produced by large power consumption instruments, a 220V/110V AC regulated power supply is recommended.

Power Cord Selection

The analyzer is equipped with a three-wire power cord in accordance with international safety standards. This cable grounds the analyzer cabinet when connected to an appropriate power line outlet. The cable must be rated greater than 250Vac and 2A.



WARNING

Improper grounding may cause damage to the instrument, or result in personal injury. Make sure the grounding conductor of the spectrum analyzer is grounded before turning on the instrument.

Always use a well-grounded power source. Do not use an external power cable, power cord or an auto transformer without grounded protection. If this product is to be powered via an external auto transformer for voltage reduction, ensure that its common terminal is connected to a neutral (earthed pole) of the power supply.

Make sure the supply power is stable before turning on the analyzer to protect it from damage. Refer to “First Time to Power on” on page 11.

Electro-static Discharge (ESD) Protection

ESD is an issue often ignored by users. Damage from ESD on the instrument is unlikely to occur immediately but will significantly reduce the reliability of it. Therefore, ESD precautions should be implemented in the work environment, and applied daily.

Generally, there are two steps to manage ESD protection:

1. Conductive table mats to connect hands via wrist bands
2. Conductive ground mat to connect feet via ankle straps

Implement both protection methods will provide a good level of anti-static protection. If used alone, the protection will not be as reliable. To ensure user's safety, anti-static components should offer at least $1M\Omega$ isolation resistance.

**WARNING**

The above ESD protections measures cannot be used when working with over 500V!

Make good use of anti-static technology to protect components from damage:

1. Quickly ground the internal and external conductor of the coaxial cable before it is connected with the spectrum analyzer.
2. Staff must wear anti-static gloves before touching the connector cord or doing any assemble work.
3. Assure all the instruments are grounded properly to avoid static storage.

First Time to Power on

Connect the three-pin AC power cord into the instrument. Insert the plug into a power socket provided with a protective ground.

**WARNING**

Check the power source before turning on the spectrum analyzer, to protect the device from damage.

Steps

1. Press the power switch  on the bottom left of the front panel.
2. Self-initialization takes about 30 seconds, after the boot screen the spectrum analyzer will default to the scanning curve.
3. After power on, let the spectrum analyzer warm up for 30 minutes for stabilization to obtain the most accurate results.

G ETTING STARTED

This chapter introduces the front / rear panel, the user interface and explains how to use the instrument with a measurement example demonstration.

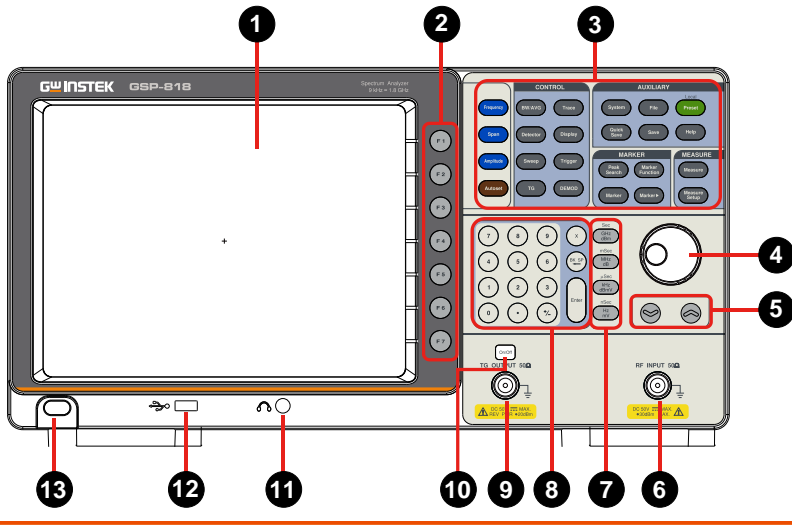

Front Panel Overview	13
Rear Panel	15
Front Panel Function Key	17
Parameter Input.....	20
Numeric Keypad.....	20
User Interface	22
Build-in Help	24
Basic Measurement	24

Front Panel Overview



1. LCD 800x600 color LCD display. The display shows the soft keys for the current function, frequency, amplitude and marker information.

 2. Menu soft keys The F1 to F7 function keys directly correspond to the soft keys on the right-hand side of display.
- 
3. Function keys See page 17 for details.

 4. Knob During parameter editing, turn the knob clockwise to increase, or counterclockwise to decrease the parameter values at specified steps.
- 
5. Arrow keys (1) Increase or decrease the parameter value at specific steps while editing a parameter.
(2) Move the cursor through the directory
- 

tree in the **File** function

6. RF Input connector

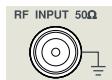

The RF input may be connected to a device via a N type connector.



Note

When input attenuator is higher than 10 dB, the RF port input signal must be less than +30 dBm.

Input voltage at RF input port must not be higher than 50 V DC to avoid damage to the attenuator and input mixer tracking generator.

7. Unit keys



Unit keys include GHz/dBm/s, MHz/dB/ms, kHz/dBmV/μs and Hz/mV/ns. After entering the desired numbers, choose an appropriate unit to complete the input. The specific meaning of unit is decided by the type of input parameter ("frequency", "amplitude" or "time").

8. Numeric keypad

See page 20 for details.

9. TG output connector

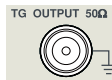

The output of the tracking generator can be connected to a receiver through an N type male connector, users can purchase this option if required.

10. TG output On/Off button



When the TG function is enabled, the backlight of button turns on and turns off when the function is disabled.

11. Earphone interface



3.5mm stereo headphone jack (wired for mono operation)

12. USB Host port



The analyzer may serve as a "host" device to connect to external USB devices. This interface is available for USB storage devices.





13. Power key

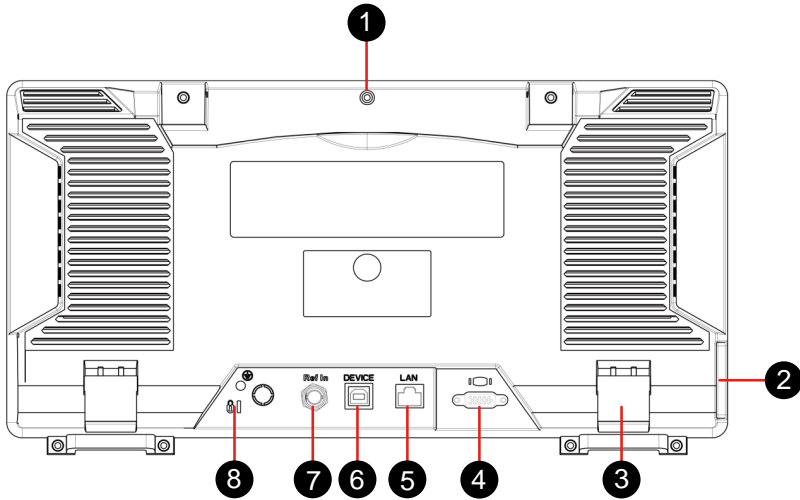

Push to turn on, long push to turn off

Rear Panel







- | | | |
|-------------------------|---|---|
| 1. Handle | | Stow the handle for mobile use. |
| 2. AC power connector | | AC: frequency 50Hz±10%, single-phase alternative 220V±15% or 110V±15% |
| 3. Stool | | To adjust the angle of the device |
| 4. VGA port |  | provides a VGA signal output which is used through a VGA cable or with a projector |
| 5. LAN interface |  | Through this interface, the analyzer can be connected to your local network for remote control. An integrated testing system can be built quickly, as the analyzer conforms to the LXI C Device class instrument standards. |
| 6. USB Device interface |  | This configurable USB port permits external USB devices. It supports PictBridge printer and remote-control connection. |
| 7. 10MHz IN/OUT |  | The BNC input or output of the 10 MHz reference clock |

8. Lock hole

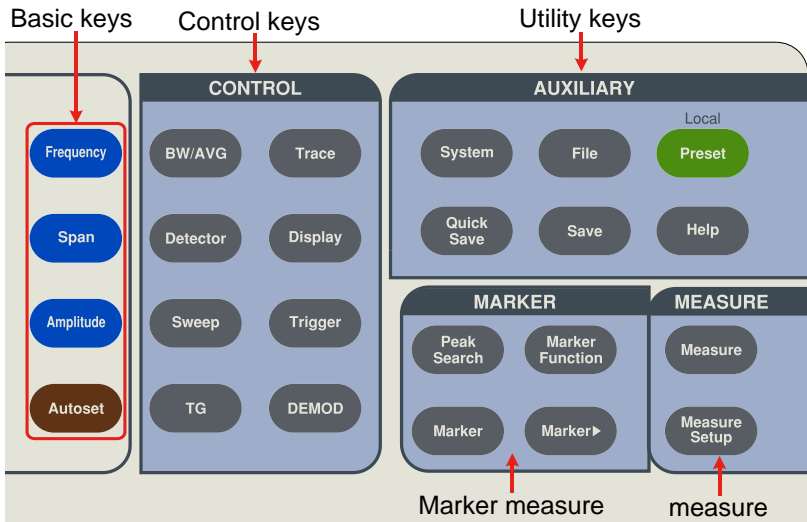
You can lock the spectrum analyzer to a fixed location using the security lock (please buy it yourself) to secure the spectrum analyzer.

Front Panel Function Key



Keys	Description
Basic keys	
	Activates the center-frequency function, and accesses the frequency function menu.
	Activates the frequency sweep span function, and set Full Span\Zero Span\Last Span.
	Activates the reference level function, and accesses the amplitude softkeys, with which you set functions that affect data on the vertical axis.
	Searches the signal automatically within the full frequency range.

Control keys

- BW/AVG** Activates the RBW (resolution bandwidth) function, and accesses the softkeys that control the bandwidth functions and averaging.
- Trace** Accesses the softkeys that allow you to store and manipulate trace information.
- Detector** Accesses the softkeys that allow you to configure detector functions.
- Display** Accesses the softkeys that allow you to control what is displayed on the analyzer, including the display line, graticule and label.
- Sweep** Accesses the softkeys that allow you to set the sweep time, select the sweep mode of the analyzer.
- Trigger** Accesses the softkeys that allow you to select the trigger mode of the analyzer.
- TG** Accesses the softkeys that allow you to set the tracking generator.
- DEMODO** Accesses the softkeys that allow you to set the demodulation.

Marker measure keys

- Peak Search** Places a marker on the highest peak, and accesses the Peak functions menu.
- Marker** Accesses the marker control keys that select the type and number of markers and turns them on and off.
- Marker▶** Accesses the marker function soft keys that allow you to set other system parameters based on the current marker's value.
- Marker Function** Accesses the menu of special functions, such as noise marker, N dB bandwidth measure and frequency counting.

Advanced measure keys

Measure

Accesses the softkeys that let you make transmitter power measurements such as ACPR(adjacent channel power), channel power, and OBW(occupied bandwidth), etc.

Measure Setup

Sets the parameters for the selected measurement function.

Utility keys

System

Sets the system parameters, and accesses the calibration menu.

File

Accesses the softkeys that allow you to configure the file system of the analyzer.

Preset

Resets the analyzer to the factory settings or user state. This state can be specified in **【System】** → [PowerOn/Preset▶] →[Preset▶].

Quick Save

Save the contents of the current screen quickly.

Save

Accesses the soft keys that allow you to save current screen, trace data, or user state.

Help

Press the Help key to activate the help system. Press the Help key again to exit.

Parameter Input

Specific parameter values are able to be entered using the numeric keypad, knob, and directional keys.

Numeric Keypad

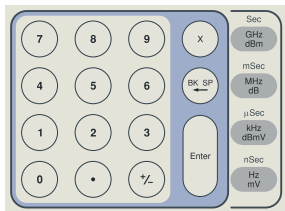

Numeric keys

Numbers 0-9 are available to be used.

Decimal point



A decimal point "." will be inserted at the cursor position when this key is pressed.

Sign key



Sign key "+/-" is to toggle the sign of a parameter. When pressed the first time, a "-" will be inserted and changed into "+" following the second press.

Cancel key



- (1) During the editing process this key will clear the inputs in the active area and exit editing mode at the same time.
- (2) Turn off the display in the active area.
- (3) Exit current test mode while in keyboard test.

Back key



- (1) During the process of parameter editing, this key will delete the characters on the left side of the cursor.
- (2) While in the process of file name editing, pressing this key will delete characters that have been entered.

Enter key



When pressed, the system will complete the input process and insert a default measurement unit for the parameter automatically.

Unit keys







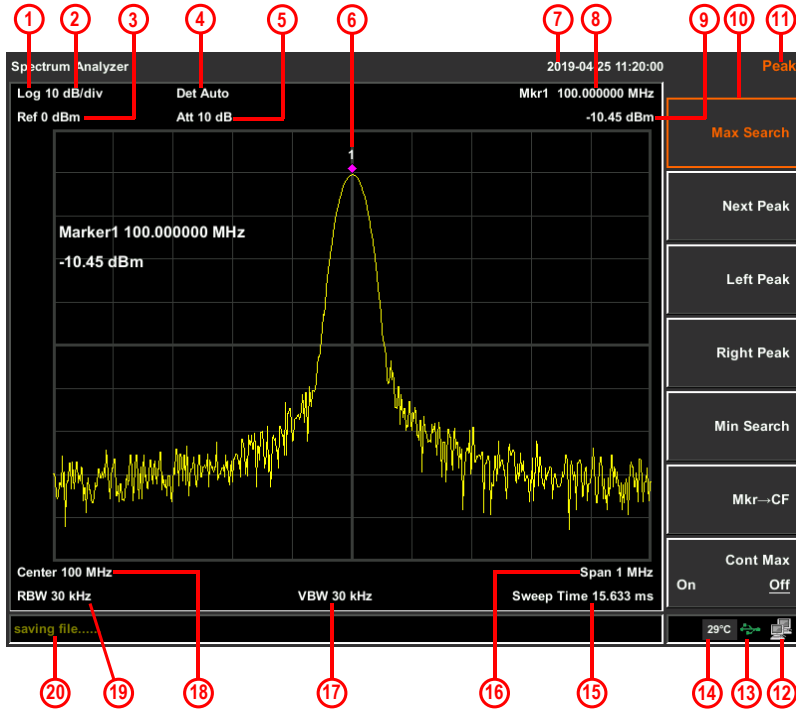



Unit keys include GHz/dBm/Sec, MHz/dB/mSec, kHz/dBmV/μSec and Hz/mV/nSec. After entering the desired numbers, choose an appropriate unit to complete the input. The specific meaning of unit is decided by the type of input parameter ("frequency", "amplitude" or "time").

User Interface



No.	Name	Description	Related Key
1.	Amplitude Division Type	Can choose logarithmic or linear	→ [Scale Type]
2.	Amplitude Division	Display division scale	→ [Scale/Div]
3.	Reference level	Reference level	→ [Ref Level]
4.	Detection type	Display detection type	
5.	Attenuation	Display input attenuation setting	→ [Attenuation]

6.	Marker	Display current activated marker	
7.	Date/time	Display system date and time	 → [Date/Time]
8.9.	Marker readout	Display frequency and amplitude of current marker	
10.	Menu item	Menu item of current function	
11.	Menu title	Function of current menu belongs to.	
12.	LAN access sign	LAN access sign	
13.	USB storage device	Show if USB storage device is inserted;	
14.	Temperature sign	Display device internal temperature	
15.	Sweep Time	System sweep time	 → [Sweep Time]
16.	Span	Display span width	 → [Span]
17.	Video bandwidth	Display video bandwidth	 → [VBW]
18.	Center frequency	Display center frequency	 → [Center Freq]
19.	Resolution bandwidth	Display resolution bandwidth	 → [RBW]
20.	System status	Display spectrum analyzer status	

Build-in Help

The built-in help provides information that refers to every function key and menu key on the front panel. Users can view this help information if required.

Basic Measurement

Basic measurements include, input signal frequency and amplitude display, marked by a frequency marker. Follow these four simple steps below to implement input signal measurement.

- | | |
|-------|---|
| Steps | <ol style="list-style-type: none"> 1. Setting center frequency 2. Setting span and resolution bandwidth 3. Activate marker 4. Setting amplitude |
|-------|---|

For example, to measure a 100MHz -20dBm signal, you must turn on the spectrum analyzer and ensure it is warmed up for 30 minutes to ensure measurement accuracy.

- | | | | | | |
|----------------------|---|-----------|---------|-----------|---------|
| Equipment connection | <ol style="list-style-type: none"> 1. Connect the output terminal of signal generator to the RF Input 50Ω terminal of spectrum analyzer. Set the parameters as follows: <table border="0" style="margin-left: 20px;"> <tr> <td style="padding-right: 20px;">Frequency</td> <td>100 MHz</td> </tr> <tr> <td>Amplitude</td> <td>-20 dBm</td> </tr> </table> | Frequency | 100 MHz | Amplitude | -20 dBm |
| Frequency | 100 MHz | | | | |
| Amplitude | -20 dBm | | | | |

- | | |
|--------------------|--|
| Setting parameters | <ol style="list-style-type: none"> 1. Press the Preset button to restore the analyzer to its factory defined state. The spectrum analyzer will display the spectrum from 9kHz to the maximum span width. The signal generated will display as a vertical line at 100MHz. |
|--------------------|--|



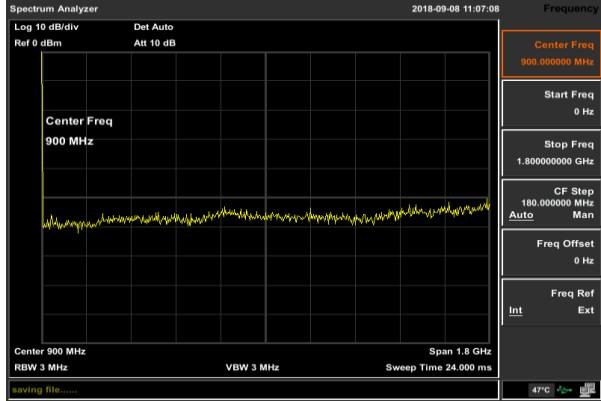

To clearly observe the signal, reduce the frequency span to 1 MHz and set the center frequency to 100MHz.

- Setting Center Frequency
Press the **Frequency** button and select **Center frequency** on corresponding pop up menu. Input "100" and select the unit as MHz on the numeric keypad. The keys can be used to set the exact value but the knob and directional keys can also be used to set the center frequency.



- Setting Frequency Span
Press the **Span** button, input "1" and select MHz as its unit using the numeric keypad or press ↓ button to decrease to 1MHz.



- Press the **BW/AVG** button and set **resolution bandwidth** to manual. Input 30 and select kHz as its unit using the numeric keypad or press ↓ button to decrease to 30kHz.



5. Press the **Detector** button and set the detection type to positive peak.



The signal at a higher resolution

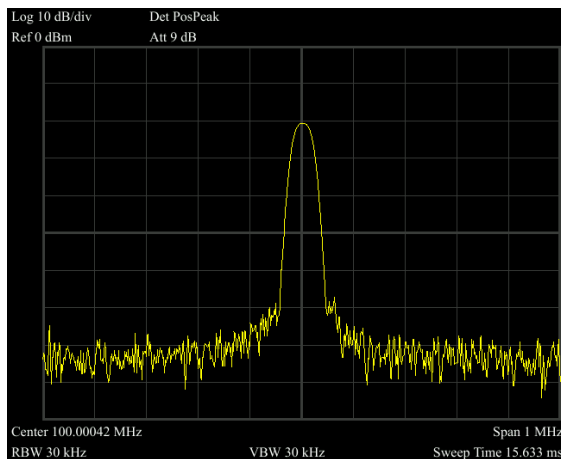

Please note that resolution bandwidth, video bandwidth and frequency span are self-adapted. They adjust to certain values according to frequency span. Sweep time can be self-adapted too.

Activate Marker

1. Press the **Marker** button in the function area. Press the soft key to select Marker 1 2 3 4 5. Select Marker 1 and the marker is located at horizontal center by default. That is the signal peak point or its neighbor.
2. Press **Peak Search** button and enter the next level menu. Select **Max Search**. Frequency and amplitude values are read by the marker and shown on the top right of the display area.



Setting amplitude 1. The reference level will be shown at the top of the display grid. To get a better dynamic range, the real signal peak point should be located at or near the top of display grid (reference level). The reference level is also the maximum value on Y axis. Here we reduce to 20dB reference level to increase the dynamic range.

2. Press the **Amplitude** button. The amplitude setting menu will pop up and the **reference level** soft key will be activated. The reference level can be input at the top left of the display grid. Input **-20** using the numeric keypad and set the unit to **dBm**. You can also use the ↓ key or the knob for adjustment.

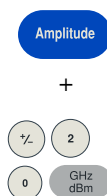

The reference level is set at -20dBm, which is the signal peak value near the top of the grid. The balance between the signal peak value and noise is dynamic range.

APPENDIX

Specifications

This chapter lists the technical specifications and general technical specifications of the spectrum analyzer. Unless otherwise stated, the technical specifications apply to the following conditions:

- The instrument has been preheated for 30 minutes before use.
- The instrument is in the calibration cycle and has been self-calibrated.

“Typical” and “nominal” for this product are defined as follows:

- Typical: Refers to the performance of the product under certain conditions.
- Nominal: Refers to the approximate value under product application process.

Model	GSP-818
Frequency	
Range	9 kHz to 1.8 GHz
Resolution	1 Hz
Frequency Span	
Span Range	0 Hz, 100 Hz to max. frequency of instrument
Span Uncertainty	$\pm \text{span} / (\text{sweep points}-1)$
Internal Frequency Reference	
Span Range	10.000000 MHz
Reference Frequency Accuracy	$\pm [(\text{days from last calibrate} \times \text{freq aging rate}) + \text{temperature stability} + \text{initial accuracy}]$

Temperature stability	<2.5ppm (15°C to 35°C)
Aging rate	<1ppm/year
SSB Phase Noise (20°C to 30°C, $f_c=1$ GHz, RBW= 1 kHz, VBW=10 Hz, Average ≥ 40)	
10 kHz	< -82 dBc/Hz
100 kHz	< -98 dBc/Hz(Typical)
1 MHz	< -110 dBc/Hz(Typical)
Bandwidth	
Resolution Bandwidth	10Hz to 500kHz (1-10 steps by sequence), 1MHz, 3MHz
RBW Uncertainty	< 18%, typical (RBW is 3MHz) < 5%, typical (RBW ≤ 1 MHz)
Resolution Filter Shape Factor (60 dB: 3 dB)	<5: 1 typical (digital and close to Gaussian shape)
Video Bandwidth (VBW)	10 Hz to 3 MHz
Amplitude	
Amplitude and level	
Amplitude measurement range	DANL to +10 dBm, 100 kHz to 1 MHz, Preamp Off DANL to +20 dBm, 1 MHz to 1.8 GHz, Preamp Off
Reference Level	-80 dBm to +30 dBm, 0.01dB by step
Preamp	20 dB, nominal, 100 kHz to 1.8 GHz
Input Attenuation	0 to 40 dB, in 1 dB step
Max Input DC Current	50 VDC
Max continuous power	+30dBm, average continuous power
Display Average Noise Level (Input Attenuation= 0 dB, RBW=1 Hz and RBW normalizes to 1 Hz)	
Preamp Off	
100 kHz to 1 MHz	-117 dBm (Typical)
1 MHz to 10 MHz	-130 dBm (Typical)
10 MHz to 1 GHz	-130 dBm (Typical)
1 GHz to 1.8 GHz	-128 dBm (Typical)

Preamp On

100 kHz to 1 MHz -140 dBm (Typical)

1 MHz to 10 MHz -150 dBm (Typical)

10 MHz to 1 GHz -150 dBm (Typical)

1 GHz to 1.8 GHz -148 dBm (Typical)

Frequency response (20°C to 30°C, 30% to 70% relative humidity, input attenuation=10 dB, reference frequency=50 MHz)

Preamp Off (fc ≥100 kHz) ±0.8 dB ; ±0.4 dB, Typical

Preamp On (fc ≥100 MHz) ±0.9 dB ; ±0.5 dB, Typical

Difference and Accuracy

RBW Switch Reference: 10 kHz RBW at 50 MHz

Uncertainty Log resolution=±0.2 dB, Lin resolution=±0.01
Nominal

Input 20°C ~30°C, fc=50 MHz, Preamplifier Off, 10 dB RF
Attenuation, input signal 0~40 dB ±0.5 dB

Uncertainty

Absolute 20°C to 30°C, fc=50 MHz, Span=200 kHz, RBW=10
Amplitude kHz, VBW=10 kHz, peak detector, 10 dB RF
Uncertainty attenuation, 95% confidence level

Preamp Off ±0.4 dB, input signal level -20 dBm

Preamp On ±0.5 dB, input signal level -40 dBm

Uncertainty Input signal range 0 dBm to -50 dBm
±1.5 dB

VSWR Input 10 dB RF attenuation, 1MHz to 1.8GHz
<1.5, Nominal

Distortion and spurious response

Second harmonic intercept fc ≥ 50 MHz, Preamp off, signal input -20 dBm, 0
dB RF attenuation, 20°C to 30°C
-65 dBc

Third-order intermodulation fc ≥ 50 MHz, Input double tone level -20 dBm,
frequency interval 100 kHz, input attenuation 0 dB,
preamplifier off, 20°C to 30°C
+10 dBm

1 dB Gain Compression fc ≥ 50 MHz, 0 dB RF attenuation, Preamp off ,
20°C to 30°C
>+2 dBm, Nominal

Residual response connect 50 Ω load at input port, 0 dB input
attenuation, 20°C to 30°C
<-85 dBm, from 100 kHz to 1.5 GHz
<-80 dBm, from 1.5 GHz to 1.8 GHz

Input related spurious	-30 dBm signal at input mixer, 20°C to 30°C <-60 dBc
---------------------------	---

Sweep

Time	
None-zero Span	10 ms to 3000 s
Zero Span	1 ms to 3000 s
Span Mode	Continue, Single

Tracking Generator (Only apply to - Opt. 01 Tracking Generator)

Tracking Generator Output

Frequency Range	100 kHz to 1.8GHz
Output power level range	-30 dBm to 0 dBm
Output power level resolution	1 dB
Output flatness	± 3 dB
Maximum safe reverse level	Average total power: 30 dBm, DC : ±50 VDC

Demodulation

Audio Demodulation

Frequency Range	100 kHz to 1.8 GHz
Demodulation Type	FM/AM

AM Measurement

Frequency Range	10MHz to 1.8GHz
Modulation rate	20Hz to 100kHz
Modulation Rate Accuracy	1Hz, nominal (Modulation rate < 1 kHz) <0.1% modulation rate, nominal (Modulation rate ≥ 1 kHz)
Depth	5% to 95%
Depth Accuracy	±4%, nominal

FM Measurement

Frequency Range	10 MHz to 1.8 GHz
Modulation rate	20 Hz to 100 kHz
Modulation Rate Accuracy	1Hz, nominal (Modulation rate < 1 kHz) <0.1% modulation rate, nominal (Modulation rate ≥ 1 kHz)
Deviation	20 Hz to 200 kHz
Deviation Accuracy	±4%, nominal

Frequency Counter

Counter Resolution	1Hz, 10Hz, 100Hz, 1kHz
Accuracy	±(frequency indication × frequency reference accuracy+ counter resolution)

Inputs and Outputs**RF Input**

Impedance	50 Ω , Typical
Connector	N Type Female

Tracking Generator Output

Impedance	50 Ω , Typical
Connector	N Type Female

Reference Input

Connector	BNC Female
10MHz Reference Amplitude	0 dBm to +10 dBm

USB**USB Host**

Connector	A Plug
Protocol	USB 2.0 (Host End)

USB Device

Connector	B Plug
Protocol	2.0 Version

VGA

Connector	15-pins D-SUB(female)
Resolution	800*600, 60 Hz

General Specification**Display**

Type	TFT LCD
Resolution	800*600
Size	10.4 inches
Color	65536

Remote Control

USB	USB TMC
LAN	10/100Base, RJ-45

Mass Memory

Internal Memory	256M Bytes
-----------------	------------

Temperature

Operating Temperature Range	0 $^{\circ}$ C to 40 $^{\circ}$ C
Storage Temperature Range	-20 $^{\circ}$ C to 70 $^{\circ}$ C

Appearance

Dimensions	421 mm (Width) \times 221 mm (Height) \times 115 mm (Depth)
Weight	Approx. 5.0 kg (without package)

Declaration of Conformity

We

GOOD WILL INSTRUMENT CO., LTD.

declare that the below mentioned product

Type of Product: **Spectrum Analyzer**

Model number: **GSP-818**

satisfies all the technical relations application to the product within the scope of council:

Directive: 2014/30/EU; 2014/35/EU; 2011/65/EU; 2012/19/EU

The above product is in conformity with the following standards or other normative documents:

© **EMC**

EN 61326-1 EN 61326-2-1	Electrical equipment for measurement, control and laboratory use -- EMC requirements (2013)	
Conducted & Radiated Emission EN55011: 2009+A1: 2010 Class A	Electrical Fast Transients EN 61000-4-4: 2012	
Current Harmonics EN 61000-3-2: 2014	Surge Immunity EN 61000-4-5: 2006	
Voltage Fluctuations EN 61000-3-3: 2013	Conducted Susceptibility EN 61000-4-6: 2014	
Electrostatic Discharge EN 61000-4-2: 2009	Power Frequency Magnetic Field EN 61000-4-8: 2010	
Radiated Immunity EN 61000-4-3: 2006 +A1:2008+A2:2010	Voltage Dip/ Interruption EN 61000-4-11: 2004	

© **Safety**

Low Voltage Equipment Directive 2014/35/EU	
Safety Requirements	EN 61010-1: 2010 EN 61010-2-030: 2010

GOOD WILL INSTRUMENT CO., LTD.

No. 7-1, Jhongsing Road, Tucheng Dist., New Taipei City 236, Taiwan

Tel: +886-2-2268-0389

Fax: +866-2-2268-0639

Web: www.gwinstek.com

Email: marketing@goodwill.com.tw

GOOD WILL INSTRUMENT (SUZHOU) CO., LTD.

No. 521, Zhujiang Road, Snd, Suzhou Jiangsu 215011, China

Tel: +86-512-6661-7177

Fax: +86-512-6661-7277

Web: www.instek.com.cn

Email: marketing@instek.com.cn

GOOD WILL INSTRUMENT EURO B.V.

De Run 5427A, 5504DG Veldhoven, The Netherlands

Tel: +31(0)40-2557790

Fax: +31(0)40-2541194

Email: sales@gw-instek.eu