

# Digital Storage Oscilloscope

GDS-1000A-U Series

---

## USER MANUAL

GW INSTEK PART NO. 82DS1112A1EB1



ISO-9001 CERTIFIED MANUFACTURER

**GW INSTEK**

This manual contains proprietary information, which is protected by copyright. All rights are reserved. No part of this manual may be photocopied, reproduced or translated to another language without prior written consent of Good Will Corporation.

The information in this manual was correct at the time of printing. However, Good Will continues to improve its products and therefore reserves the right to change the specifications, equipment, and maintenance procedures at any time without notice.

# Table of Contents

<b>SAFETY INSTRUCTIONS.....</b>	<b>8</b>
Safety Symbols .....	8
Safety Guidelines.....	9
Power cord for the United Kingdom.....	12
<b>GETTING STARTED .....</b>	<b>13</b>
Main Features .....	13
Panel Overview.....	15
Front Panel .....	15
Rear Panel.....	18
Display.....	19
Setting up the Oscilloscope.....	20
<b>QUICK REFERENCE .....</b>	<b>23</b>
Menu Tree and Shortcuts.....	23
CH1/CH2 key .....	24
Cursor key 1/2 .....	25
Cursor key 2/2 .....	25
Display key.....	26
Autoset key .....	26
Hardcopy key.....	26
Help key.....	27
Horizontal menu key.....	27
Math key 1/2 (+/-/x).....	29
Math key 2/2 (FFT/FFT rms) .....	30
Measure key.....	31
Run/Stop key.....	31
Save/Recall key 1/10 .....	32
Save/Recall key 2/10 .....	32
Save/Recall key 3/10 .....	33
Save/Recall key 4/10 .....	33
Save/Recall key 5/10 .....	34
Save/Recall key 6/10 .....	34
Save/Recall key 7/10 .....	35
Save/Recall key 8/10 .....	35
Save/Recall key 9/10 .....	36
Save/Recall key 10/10 .....	36
Trigger key 1/6.....	37

Trigger key 2/6 .....	37
Trigger key 3/6 .....	38
Trigger key 4/6 .....	38
Trigger key 5/6 .....	39
Trigger key 6/6 .....	39
Utility key 1/10 (Utility #1) .....	40
Utility key 2/10 (Utility #2) .....	40
Utility key 3/10 (Utility #3) .....	41
Utility key 4/10 (Hardcopy -Save All).....	41
Utility key 5/10 (Hardcopy -Save Image).....	42
Utility key 6/10 (Probe compensation) .....	42
Utility key 7/10 (Go-NoGo) .....	43
Utility key 8/10 (Data Logging 1/2) .....	43
Utility key 9/10 (Data Logging 2/2) .....	44
Utility key 10/10 (Self CAL Menu) .....	44
Default Settings .....	45
Built-in Help .....	46

**MEASUREMENT ..... 47**

Basic Measurements .....	47
Activating a channel.....	47
Using Autoset .....	48
Running and stopping the trigger .....	50
Changing the horizontal position and scale.....	51
Changing the vertical position and scale .....	52
Using the probe compensation signal .....	53
Automatic Measurements.....	55
Measurement items.....	55
Automatic measurement gating.....	57
Automatically measuring the input signals.....	58
Cursor Measurements .....	61
Using the horizontal cursors .....	61
Using the vertical cursors .....	62
Math Operations .....	63
Overview.....	63
Adding, subtracting or multiplying signals .....	64
Using the FFT function .....	65
Go No-Go Testing.....	67
Overview.....	67
Edit: NoGo When.....	68
Edit: Source .....	68
Edit: NoGo Violation Conditions .....	69
Edit: Template (boundary).....	69

Run Go-NoGo Tests.....	73
Data Logging.....	74
Overview.....	74
Edit: Source.....	75
Edit: Setup Parameters.....	75
Run Data logging.....	77
<b>CONFIGURATION .....</b>	<b>78</b>
Acquisition.....	78
Selecting the acquisition mode.....	78
Selecting Delay mode.....	80
Real time vs Equivalent time sampling mode.....	82
Display.....	83
Selecting vector or dot drawing.....	83
Accumulating the waveform.....	83
Adjusting the display contrast.....	84
Selecting the display grid.....	84
Horizontal View.....	85
Moving the waveform position horizontally.....	85
Selecting the horizontal scale.....	85
Selecting the waveform update mode.....	86
Zooming the waveform horizontally.....	87
Viewing waveforms in the X-Y mode.....	88
Horizontal Adjustment Menu.....	89
Vertical View (Channel).....	91
Moving the waveform position vertically.....	91
Selecting the vertical scale.....	91
Selecting the coupling mode.....	91
Expand Vertical Scale Center / Ground.....	92
Inverting the waveform vertically.....	93
Limiting the waveform bandwidth.....	94
Probe attenuation level and type.....	94
Trigger.....	96
Trigger type.....	96
Trigger parameter.....	96
Configuring Holdoff.....	98
Configuring the edge trigger.....	99
Configuring the video trigger.....	100
Configuring the pulse width trigger.....	101
Manually triggering the signal.....	103
Remote Control Interface.....	104
System Settings.....	105
Viewing the system information.....	105

Selecting the language..... 105

**SAVE/RECALL..... 107**

File Structures ..... 107

- Display image file format..... 107
- Waveform file format ..... 107
- Setup file format ..... 110
- Using the USB file utilities..... 111

Quick Save (HardCopy) ..... 113

Save ..... 115

- File type/source/destination..... 115
- Saving the panel settings..... 116
- Saving the waveform..... 117
- Saving the display image ..... 119
- Saving all (panel settings, display image, waveform) ..... 120

Recall ..... 122

- File type/source/destination..... 122
- Recalling the default panel settings..... 123
- Recalling a reference waveform to the display ..... 124
- Recalling panel settings ..... 124
- Recalling a waveform ..... 125
- Recall Image..... 127

**MAINTENANCE..... 129**

Vertical Resolution Calibration ..... 129

Probe Compensation ..... 130

**FAQ ..... 132**

- The input signal does not appear in the display. .... 132
- I want to remove some contents from the display. .... 132
- The waveform does not update (frozen)..... 133
- The probe waveform is distorted..... 133
- Autoset does not catch the signal well..... 133
- I want to clean up the cluttered panel settings. .... 133
- The saved display image is too dark on the background. . 133
- The accuracy does not match the specifications. .... 134
- The oscilloscope will not allow a 2M waveform to be saved. .... 134

**APPENDIX..... 135**

Fuse Replacement ..... 135

GDS-1000A-U Series Specifications .....	136
Model-specific specifications .....	136
Common specifications .....	137
Probe Specifications .....	139
GDS-1072A-U Probe.....	139
GDS-1102A-U Probe.....	139
GDS-1152A-U Probe.....	139
Dimensions .....	141
EC Declaration of Conformity .....	142
<b>INDEX .....</b>	<b>143</b>

# S SAFETY INSTRUCTIONS

This chapter contains important safety instructions that should be followed when operating and storing the oscilloscope. Read the following before any operation to ensure your safety and to keep the oscilloscope in the best condition.

## Safety Symbols

These safety symbols may appear in this manual or on the oscilloscope.

---



Warning: Identifies conditions or practices that could result in injury or loss of life.



Caution: Identifies conditions or practices that could result in damage to the oscilloscope or to other objects or property.



**DANGER** High Voltage



Attention: Refer to the Manual



Protective Conductor Terminal



Earth (Ground) Terminal





Do not dispose electronic equipment as unsorted municipal waste. Please use a separate collection facility or contact the supplier from which this instrument was purchased.

## Safety Guidelines

---

### General Guideline



### CAUTION

- Make sure the BNC input voltage does not exceed 300V peak.
- Never connect a hazardous live voltage to the ground side of the BNC connectors. It might lead to fire and electric shock.
- Do not place heavy objects on the oscilloscope.
- Avoid severe impact or rough handling that may damage the oscilloscope.
- Avoid discharges of static electricity on or near the oscilloscope.
- Use only mating connectors, not bare wires, for the terminals.
- Do not block the cooling fan vent.
- Do not perform measurements at power sources and building installation sites (Note below).
- The oscilloscope should only be disassembled by a qualified technician.

(Measurement categories) EN 61010-1:2001 specifies the measurement categories and their requirements as follows. The GDS-1000A-U falls under category II.

- Measurement category IV is for measurement performed at the source of a low-voltage installation.
  - Measurement category III is for measurement performed in a building installation.
  - Measurement category II is for measurement performed on circuits directly connected to a low voltage installation.
  - Measurement category I is for measurements performed on circuits not directly connected to Mains.
-

- 
- Power Supply
- AC Input voltage: 100 ~ 240V AC, 47 ~ 63Hz
  - The power supply voltage should not fluctuate more than 10%.



WARNING

- Connect the protective grounding conductor of the AC power cord to an earth ground.
- 

- Fuse
- Fuse type: T1A/250V



WARNING

- To ensure fire protection, replace the fuse only with the specified type and rating.
  - Disconnect the power cord before replacing the fuse.
  - Make sure the cause of fuse blowout is fixed before replacing the fuse.
- 

- Cleaning the oscilloscope
- Disconnect the power cord before cleaning the oscilloscope.
  - Use a soft cloth dampened in a solution of mild detergent and water. Do not spray any liquid into the oscilloscope.
  - Do not use chemicals containing harsh products such as benzene, toluene, xylene, and acetone.
- 

- Operation Environment
- Location: Indoor, no direct sunlight, dust free, almost non-conductive pollution (Note below)
  - Relative Humidity:  $\leq 80\%$ , 40°C or below  
 $\leq 45\%$ , 41°C~50°C
  - Altitude: < 2000m
  - Temperature: 0°C to 50°C

(Pollution Degree) EN 61010-1:2001 specifies pollution degrees and their requirements as follows. The oscilloscope falls under degree 2.

Pollution refers to “addition of foreign matter, solid, liquid, or gaseous (ionized gases), that may produce a reduction of dielectric strength or surface resistivity”.

- Pollution degree 1: No pollution or only dry, non-conductive pollution occurs. The pollution has no influence.
- Pollution degree 2: Normally only non-conductive pollution occurs. Occasionally, however, a temporary conductivity caused by condensation must be expected.
- Pollution degree 3: Conductive pollution occurs, or dry, non-conductive pollution occurs which becomes conductive due to condensation which is expected. In such conditions, equipment is normally protected against exposure to direct sunlight, precipitation, and full wind pressure, but neither temperature nor humidity is controlled.

---

Storage environment

- Location: Indoor
- Storage Temperature:  $-10^{\circ}\text{C}\sim 60^{\circ}\text{C}$ , no condensation-
- Relative Humidity: 93% @  $40^{\circ}\text{C}$   
65% @  $41^{\circ}\text{C}\sim 60^{\circ}\text{C}$

---

Disposal



Do not dispose this instrument as unsorted municipal waste. Please use a separate collection facility or contact the supplier from which this instrument was purchased. Please make sure discarded electrical waste is properly recycled to reduce environmental impact.

## Power cord for the United Kingdom

When using the oscilloscope in the United Kingdom, make sure the power cord meets the following safety instructions.

NOTE: This lead/appliance must only be wired by competent persons

 **WARNING: THIS APPLIANCE MUST BE EARTHED**

IMPORTANT: The wires in this lead are coloured in accordance with the following code:

Green/ Yellow:	Earth
Blue:	Neutral
Brown:	Live (Phase)



As the colours of the wires in main leads may not correspond with the coloured marking identified in your plug/appliance, proceed as follows:

The wire which is coloured Green & Yellow must be connected to the Earth terminal marked with either the letter E, the earth symbol (⊕) or coloured Green/Green & Yellow.

The wire which is coloured Blue must be connected to the terminal which is marked with the letter N or coloured Blue or Black.

The wire which is coloured Brown must be connected to the terminal marked with the letter L or P or coloured Brown or Red.

If in doubt, consult the instructions provided with the equipment or contact the supplier.

This cable/appliance should be protected by a suitably rated and approved HBC mains fuse: refer to the rating information on the equipment and/or user instructions for details. As a guide, a cable of 0.75mm<sup>2</sup> should be protected by a 3A or 5A fuse. Larger conductors would normally require 13A types, depending on the connection method used.

Any exposed wiring from a cable, plug or connection that is engaged in a live socket is extremely hazardous. If a cable or plug is deemed hazardous, turn off the mains power and remove the cable, any fuses and fuse assemblies. All hazardous wiring must be immediately destroyed and replaced in accordance to the above standard.

# G GETTING STARTED

The Getting started chapter introduces the oscilloscope's main features, appearance, and set up procedure.

## Main Features

Model name	Frequency bandwidth	Input channels
GDS-1072A-U	DC – 70MHz (–3dB)	2
GDS-1102A-U	DC – 100MHz (–3dB)	2
GDS-1152A-U	DC – 150MHz (–3dB)	2
Performance	<ul style="list-style-type: none"> <li>• 1 GS/s real-time sampling rate</li> <li>• 25GS/s equivalent-time sampling rate</li> <li>• 2M points record length</li> <li>• Up to 10ns peak detection</li> <li>• 2mV~10V vertical scale</li> <li>• 1ns ~ 50s time scale</li> </ul>	
Features	<ul style="list-style-type: none"> <li>• 5.7 inch color TFT display</li> <li>• Saving and recalling setups and waveforms</li> <li>• 27 automatic measurements</li> <li>• Multi-language menu (12 languages)</li> <li>• Math operation: Addition, Subtraction, multiplication, FFT, FFT RMS</li> <li>• Data logging</li> <li>• Go-NoGo testing</li> <li>• Edge, video, pulse width trigger</li> </ul>	

- 
- Compact size: (W) 310 × (D) 140 × (H) 142 mm
  - Probe factor from 0.1X~2000X voltage/current
- 
- Interface
- USB 2.0 full-speed interface for saving and recalling data
  - Calibration output
  - External trigger input
  - USB slave interface for remote control

# Panel Overview

## Front Panel

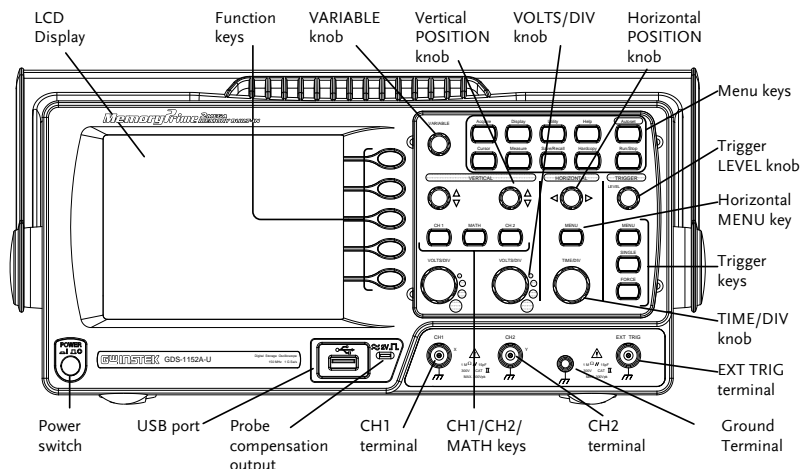

LCD display      TFT color, 320 x 234 resolution, wide angle view LCD display.

Function keys: F1 (top) to F5 (bottom)		Activates the functions which appear in the left side of the LCD display.
--	--	---













Variable knob	VARIABLE 	Increases or decreases values and moves to the next or previous parameter.
---------------	--------------	--

Acquire key	Acquire 	Configures the acquisition mode (page 78).
-------------	-------------	--













Display key	Display 	Configures the display settings (page 83).
-------------	-------------	--

Cursor key	Cursor 	Runs cursor measurements (page 61).
------------	------------	-------------------------------------

(Continued on next page)

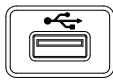
Utility key		Configures the Hardcopy function (page 113), shows the system status (page 105), selects the menu language (page 105), runs the self calibration (page 129) and configures the probe compensation signal (page 130).
Help key		Shows the Help contents on the display (page 46).
Autoset key		Automatically configures the horizontal, vertical, and trigger settings according to the input signal (page 48).
Measure key		Configures and runs automatic measurements (page 55).
Save/Recall key		Saves and recalls images, waveforms, or panel settings (page 107).
Hardcopy key		Stores images, waveforms, or panel settings to USB (page 113).
Run/Stop key		Runs or stops triggering (page 50).
Trigger level knob		Sets the trigger level (page 96).
Trigger menu key		Configures the trigger settings (page 96).
Single trigger key		Selects the single triggering mode (page 103).
Trigger force key		Acquires the input signal once regardless of the trigger condition at the time (page 103).
Horizontal menu key		Configures the horizontal view (page 85).



Horizontal position knob		Moves the waveform horizontally (page 85).
TIME/DIV knob		Selects the horizontal scale (page 85).
Vertical position knob		Moves the waveform vertically (page 91).
CH1/CH2 key		Configures the vertical scale and coupling mode for each channel (page 91).
VOLTS/DIV knob		Selects the vertical scale (page 91).
Input terminal		Accepts input signals: $1M\Omega \pm 2\%$ input impedance, BNC terminal.
Ground terminal		Accepts the DUT ground lead to achieve a common ground.
MATH key		Performs math operations (page 63).
USB port		Facilitates transferring waveform data, display images, and panel settings (page 107).
Probe compensation output		Outputs a 2Vp-p, square signal for compensating the probe (page 130) or demonstration.
External trigger input		Accepts an external trigger signal (page 96).
Power switch		Powers the oscilloscope on or off.

## Rear Panel

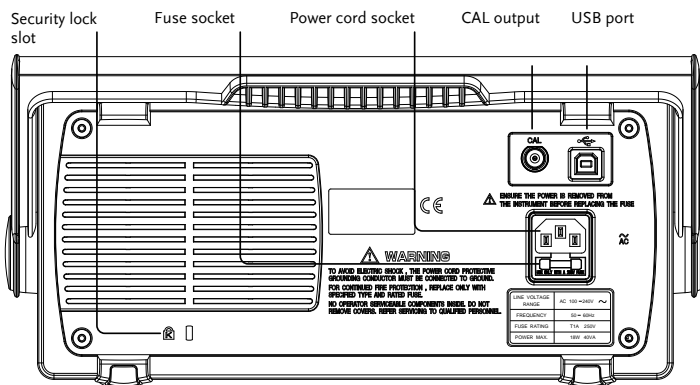

Power cord socket

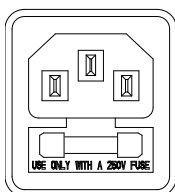

Power cord socket accepts the AC mains, 100 ~ 240V, 50/60Hz.

Fuse socket

The fuse socket holds the AC main fuse, T1A/250V.

For the fuse replacement procedure, see page 135.

USB slave port



Accepts a type B (slave) male USB connector for remote control of the oscilloscope (page 104).

Calibration output



Outputs the calibration signal used in vertical scale accuracy calibration (page 129).

Security lock slot



Standard laptop security lock slot for ensuring the security of the GDS-1000A-U.

Display

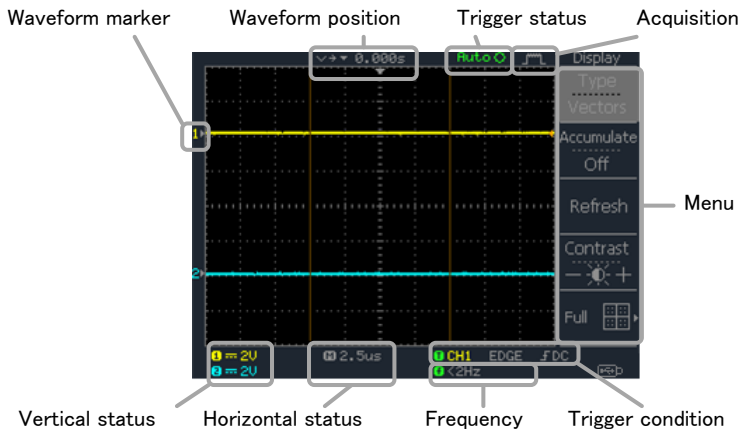

Waveforms	Channel 1: Yellow	Channel 2: Blue
Trigger status	Trig'd	A signal is being triggered
	Trig?	Waiting for a trigger condition
	Auto	Updating the input signal regardless of trigger conditions
	STOP	Triggering is stopped
	For trigger setting details, see page 96.	
Input signal frequency	Updates the input signal frequency (the trigger source signal) in real-time. “< 2Hz” Indicates that the signal frequency is less than the lower frequency limit (2Hz) and thus not accurate.	
Trigger configuration	Shows the trigger source, type, and slope. In case of the Video trigger, shows the trigger source and polarity.	
Horizontal status	Shows the channel configurations: coupling mode, vertical scale, and horizontal scale.	
Vertical status		

## Setting up the Oscilloscope

**Background** This section describes how to set up the oscilloscope properly including adjusting the handle, connecting a signal, adjusting the scale, and compensating the probe. Before operating the oscilloscope in a new environment, run these steps to make sure the oscilloscope is functionally stable.

**Procedure**

1. Pull both bases of the handle out slightly.

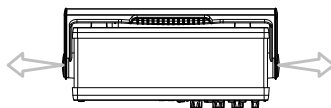

2. Turn to one of the three preset positions.

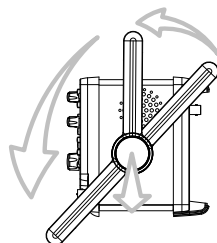

3. Connect the power cord.

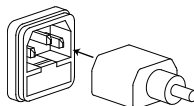

4. Press the power switch. The display will become active in approximately 10 seconds.



5. Reset the system by recalling the factory settings. Press the Save/Recall key, then *Default Setup*. For details regarding the factory settings, see page 45.



6. Connect the probe between the Channel1 input terminal and probe compensation signal output (2Vp-p, 1kHz square wave).
7. Set the probe attenuation voltage to x10.

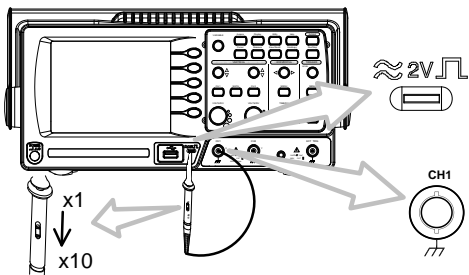

8. Press the Autoset key. A square waveform will appear in the center of the display. For details on Autoset, see page 48.



9. Press the Display key, then *Type* and select the vector waveform type.

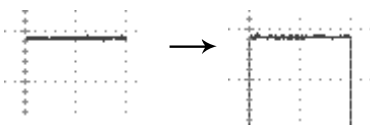
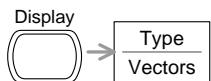

10. Turn the adjustment point on the probe to flatten the square waveform edge.

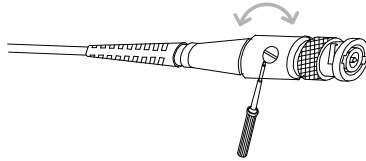
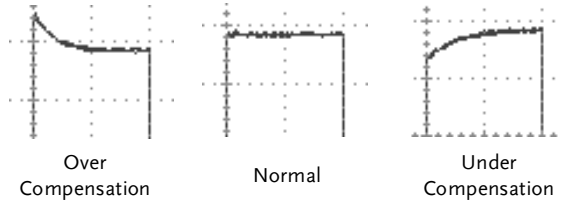

11. Setting up the oscilloscope is complete. You may continue with the other operations.



Measurement: page 47 Configuration: page 78

# QUICK REFERENCE

This chapter lists the oscilloscope menu tree, operation shortcuts, built-in help coverage, and default factory settings. Use this chapter as a handy reference to access the oscilloscope functions.

## Menu Tree and Shortcuts

---

Conventions	Examples
Normal	= Press the functionality key for "Normal"
Average 	= Repeatedly press the functionality key for "Average"
Normal ~ Average	= Select a menu from "Normal" to "Average" and press its functionality key
Normal → VAR 	= Press the functionality key for "Normal", and then use the Variable knob

## Acquire key

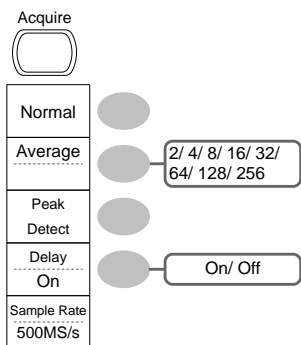

Select acquisition mode

Normal ~ Peak-Detect

Select average number

Average

Turn Delay on/off

Delay On

## CH1/CH2 key

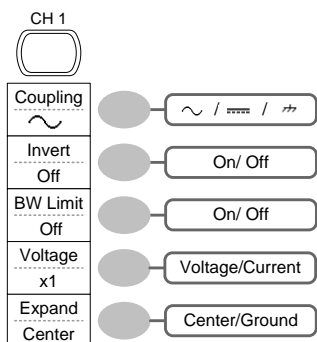

Turn channel on/off

CH 1/2

Select coupling mode

Coupling

Invert waveform

Invert

Turn bandwidth limit on/off

BW Limit

Select probe type

Voltage ↔ Current

Select probe attenuation

VAR (0.1x~2000x) (1-2-5 step)

Expand type

Expand



### Cursor key 1/2

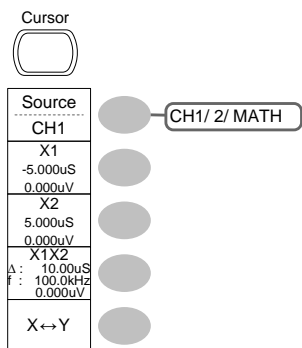

Turn cursor on/off  
Cursor

Move X1 cursor  
X1 → VAR

Move X2 cursor  
X2 → VAR

Move both X1 and X2 cursor  
X1X2 → VAR

Switch to Y cursor  
X↔Y

### Cursor key 2/2

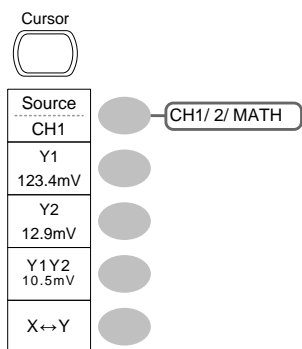

Turn cursor on/off  
Cursor

Move Y1 cursor  
Y1 → VAR

Move Y2 cursor  
Y2 → VAR

Move both Y1 and Y2 cursor  
Y1Y2 → VAR

Switch to X cursor  
X↔Y

## Display key

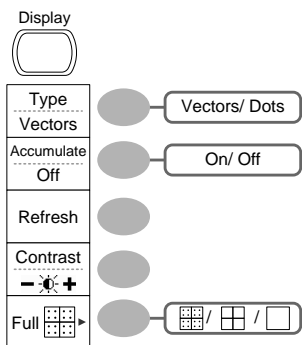

Select waveform type

Type ↩

Waveform accumulate On/Off

Accumulate ↩

Refresh accumulation

Refresh

Set display contrast

Contrast → VAR ⌚

Select display grid



## Autoset key

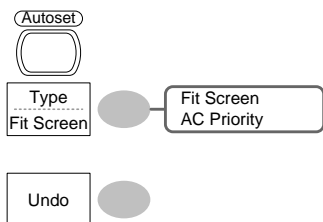

Automatically find the signal and set the scale

Autoset

Change the Type of Autoset mode.

Type ↩ (available for a few seconds)

Undo Autoset

Undo ↩ (available for a few seconds)

## Hardcopy key

Hardcopy

→ See Utility key (page 40)



## Help key



Turn help mode on/off

Help

## Horizontal menu key

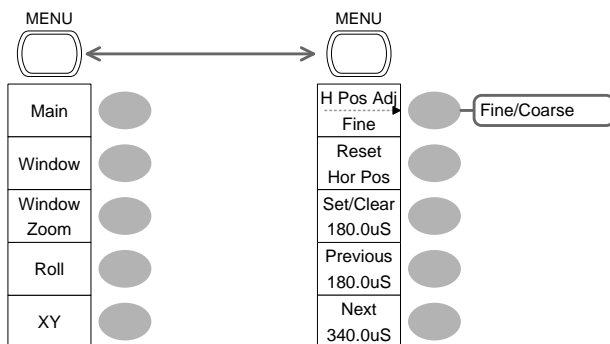

Switch from Vertical Menu to Horizontal Position Menu.      Horizontal MENU

Select main (default) display      Main

Select window mode      Window → TIME/DIV

Zoom in window mode      Window Zoom

Select window roll mode      Roll

Select XY mode      XY

Toggle adjustment mode      H Pos Adj

Reset horizontal marker      Reset

Set Horizontal marker/delete horizontal marker.      HOR → Set/Clear

Navigate to previous horizontal marker.      Previous

Navigate to next horizontal  
marker.

Next

**Math key 1/2 (+/-/x)**

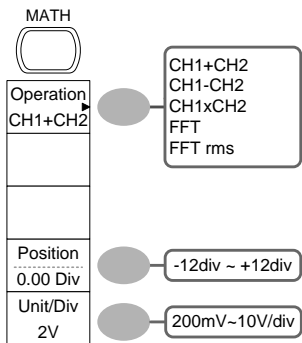

Math on/off  
 Math

Select math operation type (+/-  
 /x/FFT/FFT rms)  
 Operation

Set result position  
 Position → VAR

Math result Volt/Div  
 Unit/Div → VOLTS/DIV(CH2)

## Math key 2/2 (FFT/FFT rms)

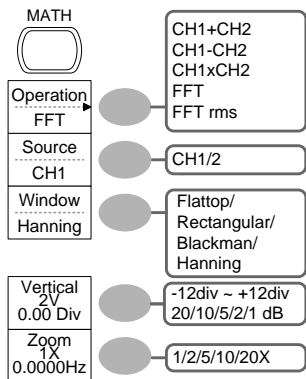

Math on/off

Math

Select math operation type (+/-  
/x/FFT/FFT rms)

Operation

Select FFT source channel

Source

Select FFT window

Window

Select FFT result position

Vertical → VAR

Select vertical scale

Vertical → VOLTS/DIV

Select vertical units

Vertical

Select Zoom level

Zoom(X) → VAR

Select Horizontal position

Zoom(Hz) → VAR

## Measure key

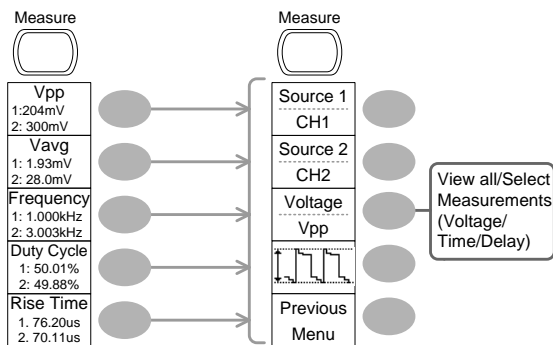

Turn on/off measurement	Measure
Select measurement type	Voltage/Time/Delay
Select measurement item	VAR  or Icon(F3)  / → VAR
Go back to previous menu	Previous Menu

## Run/Stop key

Run/Stop	Freeze/unfreeze waveform or trigger
	Run/Stop

## Save/Recall key 1/10

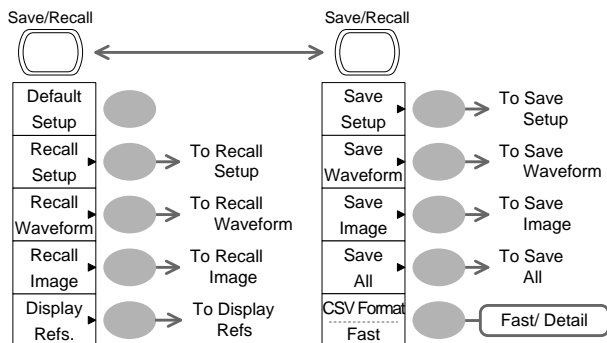

Switch to Save or Recall menu    Save/Recall

Recall default setup    Default Setup

Change CSV format    CSV Format

## Save/Recall key 2/10

### Recall Setup

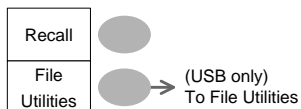
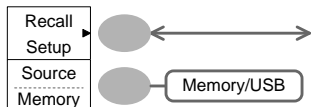

Select other menu

Recall Setup

Select setup source

Source → VAR

Recall setup

Recall

Go to USB file utilities

File Utilities



### Save/Recall key 3/10

#### Recall Waveform

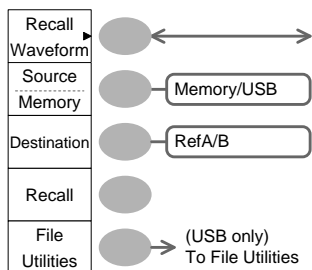

Select other menu

Recall Waveform ←

Select waveform source

Source ← → VAR ○

Select waveform destination

Destination → VAR ○

Recall waveform

Recall

Go to USB file utilities

File Utilities

### Save/Recall key 4/10

#### Recall Image

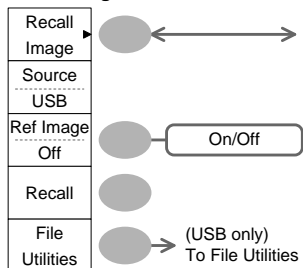

Select other menu

Recall Image ←

Turn reference image on/off

Ref image ←

Recall waveform

Recall

Go to USB file utilities

File Utilities

### Save/Recall key 5/10

#### Display Refs.

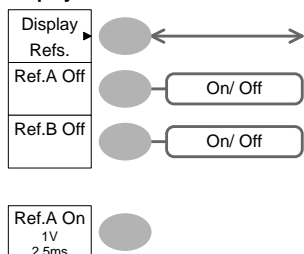

Select other menu

Display Refs.

Turn ref. waveform A on/off

Ref.A

Turn ref. waveform B on/off

Ref.B

### Save/Recall key 6/10

#### Save Setup

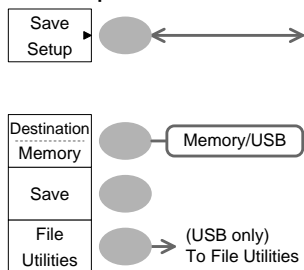

Select other menu

Save Setup

Select destination

Destination → VAR

Save setup

Save

Go to USB file utilities

File Utilities

### Save/Recall key 7/10

#### Save Waveform

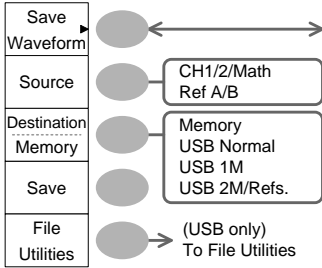

Select other menu

Save Waveform ←

Select source

Source ← → VAR ○

Select destination

Destination ← → VAR ○

Save waveform

Save

Go to USB file utilities

File Utilities

### Save/Recall key 8/10

#### Save Image

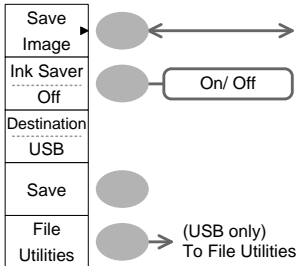

Select other menu

Save Image ←

Turn on/off ink saver

Ink Saver ←

Save image

Save

Go to USB file utilities

File Utilities

### Save/Recall key 9/10

**Save All**

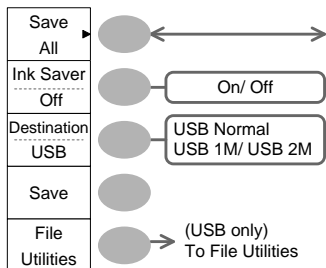

Select other menu

Save All ↩

Turn on/off ink saver

Ink Saver ↩

Select destination

Destination ↩ → VAR ⦿

Save all

Save

Go to USB file utilities

File Utilities

### Save/Recall key 10/10

**File Utilities**

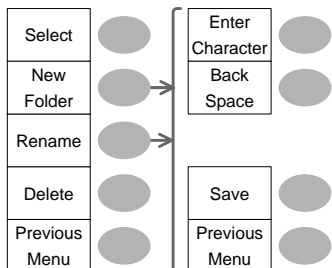

Select file/folder

VAR ⦿ → Select

Create or rename folder/file

New Folder/Rename

VAR ⦿ → Enter character / Backspace / Save / Previous menu

Delete folder/file

Delete

Go to previous menu

Previous menu

### Trigger key 1/6

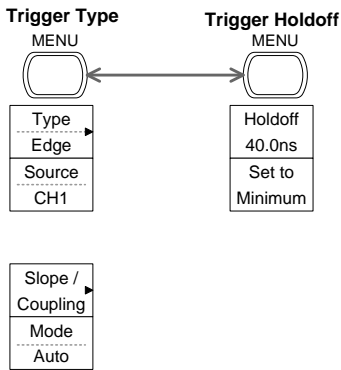

Select Trigger type or Trigger Holdoff menu  
Type ↵

### Trigger key 2/6

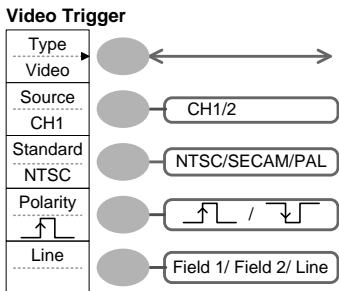

Select video trigger type  
Type ↵

Select trigger source  
Source ↵

Select video standard  
Standard ↵

Select video polarity  
Polarity ↵

Select video field/line  
Line ↵ → VAR ○

### Trigger key 3/6

#### Edge Trigger

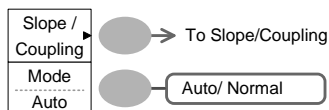
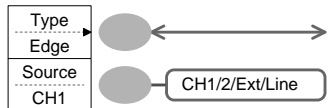

Select edge trigger type

Edge

Select trigger source

Source

Go to slope/coupling menu (page 39)

Slope/Coupling

Select trigger mode

Mode

### Trigger key 4/6

#### Pulse Trigger

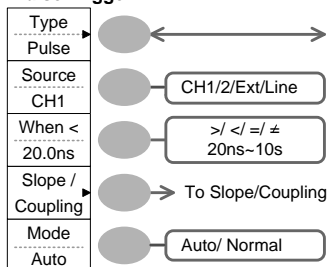

Select pulse trigger type

Type

Select trigger source

Source

Select pulse trigger condition and pulse width

When  → VAR

Go to slope/coupling menu (page 39)

Slope/Coupling

Select trigger mode

Mode

### Trigger key 5/6

**Coupling/Slope**

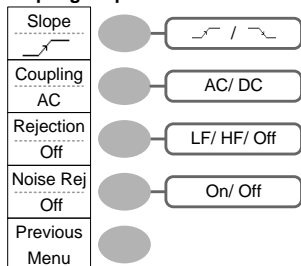

Select trigger slope type  
Slope ↩

Select trigger coupling mode  
Coupling ↩

Select frequency rejection  
Rejection ↩

Turn noise rejection on/off  
Noise Rej ↩

Go back to previous menu  
Previous Menu

### Trigger key 6/6

**Trigger Holdoff**

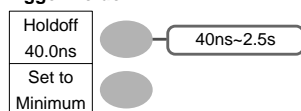

Select Holdoff time  
VAR ⌚

Set to minimum Holdoff time  
Set to Minimum ↩

## Utility key 1/10 (Utility #1)

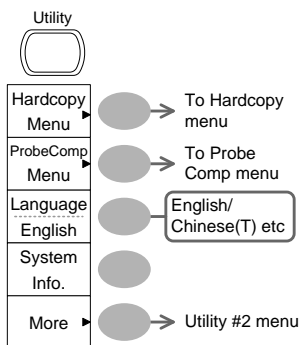

Go to hardcopy menu

Hardcopy

Go to probe compensation menu

ProbeComp

Select language

Language

Show system information

System Info.

Go to the next Utility menu

More

## Utility 2/10 (Utility #2)

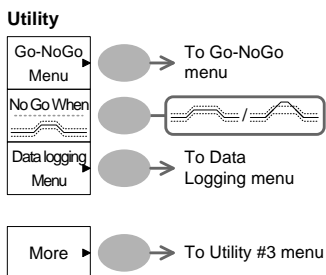

Go to the Go-NoGo menu

Go-NoGo

Set the NoGo conditions to inside / outside limits

No Go When

Go to the Data Logging Menu

Data Logging

Go to the next Utility menu

More



### Utility key 3/10 (Utility #3)

**Calibration**

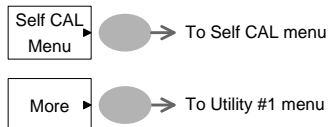

- Enter self calibration
- Self CAL
- Go to the first Utility menu
- More

### Utility key 4/10 (Hardcopy -Save All)

**Hardcopy – Save All**

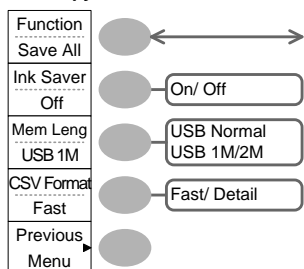

- Select Hardcopy function
- Function ←
- Turn on/off Ink saver
- Ink Saver ←
- Set the memory length
- Mem Leng ←
- Change CSV format
- CSV Format ←
- Go to previous menu
- Previous Menu ←

### Utility key 5/10 (Hardcopy -Save Image)

#### Hardcopy – Save Image

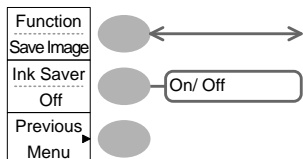

Select Hardcopy function

Function ↩

Turn on/off Inksaver

Ink Saver ↩

Go to previous menu

Previous Menu ↩

### Utility key 6/10 (Probe compensation)

#### Probe compensation

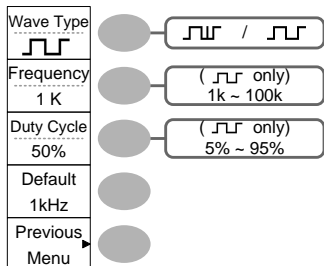

Select probe compensation signal

Wave Type ↩

Set frequency for square wave

Frequency → VAR ⦿

Set duty cycle for square wave

Duty Cycle → VAR ⦿

Go to previous menu

Previous Menu

### Utility key 7/10 (Go-NoGo)

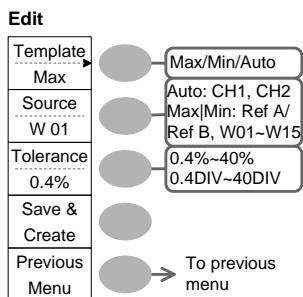

Switch between templates

Template ←

Select the template source

Source ←

Set the tolerance (% or Divisions)

Tolerance ← → VAR ○

Save the template

Save & Create

Go back to previous menu

Previous Menu

### Utility key 8/10 (Data Logging 1/2)

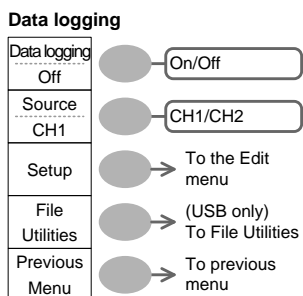

Turn Data Logging On/Off

Data logging ←

Set the logging source

Source ←

Go to the Data Logging Edit menu

Setup

Go to the File Utilities menu

File Utilities

Go back to previous menu

Previous Menu

### Utility key 9/10 (Data Logging 2/2)

**Edit**

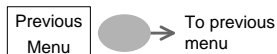
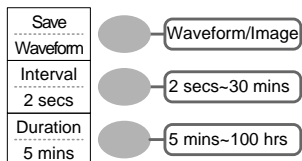

Save the logs as waveform data or as image files

Save ↩

Set the logging interval

Interval → VAR ⌚

Set the duration of the record log

Duration → VAR ⌚

Go back to previous menu

Previous Menu

### Utility key 10/10 (Self CAL Menu)

**Self Cal.**

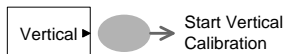





Start Vertical Calibration

Vertical

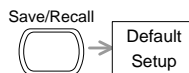
## Default Settings

Here are the factory installed panel settings which appear when pressing the Save/Recall key → *Default Setup*.



Acquisition	Mode: Normal	
Channel	Scale: 2V/Div	Invert: Off
	Coupling: DC	Probe attenuation voltage: x1
	BW limit: Off	Channel 1 & 2: On
Cursor	Source: CH1	Cursor: Off
Display	Type: Vectors	Accumulate: Off
	Grid: Full 	
Horizontal	Scale: 2.5us/Div	Mode: Main Timebase
	H Pos Adj: Fine	Hor Pos: 0
Math	Type: + (Add)	Position: 0.00 Div
	Unit/Div: 2V	
Measure	Item: Vpp, Vavg, Frequency, Duty Cycle, Rise Time	
Trigger	Type: Edge	Source: Channel1
	Mode: Auto	Slope: 
	Coupling: DC	Rejection: Off
	Noise Rejection: Off	
Utility	Hardcopy: SaveImage, InkSaver On	ProbeComp: Square wave, 1k, 50% duty cycle
Go-NoGo	Go-NoGo: Off	Source: CH1
	When: 	Violating: Stop

(Continued)

Data Logging	Data logging: Off	Source: CH1
	Setup: Waveform	Interval: 2 secs
	Duration: 5 mins	

## Built-in Help

The Help key shows the contents of the built-in help support. When you press a function key, its descriptions appear in the display.



### Applicable keys

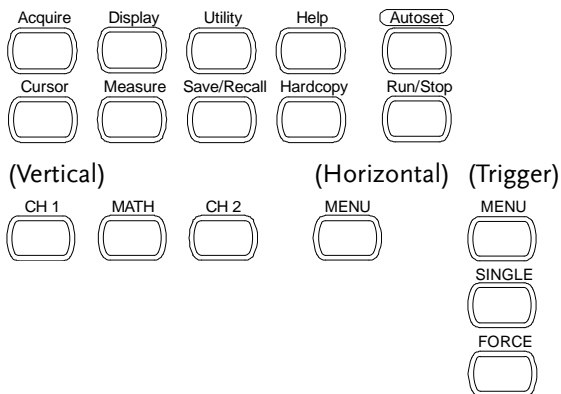

### Procedure

1. Press the Help key. The display changes to the Help mode.
2. Press a functional key to access its help contents. (example: Acquire key)
3. Use the Variable knob to scroll the Help contents up and down.
4. Press the Help key again to exit the Help mode.



# M EASUREMENT

The Measurement chapter describes how to properly observe a signal using the oscilloscope's basic functions, and how to observe a signal in a detailed manner using some of the advanced functions such as:

Automatic measurements, cursor measurements, and math operations.

## Basic Measurements

This section describes the basic operations required in capturing and viewing an input signal. For more detailed operations, see the following chapters.

- Measurements → from page 47
- Configuration → from page 78

### Activating a channel

---

Activating a channel

To activate an input channel, press the Channel key, CH1 or CH2. The channel indicator appears at the left side of the display and the channel icon changes accordingly.

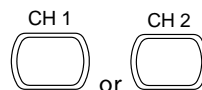

(Continued on next page)

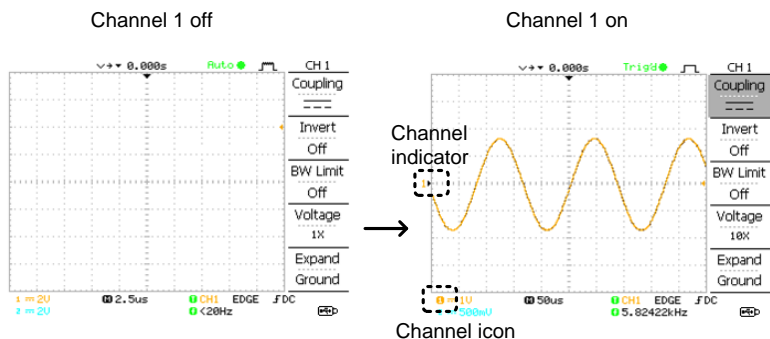

De-activating a channel

To de-activate the channel, press the Channel key twice (once if the channel menu is already selected).

## Using Autoset

Background

The Autoset function automatically configures the panel settings to the best viewing conditions, in the following way.

- Selecting the horizontal scale
- Positioning the waveform horizontally
- Selecting the vertical scale
- Positioning the waveform vertically
- Selecting the trigger source channel
- Activating the channels

Autoset can be configured into two types of modes, AC Priority Mode or Fit Screen Mode.

AC Priority mode will scale the waveform to the screen removing any DC component.

Fit Screen Mode will fit the waveform to the best scale, including any DC components (offset).



Procedure

1. Connect the input signal to the oscilloscope and press the Autoset key.



2. The waveform(s) appears in the center of the display.

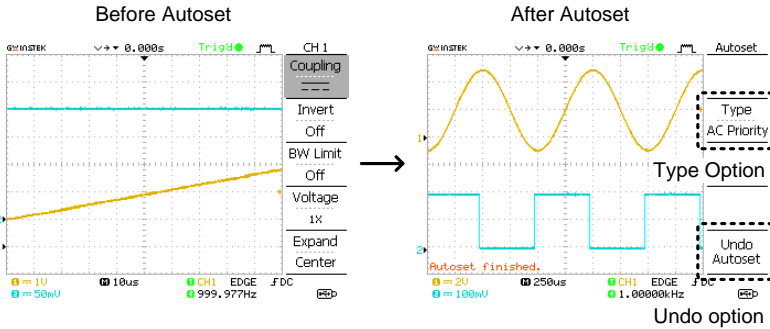

Undoing the Autoset

To undo the Autoset, press *Undo* (available for a few seconds).

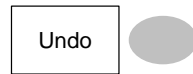

Adjusting the trigger level

If the waveform is still unstable, try adjusting the trigger level up or down by using the Trigger Level knob.



Change Modes

To change the type of mode, press *Type* (available for a few seconds). The Type icon will change to next type.

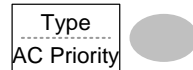

Type      Fit Screen, AC Priority

The next time the Autoset key is pressed, the new mode will be activated.

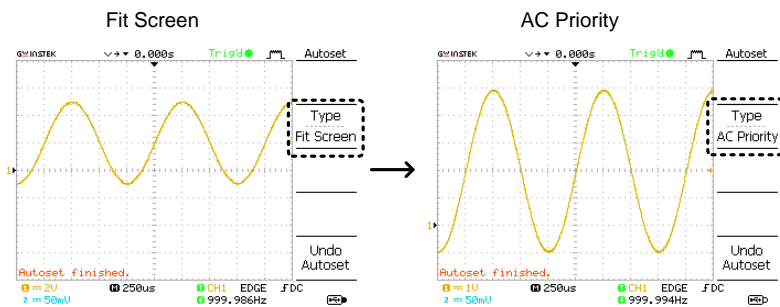

Limitation

Autoset does not work in the following situation.

- Input signal frequency less than 20Hz
- Input signal amplitude less than 30mV

Running and stopping the trigger

Background

In the trigger Run mode, the oscilloscope constantly searches for a trigger condition and updates the signal onto the display when the condition is met.

In the trigger Stop mode, the oscilloscope stops triggering and thus the last acquired waveforms stay in the display. The trigger icon at the top of the display changes into Stop mode.

Pressing the Trigger Run/Stop key switches between the Run and Stop mode.

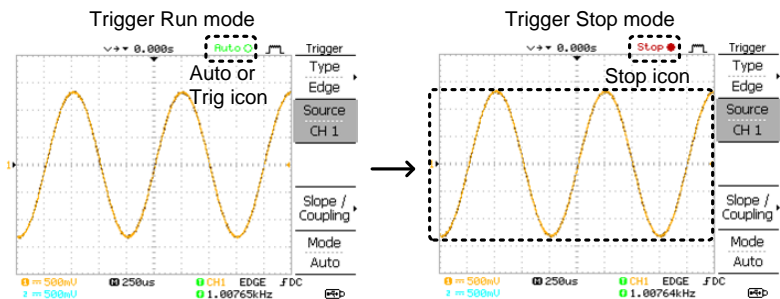

Waveform operation Waveforms can be moved or scaled in both the Run and Stop mode. For details, see page 85 (Horizontal position/scale) and page 91 (Vertical position/scale).

### Changing the horizontal position and scale

For more detailed configurations, see page 85.

Setting the horizontal position

The horizontal position knob moves the waveform left or right.

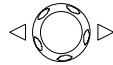

The position indicator moves along with the waveform and the distance from the center point is displayed as the offset in the upper side of the display.

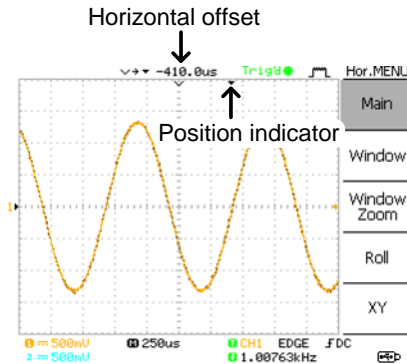

Selecting the horizontal scale

To select the timebase (scale), turn the TIME/DIV knob; left (slow) or right (fast).

TIME/DIV



Range 1ns/Div ~ 10s/Div, 1-2.5-5 increment

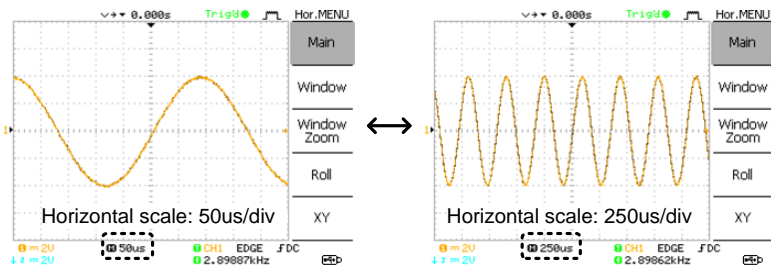

## Changing the vertical position and scale

For more detailed configuration, see page 91.

Set vertical position

To move the waveform up or down, turn the vertical position knob for each channel.



As the waveform moves, the vertical position of the cursor appears at the bottom left corner of the display.

Run/Stop mode The waveform can be moved vertically in both Run and Stop mode.

Select vertical scale

To change the vertical scale, turn the VOLTS/DIV knob; left (down) or right (up).



Range 2mV/Div ~ 10V/Div, 1-2-5 increments

The vertical scale indicator for each channel on the bottom left of the display changes accordingly.

## Using the probe compensation signal

**Background**

This section introduces how to use the probe compensation signal for general usage, in case the DUT signal is not available or to get a second signal for comparison. For probe compensation details, see page 130.



Note: The frequency accuracy and duty factor are not guaranteed. Therefore the signal should not be used for reference purposes.

**Waveform type**



Square waveform used for probe compensation. 1k ~ 100kHz, 5% ~ 95%.



Demonstration signal for showing the effects of peak detection. See page 78 for peak detection mode details.

**View the probe compensation waveform**

1. Connect the probe between the compensation signal output and Channel input.

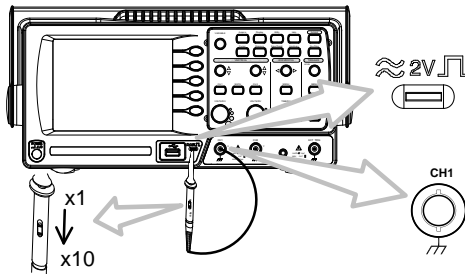

2. Press the Utility key.



3. Press *ProbeComp*.

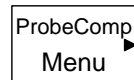

4. Press Wave type repeatedly to select the wave type.

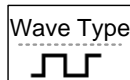

5. (For  $\square$  only) To change the frequency, press *Frequency* and use the Variable knob.

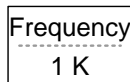

VARIABLE



Range 1kHz ~ 100kHz

6. (For  $\square$  only) To change the duty cycle, press *Duty Cycle* and use the Variable knob.

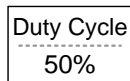

VARIABLE



Range 5% ~ 95%

Probe compensation















For probe compensation details, see page 130.

# Automatic Measurements

The automatic measurement function measures input signal attributes and updates them in the display. Up to 5 automatic measurement items can be updated at any one time on the side menus. All automatic measurement types can be displayed on screen if necessary.

## Measurement items

Overview	Voltage type	Time type	Delay type
	Vpp	Frequency	FRR
	Vmax	Period	FRF
	Vmin	RiseTime	FFR
	Vamp	FallTime	FFF
	Vhi	+Width	LRR
	Vlo	-Width	LRF
	Vavg	Dutycycle	LFR
	Vrms		LFF
	ROVShoot		
	FOVShoot		
	RPREShoot		
	FPREShoot		
Voltage measurement items	Vpp	Difference between positive and negative peak voltage (=Vmax - Vmin)	
	Vmax	Positive peak voltage.	
	Vmin	Negative peak voltage.	
	Vamp	Difference between global high and global low voltage (=Vhi - Vlo)	
	Vhi	Global high voltage.	

	Vlo		Global low voltage.
	Vavg		Averaged voltage of the first cycle.
	Vrms		RMS (root mean square) voltage.
	ROVShoot		Rise overshoot voltage.
	FOVShoot		Fall overshoot voltage.
	RPREShoot		Rise preshoot voltage.
	FPREShoot		Fall preshoot voltage.
Time measurement items	Freq		Frequency of the waveform.
	Period		Waveform cycle time (=1/Freq).
	Risetime		Rising time of the pulse (~90%).
	Falltime		Falling time of the pulse (~10%).
	+Width		Positive pulse width.
	-Width		Negative pulse width.
	Duty Cycle		Ratio of signal pulse compared with whole cycle =100x (Pulse Width/Cycle)
Delay measurement items	FRR		Time between: Source 1 first rising edge and Source 2 first rising edge



FRF		Time between: Source 1 first rising edge and Source 2 first falling edge
FFR		Time between: Source 1 first falling edge and Source 2 first rising edge
FFF		Time between: Source 1 first falling edge and Source 2 first falling edge
LRR		Time between: Source 1 first rising edge and Source 2 last rising edge
LRF		Time between: Source 1 first rising edge and Source 2 last falling edge
LFR		Time between: Source 1 first falling edge and Source 2 last rising edge
LFF		Time between: Source 1 first falling edge and Source 2 last falling edge

## Automatic measurement gating

---

**Background**      Automatic measurements can be restricted to a specific area (gating). When cursors are turned on, the area between the cursors is used for automatic measurements. When cursors are turned off, measurements are derived from all the points that are displayed on screen.

**Turn gating on**      1. Turn on cursors to enable gated automatic measurements.      page 61

2. Press the Measure key.



3. The measurement results appear on the menu bar, constantly updated. All measurements are derived from the cursor positions. See *Automatically measuring the input signals* for more details (page 58).

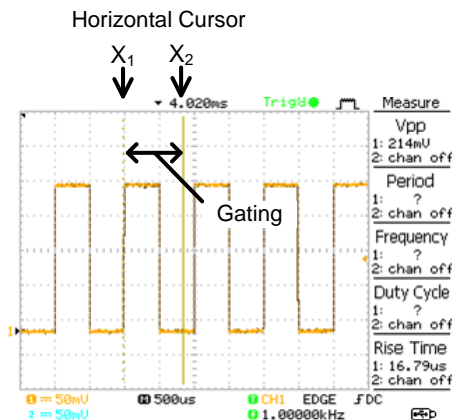

Turn gating off

4. Turn off cursors to turn off gated automatic measurements. page 61

### Automatically measuring the input signals

Viewing the measurement result

1. Press the Measure key.



2. The measurement results appear on the menu bar, constantly updated. 5 measurement slots (F1 to F5) can be customized.

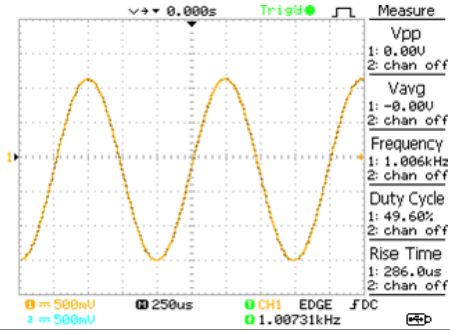

Editing a measurement item

3. Press the corresponding menu key (F1~F5) to select the measurement slot to be edited.

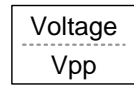

4. The editing menu appears

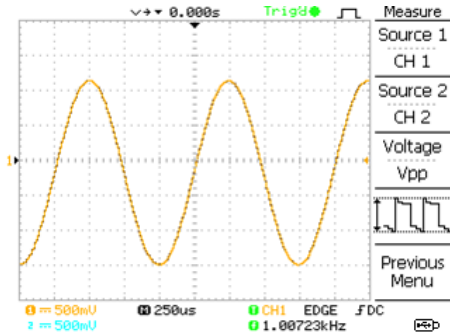

Change measurement item

5. Use the Variable knob to select a different measurement item.



Change measurement source

6. Press Source 1 repeatedly to change Source1 from CH1 to CH2 or MATH.

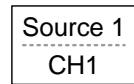

Range CH1, 2, Math

- Press *Source 2* repeatedly to change the channel for Source2.

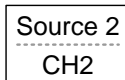

Range CH1, 2, Math

View all measurements

- Press *F3* to view all measurement items.

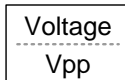

- All the measurements appear in the center of the screen.

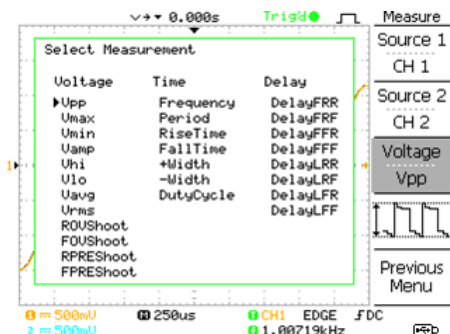

- Press *F3* again to return.



Note: All the editing operations can still be performed when viewing all the measurement items.

- Press *Previous Menu* to confirm the item selection and to go back to the measurement results view.

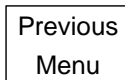

## Cursor Measurements

Cursor lines, horizontal or vertical, show the precise position of the input waveforms or the math operation results. The horizontal cursors can track time, voltage/current\* and frequency, whilst the vertical cursors can track voltage/current\*. All measurements are updated in real-time. \*probe type dependant (page 94).

### Using the horizontal cursors

---

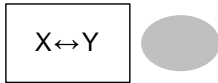
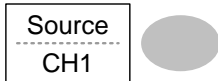
Procedure	<ol style="list-style-type: none"> <li>1. Press the Cursor key. The cursors appear in the display.</li> </ol>	
	<ol style="list-style-type: none"> <li>2. Press X↔Y to select the horizontal (X1&amp;X2) cursor.</li> </ol>	
	<ol style="list-style-type: none"> <li>3. Press <i>Source</i> repeatedly to select the source channel.</li> </ol>	
	<p style="margin-left: 40px;">Range      CH1, 2, MATH</p> <ol style="list-style-type: none"> <li>4. The cursor measurement results will appear in the menu, F2 to F4.</li> </ol>	

Parameters	<table border="0"> <tr> <td style="padding-right: 20px;">X1</td> <td>Time position of the left cursor. (relative to zero)</td> </tr> <tr> <td>X2</td> <td>Time position of the right cursor. (relative to zero)</td> </tr> <tr> <td>X1X2</td> <td>The difference between the X1 and X2.</td> </tr> <tr> <td>Δ: us</td> <td>The time difference between X1 and X2.</td> </tr> <tr> <td>f: Hz</td> <td>The time difference converted to frequency.</td> </tr> <tr> <td>V/A</td> <td>The voltage/current difference from X1 and X2.</td> </tr> </table>	X1	Time position of the left cursor. (relative to zero)	X2	Time position of the right cursor. (relative to zero)	X1X2	The difference between the X1 and X2.	Δ: us	The time difference between X1 and X2.	f: Hz	The time difference converted to frequency.	V/A	The voltage/current difference from X1 and X2.
X1	Time position of the left cursor. (relative to zero)												
X2	Time position of the right cursor. (relative to zero)												
X1X2	The difference between the X1 and X2.												
Δ: us	The time difference between X1 and X2.												
f: Hz	The time difference converted to frequency.												
V/A	The voltage/current difference from X1 and X2.												

M1:dB Position of the left cursor in dB.

M2:dB Position of the right cursor in dB.

Δ: dB The dB difference between M1 and M2.

Div: The frequency per division.

Moving the horizontal cursors

To move the left cursor, press X1 and then use the Variable knob.

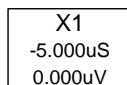

To move the right cursor, press X2 and then use the Variable knob.

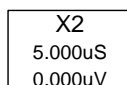

To move both cursors at once, press X1X2 and then use the Variable knob.

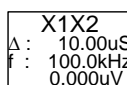

Remove cursors

Press Cursor to remove the onscreen cursors.



## Using the vertical cursors

Procedure

1. Press the Cursor key.



2. Press X↔Y to select the vertical (Y1&Y2) cursor.

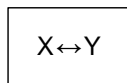

3. Press *Source* repeatedly to select the source channel.

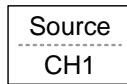







Range CH1, 2, MATH

4. The cursor measurement results will appear in the menu.

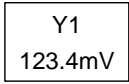
Parameters

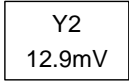
Y1 Voltage level of the upper cursor

Y2 Voltage level of the lower cursor

	Y1Y2	The difference between the upper and lower cursor	
	V/A	The voltage/current difference (Y1-Y2).	
Moving the vertical cursors	To move the upper cursor, press Y1 and then use the Variable knob.		
	To move the lower cursor, press Y2 and then use the Variable knob.		
	To move both cursors at once, press Y1Y2 and then use the Variable knob.		
Remove cursors	Press Cursor to remove the onscreen cursors.		

## Math Operations

The Math operations can add, subtract, multiply or perform FFT/FFT RMS on the input waveforms. The resulted waveform can be measured using the cursors, and saved or recalled just like normal input signals.

### Overview

Addition (+)	Adds the amplitude of CH1 & CH2 signals.
Subtraction (-)	Extracts the amplitude difference between CH1 & CH2.
Multiplication (×)	Multiplies CH1 and CH2.
FFT	Performs a FFT calculation on a signal. Four types of FFT windows are available: Hanning, Flattop, Rectangular, and Blackman.

FFT RMS	Performs a FFT RMS calculation on a signal. RMS is similar to FFT, however the amplitude is calculated as RMS and not dB. Four types of FFT windows are available: Hanning, Flattop, Rectangular, and Blackman.	
Hanning FFT window	Frequency resolution	Good
	Amplitude resolution	Not good
	Suitable for...	Frequency measurement on periodic waveforms
Flattop FFT window	Frequency resolution	Not good
	Amplitude resolution	Good
	Suitable for...	Amplitude measurement on periodic waveforms
Rectangular FFT window	Frequency resolution	Very good
	Amplitude resolution	Bad
	Suitable for...	Single-shot phenomenon (this mode is the same as having no window at all)
Blackman FFT window	Frequency resolution	Bad
	Amplitude resolution	Very good
	Suitable for...	Amplitude measurement on periodic waveforms

### Adding, subtracting or multiplying signals

Procedure

1. Activate both CH1 and CH2.

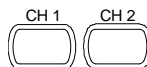

2. Press the Math key.





3. Press *Operation* repeatedly to select addition (+), subtraction (-) or multiplication (×).
 

Operation
CH1+CH2
  
4. The math measurement result appears in the display.
 

Unit/Div
2V
  
5. To move the math result vertically, use the Variable knob. The position will be displayed in *Position*.
 

VARIABLE

Position
0.00 Div
  
6. To clear the math result from the display, press the Math key again.
 

MATH
------

### Using the FFT function

---

- |           |   |      |           |     |        |     |        |         |
|-----------|---|------|-----------|-----|--------|-----|--------|---------|
| Procedure | <ol style="list-style-type: none"> <li>1. Press the Math key.                             <table border="1" style="display: inline-table; vertical-align: middle; margin-left: 10px;"> <tr><td>MATH</td></tr> </table> </li> <br/> <li>2. Press <i>Operation</i> repeatedly to select FFT or FFT RMS.                             <table border="1" style="display: inline-table; vertical-align: middle;"> <tr><td>Operation</td></tr> <tr><td>FFT</td></tr> </table> </li> <br/> <li>3. Press <i>Source</i> repeatedly to select the source channel.                             <table border="1" style="display: inline-table; vertical-align: middle;"> <tr><td>Source</td></tr> <tr><td>CH1</td></tr> </table> </li> <br/> <li>4. Press <i>Window</i> repeatedly to select the FFT window type.                             <table border="1" style="display: inline-table; vertical-align: middle;"> <tr><td>Window</td></tr> <tr><td>Hanning</td></tr> </table> </li> </ol> | MATH | Operation | FFT | Source | CH1 | Window | Hanning |
| MATH      |   |      |           |     |        |     |        |         |
| Operation |   |      |           |     |        |     |        |         |
| FFT       |   |      |           |     |        |     |        |         |
| Source    |   |      |           |     |        |     |        |         |
| CH1       |   |      |           |     |        |     |        |         |
| Window    |   |      |           |     |        |     |        |         |
| Hanning   |   |      |           |     |        |     |        |         |

5. The FFT result appears. The horizontal scale changes from time to frequency, and the vertical scale from voltage to dB or RMS.

6. To move the FFT waveform vertically, press *Vertical* repeatedly until Div is selected. Use the Variable knob to change the vertical scale.

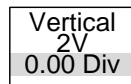

VARIABLE



Range            -12.00 Div ~ +12.00 Div

7. To select the vertical scale of an FFT waveform, press *Vertical* repeatedly until dB is selected. Use the Variable knob to change the vertical scale.

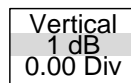

VARIABLE



Range            1, 2, 5, 10, 20 dB/Div

8. To select the vertical scale of an FFT rms waveform, use the VOLTS/DIV knob to change the vertical scale. The scale will be shown in the *Vertical* soft-key.

VOLTS/DIV



Range            Volts/Div

9. To zoom in on the FFT/FFT rms waveform, press *Zoom* repeatedly until X is selected. Use the Variable knob to change the Zoom level.

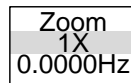

VARIABLE



Range            1/2/5/10/20X

10. To move the FFT/FFT rms waveform horizontally, press *Zoom* repeatedly until Hz is selected. Use the Variable knob to change the horizontal position.

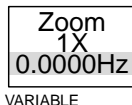

Range      0~50.000MHz

11. To clear the FFT result from the display, press the Math key again.







## Go No-Go Testing

### Overview

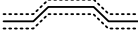

**Background**      Go-NoGo testing checks if a waveform conforms to a user-specified maximum and minimum boundary (template). The testing can be set to stop or continue each time the template has or has not been violated by the input waveform.

Settings	Item	Default	Details
	NoGo criteria: When inside or outside the boundary	Inside	Page 68
	Source	Channel 1	Page 68
	Test continue or stop when NoGo occurs	Stop	Page 69
	Boundary (template) – selects the minimum and maximum boundaries (template) from a single waveform	Auto (0.4%)	Page 69
	Run Tests		Page 73

## Edit: NoGo When



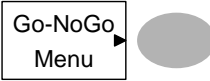
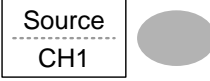

- |           |   |   |
|-----------|---|---|
| Procedure | 1. Press the Utility key.   |  |
|           | 2. Press the <i>More</i> key.   |  |
|           | 3. Press <i>No Go When</i> repeatedly to select the NoGo conditions.              |  |
|           |  | NoGo when the waveform is inside the boundary (template)                          |
|           |  | NoGo when the waveform is outside of the boundary (template)                      |

## Edit: Source

- |           |  |   |
|-----------|--|---|
| Procedure | 1. Press the Utility key.  |    |
|           | 2. Press the <i>More</i> key.  |  |
|           | 3. Press the <i>Go-NoGo Menu</i> key.  |  |
|           | 4. Press <i>Source</i> repeatedly to select the source channel (CH1 or CH2). |  |

## Edit: NoGo Violation Conditions

---

Procedure	1. Press the Utility key.	
	2. Press the <i>More</i> key.	
	3. Press the <i>Go-NoGo Menu</i> key.	
	4. Press <i>Violating</i> repeatedly to select the NoGo conditions.	
	Stop	Stops the test when the NoGo conditions have been met.
	Continue	The tests continue even when the NoGo conditions have been met.

## Edit: Template (boundary)

---

Background	The NoGo template sets the upper and lower amplitude boundary. Two methods are available: Min/Max and Auto.	
	Min/Max	Selects the upper boundary (Max) and lower boundary (Min) as separate waveforms, from the internal memory. The upper boundary is saved to Ref A, the lower boundary is saved to Ref. B.  Advantage: The template shape and distance (allowance) between the source signal are fully customizable.

Disadvantage: The waveforms (templates) have to be stored internally prior to this selection.

Auto Creates the upper and lower boundary (template) from the source signal, not from an internally stored waveform.

Advantage: No need to store the waveforms prior to this selection.

Disadvantage: The template shape is proportional to the source signal. The distance (allowance) between the source signal and the upper and lower template is the same.

Max/Mix

1. The template is based on the source signal. Ensure the source signal appears on the display.

2. Press the Utility key.



3. Press the *More* key.



4. Press the *Go-NoGo Menu* key.

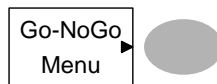

5. Press the *Template Edit* key.



6. Press *Template* repeatedly to select the upper (Max) or lower (Min) boundaries.

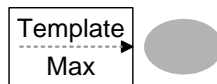

- Press *Source* and use the Variable knob to select the waveform template.

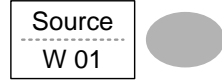

VARIABLE



Max            Waveform A: Ref A, W01~W15

Min            Waveform B: Ref B, W01~W15

- Press *Position* and use the Variable knob to set the waveform amplitude.

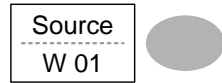

VARIABLE



- Repeat steps 5-7 for the other template setting (Max or Min).

- When both Max and Min templates have been configured, press *Save & Create* to save the templates.

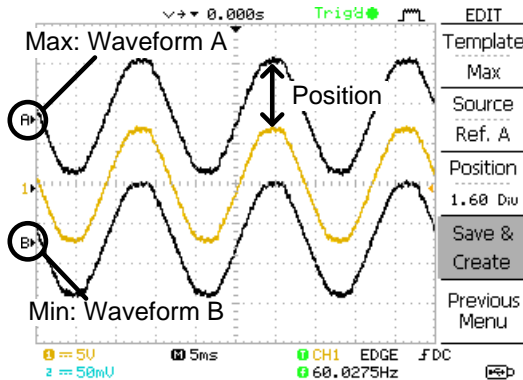

Auto

1. The template is based on the source signal. Ensure the source signal appears on the display.

2. Press the Utility key.



3. Press the *More* key.



4. Press the *Go-NoGo Menu* key.

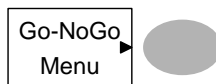

5. Press the *Template Edit* key.



6. Press *Template* repeatedly to select the Auto template.

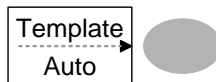

7. Press *Source* and use the Variable knob to select the template source.

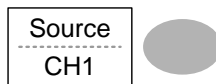

VARIABLE



Source CH1, CH2

8. Press *Tolerance* repeatedly to choose the tolerance units, % or Div. Use the Variable knob to set the tolerance. The tolerance is for both the horizontal and vertical axis.

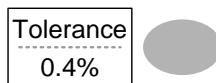

VARIABLE



% 0.4% ~ 40.0%

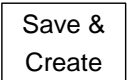

Div 0.04 Div ~ 4.0 Div

- When the Auto template has been configured, press *Save & Create* to save the template. 

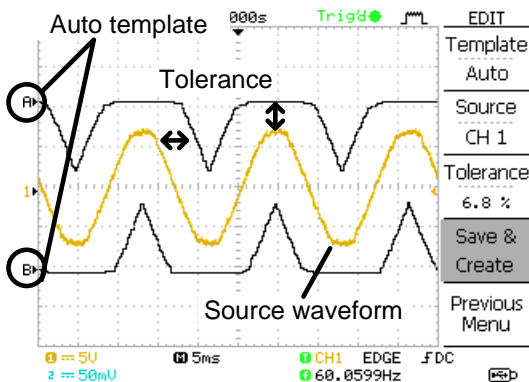

## Run Go-NoGo Tests

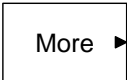
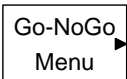
- Procedure
- Press the *Utility* key. 
  - Press the *More* key. 
  - Press the *Go-NoGo Menu* key. 

Ensure the source signal and boundary templates appear on the screen.

4. Press *Go-NoGo*. The test starts and stops according to the conditions set on page 68, 69. To stop the test that has already started, press *Go-NoGo* again.

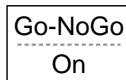

5. The test results appear in the Ratio soft-key. The numerator denotes the total number of failed tests. The denominator denotes the total number of tests.

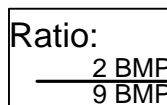

Numerator      Number of “failed” tests.

Denominator    Total number of tests.

## Data Logging

### Overview



#### Background

The Data logging function allows you to log data or a screen image over timed intervals for up to 100 hours to a USB flash drive.

The data or images are stored to a USB flash drive in a directory named LogXXXX. LogXXXX is incremented each time the data logging function is used.



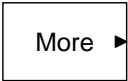

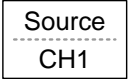
The files saved in the LogXXXX directory are named DSXXXX.CSV, or DSXXXX.BMP for data or image files, respectively. At each timed interval data or an image file is saved and the file number incremented. For example, DS0000 is the first logged data, DS0001 is the second and so on.

### Edit: Source

- |           |  |   |
|-----------|--|---|
| Procedure | 1. Press the Utility key.  |  |
|           | 2. Press the <i>More</i> key.  |  |
|           | 3. Press the <i>Data logging Menu</i> key.                                   |  |
|           | 4. Press <i>Source</i> repeatedly to select the source channel (CH1 or CH2). |  |

### Edit: Setup Parameters

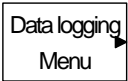
**Background**      The logging function must set the type of data that will be logged (waveform/image), the capture interval time and the duration of the data logging.

- |           |  |   |
|-----------|--|---|
| Procedure | 1. Press the Utility key.                  |   |
|           | 2. Press the <i>More</i> key.              |  |
|           | 3. Press the <i>Data logging Menu</i> key. |  |
|           | 4. Press the <i>Setup</i> key.             |  |

5. Press *Save* repeatedly to log data or screen images.



6. Press *Interval* and use the Variable knob to select the interval time.

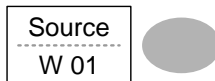

VARIABLE



Interval time	2 secs~ 2min (duration = 5 min)
	2 secs~ 5 min (duration 5~ 30 min)
	2 secs~ 30 min (duration 30+ min)

7. Press *Duration* and use the Variable knob to set the duration time.



VARIABLE



Duration 5 mins ~ 100 hours



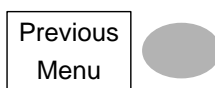

8. Press Previous menu to return to the Data logging menu. Data logging is now ready to begin.

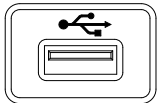

## Run Data logging

---

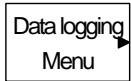
**Background**      Ensure the data source (page 75) and data logging setup has been set (page 75).

- Procedure**
1. Insert a USB flash drive into the USB front panel port. 
  
  2. Press the Utility key. 
  
  3. Press the *More* key. 
  
  4. Press the *Data logging Menu* key. 
  
  5. Press *Data logging* to turn data logging On. Data/image files start logging to the USB flash drive automatically. To stop the Data logging, press the *Data logging* key again. 

# C ONFIGURATION

The Configuration chapter describes how to configure panel settings to make measurements and observations suited to the application needs.

## Acquisition

The acquisition process samples the analog input signals and converts them into digital format for internal processing. You may select the normal, average, or peak detect acquisition mode.

### Selecting the acquisition mode

---

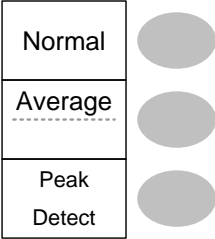
Procedure	1. Press the Acquire key.	
	2. Select the acquisition mode between <i>Normal</i> , <i>Average</i> and <i>Peak Detect</i> .	
Range	Normal	All of the acquired data is used to draw the waveform.

- Average Multiple data is averaged to form a waveform. This mode is useful for drawing a noise-free waveform. To select the number, press *Average* repeatedly.  
Average number: 2, 4, 8, 16, 32, 64, 128, 256
- Peak detect To activate the Peak detect mode, press *Peak-Detect*. Only the minimum and maximum value pairs for each acquisition interval (bucket) are used. This mode is useful for catching abnormal glitches in a signal.

Peak detect effect using the probe comp. waveform

1. One of the probe compensation waveforms can demonstrate the peak detection mode. Connect the probe to the probe compensation output.



2. Press the Utility key.



3. Press *ProbeComp*.

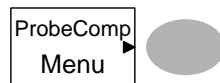

4. Press *Wave Type* and select the  waveform.

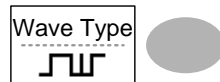

5. Press the Autoset key. The oscilloscope positions the waveform in the center of the display.



6. Press the Acquire key.



7. Press *Normal*.



8. Press *Peak-Detect* and see that a spike noise is captured.

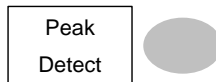

Example

The peak detect mode reveals the occasional glitch.

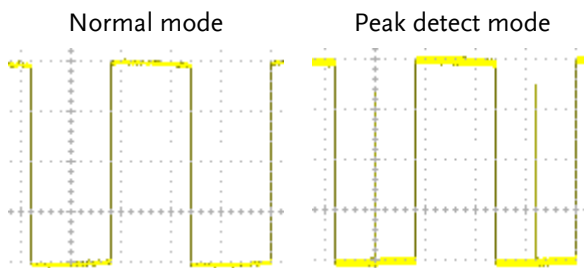

## Selecting Delay mode

**Background** When delay time is ON, the displayed output is delayed for a defined amount of time from the trigger point. Using the delay function is useful for observing an area of the waveform that occurs some time after the trigger point.

**Delay On** With Delay On the expansion point and trigger point become separated by the amount of delay time. As the delay time is increased the trigger point moves left from the expansion point. When the horizontal scale is adjusted, the waveform expands from the expansion point, not the trigger point.



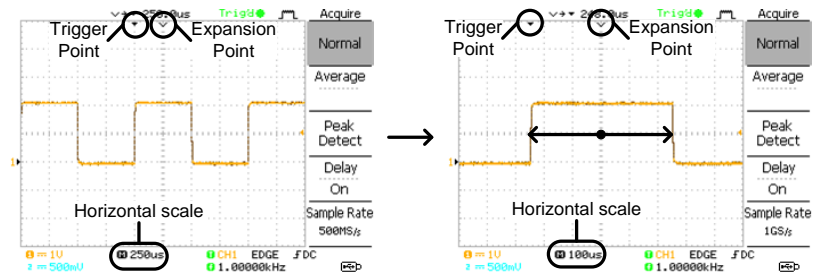

Delay Off

With Delay Off the expansion point and trigger point are always in the same position. Thus when the horizontal scale is adjusted, the waveform expands from the trigger point.

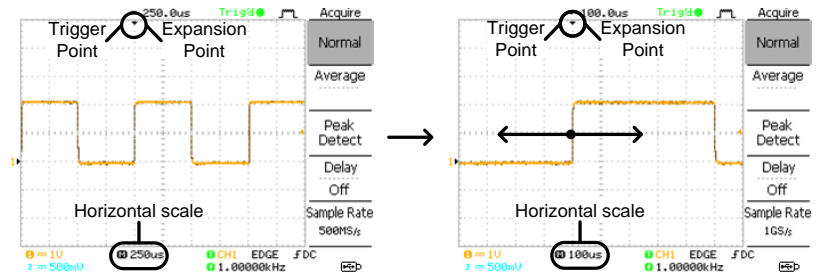

Procedure

1. Press the Acquire key.



2. Press *Delay On/Off* to toggle Delay On/Off.



3. Use the Horizontal Position knob to increase or decrease the delay time when Delay is set to On.



4. Adjust the horizontal scale to zoom into the waveform.



## Real time vs Equivalent time sampling mode

---

Background	The oscilloscope automatically switches between two sampling modes, Real-time and Equivalent-time, according to the number of active channels and sampling rate.
Real-time sampling	Once sampled data is used to reconstruct a single waveform. Short-time events might get lost if the sampling rate gets too high. This mode is used when the sampling rate is relatively low (1GSa/s or lower).
Equivalent-time sampling	Multiple numbers of sampled data are accumulated to reconstruct a single waveform. ETS restores more waveform detail but takes longer to update the waveform. This mode is used when the sampling rate becomes higher than 1GSa/s. The maximum equivalent-time sampling rate is 25GSa/s.

## Display

The Display section describes how to configure the display settings: drawing type, waveform accumulation, contrast adjustment, and grid settings.

### Selecting vector or dot drawing

---

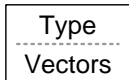
Procedure	1. Press the Display key.	
	2. Press <i>Type</i> repeatedly to select the waveform drawing.	

Types	Dots	Only the sampled dots are displayed.
	Vectors	The sampled dots are connected by lines.

### Accumulating the waveform

---

Background	Accumulation preserves the old waveform drawings and overwrites new waveforms on top of it. It is useful for observing waveform variation.
------------	--

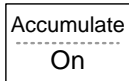
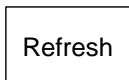
Procedure	1. Press the Display key.	
	2. Press <i>Accumulate</i> to turn on the waveform accumulation.	
	3. To clear the accumulation and start it over (refresh), press <i>Refresh</i> .	

Example

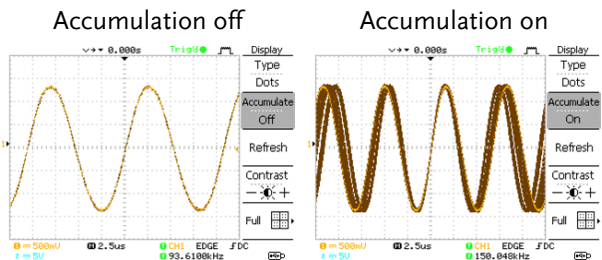

### Adjusting the display contrast

Procedure

1. Press the Display key.



2. Press *Contrast*.

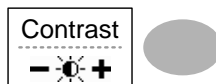

3. Turn the Variable knob left to lower the contrast (dark display) or right to raise the contrast (bright display).



### Selecting the display grid

Procedure

1. Press the Display key.



2. Press the grid icon repeatedly to select the grid.

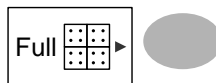

Parameters



Shows the full grid.



Shows the outer frame and X/Y axis.



Shows only the outer frame.

## Horizontal View

The Horizontal view section describes how to configure the horizontal scale, position, waveform update mode, window zoom, and X-Y mode.

### Moving the waveform position horizontally

Procedure

The horizontal position knob moves the waveform left or right. The position indicator at the top of the display shows the center and current position.

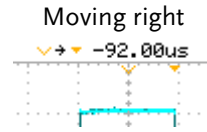
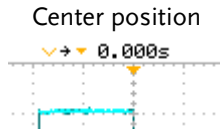
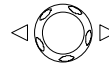

### Selecting the horizontal scale

Select horizontal scale

To select the timebase (scale), turn the TIME/DIV knob; left (slow) or right (fast).

TIME/DIV



Range 1ns/Div ~ 50s/Div, 1-2.5-5-10 increment

The timebase indicator at the bottom of the display updates the current horizontal scale.

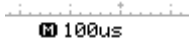
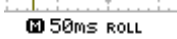

## Selecting the waveform update mode

Background	The display update mode is switched automatically or manually according to the horizontal scale.
Main mode	<p>Updates the whole displayed waveform at once. The main mode is automatically selected when the horizontal scale (timebase) is fast.</p> <p>Horizontal scale <math>\leq 100\text{ms}/\text{div}</math></p> <p>Trigger All modes available</p>
Roll mode	<p>Updates and moves the waveform gradually from the right side of the display to the left. The Roll mode is automatically selected when the horizontal scale (timebase) is 50ms or slower.</p> <p>When in the Roll mode, an indicator appears at the bottom of the display. When in roll mode the record length is 2M (1 channel) or 1M (2 channel).</p> <div style="display: flex; justify-content: space-around; align-items: center;"> <div style="text-align: center;"> <p>Main mode</p>  <p>100µs</p> </div> <div style="text-align: center;"> <p>Roll mode</p>  <p>50ms ROLL</p> </div> </div> <p>Timebase <math>\geq 50\text{ms}/\text{div}</math> (<math>\leq 1.25\text{MS}/\text{s}</math>)</p> <p>Trigger Auto mode only</p>

Selecting the Roll mode manually 1. Press the Horizontal menu key.



2. Press *Roll*. The horizontal scale automatically becomes 50ms/div and the waveform starts scrolling from the right side of the display (If the oscilloscope is already in the Roll mode, there will be no change).

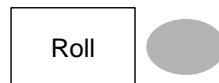

## Zooming the waveform horizontally

Procedure/ range 1. Press the Horizontal Menu key.



2. Press *Window*.



3. Use the horizontal position knob to move the zoom range sideways, and TIME/DIV knob to change the zoom range width.

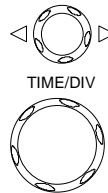

The width of the bar in the middle of the display is the actual zoomed area.

Zoom range 1ns ~ 25s

4. Press *Window Zoom*. The specified range gets zoomed.



### Example

Setting the zoom width

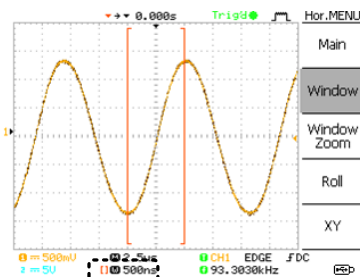

Zoom width

Zooming in

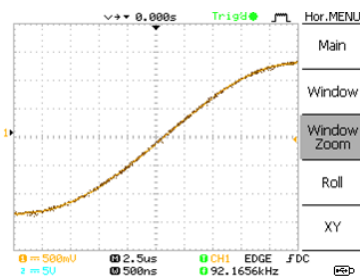

## Viewing waveforms in the X-Y mode

**Background** The X-Y mode compares the voltage of Channel 1 and Channel 2 waveforms in a single display. This mode is useful for observing the phase relationship between the two waveforms.

**Procedure**

1. Connect the signals to Channel 1 (X-axis) and Channel 2 (Y-axis).
2. Make sure both Channel 1 and 2 are activated.
3. Press the Horizontal key.
4. Press XY. The display shows two waveforms in X-Y format; Channel 1 as X-axis, Channel 2 as Y-axis.

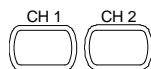
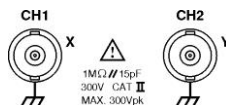

**Adjusting the X-Y mode waveform**

- |                     |                    |
|---------------------|--------------------|
| Horizontal position | CH1 Position knob  |
| Horizontal scale    | CH1 Volts/Div knob |
| Vertical position   | CH2 Position knob  |
| Vertical scale      | CH2 Volts/Div knob |

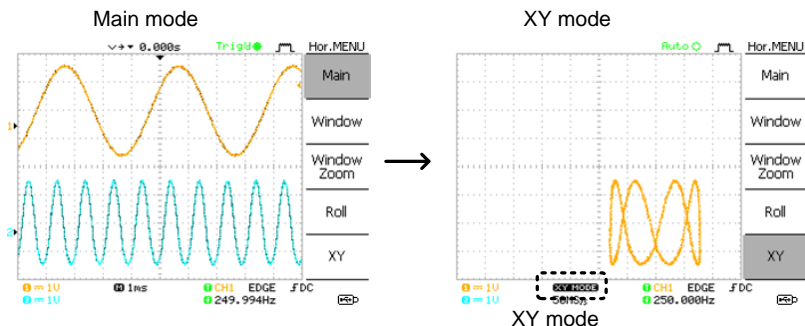

**Example**



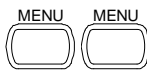
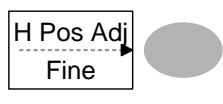

## Horizontal Adjustment Menu

**Background** The horizontal adjustment menu allows markers to be set at different times relative to the Horizontal position marker at 0 seconds. Each marker is linked to the mark directly before and after (in time). There can be up to 30 markers linked together.

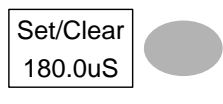
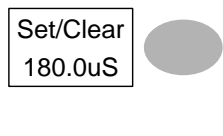
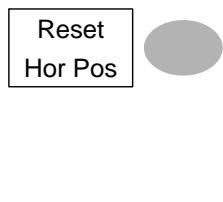
- |   |   |   |
|---|---|---|
|   | <p>1. Press the Horizontal menu key twice to enter the horizontal adjustment menu</p>   |    |
|   | <p>2. Press <i>H Pos Adj</i> to toggle between coarse and fine adjustments.</p>   |    |
|   | <p>3. Adjust the horizontal position with the horizontal position knob.</p>   |    |
| <p><b>Set marker</b></p>                | <p>4. Press <i>Set/Clear</i> to create a marker at the current horizontal position.</p>   |    |
| <p><b>Delete marker</b></p>             | <p>5. If there is already a marker at the current horizontal position press <i>Set/Clear</i> to delete the current marker.</p>                                  |  |
| <p><b>Reset horizontal position</b></p> | <p>6. Press <i>Reset</i> to reset the horizontal position to 0 seconds when the trigger is running, or to the last position before the trigger was stopped.</p> |  |

Navigate markers 7. Press *Previous* to go to the previous marker.

Previous  
180.0uS



8. Press *Next* to go to the next marker.

Next  
340.0uS

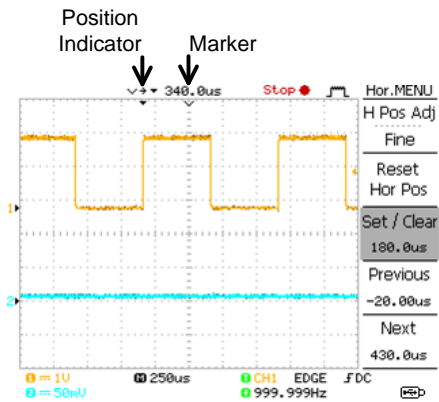

## Vertical View (Channel)

The Vertical view section describes how to set the vertical scale, position, bandwidth limitation, coupling mode, and attenuation.

### Moving the waveform position vertically

Procedure To move the waveform up or down, turn the vertical position knob for each channel. 



### Selecting the vertical scale

Procedure To change the vertical scale, turn the VOLTS/DIV knob; left (down) or right (up). 

Range 2mV/Div ~ 10V/Div, 1-2-5 increments

### Selecting the coupling mode

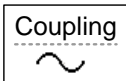
Procedure

1. Press the Channel key. 
2. Press *Coupling* repeatedly to select the coupling mode.  

Range

 DC coupling mode. The whole portion (AC and DC) of the signal appears on the display.

 Ground coupling mode. The display shows only the zero voltage level as a horizontal line. This mode is useful for measuring the signal amplitude with respect to the ground level.



AC coupling mode. Only the AC portion of the signal appears on the display. This mode is useful for observing AC waveforms mixed with DC components.

## Expand Vertical Scale Center / Ground

### Background

Normally when the vertical scale is increased, the scaled image is centered from ground. However a signal with a voltage bias could be obscured when the vertical scale is increased. The Expand Center function expands the image from the center of the signal, rather than ground.

### Expand Ground

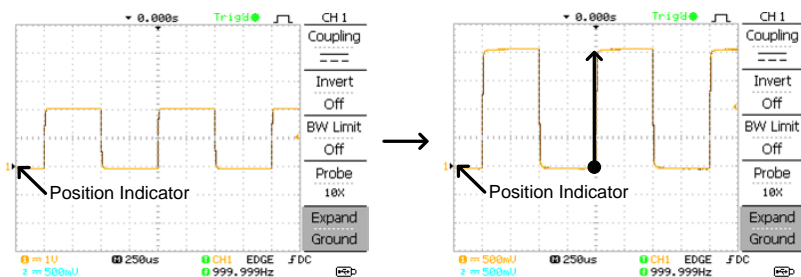

### Expand Center

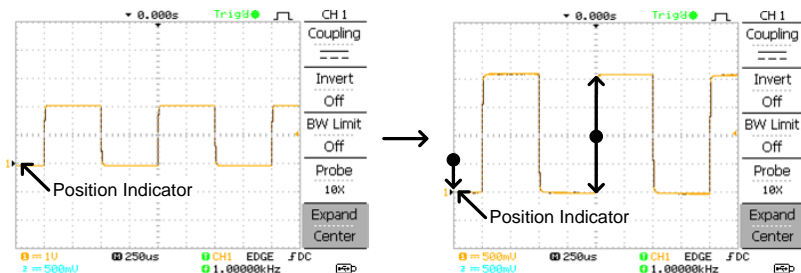

Procedure

1. Press the Channel key.



2. Press F5 to toggle between Expand Center and Expand Ground.



3. To change the vertical scale, turn the VOLTS/DIV knob; left (down) or right (up).



The vertical scale indicator on the bottom left of the display changes accordingly.



## Inverting the waveform vertically

Procedure

1. Press the Channel key.



2. Press *Invert*. The waveform becomes inverted (upside down) and the Channel indicator in the display shows a down arrow.

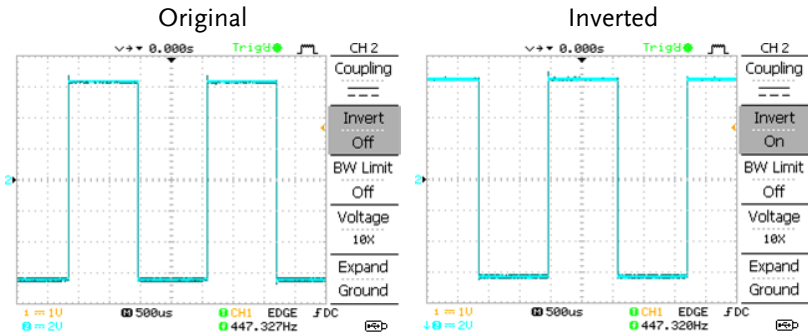
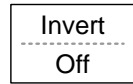

## Limiting the waveform bandwidth

**Background**      Bandwidth limitation puts the input signal into a 20MHz (-3dB) low-pass filter. This function is useful for cutting off high frequency noise to see the clear waveform shape.

**Procedure**

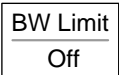
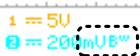
1. Press the Channel key. 
2. Press *BW Limit* to turn on or off the limitation. When turned on, the BW indicator appears next to the Channel indicator in the display.  

**Example**

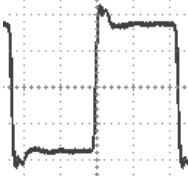
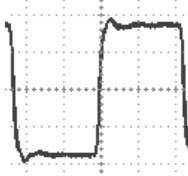
	<b>BW Limit Off</b>	<b>BW Limit On</b>
		

## Probe attenuation level and type

**Background**      The probe can be set to either voltage or current. A signal probe has an attenuation switch to lower the original DUT signal level to the oscilloscope input range, if necessary. The probe attenuation selection adjusts the vertical scale so that the voltage or current level on the display reflects the real value, not the attenuated level.

**Procedure**

1. Press the Channel key. 

2. Press *F4* repeatedly to select voltage or current probes.

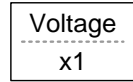

3. Use the variable knob to edit the voltage or current attenuation.



4. The voltage/current scale in the channel indicator changes accordingly. There is no change in the waveform shape.

Range	0.1X~2000X (1-2-5 steps)
-------	--------------------------



Note: The attenuation factor adds no influence on the real signal; it only changes the voltage/current scale on the display.

## Trigger

The Trigger function configures the conditions by which the oscilloscope captures the incoming signals.

### Trigger type

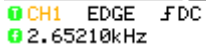
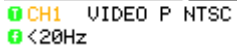
Edge	Triggers when the signal crosses an amplitude threshold in either a positive or negative slope.	
Video	Extracts a sync pulse from a video format signal and triggers on a specific line or field.	
Pulse	Triggers when the pulse width of the signal matches the trigger settings.	
Indicators	Edge/Pulse	Video
	 (CH1, Edge, Rising edge, DC coupling)	 (CH1, Video, Positive polarity, NTSC standard)

### Trigger parameter

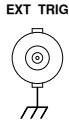
Trigger source	CH1, 2	Channel 1, 2 input signals	
	Line	AC mains signal	
	Ext	External trigger input signal	
Trigger mode	Auto	The oscilloscope updates the input signal regardless of the trigger conditions (if there is no trigger event, the oscilloscope generates an internal trigger). Select this mode especially when viewing rolling waveforms at a slow timebase.	



The Auto trigger status appears in the upper right corner of the display.

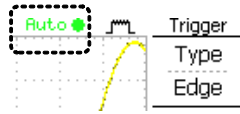

**Single** The oscilloscope acquires the input signals once when a trigger event occurs, then stops acquiring. Pressing the Single key again will repeat the process.



The Single trigger status appears in the upper right corner of the display.





**Normal** The oscilloscope acquires and updates the input signals only when a trigger event occurs.

The Normal trigger status appears in the upper right corner of the display.





**Holdoff** The holdoff function defines the waiting period before the GDS-1000A-U starts triggering again after a trigger point. The Holdoff function ensures a stable display.

<b>Video standard</b> (video trigger)	NTSC	National Television System Committee
	PAL	Phase Alternative by Line
	SECAM	SEquential Couleur A Mémoire

<b>Sync polarity</b> (video trigger)		Positive polarity
		Negative polarity

**Video line** (video trigger) Selects the trigger point in the video signal.

field	1 or 2
-------	--------

	line	1~263 for NTSC, 1~313 for PAL/SECAM
Pulse condition (pulse trigger)		Sets the pulse width (20ns ~ 10s) and the triggering condition.
	>	Longer than = Equal to
	<	Shorter than ≠ Not equal to
Trigger slope		Triggers on the rising edge.
		Triggers on the falling edge.
Trigger coupling	AC	Triggers only on AC component.
	DC	Triggers on AC+DC component.
Frequency rejection	LF	Puts a high-pass filter and rejects the frequency below 50kHz.
	HF	Puts a low-pass filter and rejects the frequency above 50kHz.
Noise rejection		Rejects noise signals.
Trigger level		Using the trigger level knob moves the trigger point up or down.

## Configuring Holdoff

**Background** The Holdoff function defines the waiting period before GDS-1000A-U starts triggering again after the trigger point. The holdoff function is especially useful for waveforms with two or more repetitive frequencies or periods that can be triggered.

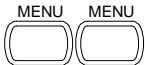
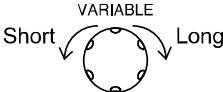
- Panel operation**
1. Press the Trigger menu key twice. 
  2. To set the Holdoff time, use the Variable knob. The resolution depends on the horizontal scale.   
Range 40ns~2.5s

Pressing *Set to Minimum* sets the Holdoff time to the minimum, 40ns.

Holdoff  
40.0ns



Note: The holdoff function is automatically disabled when the waveform update mode is in Roll mode.

## Configuring the edge trigger

---

### Procedure

1. Press the Trigger menu key.



2. Press *Type* repeatedly to select edge trigger.

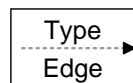

3. Press *Source* repeatedly to select the trigger source.

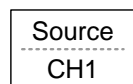

Range Channel 1, 2, Line, Ext

4. Press *Mode* repeatedly to select the Auto or Normal trigger mode. To select the single trigger mode, press the Single key.

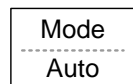

Range Auto, Normal

5. Press *Slope/coupling* to enter into the trigger slope and coupling selection menu.

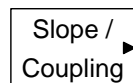

6. Press *Slope* repeatedly to select the trigger slope, rising or falling edge.

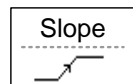

Range Rising edge, falling edge

- 7. Press *Coupling* repeatedly to select the trigger coupling, DC or AC.
 

Coupling
AC

  
 Range      DC, AC
  
- 8. Press *Rejection* to select the frequency rejection mode.
 

Rejection
Off

  
 Range      LF, HF, Off
  
- 9. Press *Noise Rej* to turn the noise rejection on or off.
 

Noise Rej
Off

  
 Range      On, Off
  
- 10. Press *Previous* menu to go back to the previous menu.
 

Previous
Menu

### Configuring the video trigger

---



- Procedure
- 1. Press the Trigger menu key.
  
  - 2. Press *Type* repeatedly to select video trigger. The video trigger indicator appears at the bottom of the display.
 

Type
Video
  
  - 3. Press *Source* repeatedly to select the trigger source channel.
 



Source
CH1

  
 Range      Channel 1, 2

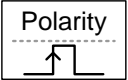

4. Press *Standard* repeatedly to select the video standard.
 

Range     NTSC, PAL, SECAM
  
5. Press *Polarity* repeatedly to select the video signal polarity.
 

Range     positive, negative
  
6. Press *Line* repeatedly to select the video field line. Use the Variable knob to select the field.
 

VARIABLE

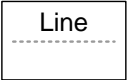





Field     NTSC: 1 ~ 262 (Field 2), 1 ~ 263 (Field 1) PAL/SECAM: 1 ~ 312 (Field 2), 1 ~ 313 (Field1)

### Configuring the pulse width trigger

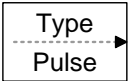
- Procedure
1. Press the Trigger menu key.
 

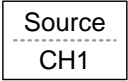

  
  2. Press *Type* repeatedly to select pulse width trigger. The pulse width trigger indicator appears at the bottom of the display.
 



  
  3. Press *Source* repeatedly to select the trigger source.
 

Range     Channel 1, 2, Ext

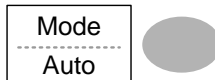
4. Press *Mode* repeatedly to select the trigger mode, Auto or Normal. To select the Single trigger mode, press the Single key.



Range      Auto, Normal

5. Press *When* repeatedly to select the pulse condition. Then use the Variable knob to set the pulse width.

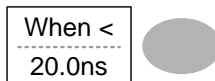

Condition   > , < , = , ≠

Width      20ns ~ 10s

6. Press *Slope/Coupling* to set trigger slope and coupling.

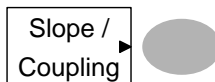

7. Press *Slope* repeatedly to select the trigger slope, which also appears at the bottom of the display.

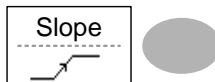

Range      Rising edge, falling edge

8. Press *Coupling* repeatedly to select the trigger coupling.



Range      DC, AC

9. Press *Rejection* to select the frequency rejection mode.



Range      LF, HF, Off

10. Press *Noise Rej* to turn the noise rejection on or off.

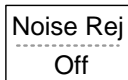

Range On, Off

11. Press *Previous* menu to go back to the previous menu.

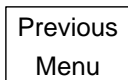

## Manually triggering the signal



Note: This section describes how to manually trigger the input signals when the oscilloscope does not capture them. This section applies to the Normal and Single trigger mode, since in the Auto trigger mode, the oscilloscope keeps updating the input signal regardless of the trigger conditions.

To acquire the signal regardless of trigger conditions

To acquire the input signal regardless of the trigger condition, press the Force key. The oscilloscope captures the signals once.



In the Single trigger mode

Press the Single key to start waiting for the trigger condition. To break out of the Single mode, press the Run/Stop key. The trigger mode changes to the Normal mode.



## Remote Control Interface

The Remote control interface section describes how to set up the USB interface for PC connection. Remote control command details are described in the GDS-1000A-U Programming Manual.

---

USB connection	PC end	Type A, host
	GDS-1000A-U end	Type B, slave
	Speed	1.1/2.0 (full speed)

---

### Procedure

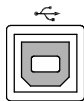
1. Connect the USB cable to the USB slave port.
 
2. When the PC asks for the USB driver, select dso\_vpo.inf V1.06 or above for Windows XP/Vista/7(32/64 bit) which are downloadable from the GW website, [www.gwinstek.com](http://www.gwinstek.com), GDS-1000A-U product corner.
3. On the PC, activate a terminal application such as Hyper Terminal. To check the COM port No., see the Device Manager in the PC. For WindowsXP, select Control panel → System → Hardware tab.
4. Run this query command via the terminal application.  
 \*idn?  
 This command should return the manufacturer, model number, serial number, and firmware version in the following format.  
 GW, GDS-1152A-U, XXXXXXXX, V1.00
5. Configuring the command interface is complete. Refer to the programming manual for the remote commands and other details.



## System Settings

The system settings show the oscilloscope's system information and allow changing the language.

### Viewing the system information

---

Procedure

1. Press the Utility key.



2. Press *System Info*. The upper half of the display shows the following information.

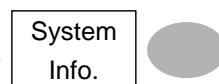

- Manufacturer
- Model
- Serial number
- Firmware version
- Web address

3. Press any other key to go back to the waveform display mode.

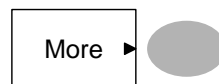

### Selecting the language

---

Parameter

Language selection differs according to the region to which the oscilloscope is shipped.

- English
- Chinese (traditional)
- Chinese (simplified)
- Japanese
- Korean
- French
- German
- Russian
- Portuguese
- Italian
- Polish
- Spanish

Procedure

1. Press the Utility key.



2. Press *Language* repeatedly to select the language.

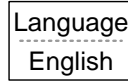

# SAVE/RECALL

The save function allows saving display images, waveform data, and panel settings into the oscilloscope's internal memory or to the front panel USB port. The recall function allows recalling the default factory settings, waveform data, and panel settings from the oscilloscope's internal memory or from USB.

## File Structures

Three types of file are available: display image, waveform file, and panel settings.

### Display image file format

---

Format	xxxx.bmp (Windows bitmap format)
Contents	The current display image in 234 x 320 pixels, color mode. The background color can be inverted (Ink saver function).

### Waveform file format

---

Format	xxxx.csv (Comma-separated values format which can be opened in spreadsheet applications such as Microsoft Excel)
	Files can be saved as two different types of CSV formats. The GDS-1000A-U can recall any of the two formats

	Detail	Contains the waveform amplitude and time of each point (4k/1M/2M) relative to the trigger point.
	Fast	Only contains the waveform amplitude data for each point (4k/1M/2M).
Waveform type	CH1, 2	Input channel signal
	Math	Math operation result (page 63)
Storage location	Internal memory	The oscilloscope's internal memory, which can hold 15 waveforms.
	External USB Flash drive	A USB flash drive (FAT or FAT32 format) can hold practically an unlimited number of waveforms.
	Ref A, B	Two reference waveforms are used as a buffer to recall a waveform in the display. You have to save a waveform into internal memory or to USB, then copy the waveform into the reference waveform slot (A or B), and then recall the reference waveform into the display.
Waveform Memory Depth	<p>The memory depth is limited to 1 M points when both channels are activated or 2M points when only a single channel is activated. The signal must be triggered /stopped to have access to the full memory depth. Therefore when a signal is saved the waveform will be automatically stopped if it is not manually triggered /stopped first.</p> <p>There are a number of conditions when all of the available memory is not utilized due to a limited number of different sample rates. This can be caused by an un-triggered signal, or a time/div setting that is too fast to display all the points on screen.</p>	



Note: 2M point memory lengths are only available for time bases slower than 10ns/div on a single channel, and 1 M point memory lengths are only available for time bases slower than 25ns/div on two channels.

---

Waveform file contents: other data

A waveform file also includes the following information.







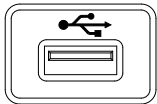

- Memory Length
- Source
- Vertical Units
- Vertical Position
- Horizontal Scale
- Horizontal Mode
- Firmware
- Mode
- Trigger Level
- Probe
- Vertical Scale
- Horizontal Units
- Horizontal Position
- Sampling Period
- Time
- Waveform Data

## Setup file format

Format	xxxx.set (proprietary format)	
	A setup file saves or recalls the following settings.	
Contents	Acquire	<ul style="list-style-type: none"> <li>• mode</li> </ul>
	Cursor	<ul style="list-style-type: none"> <li>• source channel</li> <li>• cursor on/off</li> <li>• cursor location</li> </ul>
	Display	<ul style="list-style-type: none"> <li>• dots/vectors</li> <li>• grid type</li> <li>• accumulation on/off</li> </ul>
	Measure	<ul style="list-style-type: none"> <li>• item</li> </ul>
	Utility	<ul style="list-style-type: none"> <li>• hardcopy type</li> <li>• language</li> <li>• Data Logging settings</li> <li>• ink saver on/off</li> <li>• Go-Nogo settings</li> </ul>
	Horizontal	<ul style="list-style-type: none"> <li>• display mode</li> <li>• position</li> <li>• scale</li> </ul>
	Trigger	<ul style="list-style-type: none"> <li>• trigger type</li> <li>• trigger mode</li> <li>• video polarity</li> <li>• pulse timing</li> <li>• source channel</li> <li>• video standard</li> <li>• video line</li> <li>• slope/coupling</li> </ul>
	Channel (vertical)	<ul style="list-style-type: none"> <li>• vertical scale</li> <li>• coupling mode</li> <li>• bandwidth limit on/off</li> <li>• vertical position</li> <li>• invert on/off</li> <li>• voltage/current (probe)</li> </ul>
	Math	<ul style="list-style-type: none"> <li>• operation type</li> <li>• vertical position</li> <li>• FFT window</li> <li>• source channel</li> <li>• unit/div</li> </ul>

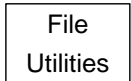
## Using the USB file utilities

**Background** When a USB flash drive is inserted into the oscilloscope, file utilities (file deletion, folder creation and file/folder renaming) are available from the front panel.

- Procedure**
1. Insert a USB flash drive into the front panel USB port. 
  2. Press the Save/Recall key. Select any save or recall function. For example USB Destination in the Save Image function.   
 Save/Recall  
 (Example)    

  3. Press *File Utilities*. The display shows the USB flash drive contents.  
  4. Use the Variable knob to move the cursor. Press *Select* to go into the folder or go back to the previous directory level.   
 VARIABLE   
 

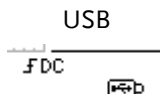
**USB flash drive indicator** When a USB flash drive is inserted into the oscilloscope, an indicator appears at the right bottom corner of the display. (The USB flash drive shouldn't be removed when a file is saved or retrieved from USB).

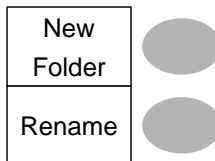

Creating a new folder / renaming a file or folder

1. Move the cursor to the file or folder location and press *New Folder* or *Rename*. The file/folder name and the character map will appear on the display.



2. Use the Variable knob to move the pointer to the characters. Press *Enter Character* or *Back Space* to delete a character.

VARIABLE

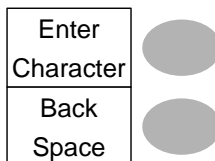

3. When editing is complete, press *Save*. The new/renamed file or folder will be saved.



Deleting a folder or file

1. Move the cursor to the folder or file location and press *Delete*. The message "*Press F4 again to confirm this process*" appears at the bottom of the display.
2. If the file/folder still needs to be deleted, press *Delete* again to complete the deletion. To cancel the deletion, press any other key.





## Quick Save (HardCopy)

**Background**      The Hardcopy key works as a shortcut for saving display images, waveform data, and panel settings onto a USB flash drive card.

The Hardcopy key can be configured into two types of operations: save image and save all (image, waveform, setup).



Using the Save/Recall key can also save files with more options. For details, see page 115.



**Functionalities**

Save image (*.bmp)	Saves the current display image into a USB flash drive.
Save all	Saves the following items into a USB flash drive. <ul style="list-style-type: none"> <li>• Current display image (*.bmp)</li> <li>• Current system settings (*.set)</li> <li>• Current waveform data (*.csv)</li> </ul>

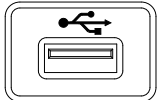
**Procedure**

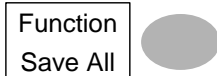
1. Insert a USB flash drive into the front panel USB port.
 
2. Press the Utility key.
 
3. Press *Hardcopy Menu*.
 
4. Press *Function* repeatedly to select *Save Image* or *Save All*.
 

5. To invert the color in the display image, press *Ink Saver*. This turns Ink Saver on or off.



6. If *Save Image* was selected, press *Mem Leng* repeatedly to select *USB Normal* or *USB 1M/2M*. *USB Normal* and *USB 1M/2M* sets the waveforms to a 4k and 1M/2M memory length when saving, respectively.



1M memory length is available when both CH1 and CH2 are active; 2M memory length is available when a single channel is active only.

7. Press the Hardcopy key. The file or folder will be saved to the root directory of the USB flash drive.



## Save

This section describes how to save data using the Save/Recall menu.

### File type/source/destination

Item	Source	Destination
Panel setup (xxx.set)	<ul style="list-style-type: none"> <li>Panel settings</li> </ul>	<ul style="list-style-type: none"> <li>Internal memory: S1 ~ S15</li> <li>External memory: USB</li> </ul>
Waveform data (xxx.csv)	<ul style="list-style-type: none"> <li>Channel 1, 2</li> <li>Math operation result</li> <li>Reference waveform A, B</li> </ul>	<ul style="list-style-type: none"> <li>Internal memory: W1 ~ W15</li> <li>Reference waveform A, B</li> <li>External memory: USB</li> </ul>
Display image (xxx.bmp)	<ul style="list-style-type: none"> <li>Display image</li> </ul>	<ul style="list-style-type: none"> <li>External memory: USB</li> </ul>
Save All	<ul style="list-style-type: none"> <li>Display image (xxx.bmp)</li> <li>Waveform data (xxx.csv)</li> <li>Panel settings (xxx.set)</li> </ul>	<ul style="list-style-type: none"> <li>External memory: USB</li> </ul>

## Saving the panel settings

Procedure

1. (For saving to USB flash drive) Insert the USB flash drive into the front panel USB port.

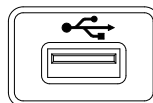

2. Press the Save/Recall key twice to access the Save menu.



3. Press *Save Setup*.

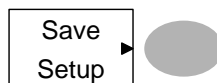

4. Press *Destination* repeatedly to select the saved location. Use the Variable knob to change the internal memory location (S1 ~ S15).

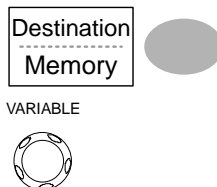

Memory      Internal memory, S1 ~ S15

USB          USB, no practical limitation for the amount of files. When saved, the setup file will be placed in the root directory.

5. Press *Save* to confirm saving. When completed, a message appears at the bottom of the display.



Note

The file will not be saved if the power is turned off or the USB flash drive is removed before completion.

File utilities

To edit the USB drive contents (create/ delete/ rename files and folders), press *File Utilities*. For details, see page 111.

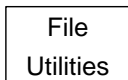

## Saving the waveform

---

Procedure

1. (For saving to USB flash drive) Insert the USB flash drive into the front panel USB port.

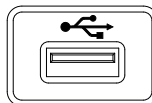

2. Press the Save/Recall key twice to access the Save menu.

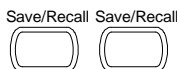

3. Press *Save Waveform*.

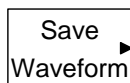

4. Press *Source*. Use the Variable knob to select the source signal.

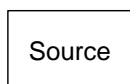

VARIABLE



CH1 ~ CH2    Channel 1 ~ 2 signal

Math            Math operation result (page 63)

RefA, B        Internally stored reference waveforms A, B

5. Press *Destination* repeatedly to select the file destination. Use the Variable knob to select the memory location.

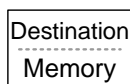

VARIABLE



Memory	Internal memory, W1 ~ W15
USB Normal	Save to the USB flash drive with a 4k waveform memory length.
USB 1M	Save to the USB flash drive with a 1M waveform memory length. For 2 channel operation only.
USB 2M	Save to the USB flash drive with a 2M waveform memory length. For single channel operation only.
Ref	Internal reference waveform, A/B

6. Press *Save* to confirm saving. When completed, a message appears at the bottom of the display.



Note 







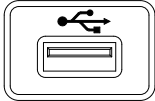

The file will not be saved if the power is turned off or the USB flash drive is removed from the USB port.

It takes approximately 1 min to save a 2M waveform to the USB drive in fast mode. Detailed mode may take over 10 times longer depending on the speed of the USB flash drive.

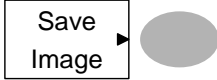
**File utilities** To edit the USB drive contents (create/ delete/ rename files and folders), press *File Utilities*. For details, see page 111.



## Saving the display image

Background	Saving the display image can be used as a screen capture or it can be used as a reference waveform.	
Procedure	1. Insert the USB flash drive into the front panel USB port. (Image files can only be saved to USB)	
	2. Press the Save/Recall key twice to access the Save menu.	
	3. Press <i>Save Image</i> .	
	4. Press <i>Ink Saver</i> repeatedly to invert the background color (on) or not (off).	
	5. Note: <i>Destination</i> is set as USB. This cannot be changed.	
	6. Press <i>Save</i> to confirm saving. When completed, a message appears at the bottom of the display.	
Note	 The file will not be saved if the power is turned off or the USB flash drive is removed before completion.	
File utilities	To edit the USB drive contents (create/ delete/ rename files and folders), press <i>File Utilities</i> . For details, see page 111.	

## Saving all (panel settings, display image, waveform)

Procedure

1. (For saving to USB flash drive) Insert the USB flash drive into the front panel USB port.

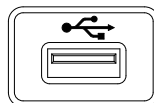

2. Press the Save/Recall key twice to access the Save menu.



3. Press *Save All*. The following information will be saved.

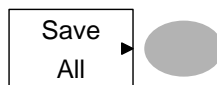

Setup file  
(Axxx.set)

Two types of setups are saved: the current panel setting and the last internally saved settings (one of S1 ~ S15).

Display image  
(Axxx.bmp)

The current display image in bitmap format.

Waveform data  
(Axxx.csv)

Two types of waveform data are saved: the currently active channel data and the last internally saved data (one of W1 ~ W15).

4. Press *Ink Saver* repeatedly to invert the background color (on) or not (off) for the display image.



5. Press *Destination*.



USB  
Normal

Save to the USB flash drive with a 4k waveform memory length.



USB 1M Save to the USB flash drive with a 1M waveform memory length. For 2 channel operation only.

USB 2M Save to the USB flash drive with a 2M waveform memory length. For single channel operation only.

6. Press *Save* to confirm saving. When completed, a message appears at the bottom of the display.



Note 

The file will not be saved if the power is turned off or the USB flash drive is removed from the USB port.

It takes approximately 1 min to save a 2M waveform to the USB drive in fast mode. Detailed mode may take over 10 times longer depending on the speed of the USB flash drive.

7. The current waveform(s) (\*.CSV), setup file (\*.SET) and display image (\*.BMP) are saved to a directory (ALLXXXX).

File utilities

To edit the USB drive contents (create/ delete/ rename files and folders), press *File Utilities*. For details, see page 111.







## Recall





### File type/source/destination

Item	Source	Destination
Default panel setup	<ul style="list-style-type: none"> <li>Factory installed setting</li> </ul>	<ul style="list-style-type: none"> <li>Current front panel</li> </ul>
Reference waveform	<ul style="list-style-type: none"> <li>Internal memory: A, B</li> </ul>	<ul style="list-style-type: none"> <li>Current front panel</li> </ul>
Panel setup (DSxxxx.set)	<ul style="list-style-type: none"> <li>Internal memory: S1 ~ S15</li> <li>External memory: USB flash drive</li> </ul>	<ul style="list-style-type: none"> <li>Current front panel</li> </ul>
Waveform data (DSxxxx.csv)	<ul style="list-style-type: none"> <li>Internal memory: W1 ~ W15</li> <li>External memory: USB flash drive</li> </ul>	<ul style="list-style-type: none"> <li>Reference waveform A, B</li> </ul>

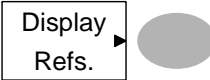
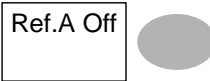

## Recalling the default panel settings

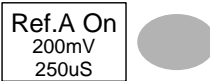
Procedure	<ol style="list-style-type: none"> <li>1. Press the Save/Recall key. </li> <li>2. Press <i>Default Setup</i>. The factory installed setting will be recalled. </li> </ol>
Setting contents	The following is the default panel setting contents.
Acquisition	Mode: Normal
Channel	Coupling: DC                      Invert: Off BW limit: Off                      voltage: x1
Cursor	Source: CH1                      Horizontal: None Vertical: None
Display	Type: Vectors                      Accumulate: Off Graticule: 
Horizontal	Scale: 2.5us/Div                      Mode: Main Timebase H Pos Adj: Fine                      Hor Pos: 0
Math	Type: + (Add)                      Channel: CH1+CH2 Position: 0.00 Div                      Unit/Div: 2V
Measure	Item: Vpp, Vavg, Frequency, Duty cycle, Rise Time
Trigger	Type: Edge                      Source: Channel1 Mode: Auto                      Slope:  Coupling: DC                      Rejection: Off Noise Rejection: Off
Utility	SaveImage, InkSaver On, Probe squarewave 1kHz 50% duty.

## Recalling a reference waveform to the display

- Procedure
- The reference waveform must be stored in advance. See page 117 for details.
  - Press the Save/Recall key. 
  - Press *Display Refs.* The reference waveform display menu appears. 
  - Select the reference waveform, *Ref A* or *Ref B*, and press it. The waveform appears on the display and the period and amplitude of the waveform appears in the menu.    
    
 
  - To clear the waveform from the display, press *RefA/B* again. 

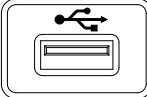
## Recalling panel settings

- Procedure
- (For recalling to USB) Insert the USB flash drive into the front panel USB port. 
  - Press the Save/Recall key. 

3. Press *Recall Setup*.

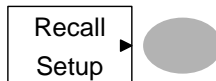

4. Press *Source* repeatedly to select the file source, internal or external memory. Use the Variable knob to change the memory.

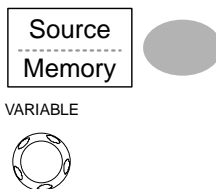

Memory Internal memory, S1 ~ S15

USB USB flash drive, DSXXXX.SET. The setup file(s) must be placed in the root directory to be recognized.

5. Press *Recall* to confirm recalling. When completed, a message appears at the bottom of the display.

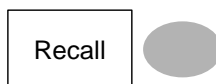

Note  The file will not be recalled if the power is turned off or the USB flash drive is removed before completion.

File utilities

To edit the USB drive contents (create/ delete/ rename files and folders), press *File Utilities*. For details, see page 111.



## Recalling a waveform

Procedure

1. (For recalling to USB) Insert the USB flash drive into the front panel USB port.

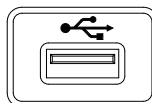

2. Press the Save/Recall key.



3. Press *Recall Waveform*. The display shows the available source and destination options.



4. Press *Source* repeatedly to select the file source, internal memory or USB. Use the Variable knob to change the memory location (W1 ~ W15)/DSXXXX.CSV.

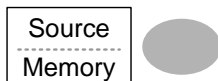

VARIABLE



Memory	Internal memory, W1 ~ W15
USB	USB flash drive, DSXXXX.CSV. The waveform file(s) must be placed in the root directory to be loaded.

5. Press *Destination*. Use the Variable knob to select the memory location.



VARIABLE



RefA, B	Internally stored reference waveforms A, B
---------	--

6. Press *Recall* to confirm recalling. When completed, a message appears at the bottom of the display.



Note  The file will not be recalled if the power is turned off or the USB flash drive is removed before completion.

File utilities

To edit the USB drive contents (create/ delete/ rename files and folders), press *File Utilities*. For details, see page 111.

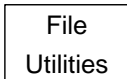

## Recall Image

Background

Recall Image is useful for recalling reference images that would not be possible using the Recall Waveform function, such as in X-Y mode. Using the Recall Image function will superimpose the reference image on the screen.

Before recalling an image, an image must first be saved to USB, see page 119.

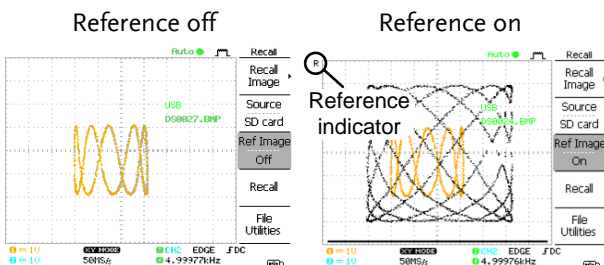

Procedure

1. Insert the USB flash drive into the front panel USB.

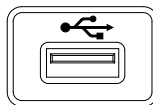

2. Press the Save/Recall key.



3. Press *Recall Image*. The display shows the available source and destination options.

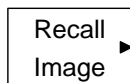

4. Use the Variable knob to choose a file name (DSXXXX.BMP).

VARIABLE



USB The image file must be placed in the root directory to be recognized.

5. Press *Recall* to confirm recalling. When completed, a message appears at the bottom of the display.

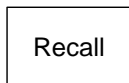

6. Press *Reference Image* to turn on / off the current image.



Note

The file will not be recalled if the power is turned off or the USB flash drive is removed before completion.

File utilities

To edit the USB drive contents (create/ delete/ rename files and folders), press *File Utilities*. For details, see page 111.

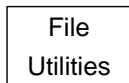



# M AINTENANCE

Two types of maintenance operations are available: calibrating the vertical resolution, and compensating the probe. Run these operations when using the oscilloscope in a new environment.

## Vertical Resolution Calibration

### Procedure

1. Press the Utility key.



2. Press the *More* key twice.

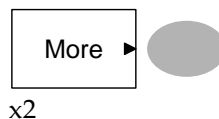

3. Press *Self Cal Menu*.

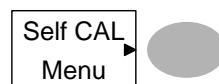

4. Press *Vertical*. The message “Set CAL to CH1, then press F5” appears at the bottom of the display.



5. Connect the calibration signal between the rear panel CAL out terminal and the Channel1 input.

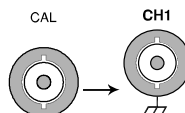

6. Press F5. The calibration automatically starts.

- The Channel1 calibration will complete in less than 5 minutes.

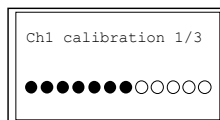

- When finished, connect the calibration signal to the Channel 2 input and repeat the procedure.



- When the calibration is complete the display will go back to the previous state.

## Probe Compensation

### Procedure

- Connect the probe between the Channel1 input and the probe compensation output (2Vp-p, 1kHz square wave) on the front panel. Set the probe voltage attenuation to x10.

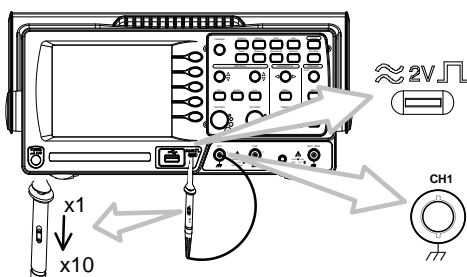

- Press the Utility key.



- Press *ProbeComp*.

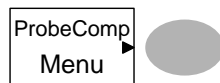

4. Press *Wavetype* repeatedly to select the standard square wave.

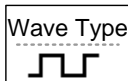

5. Press the Autoset key. The compensation signal will appear in the display.



6. Press the Display key, then *Type* to select the vector waveform.

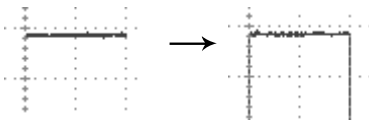
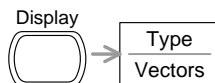

7. Turn the adjustment point on the probe until the signal edge becomes sharp.

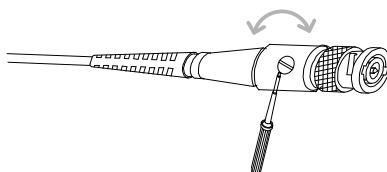
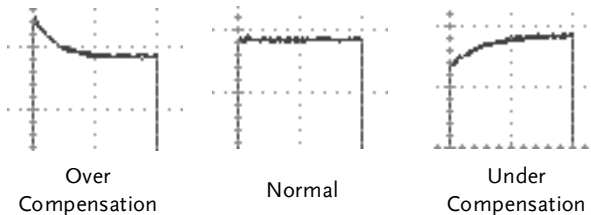

# FAQ

---

- The input signal does not appear in the display.
- I want to remove some contents from the display.
- The waveform does not update (frozen).
- The probe waveform is distorted.
- Autoset does not catch the signal well.
- I want to clean up the cluttered panel settings.
- The accuracy does not match the specifications.
- The oscilloscope will not allow a 2M waveform to be saved.

## The input signal does not appear in the display.

---

Make sure you have activated the channel by pressing the CH key (page 47).

## I want to remove some contents from the display.

---

To clear the math result, press the Math key again (page 63).

To clear the cursor, press the Cursor key again (page 61).

To clear the Help contents, press the Help key again (page 46).

The waveform does not update (frozen).

---

Press the Run/Stop key to unfreeze the waveform. See page 50 for details. For trigger setting details, see page 96.

If this does not help, press the CH key. If the signal still does not appear, press the Autoset key.

The probe waveform is distorted.

---

You might need to compensate the probe. For details, see page 130. Note that the frequency accuracy and duty factor are not specified for probe compensation waveforms and therefore it should not be used for other reference purposes.

Autoset does not catch the signal well.

---

The Autoset function does not catch signals well under 30mV or 20Hz. Please operate the oscilloscope manually. See page 48 for details.

I want to clean up the cluttered panel settings.

---

Recall the default settings by pressing the Save/Recall key→Default Setting. For default setting contents, see page 45.

The saved display image is too dark on the background.

---

Use the Inksaver function which reverses the background color. For details, see page 119.

The accuracy does not match the specifications.

---

Make sure the device is powered on for at least 30 minutes, within +20°C~+30°C. This is necessary to stabilize the unit to match the specification.

The oscilloscope will not allow a 2M waveform to be saved.

---

Make sure that only 1 channel is active. Make sure that the signal has been triggered and that the STOP or Single key has been pressed. Ensure the time base is slower than 10 ns/div. See page 107.

For more information, contact your local dealer or GWInstek at [www.gwinstek.com](http://www.gwinstek.com) / [marketing@goodwill.com.tw](mailto:marketing@goodwill.com.tw).

# APPENDIX

## Fuse Replacement

---

- Procedure
1. Remove the power cord and remove the fuse socket using a minus driver.

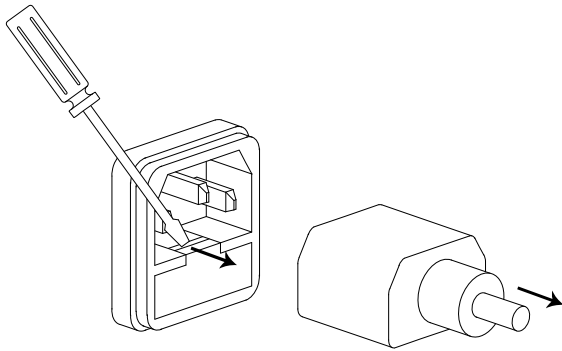

2. Replace the fuse in the holder.

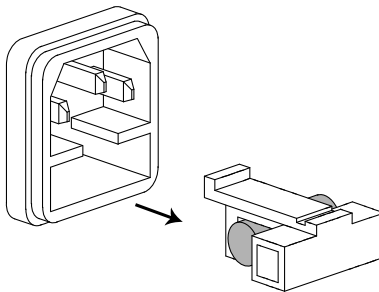

---

Ratings T1A, 250V

## GDS-1000A-U Series Specifications

The specifications apply when the oscilloscope is powered on for at least 30 minutes under +20°C~+30°C.

### Model-specific specifications

GDS-1072A-U	Bandwidth (-3dB)	DC coupling: DC ~ 70MHz AC coupling: 10Hz ~ 70MHz
	Bandwidth Limit	20MHz (-3dB)
	Trigger Sensitivity	0.5div or 5mV (DC ~ 25MHz) 1.5div or 15mV (25MHz~70MHz)
	External Trigger	~ 50mV (DC~25MHz)
	Sensitivity	~ 100mV (25MHz~70MHz)
	Rise Time	< 5ns approx.
GDS-1102A-U	Bandwidth (-3dB)	DC coupling: DC ~ 100MHz AC coupling: 10Hz ~ 100MHz
	Bandwidth Limit	20MHz (-3dB)
	Trigger Sensitivity	0.5div or 5mV (DC ~ 25MHz) 1.5div or 15mV (25MHz~100MHz)
	External Trigger	~ 50mV (DC~25MHz)
	Sensitivity	~ 100mV (25MHz~100MHz)
	Rise Time	< 3.5ns approx.
GDS-1152A-U	Bandwidth (-3dB)	DC coupling: DC ~ 150MHz AC coupling: 10Hz ~ 150MHz
	Bandwidth Limit	20MHz (-3dB)
	Trigger Sensitivity	0.5div or 5mV (DC ~ 25MHz) 1.5div or 15mV (25MHz~150MHz)
	External Trigger	~ 50mV (DC~25MHz)
	Sensitivity	~ 100mV (25MHz~100MHz)
	Rise Time	< 2.3ns approx.



## Common specifications

Vertical	Sensitivity	2mV/div~10V/Div (1-2-5 increments)
	Accuracy	± 3 full scale
	Bandwidth	See model-specific specifications
	Rise Time	See model-specific specifications
	Input Coupling	AC, DC, Ground
	Input Impedance	1MΩ±2%, ~15pF
	Polarity	Normal, Invert
	Maximum Input	300V (DC+AC peak), CAT II
	Math Operation	+, -, ×, FFT, FFT rms
Offset Range	2mV/div~50mV/div: ±0.4V	
	100mV/div~500mV/div: ±4V	
	1V/div~5V/div: ±40V	
	10V/div : ±300V	
Trigger	Sources	CH1, CH2, Line, EXT
	Modes	Auto, Normal, Single, TV, Edge, Pulse
	Coupling	AC, DC, LF rej, HF rej, Noise rej
	Sensitivity	See model-specific specifications
	Holdoff	40ns ~ 2.5s
External trigger	Range	DC: ±15V, AC: ±2V
	Sensitivity	See model-specific specifications
	Input Impedance	1MΩ±2%, ~15pF
	Maximum Input	300V (DC+AC peak), CATII
Horizontal	Range	1ns/div~50s/div, 1-2.5-5 increment Roll: 50ms/div – 50s/div
	Modes	Main, Window, Window Zoom, Roll, X-Y
	Accuracy	±0.01%
	Pre-Trigger	10 div maximum
	Post-Trigger	1000 div
X-Y Mode	X-Axis Input	Channel 1
	Y-Axis Input	Channel 2
	Phase Shift	±3° at 100kHz
Signal Acquisition	Real-Time	1G Sa/s maximum
	Equivalent	25G Sa/s maximum
	Vertical	8 bits
	Resolution	
	Record Length	Maximum; 2M points (1 channel), 1M points (2 channels)
	Acquisition	Normal, Peak Detect, Average
	Peak Detection	10ns (500ns/div ~ 50s/div)
Average	2, 4, 8, 16, 32, 64, 128, 256	

Cursors and Measurement	Voltage	Vpp, Vamp, Vavg, Vrms, Vhi, Vlo, Vmax, Vmin, Rise Preshoot/ Overshoot, Fall Preshoot/ Overshoot
	Time	Freq, Period, Rise Time, Fall Time, + Width, – Width, Duty Cycle
	Delay	FRR, FRF, FFR, FFF, LRR, LRF, LFR, LFF
	Cursors	Voltage difference ( $\Delta V$ ) and Time difference ( $\Delta T$ ) between cursors
	Auto Counter	Resolution: 6 digits, Accuracy: $\pm 2\%$ Signal source: All available trigger source except the Video trigger
Control Panel Function	Autoset	Automatically adjust Vertical Volt/div, Horizontal Time/div, and Trigger level
	Save/Recall	Up to 15 sets of measurement conditions and waveforms
Display	LCD	5.7 inch, TFT, brightness adjustable
	Resolution (dots)	234 (Vertical) x 320 (Horizontal)
	Graticule	8 x 10 divisions
	Display Contrast	Adjustable
Interface	USB Slave Connector	USB 2.0 full speed (CDC ACM)
	USB Host connector	Image (BMP) and waveform data (CSV)
Probe Compensation Signal	Frequency range	1kHz ~ 100kHz adjustable, 1kHz step
	Duty cycle	5% ~ 95% adjustable, 5% step
	Amplitude	2Vpp $\pm 3\%$
Power Source	Line Voltage	100V~240V AC, 47Hz~63Hz
	Power Consumption	18W, 40VA maximum
	Fuse Rating	1A slow, 250V
Operation Environment	Ambient temperature	0 ~ 50°C
	Relative humidity	$\leq 80\%$ , 40°C or below $\leq 45\%$ , 41°C~50°C
Storage Environment	Storage Temperature:	-10°C~60°C, no condensation- Relative humidity 93% @ 40°C 65% @ 41°C~60°C
Dimensions	310(W) x 142(H) x 140(D) mm	
Weight	Approx. 2.5kg	

## Probe Specifications

### GDS-1072A-U Probe

Applicable model & probe	GDS-1072A-U GTP-070B-4*	
Position x 10	Attenuation	10
	Bandwidth	DC ~ 70MHz
	Input Resistance	10M $\Omega$ (when used with oscilloscopes which have 1M $\Omega$ input)
	Input Capacitance	14.5~17.5pF
	Maximum Input Voltage	$\leq$ 600V DC +ACpk
	Compensation Range	10~35pF
Position x 1	Attenuation	1
	Bandwidth	DC ~ 10MHz
	Input Resistance	1M $\Omega$ (oscilloscope input resistance)
	Input Capacitance	85~115pF
	Maximum Input Voltage	$\leq$ 200V DC +ACpk
Operating Cond.	Temperature	-10 $^{\circ}$ C ~ 50 $^{\circ}$ C
	Humidity	$\leq$ 85% (Relative Humidity)
Net Weight	<55g	
Length	130cm $\pm$ 1.5cm	

### GDS-1102A-U Probe

Applicable model & probe	GDS-1102A-U GTP-100B-4*	
Position x 10	Attenuation	10
	Bandwidth	DC ~ 100MHz
	Input Resistance	10M $\Omega$ (when used with oscilloscopes which have 1M $\Omega$ input)
	Input Capacitance	14.5~17.5pF
	Maximum Input Voltage	$\leq$ 600V DC +ACpk
	Compensation Range	5~30pF
Position x 1	Attenuation	1
	Bandwidth	DC ~ 10MHz
	Input Resistance	1M $\Omega$ (oscilloscope input resistance)

	Input Capacitance	85~115pF
	Maximum Input Voltage	≤200V DC +ACpk
Operating Cond.	Temperature	-10°C ~ 50°C
	Humidity	≤85% (Relative Humidity)
Net Weight	<55g	
Length	130cm±1.5cm	

### GDS-1152A-U Probe

Applicable model & probe	GDS-1152A-U GTP-150B-4*	
Position x 10	Attenuation	10
	Bandwidth	DC ~ 150MHz
	Input Resistance	10MΩ (when used with oscilloscopes which have 1MΩ input)
	Input Capacitance	14.5~17.5pF
	Maximum Input Voltage	≤600V DC +ACpk
	Compensation Range	5~30pF
Position x 1	Attenuation	1
	Bandwidth	DC ~ 10MHz
	Input Resistance	1MΩ (oscilloscope input resistance)
	Input Capacitance	85~115pF
	Maximum Input Voltage	≤200V DC +ACpk
	Operating Cond.	Temperature
	Humidity	≤85% (Relative Humidity)
Net Weight	<55g	
Length	130cm±1.5cm	

\* Note: GW Instek reserves the right to change the probe model type (GTP-070B-4, GTP-100B-4, GTP-150B-4) at anytime without notice for probe model types of similar specification.

# Dimensions

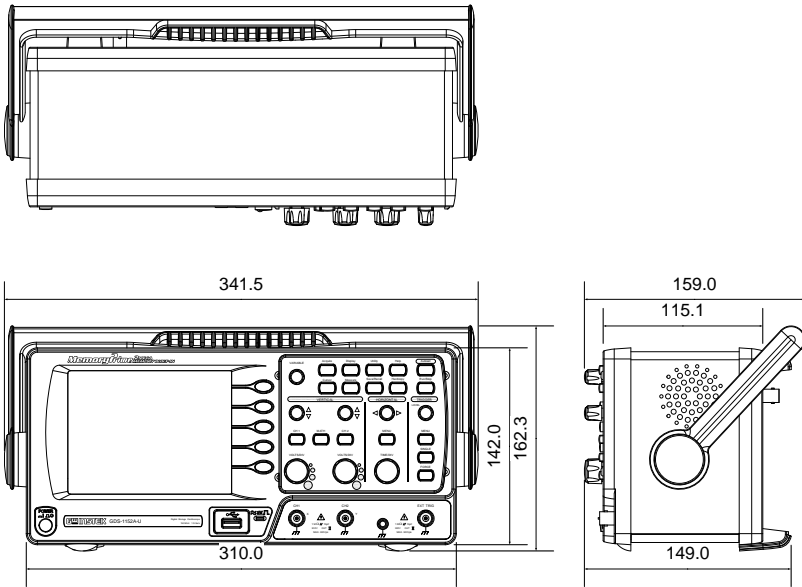

## EC Declaration of Conformity

We

**GOOD WILL INSTRUMENT CO., LTD.**

No.7-1, Jhongsing Rd., Tucheng Dist., New Taipei City 236, Taiwan

**GOOD WILL INSTRUMENT (SUZHOU) CO., LTD.**

No. 69, Lushan Road, Suzhou New District Jiangsu, China

declares that the below mentioned product

**GDS-1072A-U, GDS-1102A-U, GDS-1152A-U**

Are herewith confirmed to comply with the requirements set out in the Council Directive on the Approximation of the Law of Member States relating to Electromagnetic Compatibility (2004/108/EC) & (2014/30/EU) and Low Voltage Equipment Directive (2006/95/EC) & (2014/35/EU). For the evaluation regarding the Electromagnetic Compatibility and Low Voltage Equipment Directive, the following standards were applied:

### © EMC

<b>EN 61326-1 :</b>	Electrical equipment for measurement, control and laboratory use — EMC requirements (2013)
<b>EN 61326-2-1:</b>	
Conducted and Radiated Emissions EN 55011: 2009+A1: 2010	Electrostatic Discharge EN 61000-4-2: 2009
Current Harmonic EN 61000-3-2: 2014	Radiated Immunity EN 61000-4-3: 2008+A2 :2010
Voltage Fluctuation EN 61000-3-3: 2013	Electrical Fast Transients EN 61000-4-4: 2012
-----	Surge Immunity EN 61000-4-5: 2006
-----	Conducted Susceptibility EN 61000-4-6: 2014
-----	Power Frequency Magnetic Field EN 61000-4-8: 2010
-----	Voltage Dips/ Interrupts EN 61000-4-11: 2004

### © Safety

<b>Low Voltage Equipment Directive 2006/95/EC &amp; 2014/35/EU</b>
Safety Requirements EN 61010-1: 2010 (Third Edition) EN 61010-2-030: 2010 (First Edition)

# INDEX

2M memory length limits .....	108	menu tree .....	25
AC coupling .....	92	specification.....	138
Accumulating waveform.....	83	Cycle time measure.....	56
Acquisition .....	78	Data logging	
menu tree.....	24	menu tree .....	43
specification.....	137	overview .....	74
Addition.....	64	run.....	77
Amplitude measure.....	55	setup .....	75
Auto set.....	49	source .....	75
exception.....	50	DC coupling.....	91
specification.....	138	Declaration of conformity .....	142
type.....	49	Default setup .....	123
Auto trigger .....	96	contents .....	45
Automatic measurement .....	58	menu tree .....	32
menu tree.....	31	Delay measure.....	56
overview.....	55	Delay mode.....	80
specification.....	138	Delay Off.....	81
Automatic measurement gating		Delay On .....	80
.....	57	Display .....	84
Average acquisition.....	79	contrast setting.....	84
Average voltage measure .....	56	diagram .....	19
Bandwidth limitation .....	94	grid setting.....	84
Blackman window .....	64	menu tree.....	26
Calibration		specification.....	138
menu tree.....	41	Display image	
Calibration, vertical resolution		faq .....	133
.....	129	file format.....	107
Caution symbol.....	8	recall menu tree.....	33
Channel .....	47	save .....	119
faq.....	132	save menu tree.....	35
menu tree.....	24	Disposal instructions .....	11
Cleaning the instrument .....	10	Dot waveform.....	83
Configure remote control .....	104	Duty cycle measure .....	56
Coupling mode .....	91	Edge trigger .....	99
menu tree.....	24	menu tree .....	38
Cursor.....	61	EN61010	
faq.....	132	measurement category .....	9
		pollution degree .....	11

Environment .....	138	Horizontal.....	85
safety instructions .....	10	basic operation .....	51
Equivalent time sampling .....	82	cursor operation.....	61
Expand Center .....	92	menu tree .....	27
Expand Ground .....	92	position .....	85
External trigger .....	96	scale .....	85
input terminal.....	17	specification.....	137
Falling time measure.....	56	IEC 1010-1 .....	139, 140
Faq.....	133	Image	
FFT.....	65	recall .....	127
menu tree .....	30	Ink saver	
overview.....	63, 64	in hardcopy.....	114
File format .....	107	in save all .....	120
Firmware version .....	105	Input frequency indicator.....	19
Flattop window .....	64	Invert waveform .....	93
Force trigger.....	103	Language selection .....	105
Frequency measure .....	56	List of features.....	13
Frequency rejection .....	98	Low voltage measure .....	56
Front panel diagram .....	15	Math	
Fuse replacement.....	135	faq.....	132
safety instruction.....	10	menu tree .....	29
Gated Automatic measurements		overview .....	63
.....	57	Measurement.....	47
General purpose signal.....	53	Memory Length	
Go-NoGo		faq .....	134
conditions.....	69	Model caomparison.....	13
menu tree .....	40	Multiplication.....	64
overview.....	67	Negative peak measure.....	55
run.....	73	Noise rejection.....	98
source.....	68	Normal acquisition.....	78
template.....	69	Normal trigger .....	97
when .....	68	NTSC .....	97
Ground		Operating environment .....	138
coupling.....	91	Overshoot voltage measure.....	56
symbol .....	8	PAL.....	97
terminal .....	17	Peak detect acquisition.....	79
Hanning window .....	64	Peak to peak measure.....	55
Hardcopy.....	113	Peak voltage measure.....	55
Hardcopy - Save All		Power on/off	
menu tree .....	41	safety instruction .....	10
Hardcopy - Save image		switch overview .....	18
menu tree .....	42, 44	Preshoot voltage measure.....	56
Help.....	46	Probe.....	130
faq.....	132	attenuation level .....	94
High voltage measure.....	55	attenuation menu tree .....	24
Holdoff.....	98	compensation menu tree.....	42



compensation signal overview .....	53	recall menu tree .....	32
faq .....	133	save menu tree .....	34
peak detect demonstration .....	79	Single trigger .....	103
Pulse time measure .....	56	Single trigger mode .....	97
Pulse width trigger .....	101	Specifications .....	136
condition .....	98	faq .....	134
menu tree .....	38	Subtraction .....	64
Real time sampling .....	82	System information .....	105
Rear panel diagram .....	18	Timebase indicator .....	85
Recall .....	122	Trigger .....	96
default setup .....	123	coupling .....	98
image .....	127	edge .....	99
menu tree .....	32	force .....	103
reference waveform .....	124	indicator .....	96
setup .....	124	level knob .....	98
waveform .....	125	menu tree .....	37
Rectangular window .....	64	parameter .....	96
Reference waveform		pulse width .....	101
menu tree .....	34	specification .....	137
recall .....	124	status indicator .....	19
Remote control interface .....	104	video .....	100
Rising time measure .....	56	UK power cord .....	12
Roll mode .....	86	USB	
Root mean square measure .....	56	file operation .....	111
Run/stop .....	50	file utilities menu tree .....	36
faq .....	133	Utility	
Save .....	115	key overview .....	16
display image .....	119	menu tree .....	40
menu tree .....	32	Vector waveform .....	83
setup .....	116	Vertical .....	91
specification .....	138	basic operation .....	52
waveform .....	117	cursor operation .....	62
Save all .....	120	position .....	91
menu tree .....	36	resolution calibration .....	129
SECAM .....	97	scale .....	91
Security lock slot .....	18	specification .....	137
Serial number .....	105	Video line .....	97
Service operation		Video trigger .....	100
about disassembly .....	9	menu tree .....	37
contact .....	134	Warning symbol .....	8
Setting the handle .....	20	Waveform	
Setting up the oscilloscope .....	20	expand waveform .....	92
Setup		file format .....	107
default contents .....	45	invert waveform .....	93
file format .....	110	Memory depth .....	108
how to save .....	116	recall .....	125
recall .....	124	recall menu tree .....	33
		roll mode .....	86

save .....	117	X-Y mode .....	88, 89
save menu tree.....	35	specification.....	137
x-y mode.....	88, 89	Zoom waveform .....	87
zoom mode .....	87		
Waveform accumulation .....	83		