

Rack Adapter Panel

GRA-430

GW INSTEK

Assembly Manual

GW INSTEK PART NO. 82RA-43000M01

This assembly manual contains proprietary information, which is protected by copyrights. All rights are reserved. No part of this manual may be photocopied, reproduced or translated to another language without prior written consent of Good Will company.

The information in this manual was correct at the time of printing. However, Good Will continues to improve products and reserves the rights to change specification, equipment, and maintenance procedures at any time without notice.

Good Will Instrument Co., Ltd.
No. 7-1, Jhongsing Rd., Tucheng Dist., New Taipei City 236, Taiwan.



ISO-9001 CERTIFIED MANUFACTURER

GW INSTEK

GRA-430

The GRA-430 rack mount is suited for use with the APS-7300 AC power sources. Only one power source can be used with the GRA-430 rack adapter. The GRA-430 will accommodate a 9U-sized rack.

Rack Mount Adapter Component List

Description

Please check to make sure all the components of the GRA-430 rack mount kit are provided.

Item	Part NO.	Description	QTY
1	594B-W4012NS1	SCREW BMS, 4*12, ISO, N (WASHER P.S) , RoHS	6
2	62RA-430HP101	GRA-430 9U LEFT BRACKET ,RoHS	1
3	62RA-430HP201	GRA-430 9U RIGHT BRACKET ,RoHS	1

Assembly

Initial setup

1. Remove the four wheel casters from the APS-7300 as shown in the below diagram.

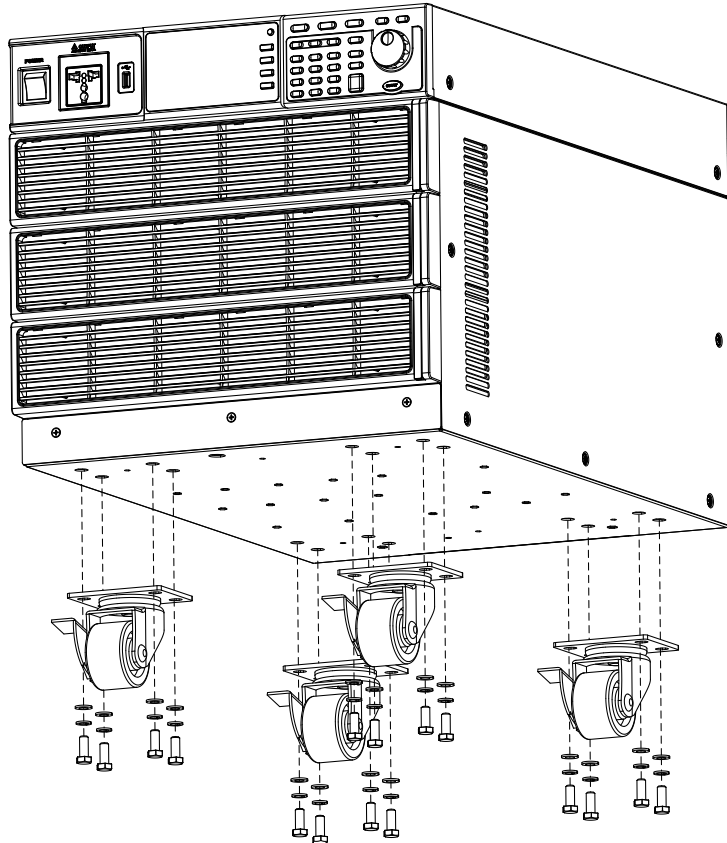

2. Remove the six screws located on each side panel of the APS-7300 as shown in the below diagram.

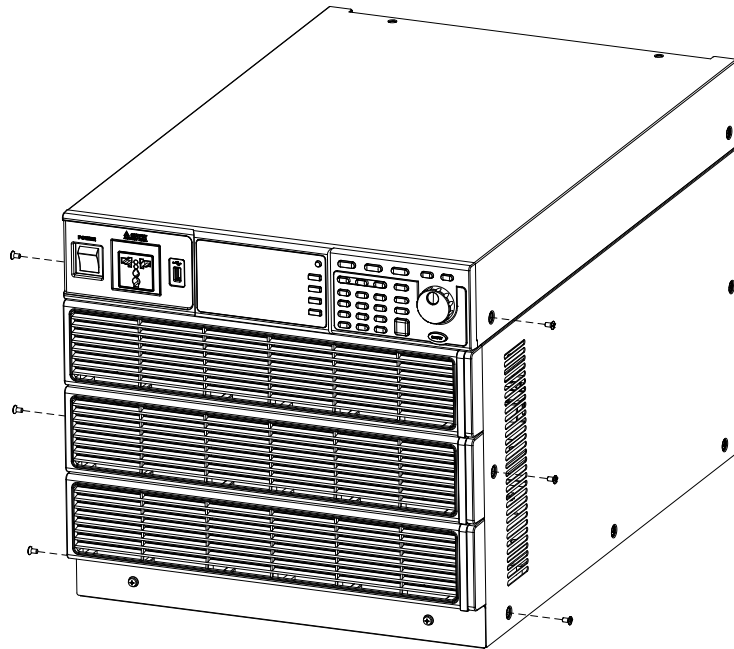

3. Screw the left bracket (62RA-430HP101) to the left side panels of the APS-7300 and right bracket (62RA-430HP201) to the right side panel of the APS-7300 using the six (594B-W4012NS1) screws as shown in the below diagram.

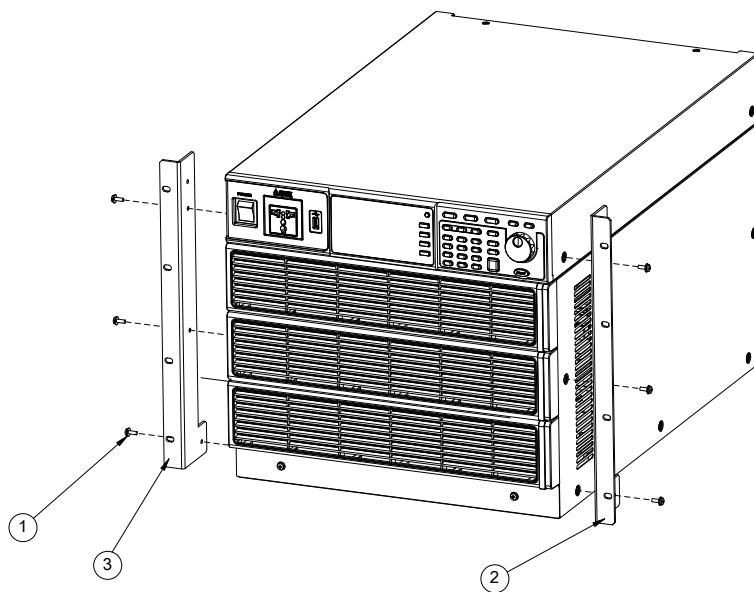

Specification

Rack Dimensions APS-7300

