

Multi-Function Programmable Oscilloscope

MPO-2000 series

PROGRAMMING MANUAL



ISO-9001 CERTIFIED MANUFACTURER

GW INSTEK

This manual contains proprietary information which is protected by copyright. All rights are reserved. No part of this manual may be photocopied, reproduced or translated to another language without prior written consent of Good Will Corporation.

The information in this manual was correct at the time of printing. However, Good Will continues to improve products and reserves the right to change specifications, equipment, and maintenance procedures at any time without notice.

Windows is a registered trademark of Microsoft Corporation in the United States and other countries.

Good Will Instrument Co., Ltd.
No. 7-1, Jhongsing Rd., Tucheng Dist., New Taipei City 236, Taiwan.

Table of Contents

INTERFACE OVERVIEW	5
Interface Configuration	5
Web Server	10
COMMAND OVERVIEW	14
Command Syntax	14
List of Commands in Functional Order	16
COMMAND DETAILS	32
Common Commands	34
Acquisition Commands	40
Autoscale Commands	48
Vertical Commands	49
Math Commands	55
Cursor Commands	64
Display Commands	75
Hardcopy Commands	79
Measure Commands	82
Measurement Commands	108
Reference Commands	116
Run Command	119
Stop Command	120
Single Command	121
Force Command	122
Timebase Commands	123
Trigger Commands	126
System Commands	160
Save/Recall Commands	161
Ethernet Command	166
Time Command	167
Bus Decode Commands	168

Mark Commands.....	179
Search Commands	181
Label Commands	211
Segment Commands	217
DVM Commands.....	226
Go_NoGo Commands	228
AWG Commands.....	234
Data Logging Commands.....	255
Remote Disk Commands.....	258
Spectrum Analyzer Commands	261
USB Delay Command	278
FRA Commands	279
Power Supply Commands.....	287
Python Commands.....	289
APPENDIX.....	296
Error messages	296
INDEX.....	300

INTERFACE OVERVIEW

This manual describes how to use the MPO-2000's remote command functionality and lists the command details. The Overview chapter describes how to configure the USB and Ethernet remote control interfaces.

Interface Configuration

Configure USB Interface

USB Configuration	PC side connector	Type A, host
	MPO-2000 side connector	Type B, device
	Speed	1.1/2.0
	USB Class	CDC (communications device class)

Panel Operation 1. Press the Utility key.



2. Press *I/O* from the bottom menu.

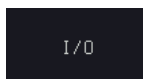

3. Rotate the *VARIABLE* knob to select the *USB Device Port* function.



4. Select *Computer* from the side menu.



- This oscilloscope is a USB-TMC device. Please install the National Instruments NI-VISA library which can download from the National Instruments web site. Newer versions are likely, and should be compatible with this instrumentation. Download the latest version available for the operating system being used by the controlling computer.

USB Functionality Check

Terminal Application

Invoke a terminal application such as RealTerm.

Set the COM port, baud rate, stop bit, data bit, and parity accordingly.

To check the COM port number and associated port settings, see the Device Manager in the PC. For Windows 7:

Control panel → Hardware and Sound → Device Manager

Example: Configuring RealTerm:

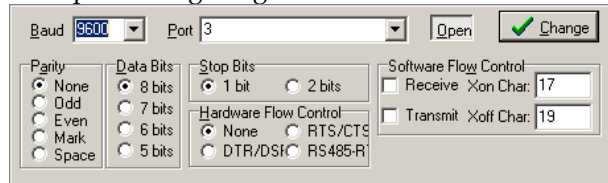

Functionality Check



Key in this query command via the terminal application.

`*!dn?`

This should return the Manufacturer, Model number, Serial number, and Firmware version in the following format.

GW,MPO-2202P,PXXXXXX,V1.00

Configure the Ethernet Interface

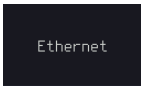
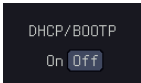
Ethernet Configuration	MAC Address	Domain Name
	Instrument Name	DNS IP Address
	User Password	Gateway IP Address
	Instrument IP Address	Subnet Mask
		HTTP Port 80 (fixed)
Background	The Ethernet interface is used for remote control using a socket server connection. For details, please see the Socket Server section on page 9.	
Panel Operation	<ol style="list-style-type: none"> 1. Connect the Ethernet cable to the LAN port on the rear panel. 2. Press the <i>Utility</i> key. 3. Press <i>I/O</i> from the bottom menu. 4. Press <i>Ethernet</i> from the side menu. 5. Set <i>DHCP/BOOTP</i> to <i>On</i> or <i>Off</i> from the side menu. 	    



Note

IP addresses will automatically be assigned with DHCP/BOOTP set to on. For Static IP Addresses, DHCP/BOOTP should be set to off.

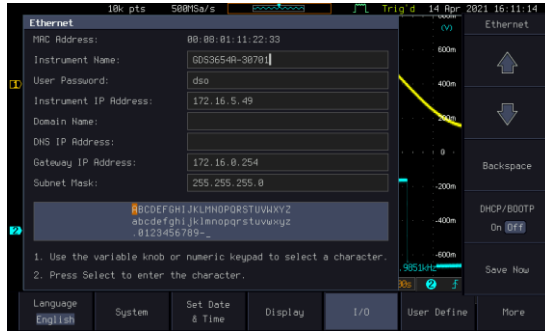

- Use the *Up* and *Down* arrows on the side menu to navigate to each Ethernet configuration item.



Items MAC Address, Instrument Name, User Password, Instrument IP Address, Domain Name, DNS IP Address, Gateway IP Address, Subnet Mask

Note: HTTP Port is fixed at 80.

- Use the *Variable* knob to highlight a character and use the *Select* key to choose a character.

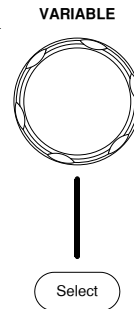

Press *Backspace* to delete a character.



Press *Save Now* to save the configuration. Complete will be displayed when successful.

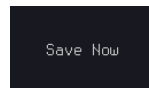

Configure Socket Server

The MPO-2000 supports socket server functionality for direct two-way communication with a client PC or device over LAN. By default, the Socket Server is off.

Configure Socket Server Page 7

1. Configure the IP address for the MPO-2000.
2. Press the *Utility* key.



3. Press *I/O* from the bottom menu.

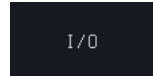

4. Rotate the *VARIABLE* knob to select the *Socket Server* function.



5. Press *Select Port* and choose the port number with the Variable knob.



Please notice that the default socket port for MPO-2000 series is "5025".

Range 1024~65535

6. Press *Set Port* to confirm the port number.

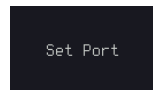

7. The *Current Port* icon will update to the new port number.



8. Press *Server* and turn the socket server On.

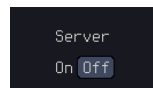

Web Server

Web Server Overview

Background

The MPO-2000 series has an inbuilt web server that can be used to:

- view the system information (Welcome Page)
- set/view the network configuration settings (Network Configuration)
- remotely view the current display image on the unit (Get Display Image)
- execute SCPI command
- send the internal profile of oscilloscope to PC side or receive profile
- Web control function: control oscilloscope remotely from browser and display waveform in real-time

System Information:

- Manufacturer
- Serial Number
- Firmware version
- Hostname
- Domain name
- IP Address
- Subset Mask
- DNS
- MAC Address
- DHCP State

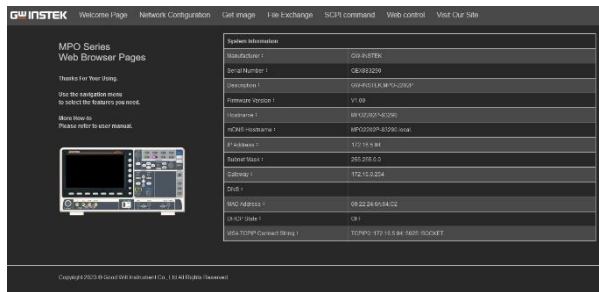

Network Configuration

- Hostname
- Domain name
- IP Address
- Subnet mask
- Gateway
- DNS
- DHCP State

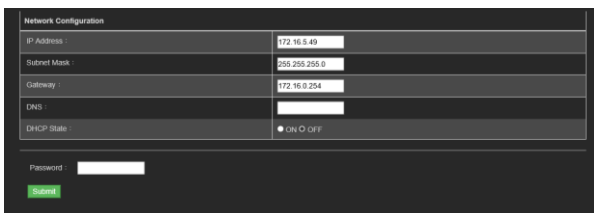

Get Display Image

- Current display image



File Exchange

Upload or download profile (*.set) to oscilloscope Web

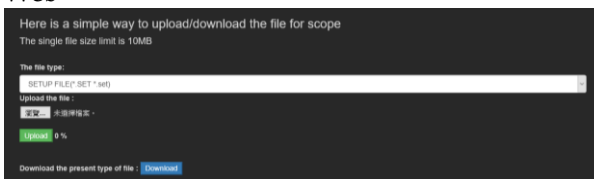

SCPI command

Control oscilloscope remotely from browser via executing SCPI command

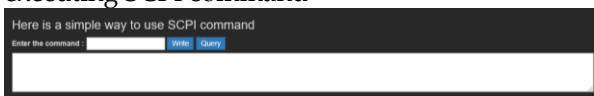

Web control

Control oscilloscope remotely from browser via graphical user interface (GUI) to display real-time waveform



Panel Operation

1. Configure the Ethernet interface. Page 6
2. Enter the IP address of the MPO-2000 unit into the address bar of a web browser.

For example

<http://172.16.20.255>

3. Press *I/O* from the bottom menu.

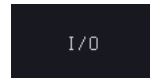

4. Rotate the *VARIABLE* knob to select the *Web Server* function.



5. Press the *Connect* button in the side menu to connect to internet.



6. The "ONLINE" will be shown for web server when internet connection is established.



7. The MPO-2000 web browser welcome page appears.

GW INSTEK Welcome Page Network Configuration Call usage File Exchange SCPI command Web control Visit Our Site

**MPO Series
Web Browser Pages**

Thanks for Your Using.

Use the navigation menu to select the features you need.

Basic Setup
Please refer to user manual.



System Information	
Manufacturer 1	GW INSTEK
Serial Number 1	08381820
Model Name 1	GW INSTEK MPO2000P
Firmware Version 1	1.0.0
Hardware 1	MS12300-M3000
PCMC Memory 1	MP0000P-A1000 user
IP Address 1	192.16.8.81
Default Host 1	255.255.0.0
Gateway 1	192.16.8.204
DNS 1	
MAC Address 1	08-00-20-40-16-02
LAN Card 1	CM1
LAN TCP/IP Control Setting 1	TCP/IP: 192.16.8.81 8081 SOCKET

Copyright © 2013 by GW INSTEK Inc. All Rights Reserved.

C **COMMAND OVERVIEW**

The Command overview chapter lists all MPO-2000 commands in functional order as well as alphabetical order. The command syntax section shows you the basic syntax rules you have to apply when using commands.

Command Syntax

- | | |
|---------------------|---|
| Compatible standard | <ul style="list-style-type: none"> • USB CDC_ACM compatible • SCPI, 1994 (partially compatible) |
|---------------------|---|

Command forms Commands and queries have two different forms, long and short. The command syntax is written with the short form of the command in capitals and the remainder (long form) in lower case.

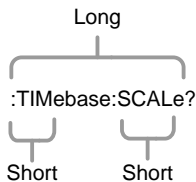

The commands can be written in capitals or lower-case, just so long as the short or long forms are complete. An incomplete command will not be recognized.

Below are examples of correctly written commands.

LONG :TIMEbase:SCALE? :TIMEBASE:SCALE?
 :timebase:scale?

SHORT :TIM:SCAL? :TIM:SCAL?

Command format :TIMEbase:SCALE <NR3>LF 1: command header

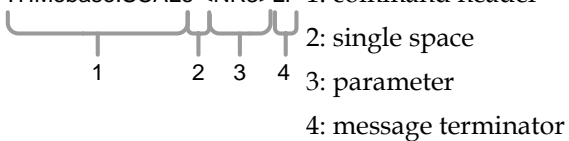

Parameter	Type	Description	Example
	<Boolean>	boolean logic	0, 1
	<NR1>	Integers	0, 1, 2, 3
	<NR2>	floating point	0.1, 3.14, 8.5
	<NR3>	floating point with an exponent	4.5e-1, 8.25e+1
	<NRf>	any of NR1, 2, 3	1, 1.5, 4.5e-1
Message terminator	LF	line feed code	



Note

Commands are non-case sensitive.

List of Commands in Functional Order

Common commands	*IDN?	34
	*LRN?	34
	*SAV	35
	*RCL	35
	*RST	35
	*CLS	36
	*ESE	36
	*ESR	36
	*OPC	37
	*SRE	37
*STB	38	
<hr/>		
Acquisition commands	:ACQuire:AVERage	40
	:ACQuire:MODe	41
	:ACQuire<X>:MEMory?	41
	:ACQuire:FILTer:SOURce	43
	:ACQuire:FILTer	44
	:ACQuire:FILTer:FREQuency	44
	:ACQuire:FILTer:FREQuency:UPPER	44
	:ACQuire:FILTer:FREQuency:LOWER	45
	:ACQuire:FILTer:TYPe	45
	:ACQuire:FILTer:TRACking	46
	:ACQuire<X>:STATe?	46
	:ACQuire:INTERpolation	46
	:ACQuire:RECOrdlength	47
:HEADer	47	
<hr/>		
Autoscale commands	:AUTOSet	48
	:AUTORSET:MODe	48
<hr/>		
Vertical Scale commands	:CHANnel<X>:BWLimit	49
	:CHANnel<X>:COUPling	50
	:CHANnel<X>:DESKew	50

	:CHANnel<X>:DISPlay	50
	:CHANnel<X>:EXPand	51
	:CHANnel<X>:IMPedance?	51
	:CHANnel<X>:INVert	52
	:CHANnel<X>:POSition	52
	:CHANnel<X>:PROBe:RATio	53
	:CHANnel<X>:PROBe:TYPe	53
	:CHANnel<X>:SCALE	54
<hr/>		
Math commands	:MATH:DISP	55
	:MATH:TYPe	56
	:MATH:DUAL:SOURce<X>	56
	:MATH:DUAL:OPERator	57
	:MATH:DUAL:POSition	57
	:MATH:DUAL:SCALE	57
	:MATH:FFT:SOURce	58
	:MATH:FFT:MAG	58
	:MATH:FFT:WINDow	58
	:MATH:FFT:POSition	59
	:MATH:FFT:SCALE	59
	:MATH:FFT:HORizontal:SCALE	60
	:MATH:FFT:HORizontal:POSition	60
	:MATH:DEFine	60
	:MATHVAR?	61
	:MATHVAR:VAR<X>	62
	:MATH:ADVanced:POSition	62
	:MATH:ADVanced:SCALE	63
<hr/>		
Cursor commands	:CURSor:MODE	64
	:CURSor:SOURce	65
	:CURSor:HUNI	65
	:CURSor:HUSE	66
	:CURSor:VUNI	66
	:CURSor:VUSE	67
	:CURSor:DDT	67

	:CURSor:H1Position	68
	:CURSor:H2Position	68
	:CURSor:HDELta	68
	:CURSor:V1Position	69
	:CURSor:V2Position	69
	:CURSor:VDELta	69
	:CURSor:XY:RECTangular:X:POSition<X>	70
	:CURSor:XY:RECTangular:X:DELta	70
	:CURSor:XY:RECTangular:Y:POSition<X>	70
	:CURSor:XY:RECTangular:Y:DELta	71
	:CURSor:XY:POLar:RADIUS:POSition<X>	71
	:CURSor:XY:POLar:RADIUS:DELta	72
	:CURSor:XY:POLar:THETA:POSition<X>	72
	:CURSor:XY:POLar:THETA:DELta	72
	:CURSor:XY:PRODuct:POSition<X>	73
	:CURSor:XY:PRODuct:DELta	73
	:CURSor:XY:RATio:POSition<X>	73
	:CURSor:XY:RATio:DELta	74
<hr/>		
Display	:DISPlay:INTensity:WAVEform	75
commands	:DISPlay:INTensity:GRATICule	75
	:DISPlay:INTensity:BACKLight	76
	:DISPlay:INTensity:BACKLight:AUTODim:ENable	76
	:DISPlay:INTENSITY:BACKLight:AUTODim:TIME	76
	:DISPlay:PERSistence	77
	:DISPlay:GRATICule	77
	:DISPlay:WAVEform	78
	:DISPlay:OUTPut	78
<hr/>		
Hardcopy	:HARDcopy:START	79
commands	:HARDcopy:MODE	79
	:HARDcopy:PRINTINKSaver	80
	:HARDcopy:SAVEINKSaver	80
	:HARDcopy:SAVEFORMat	80
	:HARDcopy:ASSIGN	81

Measure commands	:MEASure:GATing.....	83
	:MEASure:SOURce	83
	:MEASure:METhod	84
	:MEASUrement:REFLevel:PERCent:HIGH.....	84
	:MEASUrement:REFLevel:PERCent:LOW	85
	:MEASUrement:REFLevel:PERCent:MID	85
	:MEASUrement:REFLevel:PERCent:MID2	85
	:MEASure:FALL.....	86
	:MEASure:FOVShoot	86
	:MEASure:FPReshoot	87
	:MEASure:FREQuency	87
	:MEASure:NWIDth	88
	:MEASure:PDUTy.....	88
	:MEASure:PERiod	89
	:MEASure:PWIDth	89
	:MEASure:RISe.....	90
	:MEASure:ROVShoot.....	91
	:MEASure:RPReshoot	91
	:MEASure:PPULSE.....	92
	:MEASure:NPULSE	92
	:MEASure:PEDGE	93
	:MEASure:NEDGE	93
	:MEASure:AMPlitude.....	94
	:MEASure:MEAN	94
	:MEASure:CMEan	95
	:MEASure:HIGH	96
	:MEASure:LOW	96
	:MEASure:MAX.....	97
	:MEASure:MIN	97
	:MEASure:PK2PK	98
	:MEASure:RMS	98
	:MEASure:CRMS.....	99
	:MEASure:AREa	100
:MEASure:CARea	100	
:MEASure:FRRDelay	101	

	:MEASure:FRFDelay	101
	:MEASure:FFRDelay	102
	:MEASure:FFFDelay.....	103
	:MEASure:LRRDelay	103
	:MEASure:LRFDelay.....	104
	:MEASure:LFRDelay.....	104
	:MEASure:LFFDelay.....	105
	:MEASure:PHase.....	106
	:MEASure:PFLI.....	106
	:MEASure:FLI.....	107
<hr/>		
Measurement	:MEASUrement:MEAS<X>:SOURCE<X>	108
commands	:MEASUrement:MEAS<X>:TYPE.....	109
	:MEASUrement:MEAS<X>:STATE	109
	:MEASUrement:MEAS<X>:VALue	110
	:MEASUrement:MEAS<X>:MAXimum	111
	:MEASUrement:MEAS<X>:MEAN	112
	:MEASUrement:MEAS<X>:MINImum	112
	:MEASUrement:MEAS<X>:STDdev	113
	:MEASUrement:STATIstics:MODE	114
	:MEASUrement:STATIstics:WEIghting	114
	:MEASUrement:STATIstics	115
<hr/>		
Reference	:REF<X>:DISPlay	116
commands	:REF<X>:TIMEbase:POSition	116
	:REF<X>:TIMEbase:SCALE	117
	:REF<X>:OFFSet.....	117
	:REF<x>:SCALE	118
<hr/>		
Run command	:RUN	119
<hr/>		
Stop command	:STOP.....	120
<hr/>		
Single command	:SINGle	121

Force command	:FORCe	122
---------------	--------------	-----

Timebase commands	:TIMebase:EXPand	123
	:TIMebase:POSition	123
	:TIMebase:SCALE.....	124
	:TIMebase:MODE	124
	:TIMebase:WINDow:POSition	124
	:TIMebase:WINDow:SCALE	125

Trigger commands	:TRIGger:FREQuency.....	127
	:TRIGger:TYPe.....	128
	:TRIGger:SOURce	128
	:TRIGger:COUPlE.....	129
	:TRIGger:NREJ	129
	:TRIGger:MODE.....	130
	:TRIGger:HOLDoff.....	130
	:TRIGger:LEVel.....	130
	:TRIGger:HLEVel.....	131
	:TRIGger:LLEVel.....	131
	:TRIGger:EDGe:SLOP	132
	:TRIGger:DELaY:SLOP	132
	:TRIGger:DELaY:TYPe	133
	:TRIGger:DELaY:TIME.....	133
	:TRIGger:DELaY:EVENt.....	133
	:TRIGger:DELaY:LEVel	134
	:TRIGger:PULSEWidth:POLarity.....	134
	:TRIGger:RUNT:POLarity	134
	:TRIGger:RUNT:WHEn	135
	:TRIGger:RUNT:TIME	135
:TRIGger:RISEFall:SLOP	136	
:TRIGger:RISEFall:WHEn.....	136	
:TRIGger:RISEFall:TIME.....	137	
:TRIGger:VIDeo:TYPe	137	
:TRIGger:VIDeo:FIELD	138	
:TRIGger:VIDeo:LINE.....	138	

:TRIGger:VIDeo:POLarity	139
:TRIGger:PULSe:WHEn	139
:TRIGger:PULSe:TIMe	140
:TRIGger:TIMEOut:WHEn	140
:TRIGger:TIMEOut:TIMER	140
:TRIGger:STATe	141
:TRIGger:EXTERnal:PROBe:TYPe.....	141
:TRIGger:EXTERnal:PROBe:RATio	142
:TRIGger:BUS:TYPe	142
:TRIGger:BUS:THReshold:CH<x>.....	143
:TRIGger:BUS:B1:I2C:CONDition	143
:TRIGger:BUS:B1:I2C:ADDRes:MODE.....	144
:TRIGger:BUS:B1:I2C:ADDRes:TYPe.....	144
:TRIGger:BUS:B1:I2C:ADDRes:VALue	145
:TRIGger:BUS:B1:I2C:ADDRes:DIRection	146
:TRIGger:BUS:B1:I2C:DATa:SIZE	146
:TRIGger:BUS:B1:I2C:DATa:VALue.....	147
:TRIGger:BUS:B1:UART:CONDition	147
:TRIGger:BUS:B1:UART:RX:DATa:SIZE	148
:TRIGger:BUS:B1:UART:RX:DATa:VALue	148
:TRIGger:BUS:B1:UART:TX:DATa:SIZE	149
:TRIGger:BUS:B1:UART:TX:DATa:VALue	150
:TRIGger:BUS:B1:CAN:CONDition.....	150
:TRIGger:BUS:B1:CAN:FRAMeType	151
:TRIGger:BUS:B1:CAN:IDentifier:MODE.....	151
:TRIGger:BUS:B1:CAN:IDentifier:VALue	152
:TRIGger:BUS:B1:CAN:IDentifier:DIRection	153
:TRIGger:BUS:B1:CAN:DATa:QUALifier.....	153
:TRIGger:BUS:B1:CAN:DATa:SIZE.....	154
:TRIGger:BUS:B1:CAN:DATa:VALue.....	154
:TRIGger:BUS:B1:LIN:CONDition	155
:TRIGger:BUS:B1:LIN:DATa:QUALifier	156
:TRIGger:BUS:B1:LIN:DATa:SIZE	157
:TRIGger:BUS:B1:LIN:DATa:VALue	157
:TRIGger:BUS:B1:LIN:ERRTYPe.....	158

	:TRIGger:BUS:B1:LIN:IDentifier:VALue	158
System commands	:SYSTem:LOCK	160
	:SYSTem:ERRor.....	160
Save/Recall commands	:RECALL:SETUp	161
	:RECALL:WAVEform	161
	:SAVe:IMAGe	162
	:SAVe:IMAGe:FILEFormat.....	162
	:SAVe:IMAGe:INKSaver.....	163
	:SAVe:SETUp.....	163
	:SAVe:WAVEform	164
	:SAVe:WAVEform:FILEFormat	165
Ethernet Command	:ETHERnet:DHCP	166
Time Command	:DATE	167
Bus Decode Commands	:BUS1	168
	:BUS1:STATE	169
	:BUS1:TYPe	169
	:BUS1:INPut.....	170
	:BUS1:I2C:ADDRes:RWINClude.....	170
	:BUS1:I2C:SCLK:SOURce	170
	:BUS1:I2C:SDA:SOURce.....	171
	:BUS1:UART:BITRate	171
	:BUS1:UART:DATABits	171
	:BUS1:UART:PARIty.....	172
	:BUS1:UART:PACKEt	172
	:BUS1:UART:POLARity	172
	:BUS1:UART:EOFPacket	173
	:BUS1:UART:TX:SOURce	173
	:BUS1:UART:RX:SOURce	173
	:BUS1:DISPlay:FORMAt	174
	:LISTer:DATA	174

	:BUS1:CAN:SOURce.....	174
	:BUS1:CAN:PROBe.....	175
	:BUS1:CAN:SAMPLEpoint.....	175
	:BUS1:CAN:BITRate	176
	:BUS1:LIN:BITRate	176
	:BUS1:LIN:IDFOrmat	177
	:BUS1:LIN:POLARity	177
	:BUS1:LIN:SAMPLEpoint	177
	:BUS1:LIN:SOURce	178
	:BUS1:LIN:STANDard	178

Mark Commands	:MARK.....	179
	:MARK:CREATE.....	179
	:MARK:DELEte.....	180

Search	:SEARCH:COPIY	182
Commands	:SEARCH:STATE	183
	:SEARCH:TOTAL	183
	:SEARCH:TRIGger:TYPe	183
	:SEARCH:TRIGger:SOURce.....	184
	:SEARCH:TRIGger:EDGE:SLOP	184
	:SEARCH:TRIGger:LEVel	184
	:SEARCH:TRIGger:HLEVel	185
	:SEARCH:TRIGger:LLEVel	185
	:SEARCH:TRIGger:PULSEWidth:POLarity	186
	:SEARCH:TRIGger:RUNT:POLarity.....	186
	:SEARCH:TRIGger:RISEFall:SLOP	187
	:SEARCH:TRIGger:PULSe:WHEn.....	187
	:SEARCH:TRIGger:PULSe:TIME.....	188
	:SEARCH:TRIGger:RUNT:WHEn	188
	:SEARCH:TRIGger:RUNT:TIME	189
	:SEARCH:TRIGger:RISEFall:WHEn	189
	:SEARCH:TRIGger:RISEFall:TIME	190
	:SEARCH:TRIGger:BUS:TYPe.....	190
	:SEARCH:TRIGger:BUS:B1:I2C:CONDition	191

:SEARCH:TRIGger:BUS:B1:I2C:ADDRes:MODE	191
:SEARCH:TRIGger:BUS:B1:I2C:ADDRes:TYPe	192
:SEARCH:TRIGger:BUS:B1:I2C:ADDRes:VALue	193
:SEARCH:TRIGger:BUS:B1:I2C:ADDRes:DIRectio	193
:SEARCH:TRIGger:BUS:B1:I2C:DATA:SIZE.....	194
:SEARCH:TRIGger:BUS:B1:I2C:DATA:VALue.....	194
:SEARCH:TRIGger:BUS:B1:UART:CONDitio.....	195
:SEARCH:TRIGger:BUS:B1:UART:RX:DATA:SIZE	196
:SEARCH:TRIGger:BUS:B1:UART:RX:DATA:VALue ..	197
:SEARCH:TRIGger:BUS:B1:UART:TX:DATA:SIZE	197
:SEARCH:TRIGger:BUS:B1:UART:TX:DATA:VALue ..	198
:SEARCH:TRIGger:BUS:B1:CAN:CONDitio	199
:SEARCH:TRIGger:BUS:B1:CAN:FRAMEType	200
:SEARCH:TRIGger:BUS:B1:CAN:IDentifier:MODE ..	200
:SEARCH:TRIGger:BUS:B1:CAN:IDentifier:VALue ...	201
:SEARCH:TRIGger:BUS:B1:CAN:IDentifier:DIRectio	201
:SEARCH:TRIGger:BUS:B1:CAN:DATA:QUALifier....	202
:SEARCH:TRIGger:BUS:B1:CAN:DATA:SIZE	203
:SEARCH:TRIGger:BUS:B1:CAN:DATA:VALue	203
:SEARCH:TRIGger:BUS:B1:LIN:CONDitio	204
:SEARCH:TRIGger:BUS:B1:LIN:DATA:QUALifier	205
:SEARCH:TRIGger:BUS:B1:LIN:DATA:SIZE	206
:SEARCH:TRIGger:BUS:B1:LIN:DATA:VALue	206
:SEARCH:TRIGger:BUS:B1:LIN:ERRTYPE	207
:SEARCH:TRIGger:BUS:B1:LIN:IDentifier:VALue....	208
:SEARCH:FFTPeak:METHod	208
:SEARCH:FFTPeak:METHod:MPEak.....	209
:SEARCH:FFTPeak:SINFo.....	210
:SEARCH:FFTPeak:LIST.....	210

Label Commands :CHANnel<X>:LABel.....	211
:CHANnel<X>:LABel:DISPlay	212
:REF<X>:LABel	212
:REF<X>:LABel:DISPlay	213
:BUS1:Label	214

	:BUS1:LABel:DISPlay	214
	:SET<X>:LABel	215
<hr/>		
Segment	:SEGMENTS:STATE	217
Commands	:SEGMENTS:CURRENT.....	218
	:SEGMENTS:TOTALNUM	218
	:SEGMENTS:TIME	219
	:SEGMENTS:DISPALL	219
	:SEGMENTS:MEASURE:MODE	219
	:SEGMENTS:MEASURE:PLOT:SOURCce	220
	:SEGMENTS:MEASURE:PLOT:DIVide	220
	:SEGMENTS:MEASURE:PLOT:SElect	221
	:SEGMENTS:MEASURE:PLOT:RESults	221
	:SEGMENTS:MEASURE:TABLE:SOURCce	222
	:SEGMENTS:MEASURE:TABLE:SElect.....	222
	:SEGMENTS:MEASURE:TABLE:LIST	223
	:SEGMENTS:MEASURE:TABLE:SAVe	223
	:SEGMENTS:SAVe	224
	:SEGMENTS:SAVe:SOURCce	224
	:SEGMENTS:SAVe:SElect:START	224
	:SEGMENTS:SAVe:SElect:END	225
<hr/>		
DVM Commands	:DVM:STATE	226
	:DVM:SOURCce	226
	:DVM:MODE.....	227
	:DVM:VALue	227
<hr/>		
Go-NoGo	:GONogo:CLEar.....	228
Commands	:GONogo:EXECute	228
	:GONogo:FUNCTION.....	229
	:GONogo:NGCount	229
	:GONogo:NGDefine.....	229
	:GONogo:SOURCce	230
	:GONogo:VIOLation	230
	:GONogo:SCRipt	230

	:TEMPlate:MODE	231
	:TEMPlate:MAXimum	231
	:TEMPlate:MINimum	231
	:TEMPlate:POSition:MAXimum	232
	:TEMPlate:POSition:MINimum	232
	:TEMPlate:SAVe:MAXimum	232
	:TEMPlate:SAVe:MINimum	233
	:TEMPlate:TOLerance.....	233
	:TEMPlate:SAVe:AUTo.....	233
<hr/>		
AWG Commands	:AWG:UTIL.....	235
	:AWG:UTIL:AMPCpl	235
	:AWG:UTIL:FREQCpl	236
	:AWG:UTIL:FREQCpl:OFFSet	236
	:AWG:UTIL:FREQCpl:RATio	237
	:AWG:UTIL:TRACking.....	237
	:AWG<x>:AMPlitude.....	237
	:AWG<x>:FREQuency	238
	:AWG<x>:FUNCTion	238
	:AWG<x>:OFFSet.....	239
	:AWG<x>:OUTPut:LOAd:IMPEDance.....	239
	:AWG<x>:OUTPut:STATE.....	239
	:AWG<x>:PHAsE.....	240
	:AWG<x>:PULSe:DUTYcycle	240
	:AWG<x>:RAMP:SYMmetry	240
	:AWG<x>:MODulation:STATE	241
	:AWG<x>:MODulation:TYPE.....	241
	:AWG<x>:MODulation:AM:DEPth	241
	:AWG<x>:MODulation:AM:FREQ	242
	:AWG<x>:MODulation:AM:SHApe.....	242
	:AWG<x>:MODulation:AM:PHAsE	242
	:AWG<x>:MODulation:AM:DUTYcycle.....	243
	:AWG<x>:MODulation:AM:SYMmetry	243
	:AWG<x>:MODulation:AM:RATE	243
	:AWG<x>:MODulation:FM:DEV	244

	:AWG<x>:MODulation:FM:FREQ	244
	:AWG<x>:MODulation:FM:SHApe	245
	:AWG<x>:MODulation:FM:PHAsE	245
	:AWG<x>:MODulation:FM:DUTYcycle.....	246
	:AWG<x>:MODulation:FM:SYMmetry	246
	:AWG<x>:MODulation:FM:RATE.....	246
	:AWG<x>:MODulation:FSK:FREQ	247
	:AWG<x>:MODulation:FSK:RATE.....	247
	:AWG<x>:SWEep:STATE	248
	:AWG<x>:SWEep:TYPe	248
	:AWG<x>:SWEep:START	248
	:AWG<x>:SWEep:STOP	249
	:AWG<x>:SWEep:TIME.....	249
	:AWG<x>:SWEep:SPAN	249
	:AWG<x>:SWEep:CENTer	250
	:AWG<x>:ARBitrary:EDIT:NUMPoint	250
	:AWG<x>:ARBitrary:EDIT:FUNcTION	250
	:AWG<x>:ARBitrary:SAVe:WAVEform.....	251
	:AWG<x>:ARBitrary:LOAd:WAVEform	251
	:AWG<x>:ARBitrary:EDIT:COpy	252
	:AWG<x>:ARBitrary:EDIT:CLear	252
	:AWG<x>:ARBitrary:EDIT:LINE	253
	:AWG<x>:ARBitrary:EDIT:SCALE	253
	:AWG<x>:ARBitrary:EDIT:POINt.....	254
	:AWG<x>:ARBitrary:EDIT:POINt:ADD.....	254
	:AWG<x>:ARBitrary:EDIT:POINt:DELEte	254
Data Logging	:DATALOG:STATE	255
Commands	:DATALOG:SOURce	255
	:DATALOG:SAVe	256
	:DATALOG:INTErval.....	256
	:DATALOG:DURation.....	257

Remote Disk	:REMOTEDisk:IPADdress	258
Commands	:REMOTEDisk:PATHName	258
	:REMOTEDisk:USERName	259
	:REMOTEDisk:PASSWord	259
	:REMOTEDisk:MOUNT.....	259
	:REMOTEDisk:AUTOMount.....	260

Spectrum	:SA:STATE	262
Analyzer	:SA:LIST.....	262
Commands	:SA:MEMory.....	262
	:SA:MEMory:SOURce	264
	:SA:SOURce	265
	:SA<x>:SPECTRUMTrace.....	265
	:SA<x>:NORMal	266
	:SA<x>:MAXHold	266
	:SA<x>:MINHold	266
	:SA<x>:AVERage	267
	:SA<x>:AVERage:NUMAVg	267
	:SA<x>:DETECTIonmethod:MODE	268
	:SA<x>:DETECTIonmethod:MAXHold	268
	:SA<x>:DETECTIonmethod:MINHold	269
	:SA<x>:DETECTIonmethod:NORMal.....	269
	:SA<x>:DETECTIonmethod:AVERage	270
	:SA<x>:FREQuency	270
	:SA<x>:SPAN	271
	:SA<x>:START	271
	:SA<x>:STOP.....	271
	:SA<x>:RBW:MODE.....	272
	:SA<x>:RBW	272
	:SA<x>:SPANRbwratio	273
	:SA<x>:WINDow	273
	:SA<x>:UNIts	274
	:SA<x>:SCALE	274
	:SA:POSition	275
	:SA<x>:INPut	275

	:SA:SPECTRogram:NUMSLICES?	276
	:SA<x>:SPECTRogram:SLICESElect	276
	:SA<x>:SPECTRogram:SLICETIME?	276
	:SA:SPECTRogram:STATe	277

USB Delay Command	:USBDelay	278
-------------------	-----------------	-----

FRA Commands	:FRA:RUN.....	279
	:FRA:STOP	280
	:FRA:SOURce:INPut	280
	:FRA:SOURce:OUTPut	280
	:FRA:FREQuency:START	280
	:FRA:FREQuency:STOP	281
	:FRA:AWG:LOAD.....	281
	:FRA:AWG:AMPlitude.....	282
	:FRA:POINt	283
	:FRA:SAVe	283
	:FRA:RECALL.....	283
	:FRA:DATA	283
	:FRA:SAVETOCsv.....	284
	:FRA:AWG:AMPlitude:PROFile	284
	:FRA:AWG:AMPlitude:INTERPolation	284
	:FRA:DATA:GMARgin.....	285
	:FRA:DATA:GMARgin:FREQuency	285
	:FRA:DATA:PMARgin	285
	:FRA:DATA:PMARgin:FREQuency	286
	:FRA:STATe	286

Power supply Commands	:POWERSupply:OUTPut<X>	287
	:POWERSupply:OUTPut<X>:VOLTage	287
	:POWERSupply:OUTPut<X>:RECONFigure.....	288
	:POWERSupply:OUTPut<X>:OCP	288
	:POWERSupply:OUTPut<X>:CONFigure	288

Python	:PYDEcode:TYPe	289
Commands	:PYDEcode:CANFD:SOURce	290
	:PYDEcode:CANFD:PROBe	290
	:PYDEcode:CANFD:SAMPLEpoint.....	290
	:PYDEcode:CANFD:BITRate.....	291
	:PYDEcode:CANFD:FASTBITRate	291
	:PYDEcode:FLEXRay:SOURce	291
	:PYDEcode:FLEXRay:BDIFF.....	292
	:PYDEcode:FLEXRay:CHTYPe	292
	:PYDEcode:FLEXRay:BITRate	292
	:PYDEcode:USBPD:SOURce	293
	:PYDEcode:USBPACKET:SIGnal	293
	:PYDEcode:USBPACKET:DPlus.....	293
	:PYDEcode:USBPACKET:DMinus	294
	:PYDEcode:I2S:SCK	294
	:PYDEcode:I2S:WS.....	294
:PYDEcode:I2S:SD	295	

C COMMAND DETAILS

The Command details chapter shows the detailed syntax, equivalent panel operation, and example for each command. For the list of all commands, see page 16.

Common Commands	34
Acquisition Commands	40
Autoscale Commands	48
Vertical Commands	49
Math Commands	55
Cursor Commands	64
Display Commands	75
Hardcopy Commands.....	79
Measure Commands	82
Measurement Commands	108
Reference Commands	116
Run Command	119
Stop Command	120
Single Command.....	121
Force Command.....	122
Timebase Commands.....	123
Trigger Commands.....	126
System Commands	160
Save/Recall Commands.....	161
Ethernet Command	166
Time Command	167
Bus Decode Commands	168
Mark Commands.....	179
Search Commands	181

Label Commands	211
Segment Commands	217
DVM Commands	226
Go_NoGo Commands	228
AWG Commands	234
Data Logging Commands	255
Remote Disk Commands	258
Spectrum Analyzer Commands	261
USB Delay Command	278
FRA Commands	279
Power Supply Commands	287
Python Commands	289

Common Commands

*IDN?	34
*LRN?	34
*SAV	35
*RCL	35
*RST	35
*CLS	36
*ESE	36
*ESR	36
*OPC	37
*SRE	37
*STB	38

*IDN?

→ Query

Description	Returns the manufacturer, model, serial number and version number of the unit.
Syntax	*IDN?
Example	*IDN? GW,MPO-2102B,PXXXXXX,V1.XX

*LRN?

→ Query

Description	Returns the oscilloscope settings as a data string.
Syntax	*LRN?
Example	*LRN? :DISPlay:WAVEform VECTOR;PERSistence 2.400E-01; INTensity:WAVEform 50;INTensity:GRATicule 50;GRATicule FULL;:CHANnel CH1:DISPlay ON;BWLimit FULL;COUPling DC;INVert OFF;POSition -1.600E+00;PROBe:RATio

1.000e+01;PROBe:TYPe VOLTAGE;SCALe 2.000E+01;IMPedance 1E+6;EXPand GROUND;;CHANnel CH2:DISPlay ON;BWLimit FULL;COUPling DC;INVert OFF;POSition 0.000E+00;PROBe:RATio 1.000e+01;PROBe:TYPe VOLTAGE;SCALe 2.000E+00;IMPedance 1E+6;EXPand GROUND;MATH:TYPe FFT;DISP OFF;DUAL:SOURce1 CH1;SOURce2 CH2;OPERator MUL;POSition 0.000E+00;SCALe ?;FFT:SOURce CH1;MAG DB;WINDow HANNING;POSition 2.800E-01;SCALe 2.000E+01;MATH:ADVanced:OPERator DIFF;ADVanced:SOURce CH1;ADVanced:EDIT: SOURce1 CH1;ADVanced:EDIT:S

***SAV**

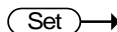

Description Saves the current panel settings to the selected memory number (setup 1 ~ 20).

Syntax *SAV {1 | 2 | 3 |... | 20}

Example *SAV 1
Saves the current panel settings to Set 1.

***RCL**



Description Recalls a set of panel settings.

Syntax *RCL {1 | 2 | 3 |... | 20}

Example *RCL 1
Recalls the selected setup from Set 1.

***RST**



Description Resets the MPO-2000 (recalls the default panel settings).

Syntax *RST

***CLS**

Set →

Description Clears the error queue.

Syntax *CLS

***ESE**

Set →

→ Query

Description Sets or queries the Standard Event Status Enable register.

Syntax *ESE <NR1>

Query Syntax *ESE?

Return parameter <NR1> 0~255

Bit Weight	Bit#	Weight	Event	Description
	0	1	OPC	Operation Complete Bit
	1	2	RQC	Not used
	2	4	QYE	Query Error
	3	8	DDE	Device Error
	4	16	EXE	Execution Error
	5	32	CME	Command Error
	6	64	URQ	User Request
	7	128	PON	Power On

Example *ESE?

>4

Indicates that there is a query error.

***ESR**

→ Query

Description Queries the Standard Event Status (Event) register. The Event Status register is cleared after it is read.

Query Syntax *ESR?

Return parameter <NR1> 0~255

Bit Weight	Bit#	Weight	Event	Description
	0	1	OPC	Operation Complete Bit
	1	2	RQC	Not used
	2	4	QYE	Query Error
	3	8	DDE	Device Error
	4	16	EXE	Execution Error
	5	32	CME	Command Error
	6	64	URQ	User Request
	7	128	PON	Power On

Example *ESR?
>4
Indicates that there is a query error.

Set →

*OPC

→ Query

Description The *OPC command sets the OPC bit (bit0) of the Standard Event Status Register when all current commands have been processed.

The *OPC? Query returns 1 when all the outstanding commands have completed.

Syntax *OPC

Query Syntax *OPC?

Return parameter 1 Returns 1 when all the outstanding commands have completed.

Set →

*SRE

→ Query

Description Sets or queries the Service Request Enable register. The Service Request Enable register determines which registers of the Status Byte register are able to generate service requests.

Syntax	*SRE <NR1>
Query Syntax	*SRE?

Parameter/ Return parameter	<NR1> 0~255
--------------------------------	-------------

Bit Weight	Bit#	Weight	Event	Description
	0	1		Not used
	1	2		Not used
	2	4		Not used
	3	8		Not used
	4	16	MAV	Message Available Bit
	5	32	ESB	Event Status Bit
	6	64	MSS	Master Summary Bit
	6	64	RQS	Request Service Bit
	7	128		Not used

Example *SRE?
 >48
 Indicates that the MAVB and ESB bit are both set.

***STB** → Query

Description Queries the bit sum of the Status Byte register with MSS (Master summary Status) replacing the RQS bit (bit 6).

Query Syntax *STB?

Return parameter <NR1> 0 ~ 255

Bit Weight	Bit#	Weight	Event	Description
	0	1		Not used
	1	2		Not used
	2	4		Not used
	3	8		Not used

4	16	MAV	Message Available Bit
5	32	ESB	Event Status Bit
6	64	MSS	Master Summary Bit
6	64	RQS	Request Service Bit
7	128		Not used

Example

*STB?

>16

Indicates that the MAV bit is set.

Acquisition Commands

:ACQuire:AVERage	40
:ACQuire:MODE	41
:ACQuire<X>:MEMory?	41
:ACQuire:FILTer:SOURce	43
:ACQuire:FILTer	44
:ACQuire:FILTer:FREQuency.....	44
:ACQuire:FILTer:FREQuency:UPPER	44
:ACQuire:FILTer:FREQuency:LOWER	45
:ACQuire:FILTer:TYPe	45
:ACQuire:FILTer:TRACking.....	46
:ACQuire<X>:STATe?	46
:ACQuire:INTERpolation	46
:ACQuire:RECOrdlength.....	47
:HEADer	47

:ACQuire:AVERage

Set →

→ Query

Description	Selects or returns the number of waveform acquisitions that are averaged in the average acquisition mode.
Syntax	:ACQuire:AVERage {<NR1> ?}
Related Commands	:ACQuire:MODE
Parameter	<NR1> 2, 4, 8, 16, 32, 64, 128, 256
Note	Before using this command, select the average acquisition mode. See the example below.
Example	:ACQuire:MODE AVERage :ACQuire:AVERage 2 Selects the average acquisition mode, and sets the average number to 2.

Set →
 → Query

:ACquire:MODE

Description	Selects or returns the acquisition mode.						
Syntax	:ACquire:MODE {SAMPlE PDETECT AVERAge ?}						
Related Commands	:ACquire:AVERage						
Parameter	<table style="width: 100%; border-collapse: collapse;"> <tr> <td style="width: 15%; background-color: #e0e0e0;">SAMPlE</td> <td>Sample mode sampling</td> </tr> <tr> <td style="background-color: #e0e0e0;">PDETECT</td> <td>Peak detect sampling</td> </tr> <tr> <td style="background-color: #e0e0e0;">AVERAge</td> <td>Average sampling mode</td> </tr> </table>	SAMPlE	Sample mode sampling	PDETECT	Peak detect sampling	AVERAge	Average sampling mode
SAMPlE	Sample mode sampling						
PDETECT	Peak detect sampling						
AVERAge	Average sampling mode						
Example	:ACquire:MODE PDETECT Sets the sampling mode to peak detection.						

→ Query

:ACquire<X>:MEMory?

Description	Returns the data in acquisition memory for the selected channel as a header + raw data.				
Syntax	:ACquire<X>:MEMory?				
Related Commands	:ACquire:RECOrdlength :HEADer				
Parameter	<X> Channel number (1 to 4)				
Return parameter	<table style="width: 100%; border-collapse: collapse;"> <tr> <td style="width: 15%; background-color: #e0e0e0;"><string></td> <td>Returns acquisition settings followed by raw waveform block data.</td> </tr> <tr> <td style="background-color: #e0e0e0;"><waveform block data></td> <td> <string> Returns the acquisition settings for the selected channel. Format: parameter(1),setting(1);parameter(2),setting(2)...parameter(n),setting(n);Waveform Data; <waveform block data> Header followed by the raw waveform data. </td> </tr> </table>	<string>	Returns acquisition settings followed by raw waveform block data.	<waveform block data>	<string> Returns the acquisition settings for the selected channel. Format: parameter(1),setting(1);parameter(2),setting(2)...parameter(n),setting(n);Waveform Data; <waveform block data> Header followed by the raw waveform data.
<string>	Returns acquisition settings followed by raw waveform block data.				
<waveform block data>	<string> Returns the acquisition settings for the selected channel. Format: parameter(1),setting(1);parameter(2),setting(2)...parameter(n),setting(n);Waveform Data; <waveform block data> Header followed by the raw waveform data.				

Format:

Header: The header (in ASCII) encodes the number of bytes for the header followed by the number of data points in bytes for the raw data.

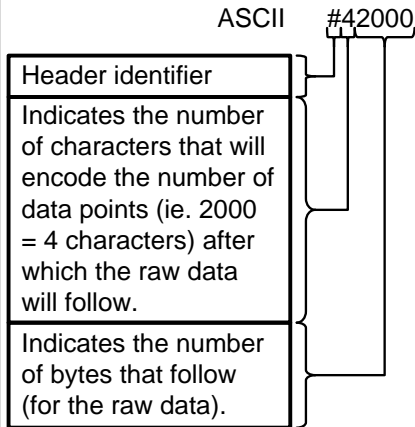

Raw Data:

Each two bytes (in hex) encodes the vertical data of a data point. The data is signed hex data (2's complement, -32768 ~ 32767).

Waveform Raw Data Example:

Header raw data.....

Hex:

23 34 32 30 30 30 00 1C 00 1B 00 1A 00
1A 00 1B

ASCII/Decimal:

#42000 28 27 26 26 27.....

The actual value of a data point can be calculated with the following formula:
(Decimal value of hex data/ AD Factor) * vertical scale.

Note: AD Factor is fixed as 25. The vertical scale is returned with the

acquisition settings that precede the raw data.

For example if the raw data for a point is 001C (=28 decimal) then,
 $(28/25) \times 0.5 = 0.56V$

Example :ACQuire1:MEMory?
 Format,2.0E;Memory Length,10000;IntpDistance,0;
 Trigger Address,4999;Trigger Level,1.160E+01;
 Source,CH1;Vertical Units,V;Vertical Units
 Div,0;Vertical Units Extend
 Div,15;Label,ACK ;Probe Type,0;Probe
 Ratio,1.000e+01;Vertical Scale,5.000e+00;Vertical
 Position,-1.100e+01;Horizontal Units,S;Horizontal
 Scale,5.000E-04;Horizontal Position,0.000E+00;
 Horizontal Mode,Main;SincET Mode,Real
 Time;Sampling Period,5.000e-07;Horizontal Old
 Scale,5.000E-04;Horizontal Old Position,0.000E+00;
 Firmware,V0.99b8;Time,02-Oct-14 17:00:43;
 Waveform Data;
 #520000.....follows waveform block
 data in hex.....

Set →

→ Query

:ACQuire:FILTer:SOURce

Description	Returns the source of the filter.
Syntax	:ACQuire:FILTer:SOURce {CH1 CH2 ?}
Parameter/ Return parameter	CH1 ~ CH2 Source channel

Example :ACQuire:FILTer:SOURce?
 CH1
 Sets the filter source to CH1.

Set →
 → Query

:ACQuire:FILTer

Description	Turns the filter on/off or queries its status.	
Syntax	:ACQuire:FILTer {ON OFF ?}	
Parameter/ Return parameter	ON	Filter on.
	OFF	Filter off.
Example	:ACQuire:FILTer? OFF Indicates that the filter is turned off.	

Set →
 → Query

:ACQuire:FILTer:FREQuency

Description	Sets or queries the filter frequency.	
Syntax	:ACQuire:FILTer:FREQuency {DEFault <NRf> ?}	
Parameter/ Return parameter	DEFault	Sets the filter frequency to the default.
	<NRf>	Manually sets the filter frequency. (1Hz ~ 500MHz)
Example	:ACQuire:FILTer:FREQuency 1 Sets the filter frequency to 1Hz.	

Set →
 → Query

:ACQuire:FILTer:FREQuency:UPPER

Description	Sets or returns the filter upper frequency.	
Syntax	:ACQuire:FILTer:FREQuency:UPPER {DEFault} :ACQuire:FILTer:FREQuency:UPPER <NRf> :ACQuire:FILTer:FREQuency:UPPER?	
Parameter	DEFault	Sets the frequency to default.
	<NRf>	Sets the frequency to user.(Range:1Hz~500MHz)

Example :ACQuire:FILTer:FREQUency:UPPER 4.95e+07
 :ACQuire:FILTer:FREQUency:UPPER?
 4.950000e+07

Set →

→ Query

:ACQuire:FILTer:FREQUency:LOWER

Description Sets or returns the filter lower frequency.

Syntax :ACQuire:FILTer:FREQUency:LOWER {DEFAult}
 :ACQuire:FILTer:FREQUency:LOWER <NRf>
 :ACQuire:FILTer:FREQUency:LOWER?

Parameter	DEFAult	Sets the frequency to default.
	<NRf>	Sets the frequency to user. (Range:1Hz~500MHz)

Example :ACQuire:FILTer:FREQUency:LOWER 1.25e+07
 :ACQuire:FILTer:FREQUency:LOWER?
 1.250000e+07

Set →

→ Query

:ACQuire:FILTer:TYPE

Description Sets or returns the filter type.

Syntax :ACQuire:FILTer:TRACking {LOWPass | HIGHPass|
 BANDPass}
 :ACQuire:FILTer:TYPE?

Parameter	LOWPass	Lowpass Type.
	HIGHPass	Highpass Type.
	BANDPass	Bandpass Type.

Example :ACQuire:FILTer:TYPE?
 >LOWPass
 Returns low pass type as present filter type

Set →
 → Query

:ACQUIRE:FILTER:TRACKing

Description	Turns filter tracking on/off or queries its state.	
Syntax	:ACQUIRE:FILTER:TRACKing {ON OFF ?}	
Parameter/ Return parameter	OFF	Tracking off
	ON	Tracking on
Example	:ACQUIRE:FILTER:TRACKing ON Turns filter tracking on.	

→ Query

:ACQUIRE<X>:STATE?

Description	Returns the status of waveform data.	
Syntax	:ACQUIRE<X>:STATE?	
Parameter	<X>	Channel number (1 to 4)
Return parameter	0	Raw data is not ready
	1	Raw data is ready
Example	:ACQUIRE1:STATE? 0 Returns 0. Channel 1's raw data is not ready.	



Note

If the oscilloscope changes the acquisition status from STOP to RUN, the status will be reset as zero.

Set →
 → Query

:ACQUIRE:INTERpolation

Description	Selects or returns the interpolation mode.	
Syntax	:ACQUIRE:INTERpolation {ET SINC ?}	
Parameter/Return parameter	ET	Equivalent Time interpolation. The MPO-2000 doesn't support ET.
	SINC	Sets to SIN(X)/X interpolation

Example :ACQuire:INTERpolation?
>SINC
Returns SINC as the interpolation mode.

:ACQuire:RECOrdlength

Set →

→ Query

Description Sets or queries the record length.

Syntax :ACQuire:RECOrdlength {<Nrf>| ?}

Parameter/Return parameter <NRF> Record length. Settable record length: (1e+3 | 1e+4 | 1e+5 | 1e+6 | 1e+7)

Example :ACQuire:RECOrdlength 1e+3
Sets the record length to 1000 points.

Set →

:HEADer

→ Query

Description Configures whether the returned data of the :ACQuire:MEM query will contain header information or not. It is set to ON by default.

Syntax :HEADer {OFF | ON | ?}

Related Commands :ACQuire<X>:MEMory?

Parameter ON Add header information.
OFF Don't add header information.

Return parameter Returns the configuration (ON, OFF) for the selected channel.

Example :HEADer ON

Autoscale Commands

:AUTOSet	48
:AUTORSET:MODE	48

:AUTOSet

Set →

Description Runs the Autoset function to automatically configure the horizontal scale, vertical scale, and trigger according to the input signal.

Syntax :AUTOSet

Set →

:AUTORSET:MODE

→ Query

Description Sets the Autoset mode or queries its state.

Syntax :AUTORSET:MODE {FITScreen | ACPriority | ?}

Related Commands :AUTOSet

Parameter/Return parameter	FITScreen	Fit Screen mode
	ACPriority	AC priority mode

Example :AUTORSET?
FITSCREEN

Vertical Commands

:CHANnel<X>:BWLimit	49
:CHANnel<X>:COUPling.....	50
:CHANnel<X>:DESKew	50
:CHANnel<X>:DISPlay	50
:CHANnel<X>:EXPanD	51
:CHANnel<X>:IMPedance?	51
:CHANnel<X>:INVert	52
:CHANnel<X>:POSition	52
:CHANnel<X>:PROBe:RATio	53
:CHANnel<X>:PROBe:TYPe	53
:CHANnel<X>:SCALE	54

:CHANnel<X>:BWLimit



Description	Sets or returns the bandwidth limit on/off.	
Syntax	:CHANnel<X>:BWLimit {FULL <NR3> ?}	
Parameter	<X>	Channel 1, 2
	FULL	Full bandwidth
	<NR3>	Sets the bandwidth limit to a pre-defined bandwidth.
		100E+6: 100MHz 20E+6: 20MHz
Return Parameter	<NR3>	Returns the bandwidth.
	Full	Full bandwidth
Example	:CHANnel1:BWLimit 2.000E+07 Sets the channel 1 bandwidth to 20MHz.	

Set →
 → Query

:CHANnel<X>:COUPling

Description	Selects or returns the coupling mode.		
Syntax	CHANnel<X>:COUPling {AC DC GND ?}		
Parameter	<X>	Channel	1, 2
	AC	AC coupling	
	DC	DC coupling	
	GND	Ground coupling	
Return parameter	Returns the coupling mode.		
Example	:CHANnel1:COUPling DC Sets the coupling to DC for Channel 1.		

Set →
 → Query

:CHANnel<X>:DESKew

Description	Sets the deskew time in seconds.		
Syntax	:CHANnel<X>:DESKew { <NR3> ?}		
Parameter	<X>	Channel	1, 2
	<NR3>	Deskew time:	-5.00E -11 to 5.00E-11 -50ns to 50 ns. (10 ps /step)
Return parameter	<NR3>	Returns the deskew time.	
Example	:CHANnel1:DESKew 1.300E-9 Sets the deskew time to 1.3 nano seconds.		

Set →
 → Query

:CHANnel<X>:DISPlay

Description	Turns a channel on/off or returns its status.		
Syntax	:CHANnel<X>:DISPlay {OFF ON ?}		
Parameter	<X>	Channel	1, 2
	OFF	Channel off	

	ON	Channel on
Return Parameter	ON	Channel is on
	OFF	Channel is off
Example	:CHANnel1:DISPlay ON Turns on Channel 1	

:CHANnel<X>:EXPand



Description	Sets Expand By Ground or Expand By Center for a channel or queries its status.	
Syntax	:CHANnel<X>:EXPand {GND CENTer ?}	
Parameter	<X>	Channel 1, 2
	GND	Ground
	CENTer	Center
Return parameter	GND	Expand By Ground
	CENTER	Expand By Center
Example	:CHANnel1:EXPand GND Sets Channel 1 to Expand By Ground.	

:CHANnel<X>:IMPedance?

Description	Returns the impedance of the oscilloscope. (The impedance of the MPO-2000 is fixed at 1M Ω)	
Syntax	:CHANnel<X>:IMPedance?	
Parameter	<x>	Channel
	1/2	CH1/2
Return parameter	<NR3>	Returns the impedance value.
Example	:CHANnel1:IMPedance? 1.000000E+06 The impedance is 1M ohms.	

Set →

→ Query

:CHANnel<X>:INVert

Description	Inverts a channel or returns its status.	
Syntax	:CHANnel<X>:INVert {OFF ON ?}	
Parameter	<X>	Channel 1, 2
	OFF	Invert off
	ON	Invert on
Return parameter	ON	Invert on
	OFF	Invert off
Example	:CHANnel1:INVert ON Inverts Channel 1	

Set →

→ Query

:CHANnel<X>:POSition

Description	Sets or returns the position level for a channel.	
Note	The vertical position will only be set to closest allowed value. The position level range depends on the vertical scale.	
	The scale must first be set before the position can be set.	
Syntax	:CHANnel<X>:POSition { <NRf> ?}	
Parameter	<X>	Channel 1, 2
	<NRf>	Position. Range depends on the vertical scale.
Return parameter	<NR3>	Returns the position value.
Example 1	:CHANnel1:POSition 2.4E-3 Sets the Channel 1 position to 2.4mV/mA	
Example 2	:CHANnel1:POSition? 2.4E-3 Returns 2.4mV as the vertical position.	

:CHANnel<X>:PROBe:RATio (Set) →
→ (Query)

Description	Sets or returns the probe attenuation factor.	
Syntax	:CHANnel<X>:PROBe:RATio { <NRf> ? }	
Related Commands	:CHANnel<X>:PROBe:TYPe	
Parameter	<X>	Channel 1, 2
	<NRf>	Probe attenuation factor
Return parameter	<NR3>	Returns the probe factor
Example	:CHANnel1:PROBe:RATio 1.00E+0 Sets the Channel 1 probe attenuation factor to 1x	

:CHANnel<X>:PROBe:TYPe (Set) →
→ (Query)

Description	Sets or returns the probe type (voltage/current).	
Syntax	:CHANnel<X>:PROBe:TYPe { VOLTage CURRent ? }	
Related Commands	:CHANnel<X>:PROBe:RATio	
Parameter	<X>	Channel 1, 2
	VOLTage	Voltage
	CURRent	Current
Return parameter	Returns the probe type.	
Example	:CHANnel1:PROBe:TYPe VOLTage Sets the Channel 1 probe type to voltage.	

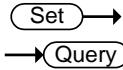

:CHANnel<X>:SCALE

Description	Sets or returns the vertical scale. The scale depends on the probe attenuation factor. Note the probe attenuation factor should be set before the scale.	
Syntax	:CHANnel<X>:SCALE { <NRf> ? }	
Parameter	<X>	Channel 1, 2
	<NRf>	Vertical scale: 2e-3 to 1e+1 2mV to 10V (Probe x1)
Return parameter	<NR3>	Returns the vertical scale in volts or amps.
Example	:CHANnel1:SCALE 2.00E-2 Sets the Channel 1 vertical scale to 20mV/div	

Math Commands

:MATH:DISP	55
:MATH:TYPe	56
:MATH:DUAL:SOURce<X>	56
:MATH:DUAL:OPERator	57
:MATH:DUAL:POSition	57
:MATH:DUAL:SCALe	57
:MATH:FFT:SOURce	58
:MATH:FFT:MAG	58
:MATH:FFT:WINDow	58
:MATH:FFT:POSition	59
:MATH:FFT:SCALe	59
:MATH:FFT:HORizontal:SCALe	60
:MATH:FFT:HORizontal:POSition	60
:MATH:DEFine	60
:MATHVAR?	61
:MATHVAR:VAR<X>	62
:MATH:ADVanced:POSition	62
:MATH:ADVanced:SCALe	63

:MATH:DISP

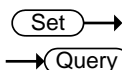

Description	Turns the math display on or off on the screen.	
Syntax	:MATH:DISP {OFF ON ?}	
Parameter/ Return parameter	OFF	Math is not displayed on screen
	ON	Math is displayed on screen
Example	:MATH:DISP OFF Math is off.	

Set →

→ Query

:MATH:TYPE

Description	Queries or sets the Math type to FFT, Advanced Math or to dual channel math operations	
Syntax	:MATH:TYPE { DUAL ADVanced FFT ? }	
Related Commands	:MATH:DISP	
Parameter	DUAL	Dual channel operations
	ADVanced	Advanced math operations
	FFT	FFT operations
Return parameter	Returns the math type.	
Example	:MATH:TYPE DUAL Sets the Math type to dual channel math operation.	

Set →

→ Query

:MATH:DUAL:SOURce<X>

Description	Sets the dual math source for source 1 or 2.	
Syntax	:MATH:DUAL:SOURce<X> { CH1 CH2 REF1 REF2 REF3 REF4 ? }	
Parameter	<X>	Source number 1 or 2
	CH1~2	Channel 1 to 2
	REF1~4	Reference waveforms 1 to 4
Return parameter	Returns the source for the source 1 or 2.	
Example	:MATH:DUAL:SOURce1 CH1 Sets source1 as channel 1.	

Set →
→ Query

:MATH:DUAL:OPERator

Description	Sets the math operator for dual math operations.	
Syntax	:MATH:DUAL:OPERator {PLUS MINUS MUL DIV ?}	
Parameter	PLUS	+ operator
	MINUS	- operator
	MUL	× operator
	DIV	÷ operator
Return parameter	Returns operator type.	
Example	:MATH:DUAL:OPERator PLUS Sets the math operator as plus (+).	

Set →
→ Query

:MATH:DUAL:POSition

Description	Sets the vertical position of the displayed math result expressed by unit/division.	
Syntax	:MATH:DUAL:POSition {<NRf> ? }	
Parameter	<NRf>	Vertical position Depends on the vertical scale (Unit/Div)
Return parameter	<NR3>	Returns the vertical position.
Example	:MATH:DUAL:POSition 1.0E+0 Sets the vertical position to 1.00 unit/div.	

Set →
→ Query

:MATH:DUAL:SCALE

Description	Sets the vertical scale of the displayed math result.	
Syntax	:MATH:DUAL:SCALE {<NRf> ? }	
Parameter	<NRf>	Vertical scale
Return parameter	<NR3>	Returns the scale.

Example :MATH:DUAL:SCALE 2.0E-3
 Sets the vertical scale to 2mV/2mA.

Set →

:MATH:FFT:SOURce

→ Query

Description	Sets and queries the FFT math source.	
Syntax	:MATH:FFT:SOURce { CH1 CH2 REF1 REF2 REF3 REF4 ? }	
Related commands	:MATH:ADVanced:EDIT:SOURce<X> :MATH:ADVanced:EDIT:OPERator	
Parameter	CH1~2	Channel 1 to 2
	REF1~4	Reference waveform 1 to 4
Return parameter	Returns the FFT source.	

Example :MATH:FFT:SOURce CH1
 Sets the FFT math source as channel 1.

Set →

:MATH:FFT:MAG

→ Query

Description	Sets FFT vertical units as linear or decibels.	
Syntax	:MATH:FFT:MAG {LINEAR DB ?}	
Parameter	LINEAR	Linear units (Vrms)
	DB	Logarithmic units (dB)
Return parameter	Returns the FFT vertical units.	

Example :MATH:FFT:MAG DB
 Sets FFT vertical units to dB.

Set →

:MATH:FFT:WINDow

→ Query

Description	Sets the windowing filter used for the FFT function.	
-------------	--	--

Syntax	:MATH:FFT:WINDow {RECTangular HAMming HANning BLAckman ?}	
Parameter	RECTangular	Rectangular window
	HAMming	Hamming window
	HANning	Hanning window
	BLAckman	Blackman window
Return parameter	Returns the FFT window.	
Example	:MATH:FFT:WINDow HAMming Sets the FFT window filter to hamming.	

:MATH:FFT:POSition

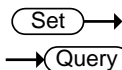

Description	Sets the vertical position of the displayed FFT result.	
Syntax	MATH:FFT:POSition { <NRf> ? }	
Parameter	<NRf>	Vertical position: -12e+0 to +12e+0 (12 units/division to +12 units/division.)
Return parameter	<NR3>	Returns the vertical position.
Example	:MATH:FFT:POSition -2e-1 Sets the FFT position to -0.2 divisions.	

:MATH:FFT:SCALE

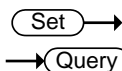

Description	Sets the vertical scale of the displayed FFT result.	
Syntax	:MATH:FFT:SCALE {<NRf> ?}	
Parameter	<NRf>	Vertical scale: Linear: 2e-3 to 1e+3 (2mV~1kV) dB: 1e+0 to 2e+1 (1~20dB)
Return parameter	<NR3>	Returns vertical scale.

Example :MATH:FFT:SCALE 1.0e+0
Sets the scale to 1dB.

:MATH:FFT:HORizontal:SCALE (Set) →
→ (Query)

Description	Sets or queries the zoom scale for FFT math.	
Syntax	:MATH:FFT:HORizontal:SCALE {<NRf> ?}	
Parameter	<NRf>	Zoom scale: 1 to 20 times
Return parameter	<NR3>	Returns zoom scale.
Example	:MATH:FFT:HORizontal:SCALE 5 Sets the zoom scale to 5X.	

:MATH:FFT:HORizontal:POSition (Set) →
→ (Query)

Description	Sets the horizontal position of the displayed FFT result.	
Syntax	MATH:FFT:HORizontal:POSition { <NRf> ? }	
Parameter	<NRf>	Horizontal position: 0Hz ~ 999.9kHz
Return parameter	<NR3>	Returns the vertical position.
Example	:MATH:FFT:HORizontal:POSition 6.0e5 Sets the FFT horizontal position to 600kHz.	

:MATH:DEFine (Set) →
→ (Query)

Description	Sets or queries the advanced math expression as a string.	
Syntax	:MATH:DEFine {<string> ?}	
Related	:MATH:DISP :MATH:TYPE	

Parameter	<string>	An expression enclosed in double quotes. Note that ensure parentheses are used correctly in the expression. The expression can contain the following parts:
	Source	CH1~CH2, Ref1~Ref4
	Function	Intg(, Diff(, log(, ln(, Exp(, Sqrt(, Abs(, Rad(, Deg(, sin(, cos(, tan(, asin(, acos(, atan(
	Variable	VAR1, VAR2
	Operator	+, -, *, /, (,), !(, <, >, <=, >=, ==, !=, , &&
	Figure	0, 1, 2, 3, 4, 5, 6, 7, 8, 9, .., E
	Measurement	Pk-Pk(, Max(, Min(, Amp(, High(, Low(, Mean(, CycleMean(, RMS(, CycleRMS(, Area(, CycleArea(, ROVShoot(, FOVShoot(, Freq(, Period(, Rise(, Fall(, PosWidth(, NegWidth(, Dutycycle(, FRR(, FRF(, FFR(, FFF(, LRR(, LRF(, LFR(, LFF(, Phase(

Return parameter Returns the expression as a string.

Example :MATH:DISP ON
 :MATH:TYPE ADVanced
 MATH:DEFine "CH1-CH2"
 Sets the math expression to CH1-CH2.

:MATHVAR? → Query

Description Returns the value of the VAR1 and VAR2 variables.

Syntax	MATHVAR?
Related Commands	MATHVAR:VAR<X> MATH:DEFine
Return parameter	<string> VAR1 <NR3>; VAR2 <NR3>
Example	MATHVAR? VAR1 1.000000E+06; VAR2 1.0E+1 Returns the value of both variables.

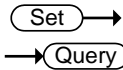

:MATHVAR:VAR<X>

Description	Sets or returns the VAR1 or VAR2 variables.
Syntax	MATHVAR:VAR<x> {<NRf> ?}
Related Commands	MATH:DEFine
Parameter	<X> 1, 2 (VAR1 or VAR2) <NRf> Value of VAR1/VAR2
Return parameter	<NR3> Returns the value of VAR1/VAR2
Example	:MATH:VAR1 6.0e4 Sets VAR1 to 60000.

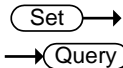

:MATH:ADVanced:POSition

Description	Sets the vertical position of the advanced math result, expressed in unit/div.
Syntax	MATH:ADVanced:POSition {<NRf> ?}
Parameter	<NRf> Vertical position: -12e+0 to +12e+0 (12 units/division to +12 units/division.)
Return parameter	<NR3> Returns the vertical position.
Example	:MATH:ADVanced:POSition 1.0e+0 Sets the position as 1.00 unit/div.

:MATH:ADVanced:SCALE

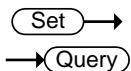

Description	Sets or queries the vertical scale the advanced math result.	
Syntax	:MATH:ADVanced:SCALE {<NRf> ?}	
Parameter	<NRf>	Vertical scale
Return parameter	<NR3>	Returns the vertical scale.
Example	:MATH:ADVanced:SCALE 2.0E-3 Sets the vertical scale to 2mV/Div.	

Cursor Commands

:CURSor:MODE	64
:CURSor:SOURce.....	65
:CURSor:HUNI	65
:CURSor:HUSE	66
:CURSor:VUNI	66
:CURSor:VUSE	67
:CURSor:DDT.....	67
:CURSor:H1Position.....	68
:CURSor:H2Position.....	68
:CURSor:HDELta	68
:CURSor:V1Position.....	69
:CURSor:V2Position.....	69
:CURSor:VDELta	69
:CURSor:XY:RECTangular:X:POSition<X>	70
:CURSor:XY:RECTangular:X:DELta	70
:CURSor:XY:RECTangular:Y:POSition<X>	70
:CURSor:XY:RECTangular:Y:DELta	71
:CURSor:XY:POLar:RADIUS:POSition<X>	71
:CURSor:XY:POLar:RADIUS:DELta	72
:CURSor:XY:POLar:THETA:POSition<X>	72
:CURSor:XY:POLar:THETA:DELta.....	72
:CURSor:XY:PRODuct:POSition<X>	73
:CURSor:XY:PRODuct:DELta	73
:CURSor:XY:RATio:POSition<X>.....	73
:CURSor:XY:RATio:DELta	74

:CURSor:MODE



Description Sets cursor mode to horizontal (H) or horizontal and vertical (HV).

 Note	When the cursor source is set to bus, then only the horizontal cursor is available.	
Syntax	:CURSor:MODE {OFF H HV ? }	
Parameter	OFF	Turns the cursors off.
	H	Turns the horizontal cursors on.
	HV	Turns horizontal and vertical cursors on.
Return parameter	Returns the state of the cursors (H, HV, OFF).	
Example	:CURSor:MODE OFF Turns the cursors off.	

:CURSor:SOURce
 →
 → 

Description	Sets or queries the cursor source.	
Syntax	:CURSor:SOURce {CH1 CH2 REF1 REF2 REF3 REF4 MATH LOGic BUS1 ? }	
Parameter	CH1~CH2	Channel 1 to 2
	REF1~4	Reference waveform 1 to 4
	MATH	Math source
	LOGic	Logic source
	BUS1	Bus source
Return parameter	Returns the cursor source.	
Example	:CURSor:SOURce CH1 Turns the cursor source as channel 1.	

:CURSor:HUNI
 →
 → 

Description	Sets or queries the units for the horizontal bar cursors.	
Syntax	:CURSor:HUNI {SECOnds HERTz DEGrees PERcent ? }	

Related Commands	:CURSor:MODE	
Parameter	SEConds	Sets the cursor units to time in seconds.
	HERtz	Sets the cursor units to frequency.
	DEGrees	Sets the cursor units to degrees.
	PERcent	Sets the cursor units to percent.
Return parameter	Returns the unit type.	
Example	:CURSor:HUNI SEConds Sets the units to time in seconds.	

:CURSor:HUSE



Description	Sets the current cursor position as the phase or ratio reference for the Percent or Degrees (horizontal) cursors.	
Note	This command can only be used when :CURSor:HUNI is set to DEGrees or PERcent.	
Syntax	:CURSor:HUSE {CURRent}	
Related Commands	:CURSor:MODE :CURSor:HUNI	
Parameter	CURRent	Uses the current horizontal position
Example	:CURSor:HUSE CURRent.	

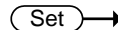

:CURSor:VUNI

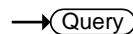

Description	Sets or queries the units for the vertical bar cursors.	
Syntax	:CURSor:VUNI {BASE PERcent ?}	
Related Commands	:CURSor:MODE	
Parameter	BASE	Sets the vertical cursor units the same as the scope units (V or A).

	PERcent	Sets the displayed units to percent.
Return parameter	Returns the unit type.	
Example	:CURSor:VUNI BASE Sets the units to the base units.	

:CURSor:VUSE



Description	Sets the current cursor position as the ratio reference for the Percent (vertical) cursors.	
Note	This command can only be used when :CURSor:VUNI is set to PERcent.	
Syntax	:CURSor:VUSE {CURRent}	
Related Commands	:CURSor:MODe :CURSor:VUNI	
Parameter	CURRent	Uses the current vertical position
Example	:CURSor:VUSE CURRent.	

:CURSor:DDT



Description	Returns the deltaY/deltaT (dy/dT) readout. This function is only supported if the source channels are CH1~4, Ref1~4 or Math.	
Syntax	:CURSor:DDT{?}	
Related Commands	:CURSor:MODe	
Return Parameter	<NR3>	Returns the readout in <NR3> format.
Example	:CURSor:DDT? 4.00E-05	

:CURSor:H1Position (Set) →
→ (Query)

Description Sets or returns the first horizontal cursor (H1) position.

Syntax :CURSor:H1Position {<NRf> | ?}

Related Commands :CURSor:H2Position

Parameter <NRf> Horizontal position

Return parameter Returns the cursor position.

Example :CURSor:H1Position?
-1.34E-3
Returns the H1 cursor position as -1.34ms.

:CURSor:H2Position (Set) →
→ (Query)

Description Sets or returns the second horizontal cursor (H2) position.

Syntax :CURSor:H2Position {<NRf> | ?}

Related Commands :CURSor:H1Position

Parameter <NRf> Horizontal Position

Return parameter Returns the cursor position.

Example :CURSor:H2Position 1.5E-3
Sets the H2 cursor position to 1.5ms.

:CURSor:HDELta → (Query)

Description Returns the delta of H1 and H2.

Syntax :CURSor:HDELta{?}

Return Parameter <NR3> Returns the distance between two horizontal cursors.

Example :CURSor:HDELta?
5.0E-9
Returns the horizontal delta as 5ns.

Set →

→ Query

:CURSor:V1Position

Description Sets the first vertical cursor (V1) position.

Syntax :CURSor:V1Position {<NRf>| ?}

Parameter <NRf> Vertical position. Depends on the vertical scale.

Return parameter <NR3> Returns the cursor position.

Example :CURSor:V1Position 1.6E -1
Sets the V1 cursor position to 160mA.

Set →

→ Query

:CURSor:V2Position

Description Sets the first vertical cursor (V2) position.

Syntax :CURSor:V2Position {<NRf> | ?}

Parameter <NRf> Vertical position. Depends on the vertical scale.

Return parameter <NR3> Returns the cursor position.

Example :CURSor:V2Position 1.1E-1
Sets the V2 cursor position to 110mA.

:CURSor:VDELta

→ Query

Description Returns the delta of V1 and V2.

Syntax :CURSor:VDELta{?}

Return Parameter <NR3> Returns the difference between two vertical cursors.

Example :CURSor:VDELta?
 4.00E+0
 Returns the vertical delta as 4 volts.

:CURSor:XY:RECTangular:X:POSition<X>  

Description Sets or queries the horizontal position in XY mode for the X rectangular coordinates for cursor 1 or 2.

Syntax :CURSor:XY:RECTangular:X:POSition<X> {<NRf>|?}

Parameter	<X>	Cursor 1, 2
	<NRf>	Horizontal position co-ordinates

Return parameter <NR3> Returns the cursor position.

Example :CURSor:XY:RECTangular:X:POSition1 4.0E-3
 Sets the X-coordinate cursor 1 position to 40mV/mV.

:CURSor:XY:RECTangular:X:DELta 

Description Returns the delta value of cursor 1 and 2 on the X coordinate.

Syntax :CURSor:XY:RECTangular:X:DELta{?}

Return Parameter	<NR3>	Returns the delta value of cursor 1 and 2 as <NR3>.
------------------	-------	---

Example :CURSor:XY:RECTangular:X:DELta?
 80.0E-3
 Returns the horizontal delta as 80mV.

:CURSor:XY:RECTangular:Y:POSition<X>  

Description Sets or queries the vertical position in XY mode for the Y rectangular coordinates for cursor 1 or 2.

Syntax :CURSor:XY:RECTangular:Y:POSition<X> {<NRf>|?}

Parameter	<X>	Cursor 1, 2
	<NRf>	Vertical position co-ordinates
Return parameter	<NR3>	Returns the cursor position.
Example	:CURSor:XY:RECTangular:Y:POSition1 4.0E-3 Sets the Y-coordinate cursor 1 position to 40mV/mV.	

:CURSor:XY:RECTangular:Y:DELta → Query

Description	Returns the delta value of cursor 1 and 2 on the Y coordinate.	
Syntax	:CURSor:XY:RECTangular:Y:DELta{?}	
Return Parameter	<NR3>	Returns the delta value of cursor 1 and 2 as <NR3>.
Example	:CURSor:XY:RECTangular:Y:DELta? 80.0E-3 Returns the horizontal delta as 80mV.	

:CURSor:XY:POLar:RADIUS:POSition<X> → Query

Description	Queries the polar radius position for the specified cursor in XY mode, where X can be either cursor 1 or 2.	
Syntax	:CURSor:XY:POLar:RADIUS:POSition<X>{?}	
Parameter	<X>	1, 2 (cursor 1, cursor 2)
Return Parameter	<NR3>	Returns the polar radius position.
Example	:CURSor:XY:POLar:RADIUS:POSition1? 80.0E-3 Returns the polar radius position as 80.0mV.	

:CURSor:XY:POLar:RADIUS:DELta → (Query)

Description	Returns the radius delta value of cursor 1 and 2.
Syntax	:CURSor:XY:POLar:RADIUS:DELta{?}
Return Parameter	<NR3> Returns the radius delta.
Example	:CURSor:XY:POLar:RADIUS:DELta? 31.4E-3 Returns the radius delta as 31.4mV.

:CURSor:XY:POLar:THETA:POSItion<X> → (Query)

Description	Queries the polar angle for the specified cursor in XY mode, where X can be either 1 or 2.
Syntax	:CURSor:XY:POLar:THETA:POSItion<X>{?}
Parameter	<X> 1, 2 (Cursor 1, Cursor 2)
Return parameter	<NR3> Returns the polar angle.
Example	:CURSor:XY:POLar:RADIUS:POSItion1? 8.91E+1 Returns the polar angle for cursor1 as 89.1°.

:CURSor:XY:POLar:THETA:DELta → (Query)

Description	Queries the polar angle delta between cursor1 and cursor2.
Syntax	:CURSor:XY:POLar:THETA:DELta{?}
Return parameter	<NR3> Returns the theta delta between cursor1 and cursor2.
Example	:CURSor:XY:POLar:THETA:DELta? 9.10E+0 Returns the delta as 9.1°.

:CURSor:XY:PRODUct:POSition<X> → Query

Description	Queries the product in XY mode for the specified cursor, where x can be either 1 or 2.	
Syntax	:CURSor:XY:PRODUct:POSition<X>{?}	
Parameter	<X>	1, 2 (Cursor 1, Cursor 2)
Return parameter	<NR3>	Returns the product value of the Cursor1 or Cursor2.
Example	:CURSor:XY:PRODUct:POSition1? 9.44E-5 Returns the product of cursor1 as 94.4uVV.	

:CURSor:XY:PRODUct:DELta → Query

Description	Queries the product delta in XY mode.	
Syntax	:CURSor:XY:PRODUct:DELta{?}	
Return parameter	<NR3>	Returns the product delta.
Example	:CURSor:XY:PRODUct:DELta? 1.22E-5 Returns the product delta as 12.2uVV.	

:CURSor:XY:RATio:POSition<X> → Query

Description	Queries the ratio in XY mode for the specified cursor, where x can be either cursor 1 or 2.	
Syntax	:CURSor:XY:RATio:POSition<X>{?}	
Parameter	<X>	1, 2 (Cursor 1, Cursor 2)
Return parameter	<NR3>	Returns the ratio.

Example :CURSor:XY:RATio:POSition?
 6.717E+1
 Returns the ratio value as 6.717V/V.

:CURSor:XY:RATio:DELta → Query

Description Queries the ratio delta in XY mode.

Syntax :CURSor:XY:RATio:DELta{?}

Return parameter <NR3> Returns the ratio delta.

Example :CURSor:XY:RATio:DELta?
 5.39E+1
 Returns the ratio delta as 53.9V/V.

Display Commands

:DISPlay:INTensity:WAVEform.....	75
:DISPlay:INTensity:GRATICule.....	75
:DISPlay:INTensity:BACKLight	76
:DISPlay:INTensity:BACKLight:AUTODim:ENABle	76
:DISPlay:INTENSITY:BACKLight:AUTODim:TIME	76
:DISPlay:PERsistence	77
:DISPlay:GRATICule	77
:DISPlay:WAVEform.....	78
:DISPlay:OUTPut	78

:DISPlay:INTensity:WAVEform (Set) →
→ (Query)

Description Sets or queries the waveform intensity level.

Syntax :DISPlay:INTensity:WAVEform {<NRf> | ?}

Parameter <NRf> 0.0E+0 to 1.0E+2 (0% to 100%)

Return Parameter <NR3> Returns the intensity.

Example :DISPlay:INTensity:WAVEform 5.0E+1
 Sets the waveform intensity to 50%.

:DISPlay:INTensity:GRATICule (Set) →
→ (Query)

Description Sets or queries the graticule intensity level.

Syntax :DISPlay:INTensity:GRATICule {<NRf> | ?}

Parameter <NRf> 1.0E+0 to 1.0E+2 (10% to 100%)

Return Parameter <NR3> Returns the graticule intensity.

Example :DISPlay:INTensity:GRATICule 5.0E+1
 Sets the graticule intensity to 50%.

:DISPlay:INTensity:BACKLight (Set) →
→ (Query)

Description	Sets or queries the intensity of the backlight display.	
Syntax	:DISPlay:INTensity:BACKLight {<NRf> ?}	
Parameter	<NRf>	1.0E+0 to 1.0E+2 (10% to 100%)
Return Parameter	<NR3>	Returns the backlight intensity.
Example	:DISPlay:INTensity:BACKLight 5.0E+1 Sets the backlight intensity to 50%.	

:DISPlay:INTensity:BACKLight:AUTODim:ENABLE (Set) →
→ (Query)

Description	Sets or queries the display auto-dim function.	
Syntax	:DISPlay:INTensity:BACKLight:AUTODim:ENABLE {OFF ON ?}	
Parameter/ Return parameter	OFF ON	Turn auto-dim on. Turn auto-dim off.
Example	:DISPlay:INTensity:BACKLight:AUTODim:ENABLE ON Turns the auto-dim function on.	

:DISPlay:INTENSITY:BACKLight:AUTODim:TIME (Set) →
→ (Query)

Description	Sets or queries the display auto-dim time.	
Syntax	:DISPlay:INTensity:BACKLight:AUTODim:TIME { <NR1> ? }	
Parameter/ Return parameter	<NR1>	1 ~ 180 minutes. Time in minutes.
Example	:DISPlay:INTensity:BACKLight:AUTODim:TIME 10 Sets the auto-dim time to 10 minutes.	





Set →
← Query

:DISPlay:PERsistence

Description	Sets or queries the waveform persistence level.	
Syntax	:DISPlay:PERsistence { INFInite OFF <NRf> ? }	
Parameter	<NRf>	1.6E-2 ~ 4.0E+0. (16mS to 10S) Range(1.6E-2, 30E-3, 60E-3, 120E-2, 240E-3, 500E-3, 750E-3, 1, 1.5,2,...,9.5,10
	INFInite	Infinite persistence
	OFF	No persistence
Return Parameter	<NR3>	Returns the persistence time.
	INFInite	Infinite persistence
	OFF	No persistence
Example	:DISPlay:PERsistence 2.0E+0 Sets the persistence to 2 seconds.	

Set →
← Query

:DISPlay:GRATicule

Description	Sets or queries graticule display type.	
Syntax	:DISPlay:GRATicule {FULL GRID CROsS FRAMe ?}	
Parameter	FULL	
	FRAMe	
Parameter	CROsS	
	GRID	
Return parameter	Returns the graticule type.	
Example	:DISPlay:GRATicule FULL Sets the graticule to  .	

:DISPlay:WAVEform

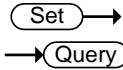

Description	Sets or queries whether the waveforms are drawn as vectors or dots.	
Syntax	:DISPlay:WAVEform {VECTor DOT ?}	
Parameter	VECTor	Vectors
	DOT	Dots
Return parameter	Returns VECTOR or DOT.	
Example	:DISPlay:WAVEform VECTor Sets the waveform to vectors.	

:DISPlay:OUTPut



Description	Returns the screen image as a 16 bit RGB run length encoded image.
Syntax	:DISPlay:OUTPut{?}
Return parameter	Format: header+data+LF For example assuming the image data size is 60072 bytes then the following would be returned: #560072<[count] [color] [count] [color]..... ><LF> Where #560072 is the header, each [count] and [color] data are 2 bytes and <LF> is a line feed character.

Hardcopy Commands

:HARDcopy:START	79
:HARDcopy:MODE	79
:HARDcopy:PRINTINKSaver	80
:HARDcopy:SAVEINKSaver	80
:HARDcopy:SAVEFORMat	80
:HARDcopy:ASSIGN	81

:HARDcopy:START

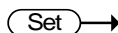

Description Executing the HARDcopy:START command is the equivalent of pressing the Hardcopy key on the front panel.

Syntax :HARDcopy:START

Related Commands

- :HARDcopy:MODE
- :HARDcopy:PRINTINKSaver
- :HARDcopy:SAVEINKSaver
- :HARDcopy:SAVEFORMat
- :HARDcopy:ASSIGN

:HARDcopy:MODE

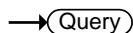
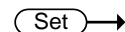

Description Sets or queries whether hardcopy is set to print or save.

Syntax :HARDcopy:MODE { PRINT | SAVE | ? }

Related Commands :HARDcopy:START

Parameter	PRINT	Print mode
	SAVE	Save mode

Return parameter Returns the mode.(PRINT/SAVE)

Example :HARDcopy:MODE PRINT
Sets hardcopy to print.

:HARDcopy:PRINTINKSaver (Set) →
→ (Query)

Description	Sets Inksaver On or Off for printing.	
Syntax	:HARDcopy:PRINTINKSaver { OFF ON ? }	
Related Commands	:HARDcopy:START :HARDcopy:MODE	
Parameter	ON	Inksaver ON
	OFF	Inksaver OFF
Return parameter	Returns the print Ink Saver mode.(ON/OFF)	

Example :HARDcopy:PRINTINKSaver ON
Sets Ink Saver to ON for printing.

:HARDcopy:SAVEINKSaver (Set) →
→ (Query)

Description	Sets Inksaver On or Off for saving screen images.	
Syntax	:HARDcopy:SAVEINKSaver { OFF ON ? }	
Related Commands	:HARDcopy:START :HARDcopy:MODE	
Parameter	ON	Inksaver ON
	OFF	Inksaver OFF
Return parameter	Returns the screen image Ink Saver mode (ON/OFF).	

Example :HARDcopy:SAVEINKSaver ON
Sets Inksaver to ON for saving screen images.

:HARDcopy:SAVEFORMat (Set) →
→ (Query)

Description	Sets or queries the image save file type.	
Syntax	:HARDcopy:SAVEFORMat { PNG BMP ? }	

Related Commands	:HARDcopy:START
	:HARDcopy:MODE
Parameter	PNG PNG file format
	BMP BMP file format
Return parameter	Returns the image file format (PNG/BMP).
Example	:HARDcopy:SAVEFORMat PNG Sets the file format to PNG.

:HARDcopy:ASSIGN

Set →

← Query

Description	Sets or queries what file type the hardcopy key has been assigned to save.
Syntax	:HARDcopy:ASSIGN {IMAGe WAVEform SETUp ALL ?}
Related Commands	:HARDcopy:START
	:HARDcopy:MODE
Parameter	IMAGe Save image files.
	WAVEform Save waveforms.
	SETUp Save the panel setup.
	ALL Save All (image, waveform,setup)
Return parameter	Returns the file type. (IMAGE/WAVEFORM/SETUP/ALL)
Example	:HARDcopy:ASSIGN IMAGE. Set the hardcopy key to save image files.

Measure Commands

:MEASure:GATing.....	83
:MEASure:SOURce	83
:MEASure:METHod	84
:MEASUrement:REFLevel:PERCent:HIGH	84
:MEASUrement:REFLevel:PERCent:LOW	85
:MEASUrement:REFLevel:PERCent:MID	85
:MEASUrement:REFLevel:PERCent:MID2	85
:MEASure:FALL.....	86
:MEASure:FOVShoot.....	86
:MEASure:FPreshoot	87
:MEASure:FREQuency.....	87
:MEASure:NWIDth	88
:MEASure:PDUTy	88
:MEASure:PERiod	89
:MEASure:PWIDth	89
:MEASure:RISe	90
:MEASure:ROVShoot.....	91
:MEASure:RPreshoot.....	91
:MEASure:PPULSE.....	92
:MEASure:NPULSE.....	92
:MEASure:PEDGE	93
:MEASure:NEDGE	93
:MEASure:AMPlitude.....	94
:MEASure:MEAN	94
:MEASure:CMEan	95
:MEASure:HIGH	96
:MEASure:LOW.....	96
:MEASure:MAX.....	97
:MEASure:MIN	97
:MEASure:PK2PK.....	98
:MEASure:RMS	98
:MEASure:CRMS.....	99

:MEASure:AREa	100
:MEASure:CARea	100
:MEASure:FRRDelay	101
:MEASure:FRFDelay.....	101
:MEASure:FFRDelay.....	102
:MEASure:FFFDelay.....	103
:MEASure:LRRDelay	103
:MEASure:LRFDelay.....	104
:MEASure:LFRDelay.....	104
:MEASure:LFFDelay.....	105
:MEASure:PHAsE.....	106
:MEASure:PFLI.....	106
:MEASure:FLI.....	107

:MEASure:GATing

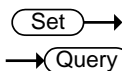

Description	Sets or queries the measurement gating.	
Syntax	:MEASure:GATing { OFF SCREEn CURSor ? }	
Parameter	OFF	Full record
	SCREEn	Gating set to screen width
	CURSor	Gating between cursors
Return parameter	Returns the gating. (OFF, SCREEN, CURSOR)	
Example	:MEASure:GATing OFF Turns gating off (full record).	

:MEASure:SOURce

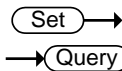

Description	Sets or queries the measurement source for source1 or source2.	
Syntax	:MEASure:SOURce<X> { CH1 CH2 MATH ? }	

Parameter	<X>	Source1 or source2
	CH1~CH2	Channel 1 to 2
	MATH	Math

Return parameter Returns the source (CH1, CH2, MATH)

Example :MEASure:SOURce1 CH1
Sets source1 to channel 1.

Set →

→ Query

:MEASure:METHOD

Description Sets or queries the method used to determine the High-Low measurement values.

Syntax :MEASure:METHOD { AUTO | HISTogram | MINMax | ? }

Parameter	AUTO	Set to auto.
	HISTogram	Set to the Histogram method.
	MINMax	Set to the Min-Max method.

Return parameter Returns the measurement method (AUTO, HISTOGRAM, MINMAX)

Example :MEASure:METHOD: AUTO
Set the measurement method to auto.

Set →

→ Query

:MEASurement:REFLevel:PERCent:HIGH

Description Sets or queries the high reference level as a percentage.

Syntax :MEASurement:REFLevel:PERCent:HIGH {<NRf> | ?}

Parameter	<NRf>	0 - 100%
-----------	-------	----------

Return parameter Returns the high reference level

Example :MEASurement:REFLevel:PERCent:HIGH 50.1
Set the high reference level to 50.1%.

:MEASUrement:REFLevel:PERCent:LOW  

Description	Sets or queries the low reference level as a percentage.
Syntax	:MEASUrement:REFLevel:PERCent:LOW {<NRf> ?}
Parameter	<NRf> 0 - 100%
Return parameter	Returns the low reference level.
Example	:MEASUrement:REFLevel:PERCent:LOW 40.1 Set the low reference level to 40.1%.

:MEASUrement:REFLevel:PERCent:MID  

Description	Sets or queries the first mid reference level as a percentage.
Syntax	:MEASUrement:REFLevel:PERCent:MID {<NRf> ?}
Parameter	<NRf> 0 - 100%
Return parameter	Returns the mid reference level.
Example	:MEASUrement:REFLevel:PERCent:MID 50 Set the mid reference level to 50%.

:MEASUrement:REFLevel:PERCent:MID2  

Description	Sets or queries the second mid reference level as a percentage.
Syntax	:MEASUrement:REFLevel:PERCent:MID2 {<NRf> ?}
Parameter	<NRf> 0 - 100%
Return parameter	Returns the mid reference level of the second source.
Example	:MEASUrement:REFLevel:PERCent:MID2 50 Set the mid reference level to 50%.

:MEASure:FALL

→ **Query**

Description	Returns the fall time measurement result.	
Syntax	:MEASure:FALL{?}	
Related Commands	:MEASure:SOURce<X>	
Return parameter	<NR3>	
	Chan Off	Indicates the source channel is not activated.

 **Note** Before using this command, select the measurement channel. See the example below.

Example :MEASure:SOURce1 CH1
 :MEASure:FALL?
 Selects Channel 1 as the source, and then measures the fall time.

:MEASure:FOVShoot

→ **Query**

Description	Returns the fall overshoot amplitude.	
Syntax	:MEASure:FOVShoot{?}	
Related Commands	:MEASure:SOURce<X>	
Return parameter	<NR3>	Returns the fall overshoot as a percentage
	Chan Off	Indicates the source channel is not activated.

 **Note** Before using this command, select the measurement channel. See the example below.

Example :MEASure:SOURce1 CH1
 :MEASure:FOVShoot?
 1.27E+0
 Selects Channel 1, and then measures the fall overshoot.

:MEASure:FPReshoot → Query

Description	Returns fall preshoot amplitude.
Syntax	:MEASure:FPReshoot{?}
Related Commands	:MEASure:SOURce<X>
Returns	Returns the fall preshoot as <NR3>.
Return parameter	<NR3> Returns the fall preshoot as a percentage. Chan Off Indicates the source channel is not activated.

 **Note** Before using this command, select the measurement channel. See the example below.

Example :MEASure:SOURce1 CH1
 :MEASure:FPReshoot?
 Selects Channel 1, and then measures the fall preshoot.

:MEASure:FREQuency → Query

Description	Returns the frequency value.
Syntax	:MEASure:FREQuency{?}
Related Commands	:MEASure:SOURce<X>
Return parameter	<NR3> Returns the frequency in Hz. Chan Off Indicates the source channel is not activated.



Note

Before using this command, select the measurement channel. See the example below.

Example :MEASure:SOURce1 CH1
:MEASure:FREQuency?
>1.0E+3

Selects Channel 1, and then measures the frequency.

:MEASure:NWIDth



Description Returns the first negative pulse width timing.

Syntax :MEASure:NWIDth{?}

Related Commands :MEASure:SOURce<X>

Return parameter	<NR3>	Returns the negative pulse width in seconds.
	Chan Off	Indicates the source channel is not activated.



Note

Before using this command, select the measurement channel. See the example below.

Example :MEASure:SOURce1 CH1
:MEASure:NWIDth?
4.995E-04

Selects Channel 1, and then measures the negative pulse width.

:MEASure:PDUTy



Description Returns the positive duty cycle ratio as percentage.

Syntax :MEASure:PDUTy{?}

Related commands :MEASure:SOURce<X>

Return parameter	<NR3>	Returns the positive duty ratio.
	Chan Off	Indicates the source channel is not activated.

 **Note** Before using this command, select the measurement channel. See the example below.

Example :MEASure:SOURce1 CH1
 :MEASure:PDUTy?
 5.000E+01
 Selects Channel 1, and then measures the positive duty cycle.

:MEASure:PERiod → 

Description	Returns the period.
Syntax	:MEASure:PERiod{?}
Related Commands	:MEASure:SOURce<X>

Return parameter	<NR3>	Returns the period.
	Chan Off	Indicates the source channel is not activated.

 **Note** Before using this command, select the measurement channel. See the example below.

Example :MEASure:SOURce1 CH1
 :MEASure:PERiod?
 1.0E-3
 Selects Channel 1, and then measures the period.

:MEASure:PWIDth → 

Description	Returns the first positive pulse width.
Syntax	:MEASure:PWIDth{?}

Related Commands :MEASure:SOURce<X>

Return parameter	<NR3>	Returns the positive pulse width.
	Chan Off	Indicates the source channel is not activated.

 **Note** Before using this command, select the measurement channel. See the example below.

Example :MEASure:SOURce1 CH1
 :MEASure:PWIDth?
 5.0E-6
 Selects Channel 1, and then measures the positive pulse width.

:MEASure:RISe → 

Description Returns the first pulse rise time.

Syntax :MEASure:RISe{?}

Related Commands :MEASure:SOURce<X>

Return parameter	<NR3>	Returns the rise time.
	Chan Off	Indicates the source channel is not activated.

 **Note** Before using this command, select the measurement channel. See the example below.

Example :MEASure:SOURce1 CH1
 :MEASure:RISe?
 8.5E-6
 Selects Channel 1, and then measures the rise time.

:MEASure:ROVShoot

→ **Query**

Description Returns the rising overshoot over the entire waveform in percentage.

Syntax :MEASure:ROVShoot{?}

Related Commands :MEASure:SOURce<X>

Return parameter	<NR3>	Returns the overshoot.
	Chan Off	Indicates the source channel is not activated.

 **Note** Before using this command, select the measurement channel. See the example below.

Example

```
:MEASure:SOURce1 CH1
:MEASure:ROVShoot?
5.00E+00
```

Selects Channel 1, and then measures the rise overshoot.

:MEASure:RPReshoot

→ **Query**

Description Returns rising preshoot over the entire waveform in percentage.

Syntax :MEASure:RPReshoot{?}

Related Commands :MEASure:SOURce<X>

Return parameter	<NR3>	Returns the rising preshoot.
	Chan Off	Indicates the source channel is not activated.

 **Note** Before using this command, select the measurement channel. See the example below.

Example :MEASure:SOURce1 CH1
 :MEASure:RPReshoot?
 2.13E-2
 Selects Channel 1, and then measures the rise preshoot.

:MEASure:PPULSE → Query

Description	Returns the number of positive pulses.	
Syntax	:MEASure:PPULSE{?}	
Related Commands	:MEASure:SOURce<X>	
Return parameter	<NR3>	Returns the number of positive pulses.
	Chan Off	Indicates the source channel is not activated.

 **Note** Before using this command, select the measurement channel. See the example below.

Example :MEASure:SOURce1 CH1
 :MEASure:PPULSE?
 6.000E+00
 Selects Channel 1, and then measures the number of positive pulses.

:MEASure:NPULSE → Query

Description	Returns the number of negative pulses.	
Syntax	:MEASure:NPULSE{?}	
Related Commands	:MEASure:SOURce<X>	
Return parameter	<NR3>	Returns the number of negative pulses.
	Chan Off	Indicates the source channel is not activated.

 **Note** Before using this command, select the measurement channel. See the example below.

Example :MEASure:SOURce1 CH1
 :MEASure:NPULSE?
 4.000E+00
 Selects Channel 1, and then measures the number of negative pulses.

:MEASure:PEDGE → 

Description	Returns the number of positive edges.	
Syntax	:MEASure:PEDGE{?}	
Related Commands	:MEASure:SOURce<X>	
Return parameter	<NR3>	Returns the number of positive edges.
	Chan Off	Indicates the source channel is not activated.

 **Note** Before using this command, select the measurement channel. See the example below.

Example :MEASure:SOURce1 CH1
 :MEASure:PEDGE?
 1.100E+01
 Selects Channel 1, and then measures the number of positive edges.

:MEASure:NEDGE → 

Description	Returns the number of negative edges.	
Syntax	:MEASure:NEDGE{?}	
Related Commands	:MEASure:SOURce<X>	

Return parameter	<NR3>	Returns the number of negative edges.
	Chan Off	Indicates the source channel is not activated.

 **Note** Before using this command, select the measurement channel. See the example below.

Example :MEASure:SOURce1 CH1
 :MEASure:NEDGE?
 1.100E+01
 Selects Channel 1, and then measures the number of negative edges.

:MEASure:AMPlitude → 

Description Returns the amplitude difference between the Vhigh-Vlow.

Syntax :MEASure:AMPlitude{?}

Related Commands :MEASure:SOURce<X>

Return parameter	<NR3>	Returns the amplitude.
	Chan Off	Indicates the source channel is not activated.

 **Note** Before using this command, select the measurement channel. See the example below.

Example :MEASure:SOURce1 CH1
 :MEASure:AMPlitude?
 3.76E-3
 Selects Channel 1, and then measures the amplitude.

:MEASure:MEAN → 

Description Returns the mean voltage/current of one or more full periods.

Syntax	:MEASure:MEAN{?}	
Related Commands	:MEASure:SOURce<X>	
Return parameter	<NR3>	Returns the mean.
	Chan Off	Indicates the source channel is not activated.

 **Note** Before using this command, select the measurement channel. See the example below.

Example

```
:MEASure:SOURce1 CH1
:MEASure:MEAN?
1.82E-3
```

Selects Channel 1, and then measures the mean value.

:MEASure:CMEan



Description	Returns the mean voltage/current of one full period.	
Syntax	:MEASure:CMEan{?}	
Related Commands	:MEASure:SOURce<X>	
Return parameter	<NR3>	Returns the cyclic mean.
	Chan Off	Indicates the source channel is not activated.

 **Note** Before using this command, select the measurement channel. See the example below.

Example

```
:MEASure:SOURce1 CH1
:MEASure:CMEan?
9.480E-01
```

Selects Channel 1, and then measures the mean value of the first period.

:MEASure:HIGH

→ Query

Description	Returns the global high voltage/current.	
Syntax	:MEASure:HIGH{?}	
Related Commands	:MEASure:SOURce<X>	
Return parameter	<NR3>	Returns the high value.
	Chan Off	Indicates the source channel is not activated.



Note

Before using this command, select the measurement channel. See the example below.

Example

```
:MEASure:SOURce1 CH1
:MEASure:HIGH?
3.68E-3
```

Selects Channel 1, and then measures the high voltage/current.

:MEASure:LOW

→ Query

Description	Returns the global low voltage/current.	
Syntax	:MEASure:LOW{?}	
Related Commands	:MEASure:SOURce<X>	
Return parameter	<NR3>	Returns the global low value.
	Chan Off	Indicates the source channel is not activated.



Note

Before using this command, select the measurement channel. See the example below.

Example :MEASure:SOURce1 CH1
 :MEASure:LOW?
 1.00E-0
 Selects Channel 1, and then measures the low current/voltage.

:MEASure:MAX → Query

Description	Returns the maximum amplitude.	
Syntax	:MEASure:MAX{?}	
Related Commands	:MEASure:SOURce<X>	
Return parameter	<NR3>	Returns the maximum amplitude.
	Chan Off	Indicates the source channel is not activated.

 **Note** Before using this command, select the measurement channel. See the example below.

Example :MEASure:SOURce1 CH1
 :MEASure:MAX?
 1.90E-3
 Selects Channel 1, and then measures the maximum amplitude.

:MEASure:MIN → Query

Description	Returns the minimum amplitude.	
Syntax	:MEASure:MIN{?}	
Related Commands	:MEASure:SOURce<X>	
Return parameter	<NR3>	Returns the minimum amplitude.
	Chan Off	Indicates the source channel is not activated.



Note

Before using this command, select the measurement channel. See the example below.

Example :MEASure:SOURce1 CH1
:MEASure:MIN?
-8.00E-3

Selects Channel 1, and then measures the minimum amplitude.

:MEASure:PK2PK



Description Returns the peak-to-peak amplitude (difference between maximum and minimum amplitude).

Syntax :MEASure:PK2Pk{?}

Related Commands :MEASure:SOURce<X>

Return parameter	<NR3>	Returns the voltage or current peak to peak measurement.
	Chan Off	Indicates the source channel is not activated.



Note

Before using this command, select the measurement channel. See the example below.

Example :MEASure:SOURce1 CH1
:MEASure:PK2Pk?
2.04E-1

Selects Channel 1, and then measures the peak-to-peak amplitude.

:MEASure:RMS



Description Returns the root-mean-square voltage/current of one or more full periods.

Syntax :MEASure:RMS{?}

Related Commands	:MEASure:SOURce<X>	
Return parameter	<NR3>	Returns the RMS value.
	Chan Off	Indicates the source channel is not activated.
 Note	Before using this command, select the measurement channel. See the example below.	
Example	:MEASure:SOURce1 CH1 :MEASure:RMS? 1.31E-3 Selects Channel 1, and then measures the RMS voltage/current.	

:MEASure:CRMS → 

Description	Returns the root-mean-square voltage/current of one full periods.	
Syntax	:MEASure:CRMS{?}	
Related Commands	:MEASure:SOURce<X>	
Return parameter	<NR3>	Returns the CRMS value.
	Chan Off	Indicates the source channel is not activated.
 Note	Before using this command, select the measurement channel. See the example below.	
Example	:MEASure:SOURce1 CH1 :MEASure:CRMS? 1.31E-3 Selects Channel 1, and then measures the CRMS voltage/current.	

:MEASure:AREa

→ Query

Description	Returns the voltage/current area over one or more full periods.	
Syntax	:MEASure:AREa{?}	
Related Commands	:MEASure:SOURce<X>	
Return parameter	<NR3>	Returns the area value.
	Chan Off	Indicates the source channel is not activated.



Note

Before using this command, select the measurement channel. See the example below.

Example	:MEASure:SOURce1 CH1
	:MEASure:AREa?
	1.958E-03
	Selects Channel 1, and then measures the area.

:MEASure:CARea

→ Query

Description	Returns the voltage/current area over one full period.	
Syntax	:MEASure:CARea{?}	
Related Commands	:MEASure:SOURce<X>	
Return parameter	<NR3>	Returns the area value.
	Chan Off	Indicates the source channel is not activated.



Note

Before using this command, select the measurement channel. See the example below.

Example :MEASure:SOURce1 CH1
 :MEASure:CARea?
 1.958E-03
 Selects Channel 1, and then measures the area.

:MEASure:FRRDelay → Query

Description Returns the delay between the first rising edge of source1 and the first rising edge of source2.

Syntax :MEASure:FRRDelay{?}

Related Commands :MEASure:SOURce<X>

Return parameter	<NR3>	Returns the delay.
	Chan Off	Indicates the source channel is not activated.

 **Note** Select the two source channels before entering this command.

Example :MEASure:SOURce1 CH1
 :MEASure:SOURce2 CH2
 :MEASure:FRRDelay?
 -4.68E-6
 Select channel 1 and 2 as source1/2, and then measure FRR.

:MEASure:FRFDelay → Query

Description Returns the delay between the first rising edge of source1 and the first falling edge of source2.

Syntax :MEASure:FRFDelay{?}

Related Commands :MEASure:SOURce<X>

Return parameter	<NR3>	Returns the delay.
	Chan Off	Indicates the source channel is not activated.

 **Note** Select the two source channels before entering this command.

Example

```
:MEASure:SOURce1 CH1
:MEASure:SOURce2 CH2
:MEASure:FRFDelay?
3.43E-6
```

Select channel 1 and 2 as source1/2, and then measures FRF.

:MEASure:FFRDelay → 

Description Returns the delay between the first falling edge of source1 and the first rising edge of source2.

Syntax :MEASure:FRRDelay{?}

Related Commands :MEASure:SOURce<X>

Return parameter	<NR3>	Returns the delay.
	Chan Off	Indicates the source channel is not activated.

 **Note** Select the two source channels before entering this command.

Example

```
:MEASure:SOURce1 CH1
:MEASure:SOURce2 CH2
:MEASure:FRRDelay?
-8.56E-6
```

Select channel 1 and 2 as delay source1/2, and then measure FFR.

:MEASure:FFFDelay → Query

Description Returns the delay between the first falling edge of source1 and the first falling edge of source2.

Syntax :MEASure:FFFDelay{?}

Related Commands :MEASure:SOURce<X>

Return parameter	<NR3>	Returns the delay.
	Chan Off	Indicates the source channel is not activated.

 **Note** Select the two source channels before entering this command.

Example

```
:MEASure:SOURce1 CH1
:MEASure:SOURce2 CH2
:MEASure:FFFDelay?
-8.89E-6
```

Select channel 1 and 2 as delay source1/2, and then measure FFF.

:MEASure:LRRDelay → Query

Description Returns the delay between the first rising edge of source1 and the last rising edge of source2.

Syntax :MEASure:LRRDelay{?}

Related Commands :MEASure:SOURce<X>

Return parameter	<NR3>	Returns the delay.
	Chan Off	Indicates the source channel is not activated.

 **Note** Select the two source channels before entering this command.

Example :MEASure:SOURce1 CH1
 :MEASure:SOURce2 CH2
 :MEASure:LRRDelay?
 -8.89E-6
 Select channel 1 and 2 as delay source1/2, and then measure LRR.

:MEASure:LRFDelay → Query

Description Returns the delay between the first rising edge of source1 and the last rising edge of source2.

Syntax :MEASure:LRFDelay{?}

Related Commands :MEASure:SOURce<X>

Return parameter	<NR3>	Returns the delay.
	Chan Off	Indicates the source channel is not activated.



Note

Select the two source channels before entering this command.

Example :MEASure:SOURce1 CH1
 :MEASure:SOURce2 CH2
 :MEASure:LRFDelay?
 -4.99E-6
 Select channel 1 and 2 as delay source1/2, and then measure LRF.

:MEASure:LFRDelay → Query

Description Returns the delay between the first falling edge of source1 and the last rising edge of source2.

Syntax :MEASure:LFRDelay{?}

Related Commands :MEASure:SOURce<X>

Return parameter	<NR3>	Returns the delay.
	Chan Off	Indicates the source channel is not activated.

 **Note** Select the two source channels before entering this command.

Example :MEASure:SOURce1 CH1
 :MEASure:SOURce2 CH2
 :MEASure:LFRDelay?
 -9.99E-6
 Select channel 1 and 2 as delay source1/2, and then measure LFR.

:MEASure:LFFDelay → 

Description Returns the delay between the first falling edge of source1 and the last falling edge of source2.

Syntax :MEASure:LFFDelay{?}

Related Commands :MEASure:SOURce<X>

Return parameter	<NR3>	Returns the delay.
	Chan Off	Indicates the source channel is not activated.

 **Note** Select the two source channels before entering this command.

Example :MEASure:SOURce1 CH1
 :MEASure:SOURce2 CH2
 :MEASure:LFFDelay?
 -9.99E-6
 Select channel 1 and 2 as delay source1/2, and then measure LFF.

:MEASure:PHase

→ Query

Description	Returns the phase between source 1 and source 2.	
Syntax	:MEASure:PHase{?}	
Related Commands	:MEASure:SOURce<X>	
Return parameter	<NR3>	Returns the phase difference.
	Chan Off	Indicates the source channel is not activated.



Note

Select the two source channels before entering this command.

Example

```
:MEASure:SOURce1 CH1
:MEASure:SOURce2 CH2
:MEASure:PHase?
4.50E+01
```

Select channel 1 and 2 as phase source1/2, and then measure the phase in degrees.

:MEASure:PFLI

→ Query

Description	Returns the % flicker of times.	
Syntax	:MEASure:PFLI?	
Related Commands	:MEASure:SOURce<x>	
Return parameter	<NR3>	
	Chan Off	Indicates the source channel is not activated.



Note

Before using this command, select the measurement channel. See the example below.

Example :MEASure:SOURce1 CH1
 :MEASure:PFLI ?
 5.950E+01
 Selects Channel 1 as the source, and then measures the % flicker of times.

:MEASure:FLI → Query

Description	Returns the flicker idx of times.	
Syntax	:MEASure:FLI?	
Related Commands	:MEASure:SOURce<x>	
Return parameter	<NR3> Chan Off	Indicates the source channel is not activated.

 **Note** Before using this command, select the measurement channel. See the example below.

Example :MEASure:SOURce1 CH1
 :MEASure:FLI ?
 2.870E-01
 Selects Channel 1 as the source, and then measures the flicker idx of times.

Measurement Commands

:MEASUrement:MEAS<X>:SOURCE<X>	108
:MEASUrement:MEAS<X>:TYPE	109
:MEASUrement:MEAS<X>:STATE	109
:MEASUrement:MEAS<X>:VALue	110
:MEASUrement:MEAS<X>:MAXimum	111
:MEASUrement:MEAS<X>:MEAN	112
:MEASUrement:MEAS<X>:MINImum	112
:MEASUrement:MEAS<X>:STDdev	113
:MEASUrement:STATIstics:MODE	114
:MEASUrement:STATIstics:WEIghting	114
:MEASUrement:STATIstics	115

:MEASUrement:MEAS<X>:SOURCE<X> (Set) →
→ (Query)

Description	Sets or queries the measurement source for a selected automatic measurement. This is a statistics related command.	
Syntax	:MEASUrement:MEAS<X>:SOURCE<X> { CH1 CH2 ? }	
Related commands	:MEASUrement:MEAS<X>:TYPE	
Parameter	MEAS<X>	The automatic measurement number from 1 to 8.
	SOURCE<X>	SOURCE1: the source for all single channel measurements.
	SOURCE<X>	SOURCE2: the source for all delay or phase measurements.
	CH1 to CH2	Channel 1, 2
	MATH	Math source

Return parameter	CH1 to CH2	Channel 1, 2
	MATH	Math source

Example :MEASUrement:MEAS1:SOURCE1?
 >CH1
 Returns the (first) source for measurement 1.

Set →

→ Query

:MEASUrement:MEAS<X>:TYPE

Description Sets or queries the measurement type for a selected automatic measurement. This is a statistics related command.

Syntax :MEASUrement:MEAS<X>:TYPE
 {PK2pk | MAXimum | MINImum | AMPlitude | HIGH | LOW | MEAN | CMEan | RMS | CRMs | AREa | CAREa | ROVShoot | FOVShoot | RPReshoot | FPReshoot | FREQuency | PERIod | RISE | FALL | PWIdth | NWIdth | PDUTy | PPULSE | NPULSE | PEDGE | NEDGE | PFLIcker | FLIcker | FRRDelay | FRFDelay | FFRDelay | FFFDelay | LRRDelay | LRFDelay | LFRDelay | LFFDelay | PHAse | ?}

Related commands :MEASUrement:MEAS<X>:SOURCE<X>

Parameter	MEAS<X>	The automatic measurement number from 1 to 8.
-----------	---------	---

Return parameter Returns the measurement type

Example :MEASUrement:MEAS1:TYPE RMS
 Sets measurement 1 to RMS measurement.

Set →

→ Query

:MEASUrement:MEAS<X>:STATE

Description Sets or queries the state of a selected measurement. This is a statistics related command.

Syntax :MEASUrement:MEAS<X>:STATE { ON | OFF | 1 | 0 | ? }

Related commands	:MEASUrement:MEAS<X>:SOUrce<X> :MEASUrement:MEAS<X>:TYPe	
Parameter	MEAS<X>	The automatic measurement number from 1 to 8.
	ON/1	Turn the measurement on.
	OFF/0	Turn the measurement off.
Return parameter	0	Measurement is off.
	1	Measurement is on.
Example	:MEASUrement:MEAS1:STATE 1 Turns measurement 1 on.	

:MEASUrement:MEAS<X>:VALue → Query

Description	Returns the measurement results for the selected measurement. This is a statistics related command.	
Syntax	:MEASUrement:MEAS<X>:VALue?	
Related Commands	:MEASure:SOURce<X>	
Parameter	MEAS<X>	The automatic measurement number from 1 to 8.
	<NR3>	Returns the measurement for the selected measurement number.

 **Note** The measurement source(s), measurement number, measurement type and measurement state must first be set before a measurement result can be returned.

Example :MEASUrement:MEAS1:SOUrce1 CH1
 :MEASUrement:MEAS1:TYPe PK2PK
 :MEASUrement:MEAS1:STATE ON
 :MEASUrement:MEAS1:VALue?
 5.000E+0

Selects channel 1 as the source for measurement 1, sets measurement 1 to peak to peak measurement and then turns on the measurement. The result returns the peak to peak measurement.

:MEASUrement:MEAS<X>:MAXimum → 

Description Returns the maximum measurement results for the selected measurement from the last time the statistics were reset. This is a statistics related command.

Syntax :MEASUrement:MEAS<X>:MAXimum?

Related Commands :MEASUrement:STATIstics:MODE

Parameter	MEAS<X>	The automatic measurement number from 1 to 8.
-----------	---------	---

Return parameter	<NR3>	Returns the measurement for the selected measurement number.
------------------	-------	--

Example :MEASUrement:MEAS3:SOUrce1 CH1
 :MEASUrement:MEAS3:TYPe PK2PK
 :MEASUrement:MEAS3:STATE ON
 :MEASUrement:STATIstics:MODE ON
 :MEASUrement:MEAS3:MAXimum?
 2.800E-02

Returns the maximum measurement result for measurement number 3.

:MEASUrement:MEAS<X>:MEAN → Query

Description	Returns the mean measurement results for the selected measurement from the last time the statistics were reset. This is a statistics related command.	
Syntax	:MEASUrement:MEAS<X>:MEAN?	
Related Commands	:MEASUrement:STATIstics:MODE	
Parameter	MEAS<X>	The automatic measurement number from 1 to 8.
Return parameter	<NR3>	Returns the measurement for the selected measurement number.
Example	<pre>:MEASUrement:MEAS3:SOUrce1 CH1 :MEASUrement:MEAS3:TYPe PK2PK :MEASUrement:MEAS3:STATE ON :MEASUrement:STATIstics:MODE ON :MEASUrement:MEAS3:MEAN? 2.090E-02</pre> <p>Returns the mean measurement result for measurement number 3.</p>	

:MEASUrement:MEAS<X>:MINIum → Query

Description	Returns the minimum measurement results for the selected measurement from the last time the statistics were reset. This is a statistics related command.	
Syntax	:MEASUrement:MEAS<X>:MINIum?	
Related Commands	:MEASUrement:STATIstics:MODE	

Parameter	MEAS<X>	The automatic measurement number from 1 to 8.
Return parameter	<NR3>	Returns the measurement for the selected measurement number.

Example

```
:MEASUrement:MEAS3:SOUrce1 CH1
:MEASUrement:MEAS3:TYPe PK2PK
:MEASUrement:MEAS3:STATE ON
:MEASUrement:STATIstics:MODE ON
:MEASUrement:MEAS3:MINIum?
1.600E-02
```

Returns the minimum measurement result for measurement number 3.

:MEASUrement:MEAS<X>:STDdev → Query

Description Returns the standard deviation for the selected measurement from the last time the statistics were reset. This is a statistics related command.

Syntax :MEASUrement:MEAS<X>:STDdev?

Related Commands :MEASUrement:STATIstics:MODE

Parameter	MEAS<X>	The automatic measurement number from 1 to 8.
Return parameter	<NR3>	Returns the measurement for the selected measurement number.

Example :MEASUrement:MEAS3:SOUrce1 CH1
 :MEASUrement:MEAS3:TYPe PK2PK
 :MEASUrement:MEAS3:STATE ON
 :MEASUrement:STATIstics:MODE ON
 :MEASUrement:MEAS3:STDdev?
 1.530E-03
 Returns the standard deviation for measurement number 3.

Set →

:MEASUrement:STATIstics:MODE

→ Query

Description Puts the statics measurement results on the display or queries whether the statistics are displayed.

Syntax :MEASUrement:STATIstics:MODE {OFF | ON | ?}

Related commands :MEASUrement:STATIstics

Parameter/ Return parameter	ON	Display the statistics on the screen.
	OFF	Remove the statistics from the screen

Example :MEASUrement:STATIstics:MODE ON
 Displays statistics on the screen.

Set →

:MEASUrement:STATIstics:WEIghing

→ Query

Description Sets and queries the number of samples (weighting) used for the statistics calculations.

Syntax :MEASUrement:STATIstics:WEIghing { <NR1> | ? }

Parameter/ Return parameter	<NR1>	Number of samples (2~1000)
-----------------------------	-------	----------------------------

Example :MEASUrement:STATIstics:WEIghing 5
 Sets the number of samples to 5.

:MEASUrement:STATIstics

Set →

Description Resets the statics calculations. This command will clear all the currently accumulated measurements.

Syntax :MEASUrement:STATIstics {RESET}

Reference Commands

:REF<X>:DISPlay	116
:REF<X>:TIMebase:POSition	116
:REF<X>:TIMebase:SCALe	117
:REF<X>:OFFSet	117
:REF<x>:SCALe	118

:REF<X>:DISPlay



Description Sets or queries whether a reference waveform will be shown on the display. A reference waveform must first be saved before this command can be used.

Syntax :REF<x>:DISPlay { OFF| ON| ? }

Parameter	<X>	Reference waveform 1, 2, 3, 4.
	OFF	Turns the selected reference waveform off
	ON	Turns the selected reference waveform on

Return parameter Returns the status of the selected reference waveform. (OFF, ON).

Example :REF1:DISPlay ON
Turns on reference1 (REF 1) on the display.

:REF<X>:TIMebase:POSition



Description Sets or returns the selected reference waveform time base position.

Syntax :REF<X>:TIMebase:POSition { <NRf> | ? }

Related commands :REF<X>:DISPlay

Parameter	<X>	Reference waveform 1, 2, 3, 4.
	<NRf>	Horizontal co-ordinates

Return parameter	<NR3>	Returns the reference waveform position
------------------	-------	---

Example :REF1:TIMEbase:POSition -5.000E-5
 Selects reference 1, and then sets the horizontal position to -50us.

:REF<X>:TIMEbase:SCALE  

Description Sets or returns the selected reference waveform time base scale.

Syntax :REF<X>:TIMEbase:SCALE { <NRf> | ?}

Related commands :REF<X>:DISPlay

Parameter	<X>	Reference waveform 1, 2, 3, 4.
	<NRf>	Horizontal scale

Return parameter	<NR3>	Returns the reference waveform scale.
------------------	-------	---------------------------------------

Example :REF1:TIMEbase:SCALE 5.00E-4
 Selects reference 1, and then sets the horizontal scale to 500us/div.

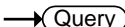
:REF<X>:OFFSet  

Description Sets or returns the selected reference waveform vertical position (offset).

Syntax :REF<X>:OFFSet { <NRf> | ?}

Related commands :REF<X>:DISPlay

Parameter	<X>	Reference waveform 1, 2, 3, 4.
	<NRf>	Vertical offset

Return parameter	<code><NR3></code>	Returns the reference waveform vertical position.
------------------	--------------------------	---

Example :REF1:OFFSet -5.000E-2
 Selects reference 1, and then sets the vertical position to -50mV/mA.

`:REF<x>:SCALE`

Description	Sets or returns the selected reference waveform vertical scale.
-------------	---

Syntax	:REF<X>:SCALE { <NRf> ? }
--------	-----------------------------

Related commands	:REF<X>:DISPlay
------------------	-----------------

Parameter	<code><X></code>	Reference waveform 1, 2, 3, 4.
	<code><NRf></code>	Vertical scale

Return parameter	<code><NR3></code>	Returns the reference waveform vertical scale.
------------------	--------------------------	--

Example :REF1:SCALE 5.000E-2
 Selects reference 1, and then sets the vertical scale to 50mV | mA/div.

Run Command

:RUN



Description	The run command allows the oscilloscope to continuously make acquisitions (equivalent to pressing the Run key on the front panel).
-------------	--

Syntax	:RUN
--------	------

Stop Command

:STOP



Description	The stop command stops the oscilloscope making further acquisitions (equivalent to pressing the Stop key on the front panel).
-------------	---

Syntax	:STOP
--------	-------

Single Command

:SINGle



Description	The single command allows the oscilloscope to capture a single acquisition when trigger conditions have been fulfilled (equivalent to pressing the Single key on the front panel).
-------------	--

Syntax	:SINGle
--------	---------

Force Command

:FORCe



Description	The Force command forces an acquisition (equivalent to pressing the Force-Trig key on the front panel).
-------------	---

Syntax	:FORCe
--------	--------

Timebase Commands

:TIMebase:EXPand	123
:TIMebase:POSition	123
:TIMebase:SCALe.....	124
:TIMebase:MODE	124
:TIMebase:WINDow:POSition	124
:TIMebase:WINDow:SCALe	125

:TIMebase:EXPand

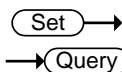

Description Sets or queries the horizontal expansion mode.

Syntax :TIMebase:EXPand {CENTer|TRIGger[?]}

Parameter/Return parameter	CENTer	Expand from the center of the display.
	TRIGger	Expand from the trigger point.

Example :TIMebase:EXPand TRIGger
Sets the expansion point to the trigger point.

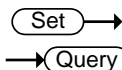

:TIMebase:POSition

Description Sets or queries the horizontal position.

Syntax :TIMebase:POSition {<NRf> | ?}

Parameter	<NRf>	Horizontal position
Return parameter	<NR3>	Returns the horizontal position

Example :TIMebase:POSition 5.00E-4
Sets the horizontal position as 500us.

Set →

→ Query

:TIMEbase:SCALE

Description	Sets or queries the horizontal scale.	
Syntax	:TIMEbase:SCALE {<NRf> ?}	
Parameter	<NRf>	Horizontal scale
Return parameter	<NR3>	Returns the horizontal scale.
Example	:TIMEbase:SCALE 5.00E-2 Sets the horizontal scale to 50ms/div.	

Set →

→ Query

:TIMEbase:MODE

Description	Sets or queries the time base mode. The time base mode determines the display view window on the scope.	
Syntax	:TIMEbase:MODE {MAIN WINDow XY ?}	
Parameter	MAIN	Sets the time base mode to the main screen.
	WINDow	Sets the time base mode to the zoom window.
	XY	Sets the time base mode to the XY display.
Return parameter	Returns the time base mode (MAIN, WINDOW, XY)	
Example	:TIMEbase:MODE MAIN Sets the time base mode to the main mode.	

Set →

→ Query

:TIMEbase:WINDow:POSition

Description	Sets or queries the zoom horizontal position.	
Syntax	:TIMEbase:WINDow:POSition {<NRf> ?}	

Related commands :TIMebase:MODE

Parameter <NRf> Horizontal position for zoom window

Return parameter <NR3> Returns the zoom horizontal position.

Example :TIMebase:WINDow:POSition 2.0E-3
Sets the zoom horizontal position as 20ms.

Set →

→ Query

:TIMebase:WINDow:SCALE

Description Sets or queries the zoom horizontal scale.

Note If the oscilloscope is under “ZOOM” mode, the main timebase function will be disabled and cannot be modified.

Syntax :TIMebase:WINDow:SCALE {<NRf> | ?}

Related commands :TIMebase:MODE

Parameter <NRf> Zoom horizontal scale. The range will depend on the time base.

Return parameter <NR3> Returns the zoom horizontal scale.

Example :TIMebase:WINDow:SCALE 2.0E-3
Sets the zoom horizontal scale to 2ms.

Trigger Commands

:TRIGger:FREQuency.....	127
:TRIGger:TYPe	128
:TRIGger:SOURce	128
:TRIGger:COUPle.....	129
:TRIGger:NREJ	129
:TRIGger:MODe.....	130
:TRIGger:HOLDoff.....	130
:TRIGger:LEVel.....	130
:TRIGger:HLEVel	131
:TRIGger:LLEVel.....	131
:TRIGger:EDGE:SLOP.....	132
:TRIGger:DElay:SLOP	132
:TRIGger:DElay:TYPe.....	133
:TRIGger:DElay:TIme.....	133
:TRIGger:DElay:EVENt.....	133
:TRIGger:DElay:LEVel	134
:TRIGger:PULSEWidth:POLarity	134
:TRIGger:RUNT:POLarity	134
:TRIGger:RUNT:WHEn.....	135
:TRIGger:RUNT:TIme.....	135
:TRIGger:RISEFall:SLOP.....	136
:TRIGger:RISEFall:WHEn	136
:TRIGger:RISEFall:TIme	137
:TRIGger:VIDeo:TYPe	137
:TRIGger:VIDeo:FIELd	138
:TRIGger:VIDeo:LINE	138
:TRIGger:VIDeo:POLarity	139
:TRIGger:PULSe:WHEn	139
:TRIGger:PULSe:TIme	140
:TRIGger:TIMEOut:WHEn.....	140
:TRIGger:TIMEOut:TImER	140
:TRIGger:STATe	141

:TRIGger:EXTERnal:PROBe:TYPe.....	141
:TRIGger:EXTERnal:PROBe:RATio	142
:TRIGger:BUS:TYPe	142
:TRIGger:BUS:THReshold:CH<x>	143
:TRIGger:BUS:B1:I2C:CONDition	143
:TRIGger:BUS:B1:I2C:ADDReSS:MODE	144
:TRIGger:BUS:B1:I2C:ADDReSS:TYPe.....	144
:TRIGger:BUS:B1:I2C:ADDReSS:VALue	145
:TRIGger:BUS:B1:I2C:ADDReSS:DIRectioN.....	146
:TRIGger:BUS:B1:I2C:DATA:SIZE	146
:TRIGger:BUS:B1:I2C:DATA:VALue	147
:TRIGger:BUS:B1:UART:CONDition	147
:TRIGger:BUS:B1:UART:RX:DATA:SIZE	148
:TRIGger:BUS:B1:UART:RX:DATA:VALue	148
:TRIGger:BUS:B1:UART:TX:DATA:SIZE.....	149
:TRIGger:BUS:B1:UART:TX:DATA:VALue	150
:TRIGger:BUS:B1:CAN:CONDition.....	150
:TRIGger:BUS:B1:CAN:FRAMeType	151
:TRIGger:BUS:B1:CAN:IDentifier:MODE	151
:TRIGger:BUS:B1:CAN:IDentifier:VALue	152
:TRIGger:BUS:B1:CAN:IDentifier:DIRectioN.....	153
:TRIGger:BUS:B1:CAN:DATA:QUALifier	153
:TRIGger:BUS:B1:CAN:DATA:SIZE.....	154
:TRIGger:BUS:B1:CAN:DATA:VALue.....	154
:TRIGger:BUS:B1:LIN:CONDition	155
:TRIGger:BUS:B1:LIN:DATA:QUALifier.....	156
:TRIGger:BUS:B1:LIN:DATA:SIZE	157
:TRIGger:BUS:B1:LIN:DATA:VALue	157
:TRIGger:BUS:B1:LIN:ERRTYPE.....	158
:TRIGger:BUS:B1:LIN:IDentifier:VALue	158

:TRIGger:FREQuency

→ Query

Description	Queries the trigger frequency.
-------------	--------------------------------

Syntax	:TRIGger:FREQuency{?}
Return parameter	<NR3> Returns the trigger frequency.
Example	:TRIGger:FREQuency? 1.032E+3 Returns the trigger frequency.

Set →

→ Query

:TRIGger:TYPE

Description	Sets or queries the trigger type.
Syntax	:TRIGger:TYPE {EDGE DELay PULSEWidth VIDEo RUNT RISEFall LOGic BUS TIMEOut ? }
Parameter	EDGE Edge trigger DELay Delay trigger PULSEWidth Pulse width trigger VIDEo Video trigger RUNT Runt trigger RISEFall Rise and fall trigger BUS Bus trigger TIMEOut Timeout trigger

Return parameter Returns the trigger type.

Example :TRIGger:TYPE EDGE
Sets the trigger type to edge.

Set →

→ Query

:TRIGger:SOURce

Description	Sets or queries the trigger source.
Syntax	:TRIGger:SOURce { CH1 CH2 EXT LINE ? }

Parameter	CH1 to CH2	Channel 1 to channel 2
	EXT	External source
	LINE	AC Line

Return parameter Returns the trigger source.

Example :TRIGger:SOURce CH1
Sets the trigger source to channel 1.

:TRIGger:COUple (Set) →
← (Query)

Description Sets or queries the trigger coupling.

Note Applicable for edge and delay triggers only.

Syntax :TRIGger:COUple {AC | DC | HF | LF | ?}

Parameter	AC	AC mode
	DC	DC mode
	HF	High frequency rejection
	LF	Low frequency rejection

Return parameter Returns the trigger coupling.

Example :TRIGger:COUple AC
Sets the trigger coupling to AC.

:TRIGger:NREJ (Set) →
← (Query)

Description Sets or queries noise rejection status.

Syntax :TRIGger:NREJ {OFF| ON| ?}

Parameter	OFF	Turns noise rejection off
	ON	Turns noise rejection on

Return parameter Returns the noise rejection status (ON, OFF).

Example :TRIGger:NREJ ON
Turns noise rejection on.

Set →
→ Query

:TRIGger:MODE

Description	Sets or queries the trigger mode.	
Syntax	:TRIGger:MODE {AUTo NORMAl ?}	
Parameter	AUTo	Auto trigger (Untriggered roll)
	NORMAl	Normal trigger
Return parameter	Returns the trigger mode.	
Example	:TRIGger:MODE NORMAl Sets the trigger mode to normal.	

Set →
→ Query

:TRIGger:HOLDoff

Description	Sets or queries the holdoff time.	
Syntax	:TRIGger:HOLDoff {<NRf> ?}	
Parameter	<NRf>	Holdoff time
Return parameter	<NR3>	Returns the trigger holdoff time.
Example	:TRIGger:HOLDoff 1.00E-8 Sets the trigger holdoff time to 10ns.	

Set →
→ Query

:TRIGger:LEVel

Description	Sets or queries the level.	
Note	Not applicable to Pulse Runt and Rise & Fall triggers.	
Syntax	:TRIGger:LEVel {TTL ECL SETTO50 <NRf> ?}	
Related commands	:TRIGger:TYPe	
Parameter	<NRf>	Trigger level value.
	TTL	Sets the trigger level to TTL.
	ECL	Sets the trigger level to ECL.

	SETTO50	Sets the trigger level to the User level (50% by default).
Return parameter	<NR3>	Returns the trigger level.
Example1	:TRIGger:LEVel TTL	Sets the trigger to TTL.
Example2	:TRIGger:LEVel 3.30E-1	Sets the trigger level to 330mV/mA.

:TRIGger:HLEVel



Description	Sets or queries the high trigger level.	
Note	Applicable for Rise and Fall/Pulse Runt triggers.	
Syntax	:TRIGger:HLEVel {<NRf> ?}	
Related commands	:TRIGger:TYPe	
Parameter	<NRf>	High level value.
Return parameter	<NR3>	Returns the trigger high level.
Example	:TRIGger:HLEVel 3.30E-1	Sets the trigger high level to 330mV/mA.

:TRIGger:LLEVel



Description	Sets or queries the low trigger level.	
Note	Applicable for Rise and Fall/Pulse Runt triggers.	
Syntax	:TRIGger:LLEVel {<NRf> ?}	
Related commands	:TRIGger:TYPe	
Parameter	<NRf>	Low level value.
Return parameter	<NR3>	Returns the trigger low level.

Example :TRIGger:LLEvel -3.30E-3
 Sets the trigger low level to -330mV/mA.

Set →

:TRIGger:EDGE:SLOP

→ Query

Description Sets or queries the trigger slope.

Syntax :TRIGger:EDGE:SLOP {RISe | FALL | EITHer | ? }

Related commands :TRIGger:TYPe

Parameter	RISe	Rising slope
	FALL	Falling slope
	EITHer	Either rising or falling slope

Return parameter Returns the trigger slope.

Example :TRIGger:EDGE:SLOP FALL
 Sets the trigger slope to falling.

Set →

:TRIGger:DELAy:SLOP

→ Query

Description Sets or queries the trigger slope for the delay trigger.

Syntax :TRIGger:DELAy:SLOP {RISe | FALL | EITHer | ? }

Related commands :TRIGger:TYPe

Parameter	RISe	Rising slope
	FALL	Falling slope
	EITHer	Either rising or falling slope

Return parameter Returns the trigger slope.

Example :TRIGger:DELAy:SLOP FALL
 Sets the trigger slope to falling.

 →
 → 

:TRIGger:DElay:TYPe

Description	Sets or queries the trigger delay type.	
Syntax	:TRIGger:DElay:TYPe {TIME EVENT ?}	
Related commands	:TRIGger:TYPe	
Parameter	TIME	Sets the delay type to time.
	EVENT	Sets the delay type to event.
Return parameter	Returns the trigger delay type.	
Example	:TRIGger:DElay:TYPe TIME Sets the delay type to time delay.	

 →
 → 

:TRIGger:DElay:TIME

Description	Sets or queries the delay time value.	
Syntax	:TRIGger:DElay:TIME {<NRf> ?}	
Related commands	:TRIGger:DElay:TYPe	
Parameter	<NRf>	Delay time (1.00E-8~1.00E+1)
Return parameter	<NR3>	Returns the delay time.
Example	:TRIGger:DElay:TIME 1.00E-6 Sets the delay time to 1us.	

 →
 → 

:TRIGger:DElay:EVENT

Description	Sets or queries the number of events for the event delay trigger.	
Syntax	:TRIGger:DElay:EVENT {<NR1> ?}	
Related commands	:TRIGger:DElay:TYPe	

Parameter	<NR1>	1~65535 events
Return parameter	<NR1>	Returns the number of events.

Example :TRIGger:DELAy:EVENT 2
Sets the number of events to 2.

(Set) →
→ (Query)

:TRIGger:DELAy:LEVel

Description	Sets or queries the trigger delay level.	
Syntax	:TRIGger:DELAy:LEVel {<NRf> ?}	

Parameter	<NRf>	Delay trigger level
Return parameter	<NR3>	Returns the delay trigger.

Example :TRIGger:DELAy:LEVel 5.00E-3
Sets the delay trigger level to 5mV/mA.

(Set) →
→ (Query)

:TRIGger:PULSEWidth:POLarity

Description	Sets or queries the pulse width trigger polarity.	
Syntax	:TRIGger:PULSEWidth:POLarity {POSitive NEGative ?}	

Related commands :TRIGger:TYPe

Parameter	POSitive	Positive polarity
	NEGative	Negative polarity

Return parameter Returns the pulse width polarity.

Example :TRIGger:PULSEWidth:POLarity POSitive
Sets the pulse width polarity to positive.

(Set) →
→ (Query)

:TRIGger:RUNT:POLarity

Description	Sets or queries the Pulse Runt trigger polarity.	
-------------	--	--

Syntax :TRIGger:RUNT:POLarity { POSitive | NEGative | EITher | ? }

Related commands :TRIGger:TYPe

Parameter	POSitive	Positive polarity
	NEGative	Negative polarity
	EITher	Positive or negative polarity

Return parameter Returns the pulse runt trigger polarity.

Example :TRIGger:RUNT:POLarity POSitive
Sets the Pulse Runt trigger polarity to positive.

Set →

→ Query

:TRIGger:RUNT:WHEn

Description Sets or queries the Pulse Runt trigger conditions.

Syntax :TRIGger:RUNT:WHEn { MOREthan | LESSthan | Equal | UNEQual | ? }

Related commands :TRIGger:TYPe
:TRIGger:RUNT:TIME

Parameter	MOREthan	>
	LESSthan	<
	Equal	=
	UNEQual	≠

Return parameter Returns the pulse runt trigger condition.

Example :TRIGger:RUNT:WHEn UNEQual
Sets the Pulse Runt trigger condition to unequal (≠).

Set →

→ Query

:TRIGger:RUNT:TIME

Description Sets or queries the Pulse Runt trigger time.

Syntax :TRIGger:RUNT:TIME {<NRf> | ? }

Related commands	:TRIGger:TYPE	
	:TRIGger:RUNT:WHEn	
Parameter	<NRf>	Pulse runt time (4nS to 10S)
Return Parameter	<NR3>	Returns the runt time in seconds.
Example	:TRIGger:RUNT:TIME 4.00E-5 Sets the runt time to 40.0uS.	

Set →

→ Query

:TRIGger:RISEFall:SLOP

Description	Sets or queries the Rise & Fall slope.	
Syntax	:TRIGger:RISEFall:SLOP {RISe FALL EITHer ?}	
Parameter	RISe	Rising slope
	FALL	Falling slope
	EITHer	Either rising or falling slope
Return parameter	Returns the rise & fall slope.	
Example	:TRIGger:RISEFall:SLOP RISe Sets the Rise & Fall slope to rising.	

Set →

→ Query

:TRIGger:RISEFall:WHEn

Description	Sets or queries the rise/fall trigger conditions.	
Syntax	:TRIGger:RISEFall:WHEn {MOREthan LESSthan EQual UNEQual ?}	
Related commands	:TRIGger:TYPE	
	:TRIGger:RISEFall:TIME	
Parameter	MOREthan	>
	LESSthan	<
	EQual	=
	UNEQual	≠

Return parameter Returns the rise/fall trigger condition.

Example :TRIGger:RISEFall:WHEn UNEQual
 Sets the Rise and Fall trigger condition to unequal (≠).

:TRIGger:RISEFall:TIME



Description	Sets or queries the Rise and Fall time.	
Syntax	:TRIGger:RISEFall:TIME {<NRF> ? }	
Related commands	:TRIGger:TYPe :TRIGger:RISEFall:WHEn	
Parameter	<NRF>	Rise and Fall time (4nS to 10S)
Return Parameter	<NR3>	Returns the rise and fall time in seconds.

Example :TRIGger:RISEFall:TIME 4.00E-5
 Sets the trigger rise & fall to 40.0us.

:TRIGger:VIDeo:TYPe



Description	Sets or queries the video trigger type.	
Syntax	:TRIGger:VIDeo:TYPe {NTSC PAL SECam EDTV480P EDTV576P HDTV720P HDTV1080I HDTV1080P ? }	
Related commands	:TRIGger:TYPe	
Parameter	NTSC	NTSC
	PAL	PAL
	SECam	SECAM
	EDTV480P	Extra definition TV 480P
	EDTV576P	Extra definition TV 576P
	HDTV720P	High definition TV 720P
	HDTV1080I	High definition TV 1080i

HDTV1080P High definition TV 1080P

Return parameter Returns the video trigger type.

Example :TRIGger:VIDeo:TYPe NTSC
Sets the video trigger to NTSC.

Set →

→ Query

:TRIGger:VIDeo:FIELD

Description Sets or queries the video trigger field.

Syntax :TRIGger:VIDeo:FIELD { FIELD1 | FIELD2 | ALLFields | ALLLines | ? }

Related commands :TRIGger:TYPe

Parameter	FIELD1	Trigger on field 1
	FIELD2	Trigger on field 2
	ALLFields	Trigger on all fields
	ALLLines	Trigger on all lines

Return parameter Returns the video trigger field.

Example :TRIGger:VIDeo:FIELD ALLFields
Sets the video trigger to trigger on all fields.

Set →

→ Query

:TRIGger:VIDeo:LINE

Description Sets or queries the video trigger line.

Syntax :TRIGger:VIDeo:LINE {<NR1> | ?}

Related commands :TRIGger:TYPe

Parameter <NR1> Video line

Return parameter <NR3> Returns the video trigger line.

Example :TRIGger:VIDeo:LINE 1
Sets the video trigger to line 1.

Set →
→ Query

:TRIGger:VIDeo:POLarity

Description	Sets or queries the video trigger polarity.	
Syntax	:TRIGger:VIDeo:POLarity { POSitive NEGative ? }	
Related commands	:TRIGger:TYPe	
Parameter	POSitive	Positive polarity
	NEGative	Negative polarity
Return parameter	Returns the video trigger polarity.	
Example	:TRIGger:VIDeo:POLarity POSitive Sets the video trigger polarity to positive.	

Set →
→ Query

:TRIGger:PULSe:WHEn

Description	Sets or queries the pulse width trigger conditions.	
Syntax	:TRIGger:PULSe:WHEn { MOREthan LESSthan EQual UNEQual ? }	
Related commands	:TRIGger:TYPe :TRIGger:PULSe:TIMe	
Parameter	MORE than	>
	LESSthan	<
	EQual	=
	UNEQual	≠
Return parameter	Returns the pulse width trigger conditions.	
Example	:TRIGger:PULSe:WHEn UNEQual Sets the trigger pulse width conditions to not equal to (≠).	

:TRIGger:PULSe:TIME (Set) →
→ (Query)

Description	Sets or queries the pulse width time.	
Syntax	:TRIGger:PULSe:TIME {<NRf> ?}	
Related commands	:TRIGger:TYPe :TRIGger:PULSe:WHEn	
Parameter	<NRf>	Pulse width time (4ns~10s)
Return parameter	<NR3>	Returns the pulse width time in seconds.
Example	:TRIGger:PULSe:TIME 4.00E-5 Sets the trigger pulse width to 40.0us.	

:TRIGger:TIMEOut:WHEn (Set) →
→ (Query)

Description	Sets or queries the timeout trigger condition.	
Syntax	:TRIGger:TIMEOut:WHEn {HIGH LOW EITHer ?}	
Related commands	:TRIGger:TIMEOut:TIMER	
Parameter	HIGH	Signal is high.
	LOW	Signal is low.
	EITHer	Signal is high or low.
Return parameter	Returns the timeout condition (HIGH, LOW, EITHER).	
Example1	:TRIGger:TIMEOut:WHEn LOW Sets the timeout condition to low.	

:TRIGger:TIMEOut:TIMER (Set) →
→ (Query)

Description	Sets or returns timeout trigger time.	
Syntax	:TRIGger:TIMEOut:TIMER {<NRf> ?}	

Related commands	:TRIGger:TIMEOut:WHEn
Parameter	<NRf> Timeout time. (4nS to 10S).
Return parameter	Returns the timeout time as <NR3>.
Example	:TRIGger:TIMEOut:TIMER? 8.960e-05

:TRIGger:STATe → Query

Description	Returns the current state of the triggering system.	
Syntax	:TRIGger:STATe?	
Return parameter	*ARMED	Indicates that the oscilloscope is acquiring pretrigger information.
	*AUTO	Indicates that the oscilloscope is in the automatic mode and acquires data even in the absence of a trigger.
	*READY	Indicates that all pretrigger information has been acquired and that the oscilloscope is ready to accept a trigger.
	*SAVE	Indicates that the oscilloscope is in save mode and is not acquiring data.
	*TRIGGER	Indicates that the oscilloscope triggered and is acquiring the post trigger information.

Example	:TRIGger:STATe? AUTO The trigger is in auto mode.
---------	---

:TRIGger:EXTERnal:PROBE:TYPE Set →
→ Query

Description	Sets or queries the external probe type.
-------------	--

Syntax :TRIGger:EXTERnAl:PROBE:TYPe { VOLTage | CURREnt | ? }

Related commands :TRIGger:EXTERnAl:PROBE:RATio

Parameter	VOLTage	Voltage
	CURREnt	Current

Return parameter Returns the probe type.

Example :TRIGger:EXTERnAl:PROBE:TYPe?
CURRENT

Set →

← Query

:TRIGger:EXTERnAl:PROBE:RATio

Description Sets or queries the external probe ratio (attenuation).

Syntax :TRIGger:EXTERnAl:PROBE:RATio { <NRf> | ? }

Related commands :TRIGger:EXTERnAl:PROBE:TYPe

Parameter	<NRf>	External probe attenuation factor.
-----------	-------	------------------------------------

Return parameter	<NR3>	Returns the probe attenuation factor.
------------------	-------	---------------------------------------

Example :TRIGger:EXTERnAl:PROBE:RATio?
5.000000e+01

← Query

:TRIGger:BUS:TYPe

Description Returns the current bus type.

Syntax :TRIGger:BUS:TYPe?

Return parameter	I2C	I ² C mode
	UART	UART mode
	CAN	CAN mode
	LIN	LIN mode

Example :TRIGger:BUS:TYPe?
UART

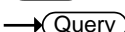
:TRIGger:BUS:THReshold:CH<x>  

Description Sets or queries the threshold level for the selected channel.

Syntax :TRIGger:BUS:THReshold:CH<X> {<NR3> | ?}

<X>	CH1 ~ CH2
<NR3>	Threshold level

Return Parameter <NR3> Returns the threshold level

Example :TRIGger:BUS:THReshold:CH1 1
Sets the CH1 threshold to 1V.

:TRIGger:BUS:B1:I2C:CONDition  

Description Sets or queries the I²C trigger conditions.

Syntax :TRIGger:BUS:B1:I2C:CONDition
{START | STOP | REPEATstart | ACKMISS | ADDRess | DATA | ADDRANDDATA | ? }

Parameter	START	Set Start as the I ² C trigger condition.
	STOP	Set Stop as the I ² C trigger condition.
	REPEATstart	Set Repeat of Start as the I ² C trigger condition.
	ACKMISS	Set Missing Acknowledgement as the I ² C trigger condition.
	ADDRess	Set Address as the I ² C trigger condition.
	DATA	Set Data as the I ² C trigger condition.

ADDRANDDATA	Set Address and Data as the I ² C trigger condition.
-------------	---

Return parameter Returns the I²C bus trigger condition.

Example :TRIGger:BUS:B1:I2C:CONDition ADDRess
Set Address as the I2C trigger condition.

:TRIGger:BUS:B1:I2C:ADDRess:MODE (Set) →
← (Query)

Description Sets or queries the I²C addressing mode (7 or 10 bits).

Syntax :TRIGger:BUS:B1:I2C:ADDRess:MODE {ADDR7 | ADDR10 | ? }

Related commands :TRIGger:BUS:B1:I2C:CONDition

Parameter	ADDR7	7 bit addressing
	ADDR10	10 bit addressing

Return Parameter	0	7 bit addressing
	1	10 bit addressing

Example :TRIGger:BUS:B1:I2C:ADDRess:MODE?
0
The addressing mode is currenty set to 7 bits.

:TRIGger:BUS:B1:I2C:ADDRess:TYPE (Set) →
← (Query)

Description Sets the I²C bus address type, or queries what the setting is.

Syntax :TRIGger:BUS:B1:I2C:ADDRess:TYPE {GENeralcall | STARtbyte | HSmode | EEPROM | CBUS | ? }

Related commands :TRIGger:BUS:B1:I2C:CONDition

Parameter	GENeralcall	Set a general call address (0000 000 0).
	STARtbyte	Set a start byte address. (0000 000 1)

HSmode	Set a high-speed mode address. (0000 1xx x)
EEPROM	Set an EEPROM address. (1010 xxx x)
CBUS	Set a CBUS address. (0000 001 x)

Return Parameter Returns the address type

Example :TRIGger:BUS:B1:I2C:ADDRess:TYPe?
CBUS

:TRIGger:BUS:B1:I2C:ADDRess:VALue  

Description Sets or queries the I²C bus address value when the I²C bus is set to trigger on Address or Address/Data.

Syntax :TRIGger:BUS:B1:I2C:ADDRess:VALue {<string> | ? }

Related commands :TRIGger:BUS:B1:I2C:ADDRess:MODe

Parameter <sting> 7/10 characters, must be enclosed in double quotes, "string".
x = don't care
1 = binary 1
0 = binary 0

Return Parameter Returns the address value.

Example1 :TRIGger:BUS:B1:I2C:ADDRess:MODe ADDR7
:TRIGger:BUS:B1:I2C:ADDRess:VALue "xxx0101"
Sets the address to XXX0101

Example 2 :TRIGger:BUS:B1:I2C:ADDRess:VALue?
XXX0101

:TRIGger:BUS:B1:I2C:ADDRess:DIRection





Description	Sets or queries the address bit as read write or don't care.	
Note	This setting only applies when the I ² C trigger is set to trigger on Address or Address/Data	
Syntax	:TRIGger:BUS:B1:I2C:ADDRess:DIRection { READ WRITE NOCARE ? }	
Related commands	:TRIGger:BUS:B1:I2C:CONDition	
Parameter	READ	Set read as the data direction.
	WRITE	Set write as the data direction.
	NOCARE	Set either as the data direction.
Return Parameter	Returns the direction (READ, WRITE, NOCARE).	
Example	:TRIGger:BUS:B1:I2C:ADDRess:DIRection READ Sets the direction to READ.	

:TRIGger:BUS:B1:I2C:DATA:SIZE

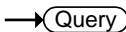

Description	Sets or queries the data size in bytes for the I ² C bus.	
Note	This setting only applies when the I ² C trigger is set to trigger on Data or Address/Data	
Syntax	:TRIGger:BUS:B1:I2C:DATA:SIZE {<NR1> ? }	
Related commands	:TRIGger:BUS:B1:I2C:CONDition	
Parameter	<NR1>	Number of data bytes (1 to 5).
Return parameter	<NR1>	Returns the number of bytes.
Example	:TRIGger:BUS:B1:I2C:DATA:SIZE 3 Sets the number of bytes to 3.	

		 → 
:TRIGger:BUS:B1:I2C:DATa:VALue		
Description	Sets or queries the triggering data value for the I ² C bus when the I ² C bus is set to trigger on Data or Address/Data.	
Syntax	:TRIGger:BUS:B1:I2C:DATa:VALue {<string> ? }	
Related commands	:TRIGger:BUS:B1:I2C:DATa:SIZE	
Parameter	<sting>	The number of characters in the string depends on the data size setting. The string must be enclosed in double quotes, "string". x = don't care 1 = binary 1 0 = binary 0
Return Parameter	Returns the data value.	
Example1	:TRIGger:BUS:B1:I2C:DATa:SIZE 1 :TRIGger:BUS:B1:I2C:DATa:VALue "1x1x0101" Sets the value to XXX0101	
Example 2	:TRIGger:BUS:B1:I2C:DATa:VALue? 1X1X0101	

		 → 
:TRIGger:BUS:B1:UART:CONDition		
Description	Sets or queries the UART triggering condition.	
Syntax	:TRIGger:BUS:B1:UART:CONDition { RXSTArt RXDATA RXENDPacket TXSTArt TXDATA TXENDPacket TXPARItYerr RXPARItyerr ? }	
Parameter	RXSTArt	Set trigger on the RX Start Bit.
	RXDATA	Set trigger on RX Data.

RXENDPacket	Set trigger on the RX End of Packet condition.
RXPARTyerr	Set trigger on RX Parity error condition.
TXSTArt	Set trigger on the TX Start Bit.
TXDATA	Set trigger on TX Data.
TXENDPacket	Set trigger on the TX End of Packet condition.
TXPARTyerr	Set trigger on TX Parity error condition.

Return Parameter Returns the triggering condition.

Example :TRIGger:BUS:B1:UART:CONDition TXDATA
Sets the UART bus to trigger on Tx Data.

:TRIGger:BUS:B1:UART:RX:DATA:SIZE (Set) →
→ (Query)

Description Sets or queries the number of bytes for UART data.

Note This setting only applies when the UART trigger is set to trigger on Rx Data

Syntax :TRIGger:BUS:B1:UART:RX:DATA:SIZE {<NR1> | ?}

Related commands :TRIGger:BUS:B1:UART:CONDition

Parameter <NR1> Number of bytes (1 to 10).

Return parameter <NR1> Returns the number of bytes.

Example :TRIGger:BUS:B1:UART:RX:DATA:SIZE 5
Sets the number of bytes to 5.

:TRIGger:BUS:B1:UART:RX:DATA:VALue (Set) →
→ (Query)

Description Sets or queries the triggering data value for the UART bus when the bus is set to trigger on Rx Data.

Syntax :TRIGger:BUS:B1:UART:RX:DATA:VALue {<string> | ? }

Related commands :TRIGger:BUS:B1:UART:RX:DATA:SIZE

Parameter	<sting>	The number of characters in the string depends on the data size setting. The string must be enclosed in double quotes, "string". x = don't care 1 = binary 1 0 = binary 0
-----------	---------	--

Return Parameter Returns the data value.

Example1 :TRIGger:BUS:B1:UART:CONDition RXDATA
 :TRIGger:BUS:B1:UART:RX:DATA:SIZE 1
 :TRIGger:BUS:B1:UART:RX:DATA:VALue "1x1x0101"
 Sets the value to 1x1x0101

Example 2 :TRIGger:BUS:B1:UART:RX:DATA:VALue?
 1X1X0101

:TRIGger:BUS:B1:UART:TX:DATA:SIZE 

Description Sets or queries the number of bytes for UART data.

Note This setting only applies when the UART trigger is set to trigger on Tx Data

Syntax :TRIGger:BUS:B1:UART:TX:DATA:SIZE {<NR1> | ? }

Related commands :TRIGger:BUS:B1:UART:CONDition

Parameter	<NR1>	Number of bytes (1 to 10).
-----------	-------	----------------------------

Return parameter	<NR1>	Returns the number of bytes.
------------------	-------	------------------------------

Example :TRIGger:BUS:B1:UART:TX:DATA:SIZE 5
 Sets the number of bytes to 5.

:TRIGger:BUS:B1:UART:TX:DATA:VALue (Set) →
→ (Query)

Description Sets or queries the triggering data value for the UART bus when the bus is set to trigger on Tx Data.

Syntax :TRIGger:BUS:B1:UART:TX:DATA:VALue {<string> | ? }

Related commands :TRIGger:BUS:B1:UART:TX:DATA:SIZE

Parameter	<code><sting></code>	The number of characters in the string depends on the data size setting. The string must be enclosed in double quotes, "string". x = don't care 1 = binary 1 0 = binary 0
------------------	----------------------------	--

Return Parameter Returns the data value.

Example1 :TRIGger:BUS:B1:UART:CONDition TXDATA
:TRIGger:BUS:B1:UART:TX:DATA:SIZE 1
:TRIGger:BUS:B1:UART:TX:DATA:VALue "1x1x0101"
Sets the value to 1x1x0101

Example 2 :TRIGger:BUS:B1:UART:TX:DATA:VALue?
1X1X0101

:TRIGger:BUS:B1:CAN:CONDition (Set) →
→ (Query)

Description Sets or returns the CAN trigger condition.

Syntax :TRIGger:BUS:B1:CAN:CONDition {SOF|FRAMetype|IDentifier|DATA|IDANDDATA|EOF|ACKMISS|STUFFERR|?}

Parameter/ Return parameter	<code>SOF</code> <code>FRAMetype</code>	Triggers on a start of frame Triggers on the type of frame
--	--	---

Identifier	Triggers on a matching identifier
DATA	Triggers on matching data
IDANDDATA	Triggers on matching identifier and data field
EOF	Triggers on the end of frame
ACKMISS	Triggers on a missing acknowledge
STUFFERR	Triggers on a bit stuffing error

Example1 :TRIGger:BUS:B1:CAN:CONDition SOF
Triggers on a start of frame.

Example2 :TRIGger:BUS:B1:CAN:CONDition?
>SOF

:TRIGger:BUS:B1:CAN:FRAMeType  

Description Sets or returns the frame type for a CAN FRAMeType trigger.

Syntax :TRIGger:BUS:B1:CAN:FRAMeType
{DATA|REMOte|ERRor|OVERLoad|?}

Parameter/ Return parameter	DATA	Sets the frame type to data frame
	REMOte	Sets the frame type to remote frame
	ERRor	Sets the frame type to error frame
	OVERLoad	Sets the frame type to overload

Example :TRIGger:BUS:B1:CAN:FRAMeType DATA
Sets the frame type to DATA.

:TRIGger:BUS:B1:CAN:IDentifier:MODE  

Description Sets or returns the CAN identifier mode for the bus.

Syntax :TRIGger:BUS:B1:CAN:IDentifier:MODE
{STANDard|EXTended|?}

Parameter/	STANDard	Standard addressing mode
Return parameter	EXTended	Extended addressing mode

Example :TRIGger:BUS:B1:CAN:IDentifier:MODE?>STANDARD
Returns the addressing mode.

:TRIGger:BUS:B1:CAN:IDentifier:VALue (Set) →
← (Query)

Description Sets or returns the identifier string used for the CAN trigger.
Note: Only applicable when the trigger condition is set to ID or IDANDDATA.

Syntax :TRIGger:BUS:B1:CAN:IDentifier:VALue {<string>|?}

Related Commands :TRIGger:BUS:B1:CAN:IDentifier:MODE

Parameter/	<string>	The size of the string depends on the data size setting. The string must be enclosed in double quotes, "string". String contents: x = don't care 1 = binary 1 0 = binary 0
Return parameter		

Example :TRIGger:BUS:B1:CAN:CONDition ID
:TRIGger:BUS:B1:CAN:IDentifier:MODE STANDARD
:TRIGger:BUS:B1:CAN:IDentifier:VALue "01100X1X01X"
:TRIGger:BUS:B1:CAN:IDentifier:VALue?>01100X1X01X

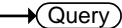
 →
 → 

:TRIGger:BUS:B1:CAN:IDentifier:DIRection

Description	Sets or queries the address bit as read, write or don't care.	
Syntax	:TRIGger:BUS:B1:CAN:IDentifier:DIRection {READ WRITE NOCARE ?}	
Parameter/ Return parameter	READ	Sets read as the data direction
	WRITE	Sets write as the data direction
	NOCARE	Sets either as the data direction
Example1	:TRIGger:BUS:B1:CAN:IDentifier:DIRection? >WRITE	
Example2	:TRIGger:BUS:B1:CAN:IDentifier:DIRection READ :TRIGger:BUS:B1:CAN:IDentifier:DIRection? > READ	

 →
 → 

:TRIGger:BUS:B1:CAN:DATA:QUALifier

Description	Sets or returns the CAN data qualifier. Note: Only applicable when the triggering condition is set to DATA or IDANDDATA.	
Syntax	:TRIGger:BUS:B1:CAN:DATA:QUALifier {LESSthan MOREthan Equal UNEQual LESSEQual MOREEqual ?}	
Parameter/ Return parameter	LESSthan	Triggers when the data is less than the qualifier value.
	MOREthan	Triggers when the data is greater than the qualifier value.
	Equal	Triggers when the data is equal to the qualifier value.
	UNEQual	Triggers when the data is not equal to the qualifier value.

LESSEQual	Triggers when the data is less than or equal to the qualifier value.
MOREEqual	Triggers when the data is more than or equal to the qualifier value.

Example :TRIGger:BUS:B1:CAN:DATA:QUALifier?>EQUAL
 :TRIGger:BUS:B1:CAN:DATA:QUALifier MOREthan
 :TRIGger:BUS:B1:CAN:DATA:QUALifier?>MOREthan

(Set) →

:TRIGger:BUS:B1:CAN:DATA:SIZE

→ (Query)

Description Sets or returns the length of the data string in bytes for a CAN trigger.
 Note: Only applicable when the condition is set to DATA or IDANDDATA.

Syntax :TRIGger:BUS:B1:CAN:DATA:SIZE {<NR1>|?}

Parameter/ Return parameter	<NR1>	1~8 (bytes)
--------------------------------	-------	-------------

Example :TRIGger:BUS:B1:CAN:DATA:SIZE?>1
 :TRIGger:BUS:B1:CAN:DATA:SIZE 2
 :TRIGger:BUS:B1:CAN:DATA:SIZE?>2

(Set) →

:TRIGger:BUS:B1:CAN:DATA:VALue

→ (Query)

Description Sets or returns the binary data string to be used for a CAN trigger.
 Note: Only applicable when the condition is set to DATA or IDANDDATA.

Related Commands :TRIGger:BUS:B1:CAN:DATA:SIZE

Syntax :TRIGger:BUS:B1:CAN:DATA:VALue {<string>|?}

Parameter/ Return parameter	<string>	The size of the string depends on the data size setting. The string must be enclosed in double quotes, "string". String contents: x = don't care 1 = binary 1 0 = binary 0
--------------------------------	----------	--

Example

```
:TRIGger:BUS:B1:CAN:DATA:SIZE 1
:TRIGger:BUS:B1:CAN:DATA:VALue "01010X1X"
:TRIGger:BUS:B1:CAN:DATA:VALue?
>01010X1X
```

Set →
 → Query

:TRIGger:BUS:B1:LIN:CONDition

Description Sets or returns the LIN trigger condition.

Syntax

```
:TRIGger:BUS:B1:LIN:CONDition
{SYNCFIELD|IDENTIFIER|DATA|IDANDDATA|WAKEUP|
SLEEP|ERROR|?}
```

Parameter/ Return parameter	SYNCFIELD	Sets the LIN trigger condition to the sync field.
	IDENTIFIER	Sets the LIN trigger condition to identifier field.
	DATA	Sets the LIN trigger condition to the data field.
	IDANDDATA	Sets the LIN trigger condition to identifier and data field
	WAKEUP	Sets the LIN trigger condition to wake up.
	SLEEP	Sets the LIN trigger condition to sleep.
	ERROR	Sets the LIN trigger condition to error.

```
Example      :TRIGger:BUS:B1:LIN:CONDition?
              >IDANDDATA
              :TRIGger:BUS:B1:LIN:CONDition DATA
              :TRIGger:BUS:B1:LIN:CONDition?
              >DATA
```

```
:TRIGger:BUS:B1:LIN:DATA:QUALifier
```

Set

→

Query

Description Sets or returns the LIN data qualifier.
 Note: Only applicable when the trigger condition is set to DATA or IDANDDATA.

Syntax :TRIGger:BUS:B1:LIN:DATA:QUALifier
 {LESSthan|MOREthan|EQUAL|UNEQUAL|LESSEQUAL|M
 OREEQUAL?}

Parameter/ Return parameter	LESSthan	Triggers when the data is less than the qualifier value.
	MOREthan	Triggers when the data is greater than the qualifier value.
	EQUAL	Triggers when the data is equal to the qualifier value.
	UNEQUAL	Triggers when the data is not equal to the qualifier value.
	LESSEQUAL	Triggers when the data is less than or equal to the qualifier value.
	MOREEQUAL	Triggers when the data is more than or equal to the qualifier value.

```
Example      :TRIGger:BUS:B1:LIN:DATA:QUALifier?
              >EQUAL
              :TRIGger:BUS:B1:LIN:DATA:QUALifier MOREthan
              :TRIGger:BUS:B1:LIN:DATA:QUALifier?
              >MORETHAN
```

		Set →
		← Query
:TRIGger:BUS:B1:LIN:DATA:SIZE		
Description	Sets or returns the length of the data string in bytes for the LIN trigger. Note: Only applicable when the condition is set to DATA or IDANDDATA.	
Syntax	:TRIGger:BUS:B1:LIN:DATA:SIZE {<NR1> ?}	
Parameter/ Return parameter	<NR1>	1~8 (bytes)
Example	:TRIGger:BUS:B1:LIN:DATA:SIZE? >1 :TRIGger:BUS:B1:LIN:DATA:SIZE 2 :TRIGger:BUS:B1:LIN:DATA:SIZE? >2	

		Set →
		← Query
:TRIGger:BUS:B1:LIN:DATA:VALue		
Description	Sets or returns the binary data string to be used for the LIN trigger. Note: Only applicable when the condition is set to DATA or IDANDDATA.	
Related Commands	:TRIGger:BUS:B1:LIN:DATA:SIZE	
Syntax	:TRIGger:BUS:B1:LIN:DATA:VALue {<string> ?}	
Parameter/ Return parameter	<string>	The size of the string depends on the data size setting. The string must be enclosed in double quotes, "string". String contents: x = don't care 1 = binary 1 0 = binary 0

```
Example      :TRIGger:BUS:B1:LIN:DATA:SIZE 1
              :TRIGger:BUS:B1:LIN:DATA:VALue "01010X1X"
              :TRIGger:BUS:B1:LIN:DATA:VALue?
              >01010X1X
```

Set →

→ Query

:TRIGger:BUS:B1:LIN:ERRTYPE

Description Sets or returns the error type be used for the LIN trigger.

Syntax :TRIGger:BUS:B1:LIN:ERRTYPE
 {SYNC|PARity|CHECKsum|?}

Parameter/ Return parameter	SYNC	Sets the LIN error type to SYNC.
	PARity	Sets the LIN error type to parity.
	CHECKsum	Sets the LIN error type to checksum.

```
Example      :TRIGger:BUS:B1:LIN:ERRTYPE?
              >SYNC
              :TRIGger:BUS:B1:LIN:ERRTYPE CHECKSUM
              :TRIGger:BUS:B1:LIN:ERRTYPE?
              >CHECKSUM
```

Set →

→ Query

:TRIGger:BUS:B1:LIN:IDentifier:VALue

Description Sets or returns the identifier string to be used for the LIN trigger.

 Note: Only applicable when the condition is set to ID or IDANDDATA.

Syntax :TRIGger:BUS:B1:LIN:IDentifier:VALue {<string>|?}

Parameter/ Return parameter	<string>	The size of the string depends on the data size setting. The string must be enclosed in double quotes, "string".

String contents:

x = don't care

1 = binary 1

0 = binary 0

Example :TRIGger:BUS:B1:LIN:CONDition ID
 :TRIGger:BUS:B1:LIN:IDentifier:VALue "00X1X01X"
 :TRIGger:BUS:B1:LIN:IDentifier:VALue?
 >01100X1X01X
 :TRIGger:LOGic:INPut:CLOCK:SOURce

System Commands

:SYSTem:LOCK	160
:SYSTem:ERRor	160

:SYSTem:LOCK



Description	Turns the panel lock on off.	
Syntax	:SYSTem:LOCK {OFF ON ? }	
Parameter	OFF	System lock off
	ON	System lock on
Return parameter	Returns the status of the panel lock (ON, OFF).	
Example	:SYSTem:LOCK ON Turns the panel lock on.	

:SYSTem:ERRor



Description	Queries the error queue. See the appendix on page 296 for details.	
Syntax	:SYSTem:ERRor?	
Return parameter	Returns the last message in the error queue.	
Example	:SYSTem:ERRor? +0, "No error."	

Save/Recall Commands

:RECALL:SETUp	161
:RECALL:WAVEform	161
:SAVe:IMAGe	162
:SAVe:IMAGe:FILEFormat	162
:SAVe:IMAGe:INKSaver	163
:SAVe:SETUp	163
:SAVe:WAVEform	164
:SAVe:WAVEform:FILEFormat	165

:RECALL:SETUp



Description	Recalls setup settings from memory or USB.	
Syntax	:RECALL:SETUp {S1~S20 <file path>("Disk:/xxx.SET", "USB:/xxx.SET")}	
Parameter	S1~S20	Recall Set1~Set20
	<file path>	Recall a file from the DSO internal files system or from a USB flash drive.
Example	:RECALL:SETUp S1 Recalls setup setting S1 from memory. :RECALL:SETUp "Disk:/DS0001.SET" Recall the setup setting DS0001.SET from the internal memory.	

:RECALL:WAVEform



Description	Recalls a waveform from wave1~wave20 or from file to REF1~4.
Note	Detail CSV files cannot be recalled.
Syntax	:RECALL:WAVEform {W<n> <file path> ("Disk:/xxx.LSF", "USB:/xxx.LSF")}, REF<X>

Parameter	n	1~20 (Wave1~wave20)
	<file page>	Filename in file path. Example: "Disk:/xxx.LSF", "USB:/xxx.LSF", "Disk:/xxx.CSV", "USB:/xxx.CSV"
	<X>	1,2,3,4 (REF1, REF2, REF3, REF4)

Example :RECALL:WAVEform W1, REF1
 Recalls the waveform stored in Wave1 to reference 1.

:SAVE:IMAGe



Description	Saves a screen image to the assigned file path with a specified filename.	
Syntax	:SAVE:IMAGe {<file path> ("Disk:/xxx.PNG", "USB:/xxx.BMP")}	
Related commands	:SAVE:IMAGe:FILEFormat :SAVE:IMAGe:INKSaver	
Parameter	xxx.PNG or xxx.BMP	File name (8 characters max)

Example :SAVE:IMAGe "Disk:/pic1.PNG"
 Saves a screen image named pic1.png to the root directory (Disk:/) of the scope.
 :SAVE:IMAGe "USB:/pic1.BMP"
 Saves a screen image named pic1.bmp to the root directory of the external USB flash disk.

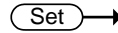

:SAVE:IMAGe:FILEFormat



Description	Sets the file format for image.	
Syntax	:SAVE:IMAGe:FILEFormat {PNG BMP ?}	
Related commands	:SAVE:IMAGe :SAVE:IMAGe:INKSaver	

Parameter	PNG	Sets the file format to PNG
	BMP	Sets the file format to BMP
Return parameter	Returns the file format (PNG, BMP).	
Example	:SAVE:IMAGE:FILEFormat PNG Sets the image file format to PNG.	

:SAVe:IMAGe:INKSaver

Set →

← Query

Description	Turns Ink Saver on or off.	
Syntax	:SAVe:IMAGe:INKSaver {OFF ON ?}	
Related commands	:SAVe:IMAGe :SAVe:IMAGe:FILEFormat	
Parameter	OFF	Turns Inksaver off.
	ON	Turns Inksaver on.
Return parameter	Returns Ink Saver status (ON, OFF).	
Example	:SAVe:IMAGe:INKSaver ON Turns Ink Saver on.	

:SAVe:SETUp

Set →

Description	Saves the current setup to internal memory (Set1~Set20) or the designated file path.	
Syntax	:SAVe:SETUp {<file path> ("Disk:/xxx.SET", "USB:/xxx.SET) S1~S20}	
Parameter	S1~S20	Saves the setup to Set1~Set20
	File path	Saves the setup to disk to the specified file path.

Example :SAVE:SETUp S1
 Saves the current setup to Set1 in internal memory.
 :SAVE:SETUp "Disk:/DS0001.SET"
 Saves the current setup to DS0001.SET in the root
 directory of the internal memory.

:SAVE:WAVEform



Description Saves a waveform to internal memory or to a
 designated file path.

Related commands :SAVE:WAVEform:FILEFormat

Syntax :SAVE:WAVEform {CH1~REF4, REF<X> } |
 {CH1~REF4, W1~W20} | {CH1~ALL, file path}

Parameter	CH1~REF4,	CH1~CH2, Math, REF1~4
	<X>	1,2,3,4 (REF1, REF2, REF3, REF4)
	W1~W20	Wave1~Wave20
	ALL	All the displayed waveforms on screen.
	File path	Saves the waveform(s) to disk or USB to the specified file path. (LSF or CSV, but note that detail CSV can't be recalled to the scope.)

Example 1 :SAVE:WAVEform CH1, REF2
 Saves the channel1 waveform to REF2.

Example 2 :SAVE:WAVEform:FILEFormat LSF
 :SAVE:WAVEform ALL, "Disk:/ALL001"
 Sets the file format to LSF. A folder named
 "ALL001" is created and saves all displayed
 waveforms to the "ALL001" directory in the LSF
 format.

Example 3 :SAVe:WAVEform:FILEFormat FCSV
 :SAVe:WAVEform ALL, "Disk:/ALL002"
 Sets the file format to FCSV (fast CSV format). It then saves the all channel's waveforms to the root directory (Disk:/) of the internal flash disk in the CSV format (with the filename ALL002.CSV).

Example 4 :SAVe:WAVEform:FILEFormat LSF
 :SAVe:WAVEform CH2, "Disk:/DS0003.LSF"
 Save the channel 2's waveform to the root directory (Disk:/) of the internal flash disk in the LSF format with DS0003.LSF as the filename.

:SAVe:WAVEform:FILEFormat



Description	Sets the waveform savefile format.	
Syntax	:SAVe:WAVEform:FILEFormat {LSF DCSV FCSV ?}	
Parameter	LSF	Sets the file format to the MPO-2000's internal file format, LSF. (xxx.LSF)(no support LA)
	DCSV	Sets the file format to detail CSV. (xxx.CSV)
	FCSV	Sets the file format to fast CSV. (xxx.CSV)
Return parameter	Returns the file format (LSF, DCSV, FCSV).	

Example :SAVe:WAVEform:FILEFormat LSF
 Sets the file format to LSF.

Ethernet Command

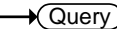
		
		
<hr/>		
Description	Sets or queries the DHCP settings.	
Syntax	:ETHERnet:DHCP { OFF ON ? }	
Parameter	ON	Turns DHCP on.
	OFF	Turns DHCP off.
<hr/>		
Example	:ETHERnet:DHCP ON Turns DHCP on.	

Time Command

:DATE



Description Sets the system date and time.

Syntax :DATE {<string>}

Parameter	<string>	"YYYYMMDDhhmmss"
-----------	----------	------------------

Where:
YYYY: year
MM: month
DD: day
hh: hour
mm: minute
ss: second

Example :DATE "20140802142830"
Sets the time and date as:
Year: 2014, Month: 08, Day: 02, Hour: 14 (2PM),
Minute: 28, Second: 30.

Bus Decode Commands

:BUS1	168
:BUS1:STATE	169
:BUS1:TYPE	169
:BUS1:INPut	170
:BUS1:I2C:ADDReSS:RWINClude	170
:BUS1:I2C:SCLK:SOURce	170
:BUS1:I2C:SDA:SOURce	171
:BUS1:UART:BITRate.....	171
:BUS1:UART:DATABits.....	171
:BUS1:UART:PARlty.....	172
:BUS1:UART:PACKEt	172
:BUS1:UART:POLARity	172
:BUS1:UART:EOFPacket	173
:BUS1:UART:TX:SOURce	173
:BUS1:UART:RX:SOURce	173
:BUS1:DISPlay:FORMAt.....	174
:LISTer:DATA	174
:BUS1:CAN:SOURce.....	174
:BUS1:CAN:PROBe.....	175
:BUS1:CAN:SAMPLEpoint.....	175
:BUS1:CAN:BITRate	176
:BUS1:LIN:BITRate	176
:BUS1:LIN:IDFORmat	177
:BUS1:LIN:POLARity	177
:BUS1:LIN:SAMPLEpoint	177
:BUS1:LIN:SOURce	178
:BUS1:LIN:STANDard	178

:BUS1

→ Query

Description

Returns the supported BUS types.

Syntax :BUS1?

Return Parameter Returns the supported bus types.

Example BUS1?
I2C, UART, CAN, LIN

Set →

→ Query

:BUS1:STATE

Description Sets or queries the state of the bus.

Syntax :BUS1:STATE { OFF | ON | ? }

Related commands :BUS1:TYPe

Parameter/Return parameter	OFF	Turns the bus off.
	ON	Turns the bus on.

Example :BUS1:STATE ON
Turns the bus on.

Set →

→ Query

:BUS1:TYPe

Description Sets or queries the type of bus.

Syntax :BUS1:TYPe { UART | I2C | CAN | LIN | ? }

Related commands :BUS1:STATE

Parameter/Return parameter	UART	Sets the bus to UART mode.
	I2C	Sets the bus to I ² C mode.
	CAN	Sets the bus to CAN mode.
	LIN	Sets the bus to LIN mode.

Example :BUS1:TYPe LIN
Sets the bus to LIN mode.

Set →
 → Query

:BUS1:INPut		
Description	Sets or returns the bus source.	
Syntax	:BUS1:INPut {ANALog ?}	
Parameter/Return parameter	ANALog	Sets the bus source as analog inputs.
Example1	:BUS1:INPut? >ANALOG	

Set →
 → Query

:BUS1:I2C:ADDResS:RWINClude		
Description	Sets or queries whether the read/write bit is included in the I ² C address.	
Syntax	:BUS1:I2C:ADDResS:RWINClude { OFF ON ? }	
Related commands	:BUS1:STATE	
Parameter	OFF	The R/W bit is not included.
	ON	The R/W bit is included.
Return parameter	0	The R/W bit is not included.
	1	The R/W bit is included.
Example	:BUS1:I2C:ADDResS:RWINClude ON Includes the R/W bit in the I ² C address.	

Set →
 → Query

:BUS1:I2C:SCLK:SOURce		
Description	Sets or queries which channel is used for the I ² C SCLK source.	
Syntax	:BUS1:I2C:SCLK:SOURce { CH1 CH2 ? }	
Parameter/Return parameter	CH1 to CH2	Analog channels 1 ~ 2.

Example :BUS1:I2C:SCLK:SOURce CH1
Sets channel 1 as the SCLK source.

:BUS1:I2C:SDA:SOURce Set →
← Query

Description Sets or queries which channel is used for the I²C SDA source.

Syntax :BUS1:I2C:SDA:SOURce{CH1| CH2| ? }

Parameter/Return parameter CH1 to CH2 Analog channels 1 ~ 2.

Example :BUS1:I2C:SDA:SOURce CH1
Sets channel 1 as the SDA source.

:BUS1:UART:BITRate Set →
← Query

Description Sets or queries the UART bit rate.

Syntax :BUS1:UART:BITRate {<NR1> | ? }

Parameter/Return parameter <NR1> UART bit rate in bps

Example :BUS1:UART:BITRate?
>2400
:BUS1:UART:BITRate 50
:BUS1:UART:BITRate?
>50

:BUS1:UART:DATABits Set →
← Query

Description Sets or queries the number UART data for bus 1.

Syntax :BUS1:UART:DATABits { 5 | 6 | 7 | 8 | 9 | ? }

Parameter/Return parameter 5 5 data bits in the UART frame.
6 6 data bits in the UART frame.
7 7 data bits in the UART frame.

8 8 data bits in the UART frame.

Example :BUS1:UART:DATABits 7
Sets the UART frame to 7 bits.

Set →

:BUS1:UART:PARity

→ Query

Description Sets or queries the UART bus parity.

Syntax :BUS1:UART:PARity { <NR1> | ? }

Parameter/Return parameter <NR1> 0: None
1: Odd parity
2: Even parity

Example :BUS1:UART:PARity 1
Sets the parity to odd.

Set →

:BUS1:UART:PACKet

→ Query

Description Sets or queries the UART packet setting.

Syntax :BUS1:UART:PACKet {<NR1> | ? }

Parameter/Return parameter <NR1> 0: Off
1: On

Example :BUS1:UART:PACKet 1
Turns UART packets on.

Set →

:BUS1:UART:POLARity

→ Query

Description Sets or returns the UART polarity.

Syntax :BUS1:UART: POLARity {NORMal|INVerted}
:BUS1:UART: POLARity?

Parameter NORMal Sets normal UART polarity.
INVerted Sets inverted UART polarity.

Example :BUS1:UART:POLARity NORMAl
 :BUS1:UART:POLARity?
 NORMAL

Set →

← Query

:BUS1:UART:EOFPacket

Description Sets or queries the EOF character for the UART packet setting.

Syntax :BUS1:UART:EOFPacket <NR1>

Parameter/Return parameter	<NR1>	0: NULL 1: LF (line feed) 2: CR (carriage return) 3: SP (space character) 4: FF
----------------------------	-------	---

Example :BUS1:UART:EOFPacket 2
 Sets the OEF character to CR.

Set →

← Query

:BUS1:UART:TX:SOURce

Description Sets or queries which channel is used for the UART Tx source.

Syntax :BUS1:UART:TX:SOURce { OFF | CH1 | CH2 | ? }

Parameter/Return parameter	OFF	Off, no Tx source
	CH1 to CH2	Analog channels CH1 to CH2

Example :BUS1:UART:TX:SOURce CH1
 Sets channel 1 as the Tx source.

Set →

← Query

:BUS1:UART:RX:SOURce

Description Sets or queries which channel is used for the UART Rx source.

Syntax	:BUS1:UART:RX:SOURce { OFF CH1 CH2 ? }	
Parameter/Return parameter	OFF	Off, no Rx source
	CH1 to CH2	Analog channels CH1 to CH2
Example	:BUS1:UART:RX:SOURce CH1 Sets channel 1 as the Rx source.	

Set →

→ Query

:BUS1:DISPlay:FORMAt

Description	Sets or queries the display format for the bus, either binary or hexadecimal.	
Syntax	:BUS1:DISPlay:FORMAt { BINary HEXadecimal ASCII ? }	
Parameter/Return parameter	BINary	Binary format
	HEXadecimal	Hexadecimal format
Example	:BUS1:DISPlay:FORMAt BINary Sets the display format to binary.	

:LISTer:DATA

→ Query

Description	Returns the Event Table data as a binary block data.	
Syntax	:LISTer:DATA?	
Return Parameter	Returns the event table as binary block data. The binary block data contains comma separated data with new lines at the end of each row.	

Set →

→ Query

:BUS1:CAN:SOURce

Description	Sets or returns the CAN input source.	
Syntax	:BUS1:CAN:SOURce { CH1 CH2 ? }	
Parameter/Return parameter	CH1 ~ CH2	Analog channel source

Example :BUS1:CAN:SOURCE?
>CH1
Returns the CAN source.

Set →

→ Query

:BUS1:CAN:PROBe

Description Sets or returns the signal type of the CAN bus.

Syntax :BUS1:CAN:PROBe {CANH | CANL | TX | RX | ? }

Parameter/Return parameter	CANH	CAN-High
	CANL	CAN-Low
	TX	Transmit
	RX	Receive

Example :BUS1:CAN:PROBe?
>CANH
:BUS1:CAN:PROBe CANL
:BUS1:CAN:PROBe?
>CANL

:BUS1:CAN:SAMPLEpoint

→ Query

Description Returns the sample point of the CAN bus.

Syntax :BUS1:CAN:SAMPLEpoint?

Return Parameter Returns the sample point of the CAN bus as a percentage of the bit time.

Example :BUS1:CAN:SAMPLEpoint?
50
Returns the sample point as a percentage.

Set →

→ Query

:BUS1:CAN:BITRate

Description	Sets or returns the bit rate of the CAN bus.	
Syntax	:BUS1:CAN:BITRate {RATE10K RATE20K RATE50K RATE125K RATE250K RATE500K RATE800K RATE1M <NR1> ?}	
Parameter/Return parameter	RATE10K	10 kbps
	RATE20K	20 kbps
	RATE50K	50 kbps
	RATE125K	125 kbps
	RATE250K	250 kbps
	RATE500K	500 kbps
	RATE800K	800 kbps
	RATE1M	1 Mbps
	<NR1>	CAN bit rate in bps

Example

```
:BUS1:CAN:BITRate?
>1000000

:BUS1:CAN:BITRate rate800k
:BUS1:CAN:BITRate?
>800000

:BUS1:CAN:BITRate 25000
:BUS1:CAN:BITRate?
>25000
```

Set →

→ Query

:BUS1:LIN:BITRate

Description	Sets or returns the bit rate of the LIN bus.	
Syntax	:BUS1:LIN:BITRate {<NR1> ?}	
Parameter/Return parameter	<NR1>	LIN bit rate in bps.

Example :BUS1:LIN:BITRate 9600
Sets the LIN bit rate to 9600bps.

:BUS1:LIN:IDFORmat (Set) →
→ (Query)

Description Sets or returns the LIN ID format.

Syntax :BUS1:LIN:IDFORmat {NOPARity|PARity|?}

Parameter/Return parameter	NOPARity	Don't include parity bits with Id.
	PARity	Include parity bits with Id.

Example :BUS1:LIN:IDFORmat?
NOPARITY
Returns the ID format.

:BUS1:LIN:POLARity (Set) →
→ (Query)

Description Sets or returns the LIN polarity.

Syntax :BUS1:LIN:POLARity {NORMAL|INVerted|?}

Parameter/Return parameter	NORMAL	Normal LIN polarity
	INVerted	Inverted LIN polarity

Example :BUS1:LIN:POLARity?
NORMAL
Returns the LIN polarity.

:BUS1:LIN:SAMPLEpoint → (Query)

Description Returns the sample point.

Syntax :BUS1:LIN:SAMPLEpoint?

Return Parameter Returns the sample point of the LIN bus as a percentage.

Example :BUS1:LIN:SAMPLEpoint?
50
Returns the sample point as a percentage.

Set →

:BUS1:LIN:SOURce → Query

Description Sets or returns the LIN data source.

Syntax :BUS1:LIN:SOURce {CH1 | CH2 | ? }

Parameter/Return parameter	CH1 ~ CH2	Analog channel source
----------------------------	-----------	-----------------------

Example :BUS1:LIN:SOURCE?
>CH1
Returns the LIN source.

Set →

:BUS1:LIN:STANDard → Query

Description Sets or returns the LIN standard.

Syntax :BUS1:LIN:STANDard {V1X|V2X|BOTH|?}

Parameter/Return parameter	V1X	Lin standard version 1.x
	V2X	Lin standard version 2.x
	BOTH	Both standards

Example :BUS1:LIN:STANDard?
>BOTH
Returns the LIN standard.

Mark Commands

:MARK	179
:MARK:CREATE.....	179
:MARK:DELEte	180

:MARK

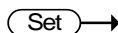

Description	Move to next or previous event mark.
Syntax	:MARK { NEXT PREvious }
Related commands	:MARK:CREATE :MARK:DELEte
Parameter	NEXT Move to next mark PREvious Move to previous mark
Example	:MARK NEXT Moves to the next event mark.

:MARK:CREATE

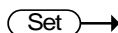

Description	Creates a mark on the waveform at the current position or creates a mark for all the events for the current waveform.
Syntax	:MARK:CREATE { CURRent ALL }
Related commands	:MARK :MARK:DELEte
Parameter	CURRent Creates a mark at the current position ALL Creates a mark for all the events.
Example	:MARK:CREATE CURRent Creates a mark at the current position.

:MARK:DELEte



Description	Deletes the current mark or all the marks on a waveform.	
Syntax	:MARK:DELEte { CURRent ALL }	
Related commands	:MARK :MARK:CREATE	
Parameter	CURRent	Deletes the current mark
	ALL	Deletes all the marks
Example	:MARK:DELEte CURRent Deletes the current mark.	

Search Commands

:SEARCH:COPIY	182
:SEARCH:STATE	183
:SEARCH:TOTAL.....	183
:SEARCH:TRIGger:TYPe	183
:SEARCH:TRIGger:SOURce.....	184
:SEARCH:TRIGger:EDGE:SLOP	184
:SEARCH:TRIGger:LEVel	184
:SEARCH:TRIGger:HLEVel	185
:SEARCH:TRIGger:LLEVel	185
:SEARCH:TRIGger:PULSEWidth:POLarity	186
:SEARCH:TRIGger:RUNT:POLarity	186
:SEARCH:TRIGger:RISEFall:SLOP.....	187
:SEARCH:TRIGger:PULSe:WHEn.....	187
:SEARCH:TRIGger:PULSe:TIme.....	188
:SEARCH:TRIGger:RUNT:WHEn	188
:SEARCH:TRIGger:RUNT:TIme.....	189
:SEARCH:TRIGger:RISEFall:WHEn	189
:SEARCH:TRIGger:RISEFall:TIme	190
:SEARCH:TRIGger:BUS:TYPe	190
:SEARCH:TRIGger:BUS:B1:I2C:CONDition.....	191
:SEARCH:TRIGger:BUS:B1:I2C:ADDRes:MODE	191
:SEARCH:TRIGger:BUS:B1:I2C:ADDRes:TYPe	192
:SEARCH:TRIGger:BUS:B1:I2C:ADDRes:VALue	193
:SEARCH:TRIGger:BUS:B1:I2C:ADDRes:DIRection.....	193
:SEARCH:TRIGger:BUS:B1:I2C:DATa:SIze.....	194
:SEARCH:TRIGger:BUS:B1:I2C:DATa:VALue.....	194
:SEARCH:TRIGger:BUS:B1:UART:CONDition.....	195
:SEARCH:TRIGger:BUS:B1:UART:RX:DATa:SIze	196
:SEARCH:TRIGger:BUS:B1:UART:RX:DATa:VALue	197
:SEARCH:TRIGger:BUS:B1:UART:TX:DATa:SIze	197
:SEARCH:TRIGger:BUS:B1:UART:TX:DATa:VALue	198
:SEARCH:TRIGger:BUS:B1:CAN:CONDition	199

:SEARCH:TRIGger:BUS:B1:CAN:FRAMeType200
 :SEARCH:TRIGger:BUS:B1:CAN:IDentifier:MODe ..200
 :SEARCH:TRIGger:BUS:B1:CAN:IDentifier:VALue...201
 :SEARCH:TRIGger:BUS:B1:CAN:IDentifier:
 DIRection201
 :SEARCH:TRIGger:BUS:B1:CAN:DATA:QUALifier ...202
 :SEARCH:TRIGger:BUS:B1:CAN:DATA:SIZE203
 :SEARCH:TRIGger:BUS:B1:CAN:DATA:VALue203
 :SEARCH:TRIGger:BUS:B1:LIN:CONDition204
 :SEARCH:TRIGger:BUS:B1:LIN:DATA:QUALifier205
 :SEARCH:TRIGger:BUS:B1:LIN:DATA:SIZE206
 :SEARCH:TRIGger:BUS:B1:LIN:DATA:VALue206
 :SEARCH:TRIGger:BUS:B1:LIN:ERRTYPE207
 :SEARCH:TRIGger:BUS:B1:LIN:IDentifier:VALue208
 :SEARCH:FFTPeak:METhod208
 :SEARCH:FFTPeak:METhod:MPeak209
 :SEARCH:FFTPeak:SINFo210
 :SEARCH:FFTPeak:LIST210

:SEARCH:COPY



Description	Copies the search settings to the trigger settings or copies the trigger settings to the search settings.	
Syntax	:SEARCH:COPY {SEARCHtotrigger TRIGgertosearch}	
Parameter	SEARCHtotrigger	Copy the search setting to the trigger settings.
	TRIGgertosearch	Copy the trigger settings to the search settings.
Example	:SEARCH:COPY SEARCHtotrigger Copies the search settings to the trigger settings.	

Set →
→ Query

:SEARCH:STATE

Description	Sets or queries whether the Search function is on or off.	
Syntax	:SEARCH:STATE { OFF ON ? }	
Parameter/Return parameter	OFF	Turn the Search function on.
	ON	Turn the Search function off.
Example	:SEARCH:STATE ON Turn Search on.	

→ Query

:SEARCH:TOTAL

Description	Returns the total number of events found from the search function.	
Syntax	:SEARCH:TOTAL?	
Return parameter	<NR1>	Number of events.
Example	:SEARCH:TOTAL? 5	

Set →
→ Query

:SEARCH:TRIGger:TYPE

Description	Sets or queries the search trigger type.	
Syntax	:SEARCH:TRIGger:TYPE { EDGe PULSEWidth RUNT RISEFall FFTPeak BUS ? }	
Parameter/Return parameter	EDGe	Edge trigger
	PULSEWidth	Pulse width trigger
	RUNT	Runt trigger
	RISEFall	Rise and Fall trigger
	FFTPeak	FFT Peak trigger
	BUS	Bus trigger

Example :SEARCH:TRIGger:TYPe EDGE
Sets the search trigger to the edge type.

Set →

:SEARCH:TRIGger:SOURce → Query

Description Sets or queries the search trigger source.

Syntax :SEARCH:TRIGger:SOURce {CH1 | CH2 | ? }

Parameter/Return parameter CH1 to CH2 Channel 1 to Channel 2

Example :SEARCH:TRIGger:SOURce CH1
Sets the search trigger source as CH1.

Set →

:SEARCH:TRIGger:EDGE:SLOP → Query

Description Sets or queries the search trigger slope.

Syntax :SEARCH:TRIGger:EDGE:SLOP { RISE | FALL | EITHER | ? }

Related commands :SEARCH:TRIGger:TYPe

Parameter	RISe	Rising slope
	FALL	Falling slope
	EITHer	Either rising or falling slope

Return parameter Returns the trigger slope.



Example :SEARCH:TRIGger:EDGE:SLOP FALL
Sets the search trigger slope to falling.



Set →

:SEARCH:TRIGger:LEVel → Query

Description Sets or queries the search trigger level.

Syntax :SEARCH:TRIGger:LEVel {TTL | ECL| SETTO50 | <NRf> | ? }

Related commands	:SEARCH:TRIGger:TYPe	
Parameter	<NRf>	Trigger level value
	TTL	Sets the search trigger level to TTL.
	ECL	Sets the search trigger level to ECL.
	SETTO50	Sets the search trigger level to the User level (50% by default).
Return parameter	<NR3>	Returns the trigger.
Example1	:SEARCH:TRIGger:LEVel TTL Sets the search trigger level to TTL.	
Example2	:SEARCH:TRIGger:LEVel 3.30E-1 Sets the search trigger level to 330mV/mA.	
		
		

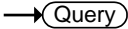
Description	Sets or queries the high level search trigger.	
 Note	Applicable for Rise and Fall/Pulse Runt search triggers.	
Syntax	:SEARCH:TRIGger:HLEVel { <NRf> ? }	
Related commands	:SEARCH:TRIGger:TYPe	
Parameter	<NRf>	High level value.
Return parameter	<NR3>	Returns the high level search trigger.
Example	:SEARCH:TRIGger:HLEVel 3.30E-1 Sets the high level search trigger to 330mV/mA.	
		
		

Description	Sets or queries the low level search trigger.	
 Note	Applicable for Rise and Fall/Pulse Runt triggers.	

Syntax	:SEARCH:TRIGger:LLEVel { <NRf> ?}	
Related commands	:SEARCH:TRIGger:TYPE	
Parameter	<NRf>	Low level value.
Return parameter	<NR3>	Returns the low level.
Example	:SEARCH:TRIGger:LLEVel -3.30E-3 Sets the low level search trigger to 330mV/mA.	

Set →
 → Query

Description	Sets or queries the pulse width search trigger polarity.	
Syntax	:SEARCH:TRIGger:PULSEWidth:POLarity {POSitive NEGative ?}	
Related commands	:SEARCH:TRIGger:TYPE	
Parameter	POSitive	Positive polarity
	NEGative	Negative polarity
Return parameter	Returns the pulse width polarity.	
Example	:SEARCH:TRIGger:PULSEWidth:POLarity POSitive Sets the pulse width polarity to positive.	

Set →
 → Query

Description	Sets or queries the Pulse Runt search trigger polarity.	
Syntax	:SEARCH:TRIGger:RUNT:POLarity {POSitive NEGative EITHER ?}	
Related commands	:SEARCH:TRIGger:TYPE	

Parameter	POSitive	Positive polarity
	NEGative	Negative polarity
	EITher	Positive or negative polarity

Return parameter Returns the pulse runt search trigger polarity.

Example :SEARCH:TRIGger:RUNT:POLarity POSitive
Sets the Pulse Runt search trigger polarity to positive.

:SEARCH:TRIGger:RISEFall:SLOP (Set) →
→ (Query)

Description Sets or queries the slope of the Rise and Fall search trigger.

Syntax :SEARCH:TRIGger:RISEFall:SLOP { RISE | FALL | EITher | ? }

Related commands :SEARCH:TRIGger:TYPE

Parameter	RISe	Rising slope
	FALL	Falling slope
	EITher	Either rising or falling slope

Return parameter Returns the rise & fall slope.

Example :SEARCH:TRIGger:RISEFall :SLOP RISe
Sets the Rise & Fall search trigger slope to rising.

:SEARCH:TRIGger:PULSe:WHEn (Set) →
→ (Query)

Description Sets or queries the pulse width search trigger conditions.

Syntax :SEARCH:TRIGger:PULSe:WHEn {MOREthan | LESSthan | EQual | UNEQual | ?}

Related commands :SEARCH:TRIGger:TYPE
:SEARCH:TRIGger:PULSe:TIME

Parameter	MOREthan	>
	LESSthan	<
	Equal	=
	UNEQUAL	≠

Return parameter Returns the pulse width search trigger conditions.

Example :SEARCH:TRIGger:PULSe:WHEn UNEQUAL
Sets the pulse width search trigger conditions to not equal to (≠).

Set →
 → Query

:SEARCH:TRIGger:PULSe:TIME

Description Sets or queries the pulse width search trigger time.

Syntax :SEARCH:TRIGger:PULSe:TIME {<NRf> | ?}

Related commands :SEARCH:TRIGger:TYPE
:SEARCH:TRIGger:PULSe:WHEn

Parameter	<NRf>	Pulse width time (4ns~10s)
-----------	-------	----------------------------

Return parameter	<NR3>	Returns the pulse width time in seconds.
------------------	-------	--

Example :SEARCH:TRIGger:PULSe:TIME 4.00E-5
Sets the pulse width search trigger to 40.0us.

Set →
 → Query

:SEARCH:TRIGger:RUNT:WHEn

Description Sets or queries the pulse runt search trigger conditions.

Syntax :SEARCH:TRIGger:RUNT:WHEn {MOREthan | LESSthan | Equal | UNEQUAL | ?}

Related commands :SEARCH:TRIGger:TYPE
:SEARCH:TRIGger:RUNT:TIME

Parameter	MOREthan	>
	LESSthan	<

Equal	=
UNEQUAL	≠

Return parameter Returns the pulse runt search trigger conditions.

Example :SEARCH:TRIGger:RUNT:WHEn UNEQUAL
Sets the pulse runt search trigger condition to unequal (≠).

:SEARCH:TRIGger:RUNT:TIME

Set →

→ Query

Description Sets or queries the pulse runt search trigger time.

Syntax :SEARCH:TRIGger:RUNT:TIME {<NRf> | ? }

Related commands :SEARCH:TRIGger:TYPE
:SEARCH:TRIGger:RUNT:WHEn

Parameter <NRf> Pulse runt time (4nS to 10S)

Return Parameter <NR3> Returns the runt time in seconds.

Example :SEARCH:TRIGger:RUNT:TIME 4.00E-5
Sets the pulse runt time to 40.0uS.

Set →

→ Query

Description Sets or queries the rise and fall search trigger conditions.

Syntax :SEARCH:TRIGger:RISEFall:WHEn {MOREthan | LESSthan | EQUAL | UNEQUAL | ? }

Related commands :SEARCH:TRIGger:TYPE
:SEARCH:TRIGger:RISEFall:TIME

Parameter	MOREthan	>
	LESSthan	<
	Equal	=
	UNEQUAL	≠

Return parameter Returns the rise and fall search trigger condition.

Example :SEARCH:TRIGger:RISEFall:WHEn UNEQual
 Sets the rise and fall search trigger condition to unequal (≠).

:SEARCH:TRIGger:RISEFall:TIME (Set) →
 → (Query)

Description	Sets or queries the rise and fall time.	
Syntax	:SEARCH:TRIGger:RISEFall:TIME {<NRf> ? }	
Related commands	:SEARCH:TRIGger:TYPE :SEARCH:TRIGger:RISEFall:WHEn	
Parameter	<NRf>	Rise and Fall time (4nS to 10S)
Return Parameter	<NR3>	Returns the rise and fall time in seconds.

Example :SEARCH:TRIGger:RISEFall:TIME 4.00E-5
 Sets the trigger rise and fall time to 40.0us.

:SEARCH:TRIGger:BUS:TYPE → (Query)

Description	Returns the current bus type.	
Syntax	:SEARCH:TRIGger:BUS:TYPE?	
Return parameter	12C	I2C mode
	UART	UART mode
	CAN	CAN mode
	LIN	LIN mode

Example :SEARCH:TRIGger:BUS:TYPE?
 UART

:SEARCH:TRIGger:BUS:B1:I2C:CONDition  

Description	Sets or queries the I ² C search trigger conditions.	
Syntax	:SEARCH:TRIGger:BUS:B1:I2C:CONDition {START STOP REPEATstart ACKMISS ADDRess DATA ADDRANDDATA ? }	
Parameter	START	Set Start as the I ² C search trigger condition.
	STOP	Set Stop as the I ² C search trigger condition.
	REPEATstart	Set Repeat of Start as the I ² C search trigger condition.
	ACKMISS	Set Missing Acknowledgement as the I ² C search trigger condition.
	ADDRess	Set Address as the I ² C search trigger condition.
	DATA	Set Data as the I ² C search trigger condition.
	ADDRANDDATA	Set Address and Data as the I ² C search trigger condition.

Return parameter Returns the I²C bus search trigger condition.

Example :SEARCH:TRIGger:BUS:B1:I2C:CONDition ADDRess
Set Address as the I²C search trigger condition.

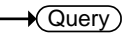
:SEARCH:TRIGger:BUS:B1:I2C:ADDRess  
:MODE

Description	Sets or queries the I ² C addressing mode (7 or 10 bits) for the search trigger.	
Syntax	:SEARCH:TRIGger:BUS:B1:I2C:ADDRess:MODE {ADDR7 ADDR10 ? }	

Related commands :SEARCH:TRIGger:BUS:B1:I2C:CONDition

Parameter	ADDR7	7 bit addressing
	ADDR10	10 bit addressing

Return Parameter	0	7 bit addressing
	1	10 bit addressing

Example :SEARCH:TRIGger:BUS:B1:I2C:ADDRes:MODE? 0
 The addressing mode is current set to 7 bits.

:SEARCH:TRIGger:BUS:B1:I2C:ADDRes (Set) →
 :TYPE ← (Query)

Description Sets the I²C bus address type, or queries what the setting is for the search trigger.

Syntax :SEARCH:TRIGger:BUS:B1:I2C:ADDRes:TYPE {GENeralcall | STARtbyte | HSmode | EEPROM | CBUS | ?}

Related commands :SEARCH:TRIGger:BUS:B1:I2C:CONDition

Parameter	GENeralcall	Set a general call address (0000 000 0).
	STARtbyte	Set a start byte address. (0000 000 1)
	HSmode	Set a high-speed mode address. (0000 1xx x)
	EEPROM	Set an EEPROM address. (1010 xxx x)
	CBUS	Set a CBUS address. (0000 001 x)

Return Parameter Returns the address type

Example :SEARCH:TRIGger:BUS:B1:I2C:ADDRes:TYPE? CBUS

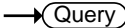
:SEARCH:TRIGger:BUS:B1:I2C:ADDRes 
:VALue 

Description Sets or queries the I²C bus address value when the I²C search trigger is set to trigger on Address or Address/Data.

Syntax :SEARCH:TRIGger:BUS:B1:I2C:ADDRes:VALue
{<string> | ? }



Related commands :SEARCH:TRIGger:BUS:B1:I2C:ADDRes:MODE

Parameter <sting> 7/10 characters, must be enclosed in double quotes "string".
x = don't care
1 = binary 1
0 = binary 0

Return Parameter Returns the address value in binary.

Example 1 :SEARCH:TRIGger:BUS:B1:I2C:ADDRes:MODE
ADDR7
:SEARCH:TRIGger:BUS:B1:I2C:ADDRes:VALue
"xxx0101"
Sets the address to XXX0101

Example 2 :SEARCH:TRIGger:BUS:B1:I2C:ADDRes:VALue?
XXX0101

:SEARCH:TRIGger:BUS:B1:I2C:ADDRes 
:DIRectioN 

Description Sets or queries the address bit as read write or don't care for the search function.



Note

This setting only applies when the I²C search trigger is set to trigger on Address or Address/Data

Syntax	:SEARCH:TRIGger:BUS:B1:I2C:ADDRes:DIRection { READ WRITE NOCARE ? }	
Related commands	:SEARCH:TRIGger:BUS:B1:I2C:CONDition	
Parameter	READ	Set read as the data direction.
	WRITE	Set write as the data direction.
	NOCARE	Set either as the data direction.
Return Parameter	Returns the direction (READ, WRITE, NOCARE).	
Example	:SEARCH:TRIGger:BUS:B1:I2C:ADDRes:DIRection READ Sets the direction to READ.	

Set →
 → Query

Description	Sets or queries the data size in bytes for the I ² C bus.	
 Note	This setting only applies when the I ² C search trigger is set to trigger on Data or Address/Data	

Syntax	:SEARCH:TRIGger:BUS:B1:I2C:DATA:SIZE {<NR1> ? }	
Related commands	:SEARCH:TRIGger:BUS:B1:I2C:CONDition	
Parameter	<NR1>	Number of data bytes (1 to 5).
Return parameter	<NR1>	Returns the number of bytes.
Example	:SEARCH:TRIGger:BUS:B1:I2C:DATA:SIZE 3 Sets the number of bytes to 3.	

Set →
 → Query

Description	Sets or queries the triggering data value for the I ² C bus when the I ² C search trigger is set to trigger on Data or Address/Data.	
-------------	--	--

RXPARIttyerr	Set search trigger on RX Parity error condition.
TXSTArt	Set search trigger on the TX Start Bit.
TXDATA	Set search trigger on TX Data.
TXENDPacket	Set search trigger on the TX End of Packet condition.
TXPARIttyerr	Set search trigger on TX Parity error condition.

Return Parameter Returns the search triggering condition.

Example :SEARCH:TRIGger:BUS:B1:UART:CONDition TXDATA
Sets the UART bus to trigger on Tx Data for the search function.

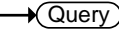
:SEARCH:TRIGger:BUS:B1:UART:RX:DATA: 
SIZE 

Description Sets or queries the number of bytes for UART data.



Note This setting only applies when the UART search trigger is set to trigger on Rx Data

Syntax :SEARCH:TRIGger:BUS:B1:UART:RX:DATA:SIZE
{<NR1> | ?}

Related commands :SEARCH:TRIGger:BUS:B1:UART:CONDition

Parameter <NR1> Number of bytes (1 to 10).

Return parameter <NR1> Returns the number of bytes.

Example :SEARCH:TRIGger:BUS:B1:UART:RX:DATA:SIZE 5
Sets the number of bytes to 5.

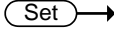
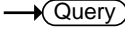
:SEARCH:TRIGger:BUS:B1:UART:RX:DATA: VALue



Description Sets or queries the search triggering data value for the UART bus when the bus is set to trigger on Rx Data.

Syntax :SEARCH:TRIGger:BUS:B1:UART:RX:DATA:VALue {<string> | ? }

Related commands :SEARCH:TRIGger:BUS:B1:UART:RX:DATA:SIZE

Parameter	<string>	The number of characters in the string depends on the data size setting. The string must be enclosed in double quotes, "string". x = don't care 1 = binary 1 0 = binary 0
------------------	-----------------------	--

Return Parameter Returns the data value.

Example1 :SEARCH:TRIGger:BUS:B1:UART:CONDition RXDATA
 :SEARCH:TRIGger:BUS:B1:UART:RX:DATA:SIZE 1
 :SEARCH:TRIGger:BUS:B1:UART:RX:DATA:VALue "1x1x0101"

 Sets the value to 1x1x0101

Example 2 :SEARCH:TRIGger:BUS:B1:UART:RX:DATA:VALue? 1X1X0101

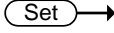
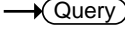
:SEARCH:TRIGger:BUS:B1:UART:TX:DATA :SIZE



Description Sets or queries the number of bytes for UART data.

 **Note** This setting only applies when the UART search trigger is set to trigger on Tx Data

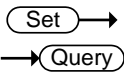
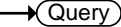
Syntax	:SEARCH:TRIGger:BUS:B1:UART:TX:DATA:SIZE {<NR1> ?}	
Related commands	:SEARCH:TRIGger:BUS:B1:UART:CONDition	
Parameter	<NR1>	Number of bytes (1 to 10).
Return parameter	<NR1>	Returns the number of bytes.
Example	:SEARCH:TRIGger:BUS:B1:UART:TX:DATA:SIZE 5 Sets the number of bytes to 5.	

:SEARCH:TRIGger:BUS:B1:UART:TX:DATA:  VALue 

Description	Sets or queries the search triggering data value for the UART bus when the bus is set to trigger on Tx Data.	
Syntax	:SEARCH:TRIGger:BUS:B1:UART:TX:DATA:VALue {<string> ?}	
Related commands	:SEARCH:TRIGger:BUS:B1:UART:TX:DATA:SIZE	
Parameter	<sting>	The number of characters in the string depends on the data size setting. The string must be enclosed in double quotes, "string". x = don't care 1 = binary 1 0 = binary 0
Return Parameter	Returns the data value.	
Example 1	:SEARCH:TRIGger:BUS:B1:UART:CONDition TXDATA :SEARCH:TRIGger:BUS:B1:UART:TX:DATA:SIZE 1 :SEARCH:TRIGger:BUS:B1:UART:TX:DATA:VALue "1x1x0101" Sets the value to 1x1x0101	

Example 2 :SEARCH:TRIGger:BUS:B1:UART:TX:DATA:VALue?
1X1X0101

Set →

:SEARCH:TRIGger:BUS:B1:CAN:CONDition → Query

Description Sets or returns the CAN search trigger condition.

Syntax :SEARCH:TRIGger:BUS:B1:CAN:CONDition
{SOF|FRAMeType|IDentifier|DATA|IDANDDATA|EOF|
ACKMISS|STUFFERR|?}

Parameter/ Return parameter	SOF	Sets search to trigger on a start of frame
	FRAMeType	Sets search to trigger on the type of frame
	IDentifier	Sets search to trigger on a matching identifier
	DATA	Sets search to trigger on matching data
	IDANDDATA	Sets search to trigger on matching identifier and data field
	EOF	Sets search to trigger on the end of frame
	ACKMISS	Sets search to trigger on a missing acknowledge
	STUFFERR	Sets search to trigger on a bit stuffing error

Example1 :SEARCH:TRIGger:BUS:B1:CAN:CONDition SOF
Triggers search on a start of frame.

Example2 :SEARCH:TRIGger:BUS:B1:CAN:CONDition?
>SOF

:SEARCH:TRIGger:BUS:B1:CAN:FRAMeType  → 

Description	Sets or returns the frame type for the CAN FRAMeType search trigger.	
Syntax	:SEARCH:TRIGger:BUS:B1:CAN:FRAMeType {DATA REMOte ERRor OVERLoad ?}	
Parameter/ Return parameter	DATA	Sets the frame type to data frame
	REMOte	Sets the frame type to remote frame
	ERRor	Sets the frame type to error frame
	OVERLoad	Sets the frame type to overload
Example	:SEARCH:TRIGger:BUS:B1:CAN:FRAMeType DATA Sets the frame type to DATA.	

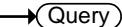
:SEARCH:TRIGger:BUS:B1:CAN:IDentifier:  → 
MODE

Description	Sets or returns the CAN identifier mode for the bus.	
Syntax	:SEARCH:TRIGger:BUS:B1:CAN:IDentifier:MODE {STANDard EXTended ?}	
Parameter/ Return parameter	STANDard	Standard addressing mode
	EXTended	Extended addressing mode
Example	:SEARCH:TRIGger:BUS:B1:CAN:IDentifier:MODE? >STANDARD :SEARCH:TRIGger:BUS:B1:CAN:IDentifier:MODE EXTENDED :SEARCH:TRIGger:BUS:B1:CAN:IDentifier:MODE? >EXTENDED	

:SEARCH:TRIGger:BUS:B1:CAN:IDentifier: VALue (Set) →
→ (Query)

Description Sets or returns the identifier string used for the CAN search trigger.

Note Only applicable when the search trigger condition is set to ID or IDANDDATA.

Syntax :SEARCH:TRIGger:BUS:B1:CAN:IDentifier:VALue {<string>[?]}

Related Commands :SEARCH:TRIGger:BUS:B1:CAN:IDentifier:MODE

Parameter/ Return parameter	<code><string></code>	The size of the string depends on the data size setting. The string must be enclosed in double quotes, "string". String contents: x = don't care 1 = binary 1 0 = binary 0
--	-----------------------------	--

Example

```
:SEARCH:TRIGger:BUS:B1:CAN:CONDition ID
:SEARCH:TRIGger:BUS:B1:CAN:IDentifier:MODE
STANDARD
:SEARCH:TRIGger:BUS:B1:CAN:IDentifier:VALue
"01100X1X01X"
:SEARCH:TRIGger:BUS:B1:CAN:IDentifier:VALue?
>01100X1X01X
```

:SEARCH:TRIGger:BUS:B1:CAN:IDentifier: DIRection (Set) →
→ (Query)

Description Sets or queries the address bit as read, write or don't care.

Syntax :SEARCH:TRIGger:BUS:B1:CAN:IDentifier:DIRection {READ|WRITE|NOCARE?}

Parameter/ Return parameter	READ	Sets read as the data direction
	WRITE	Sets write as the data direction
	NO CARE	Sets either as the data direction

Example2 :SEARCH:TRIGger:BUS:B1:CAN:IDentifier:DIRection?
>WRITE

:SEARCH:TRIGger:BUS:B1:CAN:IDentifier:DIRection
READ

:SEARCH:TRIGger:BUS:B1:CAN:IDentifier:DIRection?
>READ

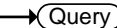
:SEARCH:TRIGger:BUS:B1:CAN:DATA: 
QUALifier 

Description Sets or returns the CAN data qualifier.

 Note Only applicable when the search triggering condition is set to DATA or IDANDDATA.

Syntax :SEARCH:TRIGger:BUS:B1:CAN:DATA:QUALifier
{LESSthan|MOREthan|EQUAL|UNEQUAL|LESSEQUAL|M
OREEQUAL|?}

Parameter/ Return parameter	LESSthan	Sets search to trigger when the data is less than the qualifier value.
	MOREthan	Sets search to trigger when the data is greater than the qualifier value.
	EQUAL	Sets search to trigger when the data is equal to the qualifier value.
	UNEQUAL	Sets search to trigger when the data is not equal to the qualifier value.
	LESSEQUAL	Sets search to trigger when the data is less than or equal to the qualifier value.
	MOREEQUAL	Sets search to trigger when the data is more than or equal to the qualifier value.

Example :SEARCH:TRIGger:BUS:B1:CAN:DATA:QUALifier?
 >EQUAL
 :SEARCH:TRIGger:BUS:B1:CAN:DATA:QUALifier
 MOREthan
 :SEARCH:TRIGger:BUS:B1:CAN:DATA:QUALifier?
 >MORETHAN

Set →

:SEARCH:TRIGger:BUS:B1:CAN:DATA:SIZE → Query

Description Sets or returns the length of the data string in bytes for the CAN search trigger.
 Note: Only applicable when the condition is set to DATA or IDANDDATA.

Syntax :SEARCH:TRIGger:BUS:B1:CAN:DATA:SIZE {<NR1>|?}

Parameter/ Return parameter	<NR1>	1~8 (bytes)
--------------------------------	-------	-------------

Example :SEARCH:TRIGger:BUS:B1:CAN:DATA:SIZE?
 >1
 :SEARCH:TRIGger:BUS:B1:CAN:DATA:SIZE 2
 :SEARCH:TRIGger:BUS:B1:CAN:DATA:SIZE?
 >2

Set →

:SEARCH:TRIGger:BUS:B1:CAN:DATA:
 VALue → Query

Description Sets or returns the binary data string to be used for the CAN search trigger.

Related
Commands :SEARCH:TRIGger:BUS:B1:CAN:DATA:SIZE

Syntax :SEARCH:TRIGger:BUS:B1:CAN:DATA:VALue
 {<string>|?}

Parameter/ Return parameter	<string>	The size of the string depends on the data size setting. The string must be enclosed in double quotes, "string".
--------------------------------	----------	--

String contents:

x = don't care

1 = binary 1

0 = binary 0

Example :SEARCH:TRIGger:BUS:B1:CAN:DATA:SIZE 1
 :SEARCH:TRIGger:BUS:B1:CAN:DATA:VALue
 "01010X1X"
 :SEARCH:TRIGger:BUS:B1:CAN:DATA:VALue?
 >01010X1X

Set →

:SEARCH:TRIGger:BUS:B1:LIN:CONDition → Query

Description Sets or returns the LIN search trigger condition.

Syntax :SEARCH:TRIGger:BUS:B1:LIN:CONDition
 {SYNCFieLd|IDentifier|DATA|IDANDDATA|WAKEup|SLEEPEP|ERRor|?}

Parameter/ Return parameter	SYNCFieLd	Sets the LIN search trigger condition to the sync field.
	IDentifier	Sets the LIN search trigger condition to identifier field.
	DATA	Sets the LIN search trigger condition to the data field.
	IDANDDATA	Sets the LIN search trigger condition to identifier and data field
	WAKEup	Sets the LIN search trigger condition to wake up.
	SLEEPEP	Sets the LIN search trigger condition to sleep.
	ERRor	Sets the LIN search trigger condition to error.

Example :SEARCH:TRIGger:BUS:B1:LIN:CONDition?
 >IDANDDATA
 :SEARCH:TRIGger:BUS:B1:LIN:CONDition DATA
 :SEARCH:TRIGger:BUS:B1:LIN:CONDition?
 >DATA

:SEARCH:TRIGger:BUS:B1:LIN:DATA: (Set) →
 QUALifier → (Query)

Description Sets or returns the LIN data qualifier.
 Note: Only applicable when the search trigger
 condition is set to DATA or IDANDDATA.

Syntax :SEARCH:TRIGger:BUS:B1:LIN:DATA:QUALifier
 {LESSthan|MOREthan|EQual|UNEQual|LESSEQual|M
 OREEQual|?}

Parameter/ Return parameter	LESSthan	Sets search to trigger when the data is less than the qualifier value.
	MOREthan	Sets search to trigger when the data is greater than the qualifier value.
	EQual	Sets search to trigger when the data is equal to the qualifier value.
	UNEQual	Sets search to trigger when the data is not equal to the qualifier value.
	LESSEQual	Sets search to trigger when the data is less than or equal to the qualifier value.
	MOREEQual	Sets search to trigger when the data is more than or equal to the qualifier value.

Example :SEARCH:TRIGger:BUS:B1:LIN:DATA:QUALifier?
 >EQUAL
 :SEARCH:TRIGger:BUS:B1:LIN:DATA:QUALifier
 MOREthan
 :SEARCH:TRIGger:BUS:B1:LIN:DATA:QUALifier?
 >MORETHAN

Set →

:SEARCH:TRIGger:BUS:B1:LIN:DATA:SIZE → Query

Description Sets or returns the length of the data string in bytes for the LIN search trigger.
 Note: Only applicable when the condition is set to DATA or IDANDDATA.

Syntax :SEARCH:TRIGger:BUS:B1:LIN:DATA:SIZE {<NR1>|?}

Parameter/ Return parameter	<NR1>	1~8 (bytes)
--------------------------------	-------	-------------

Example :SEARCH:TRIGger:BUS:B1:LIN:DATA:SIZE?
 >1
 :SEARCH:TRIGger:BUS:B1:LIN:DATA:SIZE 2
 :SEARCH:TRIGger:BUS:B1:LIN:DATA:SIZE?
 >2

:SEARCH:TRIGger:BUS:B1:LIN:DATA:VALue Set →
 → Query

Description Sets or returns the binary data string to be used for the LIN search trigger.



Note

Only applicable when the condition is set to DATA or IDANDDATA.

Related Commands :SEARCH:TRIGger:BUS:B1:LIN:DATA:SIZE

Syntax :SEARCH:TRIGger:BUS:B1:LIN:DATA:VALue {<string>|?}

Parameter/ Return parameter	<string>	The size of the string depends on the data size setting. The string must be enclosed in double quotes, "string". String contents: x = don't care 1 = binary 1 0 = binary 0
--------------------------------	----------	--

Example :SEARCH:TRIGger:BUS:B1:LIN:DATa:SIZE 1
 :SEARCH:TRIGger:BUS:B1:LIN:DATa:VALue
 "01010X1X"
 :SEARCH:TRIGger:BUS:B1:LIN:DATa:VALue?
 >01010X1X

Set →
 → Query

Description Sets or returns the error type to be used for the LIN search trigger.

Syntax :SEARCH:TRIGger:BUS:B1:LIN:ERRTYPE
 {SYNC|PARItY|CHeCksum|?}

Parameter/ Return parameter	SYNC	Sets the LIN error type to SYNC.
	PARItY	Sets the LIN error type to parity.
	CHeCksum	Sets the LIN error type to checksum.

Example :SEARCH:TRIGger:BUS:B1:LIN:ERRTYPE?
 >SYNC
 :SEARCH:TRIGger:BUS:B1:LIN:ERRTYPE CHECKSUM
 :SEARCH:TRIGger:BUS:B1:LIN:ERRTYPE?
 >CHECKSUM

:SEARCH:TRIGger:BUS:B1:LIN:IDentifier: VALue (Set) →
→ (Query)

Description Sets or returns the identifier string to be used for the LIN search trigger.

 **Note** Only applicable when the condition is set to ID or IDANDDATA.

Syntax :SEARCH:TRIGger:BUS:B1:LIN:IDentifier:VALue {<string>|?}

Parameter/ Return parameter	<string>	The size of the string depends on the data size setting. The string must be enclosed in double quotes, "string". String contents: x = don't care 1 = binary 1 0 = binary 0
--	----------	--

Example

```
:SEARCH:TRIGger:BUS:B1:LIN:CONDition ID
:SEARCH:TRIGger:BUS:B1:LIN:IDentifier:VALue
"00X1X01X"
:SEARCH:TRIGger:BUS:B1:LIN:IDentifier:VALue?
>01100X1X01X
```

:SEARCH:FFTPeak:METhod (Set) →
→ (Query)

Description Sets or returns the FFT peak method type.

Related Commands :SEARCH:TRIGger:TYPE
:SEARCH:FFTPeak:METhod:MPEak
:SEARCH:TRIGger:LEVel

Syntax :SEARCH:FFTPeak:METhod {MPEak | LEVel | ?}

Parameter/ Return parameter	MPEak	Sets the peak method to the Max Peak type.
	LEVel	Sets the peak methods to the Level type.

Example

```
:SEARCH:FFTPeak:MEthod LEVel
:SEARCH:FFTPeak:MEthod?
>LEVEL
:SEARCH:TRIGger:LEVel?
>1.000E+00
:SEARCH:TRIGger:LEVel 2
:SEARCH:TRIGger:LEVel?
>2.000E+00
```

:SEARCH:FFTPeak:MEthod:MPEak



Description Sets the active peak number (1 ~ 10) or return the frequency of the active peak number.

Related Commands :SEARCH:TRIGger:TYPE
:SEARCH:FFTPeak:MEthod

Syntax :SEARCH:FFTPeak:MEthod:MPEak {<NR1> | ?}

Parameter <NR1> Active peak number.

Return parameter <NR3> Frequency of the active peak.

Example

```
:SEARCH:FFTPeak:MEthod MPEak
:SEARCH:FFTPeak:MEthod?
>MPEAK
:SEARCH:FFTPeak:MEthod:MPEak?
>1.000E+00
:SEARCH:FFTPeak:MEthod:MPEak 2
:SEARCH:FFTPeak:MEthod:MPEak?
>2.000E+00
```

Set →

→ Query

:SEARCH:FFTPeak:SINFo

Description	Sets or returns the State Info to “Mark” or “Peak”.	
Related Commands	:SEARCH:TRIGger:TYPe	
Syntax	:SEARCH:FFTPeak:SINFo {MARK PEAK ?}	
Parameter/ Return parameter	MARK	Sets the State Info to Mark.
	PEAK	Sets the State Info to Peak.
Example	:SEARCH:FFTPeak:SINFo? >PEAK :SEARCH:FFTPeak:SINFo mark :SEARCH:FFTPeak:SINFo? >MARK	

:SEARCH:FFTPeak:LIST

→ Query

Description	Returns the data of the search event table.	
Syntax	:SEARCH:FFTPeak:LIST?	
Example	:SEARCH:FFTPeak:LIST? No.,Frequency,Value; 1,1.000E+04,-6.400E+00; 2,2.750E+06,-7.360E+01; 3,2.830E+06,-7.280E+01; 4,2.910E+06,-7.200E+01; 5,3.020E+06,-7.120E+01; 6,3.170E+06,-7.040E+01; 7,5.550E+06,-8.240E+01; 8,5.640E+06,-8.160E+01; 9,5.740E+06,-8.080E+01; 10,5.900E+06,-8.000E+01;	

Label Commands

:CHANnel<X>:LABel.....	211
:CHANnel<X>:LABel:DISPlay	212
:REF<X>:LABel	212
:REF<X>:LABel:DISPlay	213
:BUS1:LABel.....	214
:BUS1:LABel:DISPlay	214
:SET<X>:LABel	215

:CHANnel<X>:LABel

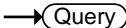

Description	Sets or returns the file label for the selected channel.	
Syntax	:CHANnel<X>:LABel {<string> ?}	
Related commands	:CHANnel<X>:LABel:DISPlay	
Parameter	<X>	Channel 1, 2
	<string>	The string must be no more than 8 characters and only contain alphanumeric characters in addition to period, dash and underscore characters. The string must be enclosed in double quotes, "string".
Return parameter	<string>	Returns the label for the selected channel. No return indicates that there has not been a file label assigned for the selected channel.
Example1	:CHANnel1:LABel "CH1_lab" Sets the channel 1 label as "CH1_lab".	
Example2	:CHANnel1:LABel? CH1_lab	

		 
:CHANnel<X>:LABel:DISPlay		
Description	Turns the label on/off for the selected channel or returns its status.	
Syntax	:CHANnel<X>:LABel:DISPlay { OFF ON ? }	
Related commands	:CHANnel<X>:LABel	
Parameter	<X>	Channel 1, 2
	OFF	Turns the file label off for the selected channel.
	ON	Turns the file label on for the selected channel.
Return parameter	Returns the status of the file label for the selected channel (ON, OFF).	
Example	<pre>:CHANnel1:LABel "CH1" :CHANnel1:LABel:DISPlay ON :CHANnel1:LABel:DISPlay? ON</pre> <p>Sets the channel 1 label to "CH1" and then turns the label display on. The query return shows that the label is on.</p>	

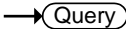
		 
:REF<X>:LABel		
Description	Sets or returns the file label for the selected reference waveform.	
Syntax	:REF<X>:LABel {<string> ?}	
Related commands	:REF<X>:LABel:DISPlay	
Parameter	<X>	REF 1, 2, 3, 4

	<string>	The string must be no more than 8 characters and only contain alphanumeric characters in addition to period, dash and underscore characters. The string must be enclosed in double quotes, "string".
Return parameter	<string>	Returns the label for the selected reference waveform. No return indicates that there has not been a file label assigned for the selected reference waveform.

Example1 :REF1:LABel "REF1_lab"
Sets the REF1 label as "REF1_lab".

Example2 :REF1:LABel?
REF1_lab

:REF<X>:LABel:DISPlay 

Description Turns the label on/off for the selected reference waveform or returns its status.

Syntax :REF<X>:LABel:DISPlay { OFF | ON | ? }

Related commands :REF<X>:LABel

Parameter	<X>	Reference waveform 1, 2, 3, 4
	OFF	Turns the file label off for the selected reference waveform.
	ON	Turns the file label on for the selected reference waveform.

Return parameter Returns the status of the file label for the selected reference waveform (ON, OFF).

Example :REF1:LABel "REF1"
 :REF1:LABel:DISPlay ON
 :REF1:LABel:DISPlay?
 ON

Sets the label for reference waveform 1 to "REF1" and then turns the label display on. The query return shows that the label is on.

Set →

→ Query

:BUS1:LABel

Description	Sets or returns the file label for the bus.	
Syntax	:BUS1:LABel {<string> ?}	
Related commands	:BUS1:LABel:DISPlay	
Parameter	<string>	The string must be no more than 8 characters and only contain alphanumeric characters in addition to period, dash and underscore characters. The string must be enclosed in double quotes, "string".
Return parameter	<string>	Returns the label for the bus. No return indicates that there has not been a file label assigned for bus.

Example1 :BUS1:LABel "Bus"
 Sets the bus label as "Bus".

Example2 :BUS1:LABel?
 Bus

Set →

→ Query

:BUS1:LABel:DISPlay

Description	Turns the label on/off for the bus or returns its status.	
Syntax	:BUS1:LABel:DISPlay { OFF ON ? }	

Related commands	:BUS1:LABel :D<x>:LABel :D<x>:LABel:DISPlay :DIGital:ANALog:A<x>:LABel :DIGital:ANALog:A<x>:LABel:DISPlay
Parameter	OFF Turns the file label off for the bus. ON Turns the file label on for the bus.
Return parameter	Returns the status of the file label for the bus (ON, OFF).
Example	:BUS1:LABel "Bus" :BUS1:LABel:DISPlay ON :BUS1:LABel:DISPlay? ON Sets the label for the bus to "Bus" and then turns the label display on. The query return shows that the label is on.



Description	Sets or returns the file label for the selected setup.
Syntax	:SET<X>:LABel {<string> ?}
Related commands	:SET<X>:LABel:DISPlay
Parameter	<X> Setup number 1 to 20 <string> The string must be no more than 8 characters and only contain alphanumeric characters in addition to period, dash and underscore characters. The string must be enclosed in double quotes, "string".

Return parameter	<string>	Returns the label for the selected setup. No return indicates that there has not been a file label assigned for the selected setup.
------------------	----------	---

Example1	:SET1:LABel "SET1_lab"
	Sets the label for setup 1 as "SET1_lab".

Example2	:SET1:LABel?
	SET1_lab

Segment Commands

:SEGMENTS:STATE	217
:SEGMENTS:CURRENT	218
:SEGMENTS:TOTALNUM	218
:SEGMENTS:TIME	219
:SEGMENTS:DISPALL	219
:SEGMENTS:MEASURE:MODE	219
:SEGMENTS:MEASURE:PLOT:SOURCE	220
:SEGMENTS:MEASURE:PLOT:DIVIDE	220
:SEGMENTS:MEASURE:PLOT:SELECT	221
:SEGMENTS:MEASURE:PLOT:RESULTS	221
:SEGMENTS:MEASURE:TABLE:SOURCE	222
:SEGMENTS:MEASURE:TABLE:SELECT	222
:SEGMENTS:MEASURE:TABLE:LIST	223
:SEGMENTS:MEASURE:TABLE:SAVE	223
:SEGMENTS:SAVE	224
:SEGMENTS:SAVE:SOURCE	224
:SEGMENTS:SAVE:SELECT:START	224
:SEGMENTS:SAVE:SELECT:END	225

:SEGMENTS:STATE

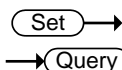

Description Turns the segmented memory function on/off or queries its state.

Syntax :SEGMENTS:STATE { OFF | ON | ? }

Related commands :RUN
:STOP

Parameter/ Return parameter	OFF	Turns the segmented memory off.
	ON	Turns the segmented memory on.

Example1 :SEGMENTS:STATE ON
Turns segmented memory on.

Set →

→ Query

:SEGMENTS:CURRENT

Description Sets or queries the current segment. The total number of segments depends on the record length.

Syntax :SEGMENTS:CURRENT
{SETTOMIN|SETTOMAX|<NR1>|?}

Related commands :SEGMENTS:STATE
:SEGMENTS:TOTALNUM

Parameter/ Return parameter	SETTOMIN	Current segment = min segment
	SETTOMAX	Current segment = max segment
	<NR1>	1~29000

Example1 :SEGMENTS:CURRENT 10
Sets the current segment to segment number 10.

Set →

→ Query

:SEGMENTS:TOTALNUM

Description Sets or queries the total number of segments for the segmented memory function. The total number of segments depends on the record length.

Syntax :SEGMENTS:TOTALNUM
{SETTOMIN|SETTOMAX|<NR1>|?}

Related commands :SEGMENTS:STATE
:SEGMENTS:CURRENT

Parameter/ Return parameter	SETTOMIN	Sets to the minimum number
	SETTOMAX	Sets to the maximum number
	<NR1>	1~29000

Example1 :SEGMENTS:TOTALNUM SETTOMAX
Sets the number of segments to max number (29000).

:SEGMents:TIME

→ Query

Description	Returns the time of the current segment in relation to the first segment.
Syntax	:SEGMents:TIME?
Related commands	:SEGMents:STATE :SEGMents:CURRent
Return parameter	The segment time as <NR3>.
Example	:SEGMents:TIME? >8.040E-03 Returns the segment time.

:SEGMents:DISPALL

Set →

→ Query

Description	Sets or queries whether all the segments are displayed on the screen.
Syntax	:SEGMents:DISPALL {OFF ON ?}
Related commands	:SEGMents:STATE :SEGMents:CURRent
Parameter/ Return parameter	OFF Turns the display all function off. ON Turns the display all function on.
Example1	:SEGMents:DISPALL ON Turns the display all function on.

:SEGMents:MEASure:MODE

Set →

→ Query

Description	Sets or queries the measurement mode.
Syntax	:SEGMents:MEASure:MODE {OFF PLOT TABLE ?}
Related commands	:MEASurement:MEAS<x>

Parameter/ Return parameter	OFF	Disables the automatic measurement function for the segments measurement.
	PLOT	Sets the measurement mode to Statistics.
	TABLE	Sets the measurement mode to a measurement list.

Example :SEGMents:MEASure:MODE?
>PLOT
Returns the measurement mode as Statistics.

Set →
 → Query

:SEGMents:MEASure:PLOT:SOURce

Description	Sets or queries the statistics source.
Syntax	:SEGMents:MEASure:PLOT:SOURce {<NR1> ? }
Related commands	:SEGMents:MEASure:MODE :SEGMents:MEASure:PLOT:DIVide :SEGMents:MEASure:PLOT:SElect :SEGMents:MEASure:PLOT:RESults

Parameter/ Return parameter	<NR1>	1~8 (Automatic measurement item 1~8)
--------------------------------	-------	--------------------------------------

Example1 :SEGMents:MEASure:PLOT:SOURce 1
Sets the source as auto measurement item 1.

Set →
 → Query

:SEGMents:MEASure:PLOT:DIVide

Description	Sets or queries the number of bins for the statistics function.
Syntax	:SEGMents:MEASure:PLOT:DIVide {<NR1> ? }
Related commands	:SEGMents:MEASure:PLOT:SOURce :SEGMents:MEASure:PLOT:SElect

Parameter/ Return parameter	<NR1>	1~20
--------------------------------	-------	------

Example1 :SEGMents:MEASure:PLOT:DIVide 5
Sets the number of bins to 5 for the statistics function.

:SEGMents:MEASure:PLOT:SElect (Set) →
← (Query)

Description Sets or queries which bin to view the statics of.

Syntax :SEGMents:MEASure:PLOT:SElect {<NR1> | ? }

Related commands :SEGMents:MEASure:PLOT:SOURce
:SEGMents:MEASure:PLOT:DIVide

Parameter	<NR1>	1~20 (cannot exceed the number of bins)
-----------	-------	---

Return parameter Return the bin number as <NR3>.

Example1 :SEGMents:MEASure:PLOT:SElect 5
Set to bin number 5.

:SEGMents:MEASure:PLOT:RESults → (Query)

Description Returns the results of the currently selected bin for the statistics measurement.

Note At least one automatic measurement must be turned on.

Syntax :SEGMents:MEASure:PLOT:RESults?

Related commands :SEGMents:STATE
:SEGMents:MEASure:MODE PLOT
:SEGMents:MEASure:PLOT:SOURce
:SEGMents:MEASure:PLOT:DIVide
:SEGMents:MEASure:PLOT:SElect

Return parameter Returns the statistics measurements as a string.

Example :SEGMents:STATE ON
 STOP
 :SEGMents:MEASure:MODE PLOT
 :SEGMents:MEASure:PLOT:SOURce 1
 :SEGMents:MEASure:PLOT:DIVide 10
 :SEGMents:MEASure:PLOT:SElect 1
 :SEGMents:MEASure:PLOT:RESults?
 > MAX,1.000kHz;MIN,1.000kHz;MEAN,1.000kHz;
 Bin Statistics,1 of 10;Percent,10.00%;Count,1;
 Measured,10;Unmeasured,0;Bin Range,
 1.000kHz~1.000kHz;
 Plots the results for automatic measurement #1,
 bin 1 of 10.

:SEGMents:MEASure:TABLE:SOURce Set →
→ Query

Description	Sets or queries the source of the measurement list.	
Syntax	:SEGMents:MEASure:TABLE:SOURce {CH1 CH2 ? }	
Related commands	:SEGMents:MEASure:MODE :SEGMents:MEASure:TABLE:SElect :SEGMents:MEASure:TABLE:LIST	
Parameter/ Return parameter	CH1~CH2	Channel 1 to 2
Example1	:SEGMents:MEASure:TABLE:SOURce CH1 Sets the source to CH1.	

:SEGMents:MEASure:TABLE:SElect Set →
→ Query

Description	Sets or queries a segment to view in the measurement table.	
Syntax	:SEGMents:MEASure:TABLE:SElect {<NR1> ? }	
Related commands	:SEGMents:TOTalnum	

Parameter	<NR1>	1~29000
-----------	-------	---------

Return parameter	Returns the number of segments as <NR3>.
------------------	--

Example1	:SEGMENTS:MEASURE:TABLE:SELECT 10 Select segment number 10.
----------	--

:SEGMENTS:MEASURE:TABLE:LIST → Query

Description	Returns the measurement results of each segment in the block data.
-------------	--

Syntax	:SEGMENTS:MEASURE:TABLE:LIST?
--------	-------------------------------

Return parameter	Returns the measurements results as a block data for each segment.
------------------	--

Example	:SEGMENTS:MEASURE:TABLE:LIST? >"GW MPO-2102P, serial number PXXXXXX, version V1.37", Segment Summary : CH1, Seg., Pk-Pk (V), Pk-Pk (V), 1, 8.00m, 8.00m, 2, 8.00m, 8.00m, 3, 8.00m, 8.00m, 4, 8.00m, 8.00m, 5, 8.00m, 8.00m, 6, 8.00m, 8.00m, 7, 8.00m, 8.00m, 8, 8.00m, 8.00m, 9, 12.0m, 12.0m, 10, 8.00m, 8.00m,
---------	--

:SEGMENTS:MEASURE:TABLE:SAVE Set →

Description	Saves the list of segment automatic measurement results.
-------------	--

Syntax	:SEGMENTS:MEASURE:TABLE:SAVE
--------	------------------------------

:SEGMents:SAVe

Set →

Description	Saves the segments.
Syntax	:SEGMents:SAVe
Related Commands	:SEGMents:SAVe:SOURce :SEGMents:SAVe:SELEct:STARt :SEGMents:SAVe:SELEct:END
Example	:SEGMents:SAVe:SOURce CH1 :SEGMents:SAVe:SELEct:STARt 1 :SEGMents:SAVe:SELEct:END 10 :SEGMents:SAVe

:SEGMents:SAVe:SOURce

Set →
→ Query

Description	Sets or queries the source segment waveform to save.
Syntax	:SEGMents:SAVe:SOURce {CH1 CH2 ? }
Parameter/ Return parameter	CH1~CH2 Channel 1 to 2.
Example	:SEGMents:SAVe:SOURce CH1 >Sets the source to CH1.

:SEGMents:SAVe:SELEct:STARt

Set →
→ Query

Description	Sets or queries the starting segment to save from. The number of possible segments depends on the record length.
Syntax	:SEGMents:SAVe:SELEct:STARt {SETTOMIN SETTOMAX <NR1> ? }
Related commands	:SEGMents:TOTALnum

Parameter/ Return parameter	SETTOMIN	Sets the starting segment to min segment.
	SETTOMAX	Sets the starting segment to the max segment.
	<NR1>	Sets the segment to 1~29000

Example :SEGMents:SAVe:SElect:STARt 2
Sets the starting segment to segment number 2.

:SEGMents:SAVe:SElect:END (Set) →
→ (Query)

Description Sets or queries the ending segment to save from. The number of possible segments depends on the record length.

Syntax :SEGMents:SAVe:SElect:END
{SETTOMIN | SETTOMAX | <NR1> | ? }

Related commands :SEGMents:TOTAlnum

Parameter/ Return parameter	SETTOMIN	Sets the starting segment to min segment.
	SETTOMAX	Sets the starting segment to the max segment.
	<NR1>	Sets the segment to 1~29000.

Return parameter <NR3> Returns the ending segment as NR3.

Example :SEGMents:SAVe:SElect:END 10
Sets the ending segment to segment number 10.

DVM Commands

The DVM commands are only available when the optional DVM software is installed.

:DVM:STATE	226
:DVM:SOURce	226
:DVM:MODE	227
:DVM:VALue	227

:DVM:STATE



Description	Sets or queries the DVM state to on or off.	
Syntax	:DVM:STATE {OFF ON ? }	
Related commands	:DVM:SOURce :DVM:MODE	
Parameter/ Return parameter	OFF	Turns the DVM off.
	ON	Turns the DVM on.
Example	:DVM:STATE ON Turns the DVM state on.	

:DVM:SOURce



Description	Sets or queries the source of the DVM.	
Syntax	:DVM:SOURce {CH1 CH2 ?}	
Related commands	:DVM:STATE :DVM:MODE	
Parameter/ Return parameter	CH1~CH2	Channel 1 to 2.
Example	:DVM:SOURce CH1 Sets the DVM source to channel 1.	

Set → → Query											
:DVM:MODE											
Description	Sets or queries the DVM mode.										
Syntax	:DVM:MODE {ACRMS DC DCRMS DUTY FREQUENCY ?}										
Related commands	:DVM:SOURce :DVM:STATE										
Parameter/ Return parameter	<table border="0"> <tr> <td style="padding-right: 10px;">ACRMS</td> <td>Sets the mode to AC RMS</td> </tr> <tr> <td>DC</td> <td>Sets the mode to DC</td> </tr> <tr> <td>DCRMS</td> <td>Sets the mode to DC RMS</td> </tr> <tr> <td>DUTY</td> <td>Sets the mode to AC Duty</td> </tr> <tr> <td>FREQUENCY</td> <td>Sets the mode to AC frequency</td> </tr> </table>	ACRMS	Sets the mode to AC RMS	DC	Sets the mode to DC	DCRMS	Sets the mode to DC RMS	DUTY	Sets the mode to AC Duty	FREQUENCY	Sets the mode to AC frequency
ACRMS	Sets the mode to AC RMS										
DC	Sets the mode to DC										
DCRMS	Sets the mode to DC RMS										
DUTY	Sets the mode to AC Duty										
FREQUENCY	Sets the mode to AC frequency										
Example	:DVM:MODE DUTY Sets the DVM mode to DUTY.										

→ Query	
:DVM:VALue	
Description	Returns the measurement value of the selected mode.
Syntax	:DVM:VALue?
Related commands	:DVM:SOURce :DVM:STATE :DVD:MODE
Return parameter	Returns the measurement value as <NR3>.
Example	:DVM:VALue? >8.410E-04 Returns the measurement.

Go_NoGo Commands

The GoNoGo APP must first be launched (or use the command, “:GONogo:SCRipt”) before any of the Go_NoGo or Template commands can be used.

:GONogo:CLear.....	228
:GONogo:EXECute	228
:GONogo:FUNCTion.....	229
:GONogo:NGCount	229
:GONogo:NGDefine.....	229
:GONogo:SOURce	230
:GONogo:VIOLation	230
:GONogo:SCRipt	230
:TEMPlate:MODE	231
:TEMPlate:MAXimum.....	231
:TEMPlate:MINimum.....	231
:TEMPlate:POSition:MAXimum.....	232
:TEMPlate:POSition:MINimum	232
:TEMPlate:SAVe:MAXimum	232
:TEMPlate:SAVe:MINimum	233
:TEMPlate:TOLerance.....	233
:TEMPlate:SAVe:AUTO	233

:GONogo:CLear

Set →

Description Clears the Go/NoGo counter.

Syntax :GONogo:CLear

:GONogo:EXECute

Set →
→ Query

Description Enables or disables the Go/NoGo function or queries its state.

Syntax :GONogo:EXECute {OFF|ON|?}

Parameter/	OFF	Disabled
Return Parameter	ON	Enabled
Example	:GONogo:EXECute OFF Turns Go/NoGo off.	

:GONogo:FUNCTion (Set) →

Description	Initializes the Go/NoGo APP. This must be run after the Go/NoGo APP has been started.
Syntax	:GONogo:FUNCTion

:GONogo:NGCount → (Query)

Description	Returns the Go/NoGo counter.
Syntax	:GONogo:NGCount{?}
Return parameter	Returns a string in the following format “number of violations,total tests”
Example	:GONogo:NGCount? > 3,25 Indicates that 3 violations occurred over 25 tests.

:GONogo:NGDefine (Set) →
→ (Query)

Description	Sets the Go/NoGo “When” conditions.	
Syntax	:GONogo:NGDefine {EXITs ENTers?}	
Parameter/ Return Parameter	EXITs	Sets the NoGo condition to when the input signal exceeds the limit boundary.
	ENTers	Sets the NoGo condition to when the input signal stays within the limit boundary.
Example	:GONogo:NGDefine EXITs Sets the Go/NoGo condition to EXITs.	

Set →
 → Query

:GONogo:SOURce	
Description	Sets the source for the Go/NoGo signal.
Syntax	:GONogo:SOURce {CH1 CH2 ?}
Parameter/ Return Parameter	CH1~CH2
Example	:GONogo:SOURce CH1 Sets the source to CH1.

Set →
 → Query

:GONogo:VIOLation	
Description	Sets or returns actions for the Go/NoGo violations.
Syntax	:GONogo:VIOLation {STOP CONTInue ?}
Parameter/ Return Parameter	STOP The waveform will be frozen. CONTInue Ignore the violation.
Example	:GONogo:VIOLation STOP Sets violation action to STOP.

Set →

:GONogo:SCRipt	
Description	Activates/Deactivates the Go/NoGo APP or queries its state.
Syntax	:GONogo:SCRipt {OFF ON ?}
Parameter/ Return Parameter	ON Turns Go/NoGo APP on. OFF Turns the Go/NoGo APP off.
Example	:GONogo:SCRipt? >ON The Go/NoGo script is on.

Set →
→ Query

:TEMPlate:MODE

Description	Sets or returns the Go/NoGo template mode.	
Syntax	:TEMPlate:MODE {MAXimum MINimum AUTO ?}	
Parameter/ Return Parameter	MAXimum	Maximum template
	MINimum	Minimum template
	AUTO	Auto template
Example	:TEMPlate:MODE AUTO Sets the template mode to AUTO.	

Set →
→ Query

:TEMPlate:MAXimum

Description	Defines or queries which waveform memory (REF1 or W1~W20) is set to the maximum template.	
Syntax	:TEMPlate:MAXimum {REF1 W1~W20 ?}	
Parameter/ Return Parameter	REF1	Reference one
	W1~W20	Waveform memory 1 to 20
Example	:TEMPlate:MAXimum REF1 Saves the maximum template to REF1.	

Set →
→ Query

:TEMPlate:MINimum

Description	Defines or queries which waveform memory (REF1 or W1~W20) is set to the minimum template.	
Syntax	:TEMPlate:MINimum {REF2 W1~W20 ?}	
Parameter/ Return Parameter	REF2	Reference one
	W1~W20	Waveform memory 1 to 20

Example :TEMPlate:MINimum REF2
Saves the minimum template to REF2.

Set →

:TEMPlate:POSition:MAXimum → Query

Description Sets or queries the position of the maximum template.

Syntax :TEMPlate:POSition:MAXimum {<NR2>|?}

Parameter <NR2> Desired template position (-12.0 ~ +12.0 divisions)

Return parameter Returns the position in the following format: "<NR2>Div"

Example :TEMPlate:POSition:MAXimum 3.00
Sets the maximum template position to 3.00 divisions.

Set →

:TEMPlate:POSition:MINimum → Query

Description Sets or queries the position of the minimum template.

Syntax :TEMPlate:POSition:MINimum {<NR2>|?}

Parameter <NR2> Desired template position (-12.0 ~ +12.0 divisions)

Return parameter Returns the position in the following format: "<NR2>Div"

Example :TEMPlate:POSition:MINimum 3.00
Sets the minimum template position to 3.00 divisions.

:TEMPlate:SAVE:MAXimum Set →

Description Saves the maximum template.

Syntax :TEMPlate:SAVE:MAXimum

:TEMPlate:SAVe:MINimum (Set) →

Description Saves the maximum template.

Syntax :TEMPlate:SAVe:MINimum

(Set) →

:TEMPlate:TOLerance

→ (Query)

Description Sets or queries the tolerance as a percentage.

Syntax :TEMPlate:TOLerance {<NR2>|?}

Parameter/ Return Parameter	<NR2>	The auto tolerance range (0.4% ~ 40%)
--------------------------------	-------	---------------------------------------

Example :TEMPlate:TOLerance 10
Sets the tolerance to 10%.

:TEMPlate:SAVe:AUTO (Set) →

Description Saves the AUTO template (maximum and minimum templates).

Syntax :TEMPlate:SAVe:AUTO

AWG Commands

:AWG:UTIL.....	235
:AWG:UTIL:AMPcpl	235
:AWG:UTIL:FREQcpl.....	236
:AWG:UTIL:FREQcpl:OFFSet	236
:AWG:UTIL:FREQcpl:RATio.....	237
:AWG:UTIL:TRACking.....	237
:AWG<x>:AMPlitude.....	237
:AWG<x>:FREQuency.....	238
:AWG<x>:FUNCTion	238
:AWG<x>:OFFSet	239
:AWG<x>:OUTPut:LOAd:IMPEDance	239
:AWG<x>:OUTPut:STATE	239
:AWG<x>:PHAsE.....	240
:AWG<x>:PULSe:DUTYcycle	240
:AWG<x>:RAMP:SYMmetry	240
:AWG<x>:MODulation:STATE	241
:AWG<x>:MODulation:TYPe.....	241
:AWG<x>:MODulation:AM:DEPth	241
:AWG<x>:MODulation:AM:FREQ.....	242
:AWG<x>:MODulation:AM:SHApe.....	242
:AWG<x>:MODulation:AM:PHAsE	242
:AWG<x>:MODulation:AM:DUTYcycle	243
:AWG<x>:MODulation:AM:SYMmetry	243
:AWG<x>:MODulation:AM:RATE	243
:AWG<x>:MODulation:FM:DEV	244
:AWG<x>:MODulation:FM:FREQ	244
:AWG<x>:MODulation:FM:SHApe	245
:AWG<x>:MODulation:FM:PHAsE	245
:AWG<x>:MODulation:FM:DUTYcycle.....	246
:AWG<x>:MODulation:FM:SYMmetry	246
:AWG<x>:MODulation:FM:RATE.....	246
:AWG<x>:MODulation:FSK:FREQ	247

:AWG<x>:MODulation:FSK:RATE247
 :AWG<x>:SWEep:STATE248
 :AWG<x>:SWEep:TYPe248
 :AWG<x>:SWEep:START248
 :AWG<x>:SWEep:STOP249
 :AWG<x>:SWEep:TIME.....249
 :AWG<x>:SWEep:SPAN.....249
 :AWG<x>:SWEep:CENTEr250
 :AWG<x>:ARBitrary:EDIT:NUMPoint250
 :AWG<x>:ARBitrary:EDIT:FUNCTion.....250
 :AWG<x>:ARBitrary:SAVe:WAVEform251
 :AWG<x>:ARBitrary:LOAd:WAVEform251
 :AWG<x>:ARBitrary:EDIT:COpy.....252
 :AWG<x>:ARBitrary:EDIT:CLEAr.....252
 :AWG<x>:ARBitrary:EDIT:LINE253
 :AWG<x>:ARBitrary:EDIT:SCALE.....253
 :AWG<x>:ARBitrary:EDIT:POINt.....254
 :AWG<x>:ARBitrary:EDIT:POINt:ADD.....254
 :AWG<x>:ARBitrary:EDIT:POINt:DELEte.....254

:AWG:UTIL



Description	Reset all of the AWG settings to the default.
Syntax	:AWG:UTIL{PRESet}
Parameter	PRESet Set the AWG settings to default.
Example	:AWG:UTIL PRESet

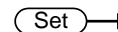

:AWG:UTIL:AMPCpl

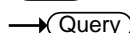

Description	Set or return the state of amplitude couple.
Syntax	:AWG:UTIL:AMPCpl{ON OFF} :AWG:UTIL:AMPCpl?
Parameter	ON Turn on the amplitude couple.

OFF Turn off the amplitude couple.

Example :AWG:UTIL:AMPCpl ON
:AWG:UTIL:AMPCpl?
>ON

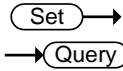

:AWG:UTIL:FREQCpl

Description Set or return the type of frequency couple.

Syntax :AWG:UTIL:FREQCpl {OFF| OFFSet| RATio}
:AWG:UTIL:FREQCpl?

Parameter	OFF	Turn off the Frequency Couple.
	OFFSet	The frequency of Gen. 1 and Gen. 2 are coupled by offset.
	RATio	The frequency of Gen. 1 and Gen. 2 are coupled by ratio.

Example :AWG:UTIL:FREQCpl RATio
:AWG:UTIL:FREQCpl?
>RATIO

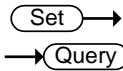

:AWG:UTIL:FREQCpl:OFFSet

Description Set or return the frequency offset between Gen. 1 and Gen. 2 for frequency couple

Syntax :AWG:UTIL:FREQCpl:OFFSet {<NRF>}
:AWG:UTIL:FREQCpl:OFFSet?

Parameter <NRF> Value of offset.

Example :AWG:UTIL:FREQCpl:OFFSet 50
:AWG:UTIL:FREQCpl:OFFSet?
>5.00000e+01

:AWG:UTIL:FREQCpl:RATio



Description Set or return the frequency ratio between Gen. 1 and Gen. 2 for frequency couple.

Syntax :AWG:UTIL:FREQCpl:RATio{<NRF>}
:AWG:UTIL:FREQCpl:RATio?

Parameter <NRF> Value of ratio.

Example :AWG:UTIL:FREQCpl:RATio 2.5
:AWG:UTIL:FREQCpl:RATio?
>2.50000e+00

:AWG:UTIL:TRACking



Description Set or return the state of AWG tracking.

Syntax :AWG:UTIL:TRACking{ON|OFF}
:AWG:UTIL:TRACking?

Parameter ON Turn on the AWG tracking.
OFF Turn off the AWG tracking.

Example :AWG:UTIL:TRACking ON
:AWG:UTIL:TRACking?
>ON

:AWG<x>:AMPlitude



Description Sets or returns the waveform amplitude.

Syntax :AWG<x>:AMPlitude {<NRF> | ?}

Related command :AWG<x>:OUTPut:LOAD:IMPEDance

Parameter/ Return parameter <x> Channel number 1~2.
<NRF> Amplitude in Volts.
(50Ω impedance 0.1~2.5V)
(High Z impedance 0.2~5V)

Example :AWG1:AMP 1

:AWG<x>:FREQuency

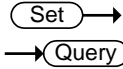

Description Sets or returns the waveform frequency.

Syntax :AWG<x>:FREQuency {<NRf> | ?}

Parameter/ Return parameter	<x> <NRf>	Channel number 1~2. Frequency in Hertz.
--------------------------------	--------------	--

Example :AWG1:FREQ 2000

:AWG<x>:FUNCTion

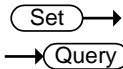

Description Sets or returns the type of waveform.

Syntax :AWG<x>:FUNCTion {ARBitrary | SINE | SQUAre | PULSe | RAMP | DC | NOISe | SINC | GAUSSian | LORENTz | EXPRise | EXPFall | HAVERSINE | CARDIac | ?}

Parameter/ Return parameter	<x> ARBitrary SINE SQUAre PULSe RAMP DC NOISe SINC GAUSSian LORENTz EXPRise EXPFall	Channel number 1~2. Arbitrary waveform Sine waveform Square waveform Pulse waveform Ramp waveform DC waveform Noise waveform Sinc waveform Gaussian waveform Lorentz waveform Exponential rise waveform Exponential fall waveform
--------------------------------	---	---

HAVERSINe	Haversine waveform
CARDIac	Cardiac waveform

Example :AWG1:FUNC?
>SINE

:AWG<x>:OFFSet

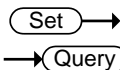

Description Sets or returns the waveform offset.

Syntax :AWG<x>:OFFSet {<NRf> | ?}

Parameter/ Return parameter	<x>	Channel number 1~2.
	<NRf>	Offset in Volts.

Example :AWG1:OFFS

:AWG<x>:OUTPut:LOAD:IMPEDance

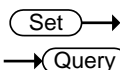

Description Sets or returns the output termination

Syntax :AWG<x>:OUTPut:LOAD:IMPEDance {FIFTy | HIGHZ | ?}

Parameter/ Return parameter	<x>	Channel number 1~2
	FIFTy	50 Ohm output termination
	HIGHZ	High Z output termination

Example :AWG1:OUTP:LOA:IMPED HIGHZ
Sets the output termination of channel 1 to high impedance.

:AWG<x>:OUTPut:STATE

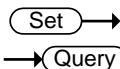

Description Sets or returns the channel output state.

Syntax :AWG<x>:OUTPut:STATE {OFF | ON | ?}

Parameter/ Return parameter	<x>	Channel number 1~2
	OFF	Turns the channel output off

ON Turns the channel output on

Example :AWG1:OUTP:STATE OFF
Turns the channel 1 output off.

:AWG<x>:PHase (Set) →
→ (Query)

Description Sets or returns the channel phase.

Syntax :AWG<x>:PHase {<NRf> | ?}

Parameter/ Return parameter <x> Channel number 1~2.
<NRf> Phase in degree -180~180°

Example :AWG1:PHA 45
Sets the channel 1 phase to 45°.

:AWG<x>:PULSe:DUTYcycle (Set) →
→ (Query)

Description Sets or returns the pulse duty cycle.

Syntax :AWG<x>:PULSe:DUTYcycle {<NRf> | ?}

Parameter/ Return parameter <x> Channel number 1~2.
<NRf> Duty cycle in percentage 0.2~99.8%

Example :AWG1:PULS:DUTY 50
Sets the channel 1 pulse duty cycle to 50%.

:AWG<x>:RAMP:SYMmetry (Set) →
→ (Query)

Description Sets or returns the ramp symmetry.

Syntax :AWG<x>:RAMP:SYMmetry {<NRf> | ?}

Parameter/ Return parameter <x> Channel number 1~2.
<NRf> Symmetry of the ramp waveform 0~100%

Example :AWG1:RAMP:SYM 15
Sets the channel 1 ramp symmetry to 15%.

:AWG<x>:MODulation:STATE



Description	Sets or returns the modulation state.	
Syntax	:AWG<x>:MODulation:STATE {OFF ON ?}	
Parameter/ Return parameter	<x>	Channel number 1~2.
	OFF	Sets the modulation to off.
	ON	Sets the modulation to on.
Example	:AWG1:MOD:STATE ON Turns the modulation on for channel 1.	

:AWG<x>:MODulation:TYPE



Description	Sets or returns the type of modulation.	
Syntax	:AWG<x>MODulation:TYPE {AM FM FSK ?}	
Parameter/ Return parameter	<x>	Channel number 1~2.
	AM	Sets a AM modulation.
	FM	Sets a FM modulation.
	FSK	Sets a FSK modulation.
Example	:AWG1:MOD:TYPE AM Sets a AM modulation for channel 1.	

:AWG<x>:MODulation:AM:DEPTH



Description	Sets or returns the AM modulation depth.	
Syntax	:AWG<x>:MODulation:AM:DEPTH {<NRF> ?}	
Parameter/ Return parameter	<x>	Channel number 1~2.
	<NRF>	AM depth in percentage 0~120%.
Example	:AWG1:MOD:AM:DEPTH >1.20000e+02	

:AWG<x>:MODulation:AM:FREQ (Set) →
→ (Query)

Description	Sets or returns the AM modulation frequency.	
Syntax	:AWG<x>:MODulation:AM:FREQ {<NRf> ?}	
Parameter/ Return parameter	<x>	Channel number 1~2.
	<NRf>	AM frequency in Hertz.
Example	:AWG1:MOD:AM:FREQ 1000 Sets the AM frequency to 1kHz.	

:AWG<x>:MODulation:AM:SHApe (Set) →
→ (Query)



Description	Sets or returns the shape of the AM modulation.	
Syntax	:AWG<x>:MODulation:AM:SHAPE {SINE SQUare PULSe RAMP NOISe ?}	
Parameter/ Return parameter	<x>	Channel number 1~2.
	SINE	Sine wave shape.
	SQUare	Square wave shape.
	PULSe	Pulse wave shape.
	RAMP	Ramp wave shape.
	NOISe	Noise wave shape.
Example	:AWG1:MOD:AM:SHA RAMP Sets a ramp shape to the AM modulating waveform.	

:AWG<x>:MODulation:AM:PHase (Set) →
→ (Query)

Description	Sets or returns the phase of the AM modulation (sine wave shape only).	
Syntax	:AWG<x>:MODulation:AM:PHase {<NRf> ?}	
Parameter/	<x>	Channel number 1~2.

Return parameter <NRf> Phase in degree -180~180°.

Example :AWG1:MOD:AM:PHA?
>-1.80000e+02

:AWG<x>:MODulation:AM:DUTYcycle  

Description Sets or returns the duty cycle of the AM modulation (pulse wave shape only).

Syntax :AWG<x>:MODulation:AM:DUTYcycle {<NRf> | ?}

Parameter/ Return parameter <x> Channel number 1~2.
<NRf> Duty cycle in percentage 2~98%.

Example :AWG1:MOD:AM:DUTY 50
Sets the duty cycle of the AM modulating waveform to 50%.

:AWG<x>:MODulation:AM:SYMmetry  

Description Sets or returns the symmetry of the AM modulation (ramp wave shape only).

Syntax :AWG<x>:MODulation:AM:SYMmetry {<NRf> | ?}

Parameter/ Return parameter <x> Channel number 1~2.
<NRf> Symmetry in percentage 0~100%.

Example :AWG1:MOD:AM:SYM 50
Sets the symmetry of the AM modulating waveform to 50%.

:AWG<x>:MODulation:AM:RATE  

Description Sets or returns the rate of the AM modulation (noise wave shape only).

Syntax :AWG<x>:MODulation:AM:RATE {RATE10M | RATE5M | RATE1M | RATE500K | RATE100K | RATE50K | RATE10K | RATE5K | RATE1K | ?}

Parameter/ Return parameter	<x>	Channel number 1~2.
	RATE10M	10MHz noise rate.
	RATE5M	5MHz noise rate.
	RATE1M	1MHz noise rate.
	RATE500K	500kHz noise rate.
	RATE100K	100kHz noise rate.
	RATE50K	50kHz noise rate.
	RATE10K	10kHz noise rate.
	RATE5K	5kHz noise rate.
	RATE1K	1kHz noise rate.

Example :AWG1:MOD:AM:RATE RATE5K
Sets the noise rate of the AM modulating waveform to 5kHz.

Set →

:AWG<x>:MODulation:FM:DEV

→ Query

Description Sets or returns the deviation of the FM modulation.

Syntax :AWG<x>:MODulation:FM:DEV {<NRF> | ?}

Parameter/ Return parameter	<x>	Channel number 1~2.
	<NRF>	Frequency deviation in Hertz.

Example :AWG1:MOD:FM:DEV?
>2.000000000e+02

Set →

:AWG<x>:MODulation:FM:FREQ

→ Query

Description Sets or returns the frequency of the FM modulation.

Syntax :AWG<x>:MODulation:FM:FREQ {<NRF> | ?}

Parameter/	<x>	Channel number 1~2.
Return parameter	<NRf>	Frequency in Hertz.

Example :AWG1:MOD:FM:FREQ 1000
 Sets the frequency of the FM modulating waveform to 1kHz.

→
 →

:AWG<x>:MODulation:FM:SHApe

Description Sets or returns the shape of the FM modulation.

Syntax :AWG<x>:MODulation:FM:SHApe {SINE | SQUare | PULSe | RAMP | NOISe | ?}

Parameter/	<x>	Channel number 1~2.
Return parameter	SINE	Sine wave shape.
	SQUare	Square wave shape.
	PULSe	Pulse wave shape.
	RAMP	Ramp wave shape.
	NOISe	Noise wave shape.

Example :AWG1:MOD:FM:SHA SINE
 Sets a sine shape to the FM modulation.

→
 →

:AWG<x>:MODulation:FM:PHAsE

Description Sets or returns the phase of the FM modulation (sine wave shape only).

Syntax :AWG<x>:MODulation:FM:PHAsE [<NRf> | ?]

Parameter/	<x>	Channel number 1~2.
Return parameter	<NRf>	Phase in degree -180~180°.

Example :AWG1:MOD:FM:PHA 90
 Sets a 90° phase to the FM modulating waveform.

:AWG<x>:MODulation:FM:DUTYcycle (Set) →
→ (Query)

Description	Sets or returns the duty cycle of the FM modulation (pulse shape wave only).	
Syntax	:AWG<x>:MODulation:FM:DUTYcycle {<Nrf> ?}	
Parameter/ Return parameter	<x>	Channel number 1~2.
	<Nrf>	Duty cycle in percentage 1~99%.
Example	:AWG1:MOD:FM:DUTY 50 Sets the duty cycle of the FM modulating waveform to 50%.	

:AWG<x>:MODulation:FM:SYMmetry (Set) →
→ (Query)

Description	Sets or returns the symmetry of the FM modulation (ramp shape wave only).	
Syntax	:AWG<x>:MODulation:FM:SYMmetry {<Nrf> ?}	
Parameter/ Return parameter	<x>	Channel number 1~2.
	<Nrf>	Symmetry in percentage 0~100%.
Example	:AWG1:MOD:FM:SYM 50 Sets the symmetry of the FM modulating waveform to 50%.	

:AWG<x>:MODulation:FM:RATE (Set) →
→ (Query)

Description	Sets or returns the noise rate of the FM modulation (noise shape wave only).	
Syntax	:AWG<x>:MODulation:FM:RATE {RATE10M RATE5M RATE1M RATE500K RATE100K RATE50K RATE10K RATE5K RATE1K ?}	
Parameter/ Return parameter	<x>	Channel number 1~2.
	RATE10M	10MHz noise rate.

RATE5M	5MHz noise rate.
RATE1M	1MHz noise rate.
RATE500K	500kHz noise rate.
RATE100K	100kHz noise rate.
RATE50K	50kHz noise rate.
RATE10K	10kHz noise rate.
RATE5K	5kHz noise rate.
RATE1K	1kHz noise rate.

Example :AWG1:MOD:FM:RATE RATE5K
 Sets the noise rate of the FM modulating waveform to 5kHz.

Set →
 → Query

:AWG<x>:MODulation:FSK:FREQ

Description Sets or returns the hop frequency of the FSK modulation.

Syntax :AWG<x>:MODulation:FSK:FREQ {<NRF> | ?}

Parameter/ Return parameter	<x>	Channel number 1~2.
	<NRF>	Frequency in Hertz.

Example :AWG1:MOD:FSK:FREQ 2000000
 Sets the FSK hop frequency to 2MHz.

Set →
 → Query

:AWG<x>:MODulation:FSK:RATE

Description Sets or returns the FSK modulation rate.

Syntax :AWG<x>:MODulation:FSK:RATE {<NRF> | ?}

Parameter/ Return parameter	<x>	Channel number 1~2.
	<NRF>	Frequency in Hertz.

Example :AWG1:MOD:FSK:RATE 100000
 Sets the FSK rate to 100kHz.

:AWG<x>:SWEep:STATE (Set) →
→ (Query)

Description	Sets or returns the Sweep mode state.	
Syntax	:AWG<x>:SWEep:STATE {OFF ON ?}	
Parameter/ Return parameter	<x>	Channel number 1~2.
	OFF	Sets the sweep mode to off.
	ON	Sets the sweep mode to on.
Example	:AWG1:SWE:STATE ON Turns the sweep mode to on for channel 1.	

:AWG<x>:SWEep:TYPe (Set) →
→ (Query)

Description	Sets or returns the sweep mode type.	
Syntax	:AWG<x>:SWEep:TYPe {LINEAR LOG ?}	
Parameter/ Return parameter	<x>	Channel number 1~2.
	LINEAR	Sets the sweep mode to linear.
	LOG	Sets the sweep mode to logarithmic.
Example	:AWG1:SWE:TYP LIN Sets the sweep mode to linear for channel 1.	

:AWG<x>:SWEep:START (Set) →
→ (Query)

Description	Sets or returns the start frequency of the sweep mode.	
Syntax	:AWG<x>:SWEep:START {<NRf> ?}	
Parameter/ Return parameter	<x>	Channel number 1~2.
	<NRf>	Start frequency in Hertz.
Example	:AWG1:SWE:START 1000 Sets the sweep mode start frequency to 1kHz.	

:AWG<x>:SWEep:STOP





Description Sets or returns the stop frequency of the sweep mode.

Syntax :AWG<x>:SWEep:STOP {<NRf> | ?}

Parameter/ Return parameter	<x>	Channel number 1~2.
	<NRf>	Stop frequency in Hertz.

Example :AWG1:SWE:STOP 500000
Sets the sweep mode stop frequency to 500kHz.

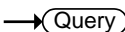
:AWG<x>:SWEep:TIME

Description Sets or returns the sweep time.

Syntax :AWG<x>:SWEep:TIME {<NRf> | ?}

Parameter/ Return parameter	<x>	Channel number 1~2.
	<NRf>	Sweep time in seconds.

Example :AWG1:SWE:TIM 6.500e-01
Sets the sweep time to 650ms.

:AWG<x>:SWEep:SPAN



Description Alternatively to setting the start and stop frequencies, the span and center frequency can be set.

Syntax :AWG<x>:SWEep:SPAN {<NRf> | ?}

Parameter/ Return parameter	<x>	Channel number 1~2.
	<NRf>	Span of the sweep in Hertz.

Example :AWG1:SWE:SPAN 1100
Sets the span of the sweep to 1.1kHz.

Set →
 → Query

:AWG<x>:SWEep:CENTer

Description	Alternatively to setting the start and stop frequencies, the span and center frequency can be set.				
Syntax	:AWG<x>:SWEep:CENTer {<NRF> ?}				
Parameter/ Return parameter	<table border="0" style="width: 100%;"> <tr> <td style="width: 15%; background-color: #e0e0e0;"><x></td> <td>Channel number 1~2.</td> </tr> <tr> <td style="background-color: #e0e0e0;"><NRF></td> <td>Center frequency of the sweep in Hertz.</td> </tr> </table>	<x>	Channel number 1~2.	<NRF>	Center frequency of the sweep in Hertz.
<x>	Channel number 1~2.				
<NRF>	Center frequency of the sweep in Hertz.				
Example	:AWG1:SWE:CENT 550 Sets the center frequency of the sweep to 550Hz.				

Set →
 → Query

:AWG<x>:ARBITrary:EDIT:NUMPoint

Description	Sets or returns the number of points of an arbitrary waveform.				
Syntax	:AWG<x>:ARBITrary:EDIT:NUMPoint { <NR1> ?}				
Parameter/ Return parameter	<table border="0" style="width: 100%;"> <tr> <td style="width: 15%; background-color: #e0e0e0;"><x></td> <td>Channel number 1~2.</td> </tr> <tr> <td style="background-color: #e0e0e0;"><NR1></td> <td>Number of points</td> </tr> </table>	<x>	Channel number 1~2.	<NR1>	Number of points
<x>	Channel number 1~2.				
<NR1>	Number of points				
Example	:AWG1:ARB:EDIT:NUMP 1500 Sets 1500 points for the arbitrary waveform.				

Set →

:AWG<x>:ARBITrary:EDIT:FUNCTION

Description	Sets the inbuilt waveform of the arbitrary waveform.								
Syntax	:AWG<x>:ARBITrary:EDIT:FUNCTION { SINE SQUARE PULSE RAMP NOISE }								
Parameter	<table border="0" style="width: 100%;"> <tr> <td style="width: 15%; background-color: #e0e0e0;"><x></td> <td>Channel number 1~2.</td> </tr> <tr> <td style="background-color: #e0e0e0;">SINE</td> <td>Sine wave shape.</td> </tr> <tr> <td style="background-color: #e0e0e0;">SQUARE</td> <td>Square wave shape.</td> </tr> <tr> <td style="background-color: #e0e0e0;">PULSE</td> <td>Pulse wave shape.</td> </tr> </table>	<x>	Channel number 1~2.	SINE	Sine wave shape.	SQUARE	Square wave shape.	PULSE	Pulse wave shape.
<x>	Channel number 1~2.								
SINE	Sine wave shape.								
SQUARE	Square wave shape.								
PULSE	Pulse wave shape.								

RAMP	Ramp wave shape.
NOISe	Noise wave shape.

Example :AWG1:ARB:EDIT:FUNCT RAMP
Sets a ramp shape to the arbitrary waveform.

:AWG<x>:ARbitrary:SAVe:WAVEform 

Description	Saves an arbitrary waveform.	
Syntax	:AWG<x>:ARbitrary:SAVe:WAVEform {ARB1 ARB2 ARB3 ARB4 <file path>}	
Parameter	<x>	Channel number 1~2.
	ARB1~4	Saves the arbitrary waveform to one of the internal memory slots.
	<file path>	Saves the arbitrary waveform to disk or USB to the specified file path. Example: "Disk:/xxx.UAW" "USB:/xxx.UAW"

Example :AWG1:ARB:SAVE:WAVE ARB2
Saves the arbitrary waveform to ARB2.

:AWG<x>:ARbitrary:LOAD:WAVEform 

Description	Loads an arbitrary waveform.	
Syntax	:AWG<x>:ARbitrary:LOAD:WAVEform {ARB1 ARB2 ARB3 ARB4 <file path>}	
Parameter	<x>	Channel number 1~2.
	ARB1~4	Loads the arbitrary waveform from one of the internal memory slots.

<code><file path></code>	Loads the arbitrary waveform from disk or USB at the specified file path. Example: "Disk:/xxx.UAW" "USB:/xxx.UAW"
--------------------------------	--

Example :AWG1:ARB:LOA:WAVE ARB2
Loads the arbitrary waveform from ARB2.

:AWG<x>:ARBitrary:EDIT:COpy Set →

Description Copies a segment of an arbitrary waveform to a specific point.

Syntax :AWG<x>:ARBitrary:EDIT:COpy {<START> , <LENGth> , <PASTe>}

Parameter	<code><x></code>	Channel number 1~2.
	<code><START></code>	NR1, point at which the segment to copy starts.
	<code><LENGth></code>	NR1, length of the segment to copy.
	<code><PASTe></code>	NR1, point at which the segment is to be copied.

Example :AWG1:ARB:EDIT:COpy 5,100,106
Copies a segment of 100 points starting from point 5 of an arbitrary waveform and paste it to point 106 of this arbitrary waveform.

:AWG<x>:ARBitrary:EDIT:CLear Set →

Description Deletes a segment of an arbitrary waveform

Syntax :AWG<x>:ARBitrary:EDIT:CLear { ALL | <START> , <LENGth> }

Parameter	<code><x></code>	Channel number 1~2.
	ALL	Deletes the entire arbitrary waveform.

<STARTt>	NR1, point at which the segment to delete starts.
<LENGth>	NR1, length of the segment to delete.

Example :AWG1:ARB:EDIT:CLE ALL

:AWG<x>:ARbitrary:EDIT:LINE

Description Creates a line on an arbitrary waveform.

Syntax :AWG<x>:ARbitrary:EDIT:LINE {<address1> , <data1> , address2> , <data2>}

Parameter	<x>	Channel number 1~2.
	<address1>	NR1, the point at which the line starts.
	<data1>	NRf, the value at the starting point.
	<address2>	NR1, the point at which the line ends.
	<data2>	NRf, the value at the ending point.

Example :AWG1:ARB:EDIT:LIN 40,0.05,100,0.1
Creates a line between point 40 at value 0.05 and point 100 at value 0.01.

:AWG<x>:ARbitrary:EDIT:SCALE

Description Sets the vertical scale of the arbitrary waveform.

Syntax :AWG<x>:ARbitrary:EDIT:SCALE {<NRf>}

Parameter	<x>	Channel number 1~2.
	<NRf>	Scale 0.1~ 10

Example :AWG1:ARB:EDIT:SCAL 5.5

:AWG<x>:ARbitrary:EDIT:POINT (Set) →

Description	Edits a single point on an arbitrary waveform.	
Syntax	:AWG<x>:ARbitrary:EDIT:POINT {<address1> , <data1>}	
Parameter	<x>	Channel number 1~2.
	<address1>	NR1, the point to be edited.
	<data1>	NRf, the value of that point.
Example	:AWG1:ARB:EDIT:POIN 20,0.2	

:AWG<x>:ARbitrary:EDIT:POINT:ADD (Set) →

Description	Adds the edited point to the arbitrary waveform.	
Syntax	:AWG<x>:ARbitrary:EDIT:POINT:ADD {<NR1>}	
Parameter	<x>	Channel number 1~2.
	<NR1>	The point to be added.
Example	:AWG1:ARB:EDIT:POIN:ADD 20	

:AWG<x>:ARbitrary:EDIT:POINT:DELEte (Set) →

Description	Adds the edited point to the arbitrary waveform.	
Syntax	:AWG<x>:ARbitrary:EDIT:POINT:DELEte {<NR1>}	
Parameter	<x>	Channel number 1~2.
	<NR1>	The point to be deleted.
Example	:AWG1:ARB:EDIT:POIN:DELE 20	

Data Logging Commands

:DATALOG:STATE	255
:DATALOG:SOURce	255
:DATALOG:SAVe	256
:DATALOG:INTerval	256
:DATALOG:DURation	257

:DATALOG:STATE



Description	Sets or queries the state of the data logging app.	
Syntax	:DATALOG:STATE {OFF ON ?}	
Related commands	:DATALOG:SOURce :DATALOG:SAVe :DATALOG:INTerval :DATALOG:DURation	
Parameter/ Return parameter	OFF	Turns the data logging off.
	ON	Turns the data logging on.
Example	:DATALOG:STATE ON Turns the data logging app on.	

:DATALOG:SOURce



Description	Sets or queries the data logging source channel.	
Syntax	:DATALOG:SOURce { CH1~CH2 all ? }	
Related commands	:DATALOG:STATE :DATALOG:SAVe :DATALOG:INTerval :DATALOG:DURation	

Parameter/Return parameter	CH1 ~CH2 all	Channel 1, 2 All displayed channels.
----------------------------	-----------------	---

Example :DATALOG:SOURce CH1
Sets the source to CH1.

:DATALOG:SAVe (Set) →
→ (Query)

Description Sets or queries the save format as image or waveform.

Syntax :DATALOG:SAVe {IMAGe|WAVEform|?}

Related commands :DATALOG:STATE
:DATALOG:SOURce
:DATALOG:INTerval
:DATALOG:DURation

Parameter/Return parameter	IMAGe	Save as images.
	WAVEform	Save as waveforms.

Example :DATALOG:SAVe WAVEform
Sets the save format to waveform.

:DATALOG:INTerval (Set) →
→ (Query)

Description Sets or queries the interval time between each recording.

Syntax :DATALOG:INTerval <NRF>
:DATALOG:INTerval?

Related commands :DATALOG:STATE
:DATALOG:SOURce
:DATALOG:SAVe
:DATALOG:DURation

Parameter <NRF> Discrete time intervals in seconds:

Example :DATALOG:INT 2
Sets the interval time to 2 seconds.

:DATALOG:DURation

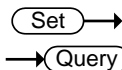

Description Sets or queries the duration time of each recording.

Syntax :DATALOG:DURation <NRf>
:DATALOG:DURation?

Related commands :DATALOG:STATE
:DATALOG:SOURce
:DATALOG:SAVe
:DATALOG:INTerval

Parameter <NRf> Discrete recording time in seconds.

Example :DATALOG:DUR 5
Sets the recording time to 5 seconds.

Remote Disk Commands

:REMOTEDisk:IPADDRESS.....	258
:REMOTEDisk:PATHName.....	258
:REMOTEDisk:USERName.....	259
:REMOTEDisk:PASSWord.....	259
:REMOTEDisk:MOUNT.....	259
:REMOTEDisk:AUTOMount.....	260

:REMOTEDisk:IPADDRESS



Description	Sets or returns the IP address of remote disk.	
Syntax	:REMOTEDisk:IPADDRESS {<string> ?}	
Parameter/ Return parameter	<string>	IP address enclosed in double quotes. Eg., 172.16.20.255
Example	:REMOTEDisk:IPADDRESS "172.16.20.255" Sets the remote disk IP address as 172.16.20.255.	

:REMOTEDisk:PATHName



Description	Sets or returns the file path of the remote disk.	
Syntax	:REMOTEDisk:PATHName {<string> ?}	
Parameter/ Return parameter	<string>	File path in enclosed in double quotes eg., "remote_disk"
Example	:REMOTEDisk:PATHName "remote_disk" Sets the file path to c:/remote_disk.	

Set →
 → Query

:REMOTEDisk:USERName

Description Sets or queries the account username for the remote disk.

Syntax :REMOTEDisk:USERName {<string> | ? }

Parameter/Return parameter <string> User name enclosed in double quotes eg., "User_Name".

Example :REMOTEDisk:USERName "User_Name"
 Sets the account name as User_Name.

Set →
 → Query

:REMOTEDisk:PASSWORD

Description Sets or queries the account password for the remote disk.

Syntax :REMOTEDisk:PASSWORD {<string> | ? }

Parameter/Return parameter <string> Username password enclosed in double quotes eg., "Password".

Example :REMOTEDisk:PASSWORD "Password"
 Sets the account password as Password.

Set →
 → Query

:REMOTEDisk:MOUNT

Description Turns remote disk on/off or queries its state.

Syntax :REMOTEDisk:MOUNT { OFF | ON | ? }

Parameter/Return parameter OFF Unmount remote disk
 ON Mount remote disk

Example :REMOTEDisk:IPADdress "172.16.5.154"
 :REMOTEDisk:PATHName "remote_disk"
 :REMOTEDisk:USERName "guest"
 :REMOTEDisk:PASSWord "password"
 :REMOTEDisk:MOUNT ON
 Sets the remote disk parameters and mounts the remote disk.

Set →

:REMOTEDisk:AUTOMount

→ Query

Description Turns automount on/off or queries its state. The remote disk must be configured beforehand.



Syntax :REMOTEDisk:AUTOMount { OFF | ON | ? }

Parameter/Return parameter	OFF	Don't mount the remote disk at start up.
	ON	Automatically mount the remote disk on start up.

Example :REMOTEDisk:AUTOMount ON
 Turns the automount function on.

Spectrum Analyzer Commands

:SA:STATE	262
:SA:LIST	262
:SA:MEMory	262
:SA:MEMory:SOURce	264
:SA:SOURce	265
:SA<x>:SPECTRUMTrace	265
:SA<x>:NORMal	266
:SA<x>:MAXHold	266
:SA<x>:MINHold	266
:SA<x>:AVERage	267
:SA<x>:AVERage:NUMAVg	267
:SA<x>:DETECTIonmethod:MODE	268
:SA<x>:DETECTIonmethod:MAXHold	268
:SA<x>:DETECTIonmethod:MINHold	269
:SA<x>:DETECTIonmethod:NORMal	269
:SA<x>:DETECTIonmethod:AVERage	270
:SA<x>:FREQUency	270
:SA<x>:SPAN	271
:SA<x>:START	271
:SA<x>:STOP	271
:SA<x>:RBW:MODE	272
:SA<x>:RBW	272
:SA<x>:SPANRbwratio	273
:SA<x>:WINDown	273
:SA<x>:UNIts	274
:SA<x>:SCALE	274
:SA:POSition	275
:SA<x>:INPut	275
:SA:SPECTRogram:NUMSLICES?	276
:SA<x>:SPECTRogram:SLICESElect	276
:SA<x>:SPECTRogram:SLICETIME?	276
:SA:SPECTRogram:STATe	277

		 
<hr/>		
:SA:STATE		
Description	Sets or returns the state of the spectrum analyzer.	
Syntax	:SA:STATE {OFF ON} :SA:STATE?	
Parameter	OFF	Disable this function.
	ON	Enable this function.
Example	SA:STATE ON SA:STATE? ON	

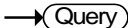
		
<hr/>		
:SA:LIST		
Description	Returns the data of the spectrum analyzer peak table.	
Syntax	:SA:LIST?	
Example	SA:LIST? NO., Frequency, Value; 1, 1.482E+07, -7.680E+01; 2, 2.790E+07, -7.600E+01; 3, 3.670E+07, -7.600E+01;	

		
<hr/>		
:SA:MEMory		
Description	Returns the data in acquisition memory for the spectrum analyzer function as a header + raw data.	
Syntax	:SA:MEMory?	
Related Commands	:SA:MEMory:SOURce	
Return parameter	<string> <waveform block data>	Returns acquisition settings followed by raw waveform block data.
	<string>	

Returns the spectrum analyzer settings .

Format:

parameter(1),setting(1);parameter(2),setting(2)...parameter(n),setting(n);Waveform Data;

<waveform block data>

Header followed by the raw waveform data.

Format:

Header: The header (in ASCII) encodes the number of bytes for the header followed by the number of data points in bytes for the raw data.

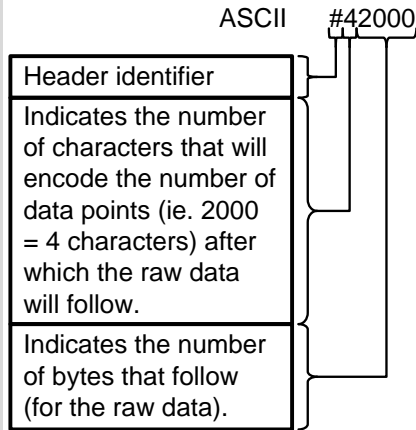

Raw Data:

Each two bytes (in hex) encodes the vertical data of a data point. The data is signed hex data (2's complement, -32768 ~ 32767).

Waveform Raw Data Example:

Header raw data.....

Hex:

23 34 32 30 30 30 00 1C 00 1B 00 1A 00

1A 00 1B

ASCII/Decimal:

#42000 28 27 26 26 27.....

The actual value of a data point can be calculated with the following formula:

(Decimal value of hex data/AD Factor) * vertical scale.

Note: AD Factor is fixed as 25. The vertical scale is returned with the acquisition settings that precede the raw data.

For example if the raw data for a point is 001C (=28 decimal) then,
 $(28/25) \times 0.5 = 0.56V$

Example

:SA:MEMory?

Format,2.0E;Firmware,V1.28;Time,24-Apr-17
 15:54:49;Memory
 Length,1.000E+03;Source,CH1;Probe
 Ratio,1.000E+00;Vertical Unit,dB;Vertical
 Position,3.000E+00;Vertical
 Scale,2.000E+01;Horizontal Unit,Hz;Horizontal
 Scale,1.000E+04;Sampling Period,1.000E+02;Center
 Frequency,2.300E+03;Span,1.000E+05;FREQUENCY,N
 ORM,Waveform Data;

#42000 follows waveform block data in hex

Set →

→ Query

:SA:MEMory:SOURce

Description

Sets or returns the source of the waveform data

Syntax

:SA:MEMory:SOURce {NORMal | AVErage| MAXHold
 | MINHold}

:SA:MEMory:SOURce?

Parameter/Return parameter	NORMAL	Normal data
	AVERage	Average data
	MAXHold	Maxhold data
	MINHold	Minhold data

Example :SA:MEMory:SOURce AVE
Sets the memory source to average data.

:SA:SOURce (Set) →
→ (Query)

Description Sets or returns the source of the spectrum analyzer

Syntax :SA:SOURce {CH1 | CH2| CH3 | CH4}
:SA:SOURce?

Parameter/Return parameter	CH1	Channel one
	CH2e	Chnanel two
	CH3	Channel three
	CH4	Channel four

Example :SA:SOURce CH2
Sets the source of spectrum analyzer to channel two.

:SA<x>:SPECTRUMTrace (Set) →

Description Resets all spectrum traces.

Syntax SA<x>:SPECTRUMTrace {RESET}

Parameter	RESET	Reset the trace
	<x>	1~2

Example :SA1:SPECTRUMTrace RESET
Reset the trace one of spectrum analyzer.

:SA<x>:NORMal (Set) →
→ (Query)

Description	Sets or returns the frequency domain Normal trace display on or off in the frequency domain graticule.	
Syntax	:SA<x>:NORMal {ON OFF} :SA<x>t:NORMal?	
Parameter/Return parameter	ON	Turns the normal trace display on.
	OFF	Turns the normal trace display off.
	<x>	1~2
Example	:SA<1>:NORMal ON Sets the normal trace one display on.	

:SA<x>:MAXHold (Set) →
→ (Query)

Description	Sets or returns the frequency domain Max Hold trace display on or off in the frequency domain graticule.	
Syntax	:SA<x>:MAXHold {ON OFF} :SA<x>:MAXHold?	
Parameter/Return parameter	ON	Turns the Max Hold trace display on.
	OFF	Turns the Max Hold trace display off.
	<x>	1~2
Example	:SA<1>:MAXHold OFF Sets the Max Hold trace one display off.	

:SA<x>:MINHold (Set) →
→ (Query)

Description	Sets or returns the frequency domain Min Hold trace display on or off in the frequency domain graticule.	
-------------	--	--

Syntax : SA<x>:MINHold {ON|OFF}
: SA<x>:MINHold?

Parameter/Return parameter	ON	Turns the Min Hold trace display on.
	OFF	Turns the Min Hold trace display off.
	<x>	1~2

Example : SA<2>:MINHold OFF
Sets the Min Hold trace two display off.

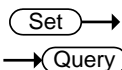

:SA<x>:AVERage

Description Sets or returns the frequency domain Average trace display on or off in the frequency domain graticule.

Syntax : SA<x>:AVERage {ON|OFF}
: SA<x>: AVERage?

Parameter/Return parameter	ON	Turns the Average trace display on.
	OFF	Turns the Average trace display off.
	<x>	1~2

Example : SA<1>: AVERage ON
Sets the Average trace one display on.

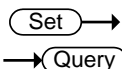

:SA<x>:AVERage:NUMAVg

Description Sets or returns the number of acquisitions to be used when creating the Average frequency domain trace.

Syntax :SA<x>:AVERage:NUMAVg {<NR1>}
:SA<x>:AVERage:NUMAVg?

Parameter/Return parameter	<NR1>	The range is 2 – 256, in exponential increments.
	<x>	1~2

Example :SA<x>:AVERage:NUMAVg 128
Sets the Average number of trace one to 128.

:SA<x>:DETECTIonmethod:MODE Set →
→ Query

Description Sets or returns the detection within the oscilloscope occurs automatically or manually.

Syntax :SA<x>:DETECTIonmethod:MODE {AUTO|MANUAL}
:SA<x>:DETECTIonmethod:MODE?

Related commands :SA<x>:DETECTIonmethod:MAXHold,:SA:DETECTIonmethod:MINHold
:SA<x>:DETECTIonmethod:NORMAL,:SA:DETECTIonmethod:AVERage

Parameter/Return parameter	AUTO	Automatically mode
	MANual	Manually mode
	<x>	1~2



Example :SA<1>:DETECTIonmethod:MODE AUTO
Sets the detection mode of trace one to automatic.

:SA<x>:DETECTIonmethod:MAXHold Set →
→ Query

Description Sets or returns the detection method of max Hold frequency domain trace.

Syntax :SA<x>:DETECTIonmethod:MAXHold {PLUSpeak|MINUSpeak|SAMPLE|AVERage}
:SA<x>:DETECTIonmethod:MAXHold?

Parameter/Return parameter	PLUSpeak	Sets the detection method to plus peak.
	MINUpeak	Sets the detection method to minus peak.
	SAMple	Sets the detection method to sample.
	AVERage	Sets the detection method to average.

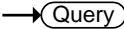
	<x>	1~2
Example	:SA<1>:DETECTIonmethod:MAXHold AVErAge Sets the detection method of trace one to average.	
		 → → 
<hr/>		
Description	Sets or returns the detection method of min Hold frequency domain trace.	
Syntax	:SA<x>:DETECTIonmethod:MINHold {PLUSpeak MINUSpeak SAMPLE AVErAge} :SA<x>:DETECTIonmethod:MINHold?	
Parameter/Return parameter	PLUSpeak	Sets the detection method to plus peak.
	MINUpeak	Sets the detection method to minus peak.
	SAMple	Sets the detection method to sample.
	AVErAge	Sets the detection method to average.
	<x>	1~2
Example	:SA<2>:DETECTIonmethod:MINHold AVErAge Sets the detection method of trace two to average.	
		 → → 
<hr/>		
Description	Sets or returns the detection method of normal frequency domain trace.	
Syntax	:SA<x>:DETECTIonmethod:NORMAl {PLUSpeak MINUSpeak SAMPLE AVErAge} :SA<x>:DETECTIonmethod:NORMAl?	
Parameter/Return parameter	PLUSpeak	Sets the detection method to plus peak.
	MINUpeak	Sets the detection method to minus peak.

SAMple	Sets the detection method to sample.
AVErage	Sets the detection method to average.
<x>	1~2

Example :SA<1>:DETECTIonmethod:NORMAl AVErage
Sets the detection method of trace one to average.

Set →

:SA<x>:DETECTIonmethod:AVErage → Query

Description Sets or returns the detection method of average frequency domain trace.

Syntax :SA<x>:DETECTIonmethod:AVErage
{PLUSpeak|MINUSpeak|SAMPlE|AVErage}
:SA<x>:DETECTIonmethod:AVErage?

Parameter/Return parameter	PLUSpeak	Sets the detection method to plus peak.
	MINUpeak	Sets the detection method to minus peak.
	SAMple	Sets the detection method to sample.
	AVErage	Sets the detection method to average.
	<x>	1~2

Example :SA<1>:DETECTIonmethod:AVErage AVErage
Sets the detection method of trace one to average.

Set →

:SA<x>:FREQUency → Query

Description Sets or returns the frequency (or center frequency) of the acquisition system.

Syntax :SA<x>:FREQUency {<NRf>|CENTER}
:SA<x>:FREQUency?

Parameter/Return parameter	<NRf>	Sets the frequency by user.
	CENTER	Sets the frequency to center.

<x> 1~2

Example SA<1>:FREQuency 3.0E+06
Sets the center frequency of trace one to 3 MHz.

Set →
→ Query

:SA<x>:SPAN

Description Sets or returns the span frequency setting.

Syntax :SA<x>:SPAN <Nrf>
:SA<x>:SPAN?

Parameter/Return parameter <Nrf> Sets the span frequency by user.

Example SA<1>:SPAN 25E+06
Sets the span frequency of trace one to 25 MH.

Set →
→ Query

:SA<x>:START

Description Sets or returns the start frequency setting.

Syntax :SA<x>:START <Nrf>
:SA<x>:START?

Parameter/Return parameter <Nrf> Sets the start frequency by user.
<x> 1~2

Example SA<1>:START -9.5E+06
Sets the start frequency of trace one to -9.5 MHz.

Set →
→ Query

:SA<x>:STOP

Description Sets or returns the stop frequency setting.

Syntax :SA<x>:STOP <Nrf>
:SA<x>:STOP?

Parameter/Return parameter <Nrf> Sets the stop frequency by user.
<x> 1~2

Example SA<1>:START 100E+06
 Sets the stop frequency of trace one to 100MHz.

Set →

:SA<x>:RBW:MODE

→ Query

Description Sets or returns the resolution bandwidth (RBW) mode, either automatic or manual.

Syntax :SA<x>:RBW:MODE {AUTO|MANual}
 :SA<x>:RBW:MODE?

Parameter/Return parameter	AUTO	Automatically mode.
	MANual	Manually mode.
	<x>	1~2

Example SA<1>:RBW:MODE AUTO
 Sets the mode of trace one to automatic.

Set →

:SA<x>:RBW

→ Query

Description Sets or returns the resolution bandwidth (RBW) when the RBW mode has been set to MANUAL (using the command SA:RBW:MODE).

Syntax :SA<x>:RBW <NRf>
 :SA<x>:RBW?

Related commands SA<x>:RBW:MODE

Parameter/Return parameter	<NRf>	Sets the RBW by user.
	<x>	1~2

Example Sets SA<1>:RBW 2.0E+04
 Query SA<1>:RBW?
 Return 1.825017e+04
 If the RBW set to 20kHz, the query will return the nearest value (1.825017e+04).

:SA<x>:SPANRbwratio



Description Sets or returns the resolution bandwidth (RBW) when the RBW mode has been set to AUTO (using the command SA<x>:RBW:MODE).

Syntax :SA<x>:SPANRbwratio
 {RATIO1K|RATIO2K|RATIO5K|RATIO10K|RATIO20K|RATIO50K|RATIO100K|RATIO200K|<NRf>}
 :SA<x>:SPANRbwratio?

Related commands SA<x>:RBW:MODE

Parameter/ Return parameter	<NRf>	Sets the RBW by user.
	RATIO1K	1000 : 1
	RATIO2K	2000 : 1
	RATIO5K	5000 : 1
	RATIO10K	10000 : 1
	RATIO20K	20000 : 1
	RATIO50K	50000 : 1
	RATIO100K	100000 : 1
	RATIO200K	200000 : 1
<x>	1~2	

Example :SA<1>:SPANRbwratio RATIO2K
 Sets the ratio of trace one to 2000:1.
 Sets :SA<1>:SPANRbwratio 2000
 Query :SA<1>:SPANRbwratio?
 Return RATIO2K

:SA<x>:WINDow

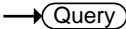
Description Sets or returns the windowing function, which is only used for traces.

Syntax :SA<x>:WINDow {RECTangular|HAMming|HANning|BLAckman}
:SA<x>:WINDow?

Parameter/ Return parameter	RECTangular	Sets to Rectangular window
	HAMming	Sets to Hamming window
	HANning	Sets to Hanning window
	BLAckman	Sets to Blackman window
	<x>	1~2

Example :SA<1>:WINDow HANning
Sets to the hanning window for the trace one.

:SA<x>:UNIts

Set →

→ Query

Description Sets or returns the vertical units.

Syntax :SA<x>:UNIts {DBV|LINEAR|DBM}
:SA<x>:UNIts?

Parameter/ Return parameter	DBV	Sets to DBV unit
	LINEAR	Sets to Linear unit
	DBM	Sets to DBM unit
	<x>	1~2

Example :SA<1>:UNIts DBM
Sets the unit of trace one to DBM unit.

Set →

→ Query

Description Sets or returns the overall vertical scale.

Syntax :SA<x>:SCAle <NRF>
:SA<x>:SCAle?

Related commands :SA<x>:UNIts

Parameter/ Return parameter	<NRf>	Vertical scale, the value may vary which depends on the unit selected. dBm and dBV : 1, 2, 5, 10, 20 (dB) Linear: 2m, 5m, 10m, 20m, 50m, 100m, 200m, 500m, 1, 2, 5, 10, 20, 50, 100, 200, 500, 1k (V)
	<x>	1~2

Example :SA<1>:SCALE 2
Sets the scale of trace one to 2.

:SA:POSition  

Description Sets or returns the overall vertical position.

Syntax :SA<x>:POSition <NRf>
:SA<x>:POSition?

Parameter/ Return parameter	<NRf>	Vertical position range: +/-12
	<x>	1~2

Example :SA<1>:POSition 3
Sets the vertical position of trace one to 3.

:SA<x>:INPut  

Description Sets or returns the input state of the spectrum analyzers.

Syntax :SA<x>:INPut {OFF|ON}
:SA<x>:INPut?

Parameter	ON	Turn off the SA<x> input.
	OFF	Turn on the SA<x> input.
	<x>	1~2

Example SA2:INPut ON
SA2:INPut?
ON

:SA:SPECTRogram:NUMSLICES? → Query

Description Query the total number of slice in spectrogram.
Syntax :SA:SPECTRogram:NUMSLICES?
Example SA:SPECTRogram:NUMSLICES?
57

Set →

:SA<x>:SPECTRogram:SLICESElect → Query

Description Set or query the selected slice in spectrogram.
Syntax :SA<x>:SPECTRogram:SLICESElect <NR1>
:SA<x>:SPECTRogram:SLICESElect?
Parameter <NR1> The number of slice. Range:0 ~ -197
<x> 1~2
Example SA2:SPECTRogram:SLICESElect -20
SA2:SPECTRogram:SLICESElect?
-20

:SA<x>:SPECTRogram:SLICETIME? → Query

Description Query the timestamp of selected slice.
Syntax :SA<x>:SPECTRogram:SLICETIME?
Parameter <x> 1~2
Example SA1:SPECTRogram:SLICETIME?

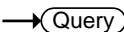
:SA:SPECTRogram:STATe					
	 				
Description	Set or query the state of spectrogram display.				
Syntax	:SA:SPECTRogram:STATe {OFF ON} :SA:SPECTRogram:STATe?				
Parameter	<table style="width: 100%; border-collapse: collapse;"> <tr> <td style="width: 10%; border: none;">OFF</td> <td style="border: none;">Turn off the spectrogram display.</td> </tr> <tr> <td style="border: none;">ON</td> <td style="border: none;">Turn on the spectrogram display.</td> </tr> </table>	OFF	Turn off the spectrogram display.	ON	Turn on the spectrogram display.
OFF	Turn off the spectrogram display.				
ON	Turn on the spectrogram display.				
Example	SA:SPECTRogram:STATe ON SA:SPECTRogram:STATe?				
Example	:DMM:MODE TEMPerature :DMM:TEMPerature:UNITs Celsius :DMM:TEMPerature:SIM 23.5 Sets the environment temperature to 23.5 Celsius degrees.				

USB Delay Command

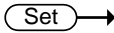
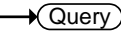
		
		
<hr/>		
:USBDelay		
<hr/>		
Description	Sets or returns the USB delay function for the PC connection which Windows 10 installed	
<hr/>		
Syntax	:USBDelay {OFF ON} :USBDelay?	
<hr/>		
Parameter/ Return parameter	<ON> <OFF>	Turns on the USB delay function Turns off the USB delay function
<hr/>		
Example	:USBDelay ON Turns on the USB delay function when the scope connected with window 10 installed PC.	
<hr/>		
Example	:REMOVEDisk:AUTOMount ON Turns the automount function on.	
<hr/>		

FRA Commands

:FRA:RUN	279
:FRA:STOP	280
:FRA:SOURce:INPut	280
:FRA:SOURce:OUTPut	280
:FRA:FREQUency:STARt.....	280
:FRA:FREQUency:STOP	281
:FRA:AWG:LOAD.....	281
:FRA:AWG:AMPlitude	282
:FRA:POINt	283
:FRA:SAVe	283
:FRA:RECALL.....	283
:FRA:DATA	283
:FRA:SAVETOCsv	284
:FRA:AWG:AMPlitude:PROFile	284
:FRA:AWG:AMPlitude:INTERPolation	284
:FRA:DATA:GMARgin	285
:FRA:DATA:GMARgin:FREQUency	285
:FRA:DATA:PMARgin.....	285
:FRA:DATA:PMARgin:FREQUency.....	286
:FRA:STATe	286

:FRA:RUN



Description	Runs the FRA function or returns the FRA state.
Syntax	:FRA:RUN :FRA:RUN?
Example	:FRA:RUN FRA starts.

Set →
 → Query

:FRA:STOP

Description	Stops the FRA function or returns the FRA state.
Syntax	:FRA:STOP :FRA:STOP?
Example	:FRA:STOP FRA stops.

Set →
 → Query

:FRA:SOURce:INPut

Description	Sets or returns the input source for FRA.
Syntax	:FRA:SOURce:INPut {CH1~CH4} :FRA:SOURce:INPut?
Parameter	CH1~CH4 Channel 1 to Channel 4
Example	:FRA:SOURce:INPut CH1 Set the input source as channel 1.

Set →
 → Query

:FRA:SOURce:OUTPut

Description	Sets or returns the output source for FRA.
Syntax	:FRA:SOURce:OUTPut {CH1~CH4} :FRA:SOURce:OUTPut?
Parameter	CH1~CH4 Channel 1 to Channel 4
Example	:FRA:SOURce:OUTPut CH2 Set the input source as channel 2.

Set →
 → Query

:FRA:FREQuency:START

Description	Sets or returns the start frequency for FRA.
-------------	--

Syntax :FRA:FREQuency:START {<NRf>}
:FRA:FREQuency:START?

Parameter <NRf> Sets the frequency to use.
(Range:20Hz~25MHz)

Example :FRA:FREQuency:START 100
Sets the start frequency as 100Hz.

Set →
→ Query

:FRA:FREQuency:STOP

Description Sets or returns the stop frequency for FRA.

Syntax :FRA:FREQuency:STOP {<NRf>}
:FRA:FREQuency:STOP?

Parameter <NRf> Sets the frequency to use.
(Range:20Hz~25MHz)

Example :FRA:FREQuency:STOP 500
Sets the start frequency as 500Hz.

Set →
→ Query

:FRA:AWG:LOAD

Description Sets or returns the impedance for load.

Syntax :FRA:AWG:LOAD {FIFty|HIGHZ}
:FRA:AWG:LOAD?

Parameter FIFty 50 ohm
HIGHZ High impedance

Example :FRA:AWG:LOAD HIGHZ
Sets the load as high impedance.

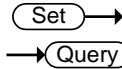

:FRA:AWG:AMplitude

Description	Sets or returns the amplitude for FRA. When amplitude profile is on, sets or returns the amplitude for the selected frequency.
Syntax	:FRA:AWG:AMplitude {<NRF>,<range>} :FRA:AWG:AMplitude? [<range>]
Parameter	<p><NRF> Sets the amplitude to user.(Load=FIFTY, Range:0.01Vpp~2.5Vpp; Load=HIGHZ, Range:0.02Vpp~5Vpp)</p> <p><range> The selected frequency. {F20hz F100hz F1Khz F10Khz F100Khz F1Mhz F10Mhz F25Mhz}</p> <p>F20hz: Frequency range >20Hz (The default <range>).</p> <p>F100hz: Frequency range >100Hz.</p> <p>F1Khz: Frequency range >1kHz.</p> <p>F10Khz: Frequency range >10kHz.</p> <p>F100Khz: Frequency range >100kHz.</p> <p>F1Mhz: Frequency range >1MHz.</p> <p>F10Mhz: Frequency range >10MHz.</p> <p>F25Mhz: Frequency range 25MHz.</p>
Example	<p>:FRA:AWG:AMplitude 0.2</p> <p>Sets the amplitude as 0.2Vpp.</p> <p>:FRA:AWG:AMplitude 0.5,F100HZ</p> <p>:FRA:AWG:AMplitude? F100HZ</p> <p>0.5</p>

		Set →
:FRA:POINt		→ Query
Description	Sets or returns the number of processing points in a decade.	
Syntax	:FRA:POINt {<NR1>} :FRA:POINt?	
Parameter	<NR1>	The number of points in a decade. (Range:10, 15, 30, 45, 90)
Example	:FRA:POINt 15 Sets the number of processing points as 15 in a decade.	
		Set →
:FRA:SAVe		
Description	Saves the FRA result.	
Syntax	:FRA:SAVe	
Example	:FRA:SAVe Saves the result to default file.	
		Set →
:FRA:RECALL		
Description	Recalls the FRA result from memory or USB.	
Syntax	:FRA:RECALL {<file path> ("Disk:/xxx.FRD", "USB:/xxx.FRD")}	
Parameter	xxx.FRD	Filename
Example	:FRA:RECALL "Disk:/FRA1.FRD" Recalls a FRA result named FRA1.FRD from root directory (Disk:/) of the scope.	
		→ Query
:FRA:DATA		

Description	Shows the detailed information of FRA settings and results.
Syntax	:FRA:DATA?
Example	:FRA:DATA? Shows the FRA result's detail.

:FRA:SAVETOCsv

Set →

Description	Saves the FRA result as a CSV file.
Syntax	:FRA:SAVETOCsv
Example	:FRA: SAVETOCsv Saves results as CSV file.

Set →

:FRA:AWG:AMPlitude:PROFile

→ Query

Description	Sets or returns the state of amplitude profile.
Syntax	:FRA:AWG:AMPlitude:PROFile {ON OFF} :FRA:AWG:AMPlitude:PROFile?
Parameter	ON Turn on the profile. OFF Turn off the profile.
Example	:FRA:AWG:AMPlitude:PROFile ON :FRA:AWG:AMPlitude:PROFile? ON

Set →

:FRA:AWG:AMPlitude:INTERPolation

→ Query

Description	Sets or returns the state of linear interpolation for the selected frequency.
Syntax	:FRA:AWG:AMPlitude:INTERPolation {ON OFF,[<range>]} :FRA:AWG:AMPlitude:INTERPolation? [<range>]

Parameter	ON	Turn off the interpolation.
	OFF	Turn off the interpolation.
	<range>	The selected frequency. {F20hz F100hz F1Khz F10Khz F100Khz F1Mhz F10Mhz F25Mhz}
		F20hz: Frequency range >20Hz(The default <range>).
		F100hz: Frequency range >100Hz.
		F1Khz: Frequency range >1kHz.
		F10Khz: Frequency range >10kHz.
		F100Khz: Frequency range >100kHz.
		F1Mhz: Frequency range >1MHz.
		F10Mhz: Frequency range >10MHz.
		F25Mhz: Frequency range 25MHz.

Example :FRA:AWG:AMplitude:INTERPolation ON,F100HZ
:FRA:AWG:AMplitude:INTERPolation? F100HZ
ON

:FRA:DATA:GMARgin → Query

Description Returns the gain margin of FRA results.

Syntax :FRA:DATA:GMARgin?

:FRA:DATA:GMARgin:FREQuency → Query

Description Returns the gain margin frequency of FRA results.

Syntax :FRA:DATA:GMARgin:FREQuency?

:FRA:DATA:PMARgin → Query

Description Returns the phase margin of FRA results.

Syntax :FRA:DATA:PMARgin?

:FRA:DATA:PMARgin:FREQuency → Query

Description	Returns the phase margin frequency of FRA results.
Syntax	:FRA:DATA:PMARgin:FREQuency?

:FRA:STATe → Query

Description	Query or turn on/off the FRA function.				
Syntax	:FRA:STATe {ON OFF} :FRA:STATe?				
Parameter	<table border="0"> <tr> <td style="padding-right: 10px;">ON</td> <td>Turn on the FRA. (No work when PWR function running)</td> </tr> <tr> <td>OFF</td> <td>Turn off the FRA.</td> </tr> </table>	ON	Turn on the FRA. (No work when PWR function running)	OFF	Turn off the FRA.
ON	Turn on the FRA. (No work when PWR function running)				
OFF	Turn off the FRA.				
Example	:FRA:STATe ON :FRA:STATe? ON				

Power Supply Commands

:POWERSupply:OUTPut<X>287
 :POWERSupply:OUTPut<X>:VOLTage287
 :POWERSupply:OUTPut<X>:RECONFigure288
 :POWERSupply:OUTPut<X>:OCP288
 :POWERSupply:OUTPut<X>:CONFigure288

:POWERSupply:OUTPut<X>

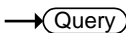

Description	Sets or returns the power supply output.	
 Note	Power supply output won't turn on when OCP occurs or power supply not yet config.	
Syntax	:POWERSupply:OUTPut<X> {ON OFF} :POWERSupply:OUTPut<X>?	
Parameter/ Return parameter	ON OFF <X>	Turns on the power supply output. Turns off the power supply output. range: 1~2
Example	:POWERSupply:OUTPut1 ON	

:POWERSupply:OUTPut<X>:VOLTage



Description	Sets or returns the power supply voltage.	
Syntax	:POWERSupply:OUTPut<X>:VOLTage <NR3> :POWERSupply:OUTPut<X>:VOLTage?	
Parameter/ Return parameter	<NR3> <X>	Sets the voltage.(range:1~5) Range:1~2
Example	POWERSupply:OUTPut1:VOLTage 3.3	

:POWERSupply:OUTPut<X>:RECONFigure (Set) →
→ (Query)

Description	Reconfigure the power supply.	
 Note	Clear OCP flag.	
Syntax	:POWERSupply:OUTPut<X>:RECONFigure {ON}	
Parameter	ON	Reconfigure the power supply.
	<X>	range:1~2
Example	:POWERSupply:OUTPut1:RECONFigure ON	

:POWERSupply:OUTPut<X>:OCP (Set) →
→ (Query)

Description	Returns the power supply OCP.	
Syntax	:POWERSupply:OUTPut<X>:OCP?	
Return parameter	<X>	Range:1~2
Example	:POWERSupply:OUTPut1:OCP?	
	Return ON ->Output1 OCP occurs.	
	Return OFF ->Output1 OCP did not occur.	

:POWERSupply:OUTPut<X>:CONFigure (Set) →
→ (Query)

Description	Configure the power supply.	
 Note	It is must delay about 6 sec after power supply config.	
Syntax	:POWERSupply:CONFigure {ON ?}	
Parameter	ON	Range:1~2
Example	:POWERSupply:CONFigure ON	

Python Commands

:PYDEcode:TYPE	289
:PYDEcode:CANFD:SOURce	290
:PYDEcode:CANFD:PROBe	290
:PYDEcode:CANFD:SAMPLEpoint	290
:PYDEcode:CANFD:BITRate	291
:PYDEcode:CANFD:FASTBITRate	291
:PYDEcode:FLEXRay:SOURce	291
:PYDEcode:FLEXRay:BDIFF	292
:PYDEcode:FLEXRay:CHTYPe	292
:PYDEcode:FLEXRay:BITRate	292
:PYDEcode:USBPD:SOURce	293
:PYDEcode:USBPACKET:SIGnal	293
:PYDEcode:USBPACKET:DPlus	293
:PYDEcode:USBPACKET:DMinus	294
:PYDEcode:I2S:SCK	294
:PYDEcode:I2S:WS	294
:PYDEcode:I2S:SD	295

:PYDEcode:TYPE



Description	Set or return the state and decode type of python bus decode application.	
Syntax	:PYDEcode:TYPE {CANFD FLEXRay USBPD USBPACKET I2S OFF} :PYDEcode:TYPE?	
Parameter/ Return parameter	CANFD	Turn on the bus decode operation and set the decode type as CANFD.
	FLEXRay	Turn on the bus decode operation and set the decode type as flexray.
	USBPD	Turn on the bus decode operation and set the decode type as USBPD.

	USBPACKET	Turn on the bus decode operation and set the decode type as USB packet.
	I2S	Turn on the bus decode operation and set the decode type as I2S.
	OFF	Turn off the bus decode operation.

Example :PYDEcode:TYPE CANFD
:PYDEcode:TYPE? CANFD

(Set) →

:PYDEcode:CANFD:SOURce → (Query)

Description Set or return the input source of the CANFD bus.

Syntax :PYDEcode:CANFD:SOURce {CH1|CH2|CH3|CH4}
:PYDEcode:CANFD:SOURce?

Parameter/ Return parameter	CH1 ~ CH4	Set the analog channel to use as the CANFD input.
--------------------------------	-----------	---

Example :PYDEcode:CANFD:SOURce CH2
:PYDEcode:CANFD:SOURce? CH2

(Set) →

:PYDEcode:CANFD:PROBe → (Query)

Description Set or return the signal type of the CANFD.

Syntax :PYDEcode:CANFD:PROBe {CANH|CANL}
:PYDEcode:CANFD:PROBe?

Parameter/ Return parameter	CANH	Specifies the CANH signal.
	CANL	Specifies the CANL signal.

Example :PYDEcode:CANFD:PROBe CANH
:PYDEcode:CANFD:PROBe? CANH

:PYDEcode:CANFD:SAMPLEpoint → (Query)

Description Returns the sample point of the CANFD.

Syntax :PYDEcode:CANFD:SAMPLEpoint?

Example :PYDEcode:CANFD:SAMPLEpoint? 50

:PYDEcode:CANFD:BITRate (Set) →
→ (Query)

Description Set or return the bit rate for CANFD.

Syntax :PYDEcode:CANFD:BITRate {<NR1>}
:PYDEcode:CANFD:BITRate?

Parameter/ Return parameter <NR1> The bit rate.

Example :PYDEcode:CANFD:BITRate 125000
:PYDEcode:CANFD:BITRate? 125000

:PYDEcode:CANFD:FASTBITRate (Set) →
→ (Query)

Description Set or return the fast bit rate for CANFD.

Syntax :PYDEcode:CANFD:FASTBITRate {<NR1>}
:PYDEcode:CANFD:FASTBITRate?

Parameter/ Return parameter <NR1> The fast bit rate.

Example :PYDEcode:CANFD: FASTBITRate 5000000
:PYDEcode:CANFD: FASTBITRate? 5000000

:PYDEcode:FLEXRay:SOURce (Set) →
→ (Query)

Description Set or return the input source of the flexray bus.

Syntax :PYDEcode:FLEXRay:SOURce {CH1|CH2|CH3|CH4}
:PYDEcode:FLEXRay:SOURce?

Parameter/ Return parameter CH1 ~ CH4 Set the analog channel to use as the flexray input.

Example :PYDEcode:FLEXRay:SOURce CH2
:PYDEcode:FLEXRay:SOURce? CH2

Set →
 → Query

:PYDEcode:FLEXRay:BDIFF

Description	Set or return the signal type of the flexray.	
Syntax	:PYDEcode:FLEXRay:BDIFF {NORMAL INVERTed} :PYDEcode:FLEXRay:BDIFF?	
Parameter/ Return parameter	NORMAL	Specifies the normal signal.
	INVERTed	Specifies the inverted signal.
Example	:PYDEcode:FLEXRay:BDIFF INVERTed :PYDEcode:FLEXRay:BDIFF? INVERTed	

Set →
 → Query

:PYDEcode:FLEXRay:CHTYPe

Description	Set or return the channel type of the flexray.	
Syntax	:PYDEcode:FLEXRay:CHTYPe {A B} :PYDEcode:FLEXRay:CHTYPe?	
Parameter/ Return parameter	A	Set the channel type as A.
	B	Set the channel type as B.
Example	:PYDEcode:FLEXRay:CHTYPe A :PYDEcode:FLEXRay:CHTYPe? A	

Set →
 → Query

:PYDEcode:FLEXRay:BITRate

Description	Set or return the bit rate for flexray..	
Syntax	:PYDEcode:FLEXRay:BITRate {<NR1>} :PYDEcode:FLEXRay:BITRate?	
Parameter/ Return parameter	<NR1>	The bit rate.
Example	:PYDEcode:FLEXRay:BITRate 5000000 :PYDEcode:FLEXRay:BITRate? 5000000	

Set →
 → Query

:PYDEcode:USBPD:SOURce

Description	Set or return the input source of the USBPD bus.
Syntax	:PYDEcode:USBPD:SOURce {CH1 CH2 CH3 CH4} :PYDEcode:USBPD:SOURce?
Parameter/ Return parameter	CH1 ~ CH4 Set the analog channel to use as the USBPD input.
Example	:PYDEcode:USBPD:SOURce CH1 :PYDEcode:USBPD:SOURce? CH1

Set →
 → Query

:PYDEcode:USBPACKET:SIGnal

Description	Set or return the signal type of the USB packet.
Syntax	:PYDEcode:USBPACKET:SIGnal {AUTOMatic LOWSpeed FULLSpeed} :PYDEcode:USBPACKET:SIGnal?
Parameter/ Return parameter	AUTOMatic Set the signal type as automatic. LOWSpeed Set the signal type as low speed. FULLSpeed Set the signal type as full speed.
Example	:PYDEcode:USBPACKET:SIGnal FULLSpeed :PYDEcode:USBPACKET:SIGnal? FULLSpeed

Set →
 → Query

:PYDEcode:USBPACKET:DPlus

Description	Set or return the D+ input source of the USB packet bus.
Syntax	:PYDEcode:USBPACKET:DPlus {CH1 CH2 CH3 CH4} :PYDEcode:USBPACKET:DPlus?
Parameter/ Return parameter	CH1 ~ CH4 Set the analog channel to use as the USB packet D+ input.

Example :PYDEcode:USBPACKET:DPlus CH1
 :PYDEcode:USBPACKET:DPlus? CH1

:PYDEcode:USBPACKET:DMinus (Set) →
 → (Query)

Description Set or return the D- input source of the USB packet bus.

Syntax :PYDEcode:USBPACKET:DMinus {CH1|CH2|CH3|CH4}
 :PYDEcode:USBPACKET:DMinus?

Parameter/ Return parameter CH1 ~ CH4 Set the analog channel to use as the USB packet D- input.

Example :PYDEcode:USBPACKET:DMinus CH1
 :PYDEcode:USBPACKET:DMinus? CH1

:PYDEcode:I2S:SCK (Set) →
 → (Query)

Description Set or return the SCK input source of the I2S bus.

Syntax :PYDEcode:I2S:SCK {CH1|CH2|CH3|CH4}
 :PYDEcode:I2S:SCK?

Parameter/ Return parameter CH1 ~ CH4 Set the analog channel to use as the I2S SCK input.

Example :PYDEcode:I2S:SCK CH3
 :PYDEcode:I2S:SCK? CH3

:PYDEcode:I2S:WS (Set) →
 → (Query)

Description Set or return the WS input source of the I2S bus.

Syntax :PYDEcode:I2S:WS {CH1|CH2|CH3|CH4}
 :PYDEcode:I2S:WS?

Parameter/ Return parameter CH1 ~ CH4 Set the analog channel to use as the I2S WS input.

Example :PYDEcode:I2S:WS CH1
 :PYDEcode:I2S:WS? CH1

:PYDEcode:I2S:SD

Set →

→ Query

Description Set or return the SD input source of the I2S bus.

Syntax :PYDEcode:I2S:SD {CH1|CH2|CH3|CH4}
 :PYDEcode:I2S:SD?

Parameter/ Return parameter CH1 ~ CH4 Set the analog channel to use as the I2S SD input.

Example :PYDEcode:I2S:SD CH1
 :PYDEcode:I2S:SD? CH1

APPENDIX

Error messages

Description The following error messages may be returned from the :SYSTem:ERRor? query. For details see page 160.

List of error messages	Error number, "Error Description"
	+0, "No error."
	-100, "Command error"
	-101, "Invalid character"
	-102, "Syntax error"
	-103, "Invalid separator"
	-104, "Data type error"
	-105, "GET not allowed"
	-108, "Parameter not allowed"
	-109, "Missing parameter"
	-110, "Command header error"
	-111, "Header separator error"
	-112, "Program mnemonic too long"
	-113, "Undefined header"
	-114, "Header suffix out of range"
	-115, "Unexpected number of parameters"
	-120, "Numeric data error"
	-121, "Invalid character in number"
	-123, "Exponent too large"
	-124, "Too many digits"
	-128, "Numeric data not allowed"
	-130, "Suffix error"
	-131, "Invalid suffix"
	-134, "Suffix too long"
	-138, "Suffix not allowed"

- 140, "Character data error"
- 141, "Invalid character data"
- 144, "Character data too long"
- 148, "Character data not allowed"
- 150, "String data error"
- 151, "Invalid string data"
- 158, "String data not allowed"
- 160, "Block data error"
- 161, "Invalid block data"
- 168, "Block data not allowed"
- 170, "Expression error"
- 171, "Invalid expression"
- 178, "Expression data not allowed"
- 180, "Macro error"
- 181, "Invalid outside macro definition"
- 183, "Invalid inside macro definition"
- 184, "Macro parameter error"

- 200, "Execution error"
- 201, "Invalid while in local"
- 202, "Settings lost due to rtl"
- 203, "Command protected"
- 210, "Trigger error"
- 211, "Trigger ignored"
- 212, "Arm ignored"
- 213, "Init ignored"
- 214, "Trigger deadlock"
- 215, "Arm deadlock"
- 220, "Parameter error"
- 221, "Settings conflict"
- 222, "Data out of range"
- 223, "Too much data"
- 224, "Illegal parameter value"
- 225, "Out of memory"
- 226, "Lists not same length"
- 230, "Data corrupt or stale"
- 231, "Data questionable"
- 232, "Invalid format"
- 233, "Invalid version"
- 240, "Hardware error"

- 241, "Hardware missing"
- 250, "Mass storage error"
- 251, "Missing mass storage"
- 252, "Missing media"
- 253, "Corrupt media"
- 254, "Media full"
- 255, "Directory full"
- 256, "File name not found"
- 257, "File name error"
- 258, "Media protected"
- 260, "Expression error"
- 261, "Math error in expression"
- 270, "Macro error"
- 271, "Macro syntax error"
- 272, "Macro execution error"
- 273, "Illegal macro label"
- 274, "Macro parameter error"
- 275, "Macro definition too long"
- 276, "Macro recursion error"
- 277, "Macro redefinition not allowed"
- 278, "Macro header not found"
- 280, "Program error"
- 281, "Cannot create program"
- 282, "Illegal program name"
- 283, "Illegal variable name"
- 284, "Program currently running"
- 285, "Program syntax error"
- 286, "Program runtime error"
- 290, "Memory use error"
- 291, "Out of memory"
- 292, "Referenced name does not exist"
- 293, "Referenced name already exists"
- 294, "Incompatible type"

- 300, "Device-specific error"
- 310, "System error"
- 311, "Memory error"
- 312, "PUD memory lost"
- 313, "Calibration memory lost"
- 314, "Save/recall memory lost"

- 315, "Configuration memory lost"
- 320, "Storage fault"
- 321, "Out of memory"
- 330, "Self-test failed"
- 340, "Calibration failed"
- 350, "Queue overflow"
- 360, "Communication error"
- 361, "Parity error in program message"
- 362, "Framing error in program message"
- 363, "Input buffer overrun"
- 365, "Time out error"

- 400, "Query error"
- 410, "Query INTERRUPTED"
- 420, "Query UNTERMINATED"
- 430, "Query DEADLOCKED"
- 440, "Query UNTERMINATED after indefinite response"

I NDEX

ACQuire	
FILTer	
TRACking 46, 287, 288, 289, 290, 291, 292, 293, 294, 295	
ACQuire	
AVERAge.....40	
FILTer	
FREQuency.....44	
FILTer.....44	
SOURce.....43	
MEMory.....41	
MODE.....41	
ACQuire	
STATe.....46	
ACQuire	
INTERpolation.....46	
ACQuire	
RECOrdlength.....47	
ACQuire	
HEADer.....47	
AUTORSET	
MODE.....48	
AUTOSet.....48	
BUS1.....168	
CAN	
BITRate.....176	
PROBe.....175	
SAMPLepoint.....175	
SOURce.....174	
DISPlay	
FORMAt.....174	
I2C	
ADDReSS	
RWINClude.....170	
SCLK	
SOURce.....170	
SDA	
SOURce.....171	
INPut.....170	
LABel.....214	
DISPlay.....214	
LIN	
BITRate.....176	
IDFORmat.....177	
POLARity.....177	
SAMPLepoint.....177	
SOURce.....178	
STANDArD.....178	
STATE.....169	
TYPe.....169	
UART	
BITRate.....171	
DATABits.....171	
EOFPacket.....172, 173	
PACKEt.....172	
PARity.....172	
RX	
SOURce.....173	
TX	
SOURce.....173	
CHANnel	
BWLimit.....49	
COUPLing.....50	
DESKew.....50	
DISPlay.....50	
EXPand.....51	
IMPedance.....51	
INVert.....52	
LABel.....211	
DISPlay.....212	
POSITion.....52	
PROBe	
TYPe.....53	
PROBe	
RATio.....53	
SCALE.....54	
CLS.....36	
CURSor	

DDT.....	67	BACKLight.....	76
H1Position.....	68	BACKLight	
H2Position.....	68	AUTODim	
HDELta.....	68	ENable.....	76
HUNI.....	65	GRATicule.....	75
HUSE.....	66	WAVEform.....	75
MODE.....	64	OUTPut.....	78
SOURce.....	65	PERSistence.....	77
V1Position.....	69	WAVEform.....	78
VDELta.....	69		
VUNI.....	66	DMM	
VUSE.....	67	TEMPerature	
XY		TYPe.....	264, 265, 266, 267
POLar		DVM	
RADIUS		MODE.....	227
DELta.....	72	SOURce.....	226
POSition.....	71	STATE.....	226
THETA		VALue.....	227
DELta.....	72	Error list.....	296
POSition.....	72	Ethernet	
PRODUct		interface.....	7
DELta.....	73	ETHERnet	
POSition.....	73	DHCP.....	166
RATio		FORCe.....	122
DELta.....	74	GONogo	
RATio		CLEar.....	228
POSition.....	73	EXECute228, 235, 236, 237, 279, 280,	
RECTangular		281	
X		FUNctioN.....	229, 238
DELta.....	70	NGCount.....	229, 238, 239, 240, 241,
POSition.....	70	242, 243, 244, 245, 246, 247, 248,	
Y		249, 250, 251, 252, 253, 273, 274,	
DELta.....	71	275, 276, 277, 278	
POSition.....	70	NGDefine.....	229
DATALOG		SCRipt.....	230
DURation....	257, 267, 268, 269, 270,	SOURce.....	230
271, 272		VIOLation.....	230
INTerval.....	256	HARDcopy	
SAVE.....	256	ASSIGN.....	81
SOURce.....	255	MODE.....	79
STATE.....	255	PRINTINKSaver.....	80
DATE.....	167	SAVEFORMat.....	80
DISPlay		SAVEINKSaver.....	80
INTENSITy		START.....	79
BACKLight		HEADER.....	47
AUTODim			
TIME.....	76		
DISPlay			
GRATicule.....	77		
INTensity			

IDN?	34	LFFDelay.....	105
Interface	5	LFRDelay.....	104
LISTer		LOW	96
DATA	174	LRFDelay.....	104
LRN?	34	LRRDelay.....	103
MARK.....	179	MAX	97
CREATE	179	MEAN	94
DELEte.....	180	METHod	84
MATH		MIN	97
ADVanced		NEDGE	93
OPERator	60	NPULSE.....	92
POSition	62	NWIDth	88
SCALe.....	63	PDUTy	88
DISP	55	PEDGE	93
DUAL		PERiod	89
OPERator	57	PHAsE	106
POSition	57	PK2PK	98
SCALe.....	57	PPULSE.....	92
SOURce	56	PWIDth	89
FFT		RISe.....	90
HORizontal		RMS	98
POSition.....	60	ROVShoot.....	91
SCALe.....	60	RPReshoot.....	91
MAG	58	SOURce	83
POSition	59		
SCALe.....	59	MEASUREMENT	
SOURce	58	MEAS	
WINDow.....	58	MAXimum	111
TYPE	56	MEAN.....	112
MATHVAR	61	MINimum	112
MEASure		SOURCE	108
AMPlitude.....	94	STATE.....	109
AREa	100	STDdev	113
CAREa.....	100	TYPe.....	109
CMean.....	95	VALue.....	110
CRMS.....	99	REFLevel	
FALL.....	86	PERCent	
FFFDelay	103	HIGH.....	84
FFRDelay.....	102	LOW	85
FOVShoot.....	86	MID	85
FPReshoot	87	MID2.....	85
FREQuency	87	STATIstics.....	115
FRFDelay.....	101	MODE	114
FRRDelay	101	WEIghting	114
GATing.....	83	RCL.....	35, 283, 284, 285, 286
HIGH	96	RECALL	
		SETUp	161
		WAVEform.....	161
		REF	
		DISPlay	116

LAbel	212	VALue	201
DISPlay	213	I2C	
OFFSet	117	ADDRESS	
SCALe	118	DIRectioN	193
TIMebase		MODE	191
POSitiON	116	TYPe	192
SCALe	117	VALue	193
Remote control		CONDitiON	191
interface configuration	5	DATA	
webserver	10	SiZe	194
REMOTEDisk		VALue	194
AUTOMount	260	LIN	
IPADDRESS	258	CONDitiON	204
MOUNT	259	DATA	
PASSWord	259	QUALifier	205
PATHName	258	SiZe	206
USERName	259	VALue	206
RST	35	ERRTYPe	207
RUN	119	IDentifier	
SAV	35	VALue	208
SAVE		UART	
IMAGe	162	CONDitiON	195
FILEFormat	162	RX	
INKSaver	163	DATA	196, 197
SETUp	163	TX	
WAVEform	164	DATA	197, 198
FILEFormat	165	TYPe	190
SEARCH		EDGE	
COPY	182	SLOP	184
FFTPeak		HLEVel	185
METHod	208	LEVel	184
MPEak	209	LLEVel	185
SINFo	210	PULSe	
STATE	183	TiMe	188
TOTAL	183	WHEN	187
TRIGger		PULSEWidth	
BUS		POLarity	186
B1		RISEFall	
CAN		SLOP	187
CONDitiON	199	TiMe	190
DATA		WHEN	189
QUALifier	202	RUNT	
SiZe	203	POLarity	186
VALue	203	TiMe	189
FRAMEType	200	WHEN	188
IDentifier		SOURCE	184
DIRectioN	201	TYPe	183
MODE	200	SEGMENTS	
		CURRent	218
		DISPALL	219
		MEASURE	
		MODE	219
		PLOT	
		DIVide	220
		RESults	221
		SELect	221

SOURce	220	CONDition	150
TABLE		DATA	
LIST	223	QUALifier	153
SAVe	223	SIze	154
SElect	222	VALue	154
SOURce	222	FRAMeType	151
SAVE	224	IDentifier	
SElect		DIRection	153
END	225	MODE	151
START	224	VALue	152
SOURce	224	I2C	
STATE	217	ADDRess	
TIME	219	DIRection	146
TOTALnum	218	MODE	144
SET		TYPE	144
LABel	215	VALue	145
SINGLE	121	CONDition	143
Socket server		DATA	
interface	9	SIze	146
STOP	120	VALue	147
SYSTEM		LIN	
ERRor	160	CONDition	155
LOCK	160	DATA	
TEMPLATE		QUALifier	156
MAXimum	231	SIze	157
MINimum	231	VALue	157
MODE	231	ERRTYPE	158
POSITION		IDentifier	
MAXimum	232	VALue	158
MINimum	232	UART	
SAVE		CONDition	147
AUTO	233	RX	
MAXimum	232	DATA	
MINimum	233	SIze	148
TOLERance	233	VALue	148
TIMEbase		TX	
EXPand	123	DATA	
MODE	124	SIze	149
POSITION	123	VALue	150
SCALE	124	THReshold	
WINDOW		CH	143
POSITION	124	TYPE	142
SCALE	125	COUPLE	129
TRIGGER		DELay	
BUS		EVENT	133
B1		LEVel	134
CAN		SLOP	132
		TIME	133
		TYPE	133
		EDGE	
		SLOP	132
		EXTERNAL	
		PRObe	
		RATio	142
		TYPE	141
		FREQuency	127

HLeVel	131	Time.....	135
HOLDOff.....	130	WHEn	135
LeVel.....	130	SOURce	128
LLeVel	131	STATe.....	141
MODe.....	130	TIMEOut	
NREJ.....	129	TIMER.....	140
PULSe		WHEn	140
TIME.....	140	TYPE	128
WHEn	139	VIDeo	
PULSEWidth		FIELD	138
POLarity	134	LINE	138
RISEFall		POLarity	139
SLOP.....	136	TYPe.....	137
TIME	137	USB	
WHEn.....	136	function check	6
RUNT		remote control interface	5
POLarity	134		