

# RF & Communication Trainer

GRF-1300A  
STUDENT BOOK

---

**USER MANUAL and TEXT BOOK**

GW INSTEK PART NO. 82RF-1300AM01



ISO-9001 CERTIFIED MANUFACTURER

**GW INSTEK**

This manual contains proprietary information, which is protected by copyright. All rights are reserved. No part of this manual may be photocopied, reproduced or translated to another language without prior written consent of Good Will Corporation.

The information in this manual was correct at the time of printing. However, Good Will continues to improve its products and therefore reserves the right to change the specifications, equipment, and maintenance procedures at any time without notice.

# Table of Contents

<b>SAFETY INSTRUCTIONS</b> .....	<b>2</b>
<b>ABOUT THIS BOOK</b> .....	<b>5</b>
<b>INTRODUCTION to the GRF-1300A</b> .....	<b>6</b>
Package Contents .....	8
Product Specifications and Function .....	8
Usage Instructions .....	9
<b>OVERVIEW of the TIME and FREQUENCY DOMAIN</b> .....	<b>16</b>
Observation from a different perspective .....	16
<b>AN INTRODUCTION to SPECTRUM ANALYZERS</b> .....	<b>24</b>
Broadband Receiver .....	24
Attenuator .....	25
Resolution Bandwidth Filter .....	25
Detector .....	27
Video Bandwidth Filter .....	27
<b>RF COMMUNICATION and SIGNALS EXPERIMENTS</b> .....	<b>31</b>
Experiment 1: Basic Operation of a Spectrum Analyzer .....	32
Experiment 2: Measuring a Baseband Waveform .....	36
Experiment 3: Different Baseband Waveforms and their Harmonic Measurement ...	40
Experiment 4: Measurement of the RF Carrier .....	47
Experiment 5: AM Signal Measurement .....	60
Experiment 6: FM signal measurement .....	70
Experiment 7: Using a Spectrum Analyzer in Communication Systems .....	81
Experiment 8: Measurement of communication products .....	88
Experiment 9: Production Line Applications .....	91
Experiment 10: Mixer .....	96
<b>TEST for LEARNING OUTCOMES</b> .....	<b>108</b>
<b>APPENDIX</b> .....	<b>117</b>
dBm Conversion Table .....	117
The relationship between dB and dBc .....	118
Resistor Values in $\pi$ -type Resistance Attenuators .....	119
Resistor Values in T-type Resistance Attenuators .....	120
Modulation Index and Sideband Amplitude Comparison Table .....	121
Declaration of Conformity .....	122







# S SAFETY INSTRUCTIONS

This chapter contains important safety instructions that should be followed when operating and storing the GRF-1300A. Read the following before any operation to ensure your safety and to keep the GRF-1300A in the best condition.

## Safety Symbols

These safety symbols may appear in this manual or on the instrument.

---

	<b>WARNING</b>	Warning: Identifies conditions or practices that could result in injury or loss of life.
	<b>CAUTION</b>	Caution: Identifies conditions or practices that could result in damage to the GRF-1300A or to other objects or property.
		<b>DANGER High Voltage</b>
		Attention: Refer to the Manual
		Protective Conductor Terminal
		Earth (Ground) Terminal
		Do not dispose electronic equipment as unsorted municipal waste. Please use a separate collection facility or contact the supplier from which this instrument was purchased.

## Safety Guidelines

---

General Guideline	<ul style="list-style-type: none"> <li>• Do not place heavy objects on the device.</li> <li>• Do not place flammable objects on the device.</li> </ul>
 <b>CAUTION</b>	<ul style="list-style-type: none"> <li>• Avoid severe impact or rough handling that may damage the device.</li> <li>• Avoid discharges of static electricity on or near the device.</li> <li>• Use only mating connectors, not bare wires, for the terminals.</li> <li>• The device should only be disassembled by a qualified technician.</li> </ul>

(Measurement categories) EN 61010-1:2010 specifies the measurement categories and their requirements as follows. The device falls under category I.

- Measurement category IV is for measurement performed at the source of a low-voltage installation.
- Measurement category III is for measurement performed in a building installation.
- Measurement category II is for measurement performed on circuits directly connected to a low voltage installation.
- Measurement category I is for measurements performed on circuits not directly connected to Mains.

Power Supply



- AC Input voltage: 100 ~ 240V AC, 50 ~ 60Hz.
- Connect the protective grounding conductor of the AC power cord to an earth ground to prevent electric shock.

Fuse



- Fuse type: 1A/250V.
- Only qualified technicians should replace the fuse.
- To ensure fire protection, replace the fuse only with the specified type and rating.
- Disconnect the power cord and all test leads before replacing the fuse.
- Make sure the cause of the fuse blowout is fixed before replacing the fuse.

Cleaning the GRF-1300A

- Disconnect the power cord before cleaning the device.
- Use a soft cloth dampened in a solution of mild detergent and water. Do not spray any liquid into the device.
- Do not use chemicals containing harsh products such as benzene, toluene, xylene, and acetone.

Operation environment

- Location: Indoor, no direct sunlight, dust free, almost non-conductive pollution (Note below) and avoid strong magnetic fields.
- Relative Humidity: < 80%
- Altitude: < 2000m
- Temperature: 0°C to 40°C

(Pollution Degree) EN 61010-1:2010 specifies pollution degrees and their requirements as follows. The device falls under degree 2.

Pollution refers to “addition of foreign matter, solid, liquid, or gaseous (ionized gases), that may produce a reduction of dielectric strength or surface resistivity”.

- Pollution degree 1: No pollution or only dry, non-conductive pollution occurs. The pollution has no influence.
- Pollution degree 2: Normally only non-conductive pollution occurs. Occasionally, however, a temporary conductivity caused by condensation must be expected.
- Pollution degree 3: Conductive pollution occurs, or dry, non-conductive pollution occurs which becomes conductive due to condensation which is expected. In such conditions, equipment is normally protected against exposure to direct sunlight, precipitation, and full wind pressure, but neither temperature nor humidity is controlled.

Storage environment

- Location: Indoor
- Relative Humidity: < 70%
- Temperature: -10°C to 70°C

**Disposal**

Do not dispose this device as unsorted municipal waste. Please use a separate collection facility or contact the supplier from which this instrument was purchased. Please make sure discarded electrical waste is properly recycled to reduce environmental impact.

## Power cord for the United Kingdom

When using the device in the United Kingdom, make sure the power cord meets the following safety instructions.

---

NOTE: This lead/appliance must only be wired by competent persons



**WARNING: THIS APPLIANCE MUST BE EARTHED**

IMPORTANT: The wires in this lead are coloured in accordance with the following code:

Green/ Yellow: Earth

Blue: Neutral

Brown: Live (Phase)



As the colours of the wires in main leads may not correspond with the coloured marking identified in your plug/appliance, proceed as follows:

The wire which is coloured Green & Yellow must be connected to the Earth terminal marked with either the letter E, the earth symbol  $\oplus$  or coloured Green/Green & Yellow.

The wire which is coloured Blue must be connected to the terminal which is marked with the letter N or coloured Blue or Black.

The wire which is coloured Brown must be connected to the terminal marked with the letter L or P or coloured Brown or Red.

If in doubt, consult the instructions provided with the equipment or contact the supplier.

This cable/appliance should be protected by a suitably rated and approved HBC mains fuse: refer to the rating information on the equipment and/or user instructions for details. As a guide, a cable of 0.75mm<sup>2</sup> should be protected by a 3A or 5A fuse. Larger conductors would normally require 13A types, depending on the connection method used.

Any exposed wiring from a cable, plug or connection that is engaged in a live socket is extremely hazardous. If a cable or plug is deemed hazardous, turn off the mains power and remove the cable, any fuses and fuse assemblies. All hazardous wiring must be immediately destroyed and replaced in accordance to the above standard.

# A ABOUT THIS BOOK

This textbook was developed in conjunction with the GRF-1300A RF & Communication Trainer and the GSP-730 3GHz spectrum analyzer as an RF communications education system. It not only offers detailed examples, but also the practical knowledge necessary for RF measurements, such as spectrum analyzer principals, as well as AM and FM communication systems.

For you to easily understand the contents of this textbook, we have included as many pictures and diagrams as possible to strengthen your comprehension.

This book is divided into a teacher version and two student versions. All experiment results are included in the teacher edition. In addition, chapters with an asterisk (\*) indicate additional text for advanced reading not present in the student edition. Students will not be affected by the omission of the additional text. To further help students, the student edition will contain a "Notes" section in these missing areas.

## INTRODUCTION to the GRF-1300A

The GRF-1300A is a well designed training kit capable of producing a 3MHz baseband signal and a carrier signal up to 900MHz. The GRF-1300A is also able to perform AM and FM RF circuit experiments as well. The practical exercises in the training kit meet the needs of most general RF courses. The GRF-1300A consists of three modules, namely: a baseband module, an RF Synthesizer/FM module and an AM module. The baseband module can simulate a baseband signal and includes sine, square or triangle waveforms. Its output frequency and amplitude are adjustable. During experiments the three kinds of waveforms can be arbitrarily switched back and forth to meet the signaling requirements of each of the different experiments.

The RF Synthesizer/FM module is used to generate an adjustable carrier frequency as well as perform frequency modulation. This module covers some of the focus points in the RF circuit theory. This will be highlighted in practical experiments in later chapters. FM waveforms can also be produced by using this module together with the baseband module. The GSP-730 spectrum analyzer can be used to observe the various characteristics of an FM waveform.

The AM module and baseband module can be used together to perform amplitude modulation experiments. The GSP-730 Spectrum Analyzer can be used to observe the various characteristics of an AM waveform.

The mixer can convert the RF signal into an intermediate frequency signal or it can do the opposite and convert the intermediate frequency signal into an RF frequency signal in order to transmit or process the carried message, respectively.

This experiment system can be connected to a computer via the USB interface. The interface can be used to turn individual circuits on or off so that students can perform diagnostic experiments.

Students can learn the fundamental aspects of RF theory through a variety of experiments. Understanding RF theory has been made easier by breaking the RF circuits into fundamental



functions. This allows students to see in detail how the theory relates to the practical aspects of the RF circuitry.

This system is a collection of different functions: signal generation, frequency modulation, amplitude modulation, communication and other functions. Connecting different modules together can create a number of different RF circuit experiments. Specific experiments will be highlighted in later chapters. The GRF-1300A RF & Communication Trainer is designed to modulate an audio signal with a carrier waveform. The system takes into account the difficulties arising from RF circuit theory and knowledge. It focuses on these theories and sets up experiments to understand the theoretical aspects of RF circuitry – This also has the added benefit of increasing a student’s interest to learn RF circuits.

Figure A-1.  
The GRF-1300A control panel





Figure A-2.  
Reference platform: GSP-730 Spectrum Analyzer



## Package Contents

This package contains the GRF-1300A unit, RF cable – 3 \* 10cm, 1\*20cm, RF cable 2\* 80cm, a user manual CD, a student book, an antenna, a power cord and so on.

Title	Photo	No	Note
GRF-1300A		1	
RF wire		3	100mm
RF wire		1	200mm
RF wire		2	800mm
Antenna		2	800-1000MHz
AC power cord		1	100-240V~50-60Hz
CD		1	User manual and software
Adapter		1	N-SMA Adapter
Student Textbook		1	RF & Communication Trainer

## Product Specifications and Function

Function	Item	Spec.
Base Band	Waveforms	Sine, Square, Triangle
	Frequency Range	0.1~3MHz (Triangle-0.1~1MHz) Step: 10kHz
	Amplitude	≥1.5Vpp ≥0.75Vpp into 50Ω
	Harmonics Distortion	≤-30dBc
RF/FM Analysis	Frequency Accuracy	±0.15MHz
	Adjustable Range	≥45MHz (870M~920M) Step: 1MHz
	Power Range	≥-15dBm
FM	Max Frequency Deviation	>3MHz
AM	Peak Difference	≥-18dBm
Mixer	LO+IF	≥-35dBm

	LO-IF	$\geq -35\text{dBm}$
Mixer+modulation		$\geq -60\text{dBm}$
Bandpass Filter	Frequency Centre: 2.4GHz	Bandwidth: $\pm 20\text{MHz}$
Communication	Turn circuits on or off by remote command for the diagnostic experiments.	

## Usage Instructions

- Procedure
1. For safety purposes, please connect the unit to the correct AC power source: 100V~240V, 50-60Hz.

Make sure the ground terminal is properly earthed to prevent electric shock.

2. The power socket and USB port are on the rear panel. The power switch is on the upper left-hand side of the device.

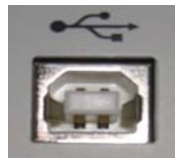

USB port



AC socket



Power switch

3. When using several modules together at the same time, connect each module with the appropriate RF cable.

Figure A-3.  
Connection diagram between different modules



4. The UP and DOWN buttons on the Baseband module can be

used to adjust the frequency of the baseband signal. The baseband module is adjustable in 10kHz steps.

- *WAVE Select* is used to select three different baseband waveforms. When the waveform is selected, the corresponding LED light will be lit up.
- The *Reset* button is used to reset the GRF-1300A. When reset, the GRF-1300A will output a 0.10MHz sine wave baseband signal and a carrier signal with a frequency 880MHz.
- The *output* port is used to output the set baseband signal.
- The four-digit display is used to display the frequency of the output baseband signal.
- TP4 (test point 4) is used to used to monitor the output signal from the output port.
- The potentiometer knob is used to adjust the voltage of the output baseband signal. Turn clockwise to increase the amplitude and turn anticlockwise to decrease its amplitude.

Figure A-4.  
Baseband module



5. The UP and DOWN buttons on the RF Synthesizer / FM module can be used to adjust the frequency of the carrier. The carrier can be adjusted in 1MHz steps.

- The Four-digit display is used to display the frequency of the carrier signal.
- *FM in* port and RF / FM Output port are used to receive the FM signal and output the carrier signal respectively.
- TP2, TP3 and TP1 are used to monitor for breaks in the circuit. For the position of each test point, please see Figure A-7.

Figure A-5. RF Synthesizer/FM module



6. The AM module is used for amplitude modulation. The AM in port and RF in port are used to input the modulating signal and the carrier signal respectively. The AM output port outputs the amplitude modulated waveform.

Figure A-6. AM module



The mixer can convert the RF signal into an intermediate frequency signal or it can do the opposite and convert the intermediate frequency signal into an RF frequency signal in order to transmit or process the carried message, respectively.



7. There are five test points (Tp1, Tp2, Tp3, Tp4, Tp5) on the panel. These five test points are set at different points in the circuit path of the connected modules. Their specific locations are as shown in the Figure below. They are turned on or off by their corresponding relays (B1, B2, B3, B4, B5). An oscilloscope can be used to detect/determine the status of the circuitry at these test points.

Figure A-7.  
Circuit location of each test point

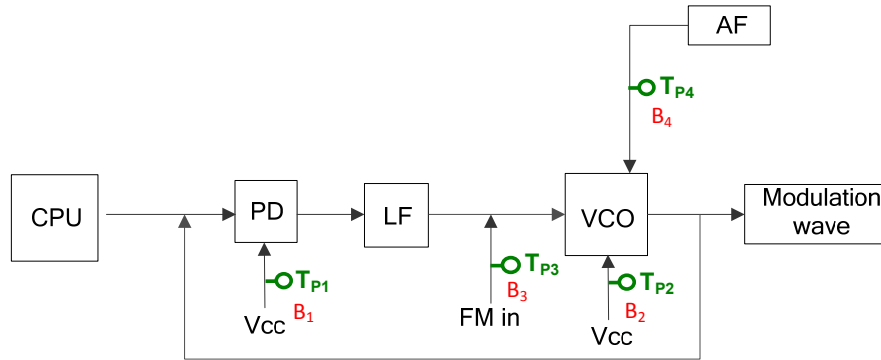

8. Install the GRF-1300A driver onto the PC.
  - Connect the GRF-1300A to the PC. Below are the steps for installing the software. Add the install software to the install directory. Click next and a window as shown below appears.

Figure A-8.  
Software  
installation



- Next, click on the “Continue Anyway” button to continue the installation until the installation procedure is complete.

Figure A-9.  
Installation  
procedure is  
complete

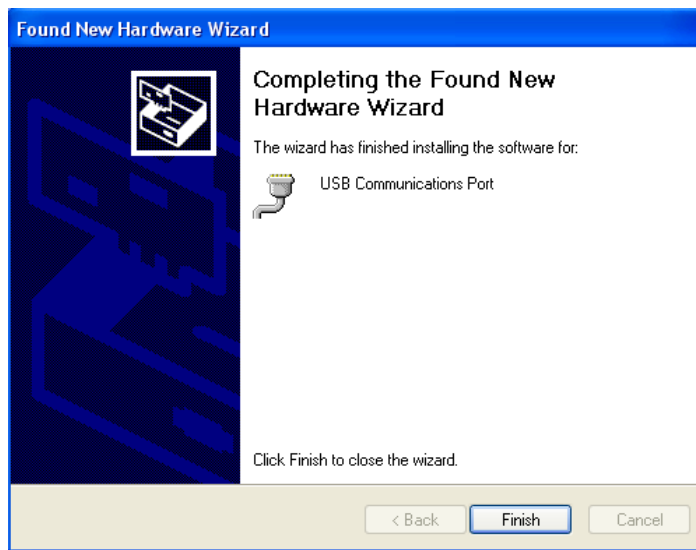

- After the software installation is complete, users can perform a system error check by sending commands to the GRF-1300A using Hyper Terminal.

Figure A-10.  
Operation  
interface for  
HyperTerminal

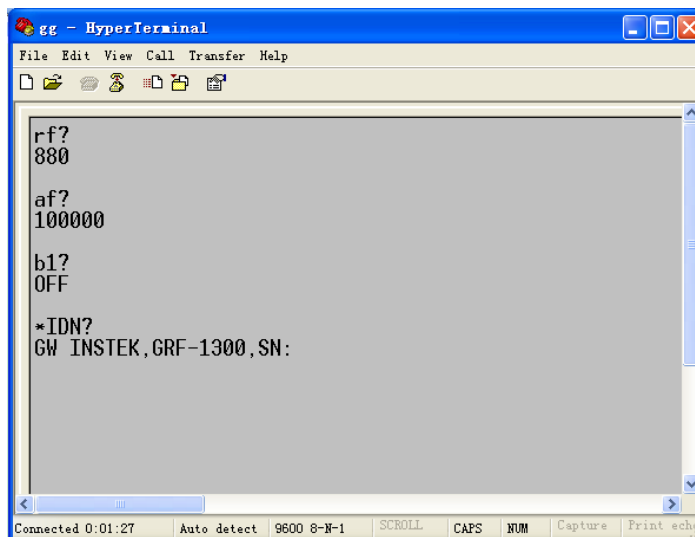



9. Below is a table listing each instruction and a description of each function.

Instruction	Function
*IDN?	Returns the manufacturer, model name and serial number.
RF?	Returns the value on the digital display of the FM/RF module.
AF?	Returns the value on the digital display on baseband module.
WAVE?	Returns the waveform type on the baseband module.
Bn? (n is the relay number for the corresponding test point)	Returns the state (open or closed) of the currently selected relay.
WAVE:0	The waveform to sine.
WAVE:1	Set the waveform to triangle.
WAVE:2	Set the waveform to square.
Bn:0 ( 'n' is the relay number. I.e., B1:0)	Set the relay of corresponding no. to OFF.
Bn:1 ( 'n' is the relay number. I.e., B3:1)	Set the relay of corresponding no. to ON.
AF:N(N is setting frequency)	Set the AF frequency to N.
RF:N(N is setting frequency)	Set the RF frequency to N.

# OVERVIEW of the TIME and FREQUENCY DOMAIN

## Observation from a different perspective

When a signal is said to be in the time domain, it means that the signal is expressed as a function of time. For example, if we describe a sine wave signal that repeats once each microsecond ( $\mu\text{sec}$ ,  $10^{-6}$ ), it means that the period of the signal is 1 microsecond. Usually we use an oscilloscope to measure these signal characteristics in the time domain. In addition, when we talk about the rise and fall time of a square waveform, we also can observe that in the time domain. Phase delay is also measured in the time domain. Oscilloscopes are well-known electrical signal measurement instruments that perform measurements in the time domain.

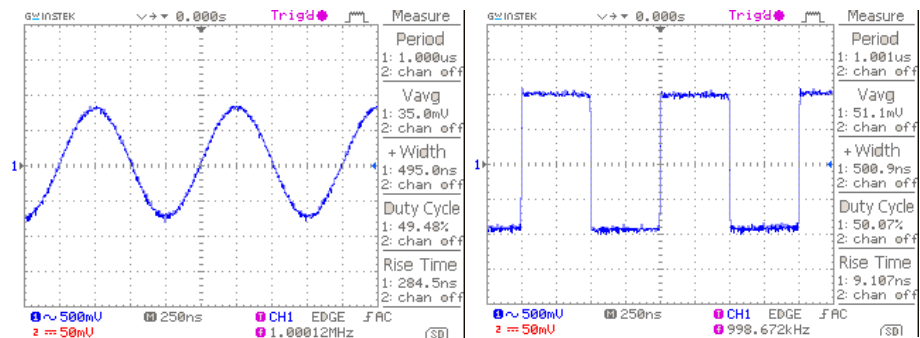

1  $\mu\text{sec}$  sine wave

Square wave with the same period

However, when we observe a sine wave and a square wave with the same amplitude and period, is there a way to describe the difference between them? Frequency domain measurements just provide a different view point.

First we will explain what frequency domain means. Frequency domain means to observe the frequency composition of a signal. If we add a sine wave signal that has a 1 microsecond period to a spectrum analyzer, we will see an obvious signal on the scale at 1 megahertz (MHz). We know that frequency is the inverse of period. Therefore, a sine wave with a period of microsecond has a frequency of 1MHz. You can measure voltage

from an oscilloscope and power (dBm) from a spectrum analyzer. Voltage and power can be converted from one to the other, so both of them can be used to display the strength of a signal. Here we introduce a basic concept first. Each frequency point in the spectrum represents a sinusoidal wave (could be a sine or cosine) of a single frequency.

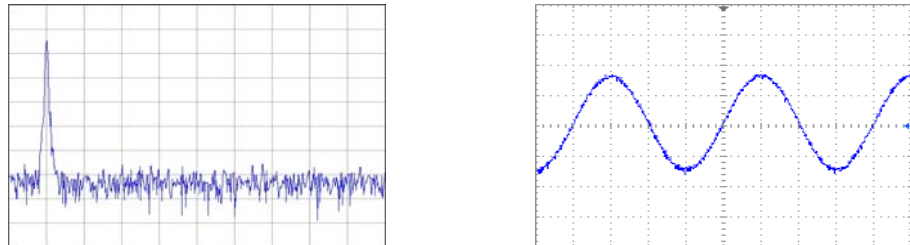

What about a square wave? We will now explain how a square waveform and sine waveform are different to each other in the frequency domain. If we input a square wave with a period of 1 microsecond into a spectrum analyzer, its waveform performance (we usually to say its *spectrum* or *frequency distribution*) is as follows.

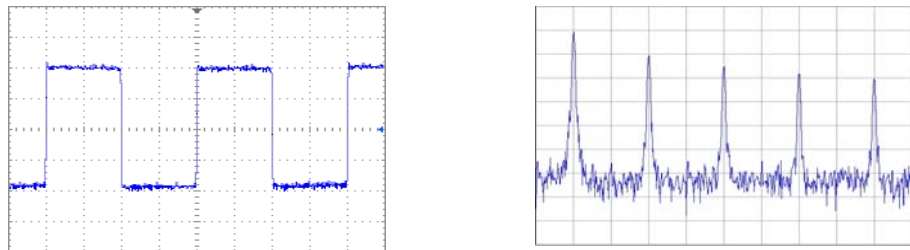

If we compare it with a sine wave spectrum, we can observe that in addition to the point at the 1MHz scale, other signal points also appear at higher frequencies and with decreased amplitudes. Therefore it shows that a square wave also includes a combination of signals that are multiples of the frequency baseband in addition to the 1MHz base frequency (fundamental frequency).

We can see a classic relationship between the time domain and frequency domain in the illustration below. A square wave signal in the time domain can be decomposed into multiple basic harmonic waves. The distribution of these harmonic components can be clearly seen in the frequency domain. Frequency domain analysis describes the characteristics of a signal from another viewpoint.

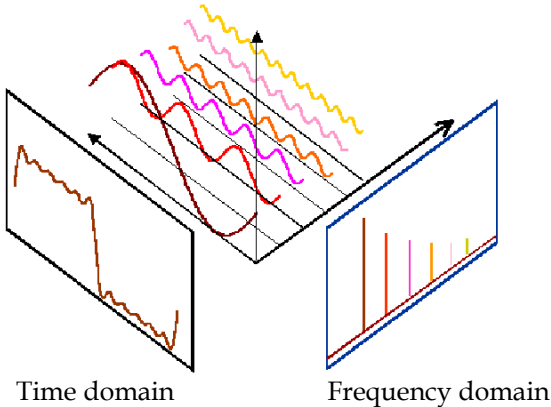

**NOTES**

---

---

---

---

---

---

---

---

---

---

---

---

---

---

---

---

---

---

---

---

---

---

---

---

---

---

---



**NOTES**

---

---

---

---

---

---

---

---

---

---

---

---

---

---

---

---

---

---

---

---

---

---

---

---

---

---





**NOTES**

---

---

---

---

---

---

---

---

---

---

---

---

---

---

---

---

---

---

---

---

---

---

---

---

---

---

---

---

---

---

# A

## N INTRODUCTION to SPECTRUM ANALYZERS

Spectrum analyzers are one of the most important instruments for RF microwave measurements. Being familiar with spectrum analyzers in general is very important for operating high frequency microwave equipment or for performing communication measurements. In addition, being familiar with the basic operating principals will allow you to quickly understand other related test equipment. In this chapter, we will briefly introduce the basic working principles of the spectrum analyzer. After understanding the basic working principles, you will find that a spectrum analyzer can be a handy tool to use.

### Broadband Receiver

---

The principal function of a spectrum analyzer is to convert the input signal frequency down to a frequency (band) that detection circuitry can handle. For example, a 2.4GHz signal needs to be down-converted to several MHz before the Detection & Display unit can process the signal. Therefore a spectrum analyzer must be able to reduce the frequency band down to several MHz. The first half of a spectrum analyzer is called the radio frequency module and its task is to reduce the input signal frequency. A mixer and a bandpass filter are used to decrease the frequency (they can raise the frequency as well). The mixer is a component with three ports: two inputs and one output. Assume that the two input frequencies on input port are  $f_{RF}$  and  $f_{LO}$  respectively, and then the output frequency will be  $f_{IF}$ .  $f_{IF}$  is made of two signals of different frequencies ( $f_{LO} - f_{RF}$  and  $f_{LO} + f_{RF}$ ) that appear on the output port at the same time. One signal is the sum of the input signals and the other is the difference. Determining which of the IF signals that will be used depends on the system and subsequent bandpass filter design. As for why the three ports are named after RF, LO, IF, they are just the conventional terms that are used.

---

Figure B-1.  
The basic structure of a broadband receiver

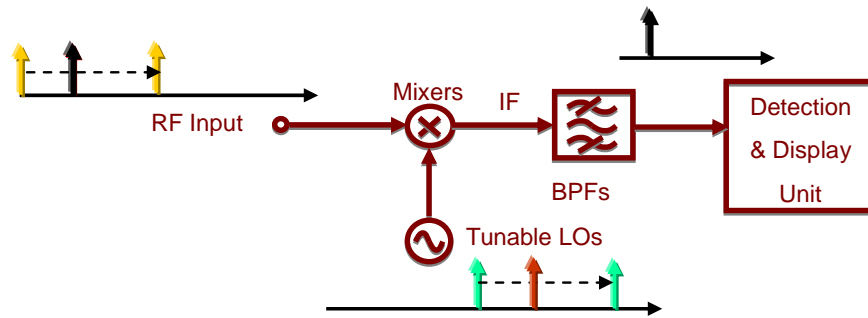

Next, we are going to introduce the other basic functional blocks that a spectrum analyzer is composed of. These blocks are often mentioned when instructed on how to use a spectrum analyzer.

## Attenuator

An attenuator on the RF input path can increase the dynamic range of the input signal level or provide more input protection to the spectrum analyzer. Referring to Figure B-2, the attenuator limits the signal level coming to the mixer (RF end) to a certain level. If the input signal is above a reference level, it can cause measurement errors, or cause spurious noise.

Figure B-2.  
Attenuator

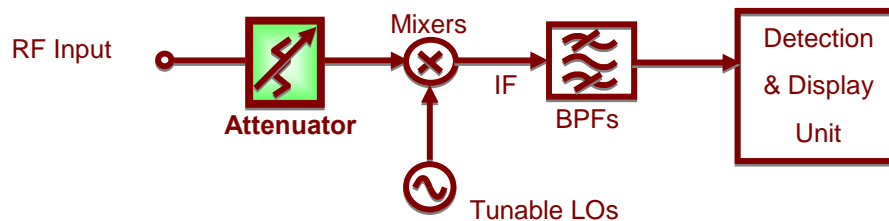

## Resolution Bandwidth Filter

When the input signal frequency is converted to an IF, a RBW (resolution bandwidth) filter is used to distinguish the signals that are close to each other in frequency. Figure B-3 shows this concept.

Figure B-3.  
Basic structure of a resolution bandwidth filter

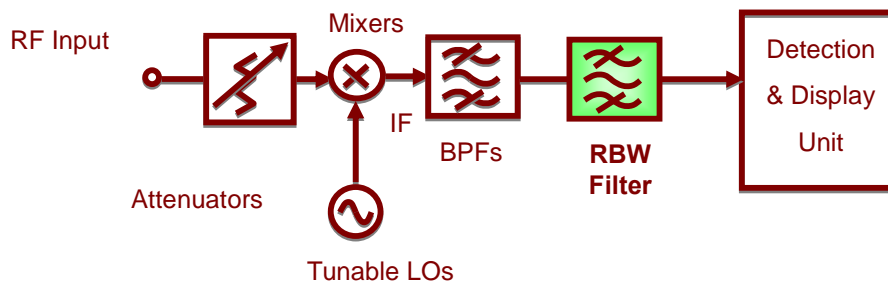
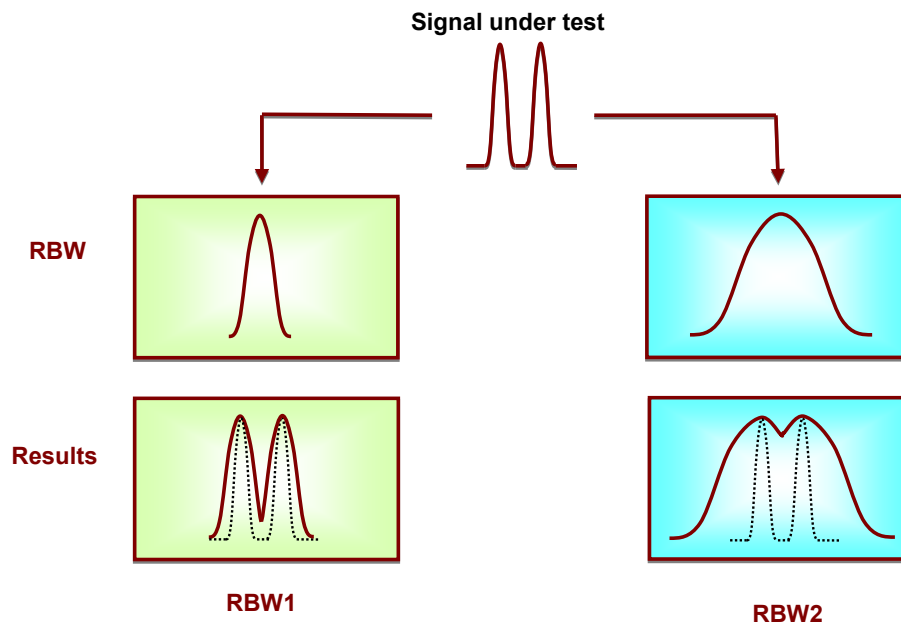

Figure B-4 shows how two different RBW filters distinguish between two signals that are close to each other in frequency. The bandwidth of RBW2 is wider than that of RBW1.

Figure B-4.  
The effect of different RBWs (1)



After passing the narrower RBW1 filter, the components of the two tone signal are clearly distinguished from each other as a result. But in the wider RBW2 filter, the result is not as clear as RBW1. We can predict that if the resolution bandwidth of RBW2 is wider, we could even misinterpret the result as only one signal. This will also happen if these two signals are even closer together in frequency.

Another case is when the amplitude of one signal is much higher than the other; the smaller signal can still be detected using RBW1, but it is obscured if RBW2 is used. Figure B-5 illustrates this difference. This is why these filters are known as resolution bandwidth filters.

Figure B-5.  
The effect of  
different RBWs  
(2)

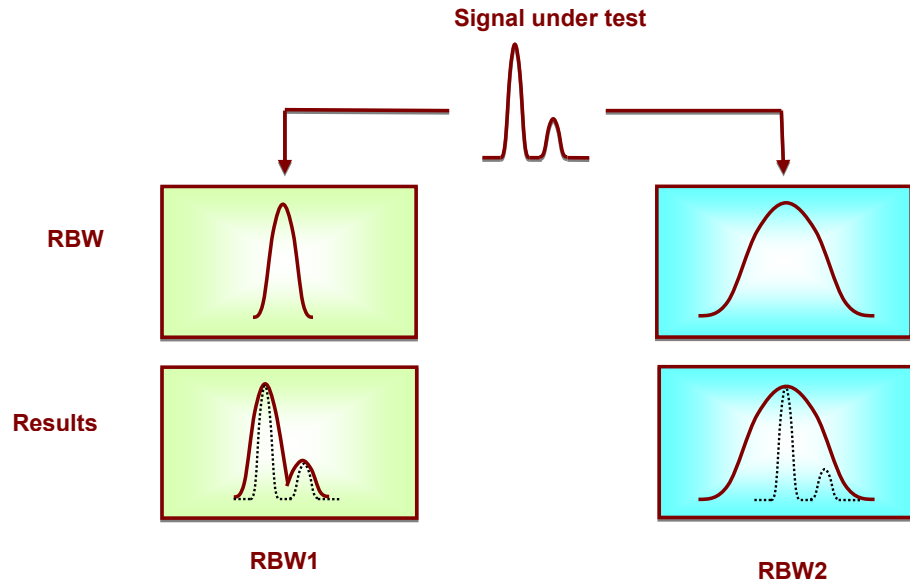

## Detector

Following the RBW filter, the detector detects the power and converts it to DC voltage via an ADC so that it can be displayed.

Figure B-6.  
Detector

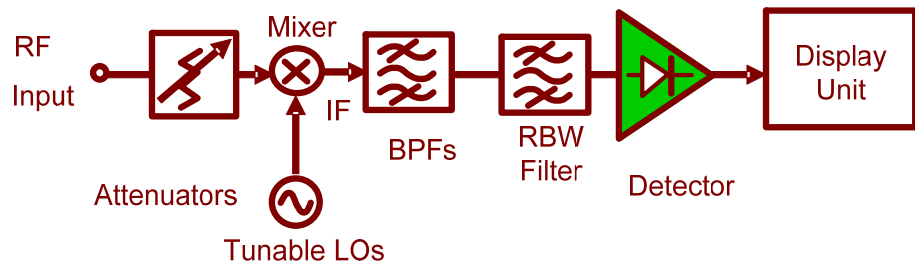

## Video Bandwidth Filter

However, a filter is employed after the detector to filter out the noise generated by the detector. This is the function of the VBW (video bandwidth) filter as shown in Figure B-7.

Figure B-7.  
VBW filter

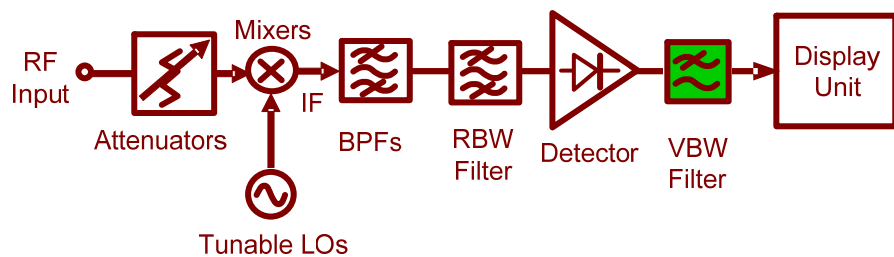
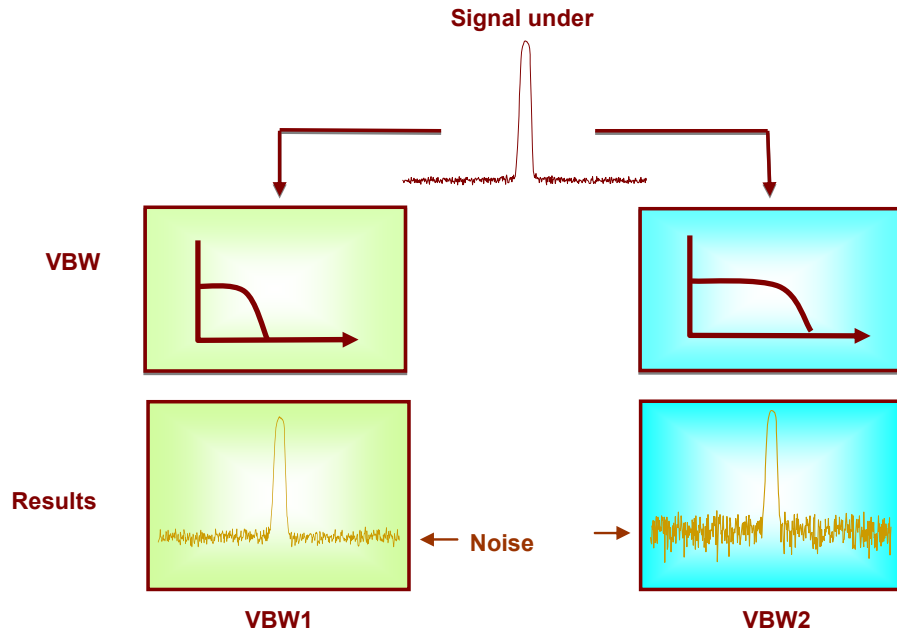

Figure B-8 shows how the VBW affects the displayed output. If the signal under test passes through two different VBW filters, in which VBW1 is less than VBW2, we can see that the magnitude of the noise floor of VBW2 is greater than that in VBW1. But notice that the average level of the noise floor remains the same. The VBW filter only averages the noise level; It doesn't affect the overall amplitude of the signal noise floor.

Figure B-8.  
Different VBWs









# RF COMMUNICATION and SIGNALS

## EXPERIMENTS

In this chapter we will explain the basic operating principals of a spectrum analyzer and introduce the measurement experiments. Prior to this, we will briefly explain how to operate the GW Instek GSP-730 spectrum analyzer. For more detail about its operation, please refer to the GSP-730 user manual.

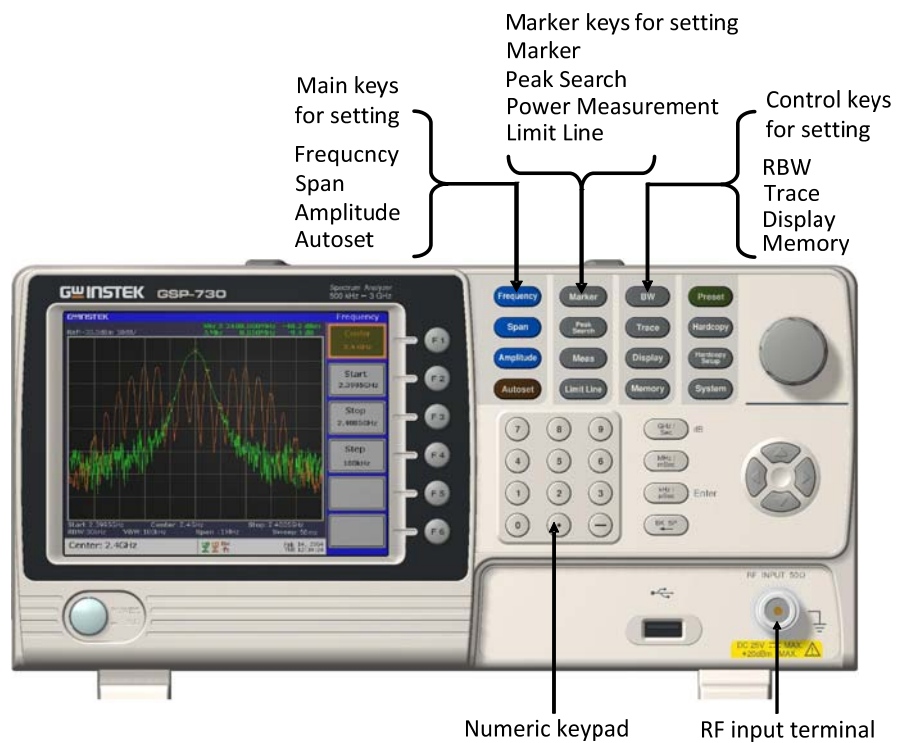

## Experiment 1: Basic Operation of a Spectrum Analyzer

**Relevant information**

In addition to the sky, oceans and forests, there is an invisible, intangible, inaudible and complex electromagnetic network in our living environment. This network is intertwined with wireless signals of various frequency bands. Although these signals are invisible and intangible, we can use a spectrum analyzer to understand and analyze these wireless signals.

In this experiment, the GSP-730 spectrum analyzer is used to capture some wireless signals in the environment. This experiment will help students to become familiar with using spectrum analyzers as well as to arouse their curiosity in the field of RF signals.

Item	Equipment	Quantity	Note
1	Spectrum analyzer	1	GSP-730
2	Adapter	1	N-SMA
3	Antenna	1	800

**Experiment goals**

To become familiar with how to use the GSP-730 and how to use parameter settings such as frequency, amplitude and markers.

**Experiment principles**

Spectrum analyzers are mainly used to measure physical quantities such as the frequency and amplitude of a signal. For basic operation, the frequency range must be set first, then the reference level amplitude.

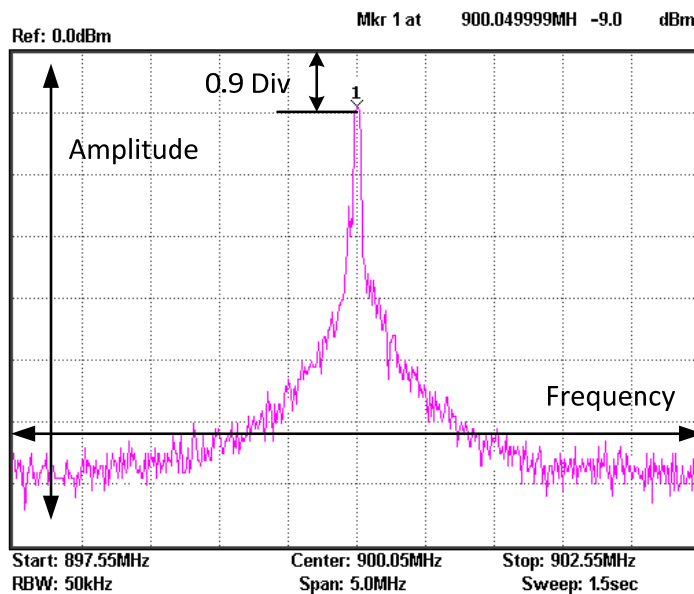

The figure above is a screen shot from a typical spectrum analyzer display. The horizontal setting is frequency and the vertical axis is amplitude. Therefore a spectrum analyzer is basically used to perform frequency and amplitude-related measurements. We can operate a spectrum analyzer by using the Frequency, Amplitude and other function keys in conjunction with the keypad to control the frequency, amplitude and other related settings.

The Frequency, Amplitude and Span keys as well as the keypad and unit keys.



There are two ways to set the frequency. If the frequency of the signal that you want to measure is known, then we can set the frequency using the center frequency and span functions. If we need to measure a frequency *range*, then we can set the start and stop frequency range.

**Experiment contents**      Connect the antenna to the GSP-730 spectrum analyzer to test the radio waves in the environment.

**Experiment steps**      1. Connect the antenna to the GSP-730 spectrum analyzer.  
 Measure the strength of a mobile phone’s transmitter signal. Because the frequency band of a mobile phone is between 800MHz - 1900MHz, we will set the frequency range between 800 - 1900MHz.

2. Set the GSP-730 as follows:
- Start frequency: 800MHz,
  - Stop frequency: 1900MHz
  - Reference level: -30dBm
  - RBW (RBW): Auto

Step1      **Frequency** F2 8 0 0      MHz/ mSec      **Start 800.0MHz**

Step2      **Frequency** F3 1 . 9      GHz/ Sec      **Stop 19GHz**

Step3 **Amplitude** (F1) — 3 0 **GHz/Sec** **Ref. Level -30.0dBm**

Step4 **BW** (F1) **RBW Auto Man**

- Now we should see some signals on the spectrum analyzer screen. Identify the three highest peaks and write down their frequency values. The reference level can be used to adjust the strength of the signal.
- As mobile phones use frequency hopping, we can use the Peak Hold function to hold the reading of the signal on the display screen. Record the frequency and amplitude of the signal.

Step5 **Trace** (F3) **Peak Hold**

- Change the span to 5MHz. Set the center frequency to each of the above three frequency points in sequence so that you can observe each one more accurately. Record these three frequency points in Table 1-1.

Step6 **Frequency** (F2)

Set the center frequencies to each of the three frequency points

Step7 **Span** 5 **MHz/mSec** **Span 5.0MHz**

- Testing the wireless signals in the environment is shown in the picture below.

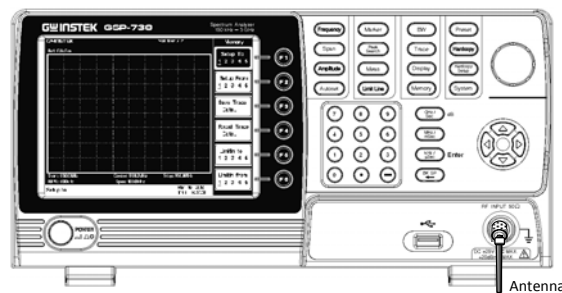

**Experiment results**

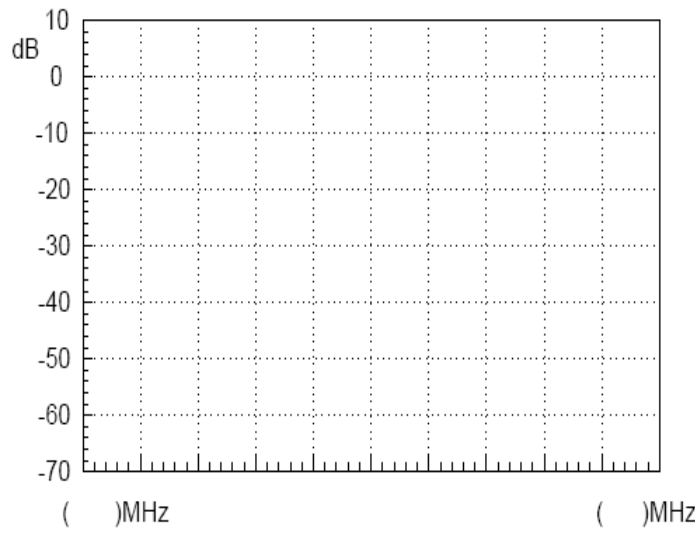

Frequency: \_\_\_\_\_ Amplitude: \_\_\_\_\_

---

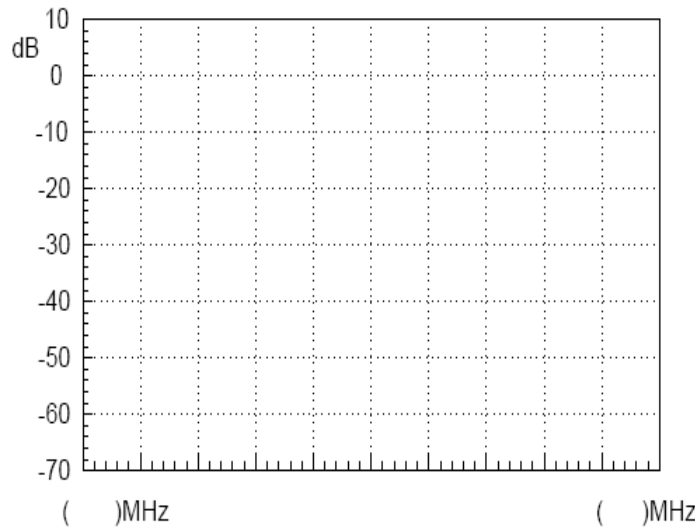

Frequency: \_\_\_\_\_ Amplitude: \_\_\_\_\_

---

Table 1-1. Frequency and amplitude of mobile phone's transmitter signal.

---

**Question** In addition to the mobile phone signal, what other wireless signals can be measured in the environment?

---

## Experiment 2: Measuring a Baseband Waveform

**Relevant information** Relative to oscilloscopes, spectrum analyzers have many outstanding advantages. They are also the primary measurement tool for measuring frequency domain data. Learning how to use a spectrum analyzer is an essential skill that every student must master to gain RF knowledge.

By measuring a baseband signal, this experiment allows students to comprehensively understand how to operate a spectrum analyzer and lays the foundation for subsequent experiments.

Item	Equipment	Quantity	Note
1	Spectrum analyzer	1	GSP-730
2	RF & Communication Trainer	1	GRF-1300A
3	RF wire	1	800mm
4	Adapter	1	N-SMA

**Experiment goals**

1. Measurement and analysis on a basic signal.
2. To understand how to use the GRF-1300A system to output a baseband signal.

**Experiment principles** Set the GRF-1300A to output a 1MHz sine waveform and use the GSP-730 to measure its spectrum. The working principle of a spectrum analyzer has been introduced in a previous chapter. We won't repeat it here.

**Experiment contents** Set and then measure the spectrum of a 1MHz sine wave. Measure the harmonic ratio at each of the harmonic frequencies.

**Experiment steps**

1. Turn on the GRF-1300A and the GSP-730.
2. Set the GRF-1300A baseband as follows:
  - Waveform: Sine wave
  - Frequency: 1MHz.
  - Turn the amplitude knob clockwise to its end.

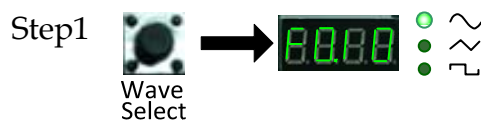



3. Connect the baseband signal from the output port of the GRF-1300A to the input terminal of the GSP-730 using the RF wire.

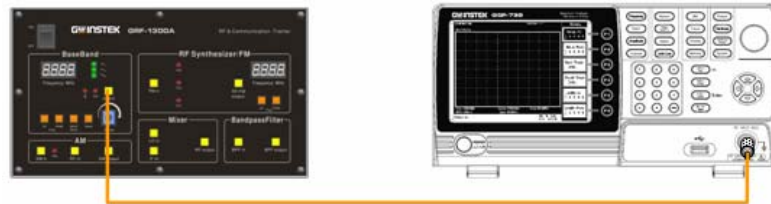

4. Set the GSP-730 as follows:

- Center frequency: 2.5MHz
- Start frequency: 0kHz,
- Stop frequency: 5MHz
- Reference level: 10dBm
- RBW: Auto

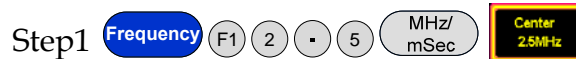

When the first step is done, steps 2 and 3 (below) will have already been automatically set. Students may do steps 2 and 3 here is for reference only.

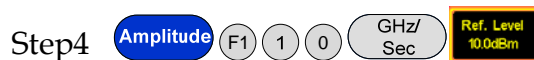
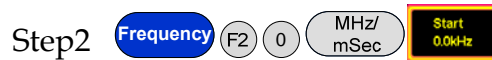

5. Utilize the Marker function on the spectrum analyzer to determine the harmonic ratio and draw the spectrum in Table 2-1.



After step 6 is done, make sure the "Delta" marker is used for the next steps and not the "Normal" marker. Set the Delta Marker to the peak point of each harmonic and make a record by drawing a simple sketch of the spectrum in table 2-1.

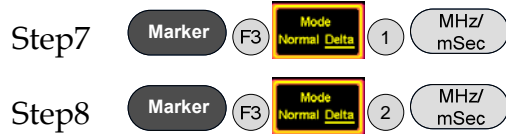

6.A function signal generator can also be used as a signal source in the above measurement, but be aware that the amplitude of the output signal can't be too high.

dBm is a power unit that is referenced to 1mW. The formula for X dBm =  $10 \cdot \log(P_x/1mW)$

Putting 10 mW into the above formula, we get  $10 \cdot \log(10/1) = 10 \cdot 1 = 10dBm$ . Similarly if we input 100 mW into the above formula,  $X = 10 \cdot \log(100mW/1mW) = 10 \cdot 2 = 20dBm$ .

Because the output voltage of a signal generator is often used expressed as a voltage into a 50 ohm load, you must convert voltage to power. A few common values are listed below:

Converting Voltage to dBm: (into 50 ohm load)

Vpp (V)	Vm (V)	Vrms (V)	P (mW)	dBm
10.00	5.00	3.54	250.00	23.98
5.00	2.50	1.77	62.50	17.96
2.00	1.00	0.71	10.00	10.00
1.00	0.50	0.35	2.50	3.98

Converting dBm to Voltage: (into 50 ohm load)

dBm	P (mW)	Vrms (V)	Vm (V)	Vpp (V)
20.00	100.00	2.24	3.16	6.32
10.00	10.00	0.71	1.00	2.00
0.00	1.00	0.22	0.32	0.63
-10.00	0.10	0.07	0.10	0.20

If voltage is measured without a load on an oscilloscope, the Vpp and Vm values should be multiplied by 2. For instance, when we get a measured value of 4Vpp into no load, it is the equivalent of 2Vpp into 50 ohms, or 10dBm after conversion.

**Experiment results**



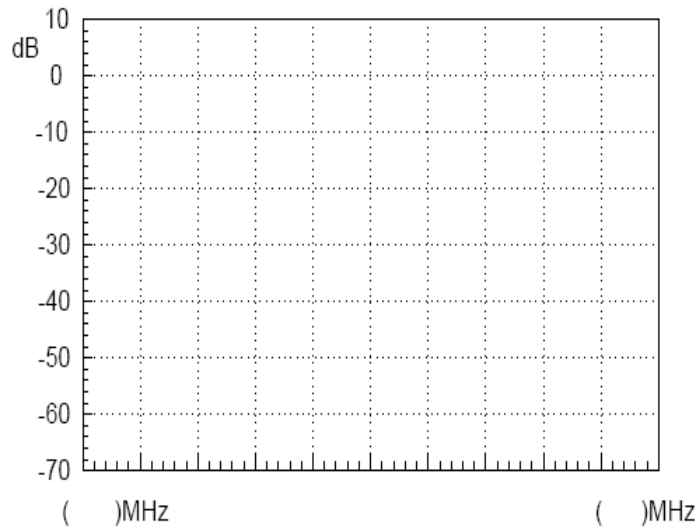

The 2<sup>nd</sup> harmonic ratio is:

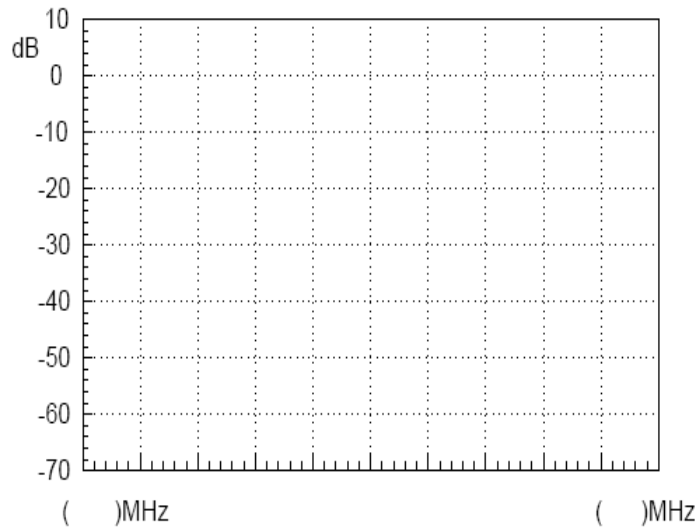

The 3<sup>rd</sup> harmonic ratio is:

Table 2-1. 1MHz sine wave spectrum test results

**Question**

1. What is the spectrum of a theoretical sine wave and why is it different with the actual measured one?
2. What is the frequency domain feature of the analyzed signal?

**Caution**

1. The output power should not exceed the rated input of the spectrum analyzer, otherwise the spectrum analyzer will be damaged.
2. When using the RF cable to make a connection, be sure to tighten the connector.

## Experiment 3: Different Baseband Waveforms and their Harmonic Measurement

**Relevant information**

You should already be familiar with electrical signals in general. We have already said that an oscilloscope is used to observe the amplitude of a waveform. In other words, it is used to observe how an electrical signal,  $X(t)$ , varies over time. However, depending on what we are trying to study, the reason for measuring a signal can also be different. For example, when we analyze amplifiers, filters and mixers, we are no longer interested in measuring a function related to time, but a response function which can be characterized by frequency.

In this experiment, you will find that analyzing a signal in the frequency domain often has a lot of advantages compared to analyzing a signal in the time domain. You will also find that there is a relationship that exists between the time domain and the frequency domain, and will thus gain a better understanding of the theory behind the Fourier series.

	Item	Equipment	Quantity	Note
<b>Experiment equipment</b>	1	Spectrum analyzer	1	GSP-730
	2	RF & Communication Trainer	1	GRF-1300A
	3	Oscilloscope	1	GDS-2204
	4	RF wire	1	800mm
	5	Adapter	1	N-SMA

**Experiment goals**

1. Measure the harmonic content that is output from the baseband signal.
2. Use the measurement results to verify the Fourier series theorem.
3. Understand the internal relationship between the time domain and the frequency domain in a signal.
4. Use this experiment to become familiar with how to measure the spectral characteristics of a typical signal, such as the amplitude and frequency.

**Experiment principles**

Set the waveform on the GRF-1300A and measure the harmonic spectrum. Switch to a different waveform and measure the harmonic spectrum. Compare the differences. The relationship between the time domain and the frequency domain has already been introduced in chapter 3. We won't repeat it again here.

**Experiment contents**

We will become familiar with using a spectrum analyzer and how to use the GRF-1300A by analyzing the spectrum of a simple triangle and square wave signal.

**Experiment steps**

1. Turn on the GRF-1300A and the GSP-730.
2. Set the GRF-1300A baseband as follows:
  - Waveform: triangle
  - Frequency: 1MHz.
  - Turn the input amplitude knob clockwise to the end.

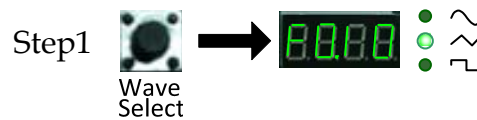

3. Connect the baseband signal from the output port on the GRF-1300A to the input terminal on GSP-730 with the RF cable.

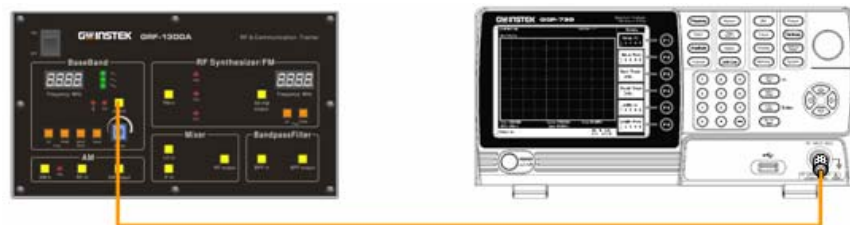

4. Set the GSP-730 as follows:
  - Center frequency: 15MHz
  - Start frequency: 0kHz,
  - Stop frequency: 30MHz, Span: 30MHz

- Reference level: 0dBm
- RBW: Auto

Step1 F1 3 0 MHz/mSec

Step2 F1 1 5 MHz/mSec

Step3 F1 0 GHz/Sec

Step4 F1

5. Observe the spectrum that appears. Use the Marker function on the spectrum analyzer to determine the harmonic ratio and draw the spectrum in Table 3-1.

Step5

After step 4 is done, make sure the "Delta" marker is used for the next steps and not the "Normal" marker. Set the Delta Marker to the peak point of each harmonic and make a record by drawing a simple sketch of the spectrum in table 3-1.

Step 6 F3 2 MHz/mSec

Step 7 F3 4 MHz/mSec

6. Select the square wave on the GRF-1300A Baseband module. Do the same spectrum measurements that were performed in the previous steps.

Step8

7. Observe the square wave spectrum that appears on the spectrum analyzer. Use the marker function to record the harmonic ratio and draw the spectrum in table 3-3. Draw the spectrum of the square wave spectrum as you did previously for the triangle wave. Remember to remove the

delta marker ( $\Delta$ -Marker) that was originally used with the triangle wave.

Step9 **Marker** (F3) **Mode** Normal Delta

After the spectrogram on table 3-3 is drawn, measure the harmonic ratio of each harmonic using the following steps:

Step10 **Marker** (F3) **Mode** Normal Delta 1 **MHz/** mSec

Step11 **Marker** (F3) **Mode** Normal Delta 2 **MHz/** mSec

In accordance to the method that is used above to measure the harmonic ratio, students can try to measure the harmonic ratio of the higher order harmonics.

- After measuring the spectrum, connect the output port to the input port of the oscilloscope and measure the time domain waveform of the triangle wave and square wave, and record the results in Table 3-2 and Table 3-4.

**Experiment results**

- In the tables below, record the measurement results of the time domain waveforms and the frequency domain spectrum for both the triangle and square waves.

Table 3-1.  
1MHz triangle wave spectrum test results.

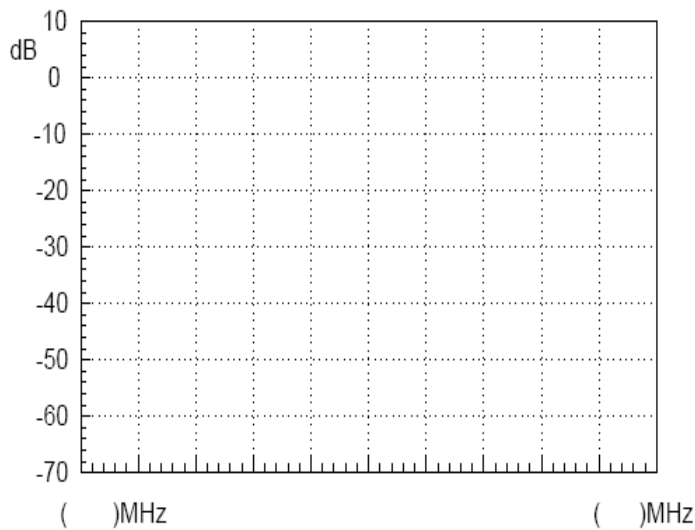

Table 3-2.  
Time domain  
waveform of the  
1MHz triangle  
wave.

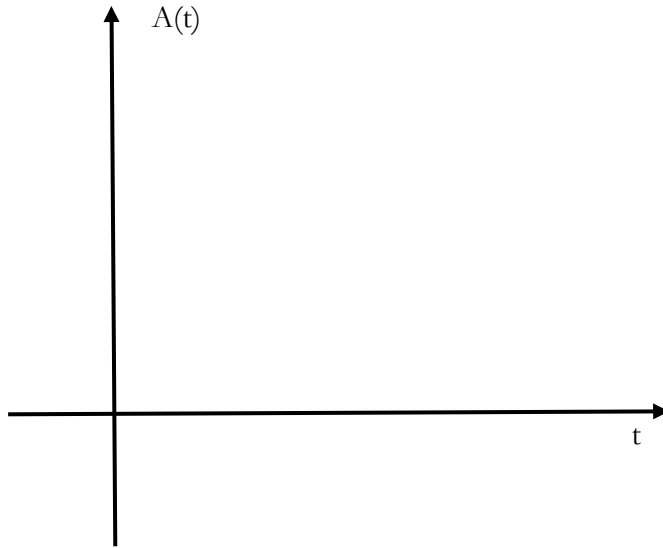

Table 3-3.  
1MHz square  
wave spectrum  
test results.

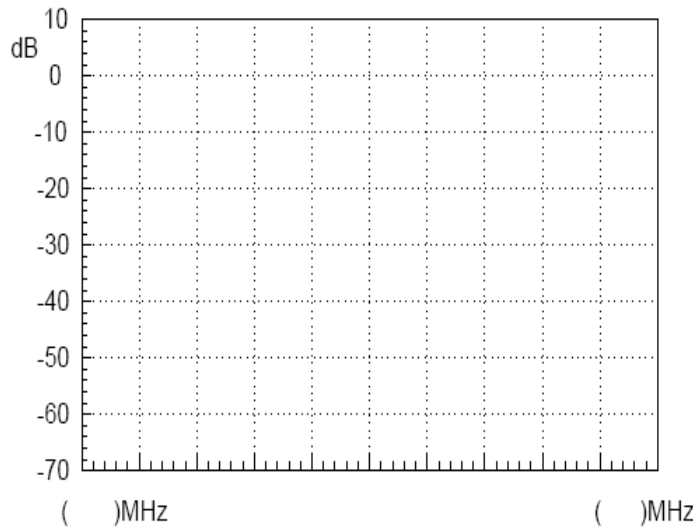
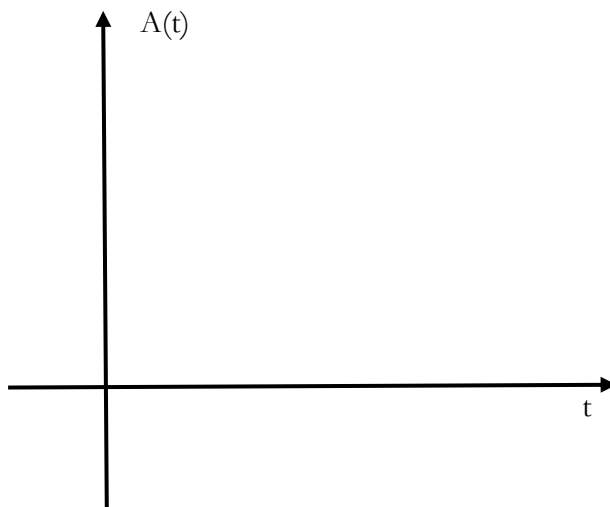
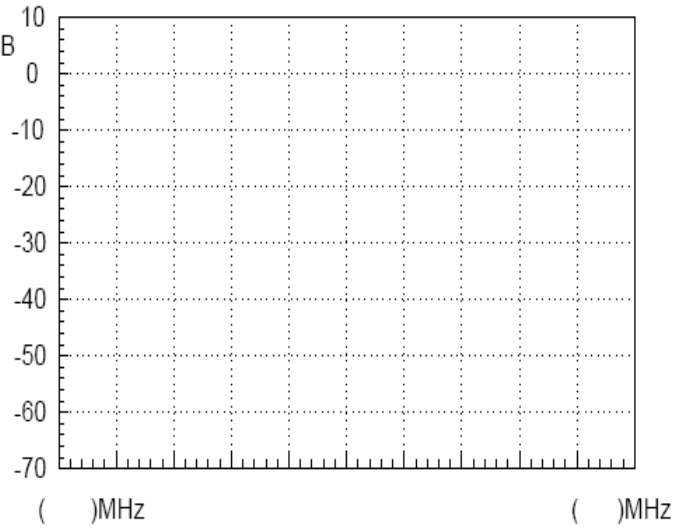

Table 3-4.  
Time domain  
waveform of the  
1MHz square  
wave.



2. For the triangle waveform, measure the harmonic ratio of the 3<sup>rd</sup> and 5<sup>th</sup> harmonic. For the square waveform, measure the harmonic ratio of the 2<sup>nd</sup> and 3<sup>rd</sup> harmonic.

Harmonic ratio of the 3<sup>rd</sup> harmonic (triangle wave)



Harmonic ratio of the 5<sup>th</sup> harmonic (triangle wave)

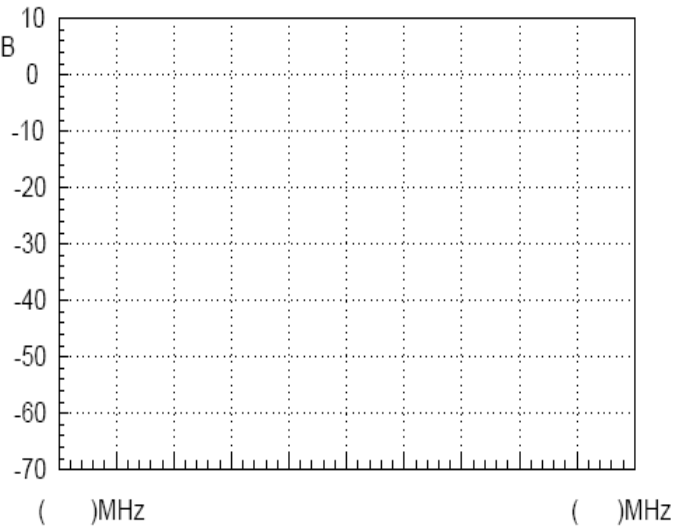

Harmonic ratio of the 2<sup>nd</sup> harmonic (square wave)

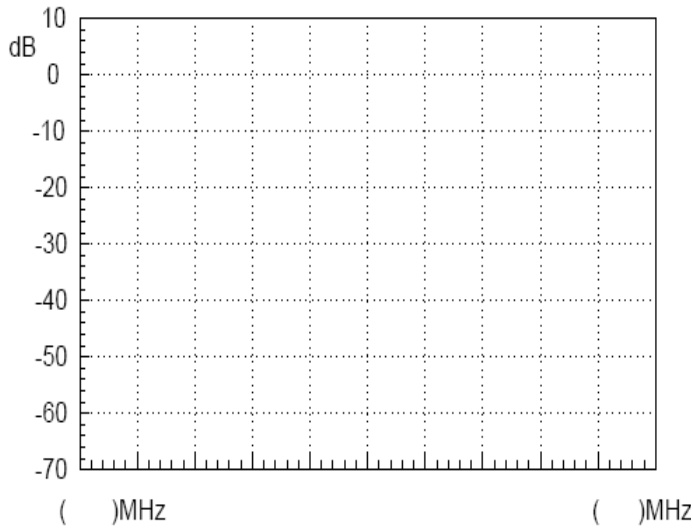

Harmonic ratio of the 3<sup>rd</sup> harmonic (square wave)

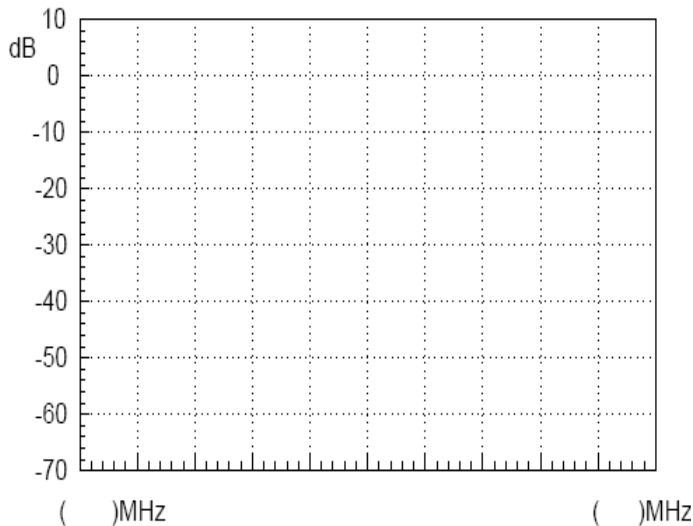

**Question**

1. Compare the measurement results from the frequency domain and the time domain, and consider the relationship to the Fourier series theory.
2. Analyze the difference between the triangle and square wave spectrum. Write their Fourier series in the form of a trigonometric function. What relationship do you find between each harmonic and each term in the series?

**Caution**

There are different ways to set the center frequency on a spectrum analyzer. Set it according to your needs.



## Experiment 4: Measurement of the RF Carrier

**Relevant information**

In communication systems, RF signals generally use carrier signals. As a low frequency signal cannot be easily transmitted very far over air, the low frequency message (such as voice) must be placed into a higher frequency signal so it can be being transmitted over a distance using an antenna. This high-frequency signal carries the message, and is thus called the carrier. In this experiment we will perform basic measurements on RF signals and measure important parameters such as phase noise and harmonic distortion.

The carrier of this experimental system is generated by a PLL. Phase locked loops are widely used as phase-locked receivers, or for phase-locked frequency modulation and demodulation. They are also often used as a local oscillator for transmitters and receivers. We must learn in detail the working principles of PLL circuits when we study RF circuits. This experiment allows students to comprehend high frequency signals by measuring the carrier frequency spectrum. It also makes students recognize the basic structure of a PLL circuit. In the following experiments, we will further study the locked and unlocked conditions of a phase-locked loop.

	Item	Equipment	Quantity	Note
<b>Experiment equipment</b>	1	Spectrum analyzer	1	GSP-730
	2	RF & Communication Trainer	1	GRF-1300A
	3	RF wire	1	800mm
	4	Adapter	1	N-SMA

**Experiment goals**

Measure an RF signal from the GRF-1300A RF & Communication Trainer. Also perform measurements on more important parameters such as phase noise and harmonic distortion.

**Experiment principles**

A Phase locked loop (PLL) is a phase error control system. It compares the phase between a reference signal and an output signal to generate a phase error voltage for adjusting the frequency output of the voltage-controlled oscillator - for the purpose of synchronizing the output frequency with the reference signal. Its basic circuit structure is shown in Figure 4-1.

Figure 4-1. PLL circuit structure

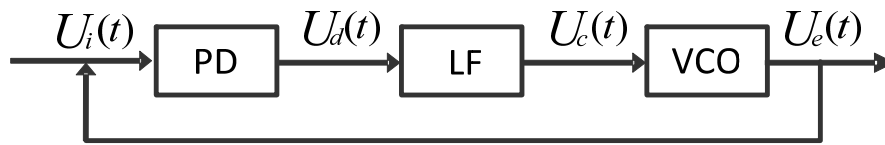

Above: PD is the phase-locked loop phase detector, LF is the loop filter and VCO stands for voltage-controlled oscillator.

The purity of the output signal from the VCO is directly related to the phase noise. The lower the distortion of the output signal, the lower the harmonic components and noise contained in the output signal.

Phase noise is usually specified in dBc/Hz at a given frequency offset value, where dBc is dB in relation to the center frequency. The phase noise of an oscillator is normalized to the noise generated in a bandwidth of 1Hz. The phase noise is usually calculated using the formula below, where  $f_m$  is the frequency of a single sideband from the carrier and  $P_{ssB}$  is the measured sideband power:

$$L(f_m) = (P_{ssB} - P_0) - \log B + 2.5$$

where,

$$B = 1.2RBW \text{ (RBW is the resolution bandwidth)}$$

Figure 4-2. Phase noise definition

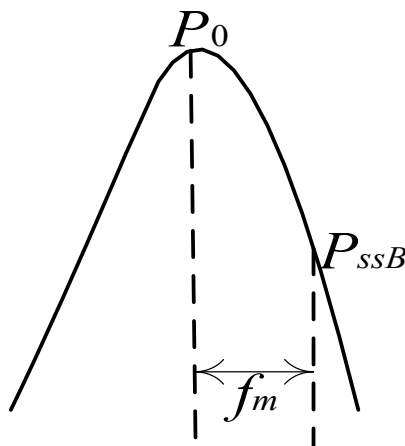

As the oscillator is a non-linear component, it will produce higher-harmonic content. Harmonic distortion is also an important factor for RF signals. In general we use a filter to filter this out.

**Experiment contents**

1. Measure the RF signal spectrum.
2. Measure the harmonic distortion of the RF signal.
3. Measure the phase noise of the RF signal.

**Experiment steps**

Measure the RF signal spectrum and harmonic distortion.

1. Turn on the GRF-1300A and GSP-730. Leave the GRF-1300A in its power-on state.
2. Connect the RF/FM output port on the GRF-1300A to the input terminal on GSP-730 with the RF cable.
3. Set the GSP-730 as follows:
  - Span: Full Span
  - Reference level: 0dBm
  - RBW: Auto: Auto

Step1 

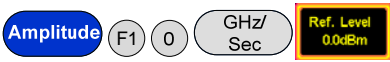
Step2 

Step3 

4. On the observed spectrum, use the marker function to measure the amplitude of each frequency point. The Next peak function can be used to find each consecutive peak. Plot the results in table 4-1.

Step4 

Step5 

5. Draw the results in table 4-1. The harmonic ratio of each the harmonic can be measured according to the following steps.

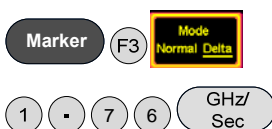
Step6 

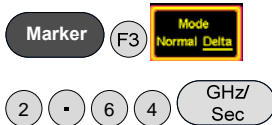
Step7 

For the last two steps, the span is quite large, and may produce some errors. To find the second and third harmonic, you may need to fine-tune the frequency. Record the results in table 4-2.

Measure the RF phase noise.

1. Turn on the GRF-1300A and the GSP-730.
2. Set the GRF-1300A RF Synthesizer/FM as follows:
  - Carrier frequency: 875MHz



3. Connect the RF/FM output port on the GRF-1300A to the input terminal on GSP-730 with the RF cable.



4. Set the GSP-730 as follows:
  - Center frequency: 875MHz
  - Span: 1MHz
  - Reference level: 0dBm
  - RBW: Auto (default state is 50kHz)

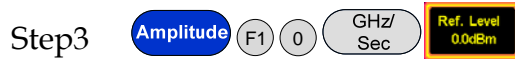
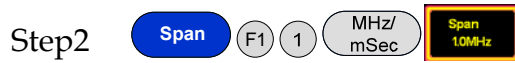
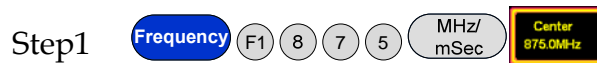

5. Record the carrier power. Set the deviation of the carrier frequency  $f_m$  to a deviation ( $\Delta$ ) of 100kHz. Use the Delta

marker function on the spectrum analyzer to measure the  $\Delta$  value.



Record the value, then calculate the phase noise according to the formula, and record the spectrum and measurement results in Table 4-3.

- Adjust the PLL output frequency to 900MHz, and again measure the power and phase noise corresponding to the frequency.

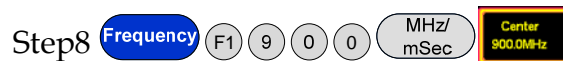
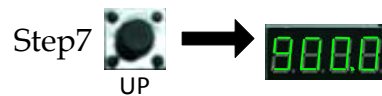

Record the carrier power. Set the deviation carrier frequency  $f_m$  to a deviation ( $\Delta$ ) of 100kHz. Use the Delta Marker function on

the spectrum analyzer to measure the  $\Delta$  value.



Record the value, then calculate the phase noise according to the formula, and record the spectrum and measurement results in Table 4-3.

- Adjust the PLL output frequency to 910MHz, and again measure the power and phase noise corresponding to the frequency.



Step12 **Frequency** F1 9 1 0 MHz/mSec **Center 910.0MHz**

Step13 **Peak Search**

Record the carrier power. Set the deviation carrier frequency  $f_m$  to a deviation ( $\Delta$ ) of 100kHz. Use the Delta Marker function on

the spectrum analyzer to measure the  $\Delta$  value.

Step1 **Marker** F3 **Mode Normal Delta** 1 0 0 kHz/uSec

4

Record the value, then calculate the phase noise according to the formula, and record the spectrum and measurement results in Table 4-3.

**Experiment results** 1. Measurement of the RF signal spectrum.

Table 4-1. RF Signal Spectrum

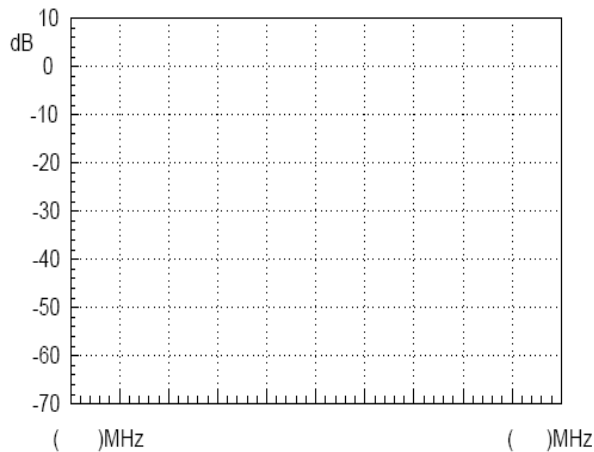

2. RF Signal Harmonic measurements

Table 4-2. RF  
Signal Spectrum

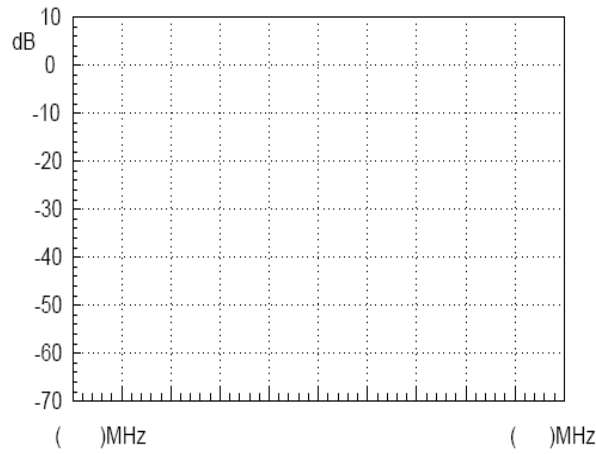

2nd Harmonic measurement

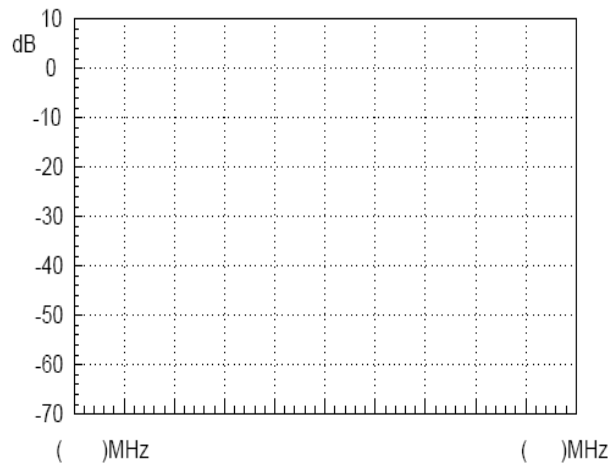

3rd Harmonic measurement

3. Phase noise measurement results

Table 4-3.  
Phase Noise  
measurement  
results

Carrier Frequency	Experiment results
-------------------	--------------------

875MHz

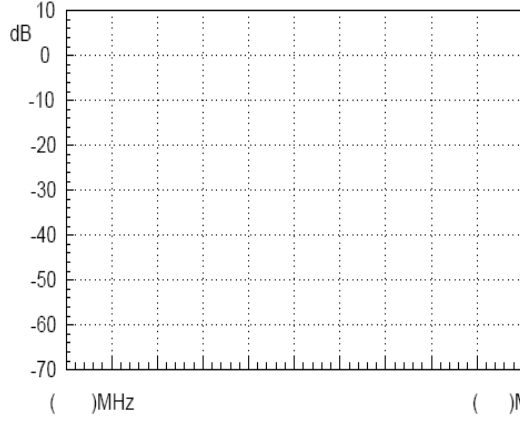

Carrier frequency: \_\_\_\_\_ Output power: \_\_\_\_\_  
Phase noise: \_\_\_\_\_

900MHz

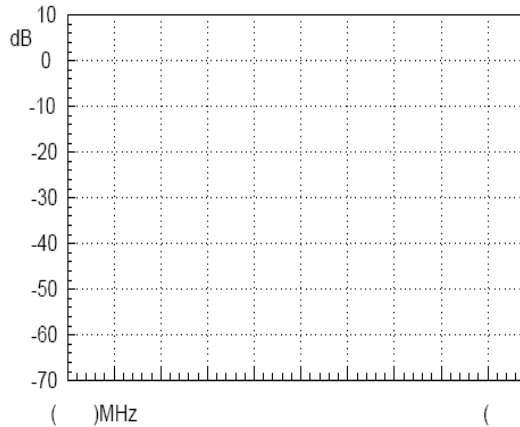

Carrier frequency: \_\_\_\_\_ Output power: \_\_\_\_\_  
Phase noise: \_\_\_\_\_

910MHz

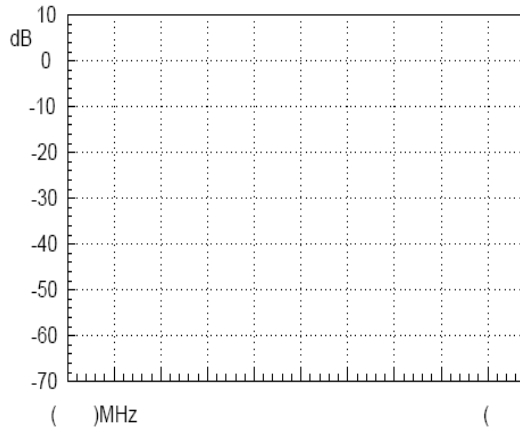

Carrier frequency: \_\_\_\_\_ Output power: \_\_\_\_\_  
Phase noise: \_\_\_\_\_



- Questions**
1. A PLL circuit is formed by which parts? Explain the function of each part.
  2. What are the advantages of a PLL?
  3. Explain the causes of phase noise? How can we improve phase noise?
- 

**Caution** Be sure to tighten the connectors when connecting the RF cable.





**NOTES**

---

---

---

---

---

---

---

---

---

---

---

---

---

---

---

---

---

---

---

---

---

---

---

---

---

---

---

---

---

---



## Experiment 5: AM Signal Measurement

**Relevant information**

Message signals are usually of a low frequency. In general, these low frequency signals are not appropriate for transmission. Therefore, modulation is required to transmit messages for communication and test systems. Modulation is a signal adjustment method used in signal transmission. It is used to modulate a low frequency signal which carries information with a signal of an appropriate frequency. This is used to solve problems associated with the amplification and transmission of weak signals. The role of modulation in RF communication systems is essential. Not only is modulation used to modulate the original low-frequency signal and its transmission, but it is also used for frequency division multiplexing (FDM). If signals with the same frequency range are transmitted on the same channel at the same time, they can easily interfere with each other, and hence why they are first modulated onto different carriers so that multiple signals can be transmitted simultaneously. These experiments start with amplitude modulation. The spectrum analyzer is used to measure the characteristics of AM signals, which has a great significance for students to master FM as well as AM principles and characteristics.

	Item	Equipment	Quantity	Note
<b>Experiment equipment</b>	1	Spectrum analyzer	1	GSP-730
	2	RF & Communication Trainer	1	GRF-1300A
	3	RF wire	2	100mm
	4	RF wire	1	800mm
	5	Adapter	1	N-SMA

**Experiment goals**

1. Learn the working principals of amplitude modulation.
2. Use the spectrum analyzer to measure the AM characteristics of an RF signal.

**Experiment principles**

Modulation is the process of moving a low-frequency signal to a high-frequency and then transmitting the high-frequency signal. Generally the low frequency signal carrying the original information is called the modulating signal or baseband signal. The high-frequency signal is known as the carrier signal. After the carrier signal is modulated by the modulating signal, the resultant signal is called the modulated wave. There are three kinds of modulation methods that are used: AM, FM and phase modulation.

This experiment begins with AM to learn some modulation theory. AM uses the modulating signal to control the amplitude of the high-frequency carrier signal. The modulating signal is used to alter the amplitude of the carrier in proportion to the amplitude of the modulating signal. A high frequency carrier signal that is amplitude modulated is called an AM wave. AM waves are divided into ordinary AM waves, double-sideband AM waves with suppressed carrier transmission and single-sideband AM waves with suppressed carrier transmission.

1. The formula to express the modulated waveform is as follows:

Assuming that the modulating signal is a sine wave of a single frequency ( $\Omega=2\pi f_{\Omega}$ )

And

$$u_{\Omega}(t) = U_{\Omega m} \cos \Omega t = U_{\Omega m} \cos 2\pi f_{\Omega} t \quad (5.1)$$

then the carrier signal is

$$u_c(t) = U_{cm} \cos \omega_c t = U_{cm} \cos 2\pi f_c t \quad (5.2)$$

Because the carrier frequency remains unchanged after amplitude modulation and the amplitude of an AM wave is proportional to the modulating signal, therefore, the modulated wave can be expressed as below:

$$u_{AM}(t) = U_{AM}(t) \cos \omega_c t = U_{cm}(1+m_a \cos \Omega t) \cos \omega_c t \quad (5.3)$$

To simplify the analysis, we set the initial phase angle of both waveforms to zero. In formula (5.3),  $m_a$  is known as the degree of AM modulation or the AM modulation index.

$$\text{Namely, } m_a = \frac{k_a U_{\Omega m}}{U_{cm}}$$

This equation indicates to what degree the carrier amplitude is controlled by the modulating signal. The constant  $k_a$  is a proportional constant determined by the modulation circuit. The AM modulation index should be less than or equal to 1. When the AM modulation index is greater than 1, it is called over modulation and will distort the modulated signal.

We can see from this that the AM wave also oscillates at a high frequency. Its amplitude varies regularly (envelope changes) and is proportional to the modulating signal. Therefore, the information in a modulating signal is carried in the amplitude of an amplitude modulated wave. The following figure shows how a signal changes from a carrier signal

(unmodulated state) to an AM wave (modulated state).

Figure 5-1. A diagram showing how an unmodulated carrier signal undergoes the process of modulation.

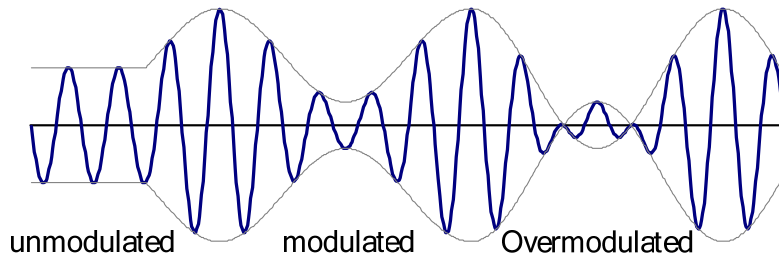
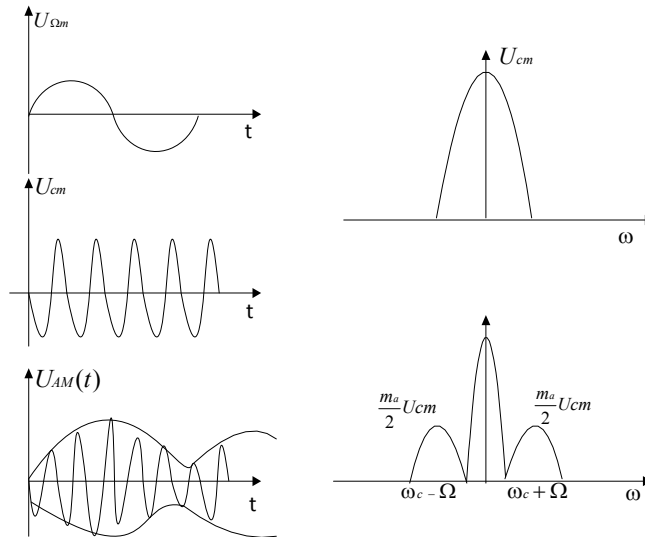

Figure 5-2. AM waveform in the time domain and the frequency domain



## 2. AM Wave Spectrum

Expand formula (4.3) to get the following formula:

$$u_{AM}(t) = U_{cm} \cos \omega_c t + \frac{1}{2} m_a U_{cm} \cos(\omega_c + \Omega)t + \frac{1}{2} m_a U_{cm} \cos(\omega_c - \Omega)t$$

As can be seen here, a single modulated audio signal consists of three high frequency components. In addition to the carrier, two new frequency components ( $\omega_c + \Omega$ ) and ( $\omega_c - \Omega$ ) are included. One is higher than  $\omega_c$ , known as the upper sideband, and the other is lower than  $\omega_c$ , known as the lower sideband. Its spectrum is shown in Figure 5-3.



Figure 5-3.  
Spectrum of an  
AM wave

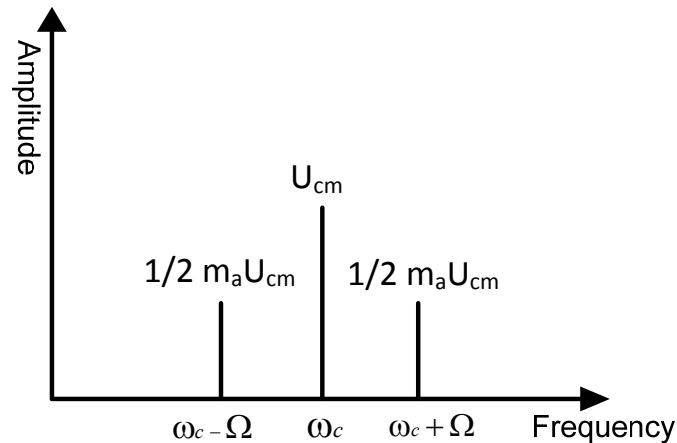

From the above analysis, we can understand that amplitude modulation is a process of shifting a low frequency modulating signal into the sideband of a high frequency carrier. Obviously, in AM waves, the carrier does not contain any useful information. Information is only included in the sidebands.

#### Experiment contents

1. Measure the waveform and spectrum of an AM wave.
2. Measure the spectrum of the AM wave with different carrier frequencies and with modulating signals with different amplitudes.

#### Experiment steps

1. Turn on the power to the GRF-1300A and GSP-730.
2. Set the GRF-1300A as follows:
  - Set the GRF-1300A to the default power-on state.
  - Connect the output port on the Baseband module to the AM in port on the AM module with an RF cable.
  - Connect the RF/FM output port on the RF Synthesizer/FM to the RF in port on the AM module with an RF cable.
  - Turn the potentiometer clockwise to the end.
3. Connect the AM output port to the input port of the spectrum analyzer with the 800mm RF cable.



4. Set up the GSP-730 as follows:

- Center frequency: 880MHz
- Span: 5MHz
- Reference level: 0dBm
- RBW: Auto

Step1 **Frequency** (F1) 8 8 0 (MHz/mSec) **Center 880MHz**

Step2 **Span** (5) (MHz/mSec) (MHz/mSec) **Span 5.0MHz**

Step3 **Amplitude** (F1) 0 (GHz/Sec) **Ref. Level 0.0dBm**

Step4 **BW** (F1) **RBW Auto Man**

5. Use the Marker function to measure the carrier component of the AM wave on the spectrum analyzer and the power of the upper and lower sidebands. Use the oscilloscope to measure the voltage at TP4 in relation to the position of the potentiometer (i.e., the modulating amplitude). Draw the spectrum diagram in Table 5-4.

Step5 **Peak Search**

Step6 **Marker** (F3) **Mode Normal Delta** (1) (0) (0) (kHz/uSec)

6. Turn the potentiometer counterclockwise to the half-way mark. Measure the voltage with the oscilloscope. By changing the output amplitude of the modulating signal, can you observe any change in the spectrum? Record the experiment in Table 5-4.

7. Turn the potentiometer counterclockwise to decrease the output voltage. Measure the voltage with the oscilloscope. Observe any changes in the spectrum of the AM wave and record it in Table 5-4.

8. Turn the potentiometer clockwise to the maximum. Adjust the UP button on the Baseband module to adjust the frequency of modulating signal. Do you see any change in the AM wave spectrum? Compare the experiment results with that of the original baseband frequency of 100kHz and record it to Table 5-5.

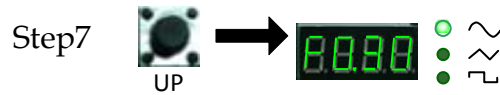

9. Use the UP button on the Baseband module to adjust the frequency of the modulating signal. Do you see any change in the AM wave spectrum? Record the result in Table 5-5.



10. After completing the experiment steps above, press the Reset button, and then use the UP button on the RF Synthesizer/FM module to change the frequency of the carrier signal. Is there is any change in the AM wave spectrum? Compare the experiment result with that of the original carrier frequency of 880MHz and record it to Table 5-6.



11. Use the DOWN button on the RF Synthesizer/FM module to change the frequency of the carrier signal. See if there is any change to the AM wave spectrum and record it Table 5-6.



**Experiment results**      1. Changing modulating voltage

Table 5-4.  
Experiment results:  
Changing the modulating voltage

Modulating voltage	Experiment results
--------------------	--------------------

Vpp:

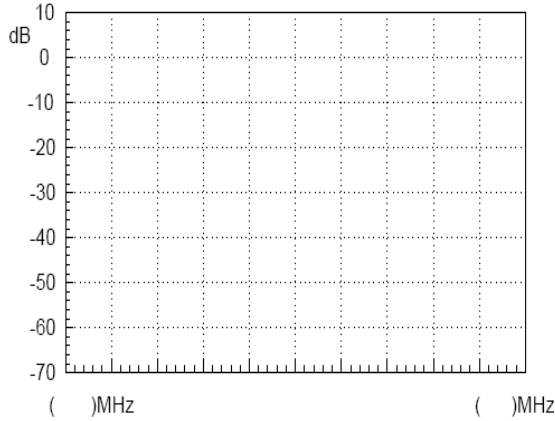

Carrier power: \_\_\_\_\_  
 Modulation index: : \_\_\_\_\_ Lower sideband power: : \_\_\_\_\_

Vpp:

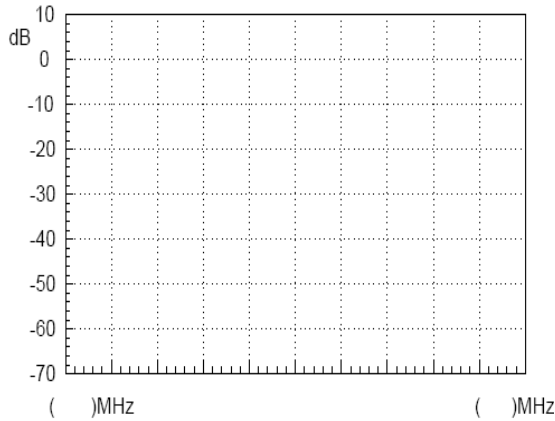

Carrier power: : \_\_\_\_\_  
 Modulation index: : \_\_\_\_\_ Lower sideband power: : \_\_\_\_\_

Vpp:

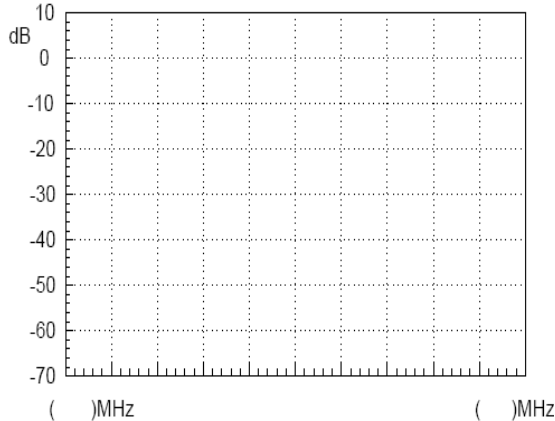

Carrier power: : \_\_\_\_\_  
 Modulation index: : \_\_\_\_\_ Lower sideband  
 power: : \_\_\_\_\_

Conclusion:

2. Changing the modulating signal frequency.

Table 5-5.  
 Experiment  
 results:  
 Changing the  
 modulating  
 signal frequency.

Modulating frequency	Experiment results
----------------------	--------------------

100kHz

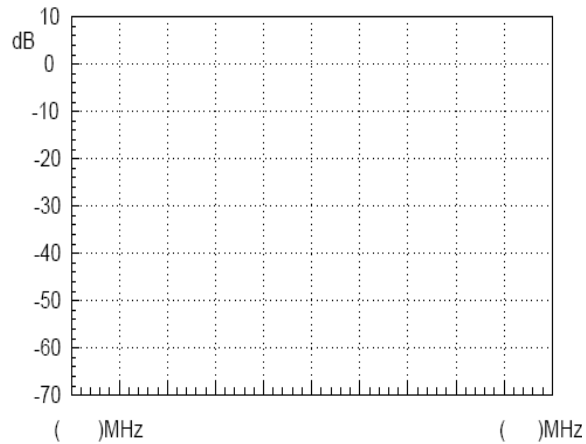

Carrier power: : \_\_\_\_\_  
 Lower sideband power: : \_\_\_\_\_

300Khz

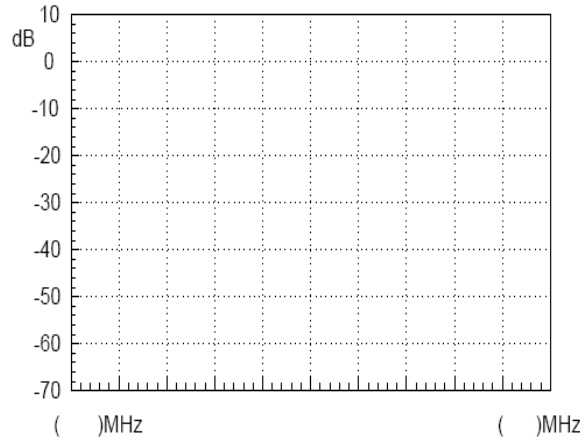

Carrier power: : \_\_\_\_\_  
 Lower sideband power: : \_\_\_\_\_

600kHz

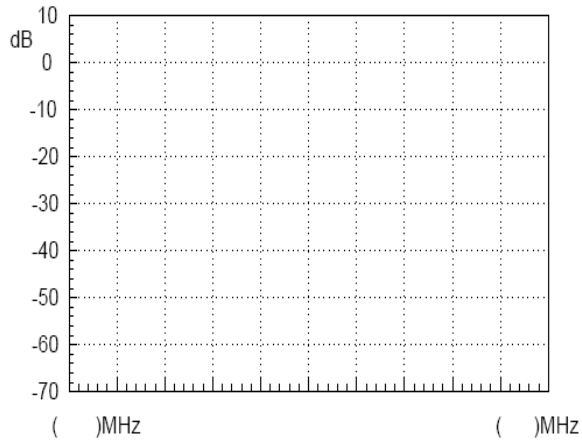

Carrier power: : \_\_\_\_\_

Lower sideband power: : \_\_\_\_\_

Conclusion:

3. Changing the carrier frequency.

Carrier Frequency	Experiment results
-------------------	--------------------

Table 5-6.  
Experiment results:  
Changing the carrier frequency.

882MHz

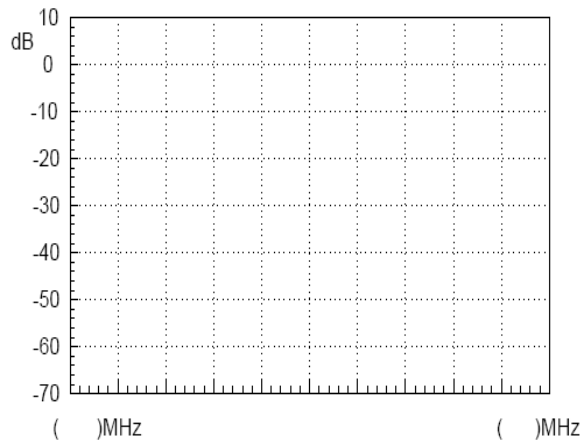

880MHz

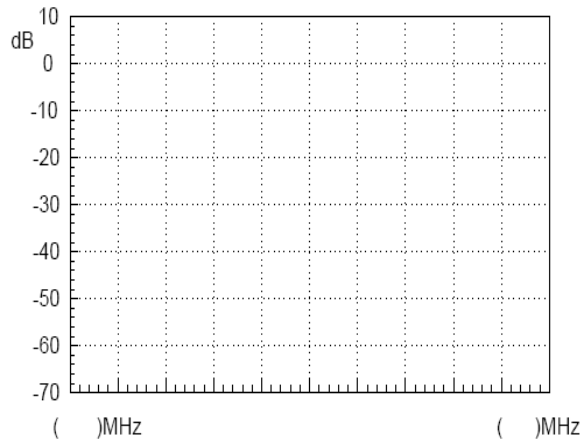

878MHz

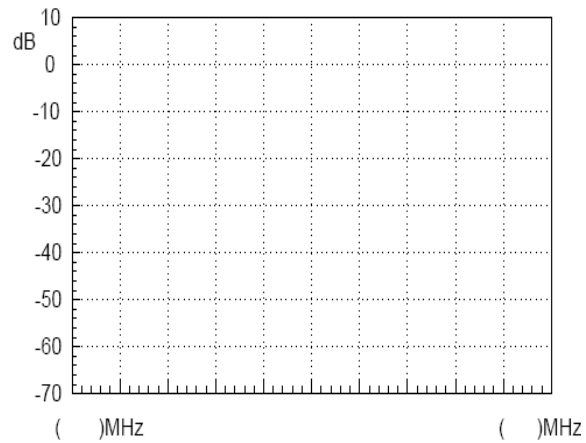

Conclusion:

**Questions**

1. If we change the frequency of the modulating wave but keep the amplitude the same, will the AM wave be affected?
2. If the input cables on the AM modules were switched (Connect the baseband signal to the "RF in" terminal and connect the carrier signal to the "AM in" terminal.) what will happen and why?

## Experiment 6: FM signal measurement

**Relevant information** Since frequency modulation is a common type of modulation, it is important to learn the principles and characteristics of FM waves. Compared to AM waves, the amplitude of an FM wave doesn't carry the modulating signal information. This allows an amplitude limiter to be used to eliminate the magnitude interference before demodulation. The noise power spectral density in an FM wave band is evenly distributed at the input terminal. But due to frequency modulation, it is affected by frequency at the output terminal. Because the bandwidth of a modulated signal is far less than the FM wave bandwidth, it can pass through a low-pass filter to attenuate noise and increase the output signal to noise ratio during demodulation. FM waveforms are advantageous as they utilize power efficiently and have a high degree of fidelity as they rely on the phase of the modulated signal and not the amplitude to carry the baseband signal. The FM circuit in this experiment uses a phase-locked loop. The phase-locked loop circuit principles described earlier can be used to study the application of a phase-locked loop circuit for this section.

	Item	Equipment	Quantity	Note
<b>Experiment equipment</b>	1	Spectrum analyzer	1	GSP-730
	2	RF & Communication Trainer	1	GRF-1300A
	3	RF wire	2	100mm
	4	RF wire	1	800mm
	5	Adapter	1	N-SMA

- Experiment goals**
1. Understand the working principals of frequency modulation.
  2. Use a spectrum analyzer to measure the FM characteristics of an FM wave.
  3. Master phase-locked loop principals that are used in FM.

**Experiment principles**

1. Time domain analysis.  
Frequency modulation is a type of modulation in which the instantaneous frequency deviation of the modulated signal with respect to the frequency of the carrier signal is directly proportional to the instantaneous amplitude of the modulating signal.

Assume that the modulating signal is

$$u_{\Omega}(t) = U_{\Omega m} \cos \Omega t$$



And the carrier signal is

$$u_c(t) = U_{cm} \cos \omega_c t = U_{cm} \cos 2\pi f_c t$$

An FM signal varying to changes in the modulating signal is shown in Figure 6-1.

Figure 6-1.  
An FM signal  
varying to the  
change of a  
modulating  
signal

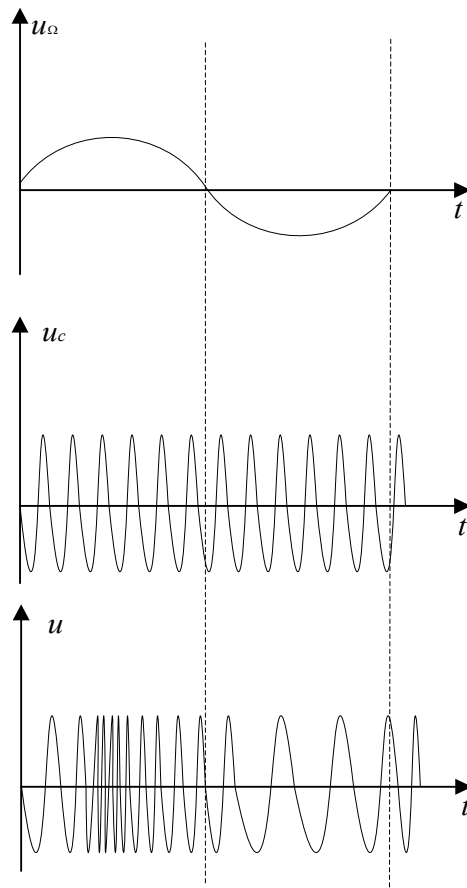

In the positive half-period of the modulating signal, the frequency of the modulated signal is higher than the frequency of the carrier signal. At the peak of the positive half-period, the angular frequency of the modulated signal is at its peak.

In the negative half-period of the modulating signal, the frequency of the modulated signal is lower than the frequency of the carrier signal, and its angular frequency is at its lowest. The angular frequency  $\omega$  of an FM wave changes in response to changes in the modulation signal.

$$\text{Then } \omega = \omega_c + \Delta\omega \cos \Omega t$$

In this formula,  $\omega_c$  is the angular frequency of the carrier wave,  $\Delta\omega$

is the offset of the angular frequency determined by the modulating signal  $U_{\Omega}$

The general expression for the FM signal:

$$\begin{aligned}
 u(t) &= U_{cm} \cos[\omega_c t + k_f \int_0^t u_{\Omega}(t) dt + \varphi_0] \\
 &= U_{cm} \cos[\omega_c t + k_f \int_0^t U_{\Omega m} \cos \Omega t dt + \varphi_0] \\
 &= U_{cm} \cos[\omega_c t + \frac{k_f U_{\Omega m}}{\Omega} \sin(\Omega t) + \varphi_0]
 \end{aligned}$$

Assume that,  $M_f = \frac{k_f U_{\Omega m}}{\Omega} = \frac{\Delta \omega_m}{\Omega}$

In this formula,  $M_f$  is called the FM index,  $\Delta \omega_m$  is called the maximum angular frequency deviation, its value is proportional to the amplitude of the modulating signal.

2. Frequency domain analysis

Expressed by the time domain FM wave

$$\begin{aligned}
 u(t) &= U_{cm} \cos[\omega_c t + \frac{k_f U_{\Omega m}}{\Omega} \sin(\Omega t) + \varphi_0] \\
 &= U_{cm} \cos[\omega_c t + m_f \sin(\Omega t) + \varphi_0]
 \end{aligned}$$

Let the initial phase angle be 0 and expand as follows:

$$u(t) = U_{cm} [\cos \omega_c t \cos(m_f \sin \Omega t) + \sin \omega_c t \sin(m_f \sin \Omega t)]$$

When  $m_f \ll 1$ ,  $\cos(m_f \sin \Omega t) \approx 1$

$$\sin(m_f \sin \Omega t) \approx (m_f \sin \Omega t)$$

Then we get,

$$\begin{aligned}
 u(t) &= U_{cm} \cos \omega_c t + m_f U_{cm} \sin \omega_c t \sin \Omega t \\
 &= U_{cm} \cos \omega_c t + \frac{m_f U_{cm}}{2} \cos(\omega_c + \Omega)t + \frac{m_f U_{cm}}{2} \cos(\omega_c - \Omega)t
 \end{aligned}$$

We can see when  $m_f \ll 1$ , the FM wave spectrum is composed of the carrier,  $(\omega_c + \Omega)$  frequency component and  $(\omega_c - \Omega)$  frequency component.

When  $m_f \gg 1$

$$\begin{aligned}
 \cos(m_f \sin \Omega t) &= J_0(m_f) + 2J_2(m_f) \cos 2\Omega t + 2J_4(m_f) \cos 4\Omega t + \dots \\
 \sin(m_f \sin \Omega t) &= 2J_1(m_f) \sin \Omega t + 2J_3(m_f) \cos 3\Omega t + 2J_5(m_f) \sin 5\Omega t + \dots
 \end{aligned}$$

In this formula,  $J_n(m_f)$  is called an n-order Bessel function of the first kind.

There are an infinite number of frequency components in FM waves, and they are distributed symmetrically around the center of

carrier frequency. The amplitude of each component depends on the Bessel functions.

Theoretically, FM bandwidth is infinite, but the energy of an FM signal is mainly concentrated near the carrier frequency. The sidebands of the FM signal only contain a small amplitude component and are generally ignored in practice by engineers. Provided that the amplitude at the sidebands is negligible, less than 10%, we can get the FM wave band as follows:

$$B=2(m_f+1)F$$

From above analysis

Because 
$$m_f = \frac{\Delta\omega_m}{\Omega} = \frac{\Delta F}{F}$$

Therefore 
$$B=2(\Delta F + F)$$

When  $\Delta F \gg F$ , it is wide band modulation,  
 $m_f \gg 1, B \approx 2\Delta F$

When  $\Delta F \ll F$ , it is narrow band modulation,  
 $m_f \ll 1, B \approx 2F$

The amplitude of the sideband components in an FM signal is related to the frequency modulation index. This can be seen in the comparison table in the appendix. Below we have a few examples of the absolute magnitudes of the sidebands for signals with a modulation index of 0.5, 2.41 and 5.

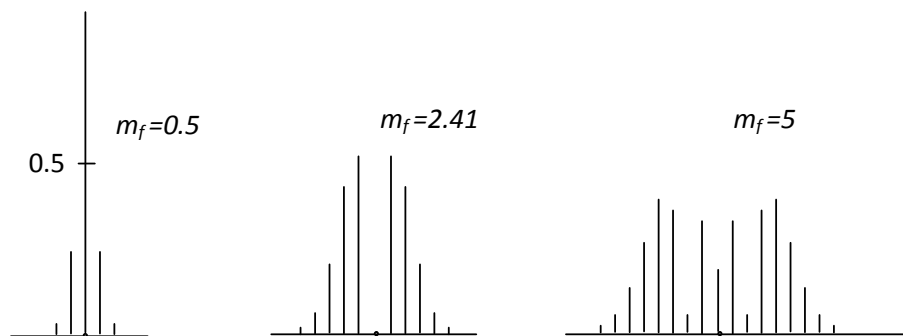

The FM circuit in the GRF-1300A uses a phase-locked loop. Using a PLL circuit for FM modulation not only solves the center frequency stability problems in direct FM modulation but also the narrow FM range limitations when using a crystal oscillator.

The spectrum of the modulating signal must be outside the of

low-pass filter passband to achieve a phase-locked FM wave.

When the center frequency of the VCO is locked on to a stable high frequency, it allows the VCO to shift in frequency when the modulating signal is varied.

Figure 6-2.  
GRF-1300A  
FM principle

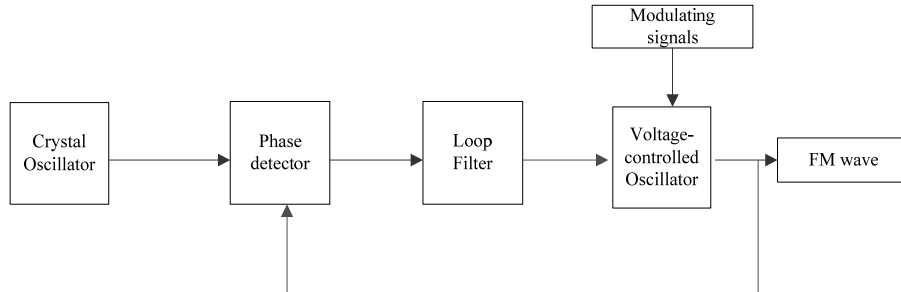

Experiment contents

1. Measure the FM wave spectrum.
2. Observe how the amplitude of the modulating signal affects the FM wave frequency deviation.
3. Observe how the frequency of the modulating signal affects the FM wave frequency deviation.

Experiment steps

1. Turn on the GRF-1300A and GSP-730.
2. Set the GRF-1300A as follows:
  - Under the default state (the state from power-up), turn the potentiometer to the minimum position.
  - Connect the output port on the Baseband module to the FM in port on the RF Synthesizer/FM module with an RF cable.
  - Connect the RF/FM output port to the RF input port on the spectrum analyzer with an RF cable.



3. Set the GSP-730 as follows:
  - Center frequency: 880MHz
  - Span: 50MHz
  - Reference level: 0dBm
  - RBW: Auto

Step1 F1 8 8 0 MHz/mSec

Step2 F1 5 0 MHz/mSec

Step3 F1 0 GHz/Sec

Step4 F1 F4

4. Use the Marker function on the spectrum analyzer and measure the carrier position at this time.

Step5

5. Turn the potentiometer clockwise to an arbitrary position. Measure the voltage with an oscilloscope. Does the FM wave spectrum change after the output amplitude of the modulating signal has changed? Follow the steps below to measure the frequency deviation and record it in Table 6-2.

Step6 F3

6. Turn the potentiometer clockwise again to a different position. Measure the voltage with an oscilloscope. Does the spectrum of the FM wave change when the output amplitude of modulating signal changes? Follow the steps below to measure the frequency deviation and record it in Table 6-2.

Step7

7. Adjust the potentiometer to the maximum position. Repeat the above steps and record the results in Table 6-2.

Step8

8. After the completing the experiment steps above, see if there is any change to the spectrum of the FM wave when the UP button on the baseband module is used to change the frequency of the modulating signal. Compare this to the original 100kHz baseband signal and record it to Table 6-3.

Step9

9. Change the modulating signal frequency to 600KHz. Observe the change in the spectrum of the FM wave and record the results in Table 6-3.

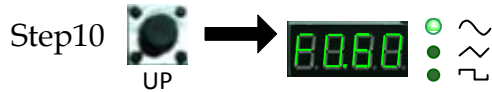

10. Change the modulating signal frequency to 1MHz. Observe the change in the spectrum of the FM wave and record the results in Table 6-3.



11. After completing the experiment steps above, press the Reset button, and minimize the amplitude of the modulating signal in order to view the FM spectrum within a span of 50MHz. Then use the DOWN button on the RF Synthesizer/FM module to change the frequency of the carrier signal. See if there is any change in FM wave spectrum. Compare this result to the original carrier frequency of 880MHz and record it in Table 6-4.



12. Adjust the carrier frequency again. See if there is any change on FM wave spectrum and record it to Table 6-4.

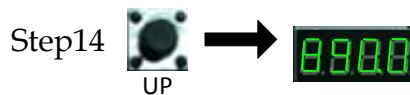

**Experiment results** 1. Changing the amplitude of the modulating signal.

Table 6-2.  
Experimental  
Results:  
Changing the  
amplitude of  
the modulating  
signal

Modulating voltage Experiment result

V<sub>pp</sub>:

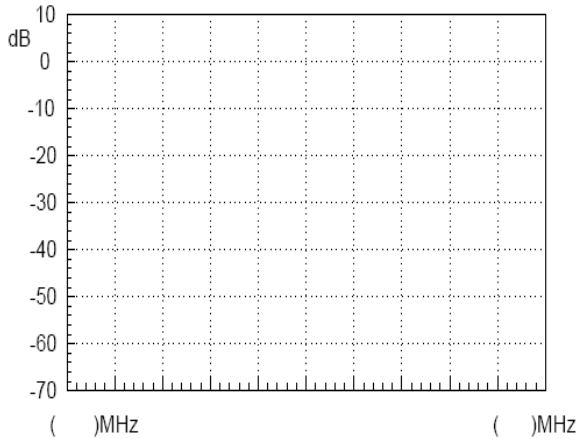

Frequency deviation:

FM index:

V<sub>pp</sub>:

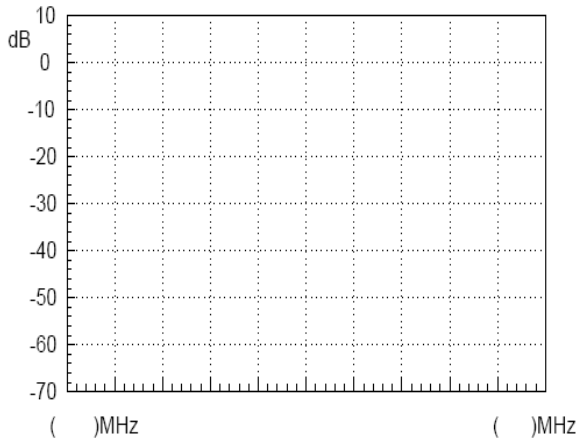

Frequency deviation:

FM index:

V<sub>pp</sub>:

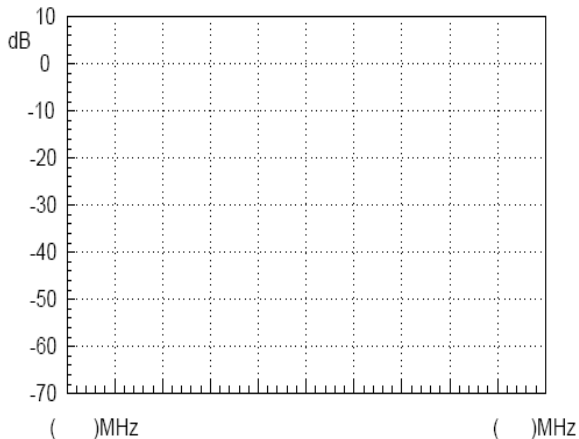

Frequency deviation:

FM index:

Conclusion

2. Changing the frequency of an FM signal.

Table 6-3.  
Experimental results:  
Changing the frequency of the FM signal

Modulating frequency	Experimental result
100Khz	
300Khz	
600kHz	



1MHz

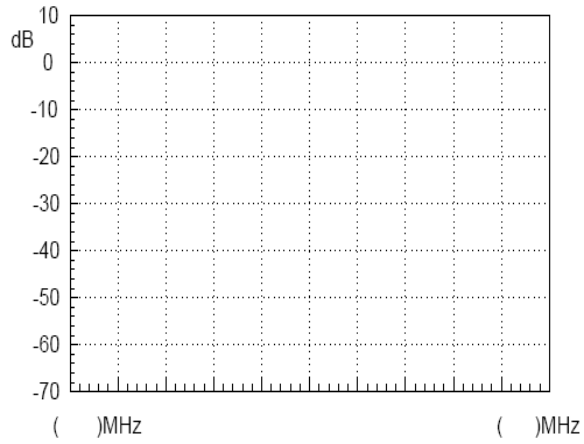

Conclusion

### 3. Changing the carrier frequency

Table 6-4.  
Experimental results:  
Changing the carrier frequency

Carrier frequency	Experimental result
-------------------	---------------------

875MHz

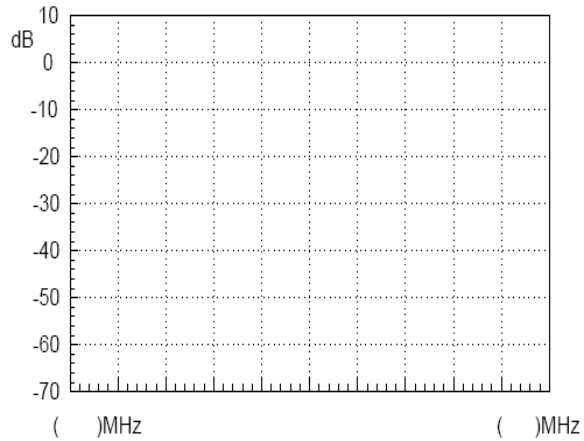

880MHz

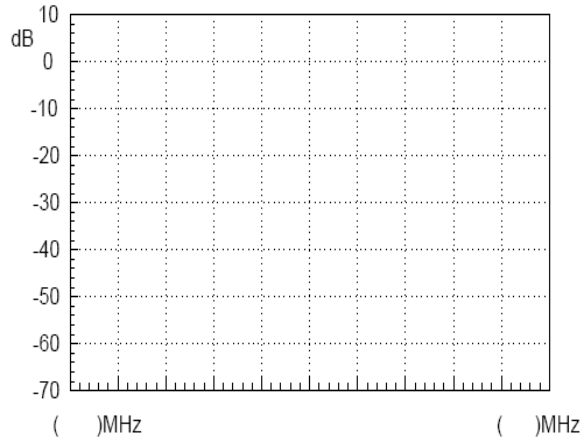

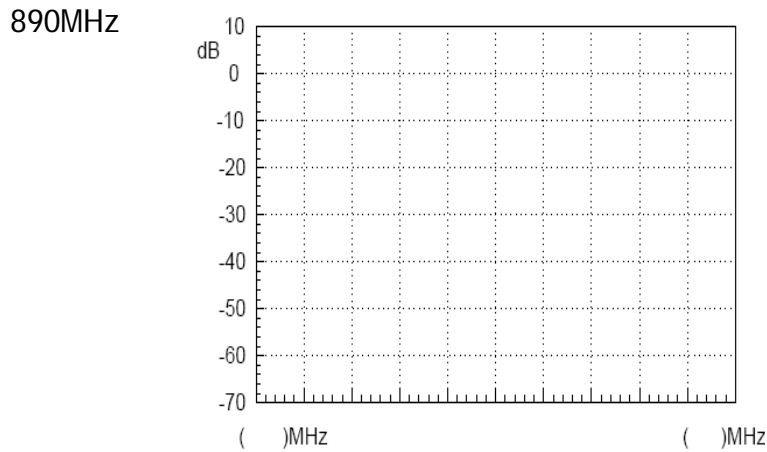

**Conclusion**

4. Draw a table to record the time domain waveform of the AM wave that is measured by the oscilloscope.

**Question**

1. For FM waves, if we keep the modulation signal amplitude constant and double the modulation signal frequency, how will the frequency deviation and bandwidth change in the modulated signal?
2. Calculate the FM index of the modulation circuit through the measured data obtained from the spectrum analyzer.

## Experiment 7: Using a Spectrum Analyzer in Communication Systems

**Relevant information**

ACPR and OCBW are important parameters in the measurement of RF modulated signals. It is very important to master using a spectrum analyzer to measure ACPR and OCBW. We must know how to utilize a spectrum analyzer to measure the RF parameters that are frequently used and to lay the foundation for future use. ACPR is the ratio of the amount of power leaked to an adjacent channel from the main channel. OCBW is the occupied bandwidth that contains a specific percentage of the total integrated power of the channel. At present, third generation mobile communication systems (3G) are becoming ubiquitous, while some countries and companies are looking to develop fourth generation mobile communication systems (4G). This experiment, therefore, has a high practical value for the measurement of CDMA RF power and related fields.

	Item	Equipment	Quantity	Note
<b>Experiment equipment</b>	1	Spectrum analyzer	1	GSP-730
	2	RF & Communication Trainer	1	GRF-1300A
	3	RF wire	2	100mm
	4	RF wire	1	800mm
	5	Adapter	1	N-SMA

**Experiment goal**

1. To understand ACPR measurement principles and to perform actual ACPR measurements.
2. Understand OCBW measurement principles and to perform actual OCBW measurements.

**Experiment principles**

1. ACPR Measurement

ACPR (Adjacent Channel Power Ratio) is the ratio of the amount of power leaked to an adjacent channel from the main channel. It represents how much power from the transmitter leaks into the transmission band of other channels. The adjacent channel usually refers to the closest adjacent channels near the transmission channel, other channels can also be selected, depending on the measurement requirements.

When two signals with similar frequencies are input into an RF power amplifier, there are not only two output signals, but also the inter-modulation signals (input signal 1  $\pm$  input signal 2). A typical input and output frequency spectrum is shown in Figure 7-1.

Figure 7-1. RF power amplifier input and output

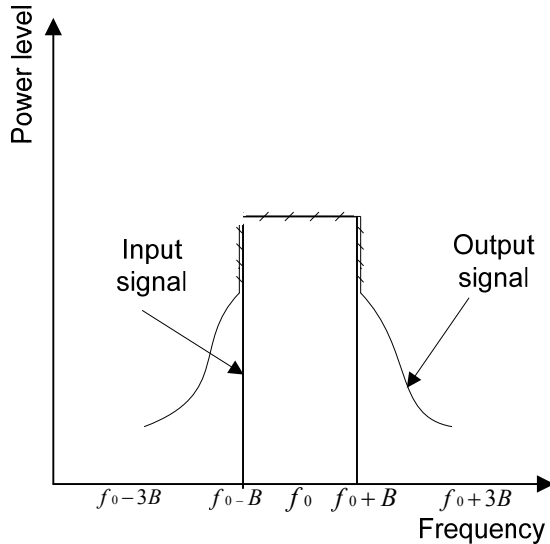
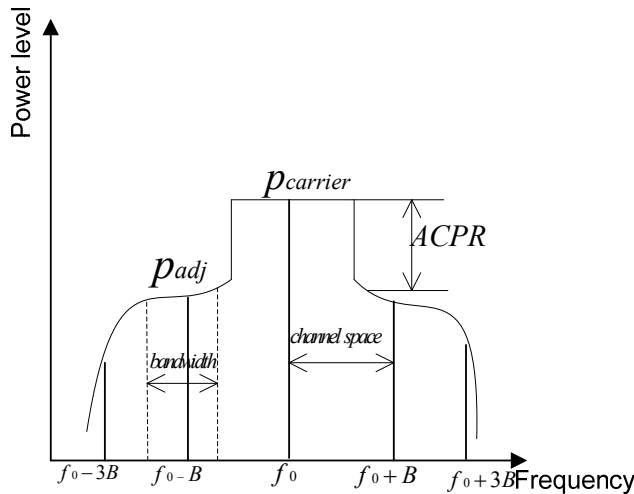

Figure 7-2. Definition of ACPR



In accordance with the definition of ACPR (Figure 7-2), we know that  $ACPR = 10 \log (P_{adj} / P_{carrier})$ .

When using a spectrum analyzer to measure ACPR, first you need to select the appropriate settings for the span and the resolution bandwidth (RBW). The span needs to be greater than the measurement bandwidth. The RBW should be equal to approximately 1% of the measurement bandwidth. Because the sweep time of the spectrum analyzer is inversely proportional to the square of the RBW, the RBW settings should be considered.

The RBW should not more than 4% of the measured channel bandwidth. Otherwise, the RBW will too wide and will obscure the original spectrum of channel. The RBW settings on the GSP-730 have a number of set ranges, therefore it fine to set the RBW to Auto mode.

## 2. OCBW-measurement

OCBW measurement is for measuring the bandwidth that the channel occupies for a specified amount of power. This is used to measure the occupied bandwidth as a percentage of the channel power for a specified amount of power. Commonly used parameters for the measurements are: channel bandwidth, channel spacing and OCBW %.

---

### Experiment contents

1. Measure the ACPR from the FM signal produced by the GRF-1300A.
  2. Measure the OCBW from the FM signal produced by the GRF-1300A.
- 

### Experiment steps

1. Turn on the GRF-1300A and GSP-730.
2. Set up the GRF-1300A as follows:
  - Set the GRF to the power-on default state.
  - Use the RF wire to connect the baseband output to the FM in port on the RF synthesizer/FM module.
  - Connect the output terminal on the RF/FM module to the input terminal on the spectrum analyzer with the RF cable.



3. Set up the GSP-730 as follows:

- Center frequency: 880MHz
- Span: 10MHz
- Reference level: -10dBm
- RBW: Auto

Step1 **Frequency** (F1) 8 8 0 (MHz/mSec) **Center 880.0MHz**

Step2 **Span** (F1) 1 0 (MHz/mSec) **Span 10.0MHz**

Step3 **Amplitude** (F1) - 1 0 (GHz/Sec) **Ref. Level -10.0dBm**

Step4 **BW** (F1) **RBW Auto Man**

4. Adjust the FM frequency deviation to 1MHz (2MHz in total) with the amplitude knob.

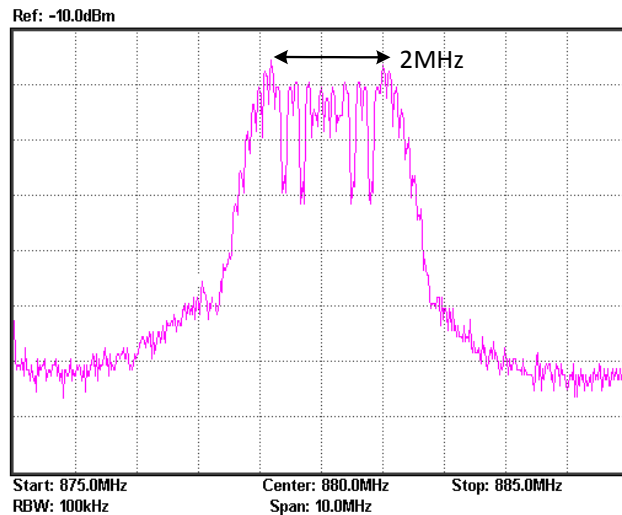

5. Measure the ACPR and OCBW after these settings are performed.

ACPR measurement

Step1 **Meas** (F2) **ACPR ON OFF**

Step2 (F1) **Main CH BW**

Set the bandwidth of the main channel to 2MHz.

Step3  Set the main channel space to 5MHz.

Step4   Set the bandwidth of the 1<sup>st</sup> adjacent channel 0.8MHz.

Step5  Set the offset of the 1<sup>st</sup> adjacent channel to 2MHz.

Step6  Set the bandwidth of the 2<sup>nd</sup> adjacent channel to 0.5MHz.

Step7  Set the offset of the 2<sup>nd</sup> adjacent channel to 4MHz.

Increase the frequency deviation to 2MHz (4MHz in total) using the amplitude knob. Measure the ACPR again and record the results to table 7-1.

OCBW measurement

Step1  

Step2  Set the bandwidth of the channel that you will measure to 2MHz.

Step3  Set the span of the main channel space to 10MHz.

Step4 The OCBW is default at 90%.

Record the measurement data in Table 7-2

Step5 Adjust the frequency deviation of FM wave by adjusting the potentiometer of GRF-1300A. Measure the OCBW again and record the results to table 7-2.

Record the measurement data in Table 7-2

**Experiment results** 1. ACPR measurement results

1MHz frequency deviation results

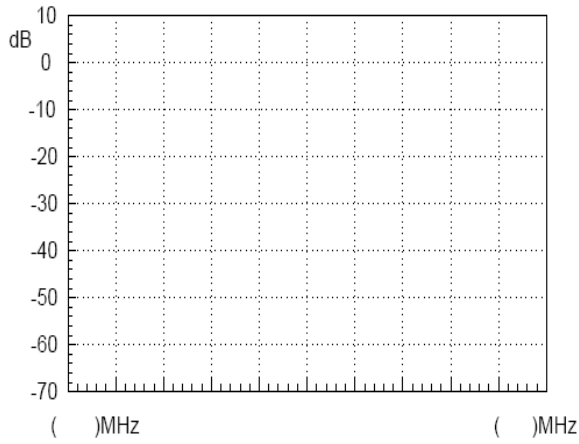

2MHz frequency deviation results

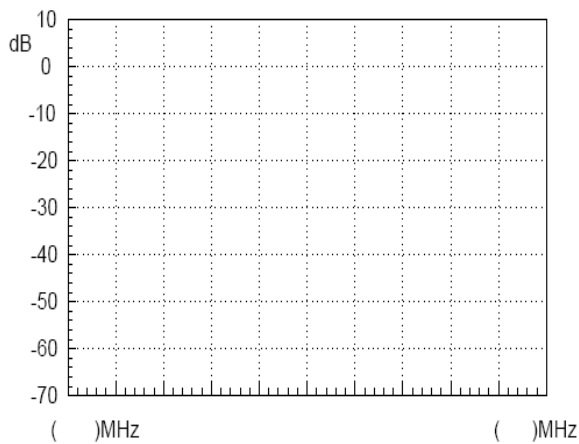

Table 7-1. ACPR measurement results

Test No.	Item			
	Lower ACPR1	Upper ACPR1	Lower ACPR2	Upper ACPR2
1				
2				
3				
4				
Average				

2. OCBW measurement results



1MHz frequency deviation results

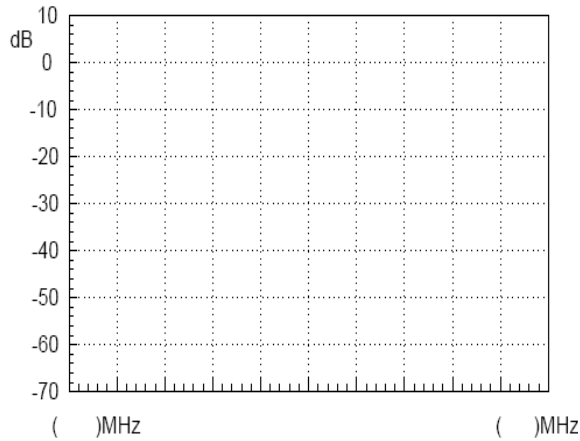

2MHz frequency deviation results

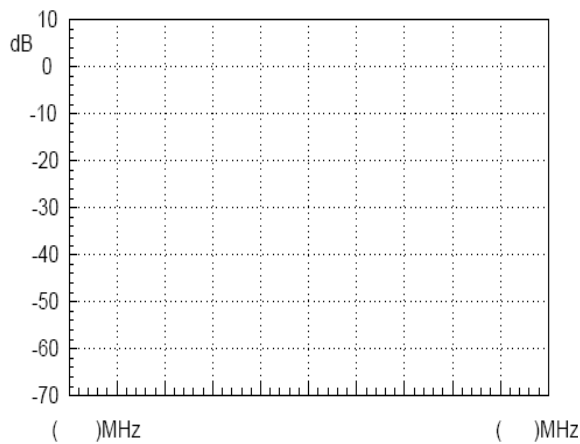

Table 7-2. OCBW measurement results

OCBW% : _____			
Test No.	CH Power	OCBW	Average
1			
2			
3			
4			
5			

**Questions** Describe the definition for ACPR?

**Caution** Taking multiple measurements and the getting average value is required for ACPR and OCBW measurements. Using the Average function cannot be used as it uses a logarithmic method to calculate the average.

## Experiment 8: Measurement of communication products

**Relevant information**

The computer mouse has experienced nearly four decades of evolution and development since its inception in 1968. With the popularity of consumer oriented computers over the past decade, the mouse has seen tremendous progress. From the early mechanical wheel mouse to the current mainstream optical mouse or the high-end laser mouse, each evolution of the mouse has been more enjoyable to use each time. In addition, the demand for better work environments has made the wireless mouse very popular. Wireless technology, depending on the frequency band and its purpose, is divided into different categories such as Bluetooth, Wi-Fi (IEEE 802.11), Infrared (IrDA), ZigBee (IEEE 802.15.4) and so on. But for the current mainstream wireless mouse, there are three different categories: 27Mhz, 2.4G and Bluetooth.

This experiment actually performs measurements on actual communication products (a wireless mouse in this case). After performing this experiment you should have a good understanding of the spectrum analyzer and the measurement methods used. This experiment will help to consolidate your RF knowledge and to strengthen your practical spectrum analyzer skills.

	Item	Equipment	Quantity	Note
<b>Experiment equipment</b>	1	Spectrum analyzer	1	GSP-730
	2	2.4G wireless mouse	1	
	3	Antenna	1	
	4	Adapter	1	N-SMA

**Experiment goals**

1. Use the spectrum analyzer to measure some parameters from common every-day electronic communication products.
2. Learn how a wireless mouse works.

**Experiment principles**

In this experiment we will use a 2.4G wireless mouse. It uses the so-called 2.4G frequency band. The advantage of the 2.4G band over the 27MHz band is that the 27MHz band has a shorter transmission distance and is prone to interference from other devices. We call it 2.4G because it operates in the 2.4GHz frequency band. In most countries, this frequency band is license-free.

The principle of the wireless mouse is actually very simple. It mainly uses digital radio technology to provide adequate bandwidth for communications equipment over a short distance. It is ideal for peripheral equipment such as mice and keyboards. The working principles behind a wireless mouse and that of a traditional mouse are the same. The only difference is that the X & Y position, as well each button press is transmitted wirelessly via a transmitter. The wireless receiver then passes this information to the host after decoding the signal. The driver then tells the operating system to convert the signal to mouse actions.

**Experiment contents**

Measure the frequency and power of the signal that is transmitted from a wireless mouse.

**Experiment steps**

1. Connect the antenna to the input port of the spectrum analyzer.

2. Set up the GSP-730 as follows:

- Center frequency: 2.4GHz
- Span: 200MHz
- Reference level: -20dBm
- RBW: Auto

Step1 **Frequency** (F1) 2 . 4 (GHz/Sec) **Center 2.4GHz**

Step2 **Span** (F1) 2 0 0 (MHz/mSec) **Span 200.0MHz**

Step3 **Amplitude** (F1) - 2 0 (GHz/Sec) **Ref. Level -20.0dBm**

Step4 **BW** (F1) **RBW Auto Man**

3. Turn the wireless mouse on.

Step5 **Trace** (F3) **Peak Hold**

Step6 **Peak Search**

4. A connection diagram is shown below.

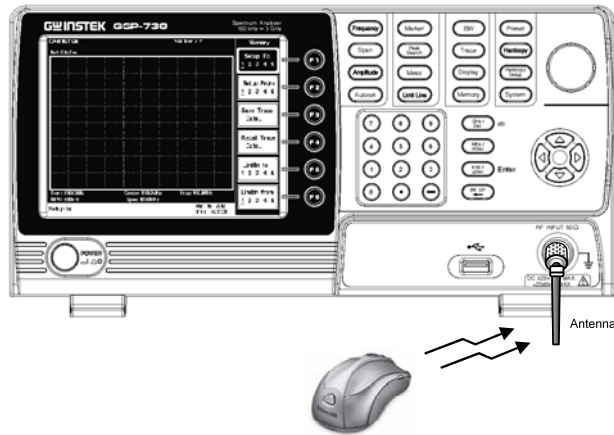

5. A blue tooth device or wireless network card can also be used in the same way to create a signal to measure.

**Experiment results**

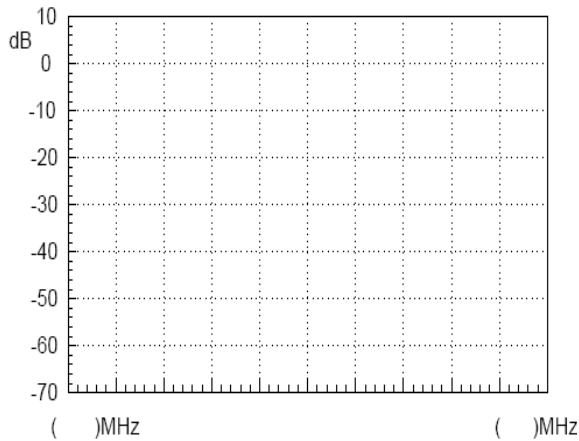

Transmitting frequency: \_\_\_\_\_

Transmitted signal power: \_\_\_\_\_

**Question** What are the advantages for a wireless mouse to operate in the 2.4 G bandwidth?

**Caution** Use the Peak Hold function on the spectrum analyzer to capture the signal emitted from the wireless mouse. It is not easy to dynamically measure the signal.

## Experiment 9: Production Line Applications

**Relevant information** A spectrum analyzer can be used in Pass/Fail testing of RF communication products. Testing can be done either manually with a stand-alone instrument or via remote control using a PC. When using remote control, the spectrum analyzer parameter settings and test results can be returned remotely. This saves a lot of time and can improve the efficiency of a production line. In this experiment, we will imagine that the GRF-1300A is in a production line environment. We will use the limit line function to perform a simple test to see if a product has passed the test and return the test results using remote commands.

Experiment equipment	Item	Equipment	Quantity	Note
	1	Spectrum analyzer	1	GSP-730
	2	RF & Communication Trainer	1	GRF-1300A
	3	RF wire	1	800mm/100mm
	4	Adapter	1	N-SMA

**Experiment goals**

1. Learn how to edit the pass/fail limit lines and understand how to perform pass/fail testing.
2. Use remote commands to read back test data from the spectrum analyzer.

**Experiment principles**

1. Limit line editing and Pass/Fail testing.  
The upper and lower limit lines apply throughout the entire frequency span. The limit lines can be used to detect if the signal amplitude is above or below a set amplitude level. The judgment of the pass/fail test is shown on the bottom of the screen.

To create a limit line, edit the ten points in the lower Limit Line Editing Table, shown below.

No.	MHz	dBm	No.	MHz	dBm
1	0.0	0.0	6	60.0	0.0
2	20.0	0.0	7	70.0	0.0
3	30.0	0.0	8	80.0	0.0
4	40.0	0.0	9	90.0	0.0
5	50.0	0.0	10	100.0	0.0

Set the amplitude and frequency of each point. Use the arrow keys to move the cursor to each of the different points. Use the same method is used to edit both the upper and lower limit lines. Pass/Fail testing can be started after setting the limit lines.

2. Use the remote commands to read back test results.

Manually setting the spectrum analyzer for testing can be time-consuming. Here we will use remote commands to set various parameters on the spectrum analyzer remotely. We will briefly explain some of these commands below.

<b>Frequency Commands</b>	<code>meas:freq:cen?</code>	Return the center frequency in kHz.
	<code>meas:freq:cen</code>	Sets the center frequency, for example: <code>meas:freq:cen_100_mhz</code>
	<code>meas:freq:st?</code>	Returns the start frequency in kHz.
	<code>meas:freq:st</code>	Sets the start frequency, for example: <code>meas:freq:st_100_mhz</code>
	<code>meas:freq:stp?</code>	Returns the stop frequency in kHz.
	<code>meas:freq:stp</code>	Sets the stop frequency, for example: <code>meas:freq:stp_100_mhz</code>
<b>Span Commands</b>	<code>meas:span?</code>	Returns the frequency span settings.
	<code>meas:span</code>	Sets the frequency span settings, for example: <code>meas:span:10_mhz</code>
	<code>meas:span:full</code>	Sets the span to Full Span mode.
<b>Amplitude Commands</b>	<code>meas:refl:unit?</code>	Returns the reference level unit.
	<code>meas:refl:unit</code>	Sets the reference level unit. Parameters: 1(dBm), 2(dBmV), 3(dBuV)
	<code>meas:refl?</code>	Returns the reference level in dBm.
	<code>meas:refl</code>	Sets the reference level in dBm. For example: <code>meas:refl:-30</code>

**Limit line Commands**

meas:lmtnline:on Turns the limit lines on.  
Parameters:  
0(low limit line), 1(high limit line)

meas:lmtnline:off Turns the limit lines off.  
Parameters:  
0(low limit line), 1(high limit line)

meas:lmtnline:pas Turns pass/fail testing on.  
sfail\_on

**Experiment contents**

1. Set the upper and lower limit lines to perform a pass/fail test on the signal from the GRF-1300A.
2. Use remote commands to remotely setup the spectrum analyzer.

**Experiment steps**

1. Turn on the GRF-1300A and GSP-730.
2. Set the GRF-1300A to the power-on default state.
3. Connect the RF wire from the output port on the baseband module to the FM in port on the RF Synthesizer/FM module.



4. Set up the GSP-730 as follows:
  - Center frequency: 880MHz
  - Span: 50MHz
  - Reference level: 0dBm
  - RBW: Auto

Step1 **Frequency** F1 8 8 0 MHz/ mSec **Center 880.0MHz**

Step2 **Span** F1 5 0 MHz/ mSec **Span 50.0MHz**

Step3 **Amplitude** F1 0 GHz/ Sec **Ref. Level 0.0dBm**

Step4 **BW** F1 **RBW Auto Man**

5. Limit line Pass/Fail test.

Step5 **Limit Line** (F3) **Edit**

Step6 (F1) **Limit High Low** (F2) **Edit Table ON OFF**

Below the display, you can set the magnitude and frequency of each point. Move the cursor to select a point and edit it with the number pad and unit keys. Press (F6) to return to the previous menu.

Step7 (F1) **Pass/Fail ON OFF**

6. According to the procedures above, students can set the limit lines.
7. Adjust the amplitude knob on the GRF-1300A. Observe the Pass/Fail test results and record the results to table 9-1.
8. The same functionality can be achieved by sending remote commands from a PC using HyperTerminal.

**Experiment results**

Table 9-1. Results for adjusting the position of the amplitude knob.

5MHz frequency deviation test results.

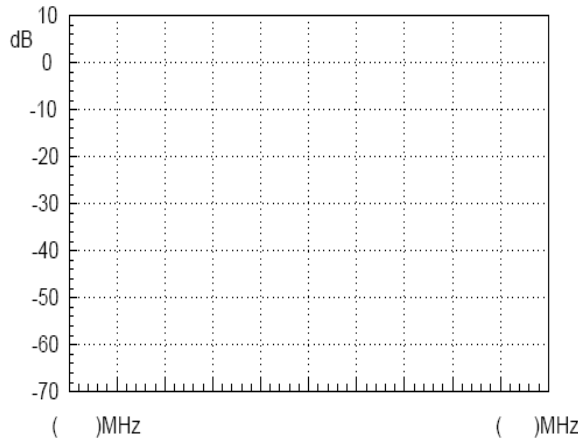



10MHz frequency deviation test results.

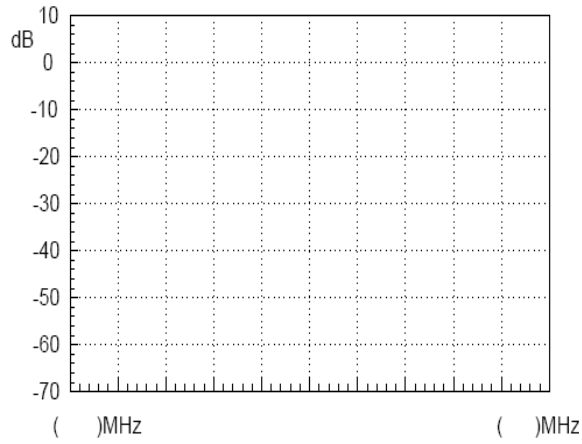

## Experiment 10: Mixer

Relevant information

In experiment 5 and 6 we introduced how the signal is modulated onto a carrier. However, what are the other processes that need to be performed on the modulated signal before it can be transmitted?

One thing called a frequency mixer is very important in this process. The main function of a frequency mixer is to perform frequency conversion; The mixer can convert the RF signal into an intermediate frequency signal or it can do the opposite and convert the intermediate frequency signal into an RF frequency signal in order to transmit or process the carried message, respectively. The goal of this experiment is to observe how a mixer will shift the frequency spectrum of a signal from a spectrum point of view and to understand the principles of the mixer.

Experiment Equipment	Item	Equipment	Quantity	Note
	1	Spectrum Analyzer	1	GSP-730
	2	RF & Communication Trainer	1	GRF-1300A
	3	USB Signal Generator	1	USG-LF44
	4	RF cable	2	100mm
	5	RF cable	1	200mm
	6	RF cable	1	800mm
	7	Adapter	1	N-SMA

Experiment goals

1. To understand the working principles of the mixer.
2. To observe frequency shift by analyzing the frequency spectrum with a spectrum analyzer.
3. To measure mixer parameters such as conversion gain and port isolation.

Experiment principals

1. Introduction to the concept of mixing  
The mixer is used for frequency conversion. Mixing is also known as conversion. Mixing is used to convert a modulated signal with a carrier frequency  $f^c$  to a modulated signal with the carrier the frequency  $f^l$  for processing at the next circuit. This process is called frequency shifting (shifting of the frequency spectrum). Frequency conversion by the mixer needs to maintain the modulation from the modulated carrier unchanged~ so it still carries information and has no distortion.

The basic function of a mixer is to maintain the modulation of the

modulated signal constant, only to increase (up-conversion) or decrease (down conversion) the carrier frequency. From the spectrum point of view, the essence of mixing is to linearly move the spectrum of the modulated signal along the frequency axis. Therefore, a mixer circuit must be composed of a non-linear device with a multiplicative function as well as band-pass filters, as shown in 10-1.

Figure 10-1 The mixer circuit

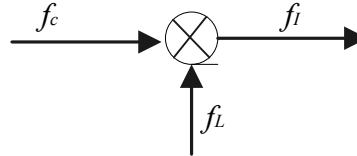

The mixer multiplies the modulated signal  $u_s(t)$  with carrier frequency  $f_c$  and the local oscillator signal  $u_L(t)$  with the oscillation frequency  $f_L$ , as shown in figure 10-2. According to the multiplication of trigonometric functions, the multiplication of the inputs results in the addition and difference of  $f_c$  and  $f_L$ . I.e.,  $f_i = f_L + f_c$  and  $f_i = |f_L - f_c|$ , where  $f_i$  is called the intermediate frequency. The mixing frequency signal with the carrier frequency  $f_i$  is called the intermediate frequency signal  $u_i(t)$ .

Figure 10-2

Mixer signal diagram

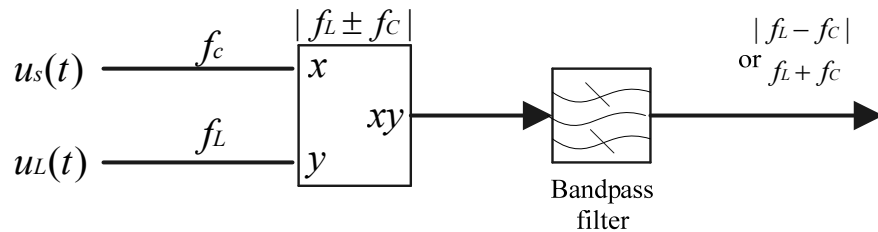

Say the modulated input signal  $u_s(t)$  is  $u_s(t) = V_s \cos(\omega_c t)$ , the local oscillation signal  $u_L(t)$  is  $u_L(t) = V_L \cos(\omega_L t)$ , then the product becomes

$$u_i(t) = V_s V_L \cos(\omega_c t) \cos(\omega_L t) = \frac{V_s V_L}{2} [\cos(\omega_c + \omega_L)t + \cos(\omega_L - \omega_c)t]$$

Passing through a band-pass filter and removing one of the frequency components ( $\omega_c + \omega_L$  or  $\omega_L - \omega_c$ ) completes the frequency conversion. Generally the new carrier frequency is called the IF signal.

The spectrum of the calculated result above is shown in the

diagram below.

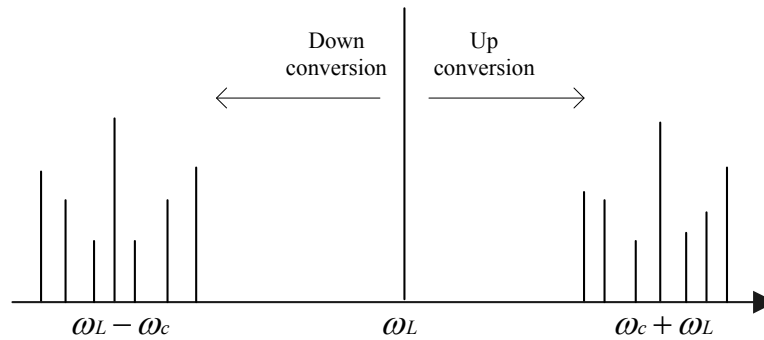

We can see from the spectrum shift in the chart above that the mixing frequency signal is the addition and subtraction of the input signal and the LO signal. As the frequency mixing device is generally a non-linear device, it is obvious that a non-linear combination of frequency distortion and interference will inevitably occur in the mixing process. The harmonic components of the LO signal and the input signal will also be input into the frequency mixer as well, therefore, the output will have the positive and negative components for each harmonic.

In a wireless transceiver circuit, the front-end small-signal low noise amplifier (LNA) and the IF amplifier (IFA) has far less non-linear frequency distortion than that produced by the frequency mixer. Therefore the combined non-linear distortion and frequency interference in the wireless receiver circuit is mainly generated by the frequency mixer circuit. The non-linear characteristics of the frequency mixer for engineering is commonly expressed by the following expansion formula:

$$i = a_0 + a_1u + a_2u^2 + a_3u^3 + \dots$$

In the formula  $u$  is the total signal that is added to the input end of the frequency mixer. Say the composition of  $u$  is

$$u = u_1 \cos \omega_1 t + u_2 \cos \omega_2 t + u_3 \cos \omega_3 t$$

Substituting U

$$\begin{aligned}
 i = & A_0 + A_1(u_1 \cos \omega_1 t + u_2 \cos \omega_2 t + u_3 \cos \omega_3 t) \\
 & + A_2(u_1^2 \cos 2\omega_1 + u_2^2 \cos 2\omega_2 + u_3^2 \cos 2\omega_3) \\
 & + A_3(u_1^3 \cos 3\omega_1 + u_2^3 \cos 3\omega_2 + u_3^3 \cos 3\omega_3) \\
 & + \dots + A_p \cos(\pm\omega_3 + \omega_1)t + A_q \cos(\pm\omega_3 \pm \omega_2)t \\
 & + A_m \cos(\pm\omega_3 + 2\omega_1 \pm \omega_2)t \\
 & + A_n \cos(\pm\omega_3 + \omega_1 \pm 2\omega_2)t \\
 & + A_x \cos(k\omega_3 + r\omega_1 + s\omega_2)t \\
 & + \dots
 \end{aligned}$$

Where, the  $A_0$  term is the DC component items, the  $A_1$  term is the fundamental term, while the  $A_2$  term and the  $A_3$  term are the 2nd and 3rd order harmonics, respectively. Higher harmonic components have been ignored. These frequency components are produced after the mixer and are filtered out with a bandpass filter. They do not affect any subsequent stages. The  $A_p$  and  $A_q$  terms are useful IF terms and should be received by the receiver normally. The  $A_m$  and  $A_n$  components are the third-order intermodulation frequency components and they also contribute to channel interference. It is difficult to use filters to filter out the third-order intermodulation interference. The most effective means of reducing third order interference is by designing and producing a mixing device with good linearity. Integrated mixing devices usually express the level of third-order intermodulation interference using the IP3 point (third order intermodulation intercept point). A large IP3 value indicates a mixer with good linearity. Circuit design that minimizes the amplitude of the RF signal input so that the mixer operates more linearly can also reduce third order intermodulation products.

## 2. The main parameters of the frequency mixer

The main technical indicators in the frequency mixer include conversion gain, 1dB compression point, port isolation and so on.

### (1) Conversion gain

The ratio of RF input power level to the output signal power level is called conversion gain,  $G_c$ . I.e.,

$$G_c = 10 \lg \frac{P_I}{P_R}$$

In the formula, both the RF input power  $P_R$  and IF output power  $P_I$  use dBm as the unit.

There exists conversion loss when the conversion gain is  $<1$ , therefore, for passive diodes, which is expressed by  $L_c$ . While for active frequency mixers such as transistors, FETs or integrated analog multipliers, the conversion gain is frequency gain  $> 1$ .

In measuring the conversion gain  $G_c$ , the LO drive power must be a fixed power level. For example, for a diode ring mixer with a  $50\Omega$  input/output impedance, the LO standard power level is 7dBm. For the integrated analog multiplier MC1596, the LO standard power level is 20dBm.

When measuring and applying the frequency mixer, it should be noted that impedance matching should be used with the three ports of the frequency mixer. When the RF port of the frequency mixer passes through image rejection filter and is connected to LNA, the input impedance in the RF port of frequency mixer must match the output impedance of its filter to ensure the performance of the filter. Generally the output impedance of the filter is  $50\Omega$ . Similarly, the output impedance of the IF port of the frequency mixer should match the input impedance of the IF filter. Generally the impedance of an IF filter with a frequency lower than 100MHz is greater than  $50\Omega$ .

## (2) 1dB compression point

The Compression point is used to denote the non-linear distortion of a frequency mixer. For a signal with small RF, the frequency mixer is a linear network. When the RF input level is much smaller than the LO level, the frequency mixer operates linearly. In other words, the RF output increases linearly with an increase in the RF input level. However, when the RF input increases to a certain extent, such as when the difference between the RF input level and the LO level is more than 10dB, the rate of the IF output slows, and the relationship between the RF input and RF output is no longer linear. At this point, the frequency mixer begins to enter saturation and exhibits

non-linear distortion as shown in Figure 10-3

The figure shows that the conversion compression point is the point in which the IF output power level deviates from the linear ideal by 1dB. Obviously, the conversion compression point indirectly expresses the extent of the nonlinear distortion of the frequency mixer. For a LNA this 1dB compression point can also be used to represent the linear amplification range for a LNA.

10-3  
1dB  
compression  
point

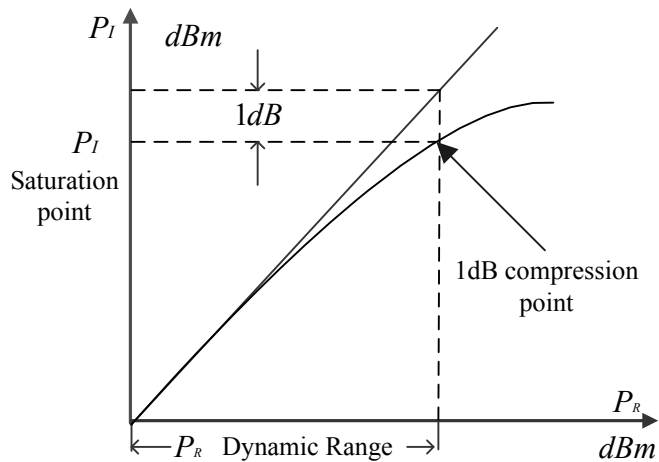

(3) Port isolation

The port isolation of the mixer characterizes the balance of the internal circuitry, which determines the amount of feedthrough leakage between the mixer and each port. Theoretically the ports on a mixer should be strictly isolated, but because practical internal mixer circuitry is somewhat unbalanced, it will generate signal feedthrough between each port.

If the isolation between each port of the frequency mixer is low, it will directly affect the following aspects: The leakage of the LO signal port to the RF port will affect the LNA and even radiate through the antenna. With a diode ring frequency mixer in particular, when an LO signal passes through the LO port and leaks into the RF input port, it will transmit out the LO signal through the antenna to create interference in the adjacent channels. The leaking power from the RF port to the LO port makes the LO vulnerable to frequency pulling. When the LO port leaks to the mixer output port, a big LO signal can affect the amplification of the IF signal.

- Experiment contents
1. Observe frequency shift.
  2. Measure port isolation and conversion gain.
- 
3. Use the GRF-1300A to emit a 2.4GHz modulated signal.

- Experiment steps
1. Turn on the GRF-1300A and GSP-730.
  2. Set up the GRF-1300A.
    - Connect an RF cable from the RF/FM port in the synthesizer/FM module to the IF In port in the Mixer module.
    - Connect an RF cable from the USG (USB signal generator) output port to the LO In port in the mixer module.
    - Connect an RF cable from the RF output in the mixer module to the RF port of the spectrum analyzer.
    - Use PC software to set the USG frequency to 1520MHz.



3. Set the spectrum analyzer as follows:
  - Center frequency: 2.4 GHz
  - Span: FULL
  - Reference level: 0dBm
  - Resolution bandwidth: Auto

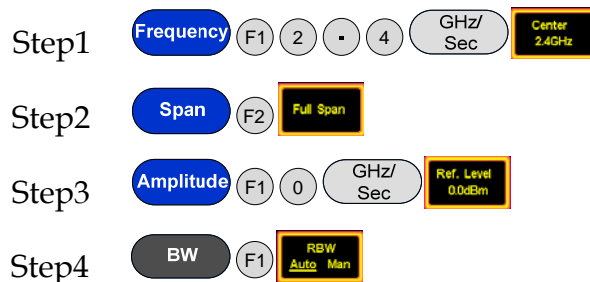

4. Observe the spectrum distribution with the spectrum analyzer. Get the spectrum distribution at the time of frequency mixing. Measure the magnitude of each spectral line and draw it into



table 10-1.

Step5 **Peak Search**

5. Adjust the frequency of the RF output in the RF Synthesizer/FM module. Observe the changes on the spectrum analyzer and record it in table 10-1.

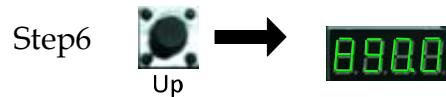

6. Adjust the frequency of the RF output in the RF Synthesizer/FM module. Observe the changes on the spectrum analyzer and record it in table 10-1.

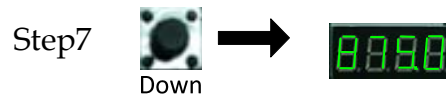

7. Obtain the spectrum and amplitude of each spectral line according to the previous step, calculate the conversion gain of the down-converted product and calculate the isolation degree in the IF In port. Record the experimental results in the table 10-2.
8. After completion of the above experimental steps, adjust the RF frequency in the RF Synthesizer / FM module to 880MHz. Then, connect the RF output port in the Mixer module to the BPF in port in the Band Pass Filter module with the RF cable. Connect the RF cable that was originally connected to the RF output port in the Mixer module to BPF output port and keep the other connected to the input port of the spectrum analyzer.

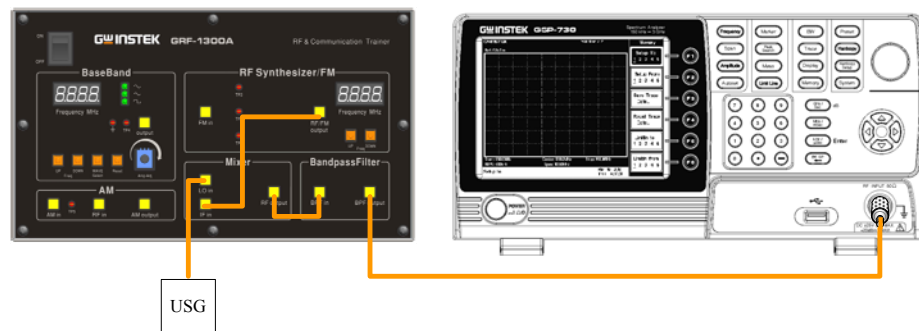

9. Spectrum analyzer settings remain unchanged.
10. Observe what changes on the spectrum analyzer and record in table 10-3.

11. Maintain the same connections as used in step 10. Connect the output port in the Base Band module to the FM port in the RF synthesizer/FM module with an RF cable. Adjust the potentiometer in the bassband so that the audio signal is at a certain level.

12. Now set the GSP-730 as follows:

- Center frequency: 2.4GHz
- Span: 50MHz
- Reference level: 0dBm
- Resolution bandwidth(RBW): Auto

Step8 **Frequency** (F1) 2 4 GHz/Sec **Center 2.4GHz**

Step9 **Span** (F1) 5 0 MHz/mSec **Span 50MHz**

Step10 **Amplitude** (F1) 0 GHz/Sec **Ref. Level 0.0dBm**

Step11 **BW** (F1) **RBW Auto Man**

13. Observe what changes on the spectrum analyzer and record it in table 10-3.

14. Convert the AM modulated signal to 2.4 GHz according to the method used to generate an AM modulated signal in experiment 5. Record the result in table 10-3.

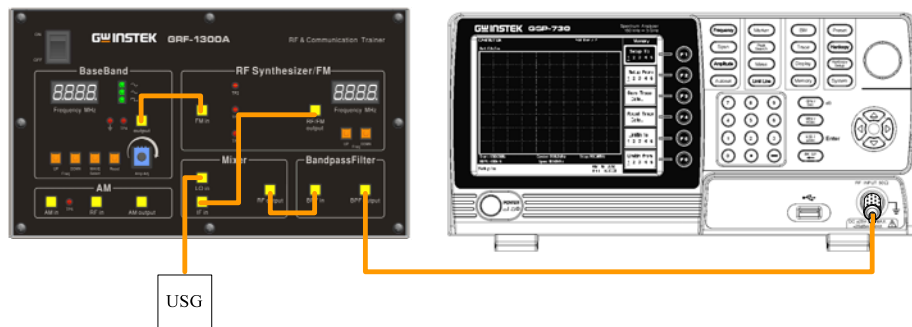

Experiment results

1. Frequency shifting with the mixer

TABLE 10-3

RF Frequency	Test Results
--------------	--------------

shifting result

880MHz

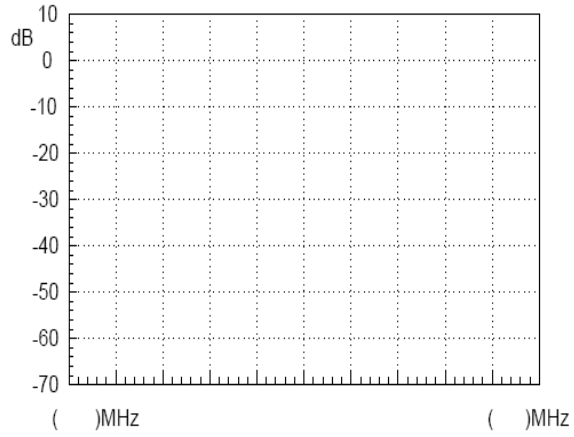

Amplitude of each frequency point:

890MHz

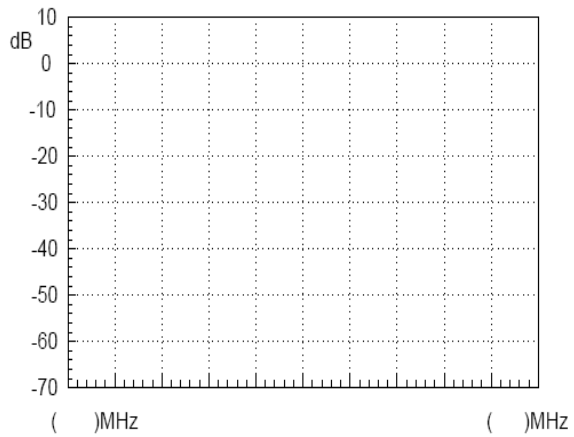

Amplitude of each frequency point:

875MHz

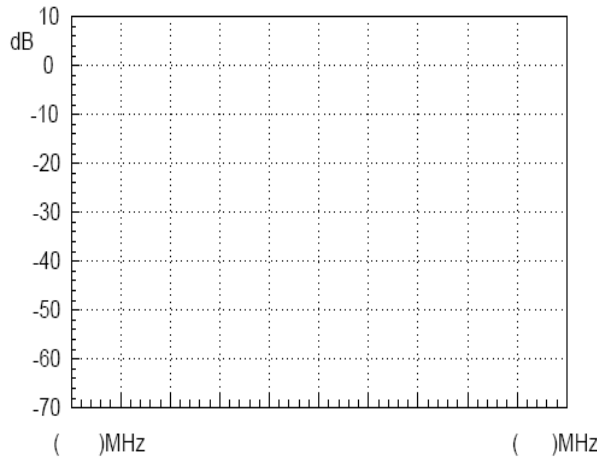

Amplitude of each frequency point:

2. Conversion gain for the down-converted product and the isolation degree of the IF In port.

Table 10-2 Conversion gain

Calculation of gain and isolation

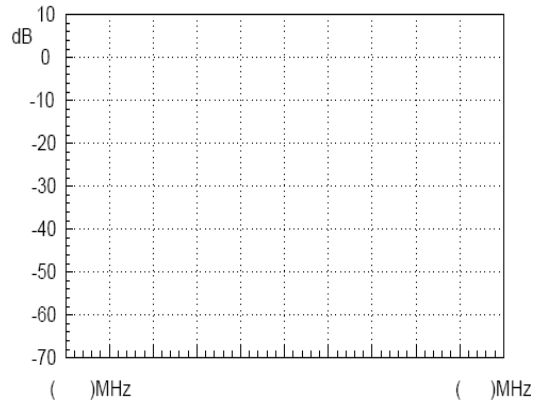

Gain:

IF In port isolation

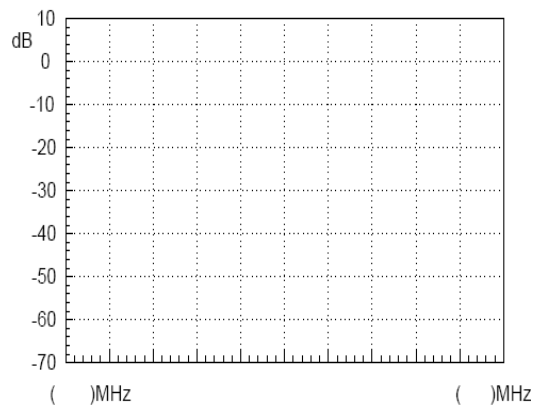

Isolation:

### 3. 2.4GHz modulated signal

Table 10-3 Unmodulated signal  
2.4GHz modulated signal

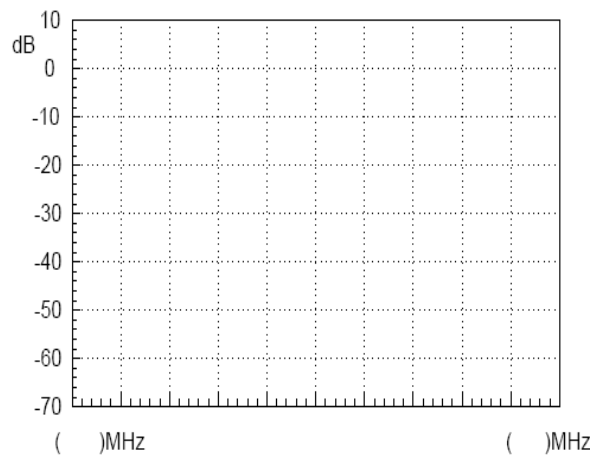

FM modulated  
signal

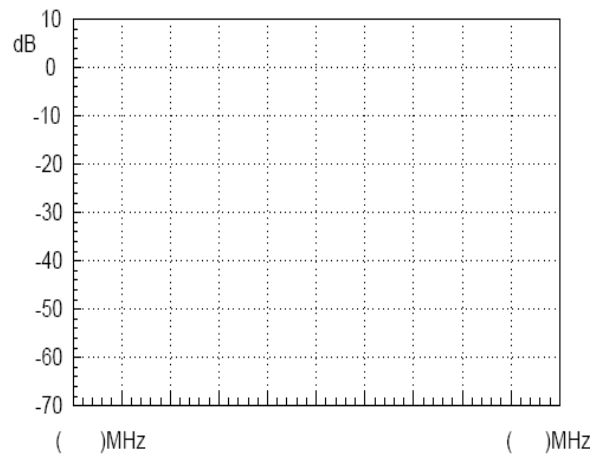

AM modulated  
signal

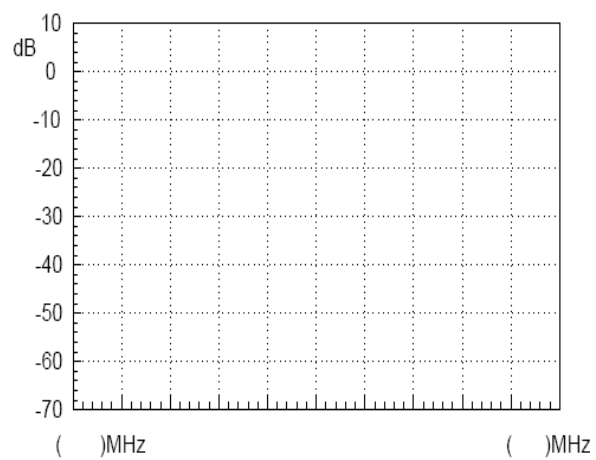

Questions

1. What are the characteristics of a bandpass filter?
2. Why are there 5 frequency points in the output spectrum of the frequency mixer?

# T EST for LEARNING OUTCOMES

In the previous experiments, we introduced the concepts behind phase locked loops, amplitude modulation and frequency modulation, and we now have a good understanding of them. But that is not enough to fully grasp RF circuits. This experiment combines these three parts to form one system. Each module in the circuit can be turned on or off via remote commands so that the experiments can be used to diagnose (simulated) malfunctions. When students analyze the causes of these malfunctions, they will have an overall understanding about the relationship and principles behind each one. This helps students build their knowledge of PLLs, AM and FM.

---

- Experiment Aim:**
1. Understand how and why a phase locked loop enters the lock state or loses the lock state.
  2. Have an understanding of the overall communication system.
- 

**Experiment Contents** The instructor will send remote commands to the GRF-1300A and create a malfunction. Students can use an oscilloscope, spectrum analyzer and/or other measurement instruments to try to deduce/verify the cause of the malfunction/fault.

## 1: RF signal Fault Simulation

---

**Fault 1**

**Fault description:**

---



---



---

**Hypothesis:**

---



---



---

**Verification**

**Fault 2**

**Fault description**

**Hypothesis:**

**Verification:**

**2: FM Fault Simulation**

**Fault 1:**

**Fault description:**

**Hypothesis:**

**Verification:**

**Fault 2**

**Fault  
description**

---

---

---

**Hypothesis:**

---

---

---

**Verification:**

---

---

**Fault 3**

**Fault  
description:**

---

---

---

**Hypothesis:**

---

---

---

**Verification:**

---

---

**Fault 4**

**Fault  
description**

---

---

---

**Hypothesis:**

---

---



Verification:

### 3:AM Fault Simulation

Fault 1

Fault  
description:

Hypothesis:

Verification:

Fault 2

Fault  
description

Hypothesis:

Verification:

**Fault 3****Fault  
description**

---

---

---

**Hypothesis:**

---

---

---

**Verification:**

---

---

**Fault 4****Fault  
description:**

---

---

---

**Hypothesis:**

---

---

---

**Verification:**

---

---

---









# A PPENDIX

We have included some commonly-used conversion tables for use with the questions.

## dBm Conversion Table

dBm, dBuV and dBmV are all absolute units. i.e., they represent a physical quantity. The corresponding conversion tables are below:

dBm	mW	uV	dBuV	dBmV
-30	0.001	7071.07	76.9897	16.9897
-25	0.003	12574.33	81.9897	21.9897
-20	0.010	22360.68	86.9897	26.9897
-15	0.032	39763.54	91.9897	31.9897
-10	0.100	70710.68	96.9897	36.9897
-5	0.316	125743.34	101.9897	41.9897
0	1.000	223606.80	106.9897	46.9897
5	3.162	397635.36	111.9897	51.9897
10	10.000	707106.78	116.9897	56.9897
15	31.623	1257433.43	121.9897	61.9897
20	100.000	2236067.98	126.9897	66.9897
25	316.228	3976353.64	131.9897	71.9897
30	1000.000	7071067.81	136.9897	76.9897

## The relationship between dB and dBc

---

The figures in the table above are based on a 50Ω load. As an example, as -30dBm is equal to 0.001mW or 10<sup>-6</sup>W, therefore with a 50Ω load it is 7071.07 uV or 0.007071mV. The formulas and derivations from the above table are:

$$P_{\text{inmW}} = 10^{\frac{\text{dBm}}{10}} \Rightarrow V = \sqrt{P \times R}$$

$$\Rightarrow \text{dBuV} = 20 \times \log\left(\frac{V}{\text{uV}}\right)$$

further  $\text{dBm} = 10 \times \log\left(\frac{P}{\text{mW}}\right) \quad \text{dBmV} = 20 \times \log\left(\frac{V}{\text{mV}}\right)$

As for dB and dBc, they are relative units. In terms of power, a difference of 20dB is equal to a difference of 100 times.

**Question**      What is the difference between 0dBm and -50dBm? Is it 50dB or 50dBm?

**Answer**        50dB

**Explanation**    0dBm = 1mW, -50dBm = 10<sup>-5</sup>mW, therefore the difference of both is 10<sup>5</sup> times which equal to 50dB or a difference of 0.99999mW

And 0.99999mW is equal to -0.0000434dBm ≈ 0dBm.

50dBm = 10<sup>5</sup>mW = 100W. Obviously 50dBm is the wrong answer.



Resistor Values in  $\pi$ -type Resistance Attenuators

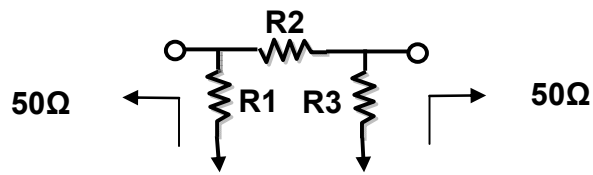

dB	R1	R2	R3
1	869.55	5.77	869.55
2	436.21	11.61	436.21
3	292.40	17.61	292.40
4	220.97	23.85	220.97
5	178.49	30.40	178.49
6	150.48	37.35	150.48
7	130.73	44.80	130.73
8	116.14	52.84	116.14
9	104.99	61.59	104.99
10	96.25	71.15	96.25
11	89.24	81.66	89.24
12	83.54	93.25	83.54
13	78.84	106.07	78.84
14	74.93	120.31	74.93
15	71.63	136.14	71.63
16	68.83	153.78	68.83
17	66.45	173.46	66.45
18	64.40	195.43	64.40
19	62.64	220.01	62.64
20	61.11	247.50	61.11
25	55.96	443.16	55.96
30	53.27	789.78	53.27
35	51.81	1405.41	51.81
40	51.01	2499.75	51.01

## Resistor Values in T-type Resistance Attenuators

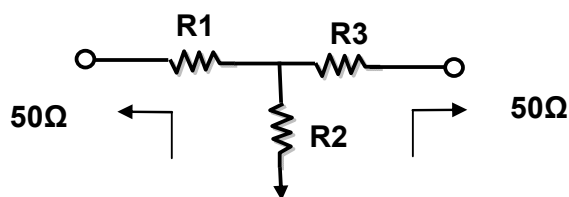

dB	R1	R2	R3
1	2.88	433.34	2.88
2	5.73	215.24	5.73
3	8.55	141.93	8.55
4	11.31	104.83	11.31
5	14.01	82.24	14.01
6	16.61	66.93	16.61
7	19.12	55.80	19.12
8	21.53	47.31	21.53
9	23.81	40.59	23.81
10	25.97	35.14	25.97
11	28.01	30.62	28.01
12	29.92	26.81	29.92
13	31.71	23.57	31.71
14	33.37	20.78	33.37
15	34.90	18.36	34.90
16	36.32	16.26	36.32
17	37.62	14.41	37.62
18	38.82	12.79	38.82
19	39.91	11.36	39.91
20	40.91	10.10	40.91
25	44.68	5.64	44.68
30	46.93	3.17	46.93
35	48.25	1.78	48.25
40	49.01	1.00	49.01

Modulation Index and Sideband Amplitude Comparison Table

Modulation index	Sideband																
	Carrier	1	2	3	4	5	6	7	8	9	10	11	12	13	14	15	16
0.00	1.00																
0.25	0.98	0.12															
0.5	0.94	0.24	0.03														
1.0	0.77	0.44	0.11	0.02													
1.5	0.51	0.56	0.23	0.06	0.01												
2.0	0.22	0.58	0.35	0.13	0.03												
2.41	0	0.52	0.43	0.20	0.06	0.02											
2.5	-0.05	0.50	0.45	0.22	0.07	0.02	0.01										
3.0	-0.26	0.34	0.49	0.31	0.13	0.04	0.01										
4.0	-0.40	-0.07	0.36	0.43	0.28	0.13	0.05	0.02									
5.0	-0.18	-0.33	0.05	0.36	0.39	0.26	0.13	0.05	0.02								
5.53	0	-0.34	-0.13	0.25	0.40	0.32	0.19	0.09	0.03	0.01							
6.0	0.15	-0.28	-0.24	0.11	0.36	0.36	0.25	0.13	0.06	0.02							
7.0	0.30	0.00	-0.30	-0.17	0.16	0.35	0.34	0.23	0.13	0.06	0.02						
8.0	0.17	0.23	-0.11	-0.29	-0.10	0.19	0.34	0.32	0.22	0.13	0.06	0.03					
8.65	0	0.27	0.06	-0.24	-0.23	0.03	0.26	0.34	0.28	0.18	0.10	0.05	0.02				
9.0	-0.09	0.25	0.14	-0.18	-0.27	-0.06	0.20	0.33	0.31	0.21	0.12	0.06	0.03	0.01			
10.0	-0.25	0.04	0.25	0.06	-0.22	-0.23	-0.01	0.22	0.32	0.29	0.21	0.12	0.06	0.03	0.01		
12.0	0.05	-0.22	-0.08	0.20	0.18	-0.07	-0.24	-0.17	0.05	0.23	0.30	0.27	0.20	0.12	0.07	0.03	0.01

## Declaration of Conformity

We

**GOOD WILL INSTRUMENT CO., LTD.**

No. 7-1, Jhongsing Rd, Tucheng Dist., New Taipei City 236. Taiwan.

**GOOD WILL INSTRUMENT (SUZHOU) CO., LTD.**

No. 69 Lushan Road, Suzhou City(Xin Qu), Jiangsu Sheng, China. declare that the below mentioned product

Type of Product: **RF & Communication Trainer**

Model Number: **GRF-1300A**

are herewith confirmed to comply with the requirements set out in the Council Directive on the Approximation of the Law of Member States relating to Electromagnetic Compatibility (2004/108/EEC) and Low Voltage Directive (2006/95/EEC).

For the evaluation regarding the Electromagnetic Compatibility and Low Voltage Directive, the following standards were applied:

© EMC	
EN 61326-1:	Electrical equipment for measurement, control and laboratory use -- EMC requirements (2006)
Conducted & Radiated Emission EN 55011: 2009+A1: 2010	ClassB Electrostatic Discharge IEC 61000-4-2: 2008
Current Harmonics EN 61000-3-2: 2006+A2: 2009	Radiated Immunity IEC 61000-4-3: 2006+A2: 2010
Voltage Fluctuations EN 61000-3-3: 2008	Electrical Fast Transients IEC 61000-4-4: 2004+A1: 2010
-----	Surge Immunity IEC 61000-4-5: 2005
-----	Conducted Susceptibility IEC 61000-4-6: 2008
-----	Power Frequency Magnetic Field IEC 61000-4-8: 2009
-----	Voltage Dip/ Interruption IEC 61000-4-11: 2004

Low Voltage Equipment Directive 2006/95/IEC	
Safety Requirements	IEC 61010-1: 2010 (Third Edition)