

Programmable DC Power Supply

PSU Series

PROGRAMMING MANUAL



ISO-9001 CERTIFIED MANUFACTURER

GW INSTEK

This manual contains proprietary information, which is protected by copyright. All rights are reserved. No part of this manual may be photocopied, reproduced or translated to another language without prior written consent of Good Will company.

The information in this manual was correct at the time of printing. However, Good Will continues to improve products and reserves the rights to change specification, equipment, and maintenance procedures at any time without notice.

Good Will Instrument Co., Ltd.
No. 7-1, Jhongsing Rd., Tucheng Dist., New Taipei City 236, Taiwan.

Table of Contents

SAFETY INSTRUCTIONS	4
GETTING STARTED.....	8
PSU Series Overview.....	9
Appearance.....	14
Configuration Settings.....	22
REMOTE CONTROL.....	33
Interface Configuration.....	35
Command Syntax.....	68
Command List.....	71
Status Register Overview.....	139
Error List.....	152
APPENDIX.....	161
PSU Factory Default Settings.....	162
PSU Preset Default Settings.....	165
Error Messages & Messages.....	166
LED ASCII Table Character Set.....	167
INDEX.....	168

S SAFETY INSTRUCTIONS

This chapter contains important safety instructions that you must follow during operation and storage. Read the following before any operation to insure your safety and to keep the instrument in the best possible condition.

Safety Symbols

These safety symbols may appear in this manual or on the instrument.



WARNING

Warning: Identifies conditions or practices that could result in injury or loss of life.



CAUTION

Caution: Identifies conditions or practices that could result in damage to the PSU or to other properties.



DANGER High Voltage



Attention Refer to the Manual



Protective Conductor Terminal



Earth (ground) Terminal



Do not dispose electronic equipment as unsorted municipal waste. Please use a separate collection facility or contact the supplier from which this instrument was purchased.

Safety Guidelines

General Guideline



CAUTION

- Do not place any heavy object on the PSU.
- Avoid severe impact or rough handling that leads to damaging the PSU.
- Do not discharge static electricity to the PSU.
- Use only mating connectors, not bare wires, for the terminals.
- Do not block the cooling fan opening.
- Do not disassemble the PSU unless you are qualified.

(Measurement categories) EN61010-1:2010 and EN61010-2-030 specifies the measurement categories and their requirements as follows. The PSU falls under category II.

- Measurement category IV is for measurement performed at the source of low-voltage installation.
- Measurement category III is for measurement performed in the building installation.
- Measurement category II is for measurement performed on the circuits directly connected to the low voltage installation.
- 0 is for measurements performed on circuits not directly connected to Mains.

Power Supply



WARNING

- AC Input voltage range: 85Vac~265Vac
 - Frequency: 47Hz to 63Hz
 - To avoid electrical shock connect the protective grounding conductor of the AC power cord to an earth ground.
-

-
- Cleaning the PSU
- Disconnect the power cord before cleaning.
 - Use a soft cloth dampened in a solution of mild detergent and water. Do not spray any liquid.
 - Do not use chemicals containing harsh material such as benzene, toluene, xylene, and acetone.
-

- Operation Environment
- Location: Indoor, no direct sunlight, dust free, almost non-conductive pollution (Note below)
 - Relative Humidity: 20%~ 85% (no condensation)
 - Altitude: < 2000m
 - Temperature: 0°C to 50°C

(Pollution Degree) EN61010-1:2010 and EN61010-2-030 specifies the pollution degrees and their requirements as follows. The PSU falls under degree 2.

Pollution refers to “addition of foreign matter, solid, liquid, or gaseous (ionized gases), that may produce a reduction of dielectric strength or surface resistivity”.

- Pollution degree 1: No pollution or only dry, non-conductive pollution occurs. The pollution has no influence.
 - Pollution degree 2: Normally only non-conductive pollution occurs. Occasionally, however, a temporary conductivity caused by condensation must be expected.
 - Pollution degree 3: Conductive pollution occurs, or dry, non-conductive pollution occurs which becomes conductive due to condensation which is expected. In such conditions, equipment is normally protected against exposure to direct sunlight, precipitation, and full wind pressure, but neither temperature nor humidity is controlled.
-

- Storage environment
- Location: Indoor
 - Temperature: -25°C to 70°C
 - Relative Humidity: ≤90% (no condensation)
-

Disposal



Do not dispose this instrument as unsorted municipal waste. Please use a separate collection facility or contact the supplier from which this instrument was purchased. Please make sure discarded electrical waste is properly recycled to reduce environmental impact.

Power cord for the United Kingdom

When using the power supply in the United Kingdom, make sure the power cord meets the following safety instructions.

NOTE: This lead/appliance must only be wired by competent persons



WARNING: THIS APPLIANCE MUST BE EARTHED

IMPORTANT: The wires in this lead are coloured in accordance with the following code:

Green/ Yellow:	Earth
Blue:	Neutral
Brown:	Live (Phase)



As the colours of the wires in main leads may not correspond with the coloured marking identified in your plug/appliance, proceed as follows:

The wire which is coloured Green & Yellow must be connected to the Earth terminal marked with either the letter E, the earth symbol  or coloured Green/Green & Yellow.

The wire which is coloured Blue must be connected to the terminal which is marked with the letter N or coloured Blue or Black.

The wire which is coloured Brown must be connected to the terminal marked with the letter L or P or coloured Brown or Red.

If in doubt, consult the instructions provided with the equipment or contact the supplier.

This cable/appliance should be protected by a suitably rated and approved HBC mains fuse: refer to the rating information on the equipment and/or user instructions for details. As a guide, a cable of 0.75mm² should be protected by a 3A or 5A fuse. Larger conductors would normally require 13A types, depending on the connection method used.

Any exposed wiring from a cable, plug or connection that is engaged in a live socket is extremely hazardous. If a cable or plug is deemed hazardous, turn off the mains power and remove the cable, any fuses and fuse assemblies. All hazardous wiring must be immediately destroyed and replaced in accordance to the above standard.

G E T T I N G S T A R T E D

This chapter describes the power supply in a nutshell, including its main features and front / rear panel introduction. After going through the overview, please read the theory of operation to become familiar with the operating modes, protection modes and other safety considerations.



PSU Series Overview	9
Series lineup.....	9
Main Features.....	10
Accessories	11
Appearance	14
PSU Series Front Panel	14
PSU Series Display and Operation Panel.....	17
Rear Panel	19
Configuration Settings	22
Setting Normal Function Settings.....	22
Setting Power On Configuration Settings.....	24
Configuration Table.....	26

PSU Series Overview

Series lineup

The PSU series consists of 15 models, covering a number of different current, voltage and power capacities:

Model name	Voltage Rating ¹	Current Rating ²	Power
PSU 6-200	6V	200A	1200W
PSU 8-180	8V	180A	1440W
PSU 12.5-120	12.5V	120A	1500W
PSU 15-100	15V	100V	1500W
PSU 20-76	20V	76A	1520W
PSU 30-50	30V	50A	1500W
PSU 40-38	40V	38A	1520W
PSU 50-30	50V	30A	1500W
PSU 60-25	60V	25A	1500W
PSU 80-19	80V	19A	1520W
PSU 100-15	100V	15A	1500W
PSU 150-10	150V	10A	1500W
PSU 300-5	300V	5A	1500W
PSU 400-3.8	400V	3.8A	1520W
PSU 600-2.6	600V	2.6A	1560W

¹Minimum voltage guaranteed to 0.2% of rating voltage.

²Minimum current guaranteed to 0.4% of rating current.

Main Features

- Performance
- High power density: 1500W in 1U
 - Universal input voltage 85~265Vac, continuous operation.
 - Output voltage up to 600V, current up to 200A.
-

- Features
- Active power factor correction.
 - Parallel master/slave operation with active current sharing.
 - Remote sensing to compensate for voltage drop in load leads.
 - 19" rack mounted ATE applications.
 - A built-in Web server.
 - OVP, OCP and OHP protection.
 - Preset memory function.
 - Adjustable voltage and current slew rates.
 - Bleeder circuit ON/OFF setting.
 - CV, CC priority start function. (Prevents overshoot with output ON)
 - Supports test scripts.
-

- Interface
- Built-in RS-232/485, LAN and USB interface.
 - Analog output programming and monitoring.
 - Optional interfaces: GPIB, Isolated Voltage (0-5V/0-10V) and Isolated Current (4-20mA) programming and monitoring interface. (Factory options)

Accessories

Before using the PSU power supply unit, check the package contents to make sure all the standard accessories are included.

Standard Accessories	Part number	Description	Qty.
		Output terminal cover	1
		Analog connector plug kit	1
		Output terminal M8 bolt set (6V~60V model)	1
		Input terminal cover	1
		Power Cord (230VAC/10A, 1.8M, provide for some region only)	1
	82GW1SAFE0M*1	Safety Guide	1
	62SB-8K0HD1*1	1U Handle, ROHS	2
	62SB-8K0HP1*1	1U BRACKET (LEFT), RoHS	1
	62SB-8K0HP2*1	1U BRACKET (RIGHT), RoHS	1
	CD-ROM	User manual, Programming manual	1 set
	82SU-PSU00K*1	Packing list	
	82GW-00000C*1	* CTC GW/INSTEK JAPAN USE ,RoHS	1
Factory Installed Options	Part number	Description	
	PSU-GPIB	GPIB interface	
	PSU-ISO-V	Voltage programming isolated analog interface	
	PSU-ISO-I	Current programming isolated analog interface	
	PSU-001	Front Panel Filter Kit (Operation Temperature is guaranteed to 40°C)	

Optional Accessories	Part number	Description
	PSU-01C	Cable for 2 units of PSU-Series in parallel mode connection
	PSU-01B	Bus Bar for 2 units of PSU-Series in parallel mode connection
	PSU-01A	Joins a vertical stack of 2 PSU units together. 2U-sized handles x2, joining plates x2.
	PSU-02C	Cable for 3 units of PSU-Series in parallel mode connection
	PSU-02B	Bus Bar for 3 units of PSU-Series in parallel mode connection
	PSU-02A	Joins a vertical stack of 3 PSU units together. 3U-sized handles x2, joining plates x2.
	PSU-03C	Cable for 4 units of PSU-Series in parallel mode connection
	PSU-03B	Bus Bar for 4 units of PSU-Series in parallel mode connection
	PSU-03A	Joins a vertical stack of 4 PSU units together. 4U-sized handles x2, joining plates x2.
	PSU-232	RS232 cable with DB9 connector kit. It Includes RS232 cable with DB9 connector, RS485 used master cable (gray plug), slave cable (black plug), intermediate connector and end terminal connector.
	PSU-485	RS485 cable with DB9 connector kit. It Includes RS485 cable with DB9 connector, RS485 used master cable (gray plug), slave cable (black plug), intermediate connector and end terminal connector.

GRM-001	Rack-mount slides (General Devices P/N: C-300-S-116-RH-LH)
GTL-246	USB Cable 2.0-A-B Type, Approx. 1.2M
GPW-001	Power Cord SJT 12AWG/3C, 3m MAX Length, 105 °C, RNB5-5*3P UL/CSA type
GPW-002	Power Cord H05W-F 1.5mm ² /3C, 3m MAX Length, 105 °C, RNB5-5*3P VDE type
GPW-003	Power Cord VCTF 3.5mm ² /3C, 3m MAX Length, 105 °C, RNB5-5*3P PSE type

Download	Name	Description
	psu_cdc.inf	PSU USB driver
Other	Name	Description
	Certificate of traceable calibration	

Appearance

PSU Series Front Panel

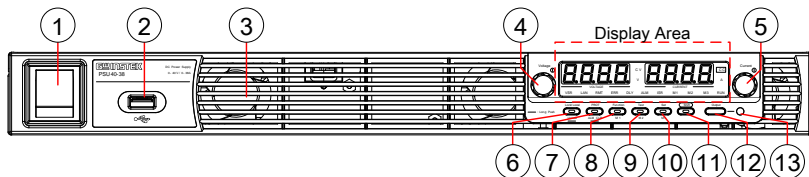

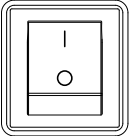
- 1. Power Switch  Used to turn the power on/off.



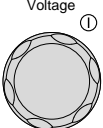

- 2. USB A Port  USB A port for data transfer, loading test scripts etc.

- 3. Air Inlet  Air inlet for cooling the inside of the PSU series.

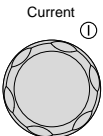
- 4. Voltage Knob  Used to set the voltage value or select a parameter number in the Function settings.

Display Area The display area shows setting values, output values and parameter settings. The function LEDs below show the current status and mode of the power supply. See page 17 for details.

- 5. Current Knob  Used to set the current value or change the value of a Function parameter.

6. Lock/Local Button  Used to lock all front panel buttons other than the Output Button or it switches to local mode.
- Unlock Button (Long push) Used to unlock the front panel buttons.
7. PROT Button  Used to set and display OVP, OCP and UVL.
- ALM_CLR Button (Long push) Used to release protection functions that have been activated.
8. Function Button  Used to configure the various functions.
- M1 Button (+Shift) Used to recall the M1 setup.
(+Shift and hold) Used to save the current setup to M1.
9. Test Button  Used to run customized scripts for testing.
- M2 Button (+Shift) Used to recall the M2 setup.
(+Shift and hold) Used to save the current setup to M2.
10. Set Button  Used to set and confirm the output voltage and output current.
- M3 Button (+Shift) Used to recall the M3 setup.
(+Shift and hold) Used to save the current setup to M3.

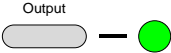
11. Shift Button  Used to enable the functions that are written in blue characters below certain buttons.
12. Output Button  Used to turn the output on or off.
13. Output ON LED Lights in green when the output is on.

PSU Series Display and Operation Panel

Display Area

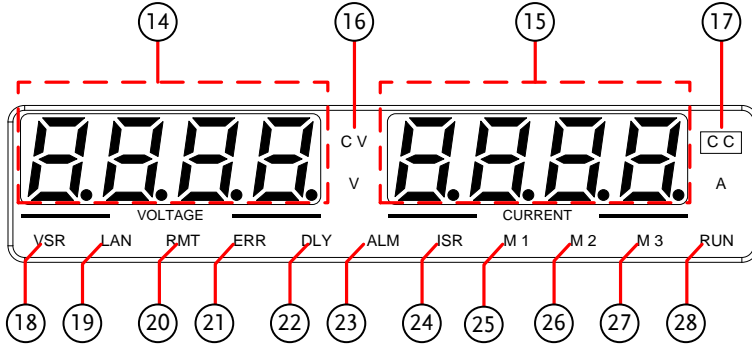

- | | |
|-------------------|---|
| 14. Voltage Meter | Displays the voltage or the parameter number of a Function parameter. |
| 15. Current Meter | Displays the current or the value of a Function parameter. |
| 16. CV LED | Lights in green during constant voltage mode. |
| 17. CC LED | Lights in green during constant current mode. |
| 18. VSR LED | Lights up when CV Slew Rate Priority is enabled. |
| 19. LAN LED | Lights up when the LAN interface is connected. |
| 20. RMT LED | Lights in green during remote control. |
| 21. ERR LED | Lights in red when an SCPI error has occurred. |
| 22. DLY LED | The Output On/Off Delay indicator LED. |
| 23. ALM LED | Lights in red when a protection function has been activated. |

- 24. ISR LED Lights up when CC Slew Rate Priority is enabled.
- 25. M1 LED Lights in green when the memory value are being recalled or saved.
- 26. M2 LED Lights in green when the memory value are being recalled or saved.
- 27. M3 LED Lights in green when the memory value are being recalled or saved.
- 28. RUN LED Lights up when a Test Script has been activated.



Note

Only the ERR and ALM LED's are red. All the others are green.

Rear Panel

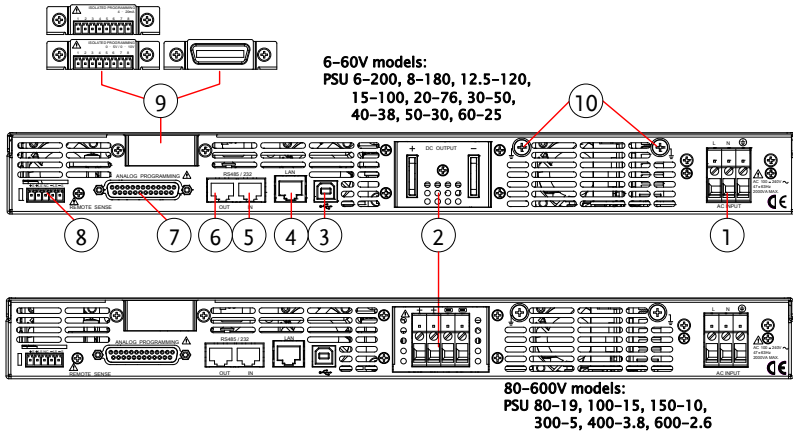

1. AC Input

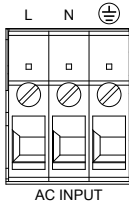

Wire clamp connector.

2. DC Output

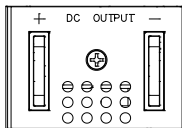

Output terminals for 6V to 60V models.

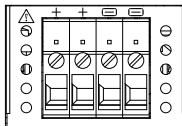

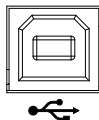

Output terminals for 80V to 600V models.

3. USB

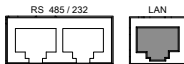

USB port for controlling the PSU remotely.

- 4. LAN  Ethernet port for controlling the PSU remotely.
- 5. Remote-IN  Two different types of cables can be used for RS232 or RS485-based remote control.

PSU-232: RS232 cable with DB9 connector kit.

PSU-485: RS485 cable with DB9 connector kit.
- 6. Remote-OUT  RJ-45 connector that is used to daisy chain power supplies with the Remote-IN port to form a communication bus.

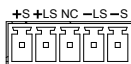
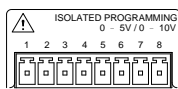
PSU-485S: Serial link cable with RJ-45 shielded connector.
- 7. Analog Control  External analog control connector.
- 8. Remote Sense  Compensation of load wire drop.
- 9. Option Slot  Blank sub-plate for standard units. Isolated Analog connector for units equipped with Isolated Current and Voltage Programming and Monitoring option. GPIB connector for units equipped with IEEE programming option.

10. Ground
Screw

Connectors for grounding the output (two positions, shown in red).

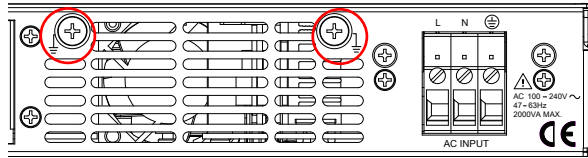

Configuration Settings

Setting Normal Function Settings

The normal function settings, F-01~F-61, F-70~F-78, F-88~F-89 and F100~F122 can be easily configured with the Function key.

- Ensure the load is not connected.
- Ensure the output is off.
- Function settings F-90~97 can only be viewed.



Note

Function setting F-89 (Show Version) can only be viewed, not edited.

Configuration settings F-90~ F-97 cannot be edited in the Normal Function Settings. Use the Power On Configuration Settings. See page 24 for details.

Steps

1. Press the Function key. The function key will light up.

Function



2. The display will show F-01 on the left and the configuration setting for F-01 on the right.

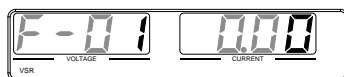

3. Rotate the voltage knob to change the F setting.

Range F-00~F-61, F-70~F-78, F-88~F-97, F100~F122

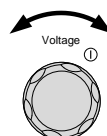

4. Use the current knob to set the parameter for the chosen F setting.

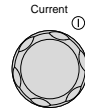

Press the Voltage knob to save the configuration setting. ConF will be displayed when it is configuring.

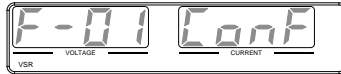
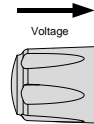

Exit

Press the Function key again to exit the configuration settings. The function key light will turn off.



Setting Power On Configuration Settings

Background The Power On configuration settings can only be changed during power up to prevent the configuration settings being inadvertently changed.

- Ensure the load is not connected.
- Ensure the power supply is off.

Steps 1. Hold the Function key whilst turning the power on.

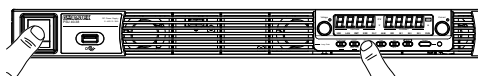

2. The display will show F-90 on the left and the configuration setting for F-90 on the right.

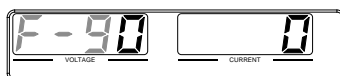

3. Rotate the voltage knob to change the F setting.

Range F-90 ~ F-97

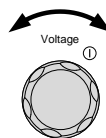

4. Use the current knob to set the parameter for the chosen F setting.

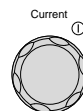

Press the Voltage knob to save the configuration setting. ConF will be displayed when it is configuring.

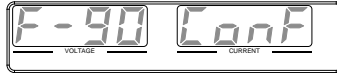
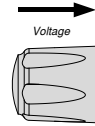

Exit

Cycle the power to save and exit the configuration settings.

Configuration Table

Please use the configuration settings listed below when applying the configuration settings.



Normal Function Settings	Setting	Setting Range
Output ON delay time	F-01	0.00s~99.99s
Output OFF delay time	F-02	0.00s~99.99s
V-I mode slew rate select	F-03	0 = CV high speed priority (CVHS) 1 = CC high speed priority (CCHS) 2 = CV slew rate priority (CVLS) 3 = CC slew rate priority (CVLS)
Rising voltage slew rate	F-04	0.001~0.060V/msec (PSU 6-200) 0.001~0.080V/msec (PSU 8-180) 0.001~0.125V/msec (PSU 12.5-120) 0.001~0.150V/msec (PSU 15-100) 0.001~0.200V/msec (PSU 20-76) 0.001~0.300V/msec (PSU 30-50) 0.001~0.400V/msec (PSU 40-38) 0.001~0.500V/msec (PSU 50-30) 0.001~0.600V/msec (PSU 60-25) 0.001~0.800V/msec (PSU 80-19) 0.001~1.000V/msec (PSU 100-15) 0.001~1.500V/msec (PSU 150-10) 0.001~1.500V/msec (PSU 300-5) 0.001~2.000V/msec (PSU 400-3.8) 0.001~2.400V/msec (PSU 600-2.6)
Falling voltage slew rate	F-05	0.001~0.060V/msec (PSU 6-200) 0.001~0.080V/msec (PSU 8-180) 0.001~0.125V/msec (PSU 12.5-120) 0.001~0.150V/msec (PSU 15-100) 0.001~0.200V/msec (PSU 20-76) 0.001~0.300V/msec (PSU 30-50) 0.001~0.400V/msec (PSU 40-38) 0.001~0.500V/msec (PSU 50-30) 0.001~0.600V/msec (PSU 60-25) 0.001~0.800V/msec (PSU 80-19) 0.001~1.000V/msec (PSU 100-15) 0.001~1.500V/msec (PSU 150-10)



		0.001~1.500V/msec (PSU 300-5)
		0.001~2.000V/msec (PSU 400-3.8)
		0.001~2.400V/msec (PSU 600-2.6)
Rising current slew rate	F-06	0.001~2.000A/msec (PSU 6-200)
		0.001~1.800A/msec (PSU 8-180)
		0.001~1.200A/msec (PSU 12.5-120)
		0.001~1.000A/msec (PSU 15-100)
		0.001~0.760A/msec (PSU 20-76)
		0.001~0.500A/msec (PSU 30-50)
		0.001~0.380A/msec (PSU 40-38)
		0.001~0.300A/msec (PSU 50-30)
		0.001~0.250A/msec (PSU 60-25)
		0.001~0.190A/msec (PSU 80-19)
		0.001~0.150A/msec (PSU 100-15)
		0.001~0.100A/msec (PSU 150-10)
		0.001~0.025A/msec (PSU 300-5)
		0.001~0.008A/msec (PSU 400-3.8)
		0.001~0.006A/msec (PSU 600-2.6)
Falling current slew rate	F-07	0.001~2.000A/msec (PSU 6-200)
		0.001~1.800A/msec (PSU 8-180)
		0.001~1.200A/msec (PSU 12.5-120)
		0.001~1.000A/msec (PSU 15-100)
		0.001~0.760A/msec (PSU 20-76)
		0.001~0.500A/msec (PSU 30-50)
		0.001~0.380A/msec (PSU 40-38)
		0.001~0.300A/msec (PSU 50-30)
		0.001~0.250A/msec (PSU 60-25)
		0.001~0.190A/msec (PSU 80-19)
		0.001~0.150A/msec (PSU 100-15)
		0.001~0.100A/msec (PSU 150-10)
		0.001~0.025A/msec (PSU 300-5)
		0.001~0.008A/msec (PSU 400-3.8)
		0.001~0.006A/msec (PSU 600-2.6)
Internal resistance setting	F-08	0~0.030Ω (PSU 6-200)
		0~0.044Ω (PSU 8-180)
		0~0.104Ω (PSU 12.5-120)
		0~0.150Ω (PSU 15-100)
		0~0.263Ω (PSU 20-76)
		0~0.600Ω (PSU 30-50)
		0~1.053Ω (PSU 40-38)

		0~1.667Ω (PSU 50-30)
		0~2.400Ω (PSU 60-25)
		0~4.210Ω (PSU 80-19)
		0~6.667Ω (PSU 100-15)
		0~15.00Ω (PSU 150-10)
		0~60.00Ω (PSU 300-5)
		0~105.3Ω (PSU 400-3.8)
		0~230.8Ω (PSU 600-2.6)
Bleeder circuit control	F-09	0 = OFF, 1 = ON, 2 = AUTO
Buzzer ON/OFF control	F-10	0 = OFF, 1 = ON
OCP Delay Time	F-12	0.1 ~ 2.0 sec
Current Setting Limit (I-Limit)	F-13	0 = OFF, 1 = ON
Voltage Setting Limit (V-Limit)	F-14	0 = OFF, 1 = ON
Display memory parameter when recalling (M1, M2, M3)	F-15	0 = OFF, 1 = ON
Auto Calibration Parallel Control	F-16	0 = Disable, 1 = Enable, 2 = Execute Parallel Calibration and set to Enable. Note: Must be a short between each unit before starting.
Measurement Average Setting	F-17	0 = Low, 1 = Middle, 2 = High
Alarm Recovery and Output Status	F-18	0 = Safe Mode, 1 = Force Mode
Lock Mode	F-19	0:Lock Panel, Allow Output OFF 1:Lock Panel, Allow Output ON/OFF
USB/GPIB settings		
Show front panel USB status	F-20	0 = None, 1 = Mass Storage
Show rear panel USB status	F-21	0 = None, 1 = Linking to PC
Setup rear USB Speed	F-22	0 = Disable USB, 1 = Full Speed, 2 = Auto Detect Speed
GPIB Address	F-23	0 ~ 30
GPIB Enable/Disable	F-24	0 = Disable GPIB, 1 = Enable GPIB
Show GPIB available status	F-25	0 = No GPIB, 1 = GPIB is available
SCPI Emulation	F-26	0 = GW Instek, 1 = TDK GEN, 2 =

Agilent 5700, 3 = Kikusui PWX, 4 = AMREL SPS*

LAN settings		
Show MAC Address-1	F-30	0x00~0xFF
Show MAC Address-2	F-31	0x00~0xFF
Show MAC Address-3	F-32	0x00~0xFF
Show MAC Address-4	F-33	0x00~0xFF
Show MAC Address-5	F-34	0x00~0xFF
Show MAC Address-6	F-35	0x00~0xFF
LAN Enable	F-36	0 = OFF, 1 = ON
DHCP	F-37	0 = OFF, 1 = ON
IP Address-1	F-39	0~255
IP Address-2	F-40	0~255
IP Address-3	F-41	0~255
IP Address-4	F-42	0~255
Subnet Mask-1	F-43	0~255
Subnet Mask-2	F-44	0~255
Subnet Mask-3	F-45	0~255
Subnet Mask-4	F-46	0~255
Gateway-1	F-47	0~255
Gateway-2	F-48	0~255
Gateway-3	F-49	0~255
Gateway-4	F-50	0~255
DNS address -1	F-51	0~255
DNS address -2	F-52	0~255
DNS address-3	F-53	0~255
DNS address-4	F-54	0~255
Socket Server Enable/Disable	F-57	0 = Disable, 1 = Enable
Show Socket Server Port	F-58	No setting
Web Server Enable/Disable	F-59	0 = Disable, 1 = Enable
Web Password Enable/Disable	F-60	0 = Disable, 1 = Enable
Web Enter Password	F-61	0000~9999
UART Settings		
UART Mode	F-70	0 = Disable UART, 1 = RS232, 2 = RS485 4W, 3 = RS485 2W

UART Baud Rate	F-71	0 = 1200, 1 = 2400, 2 = 4800, 3 = 9600, 4 = 19200, 5 = 38400, 6 = 57600, 7 = 115200
UART Data Bits	F-72	0 = 7 bits, 1 = 8 bits
UART Parity	F-73	0 = None, 1 = Odd, 2 = Even
UART Stop Bit	F-74	0 = 1 Bit, 1 = 2 Bits
UART TCP	F-75	0 = SCPI, 1 = TDK (emulation mode)
UART Address (For multi-unit remote control)	F-76	00 ~ 30
UART Multi-Drop control	F-77	0 = Disable, 1 = Master, 2 = Slave, 3 = Display information
UART Multi-Drop status	F-78	Displayed parameter: AA-S AA: 00~30 (Address), S: 0~1 (Off-line/On-line status).
System Settings		
Factory Set Value	F-88	0 = None 1 = Return to factory default settings
Show Version	F-89	0, 1 = Version 2, 3, 4, 5 = Build date (YYYYMMDD) 6, 7 = Keyboard CPLD 8, 9 = Analog Board CPLD A, B = Analog Board FPGA C, D, E, F = Kernel Build (YYYYMMDD) G, H = Test Command Version I, J, K, L = Test Command Build (YYYYMMDD) M, N = Reserved O, P = Option Module
Power On Configuration Settings*		
CV Control	F-90	0 = Control by Local 1 = Control by External Voltage 2 = Control by External Resistor - Rising  3 = Control by External Resistor - Falling  4 = Control by Isolated Board

CC Control	F-91	0 = Control by Local 1 = Control by External Voltage 2 = Control by External Resistor - Rising  3 = Control by External Resistor - Falling  4 = Control by Isolated Board
Output Status when Power ON	F-92	0 = Safe Mode (Always OFF), 1 = Force Mode (Always ON), 2 = Auto Mode (Status before last time power OFF)
Master/Slave Configuration	F-93	0 = Independent 1 = Master with 1 slave in parallel 2 = Master with 2 slaves in parallel 3 = Master with 3 slaves in parallel 4 = Slave (parallel)
External Output Logic	F-94	0 = High ON, 1 = Low ON
Monitor Voltage Select	F-96	0 = 5V , 1 = 10V
Control Range	F-97	0 = 5V [5kΩ], 1 = 10V [10kΩ]
External Output Control Function	F-98	0 = OFF, 1 = ON
Trigger Input and Output Configuration Settings		
Trigger Input Pulse Width	F100	0~60ms. 0 = trigger controlled by trigger level.
Trigger Input Action	F102	0 = None 1 = Output ON/OFF (refer to F103) 2 = Setting (refer to F104 & F105) 3 = Memory (refer to F106)
Output State When Receiving Trigger	F103	0 = OFF 1 = ON
Apply Voltage Setting on Trigger	F104	0 ~ rated voltage (only applicable when F102 =2)
Apply Current Setting on Trigger	F105	0 ~ rated current (only applicable when F102 =2)
Recall memory number	F106	1 ~ 3 (M1 ~ M3)
Trigger Output Pulse Width	F120	0 ~ 60ms. 0 = trigger output is set to the active level, not pulse width.
Trigger Output Level	F121	0 = LOW, 1 = HIGH (if F120 = 0)

Trigger Source	F122	0 = None 1 = Switching the output on or off 2 = Changing a setting 3 = Recalling a memory
Special Function Settings*		
Calibration	F-00	0000 ~ 9999

***Note**

Power on configuration settings only can be set during power up. Under normal operation they only can be viewed.

REMOTE CONTROL

This chapter describes basic configuration of IEEE488.2 based remote control.

Interface Configuration	35
USB Remote Interface	35
Configuration	35
Function Check	36
GPIB Remote Interface	37
Configuration	37
GPIB Function Check.....	38
UART Remote Interface.....	42
Configure UART	42
UART Function Check	46
Multiple Unit Connection.....	47
Legacy Multi-Drop mode	47
Multi-Drop mode	51
Multiple units Function Check	55
Configure Ethernet Connection.....	59
Web Server Configuration	59
Web Server Remote Control Function Check	60
Sockets Server Configuration.....	62
Socket Server Function Check.....	63
Command Syntax.....	68
Command List	71
Status Register Overview	139
Introduction to the Status Registers	139
The Status Registers.....	140
Questionable Status Register Group	141
Operation Status Register Group	145
Standard Event Status Register Group	148
Status Byte Register & Service Request Enable Register	150
Error List	152
Command Errors	152
Execution Errors	156

Device Specific Errors.....	158
Query Errors	159

Interface Configuration

USB Remote Interface

Configuration

USB Configuration	PC side connector	Type A, host
	PSU side connector	Rear panel Type B, slave
	Speed	1.1/2.0 (full speed/high speed)
	USB Class	CDC (communications device class)

Steps

1. Connect the USB cable to the rear panel USB B port.

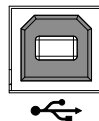

2. Change the Rear panel-USB (F-22) setting to 2 (Auto Detect Speed) or 1 (USB Full Speed). Page 22
-



Note

- If you are not using the rear panel USB device port, set F-22 to 0 (Disable USB). Page 22
-

3. The RMT indicator will turn on when a remote connection has been established.

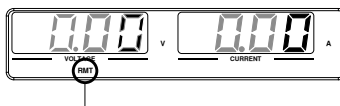

RMT indicator

Function Check

Functionality check

Invoke a terminal application such as Realterm.

To check the COM port No., see the Device Manager in the PC. For WinXP; Control panel → System → Hardware tab.

Run this query command via the terminal application after the instrument has been configured for USB remote control (page 35).

```
*idn?
```

This should return the Manufacturer, Model number, Serial number, and Firmware version in the following format.

```
GW-INSTEK,PSU40-38,TW123456,T0.01.12345678
```

```
Manufacturer: GW-INSTEK
```

```
Model number : PSU40-38
```

```
Serial number : TW123456
```

```
Firmware version : T0.01.12345678
```

GPIB Remote Interface

Configuration

To use GPIB, the optional GPIB option (GW Instek part number: PSU-GPIB) must be installed. This is a factory installed option and cannot be installed by the end-user. Only one GPIB address can be used at a time.

- Configure GPIB
1. Ensure the PSU is off before proceeding.
 2. Connect a GPIB cable from a GPIB controller to the GPIB port on the PSU.
 3. Turn the PSU on.
 4. Press the Function key to enter the Page 22 Normal configuration settings.
 5. Set the following GPIB settings.

F-24 = 1	Enable the GPIB port
F-23 = 0~30	Set the GPIB address (0~30)
 6. Check to see that the GPIB option is detected by the PSU. The F-25 setting indicates the GPIB port status.

F-25 = 1	Indicates that the GPIB port is available.
F-25 = 0	Indicates that the GPIB port is not detected.

- The RMT indicator will turn on when a remote connection has been established.

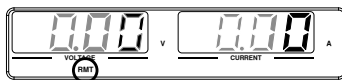

RMT indicator

-
- GPIB constraints
- Maximum 15 devices altogether, 20m cable length, 2m between each device
 - Unique address assigned to each device
 - At least 2/3 of the devices turned On
 - No loop or parallel connection

GPIB Function Check

Background To test the GPIB functionality, National Instruments Measurement and Automation Explorer can be used. This program is available on the NI website, www.ni.com, via a search for the VISA Run-time Engine page, or “downloads” at the following URL, <http://www.ni.com/visa/>

Requirements Operating System: Windows XP, 7, 8

Functionality check

1. Start the NI Measurement and Automation Explorer (MAX) program. Using Windows, press:

Start>All Programs>National Instruments>Measurement & Automation

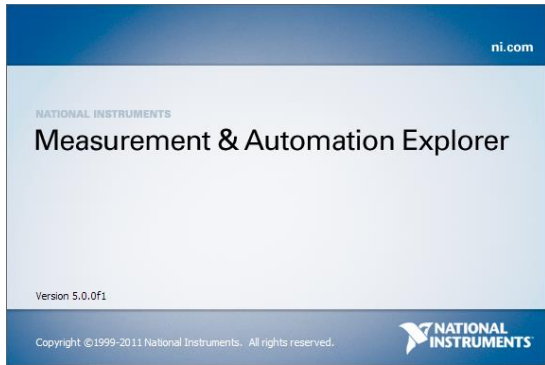

2. From the Configuration panel access; *My System>Devices and Interfaces>GPIB*
3. Press *Scan for Instruments*.

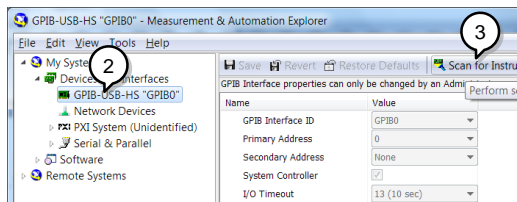

4. Select the device (GPIB address of PSU) that now appears in the *System>Devices and Interfaces > GPIB-USB-HS "GPIBX"* node.
5. Click on the *VISA Properties* tab on the bottom.
6. Click *Open Visa Test Panel*.

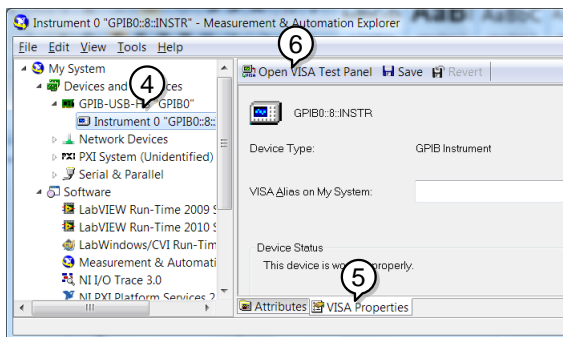

7. Click on *Configuration*.
8. Click on the *GPIB Settings* tab and confirm that the GPIB settings are correct.

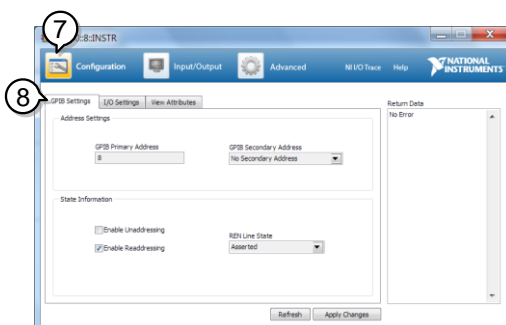

9. Click on the *I/O Settings* tab.
10. Make sure the *Enable Termination Character*

check box is checked, and the terminal character is \n (Value: xA).

11. Click *Apply Changes*.

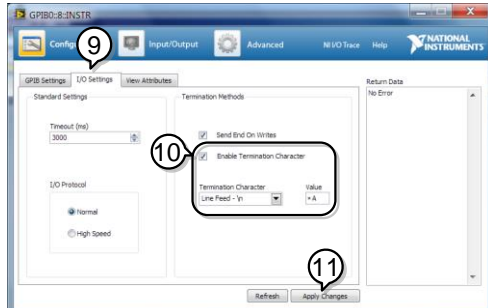

12. Click on *Input/Output*.

13. Click on the *Basic/IO* tab.

14. Enter *IDN? in the *Select or Enter Command* drop down box.

15. Click *Query*.

16. The *IDN? query will return the Manufacturer, model name, serial number and firmware version in the dialog box.

GW-INSTEK,PSU40-38,
TW123456,T0.02.20131205

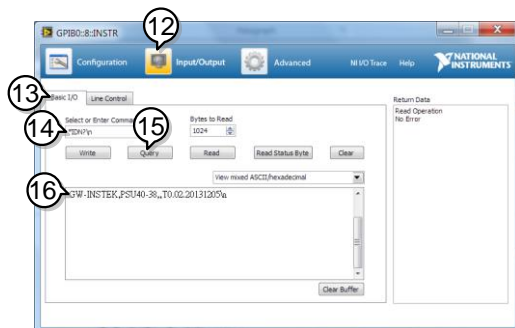

UART Remote Interface

Configure UART

Overview

The PSU uses the IN & OUT ports for UART communication coupled with RS232 (GW Part number PSU-232) or RS485 adapters (GW part number PSU-485).

The pin outs for the adapters are shown below.

PSU-232 RS232 cable with DB9 connector

DB-9 Connector			Remote IN Port(RJ-45)		Remark
Pin No.	Name		Pin No.	Name	
Housing	Shield	↔	Housing	Shield	
2	RX	↔	7	TX	Twisted pair
3	TX	↔	8	RX	
5	SG	↔	1	SG	

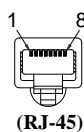
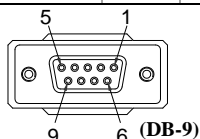

PSU-485 RS485 cable with DB9 connector

DB-9 Connector			Remote IN Port(RJ-45)		Remark
Pin No.	Name		Pin No.	Name	
Housing	Shield	↔	Housing	Shield	
9	TXD-	↔	6	RXD-	Twisted pair
8	TXD+	↔	3	RXD+	
1	SG	↔	1	SG	
5	RXD-	↔	5	TXD-	Twisted pair
4	RXD+	↔	4	TXD+	

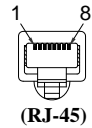
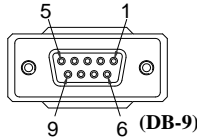

To use RS485-2W, please refer to this wiring

User's RS485-2W		DB-9 Connector (PSU-485 RS485 cable with DB9 connector)	
Name		Pin No.	Name
		Housing	Shield
DATA+	↔	8	TXD+
	↔	4	RXD+
SG	↔	1	SG
DATA-	↔	9	TXD-
	↔	5	RXD-

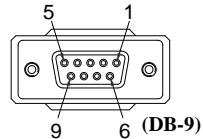

Diagram of End terminal connector



End terminal connector from PSU-232 or PSU-485 connection kit.	End terminal connector	
	8 Pin Connector	
	Pin No.	Remarks
	3	Internal shorted
	7	
4	Internal shorted	
8		

Steps

1. Connect the RS232 serial cable (include in the PSU-232 connection kit) or RS485 serial cable (include in the PSU-485 connection kit) to the Remote IN port on the real panel.

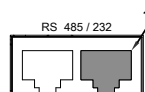

Connect the other end of the cable to the PC.

2. Connect the end terminal connector (include in the PSU-232 or RS-485 connection kit) to the Remote OUT port on the rear panel.

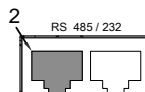

3. Press the Function key to enter the Normal configuration settings. Page 4

Set the following UART settings:

F-70 = 1~3	Interface: 0= Disable UART, 1=RS232, 2=RS485 4W, 3=RS485 2W
F-71 = 0 ~ 7	Set the baud rate: 0=1200, 1=2400, 2=4800, 3=9600, 4=19200, 5=38400, 6=57600, 7=115200

F-72 = 0 or 1	Data bits: 0=7 or 1=8
F-73 = 0 ~3	Parity: 0 = none, 1 = odd, 2 = even
F-74 = 0 or 1	Stop bits: 0 = 1, 1 = 2
F-75 = 0	TCP: 0 = SCPI
F-76 = 00~30	UART address for multi-unit remote connection.
F-77 = 0	Disable Multi-Drop mode.

4. The RMT indicator will turn on when a remote connection has been established.

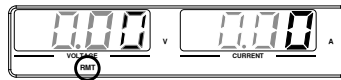

RMT indicator

UART Function Check

Functionality check Invoke a terminal application such as Realterm.

To check the COM port No, see the Device Manager in the PC. For WinXP; Control panel → System → Hardware tab.

Run this query command via the terminal application after the instrument has been configured for either RS232 or RS485 remote control.

SCPI commands

Command or response	Status
*IDN?	Typing
GW-INSTEK,PSU40-38,TW123456, T0.01.12345678	Return
Return the manufacturer, model, serial number, and firmware version in the above format.	Note
Manufacturer: GW-INSTEK	
Model: PSU40-38	
Serial number: TW123456	
Firmware version: T0.01.12345678	

Multiple Unit Connection

The PSU power supplies can have up to 31 units daisy chained together using the 8 pin connectors (IN OUT ports) on the rear panel. The first unit (master) in the chain is remotely connected to a PC using RS232 or RS485 (Legacy Multi-Drop mode), or USB, GPIB or LAN (Multi-Drop mode). Each subsequent unit (slave) is daisy chained to the next using a RS485 local bus. The OUT port of the first unit must be connected to intermediate connector and the OUT port of the last unit must be connected to end terminal connector.

There are two modes for controlling multiple units. In the first mode (Legacy Multi-Drop mode), the PC is only allowed to use RS232 or RS485 to connect to the first device, and all UART parameters must be executed in this mode Configuration. The remote command supports the SCPI commands or TDK GENESYS legacy commands.

In the second mode (Multi-Drop mode), the PC is allowed to connect to the first unit using USB-CDC/GPIB/LAN. In this mode, you only need to specify the Multi-Drop parameter. Remote commands only support SCPI commands.

For these two modes, each unit is assigned a unique address, which can then be controlled independently of the host PC.

Legacy Multi-Drop mode

- Operation
1. Check the F-89 (System version and build date) settings first on all units. The two parameters O and P (Option Module) must be the same on all units before any multiple unit connection can be established.

Example: F-89 O:00, P:01.

2. Connect the first unit's IN port to a PC via RS232 or RS485 serial cable.
 - Use the serial cables supplied in the PSU-

232 or PSU-485 connection kit.

3. Plug in intermediate connector to the OUT port on the first unit then using the slave serial link cable (black plug) to connect intermediate connector to the IN port of the second unit.
4. Connect all the remaining units in the same fashion until all the units have been daisy-chained together.

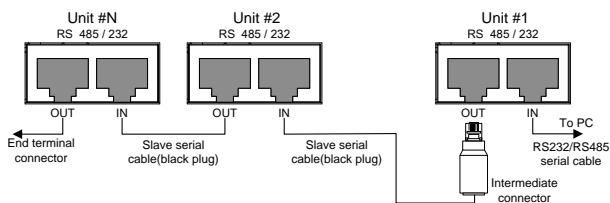

5. Terminate the OUT port of the last unit with the end terminal connector included in the PSU-232 or PSU-485 connection kit.
6. Press the Function key to enter the Page 4 Normal configuration settings for the master unit.

Set the following settings:

F-70 = 1~3	Configure the master unit as you normally would for RS232 or RS485 remote control, see page 42.
F-71 = 0~7	Set the baud rate (set all units the same). See page 42.
F-72 = 1	Set to 8 data bits.
F-73 = 0	Parity to none.
F-74 = 0	1 Stop bit.

F-75 = 0 or 1	F-75 = 0 Set the UART TCP to SCPI. F-75 = 1 Set the UART TCP to TDK (emulation mode).
F-76 = 00~30	Set the address of the master unit. It must be a unique address identifier.
F-77 = 0	Disable Multi-Drop mode.

7. Press the Function key to enter the Normal configuration settings for the slave(s). Page 4

Set the following settings:

F-70 = 2~3 Set the slave unit to RS485.

Connect to PC using	F-70 (Master)	F-70 (All slave)
RS232	1	2
RS485 4W	2	2
RS485 2W	3	3

F-71 = 0~7 Set the baud rate (make all units, including the master, the same baud). See page 42.

F-72 = 1 Set to 8 data bits.

F-73 = 0 Parity to none.

F-74 = 0 1 Stop bit.

F-75 = 0~1
F-75 = 0
Set the UART TCP to SCPI.
F-75 = 1
Set the UART TCP to TDK (emulation mode).
Set the uart tcp (make all units, including the master, the same uart tcp).

F-76 = 00~30 Set the address of each slave to a unique address identifier

F-77 = 0 Disable Multi-Drop mode.

8. Multiple units can now be operated at the same time. See the programming manual or see the function check below for usage details.

Slave serial link cable with RJ-45 shielded connectors from PSU-232 or PSU-485 connection kit	RS-485 slave serial link pin assignment						
	8 Pin Connector (IN) (RJ-45)				8 Pin Connector (OUT) (RJ-45)		
	Pin No.	Name		Pin No.	Name		
	Housing	Shield	↔	Housing	Shield		
	1	SG	↔	1	SG		
	6	TXD -	↔	6	TXD -		
	3	TXD +	↔	3	TXD +		
	5	RXD -	↔	5	RXD -		
	4	RXD +	↔	4	RXD +		



(RJ-45)



(RJ-45)

Diagram of Intermediate connector

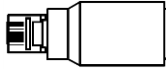

Intermediate connector from PSU-232 or PSU-485 connection kit.	Intermediate connector					
	8 Pin (Male)			8 Pin (Female)		
	Pin No.	Name		Pin No.	Name	Remarks
	Housing	Shield	↔	Case	Shield	
	1	SG	↔	1	SG	
	6	TXD -	↔	6	TXD -	Internal paralleled by 120 ohm
	3	TXD +	↔	3	TXD +	
	5	RXD -	↔	5	RXD -	Internal paralleled by 120 ohm
4	RXD+	↔	4	RXD +		

Diagram of End terminal connector

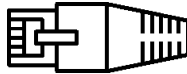

End terminal connector from PSU-232 or PSU-485 connection kit.	End terminal connector	
	8 Pin Connector	
	Pin No.	Remarks
	3	Internal shorted
	7	
4	Internal shorted	

Multi-Drop mode

Operation

1. Check the F-89 (System version and build date) settings first on all units. The two parameters O and P (Option Module) must be the same on all units before any multiple unit connection can be established.

Example: F-89 O:00, P:01.

2. All units must be powered down before starting the Multi-Drop mode configuration.

3. Connect the first unit's LAN, USB or GPIB port to a PC.
4. Plug in intermediate connector to the OUT port on the first unit then using the master serial link cable (gray plug) to connect intermediate connector to the IN port of the second unit.
5. Connect all the remaining units between the OUT port and the IN port with the slave serial link cable (black plug) supplied in the PSU-232 or PSU-485 connection kit until all the desired units have been daisy-chained together.

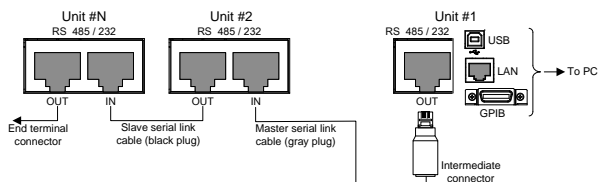

6. Terminate the OUT port of the last unit with the end terminal connector included in the PSU-232 or PSU-485 connection kit.
7. Power up all slave units.
8. Set the addresses of all slave units using the F-76 parameter.

F-76 = 00~30 Set the address of the unit. It must be a unique address identifier.
9. Set the Multi-Drop setting parameter (F-77) to Slave for all slave units.

F-77 = 2 Set the Multi-Drop setting to slave.
10. Power up the master unit.

11. Set the address of the master unit using the F-76 parameter.

F-76 = 00~30 Set the address of the unit. It must be a unique address identifier.

12. You can check the slaves' addresses by using the F-77 parameter on the master unit.

F-77 = 3 Display on each slave units the configured address. This can show if identical addresses have been assigned individually to each slave units.

13. Set the Multi-Drop setting parameter (F-77) to Master.

F-77 = 1 Set the Multi-Drop setting to master.

14. You can display the status of each slave unit by using the F-78 parameter.

F-78 = 0~30 Displayed parameter: AA-S
AA: 00~30 (Address),
S: 0~1 (Off-line/On-line status).

15. Multiple units can now be operated using SCPI commands. See the programming manual or see the function check below for usage details.
-

Slave serial link cable with RJ-45 shielded connectors from PSU-232 or PSU-485 connection kit

RS-485 slave serial link pin assignment				
8 Pin Connector (IN) (RJ-45)			8 Pin Connector (OUT) (RJ-45)	
Pin No.	Name		Pin No.	Name
Housing	Shield	↔	Housing	Shield
1	SG	↔	1	SG
6	TXD -	↔	6	TXD -
3	TXD +	↔	3	TXD +
5	RXD -	↔	5	RXD -
4	RXD +	↔	4	RXD +

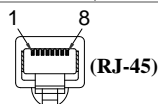
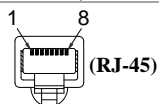

Master serial link cable with RJ-45 shielded connectors from PSU-232 or PSU-485 connection kit

RS-485 master serial link pin assignment				
8 Pin Connector (IN) (RJ-45)			8 Pin Connector (OUT) (RJ-45)	
Pin No.	Name		Pin No.	Name
Housing	Shield	↔	Housing	Shield
1	SG	↔	1	SG
6	TXD -	↔	5	RXD -
3	TXD +	↔	4	RXD +
5	RXD -	↔	6	TXD -
4	RXD +	↔	3	TXD +

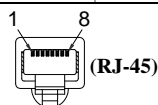
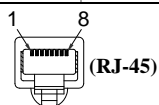
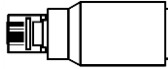

Diagram of Intermediate connector



Intermediate connector from PSU-232 or PSU-485 connection kit.	Intermediate connector					
	8 Pin (Male)			8 Pin (Female)		
	Pin No.	Name		Pin No.	Name	Remarks
		Housing	Shield	↔	Case	Shield
	1	SG	↔	1	SG	
	6	TXD -	↔	6	TXD -	Internal paralleled
	3	TXD +	↔	3	TXD +	by 120 ohm
	5	RXD -	↔	5	RXD -	Internal paralleled
4	RXD +	↔	4	RXD +	by 120 ohm	

Diagram of End terminal connector



End terminal connector from PSU-232 or PSU-485 connection kit.	End terminal connector	
	8 Pin Connector	
	Pin No.	Remarks
	3	Internal shorted
	7	
	4	Internal shorted
8		

Multiple units Function Check

Functionality check

Invoke a terminal application such as Realterm.

To check the COM port No, see the Device Manager in the PC. For WinXP; Control panel → System → Hardware tab.

Below shows examples using the Legacy Multi-Drop mode and the Multi-Drop mode.

Legacy Multi-Drop mode

When using SCPI commands or TDK GENESYS legacy commands, each unit can be individually controlled using the unique address identifiers. For this function check, we will assume that the master unit is assigned to address 8, while a slave is assigned address 11.

Run this query command via the terminal application after the instruments have been configured for multi-unit control with Legacy Multi-Drop mode. See page 47.

SCPI commands

Command or response	Status
INST:SEL 8	Typing
*IDN?	Typing
GW-INSTEK,PSU40-38,,T0.01.12345678	Return
Selects the unit with address 8 and returns its identity string.	Note
INST:SEL 11	Typing
*IDN?	Typing
GW-INSTEK,PSU6-200,,T0.01.12345678	Return
Selects the unit with address 11 and returns its identity string.	Note

TDK GENESYS legacy commands

(Because the terminal character used by the TDK GENESYS legacy command is CR instead of LF, the terminal characters are specifically listed below)

Command or response	Status
ADR 8\r	Typing
OK\r	Return
IDN? \r	Typing
GW-INSTEK,PSU40-38,,T0.01.12345678\r	Return

Selects the unit with address 8 and returns its identity string.	Note
ADR 11\r	Typing
OK\r	Return
IDN? \r	Typing
GW-INSTEK,PSU6-200,,T0.01.12345678\r	Return
Selects the unit with address 11 and returns its identity string.	Note



Note

TDK commands do not use LF (line feed) codes to terminate commands. See the TDK GENESYS user manual for further information.

Multi-Drop mode When using the Multi-Drop mode, the entire SCPI command list developed for the PSU can be used. Each unit can be individually controlled after a slave unit has been selected. For this function check, we will assume that the master unit is assigned to address 0, while a slave is assigned address 5.

Run this query command via the terminal application after the instruments have been configured for multi-unit control with Multi-Drop mode. See page 51.

SCPI commands

Command or response	Status
INST:SEL 0	Typing
*IDN?	Typing
GW-INSTEK,PSU150-10,,T0.01.12345678	Return
Selects the unit with address 0 and returns its identity string.	Note
INST:SEL 5	Typing
*IDN?	Typing

GW-INSTEK, PSU150-10,,T0.01.12345678	Return
Selects the unit with address 5 and returns its identity string.	Note
<hr/>	
INST:SEL 6	Typing
Selects the unit with address 6 (not configured in our example). An error is displayed on the master front panel.	Note
<hr/>	
INST:SEL 0	Typing
SYST:ERR?	Typing
-221, "Settings conflict"	Return
Query the system errors. "Settings conflict" is returned.	Note
<hr/>	
INST:STAT?	Typing
33,0	Return
Returns the active units and master unit in the bus.	Note
33=0b100001	
The units at address 0 and address 5 are on-line.	
0	
Master device's address is 0.	

Configure Ethernet Connection

The Ethernet interface can be configured for a number of different applications. Ethernet can be configured for basic remote control or monitoring using a web server or it can be configured as a socket server.

The PSU series supports both DHCP connections so the instrument can be automatically connected to an existing network or alternatively, network settings can be manually configured.

Ethernet configuration Parameters	For details on how to configure the Ethernet settings, please see the configuration chapter on page 4.
	MAC Address (display only) LAN Enable/Disable
	DHCP Enable/Disable IP Address
	Subnet Mask Gateway
	DNS Address Sockets Server Enable/Disable
	Web Server Enable/Disable Web Password Enable/Disable
	Web Enter Password

Web Server Configuration

Configuration This configuration example will configure the PSU as a web server and use DHCP to automatically assign an IP address to the PSU.

1. Connect an Ethernet cable from the network to the rear panel Ethernet port.

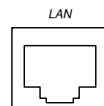

- Press the Function key to enter the Page 22 Normal configuration settings.

Set the following LAN settings:

F-36 = 1	Turn LAN on
F-37 = 1	Enable DHCP
F-59 = 1	Turn the web server on
F-60 = 0 or 1	Set to 0 to disable web password, set to 1 to enable web password
F-61 = 0000 ~9999	Set the web password

- The LAN indicator will turn on when a network cable is plugged in.

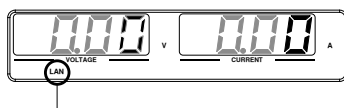

LAN indicator



Note

It may be necessary to cycle the power or refresh the web browser to connect to a network.

Web Server Remote Control Function Check

Functionality check

Enter the IP address of the power supply in a web browser after the instrument has been configured as a web server (page 59).

The web server allows you to monitor the function settings of the PSU.

You can check the IP address by checking F-39 to F-42.

F-39 = AAA	IP Address part 1 of 4
F-40 = BBB	IP Address part 2 of 4
F-41 = CCC	IP Address part 3 of 4
F-42 = DDD	IP Address part 4 of 4

http:// AAA.BBB.CCC.DDD

The web browser interface appears.



Visit Our Site

Made to Measure

Support | Contact Us

Welcome Page

Network Configuration

Analog Control

Figure of Dimensions

Operating Area

**PSU Series
Web Control Pages**

Thanks For Your Using.

Use the left menu to select the features you need.

More How-to Please refer to user manual.



System Information

Manufacturer :	GW-INSTEK
Serial Number :	
Description :	GW-INSTEK.PSU12.5-120
Firmware Version :	T1.13.20170310
Hostname :	P-
IP Address :	172.16.23.146
Subnet Mask :	255.255.128.0
Gateway :	172.16.0.254
DNS :	172.16.1.252
MAC Address :	02:80:ad:20:31:b2
DHCP State :	ON
VISA TCP/IP Connect String :	TCPIP0-172.16.23.146-2268-SOCKET

Copyright 2011 © Good Will Instrument Co., Ltd. All Rights Reserved.

The web browser interface allows you to access the following:

- Network configuration settings
- Analog control pinouts & usage
- PSU dimensions
- Operating area diagram

Sockets Server Configuration

Configuration This configuration example will configure the PSU socket server.

The following configuration settings will manually assign the PSU an IP address and enable the socket server. The socket server port number is fixed at 2268.

1. Connect an Ethernet cable from the network to the rear panel Ethernet port.

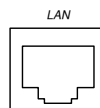

2. Press the Function key to enter the Normal configuration settings. Page 22

Set the following LAN settings:

F-36 = 1	Enable LAN
F-37 = 0	Disable DHCP
F-39 = 172	IP Address part 1 of 4
F-40 = 16	IP Address part 2 of 4
F-41 = 5	IP Address part 3 of 4
F-42 = 133	IP Address part 4 of 4
F-43 = 255	Subnet Mask part 1 of 4
F-44 = 255	Subnet Mask part 2 of 4
F-45 = 128	Subnet Mask part 3 of 4
F-46 = 0	Subnet Mask part 4 of 4
F-47 = 172	Gateway part 1 of 4
F-48 = 16	Gateway part 2 of 4
F-49 = 21	Gateway part 3 of 4
F-50 = 101	Gateway part 4 of 4
F-57 = 1	Enable Sockets

Socket Server Function Check

Background To test the socket server functionality, National Instruments Measurement and Automation Explorer can be used. This program is available on the NI website, www.ni.com, via a search for the VISA Run-time Engine page, or “downloads” at the following URL, <http://www.ni.com/visa/>

Requirements Operating System: Windows XP, 7, 8

Functionality check

1. Start the NI Measurement and Automation Explorer (MAX) program. Using Windows, press:

Start>All Programs>National Instruments>Measurement & Automation

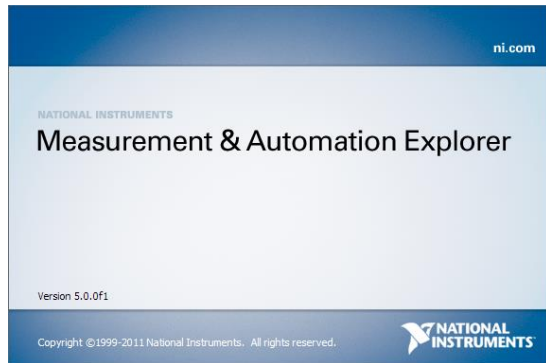

2. From the Configuration panel access;

My System>Devices and Interfaces>Network Devices

3. Press *Add New Network Device>Visa TCP/IP Resource...*

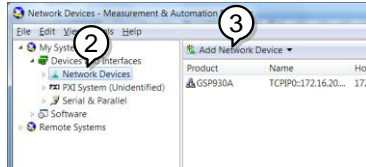

4. Select *Manual Entry of Raw Socket* from the popup window.

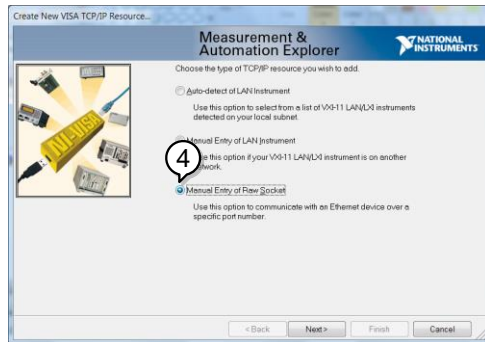

5. Enter the IP address and the port number of the PSU. The port number is fixed at 2268.
6. Click the Validate button.
7. A popup will appear if a connection is successfully established.
8. Click Next.

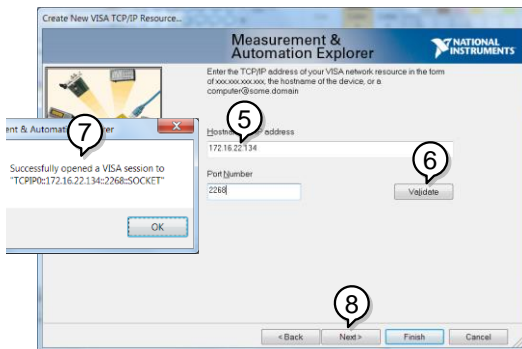

9. Next configure the Alias (name) of the PSU connection. In this example the Alias is: PSU_DC1

10. Click finish.

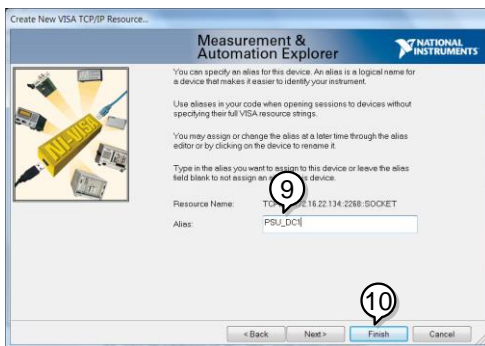

11. The IP address of the PSU will now appear under Network Devices in the configuration panel. Select this icon now.

12. Click *Open VISA Test Panel*.

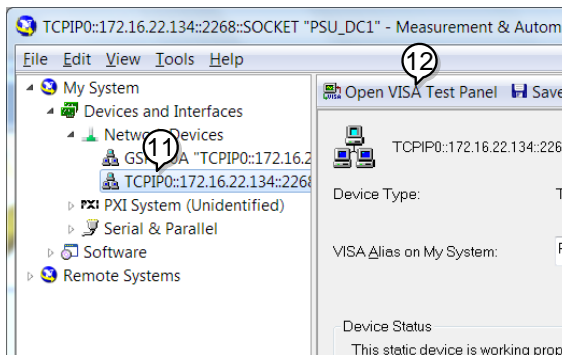

13. Click the *Configuration* icon,

14. Click on *I/O Settings*.

15. Make sure the *Enable Termination Character* check box is checked, and the terminal character is `\n` (Value: xA).

16. Click *Apply Changes*.

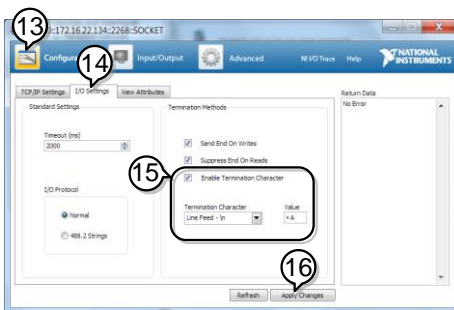

17. Click the *Input/Output* icon.

18. Enter `*IDN?` in the *Select or Enter Command* dialog box if it is not already.

19. Click the *Query* button.

20. The *IDN? query will return the Manufacturer, model name, serial number and firmware version in the dialog box.

GW-INSTEK,PSU40-38,TW123456,T0.02.20131205

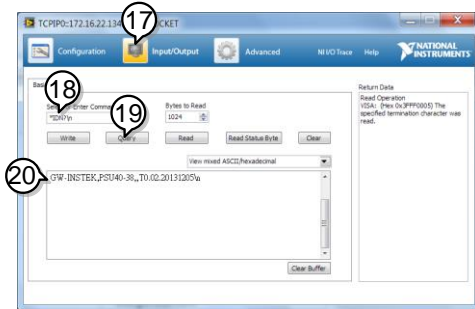

Command Syntax

Compatible Standard	IEEE488.2	Partial compatibility
	SCPI, 1999	Partial compatibility

Command Structure SCPI commands follow a tree-like structure, organized into nodes. Each level of the command tree is a node. Each keyword in a SCPI command represents each node in the command tree. Each keyword (node) of a SCPI command is separated by a colon (:).

For example, the diagram below shows an SCPI sub-structure and a command example.

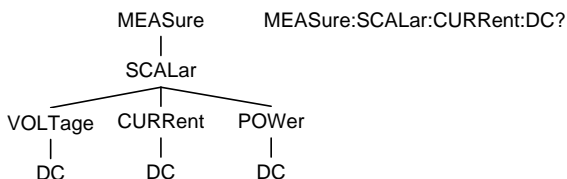

Command types There are a number of different instrument commands and queries. A command sends instructions or data to the unit and a query receives data or status information from the unit.

Command types

Simple A single command with/without a parameter

Example *IDN?

Query A query is a simple or compound command followed by a question mark (?). A parameter (data) is returned.

Example meas:curr:dc?

Compound Two or more commands on the same command line. Compound commands are separated with either a semi-colon (;) or a semi-colon and a colon (;;).

A semi-colon is used to join two related commands, with the caveat that the last command must begin at the last node of the first command.

A semi-colon and colon are used to combine two commands from different nodes.

Example meas:volt:dc?;;meas:curr:dc?

Command Forms Commands and queries have two different forms, long and short. The command syntax is written with the short form of the command in capitals and the remainder (long form) in lower case.

The commands can be written in capitals or lower-case, just so long as the short or long forms are complete. An incomplete command will not be recognized.

Below are examples of correctly written commands.

Long form STATus:OPERation:NTRansition?
 STATUS:OPERATION:NTRANSITION?
 status:operation:ntransition?

Short form STAT:OPER:NTR?
 stat:oper:ntr?

Square Brackets Commands that contain square brackets indicate that the contents are optional. The function of the command is the same with or without the square bracketed items, as shown below.

Both "DISPlay:MENU[:NAME]?" and "DISPlay:MENU?" are both valid forms.

Command Format

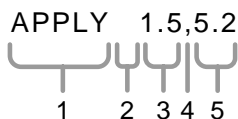

1. Command header
2. Space
3. Parameter 1
4. Comma (no space before/after comma)
5. Parameter 2

Parameters

Type	Description	Example
<Boolean>	Boolean logic	0, 1
<NR1>	integers	0, 1, 2, 3
<NR2>	decimal numbers	0.1, 3.14, 8.5
<NR3>	floating point	4.5e-1, 8.25e+1
<NRf>	any of NR1, 2, 3	1, 1.5, 4.5e-1
<block data>	Definitive length arbitrary block data. A single decimal digit followed by data. The decimal digit specifies how many 8-bit data bytes follow.	

Message Terminator

LF Line feed code

Command List

:ABORt	:ABORt	75
:APPLY	:APPLy	75
Commands		
Display	:DISPlay:MENU[:NAME]	76
Commands	:DISPlay[:WINDow]:TEXT:CLEAr	76
	:DISPlay[:WINDow]:TEXT[:DATA]	77
	:DISPlay:BLINK	77
Initiate	:INITiate:CONTInuous[:TRANSient]	78
Commands	:INITiate[:IMMEdiate]:NAME	78
	:INITiate[:IMMEdiate][:TRANSient]	79
Instrument	:INSTRument:SCAN	80
Commands	:INSTRument:SELEct	80
	:INSTRument:STATe	80
	:INSTRument:DISPlay	81
Measure	:MEASure[:SCALAr]:ALL[:DC]	82
Commands	:MEASure[:SCALAr]:CURREnt[:DC]	82
	:MEASure[:SCALAr]:VOLTage[:DC]	82
	:MEASure[:SCALAr]:POWEr[:DC]	83
Memory	:MEMory:TRIGgered	84
Output	:OUTPut:DELAy:ON	85
Commands	:OUTPut:DELAy:OFF	85
	:OUTPut:MODE	86
	:OUTPut[:STATe][:IMMEdiate]	86
	:OUTPut[:STATe]:TRIGgered	86
	:OUTPut:PROTEction:CLEAr	87
	:OUTPut:PROTEction:TRIPped	87

Sense	:SENSe:AVERAge:COUNT	88
Commands		
Status	:STATus:OPERation[:EVENT]	89
Commands	:STATus:OPERation:CONDition	89
	:STATus:OPERation:ENABle	90
	:STATus:OPERation:PTRansition	90
	:STATus:OPERation:NTRansition	90
	:STATus:QUEStionable[:EVENT]	91
	:STATus:QUEStionable:CONDition	91
	:STATus:QUEStionable:ENABle	91
	:STATus:QUEStionable:PTRansition	91
	:STATus:QUEStionable:NTRansition	92
	:STATus:QUEStionable:INSTrument:	
	ISUMmary<n>[:EVENT]	92
	:STATus:QUEStionable:INSTrument:	
	ISUMmary<n>:CONDition	92
	:STATus:QUEStionable:INSTrument:	
	ISUMmary<n>:ENABle	93
	:STATus:PRESet	93
Source	[:SOURce]:CURREnt[:LEVel][:IMMediate]	
Commands	[:AMPLitude]	95
	[:SOURce]:CURREnt[:LEVel]:TRIGgered	
	[:AMPLitude]	96
	[:SOURce]:CURREnt:LIMit:AUTO	96
	[:SOURce]:CURREnt:PROTEction:DELay	97
	[:SOURce]:CURREnt:PROTEction[:LEVel]	97
	[:SOURce]:CURREnt:PROTEction:STATe	98
	[:SOURce]:CURREnt:PROTEction:TRIPped	98
	[:SOURce]:CURREnt:SLEWrate:RISing	99
	[:SOURce]:CURREnt:SLEWrate:FALLing	99
	[:SOURce]:MODE?	100
	[:SOURce]:RESistance[:LEVel][:IMMediate]	
	[:AMPLitude]	100
	[:SOURce]:VOLTage[:LEVel][:IMMediate]	
	[:AMPLitude]	101
	[:SOURce]:VOLTage[:LEVel]:TRIGgered	
	[:AMPLitude]	101
	[:SOURce]:VOLTage:LIMit:AUTO	102
	[:SOURce]:VOLTage:LIMit:LOW	102
	[:SOURce]:VOLTage:PROTEction[:LEVel]	103

	[:SOURce]:VOLTage:PROTection:TRIPped	103
	[:SOURce]:VOLTage:SLEWrate:RISing	104
	[:SOURce]:VOLTage:SLEWrate:FALLing	104
System	:SYSTem:BEEPPer[:IMMediate].....	107
Commands	:SYSTem:CONFigure:BEEPPer[:STATe]	108
	:SYSTem:CONFigure:BLEeder[:STATe].....	108
	:SYSTem:CONFigure:CURREnt:CONTRol.....	109
	:SYSTem:CONFigure:VOLTage:CONTRol	110
	:SYSTem:CONFigure:OUTPut:PON[:STATe]	111
	:SYSTem:CONFigure:PROTection:RECOvery.....	112
	:SYSTem:CONFigure:MSLave.....	112
	:SYSTem:CONFigure:OUTPut:EXTernal:MODE	113
	:SYSTem:CONFigure:OUTPut:EXTernal[:STATe]	113
	:SYSTem:CONFigure:MONitor:RANGe	114
	:SYSTem:CONFigure:CONTRol:RANGe	114
	:SYSTem:CONFigure:TRIGger:INPut:SOURce.....	115
	:SYSTem:CONFigure:TRIGger:INPut:WIDTh	116
	:SYSTem:CONFigure:TRIGger:OUTPut:SOURce	116
	:SYSTem:CONFigure:TRIGger:OUTPut:WIDTh	117
	:SYSTem:CONFigure:TRIGger:OUTPut:LEVel	117
	:SYSTem:COMMunicate:ENABle	117
	:SYSTem:COMMunicate:GPIB[:SELf]:ADDReSS.....	118
	:SYSTem:COMMunicate:LAN:IPADdress.....	119
	:SYSTem:COMMunicate:LAN:GATeway	119
	:SYSTem:COMMunicate:LAN:SMASK	120
	:SYSTem:COMMunicate:LAN:MAC.....	120
	:SYSTem:COMMunicate:LAN:DHCP	120
	:SYSTem:COMMunicate:LAN:DNS	121
	:SYSTem:COMMunicate:RLState	121
	:SYSTem:COMMunicate:TCPip:CONTRol	122
	:SYSTem:COMMunicate:SERial:LANGUage	
	[:SELect]	122
	:SYSTem:COMMunicate:SERial[:RECeive]	
	:TRANsmit:BAUD	123
	:SYSTem:COMMunicate:SERial[:RECeive]	
	:TRANsmit:BITS	123
	:SYSTem:COMMunicate:SERial[:RECeive]	
	:TRANsmit:PARity	124
	:SYSTem:COMMunicate:SERial[:RECeive]	
	:TRANsmit:SBITS.....	125
	:SYSTem:COMMunicate:SERial:MULTidrop	
	:CONTRol.....	126

	:SYSTem:COMMunicate:USB:FRONt:STATe	126
	:SYSTem:COMMunicate:USB:REAR:MODE	126
	:SYSTem:COMMunicate:USB:REAR:STATe	127
	:SYSTem:ERRor	127
	:SYSTem:KLOCK	127
	:SYSTem:KEYLock:MODE	128
	:SYSTem:ERRor:ENABle	128
	:SYSTem:LANGuage:EMULation	128
	:SYSTem:LANGuage:[:SELect]	128
	:SYSTem:PRESet	129
	:SYSTem:VERSion	129
	:SYSTem:REBoot	129
Trigger	:TRIGger:OUTPut:SOURce	130
Commands	:TRIGger:OUTPut[:IMMediate]	130
	:TRIGger[:TRANsient]:SOURce	131
	:TRIGger[:TRANsient][:IMMediate]	131
Global	:GLOBal:CURRent[:LEVel][:IMMediate]	
Commands	[:AMPLitude]	132
	:GLOBal:VOLTag[:LEVel][:IMMediate]	
	[:AMPLitude]	132
	:GLOBal:OUTPut[:STATe][:IMMediate]	133
	:GLOBal:PRESet	133
Common	*CLS	134
Commands	*ESE	134
	*ESR	135
	*IDN	135
	*OPC	135
	*RCL	136
	*RST	136
	*SAV	136
	*SRE	137
	*STB	137
	*TRG	137
	*TST	137
	*WAI	138

Abort Commands

:ABORt 75

:ABORt (Set) →

Description The :ABORt command will cancel any triggered actions.

Syntax :ABORt

Apply Commands

:APPLy 75

:APPLy (Set) →
→ (Query)

Description The apply command sets the voltage and current at the same time.

Syntax :APPLy
{<NRf>(V)|MINimum|MAXimum[,<NRf>(A)|MINimum|MAXimum]}

Query Syntax :APPLy?

Parameter/ Return parameter	<NRf>(V)	Voltage setting.
	MINimum	Minimum voltage level
	MAXimum	Maximum voltage level
	<NRf>(A)	Current setting.
	MINimum	Minimum voltage level
	MAXimum	Maximum voltage level

Example APPL MIN, MIN
Sets the current and voltage to the minimum settings.

Display Commands

:DISPlay:MENU[:NAME]	76
:DISPlay:WINDow]:TEXT:CLEar	76
:DISPlay:WINDow]:TEXT[:DATA]	77
:DISPlay:BLINK	77

:DISPlay:MENU[:NAME]

Set →
 → Query

Description	The DISPlay MENU command selects a screen menu or queries the current screen menu.	
Syntax	:DISPlay:MENU[:NAME] <NR1>	
Query Sytax	:DISPlay:MENU[:NAME]?	
Parameter/ Return parameter	<NR1>	Description
	0	Measure voltage & current
	1~2	Not Used
	3	Set Menu
	4	OVP / OCP Menu
	5~99	Not Used.
	100~199	F-00~99 Menu.
	200~229	F100~F129 Menu.

Example DISP:MENU:NAME 0
 Sets the display to the Voltage/Current display screen.

:DISPlay[:WINDow]:TEXT:CLEar

Set →

Description	Clears the text on the main screen from the :DISPlay[:WINDow]:TEXT[:DATA] command.
Syntax	:DISPlay[:WINDow]:TEXT:CLEar

:DISPlay[:WINDow]:TEXT[:DATA]



Description	Sets or queries the data text that will be written to the display. Writing to the display will overwrite data that is currently on the screen. Overwriting a display area with a shorter string may or may not overwrite the screen. The string must be enclosed in quotes: "STRING". Only ASCII characters 20H to 7EH can be used in the <string>.
Syntax	:DISPlay[:WINDow]:TEXT[:DATA] <string>
Query Syntax	:DISPlay[:WINDow]:TEXT[:DATA]?
Parameter/ Return parameter	<string> ASCII character 20H to 7EH can be used to in the string parameter. The string must be enclosed in quotes: "STRING"
Example	DISP:WIND:TEXT:DATA "STRING" Writes STRING to the display.
Query Example	DISP:WIND:TEXT:DATA? "STRING" Returns the text data string on the screen.

:DISPlay:BLINK



Description	Turns blink on or off for the display. Blink is set to OFF by default.
Syntax	:DISPlay:BLINK {<bool> OFF ON}
Query Syntax	:DISPlay:BLINK?
Parameter	OFF 0 Turns blink OFF ON 1 Turns blink ON
Return parameter	<bool> Returns the blink status.
Example	DISP:BLIN 1 Turns blink ON.

Initiate Commands

:INITiate:CONTInuous[:TRANsient]	78
:INITiate[:IMMEDIATE]:NAME	78
:INITiate[:IMMEDIATE][:TRANsient]	79

:INITiate:CONTInuous[:TRANsient]

Set →
 → Query

Description	This command continuously initiates software triggers for the transient or output triggers.	
Syntax	:INITiate:CONTInuous[:TRANsient]	
Query Syntax	{<bool> OFF ON}	
	:INITiate:CONTInuous[:TRANsient]?	
Parameter	OFF 0	OFF
	ON 1	ON
Return parameter	0	OFF
	1	ON
Example	INIT:TRAN 1 Turns on the continuous trigger.	

:INITiate[:IMMEDIATE]:NAME

Set →

Description	The INITiate command starts the TRANsient or OUTPut trigger.	
Syntax	:INITiate[:IMMEDIATE]:NAME {TRANsient OUTPut}	
Parameter	TRANsient	Starts the TRANsient trigger.
	OUTPut	Starts the OUTPut trigger.
Example	INITiate:NAME TRANient Starts the TRANsient trigger.	

`:INITiate[:IMMEDIATE][:TRANSient]`

Set →

Description	This command controls the enabling of output triggers. When a trigger is enabled, a trigger causes the specified action to occur. If the trigger system is not enabled, all triggers are ignored.
Syntax	<code>:INITiate[:IMMEDIATE][:TRANSient]</code>
Example	INIT

Instrument Commands

:INSTrument:SCAN	80
:INSTrument:SELEct.....	80
:INSTrument:STATe.....	80
:INSTrument:DISPlay.....	81

:INSTrument:SCAN

Set →

Description Links the units which could be scanned from system when using Multi-Drop mode.

Syntax :INSTrument:SCAN

:INSTrument:SELEct

Set →

→ Query

Description Specifies the address of the unit to which communication will be established when using the Multi-Drop mode.

Syntax :INSTrument :SELEct {<NR1>}

Query Syntax :INSTrument :SELEct?

Parameter <NR1> The address of the unit to be selected (0~30).

Return parameter <NR1> The currently selected address.

Example :INST:SEL?
>30
The currently selected address is 30.

:INSTrument:STATe

→ Query

Description Displays the status (on-line/off-line) of each slave unit and the address of master unit, when using the Multi-Drop mode.

Query Syntax :INSTrument:STATe?

Return parameter	<code><NR1>,<NR1></code>	<p>0~1073741823, 0~30 (1073741823=2^30-1)</p> <p>First value: Each bit of the binary value corresponds to a unit from 0 to 30 (LSB to MSB). The bit will be set to 1 when the corresponding unit is on-line.</p> <p>Second value: This value represents the master address.</p>
------------------	--------------------------------------	---

Example

```
:INST:STAT?
33,0
33=0b100001
```

The units at address 0 and address 5 are on-line.

```
0
```

Master device's address is 0.

:INSTrument:DISPlay



Description	Displays information (configured address) for all slave units when using the Multi-Drop mode.
Syntax	:INSTrument:DISPlay
Example	:INST:DISP

Measure Commands

:MEASure[:SCALar]:ALL[:DC]	82
:MEASure[:SCALar]:CURRent[:DC]	82
:MEASure[:SCALar]:VOLTage[:DC]	82
:MEASure[:SCALar]:POWer[:DC]	83

:MEASure[:SCALar]:ALL[:DC] → Query

Description	Takes a measurement and returns the average output current and voltage	
Syntax	:MEASure[:SCALar]:ALL[:DC]?	
Return parameter	" +0.0000,+0.0000"	<voltage>,<current> Returns the voltage (V) and current (A), respectively.

:MEASure[:SCALar]:CURRent[:DC] → Query

Description	Takes a measurement and returns the average output current	
Syntax	:MEASure[:SCALar]:CURRent[:DC]?	
Return parameter	" +0.0000"	Returns the current in amps.

:MEASure[:SCALar]:VOLTage[:DC] → Query

Description	Takes a measurement and returns the average output voltage.	
Syntax	:MEASure[:SCALar]:VOLTage[:DC]?	
Return	" +0.0000"	Returns the voltage in volts.

:MEASure[:SCALar]:POWer[:DC]

→ Query

Description	Takes a measurement and returns the average output power.
Syntax	:MEASure[:SCALar]:POWer[:DC]?
Return	"+0.0000" Returns the power measured in watts.

Memory Commands

:MEMory:TRIGgered..... 84

:MEMory:TRIGgered

Set →

→ Query

Description	Sets or queries which memory is loaded when a trigger input is received and the trigger input is configured to load a memory setting.	
Related Commands	:SYSTem:CONFigure:TRIGger:INPut:SOURce :SYSTem:CONFigure:TRIGger:OUTPut:SOURce	
Syntax	:MEMory:TRIGgered {<NR1> MINimum MAXimum}	
Return Syntax	:MEMory:TRIGgered? [MINimum MAXimum]	
Parameter	<NR1> MINimum MAXimum	0(M1)~2(M3)
Return Parameter	<NR1>	Returns the memory setting

Output Commands

:OUTPut:DELAy:ON.....	85
:OUTPut:DELAy:OFF.....	85
:OUTPut:MODE.....	86
:OUTPut[:STATe][:IMMediate].....	86
:OUTPut[:STATe]:TRIGgered.....	86
:OUTPut:PROTection:CLEar.....	87
:OUTPut:PROTection:TRIPped.....	87

:OUTPut:DELAy:ON

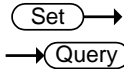

Description	Sets the Delay Time in seconds for turning the output on. The delay is set to 0.00 by default.	
Syntax	:OUTPut:DELAy:ON {<NR2> MINimum MAXimum}	
Query Syntax	:OUTPut:DELAy:ON?	
Parameter	<NR2>	0.00~99.99 seconds, where 0=no delay.
Return parameter	"0.00"	Returns the delay on time in seconds until the output is turned on.

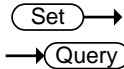

:OUTPut:DELAy:OFF

Description	Sets the Delay Time in seconds for turning the output off. The delay is set to 0.00 by default.	
Syntax	:OUTPut:DELAy:OFF {<NR2> MINimum MAXimum}	
Return Syntax	:OUTPut:DELAy:OFF?	
Parameter	<NR2>	0.00~99.99 seconds, where 0=no delay.
Return parameter	"0.00"	Returns the delay off time in seconds until the output is turned off.

Set →
 → Query

:OUTPut:MODE

Description	Sets the PSU output mode. This is the equivalent to the F-03 (V-I Mode Slew Rate Select) settings.
Syntax	:OUTPut:MODE {<NR1> CVHS CCHS CVLS CCLS}
Return Syntax	:OUTPut:MODE?
Parameter	CVHS 0 CV high speed priority CCHS 1 CC high speed priority CVLS 2 CV slew rate priority CCLS 3 CC slew rate priority
Return parameter	<NR1> Returns the output mode.

Set →
 → Query

:OUTPut[:STATe][:IMMediate]

Description	Turns the output on or off.
Syntax	:OUTPut[:STATe][:IMMediate] { <bool> OFF ON }
Query Syntax	:OUTPut[:STATe][:IMMediate]?
Parameter	OFF 0 Turns the output off. ON 1 Turns the output on.
Return parameter	<bool> Returns output status of the instrument.

Set →
 → Query

:OUTPut[:STATe]:TRIGgered

Description	Turns the output on or off when a software trigger is generated.
Syntax	:OUTPut[:STATe]:TRIGgered { <bool> OFF ON }
Query Syntax	:OUTPut[:STATe]:TRIGgered?
Parameter	OFF 0 Turns the output off when a software trigger is generated (*TRG).

	ON 1	Turns the output on when a software trigger is generated (*TRG).
Return parameter	<bool>	Returns output trigger status of the instrument.

:OUTPut:PROTection:CLEar (Set) →

Description Clears over-voltage, over-current and over-temperature (OVP, OCP, OTP) protection circuits. It also clears the shutdown and sense protection circuit. The AC failure protection cannot be cleared.

Syntax :OUTPut:PROTection:CLEar

:OUTPut:PROTection:TRIPped → (Query)

Description Queries the unit to see if a protection circuit has been tripped.

Syntax :OUTPut:PROTection:TRIPped?

Return <boolean> 0 = No protection error
 1 = A protection error had occurred

Sense Commands

:SENSe:AVERAge:COUNt 88

:SENSe:AVERAge:COUNt

Set →

→ Query

Description	Sets or queries the level of smoothing for the average setting.	
Syntax	:SENSe:AVERAge:COUNt	
Return Syntax	{<NR1> LOW MIDDLE HIGH}	
	:SENSe:AVERAge:COUNt?	
Parameter	LOW 0	Low setting
	MIDDLE 1	Middle setting
	HIGH 2	High setting
Return Parameter	<NR1>	Returns the average setting.

Status Commands

For an overview of all the status registers, their associated register contents and the system diagram, please see the status overview on page 138

:STATus:OPERation[:EVENT]	89
:STATus:OPERation:CONDition	89
:STATus:OPERation:ENABle	90
:STATus:OPERation:PTRansition	90
:STATus:OPERation:NTRansition	90
:STATus:QUESTionable[:EVENT]	91
:STATus:QUESTionable:CONDition	91
:STATus:QUESTionable:ENABle	91
:STATus:QUESTionable:PTRansition	91
:STATus:QUESTionable:NTRansition	92
:STATus:QUESTionable:INSTrument	
:ISUMmary<n>[:EVENT]	92
:STATus:QUESTionable:INSTrument	
:ISUMmary<n>:CONDition	92
:STATus:QUESTionable:INSTrument	
:ISUMmary<n>:ENABle	93
:STATus:PRESet	93

:STATus:OPERation[:EVENT] → Query

Description	Queries the Operation Status Event register and clears the contents of the register.
-------------	--

Syntax	:STATus:OPERation[:EVENT]?
--------	----------------------------

Return	<NR1> Returns the bit sum of the Operation Status Event register.
--------	---

:STATus:OPERation:CONDition → Query

Description	Queries the Operation Status register. This query will not clear the register.
-------------	--

Syntax	:STATus:OPERation:CONDition?
--------	------------------------------

Return	<code><NR1></code>	Returns the bit sum of the Operation Condition register.
--------	--------------------------	--

(Set) →

:STATus:OPERation:ENABLE

→ (Query)

Description	Sets or queries the bit sum of the Operation Status Enable register.	
-------------	--	--

Syntax	:STATus:OPERation:ENABLE <NR1>	
--------	--------------------------------	--

Query Syntax	:STATus:OPERation:ENABLE?	
--------------	---------------------------	--

Parameter	<code><NR1></code>	0~32767
-----------	--------------------------	---------

Return parameter	<code><NR1></code>	0~32767
------------------	--------------------------	---------

(Set) →

:STATus:OPERation:PTRansition

→ (Query)

Description	Sets or queries the bit sum of the positive transition filter of the Operation Status register.	
-------------	---	--

Syntax	:STATus:OPERation:PTRansition <NR1>	
--------	-------------------------------------	--

	:STATus:OPERation:PTRansition?	
--	--------------------------------	--

Parameter	<code><NR1></code>	0~32767
-----------	--------------------------	---------

Return parameter	<code><NR1></code>	0~32767
------------------	--------------------------	---------

(Set) →

:STATus:OPERation:NTRansition

→ (Query)

Description	Sets or queries the bit sum of the negative transition filter of the Operation Status register.	
-------------	---	--

Syntax	:STATus:OPERation:NTRansition <NR1>	
--------	-------------------------------------	--

Query Syntax	:STATus:OPERation:NTRansition?	
--------------	--------------------------------	--

Parameter	<code><NR1></code>	0~32767
-----------	--------------------------	---------

Return parameter	<code><NR1></code>	0~32767
------------------	--------------------------	---------

:STATus:QUESTIONable[:EVENT] → Query

Description Queries the bit sum of the Questionable Status Event register. This query will also clear the contents of the register.

Query Syntax :STATus:QUESTIONable[:EVENT]?

Return parameter <NR1> 0~32767

:STATus:QUESTIONable:CONDition → Query

Description Queries the status (bit sum) of the Questionable Status register. This query will not clear the register.

Query Syntax :STATus:QUESTIONable:CONDition?

Return parameter <NR1> 0~32767

Set →

:STATus:QUESTIONable:ENABLE → Query

Description Sets or queries the bit sum of the Questionable Status Enable register.

Syntax :STATus:QUESTIONable:ENABLE <NR1>

Query Syntax :STATus:QUESTIONable:ENABLE?

Parameter <NR1> 0~32767

Return parameter <NR1> 0~32767

Set →

:STATus:QUESTIONable:PTRansition → Query

Description Sets or queries the bit sum of the positive transition filter of the Questionable Status register.

Syntax :STATus:QUESTIONable:PTRansition <NR1>

Return Syntax :STATus:QUESTIONable:PTRansition?

Parameter <NR1> 0~32767

Return parameter <NR1> 0~32767

:STATus:QUESTionable:NTRansition

Set →

→ Query

Description Sets or queries the negative transition filter of the Questionable Status register.

Syntax :STATus:QUESTionable:NTRansition <NR1>

Query Syntax :STATus:QUESTionable:NTRansition?

Parameter <NR1> 0~32767

Return parameter <NR1> 0~32767

**:STATus:QUESTionable:INSTRument:
ISUMmary<n>[:EVENT]**

→ Query

Description Queries the bit sum of the Questionable Instrument Summary Status Event register. This query will also clear the contents of the register (Multi-Drop mode).

Query Syntax :STATus:QUESTionable:INSTRument:ISUMmary <n>[:EVENT]?

Parameter <n> 1,2 or 3

Return parameter <NR1> 0~32767

**:STATus:QUESTionable:INSTRument:
ISUMmary<n>:CONDition**

→ Query

Description Queries the status (bit sum) of the Questionable Instrument Summary Status Condition register. This query will not clear the register (Multi-Drop mode).

Query Syntax :STATus:QUESTionable:INSTRument:ISUMmary<n>:CONDition?

Parameter <n> 1, 2 or 3

Return parameter <NR1> 0~32767

:STATus:QUESTionable:INSTrument:ISUMmary<n>:ENABle (Set) →
→ (Query)

Description Sets or queries the bit sum of the Questionable Instrument Summary Status Enable register. (Multi-Drop mode).

Syntax :STATus:QUESTionable:INSTrument:ISUMmary <n>:ENABle <NR1>

Query Syntax :STATus:QUESTionable:INSTrument:ISUMmary <n>:ENABle?

Parameter <n> 1,2 or 3
<NR1> 0~32767

Return parameter <NR1> 0~32767

:STATus:PRESet (Set) →

Description This command resets the ENABle register, the PTRansition filter and NTRansition filter on the Operation Status and Questionable Status Registers. The registers/filters will be reset to a default value.

Default Register/Filter Values	Setting
QUESTionable Status Enable	0x0000
QUESTionable Status Positive Transition	0x7FFF
QUESTionable Status Negative Transition	0x0000
QUESTionable Instrument Summary1 Status Enable	0x7FFF
QUESTionable Instrument Summary2 Status Enable	0x7FFF
QUESTionable Instrument Summary3 Status Enable	0x7FFF

Operation Status Enable 0x0000

Operation Status Positive Transition 0x7FFF

Operation Status Negative Transition 0x0000

Summary: The Questionable Status Enable registers and the Operation Status Enable registers are both reset to 0.

The Questionable Status and Operation Status Positive Transition filters are all set high (0x7FFF) and the Negative Transition filters are all set low (0x0000). I.e., only positive transitions will be recognized for the Questionable Status and Operation Status registers.

Syntax :STATus:PRESet

Source Commands

[:SOURce]:CURRent[:LEVel][:IMMediate] [:AMPLitude]	95
[:SOURce]:CURRent[:LEVel]:TRIGgered [:AMPLitude]	96
[:SOURce]:CURRent:LIMit:AUTO	96
[:SOURce]:CURRent:PROTection:DELay	97
[:SOURce]:CURRent:PROTection[:LEVel]	97
[:SOURce]:CURRent:PROTection:STATe	98
[:SOURce]:CURRent:PROTection:TRIPped	98
[:SOURce]:CURRent:SLEWrate:RISing	99
[:SOURce]:CURRent:SLEWrate:FALLing	99
[:SOURce]:MODE?	100
[:SOURce]:RESistance[:LEVel][:IMMediate] [:AMPLitude]	100
[:SOURce]:VOLTage[:LEVel][:IMMediate] [:AMPLitude]	101
[:SOURce]:VOLTage[:LEVel]:TRIGgered [:AMPLitude]	101
[:SOURce]:VOLTage:LIMit:AUTO	102
[:SOURce]:VOLTage:LIMit:LOW	102
[:SOURce]:VOLTage:PROTection[:LEVel]	103
[:SOURce]:VOLTage:PROTection:TRIPped	103
[:SOURce]:VOLTage:SLEWrate:RISing	104
[:SOURce]:VOLTage:SLEWrate:FALLing	104

[:SOURce]:CURRent[:LEVel][:IMMediate] Set →
[:AMPLitude] Query

Description	Sets or queries the current level in amps. For externally set current levels (from the analog control connector) the set current level is returned.
Syntax	[:SOURce]:CURRent[:LEVel][:IMMediate][:AMPLitude] {<NR2> (A) MINimum MAXimum}
Query Syntax	[:SOURce]:CURRent[:LEVel][:IMMediate][:AMPLitude] ?
Parameter/Return	<NR2> 0~105% of the rated current output level.

parameter	MIN	Minimum current level.
	MAX	Maximum current level.
Example	SOUR:CURR:LEV:IMM:AMPL? 38.000 Returns the current level in amps.	

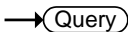
[[:SOURce]:CURRent[:LEVel]:TRIGgered[:AMPLitude]



Description	Sets or queries the current level in amps when a software trigger has been generated.	
Syntax	[:SOURce]:CURRent[:LEVel]:TRIGgered[:AMPLitude] {<NR2> (A) MINimum MAXimum}	
Query Syntax	[:SOURce]:CURRent[:LEVel]:TRIGgered[:AMPLitude]?	
Parameter	<NR2>	0%~105% of the rated current output in amps.
	MIN	Minimum current level.
	MAX	Maximum current level.
Return Parameter	<NR2>	Returns the current level.
Example	SOUR:CURR:LEV:TRIG:AMPL? 38.000 Returns the maximum possible current level in amps.	

[[:SOURce]:CURRent:LIMit:AUTO



Description	Enables or disables the limit on the current setting.	
Syntax	[:SOURce]:CURRent:LIMit:AUTO {<bool> OFF ON}	
Query Syntax	[:SOURce]:CURRent:LIMit:AUTO?	
Parameter	OFF 0	Disable the setting current limit

	ON 1	Enable the setting current limit
Return parameter	<bool>	Returns the setting in <bool> format.
Example	<p>SOUR:CURR:LIM:AUTO 0</p> <p>Disables the current limit.</p>	

Set →
 → Query

[[:SOURce]:CURRent:PROTEction:DElay]		
Description	Sets the Delay Time for OCP in seconds for turning the output off. The delay is set to 0.1 by default.	
Syntax	[:SOURce]:CURRent:PROTEction:DElay {<NR2> MINimum MAXimum}	
Query Syntax	[:SOURce]:CURRent:PROTEction:DElay?	
Parameter	<NR2>	0.1~2.0 seconds, where 0=no delay
	MAX	The maximum allowed delay time
	MIN	The minimum allowed delay time
Return parameter	<NR2>	Returns the delay time in seconds
Example	<p>SOUR:CURR:PROT:DEL MAX</p> <p>Sets the current protection delay to the maximum.</p>	

Set →
 → Query

[[:SOURce]:CURRent:PROTEction[:LEvel]]		
Description	Sets or queries the OCP (over-current protection) level in amps.	
Syntax	[:SOURce]:CURRent:PROTEction[:LEvel] {<NR2>(A) MINimum MAXimum}	
Query Syntax	[:SOURce]:CURRent:PROTEction[:LEvel]?	

Parameter	<NR2>	Current protection level. Minimum: Depend on the unit type: if Irated * 0.1 > 5A, then minimum = 5A, else minimum = Irated * 0.1 Maximum: Irated * 1.1
	MIN	Minimum current level.
	MAX	Maximum current level.
Return parameter	<NR2>	Returns the current protection level.
Example	<p>SOUR:CURR:PROT:LEV? +5.000</p> <p>Returns the minimum possible current level in amps.</p>	

Set →
 → Query

[[:SOURce]:CURRent:PROTection:STATe

Description	Turns OCP (over-current protection) on or off.	
Syntax	[:SOURce]:CURRent:PROTection:STATe {<bool> OFF ON}	
Query Syntax	[:SOURce]:CURRent:PROTection:STATe?	
Parameter	OFF 0	Turns the OCP off.
	ON 1	Turns the OCP on.
Return parameter	<bool>	Returns the over current protection state in <bool> format.
Example	<p>SOUR:CURR:PROT:STAT OFF</p> <p>Turns OCP off.</p>	

[[:SOURce]:CURRent:PROTection:TRIPped → Query

Description	Returns the state of the current protection circuits.	
Query Syntax	[:SOURce]:CURRent:PROTection:TRIPped?	
Return parameter	<bool>	Returns protection status.

Example SOUR:CURR:PROT:TRIP?
 >0
 The protection circuit has not been tripped.

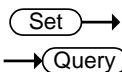

[[:SOURce]:CURRent:SLEWrate:RISing

Description Sets or queries the rising current slew rate. This is only applicable for CC slew rate priority mode.

Syntax [[:SOURce]:CURRent:SLEWrate:RISing
 {<NR2>(A)|MINimum|MAXimum}

Query Syntax [[:SOURce]:CURRent:SLEWrate:RISing?

Parameter	<NR2>	Per step is between 0.001A/msec and rated current divided by 100 msec.
	MIN	Minimum rising current slew rate is 0.001A/msec.
	MAX	Maximum rising current slew rate is rated current divided by 100msec.

Return parameter <NR2> Returns the step current in amps.

Example SOUR:CURR:SLEW:RIS?
 0.950
 Sets the rising current slew rate to 0.950 A/ms.

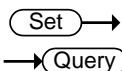

[[:SOURce]:CURRent:SLEWrate:FALLing

Description Sets or queries the falling current slew rate. This is only applicable for CC slew rate priority mode.

Syntax [[:SOURce]:CURRent:SLEWrate:FALLing
 {<NR2>(A)|MINimum|MAXimum}

Query Syntax [[:SOURce]:CURRent:SLEWrate:FALLing?

Parameter	<NR2>	Per step is between 0.001A/msec and rated current divided by 100 msec.
-----------	-------	--

	MIN	Minimum falling current slew rate is 0.001A/msec.
	MAX	Maximum falling current slew rate is rated current divided by 100msec.
Return Parameter	<NR2>	Returns the step current
Example	SOUR:CURREN:SLEW:FALL MAX Sets the falling current slew rate to the maximum.	

[[:SOURce]:MODE? → Query

Description	Returns the status of the output mode (CC, CV, Off) of the power supply. The interface will return "CV" if the supply is in Constant Voltage Mode, "CC" if the supply is in Constant Current Mode or "OFF" if the supply output is off.	
Query Syntax	[:SOURce]:MODE?	
Return parameter	<string>	Returns the output state as a string, "CC", "CV", "OFF"
Example	:SOUR:MODE? >CC The power supply is currently in CC mode.	

[[:SOURce]:RESistance[:LEVel][:IMMediate] [:AMPLitude] Set →
→ Query

Description	Sets or queries the internal resistance in ohms.	
Syntax	[:SOURce]:RESistance[:LEVel][:IMMediate][:AMPLitude] {<NR2>(OHM) MINimum MAXimum}	
Query Syntax	[:SOURce]:RESistance[:LEVel][:IMMediate][:AMPLitude]?	
Parameter	<NR2>	Resistance in ohms: 0 ohm ~ Rrated = Vrated/Irated

	MIN	Minimum internal resistance in ohms
	MAX	Maximum internal resistance in ohms
Return parameter	<NR2>	Returns the internal resistance in ohms.
Example	SOUR:RES:LEV:IMM:AMPL 0.1 Sets the internal resistance to 100mΩ.	

**[[:SOURce]:VOLTage[:LEVel]][:IMMediate]
[:AMPLitude]**
 →
 →

Description	Sets or queries the voltage level in volts.	
Syntax	[:SOURce]:VOLTage[:LEVel]][:IMMediate][:AMPLitude] {<NR2>(V) MINimum MAXimum}	
Query Syntax	[:SOURce]:VOLTage[:LEVel]][:IMMediate][:AMPLitude]?	
Parameter	<NRF>	0~105% of the rated output voltage in volts.
	MIN	Minimum voltage level
	MAX	Maximum voltage level
Return parameter	<NR2>	Returns the voltage level in volts
Example	SOUR:VOLT:LEV:IMM:AMPL 10 Sets the voltage level to 10 volts.	

**[[:SOURce]:VOLTage[:LEVel]:TRIGgered
[:AMPLitude]**
 →
 →

Description	Sets or queries the voltage level in volts when a software trigger has been generated.	
Syntax	[:SOURce]:VOLTage[:LEVel]:TRIGgered[:AMPLitude] {<NR2>(V) MINimum MAXimum}	
Query Syntax	[:SOURce]:VOLTage[:LEVel]:TRIGgered[:AMPLitude]?	
Parameter	<NR2>	0%~105% of the rated voltage output in volts.

	MIN	Minimum current level.
	MAX	Maximum current level.
Return parameter	<NR2>	Returns the voltage level.

Example SOUR:VOLT:LEV:TRIG:AMPL 10
 Sets the voltage level to 10 volts when a software trigger is generated.

Set →
 → Query

[:SOURce]:VOLTage:LIMit:AUTO

Description Sets whether to limit the voltage setting so that it does not exceed the OVP setting or become lower than the UVL setting.

If you enable the limit when the OVP setting is lower than the voltage setting, the OVP setting will be set to 105 % of the voltage setting.

If you enable the limit when the UVL setting is higher than the voltage setting, the UVL setting will be set equal to the voltage setting.

Syntax [:SOURce]:VOLTage:LIMit:AUTO {<bool>|OFF|ON}

Query Syntax [:SOURce]:VOLTage:LIMit:AUTO?

Parameter	OFF 0	Disable the limit setting
	ON 1	Enable the limit setting

Return parameter <bool> Returns the setting in <bool> format.

Example SOUR:VOLT:LIM:AUTO 0
 Disables the limit setting.

Set →
 → Query

[:SOURce]:VOLTage:LIMit:LOW

Description Sets or queries the under voltage (UVL) trip point.

Syntax [:SOURce]:VOLTage:LIMit:LOW
 <NR2>(V)|MINimum|MAXimum

Query Syntax [:SOURce]:VOLTage:LIMit:LOW?

Parameter/Return	<NR2>	0 ~ the present setting voltage
	MIN	Minimum allowed voltage level
	MAX	Maximum allowed voltage level

Example SOUR:VOLT:LIM:LOW MAX
 Sets the UV> level to its maximum.

Set →
 → Query

[:SOURce]:VOLTage:PROTection[:LEVel]

Description Sets or queries the overvoltage protection level.

Syntax [:SOURce]:VOLTage:PROTection[:LEVel]
 {<NR2>(V)|MINimum|MAXimum}

Query Syntax [:SOURce]:VOLTage:PROTection[:LEVel]?

Parameter/Return	<NR2>	Minimum: Depends on the unit type: if Vrated * 0.1 > 5V, then Minimum = 5V, else Minimum = Vrated * 0.1 Maximum: Vrated * 1.1
	MIN	Minimum OVP level
	MAX	Maximum OVP level

Example SOUR:VOLT:PROT:LEV MAX
 Sets the OVP level to its maximum.

[:SOURce]:VOLTage:PROTection:TRIPped → Query

Description Sets or queries the overvoltage protection level.

Query Syntax [:SOURce]:VOLTage:PROTection:TRIPped?

Return parameter	<bool>	
	0	Protection not tripped
	1	Protection tripped

Example SOUR:VOLT:PROT:TRIP?
 >0
 Indicates that the OVP protection has not been tripped.

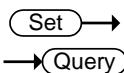

[[:SOURce]:VOLTage:SLEWrate:RISing

Description Sets or queries the rising voltage slew rate. This is only applicable for CV slew rate priority mode.

Syntax [[:SOURce]:VOLTage:SLEWrate:RISing
Query Syntax {<NR2>(V)|MINimum|MAXimum}
 [[:SOURce]:VOLTage:SLEWrate:RISing?]

Parameter	<NR2>	Per step is between 0.001V/msec and rated voltage divided by 100msec.
	MIN	Minimum rising voltage slew rate is 0.001V/msec.
	MAX	Maximum rising voltage slew rate is rated voltage divided by 100msec.

Return parameter <NR2> Returns the slew rate in V/msec.

Example SOUR:VOLT:SLEW:RIS MAX
 Sets the rising voltage slew rate to its maximum.

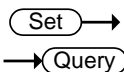

[[:SOURce]:VOLTage:SLEWrate:FALLing

Description Sets or queries the falling voltage slew rate. This is only applicable for CV slew rate priority mode.

Syntax [[:SOURce]:VOLTage:SLEWrate:FALLing
 {<NR2>(V)|MINimum|MAXimum}
Query Syntax [[:SOURce]:VOLTage:SLEWrate:FALLing?]

Parameter	<NR2>	Per step is between 0.001V/msec and rated voltage divided by 100msec.
	MIN	Minimum falling voltage slew rate is 0.001V/msec.
	MAX	Maximum falling voltage slew rate is rated voltage divided by 100msec.

Return parameter	<NR2>	Returns the voltage slew rate in V/msec
------------------	-------	---

Example	SOUR:VOLT:SLEW:FALL MIN Sets the falling voltage slew rate to its minimum.	
---------	---	--

System Function Command

:SYSTem:BEEPer[:IMMediate]	107
:SYSTem:CONFigure:BEEPer[:STATe]	108
:SYSTem:CONFigure:BLEeder[:STATe]	108
:SYSTem:CONFigure:CURRent:CONTRol	109
:SYSTem:CONFigure:VOLTagE:CONTRol	110
:SYSTem:CONFigure:OUTPut:PON[:STATe]	111
:SYSTem:CONFigure:PROTectioN:RECOvery	112
:SYSTem:CONFigure:MSLave	112
:SYSTem:CONFigure:OUTPut:EXTernal:MODE	113
:SYSTem:CONFigure:OUTPut:EXTernal[:STATe]	113
:SYSTem:CONFigure:MONitor:RANGe	114
:SYSTem:CONFigure:CONTRol:RANGe	114
:SYSTem:CONFigure:TRIGger:INPut:SOURce	115
:SYSTem:CONFigure:TRIGger:INPut:WIDTh	116
:SYSTem:CONFigure:TRIGger:OUTPut:SOURce	116
:SYSTem:CONFigure:TRIGger:OUTPut:WIDTh	117
:SYSTem:CONFigure:TRIGger:OUTPut:LEVel	117
:SYSTem:COMMunicate:ENABle	117
:SYSTem:COMMunicate:GPIB[:SELf]:ADDReSS	118
:SYSTem:COMMunicate:LAN:IPADdress	119
:SYSTem:COMMunicate:LAN:GATeway	119
:SYSTem:COMMunicate:LAN:SMASK	120
:SYSTem:COMMunicate:LAN:MAC	120
:SYSTem:COMMunicate:LAN:DHCP	120
:SYSTem:COMMunicate:LAN:DNS	121
:SYSTem:COMMunicate:RLSTATe	121
:SYSTem:COMMunicate:TCPip:CONTRol	122
:SYSTem:COMMunicate:SERial:LANGUage[:SELect]	122
:SYSTem:COMMunicate:SERial[:RECEive]	
:TRANsmit:BAUD	123
:SYSTem:COMMunicate:SERial[:RECEive]	
:TRANsmit:BITS	123
:SYSTem:COMMunicate:SERial[:RECEive]	
:TRANsmit:PARity	124
:SYSTem:COMMunicate:SERial[:RECEive]	
:TRANsmit:SBITs	125
:SYSTem:COMMunicate:SERial:MULTidrop	
:CONTRol	126
:SYSTem:COMMunicate:USB:FRONT:STATe	126
:SYSTem:COMMunicate:USB:REAR:MODE	126

:SYSTem:COMMunicate:USB:REAR:STATe..... 127
 :SYSTem:ERRor 127
 :SYSTem:KLOCK 127
 :SYSTem:KEYLock:MODE 128
 :SYSTem:ERRor:ENABle..... 128
 :SYSTem:LANGuage:EMULation 128
 :SYSTem:LANGuage:[:SElect] 128
 :SYSTem:PRESet 129
 :SYSTem:VERSion 129
 :SYSTem:REBoot 129

:SYSTem:BEEPer[:IMMediate]

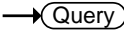

Description	This command causes an audible tone to be generated by the instrument. The duration time is specified in seconds.	
Syntax	:SYSTem:BEEPer[:IMMediate] {<NR1> MINimum MAXimum}	
Query Syntax	:SYSTem:BEEPer[:IMMediate]? [MINimum MAXimum]	
Parameter	<NR1>	0 ~ 3600 seconds.
	MINimum	Sets the beeper time to the minimum (0 seconds)
	MAXimum	Sets the beeper time to the maximum (3600 seconds)
Return parameter	<NR1>	Returns the remaining beeper duration time in seconds or returns the maximum or minimum beeper time in seconds (for the [MINimum MAXimum] query parameters).

Example 1 :SYST:BEEP 10
 after a 2 second wait
 :SYST:BEEP?
 >8

The first command turns the beeper on for 10 seconds. After 2 seconds the SYST:BEEP? Query returns the remaining beeper time (8 seconds).

Example 2 :SYST:BEEP? MAX
 >3600

Returns the maximum settable beeper time in seconds.

Set →
 → Query

:SYSTem:CONFIgure:BEEPer[:STATe]

Description	Sets or queries the buzzer state on/off.	
Syntax	:SYSTem:CONFIgure:BEEPer[:STATe] {<bool> OFF ON}	
Query Syntax	:SYSTem:CONFIgure:BEEPer[:STATe]?	
Parameter	OFF 0	Turns the buzzer off.
	ON 1	Turns the buzzer on.
Return parameter	<bool>	Returns the buzzer status.

Set →
 → Query

:SYSTem:CONFIgure:BLEEder[:STATe]

Description	Sets or queries the status of the bleeder resistor.	
Syntax	:SYSTem:CONFIgure:BLEEder[:STATe] {<NR1> OFF ON AUTO}	
Query Syntax	:SYSTem:CONFIgure:BLEEder[:STATe]?	
Parameter	OFF 0	Turns the bleeder resistor off.
	ON 1	Turns the bleeder resistor on.
	AUTO 2	Turn the AUTO mode on.
Return parameter	<NR1>	Returns bleeder resistor status.

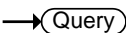
:SYSTem:CONFigure:CURRent:CONTRol



Description Sets or queries the CC control mode (local control (panel), external voltage control, external resistance control). This is the equivalent to the F-91 (CC Control) power on configuration settings.

 **Note** The setting will only be valid after the power has been cycled.

Syntax :SYSTem:CONFigure:CURRent:CONTRol { <NR1>|NONE|VOLTage|RRISing|RFALLing|VISolation }

Query Syntax :SYSTem:CONFigure:CURRent:CONTRol?

Parameter	<NR1>	Description
	0 NONE	Local (Panel) control
	1 VOLTage	External voltage control
	2 RRISing	External resistance control; 10kΩ or 5kΩ = I _o max*, 0kΩ = I _o min.
	3 RFALLing	External resistance control; 10kΩ or 5kΩ = I _o min*, 0kΩ = I _o max.
	4 VISolation	External voltage control (isolated)

*The resistance value depends on the :SYSTem:CONFigure:CONTRol:RANGE command.
If the range is high, then the resistance is 10kΩ, else it is 5kΩ.

Return Parameter <NR1> Returns the current control configuration.

Example SYST:CONF:CURR:CONT VOLT
SYST:REB
Sets the current control by external voltage and reboot the unit to active the setting.

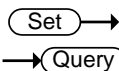

:SYSTem:CONFigure:VOLTage:CONTRol

Description Sets or queries the CV control mode (local control (panel), external voltage control, external resistance control). This is the equivalent to the F-90 (CV Control) power on configuration settings.

Note The setting will only be valid after the power has been cycled.

Syntax :SYSTem:CONFigure:VOLTage:CONTRol { <NR1>|NONE|VOLTage|RRISing|RFALLing|VISolation }

Query Syntax :SYSTem:CONFigure:VOLTage:CONTRol?

Parameter	<NR1>	Description
	0 NONE	Local (Panel) control
	1 VOLTage	External voltage control
	2 RRISing	External resistance control; 10kΩ or 5kΩ = I _o max*, 0kΩ = I _o min.
	3 RFALLing	External resistance control; 10kΩ or 5kΩ = I _o min*, 0kΩ = I _o max.
	4 VISolation	External voltage control (isolated)

*The resistance value depends on the :SYSTem:CONFigure:CONTRol:RANGe command.

If the range is high, then the resistance is 10kΩ, else it is 5kΩ.

Return Parameter <NR1> Returns the voltage control configuration.

Example SYST:CONF:VOLT:CONT VOLT
 SYST:REB
 Sets the voltage control by external voltage and reboot the unit to active the setting.

:SYSTem:CONFigure:OUTPut:PON[:STATe]





Description	Sets the output state at power-on. This is the equivalent to the F-92 (Output Status when Power ON) power on configuration settings.	
 Note	The setting will only be valid after the power has been cycled.	
Syntax	:SYSTem:CONFigure:OUTPut:PON[:STATe]	
Return Syntax	{<NR1> {SAFE OFF}} {FORCe ON} AUTO}	
	:SYSTem:CONFigure:OUTPut:PON[:STATe]?	
Parameter	SAFE OFF 0	The PSU turns on in the same state the unit was in prior to the previous shut down. The output is set to off (default).
	FORCe ON 1	The PSU turns on in the same state the unit was in prior to the previous shut down. The output is set to on.
	AUTO 2	The PSU turns on in the same state the unit was in prior to the previous shut down, but with the same output on/off setting.
Return parameter	0	The power on output setting is "SAFE" or "OFF".
	1	The power on output setting is "FORCe" or "ON".
	2	The power on output setting is "AUTO".
Example	SYST:CONF:OUTP:PON SAFE SYST:REB Set the power-on output state to safe and reboot the unit to active the setting.	

:SYSTem:CONFigure:PROTection:RECover



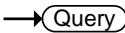

Description	Sets or queries how the OHP, FAN, AC-FAIL, and SD alarms are cleared.	
Syntax	:SYSTem:CONFigure:PROTection:RECover	
Return Syntax	{SAFE AUTO}	
	:SYSTem:CONFigure:PROTection:RECover?	
Parameter	SAFE	The output is not turned on automatically when the cause of the alarm is fixed.
	AUTO	The output is turned on automatically when the cause of the alarm is fixed.

:SYSTem:CONFigure:MSLave

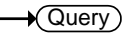

Description	Sets or queries the unit operation mode.	
 Note	This is the equivalent to the F-93 (Master/Slave Configuration) power on configuration settings.	
Syntax	:SYSTem:CONFigure:MSLave { <NR1> }	
Query Syntax	:SYSTem:CONFigure:MSLave?	
Parameter/ Return parameter	<NR1>	Description
	0	Master/Local
	1	Master/with 1 unit in Parallel (total:2 units)
	2	Master/with 2 units in Parallel (total: 3 units)
	3	Master/with 3 units in Parallel (total: 4 units)
	4	Slave
Example	SYST:CONF:MSL 2 SYST:REB Set to Master (with 2 slave units in Parallel) and reboot the unit to active the setting.	

:SYSTem:CONFigure:OUTPut:EXTernal:MODE

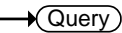

Description	Sets the logic used to turn the output on or off when using an external contact. This is the equivalent to the F-94 (External Output Logic) power on configuration settings.
 Note	The setting will only be valid after the power has been cycled.
Syntax	:SYSTem:CONFigure:OUTPut:EXTernal:MODE
Return Syntax	{<NR1> LOW HIGH} :SYSTem:CONFigure:OUTPut:EXTernal:MODE?
Parameter	HIGH 0 Active high LOW 1 Active low
Return Parameter	<NR1> Returns the logic setting.
Example	SYST:CONF:OUTP:EXT:MODE 0 SYST:REB Set active high for the logic for the external analog control contact and reboot the unit to active the setting.

:SYSTem:CONFigure:OUTPut:EXTernal[:STATe]



Description	Sets whether the output will be turned on or off externally. By default this setting is turned off. This is the equivalent to the F-98 (External Output Control Function) power on configuration settings.
 Note	The setting will only be valid after the power has been cycled.
Syntax	:SYSTem:CONFigure:OUTPut:EXTernal[:STATe]
Return Syntax	{<bool> OFF ON} :SYSTem:CONFigure:OUTPut:EXTernal[:STATe]?
Parameter	ON 1 External control is performed.

	OFF 0	External control is not performed.
Return parameter	<bool>	Returns output status of the instrument.
Example	SYST:CONF:OUTP:EXT 1 SYST:REB Active the external output control and reboot the unit to active the setting.	

Set →
 → Query

:SYSTem:CONFIgure:MONitor:RANGe

Description This command is used to select the monitor voltage range. This is the equivalent to the F-96 (Monitor Voltage Select) power on configuration settings.

 **Note** The setting will only be valid after the power has been cycled.

Syntax :SYSTem:CONFIgure:MONitor:RANGe {<NR1>|LOW|HIGH}

Return Syntax :SYSTem:CONFIgure:MONitor:RANGe?

Parameter

LOW 0	5V
HIGH 1	10V

Return Parameter <NR1> Returns the range setting.

Example SYST:CONF:MON:RANG LOW
 SYST:REB
 Set monitor voltage range to 0~5V and reboot the unit to active the setting.

Set →
 → Query

Description This command is used to select the external analog control voltage (or resistance) range. This is the equivalent to the F-97 (Control Range) power on configuration settings.

 Note	The setting will only be valid after the power has been cycled.
Syntax	:SYSTem:CONFigure:CONTRol:RANG {<NR1> LOW HIGH}
Return Syntax	:SYSTem:CONFigure:CONTRol:RANGe?
Parameter	LOW 0 5V [5kΩ] HIGH 1 10V [10kΩ]
Return Parameter	<NR1> Returns the range setting.
Example	SYST:CONF:CONT:RANG LOW SYST:REB Set external analog control voltage (or resistance) range to 0~5V [5kΩ] and reboot the unit to active the setting.

:SYSTem:CONFigure:TRIGger:INPut:SOURce
 Set →
 → Query

Description	Sets or queries what action will be performed on receiving a trigger.
Syntax	:SYSTem:CONFigure:TRIGger:INPut:SOURce {<NR1> NONE OUTPut SETTing MEMory}
Return Syntax	:SYSTem:CONFigure:TRIGger:INPut:SOURce?
Parameter	NONE 0 No input trigger. OUTPut 1 Toggles the output on receiving a trigger. SETTing 2 Sets the voltage/current on receiving a trigger. MEMory 3 Loads a memory setting on receiving a trigger.
Return Parameter	<NR1> Returns the input source.

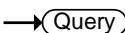
:SYSTem:CONFIgure:TRIGger:INPut:WIDTh

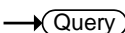

Description	Sets or queries the input trigger pulse width. A setting of 0 indicates that the input trigger is controlled by the trigger input level, rather than a trigger pulse.	
Syntax	:SYSTem:CONFIgure:TRIGger:INPut:WIDTh {<NR2> MINimum MAXimum}	
Return Syntax	:SYSTem:CONFIgure:TRIGger:INPut:WIDTh? [MINimum MAXimum]	
Parameter	<NR2>	0 ~ 60ms.
	MINimum	Minimum width = 0.
	MAXimum	60ms
Return Parameter	<NR2>	Returns the trigger input width.

:SYSTem:CONFIgure:TRIGger:OUTPut:SOURce



Description	Sets or queries the output trigger source.	
Syntax	:SYSTem:CONFIgure:TRIGger:OUTPut:SOURce {<NR1> NONE OUTPut SETTing MEMory}	
Return Syntax	:SYSTem:CONFIgure:TRIGger:OUTPut:SOURce?	
Parameter	NONE 0	No output trigger.
	OUTPut 1	Output trigger is generated by a change in the output.
	SETTing 2	Output trigger is generated when a setting is changed.
	MEMory 3	Output trigger is generated when a memory setting is loaded.
Return Parameter	<NR1>	Returns the output source.

:SYSTem:CONFigure:TRIGger:OUTPut:WIDTh
 →
 →





Description	Sets or queries the output trigger pulse width. A setting of 0 indicates that the output trigger will go high or low, depending on the output level setting.	
Related Commands	:SYSTem:CONFigure:TRIGger:OUTPut:LEVel	
Syntax	:SYSTem:CONFigure:TRIGger:OUTPut:WIDTh {<NR2> MINimum MAXimum}	
Return Syntax	:SYSTem:CONFigure:TRIGger:OUTPut:WIDTh? [MINimum MAXimum]	
Parameter	<NR2>	0 ~ 60ms.
	MINimum	Minimum width = 0
	MAXimum	60ms
Return Parameter	<NR2>	Returns the trigger output width.

:SYSTem:CONFigure:TRIGger:OUTPut:LEVel
 →
 →

Description	Sets the polarity of the output trigger level when the output trigger pulse width is set to 0.	
Syntax	:SYSTem:CONFigure:TRIGger:OUTPut:LEVel {<NR1> LOW HIGH}	
Return Syntax	:SYSTem:CONFigure:TRIGger:OUTPut:LEVel?	
Parameter	0 LOW	Sets the output trigger to active low.
	1 HIGH	Sets the output trigger to active high.
Return Parameter	<NR1>	Returns the trigger output width.

:SYSTem:COMMunicate:ENABle
 →
 →

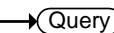
Description	Enables/Disables GPIB, USB or other remote interfaces such as Sockets and the Web Server.	
-------------	---	--

 Note	The setting will only be valid after the power has been cycled.	
Syntax	:SYSTem:COMMunicate:ENABLE {<bool> OFF ON,GPIB USB LAN SOCKets WEB SERial}	
Query Syntax	:SYSTem:COMMunicate:ENABLE? {GPIB USB LAN SOCKets WEB SERial}	
Parameter 1	OFF 0	Disables the selected interface.
	ON 1	Enables the selected interface.
Parameter 2	GPIB	Select GPIB
	USB	Select USB
	LAN	Select LAN
	SOCKets	Select Sockets
	WEB	Select the web server
	SERial	Selected Serial (UART)
Return Parameter	<bool>	Returns the status of the selected mode.
Example	<pre>SYST:COMM:ENAB 1,USB SYST:REB</pre> <p>Turns the USB interface on and reboot the unit to active the setting.</p>	
Query Example	<pre>SYST:COMM:ENAB? USB 1</pre> <p>Queries the USB state, returns 1 (USB is on).</p>	
	<div style="text-align: right;">  →  → </div>	
	<hr style="border: 1px solid orange;"/> <pre>:SYSTem:COMMunicate:GPIB[:SELF]:ADDRess</pre>	
Description	Sets or queries the GPIB address.	
 Note	The setting will only be valid after the power has been cycled.	
Syntax	:SYSTem:COMMunicate:GPIB[:SELF]:ADDRess <NR1>	
Query Syntax	:SYSTem:COMMunicate:GPIB[:SELF]:ADDRess?	

Parameter/Return	<NR1> 0~30
Example	<p>SYST:COMM:GPIB:SELF:ADDR 15 SYST:REB</p> <p>Sets the GPIB address to 15 and reboot the unit to active the setting.</p>

Set →
 → Query

Description	Sets or queries LAN IP address.
 Note	The setting will only be valid after the power has been cycled.
Syntax	:SYSTem:COMMunicate:LAN:IPADdress <string>
Query Syntax	:SYSTem:COMMunicate:LAN:IPADdress?
Parameter/Return	<p><string> LAN IP address in string format (“address”) Applicable ASCII characters: 20H to 7EH</p>

Example	<p>SYST:COMM:LAN:IPAD “172.16.5.111” SYST:REB</p> <p>Sets the IP address to 172.16.5.111 and reboot the unit to active the setting.</p>
---------	---

Set →
 → Query

Description	Sets or queries the Gateway address.
 Note	The setting will only be valid after the power has been cycled.
Syntax	:SYSTem:COMMunicate:LAN:GATeway <string>
Query Syntax	:SYSTem:COMMunicate:LAN:GATeway?
Parameter/Return	<p><string> Gateway address in string format (“address”) Applicable ASCII characters: 20H to 7EH</p>

Example SYST:COMM:LAN:GATe "172.16.0.254"
 SYST:REB
 Sets the LAN gateway to 172.16.0.254 and reboot the unit to active the setting.

(Set) →
 → (Query)

:SYSTem:COMMunicate:LAN:SMASK

Description	Sets or queries the LAN subnet mask.
 Note	The setting will only be valid after the power has been cycled.
Syntax	:SYSTem:COMMunicate:LAN:SMASK <string>
Query Syntax	:SYSTem:COMMunicate:LAN:SMASK?
Parameter/Return	<string> Subnet mask in string format ("mask") Applicable ASCII characters: 20H to 7EH

Example SYST:COMM:LAN:SMASK "255.255.0.0"
 SYST:REB
 Sets the LAN mask to 255.255.0.0. and reboot the unit to active the setting.

:SYSTem:COMMunicate:LAN:MAC

→ (Query)

Description	Returns the unit MAC address as a string. The MAC address cannot be changed.
Query Syntax	:SYSTem:COMMunicate:LAN:MAC?
Return parameter	<string> Returns the MAC address in the following format "FF-FF-FF-FF-FF-FF"

Example SYST:COMM:LAN:MAC?
 02-80-AD-20-31-B1
 Returns the MAC address.

(Set) →
 → (Query)

:SYSTem:COMMunicate:LAN:DHCP

Description	Turns DHCP on/off. Queries the DHCP status.
-------------	---

 Note	The setting will only be valid after the power has been cycled.
Syntax	:SYSTem:COMMunicate:LAN:DHCP {<bool> OFF ON}
Query Syntax	:SYSTem:COMMunicate:LAN:DHCP?
Parameter	OFF 0 DHCP off ON 1 DHCP on
Return parameter	<bool> Returns the DHCP status.
Example	SYST:COMM:LAN:DHCP ON SYST:REB Sets the DHCP active and reboot the unit to active the setting.

:SYSTem:COMMunicate:LAN:DNS
 →
 →

Description	Sets or queries the DNS address.
 Note	The setting will only be valid after the power has been cycled.
Syntax	:SYSTem:COMMunicate:LAN:DNS <string>
Query Syntax	:SYSTem:COMMunicate:LAN:DNS?
Parameter/Return	<string> DNS in string format (“mask”) Applicable ASCII characters: 20H to 7EH
Example	SYST:COMM:LAN:DNS “172.16.1.252” SYST:REB Sets the DNS to 172.16.1.252 reboot the unit to active the setting.

:SYSTem:COMMunicate:RLState
 →
 →

Description	Enables or disables local/remote state of the instrument.
-------------	---

Syntax	:SYSTem:COMMunicate:RLSTate {LOCa REMote RWLock}	
Query Syntax	:SYSTem:COMMunicate:RLSTate?	
Parameter/Return parameter	LOCa	All keys are valid. This instrument is controlled by the front panel controls.
	REMote	All keys are invalid, except for the [local] key and the ability to turn the output off.
	RWLock	All keys are invalid. The instrument can only be controlled remotely.
Example	:SYST:COMM:RLST LOCAL Sets the operating mode to local.	

:SYSTem:COMMunicate:TCPIP:CONTRol → **Query**

Description	Queries the socket port number.	
Query Syntax	:SYSTem:COMMunicate:TCPIP:CONTRol?	
Return parameter	<NR1>	0000 ~ 9999
Example	SYST:COMM:TCP:CONT? >2268 Returns the socket port number.	

:SYSTem:COMMunicate:SERial:LANGuage **Set** →
[:SElect] → **Query**

Description	Sets or queries the communication protocol for the serial port.	
Syntax	:SYSTem:COMMunicate:SERial:LANGuage[:SElect] {“SCPI” “LEGACY”}	
Query Syntax	:SYSTem:COMMunicate:SERial:LANGuage[:SElect]?	
Parameter/Return parameter	“SCPI”	Sets the communication protocol to SCPI.

“LEGACY” Sets the communication protocol to legacy mode. (Emulate TDK Genesys)

Example SYST:COMM:SER:LANG?
>SCPI
Indicates that the communication protocol is set to SCPI.

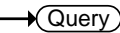
:SYSTem:COMMunicate:SERial[:RECeive] 
:TRANsmit:BAUD 

Description	Sets or queries the UART baud rate.
 Note	The setting will only be valid after the power has been cycled.
Syntax	:SYSTem:COMMunicate:SERial[:RECeive]:TRANsmit
Query Syntax	:BAUD <NR1> :SYSTem:COMMunicate:SERial[:RECeive]:TRANsmit :BAUD?
Parameter/Return	<NR1> 2400, 4800, 9600, 19200, 38400, 57600, 115200

Example SYST:COMM:SER:TRAN:BAUD?
>2400
Returns the baud rate settings.
SYST:COMM:SER:TRAN:BAUD 9600
SYST:REB
Set the UART baud rate to 9600bps and reboot the unit to active the setting.

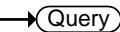
:SYSTem:COMMunicate:SERial[:RECeive] 
:TRANsmit:BITS 

Description	Sets or queries the UART number of data bits.
 Note	The setting will only be valid after the power has been cycled.

Syntax :SYSTem:COMMunicate:SERial[:RECeive]:TRANsmit
 Query Syntax :BITS <NR1>
 :SYSTem:COMMunicate:SERial[:RECeive]:TRANsmit
 :BITS?

Parameter/Return parameter	<NR1>	
	0	7 bits
	1	8 bits

Example SYST:COMM:SER:TRAN:BITS?
 >1
 Indicates that 8 data bits are used for the UART connection.
 SYST:COMM:SER:TRAN:BITS 1
 SYST:REB
 Set the UART data bits to 8 data bits and reboot the unit to active the setting.

:SYSTem:COMMunicate:SERial[:RECeive] Set →
 :TRANsmit:PARity → Query

Description Sets or queries the parity of the UART connection.

 Note The setting will only be valid after the power has been cycled.

Syntax :SYSTem:COMMunicate:SERial[:RECeive]:TRANsmit
 :PARity <NR1>

Query Syntax :SYSTem:COMMunicate:SERial[:RECeive]:TRANsmit
 :PARity?

Parameter/Return parameter	0	None
	1	Odd
	2	Even

**:SYSTem:COMMunicate:SERial:MULTidrop
:CONTRol**

→ **Query**

Description Queries the Multi-Drop Control state.

Query Syntax SYST:COMM:SER:MULT:CONT?

Return parameter	0	<NR1>Disable
	1	<NR1>Master
	2	<NR1>Slave

:SYSTem:COMMunicate:USB:FRONT:STATe

→ **Query**

Description Queries the front panel USB-A port state.

Query Syntax :SYSTem:COMMunicate:USB:FRONT:STATe?

Return parameter	0	<NR1>Absent
	1	<NR1>Mass Storage

Set →

:SYSTem:COMMunicate:USB:REAR:MODE

→ **Query**

Description Sets or queries the speed of the rear panel USB B port.

 **Note** The setting will only be valid after the power has been cycled.

Syntax :SYSTem:COMMunicate:USB:REAR:MODE
{<NR1>|DISable|AUTO|FULL}

Query Syntax :SYSTem:COMMunicate:USB:REAR:MODE?

Parameter	0 DISable	Disable
	1 AUTO	Auto detect speed
	2 FULL	Full speed

Return parameter	<NR1>	
	0	Disable

1	Auto detect speed
2	Full speed

Example SYST:COMM:USB:REAR:MODE 2
 SYST:REB

Sets the rear panel USB B port to full speed and reboot the unit to active the setting.

:SYSTem:COMMunicate:USB:REAR:STATe → **Query**

Description	Queries the rear panel USB-B port state.
Query Syntax	:SYSTem:COMMunicate:USB:REAR:STATe?
Return parameter	0 <NR1>Absent 1 <NR1>Connected to the PC

:SYSTem:ERRor → **Query**

Description	Queries the error queue. The last error message is returned. A maximum of 32 errors are stored in the error queue.
Query Syntax	:SYSTem:ERRor?
Return parameter	<string> Returns an error code followed by an error message as a single string.
Example	SYSTem:ERRor? -100, "Command error"

Set →

:SYSTem:KLOCK → **Query**

Description	Enables or disables the front panel key lock.
Syntax	:SYSTem:KLOCK {<bool> OFF ON }
Query Syntax	:SYSTem:KLOCK?
Parameter	OFF 0 Panel keys unlocked ON 1 Panel keys locked

Return parameter <bool> Returns the key lock status.

:SYSTem:KEYLock:MODE

Set →
→ Query

Description Sets or queries the keylock mode. This setting is the equivalent to the F-19 function setting.

Syntax :SYSTem:KEYLock {<bool>|OFF|ON}

Query Syntax :SYSTem:KEYLock?

Parameter/Return parameter	0 OFF	Panel lock: allow output off.
	1 ON	Panel lock: allow output on/off.

:SYSTem:ERRor:ENABLE

Set →

Description Clears the Error Queue and enables all error messages to be placed in the System Error Queue.

Syntax :SYSTem:ERRor:ENABLE

Set →

:SYSTem:LANGUage:EMULation

→ Query

Description Sets or queries the command language.

Syntax :SYSTem:LANGUage:EMULation
{“NONE”|“N5700”|“GENSYS”|“PWX”}

Query Syntax :SYSTem:LANGUage:EMULation?

Parameter/Return parameter	“NONE”	Emulation is not used. This is the default setting
	“N5700”	N5700/N8700 emulation is used.
	“GENSYS”	GENESYS emulation is used.
	“PWX”	PAG emulation is used.

Set →

:SYSTem:LANGUage[:SElect]

→ Query

Description Sets or queries the command language.

Syntax :SYSTem:LANGUage[:SElect] {"SCPI"}|"LEGACY"}

Query Syntax :SYSTem:LANGUage[:SElect]?

Parameter/ Return parameter "SCPI" Use the SCPI command language.
This the default language

"LEGACY" Use the GEN command language.

:SYSTem:PRESet

Set →

Description Loads the preset default settings.

Syntax :SYSTem:PRESet

:SYSTem:VERSion

→ Query

Description Returns the version of the PSU SCPI version.

Query Syntax :SYSTem:VERSion?

Return <string> Returns the SCPI version as a string.

Query Example SYST:VERS?
>1999.9

:SYSTem:REBoot

Set →

Description Reboots the PSU system.

Syntax :SYSTem:REBoot

Trigger Commands

```
:TRIGger:OUTPut:SOURce.....
:TRIGger:OUTPut[:IMMediate] .....
:TRIGger[:TRANsient]:SOURce .....
:TRIGger[:TRANsient][:IMMediate].....
```

:TRIGger:OUTPut:SOURce

Set →
→ Query

Description	Sets or queries the trigger source of the output trigger.	
Syntax	:TRIGger:OUTPut:SOURce {BUS IMMediate EXTernal}	
Query Syntax	:TRIGger:OUTPut:SOURce?	
Parameter/ Return parameter	BUS	Output trigger is generated by the bus.
	IMMediate	Output trigger is immediately generated.
	EXTernal	The output trigger is generated when an external signal triggers it.
Example	:TRIGger:OUTPut:SOURce? EXT Sets the output trigger source to EXT.	

:TRIGger:OUTPut[:IMMediate]

Set →

Description	Generates an immediate trigger for the output trigger system.
Syntax	:TRIGger:OUTPut[:IMMediate]
Example	:TRIG:OUTP
Example	:TRIG:MEM

:TRIGger[:TRANSient]:SOURce (Set) →
→ (Query)

Description	Sets or queries the source of the transient trigger.	
Syntax	:TRIGger[:TRANSient]:SOURce {BUS IMMediate EXTernal}	
Query Syntax	:TRIGger[:TRANSient]:SOURce?	
Parameter/ Return parameter	BUS	Transient trigger is generated by the bus.
	IMMediate	Transient trigger is immediately generated.
	EXTernal	The transient trigger is generated when an external signal triggers it.
Example	:TRIG:SOUR? EXT Sets the transient trigger source to EXT.	

:TRIGger[:TRANSient][:IMMediate] (Set) →

Description	Generates an immediate trigger for the transient trigger system.	
Syntax	:TRIGger[:TRANSient][:IMMediate]	
Example	:TRIG	

Global Commands

:GLOBal:CURRent[:LEVel][:IMMediate]	
[:AMPLitude]	132
:GLOBal:VOLTage[:LEVel][:IMMediate]	
[:AMPLitude]	132
:GLOBal:OUTPut[:STATe][:IMMediate]	133
:GLOBal:PRESet	133

:GLOBal:CURRent[:LEVel][:IMMediate]
[:AMPLitude]



Description	Sets current value for all units when using the (Legacy) Multi-Drop mode.	
Syntax	GLOBal:CURRent[:LEVel][:IMMediate][:AMPLitude] {<NR2>(A) MINimum MAXimum}	
Parameter	<NR2>	0~105% of the rated current output level.
	MIN	Minimum current level.
	MAX	Maximum current level.
Example	GLOB:CURR MAX Sets the current to the maximum for all units.	

:GLOBal:VOLTage[:LEVel][:IMMediate]
[:AMPLitude]



Description	Sets voltage value for all units when using the (Legacy) Multi-Drop mode.	
Syntax	:GLOBal:VOLTage[:LEVel][:IMMediate][:AMPLitude] {<NR2>(V) MINimum MAXimum}	
Parameter	<NR2>	0~105% of the rated voltage output level
	MIN	Minimum voltage level.
	MAX	Maximum voltage level.

Example GLOB:VOLT MIN
Sets the voltage to the minimum for all units.

:GLOBal:OUTPut[:STATe][:IMMediate] 

Description Sets output on or off for all units when using the (Legacy) Multi-Drop mode.

Syntax :GLOBal:OUTPut[:STATe][:IMMediate]
<bool>|OFF|ON

OFF | 0 Turns the output off for all units.

ON | 1 Turns the output on for all units.

Example GLOB:OUTP OFF
Sets the output off for all units.

:GLOBal:PRESet 

Description Loads the preset default settings for all units when using the (Legacy) Multi-Drop mode.

Syntax :GLOBal:PRESet

IEEE 488.2 Common Commands

*CLS	134
*ESE	134
*ESR	135
*IDN	135
*OPC	135
*RCL	136
*RST	136
*SAV	136
*SRE	137
*STB	137
*TRG	137
*TST	137
*WAI	138

*CLS

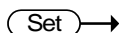

Description The *CLS command clears all the event registers, including the status byte, event status and error queue.

Syntax *CLS

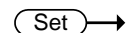

*ESE



Description Sets or queries the Standard Event Status Enable register.

Syntax *ESE <NR1>

Query Syntax *ESE?

Parameter <NR1> 0~255

Return parameter <NR1> Returns the bit sum of the Standard Event Status Enable register.

***ESR** → **Query**

Description Queries the Standard Event Status (Event) register. The Event Status register is cleared after it is read.

Query Syntax *ESR?

Return parameter <NR1> Returns the bit sum of the Standard Event Status (Event) register and clears the register.

***IDN** → **Query**

Description Queries the manufacturer, model name, serial number, and firmware version of the PSU.

Query Syntax *IDN?

Return parameter <string> Returns the instrument identification as a string in the following format:
 GW-INSTEK, PSU-20-76, TW123456, 01.00.20110101
 Manufacturer: GW-INSTEK
 Model number: PSU-20-76
 Serial number: TW123456
 Firmware version: 01.00.20110101

***OPC** → **Set** → **Query**

Description The *OPC command sets the OPC bit (bit0) of the Standard Event Status Register when all current commands have been processed.
 The *OPC? Query returns 1 when all the outstanding commands have completed.

Syntax	*OPC
Query Syntax	*OPC?
Return parameter	1 Returns 1 when all the outstanding commands have completed.

***RCL** (Set) →

Description	Recalls the contents stored in memory slot M1, M2 or M3.						
Syntax	*RCL {<NR1> MAX MIN}						
Parameter	<table border="0"> <tr> <td><NR1></td> <td>0, 1, 2 (as memory M1 , M2, M3)</td> </tr> <tr> <td>MIN</td> <td>Recalls the M1 memory contents.</td> </tr> <tr> <td>MAX</td> <td>Recalls the M3 memory contents.</td> </tr> </table>	<NR1>	0, 1, 2 (as memory M1 , M2, M3)	MIN	Recalls the M1 memory contents.	MAX	Recalls the M3 memory contents.
<NR1>	0, 1, 2 (as memory M1 , M2, M3)						
MIN	Recalls the M1 memory contents.						
MAX	Recalls the M3 memory contents.						

***RST** (Set) →

Description	Performs a device reset. Configures the unit to a known configuration (preset default settings). This known configuration is independent of the usage history.
Syntax	*RST

***SAV** (Set) →

Description	Saves the settings into memory slot M1, M2 or M3.						
Syntax	*SAV {<NR1> MIN MAX}						
Return parameter	<table border="0"> <tr> <td><NR1></td> <td>0, 1, 2 (as memory M1 , M2, M3)</td> </tr> <tr> <td>MIN</td> <td>Saves the M1 memory contents.</td> </tr> <tr> <td>MAX</td> <td>Saves the M3 memory contents.</td> </tr> </table>	<NR1>	0, 1, 2 (as memory M1 , M2, M3)	MIN	Saves the M1 memory contents.	MAX	Saves the M3 memory contents.
<NR1>	0, 1, 2 (as memory M1 , M2, M3)						
MIN	Saves the M1 memory contents.						
MAX	Saves the M3 memory contents.						

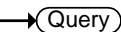
 →
 → 

*SRE	
Description	Sets or queries the Service Request Enable register. The Service Request Enable register determines which registers of the Status Byte register are able to generate service requests.
Syntax	*SRE <NR1>
Query Syntax	*SRE?
Parameter	<NR1> 0~255
Return parameter	<NR1> Returns the bit sum of the Service Request Enable register.

→ 

*STB	
Description	Queries the bit sum of the Status Byte register with MSS (Master summary Status) replacing the RQS bit (bit 6).
Query Syntax	*STB?
Return parameter	<NR1> Returns the bit sum of the Status Byte register with the MSS bit (bit 6).

 →

*TRG	
Description	The *TRG command is able to generate a “get” (Group Execute Trigger). If the PSU cannot accept a trigger at the time of the command, an error message is generated (-211, “Trigger ignored”).
Syntax	*TRG

→ 

*TST	
Description	Executes a self test.
Query Syntax	*TST?

Return parameter	0	Returns "0" if there are no errors.
	<NR1>	Returns an error code <NR1> if there is an error.

***WAI**

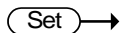

Description	Prevents any other commands or queries from being executed until all outstanding commands have completed.
Syntax	*WAI

Status Register Overview

To program the PSU power supply effectively, the Status registers need to be understood. This chapter explains in detail how the Status registers are used and how to configure them.

Introduction to the Status Registers

Overview

The status registers are used to determine the status of the power supply. The status registers maintain the status of the protection conditions, operation conditions and instrument errors.

The PSU Series have a number of register groups:

- Questionable Status Register Group
- Standard Event Status Register Group
- Operation Status Register Group
- Status Byte Register
- Service Request Enable Register
- Service Request Generation
- Error Queue
- Output Buffer

The next page shows the structure of the Status registers.

The Status Registers

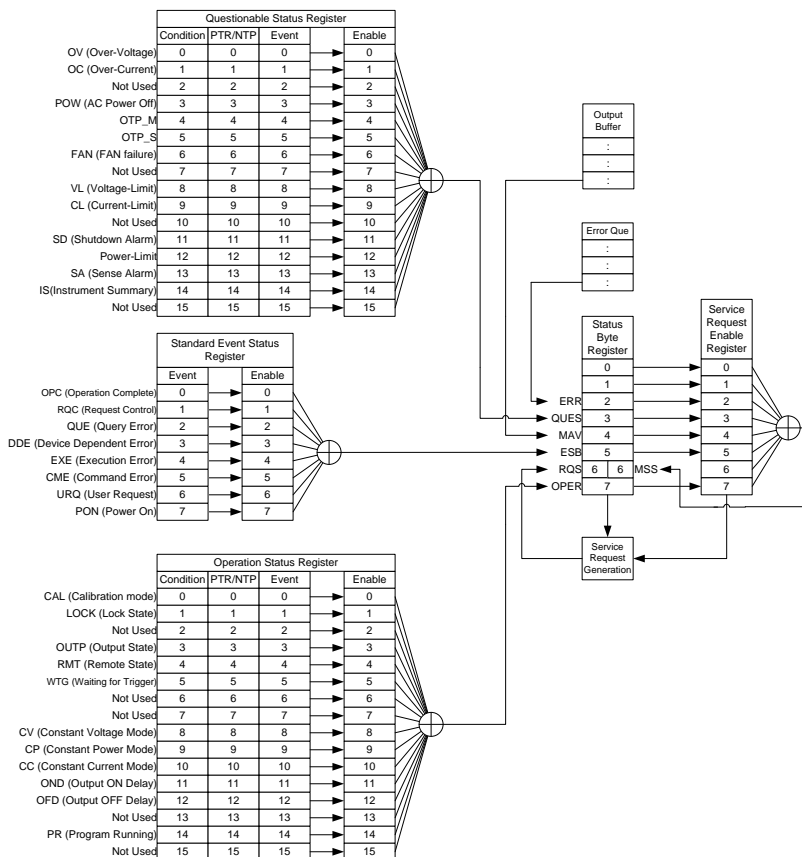

Questionable Status Register Group

Overview The Questionable Status Register Group indicates if any protection modes or limits have been tripped.

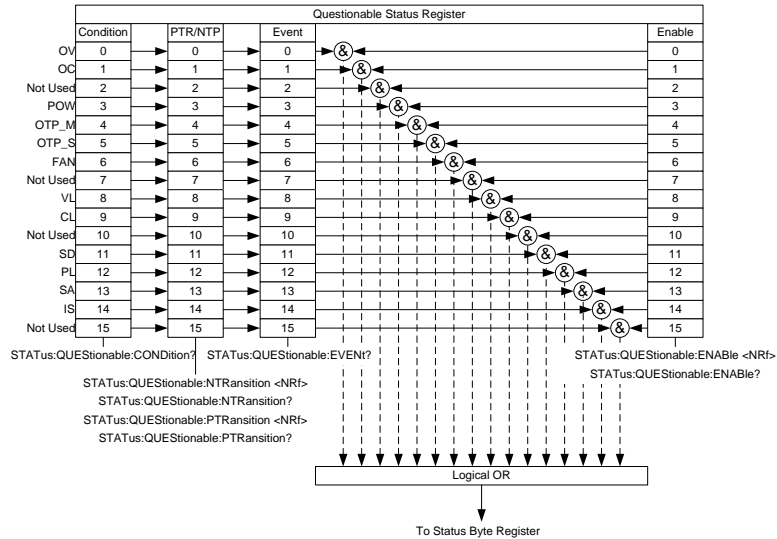

Bit Summary	Event	Bit #	Bit Weight
	OV (Over-Voltage)	0	1
	Over voltage protection has been tripped		
	OC (Over-Current)	1	2
	Over current protection has been tripped		
	POW (AC Power Off)	3	8
	AC power switch is off		

OTP_M (Over Temperature Protection Master Board)	4	16
Over temperature protection has been tripped on the master		
OTP_S (Over Temperature Protection Slave Board)	5	32
Over temperature protection has been tripped on the slave		
FAN failure	6	64
VL (Voltage Limit)	8	256
Voltage limit has been reached		
CL (Current Limit)	9	512
Current limit has been reached		
SD (Shutdown Alarm)	11	2048
PL (Power-Limit)	12	4096
SA (Sense Alarm)	13	8192
IS (Instrument Summary)	14	16384

Condition Register The Questionable Status Condition Register indicates the status of the power supply. If a bit is set in the Condition register, it indicates that the event is true. Reading the condition register does not change the state of the condition register.

PTR/NTR Filters The PTR/NTR (Positive/Negative transition) register determines the type of transition conditions that will set the corresponding bit in the Event Registers. Use the Positive transition filter to view events that change from false to positive, and use the negative transition filter to view events that change from positive to negative.

Positive Transition	0→1
Negative Transition	1→0

Event Register The PTR/NTR Register will dictate the type of transition conditions will set the corresponding bits in the Event Register. If the Event Register is read, it will be cleared to 0.

Enable Register The Enable register determines which Events in the Event Register will be used to set the QUES bit in the Status Byte Register.

Instrument Summary Registers

The Instrument Summary Registers indicate if the protection mode or limit of any of the instruments connected in Multi-Drop mode has been tripped.

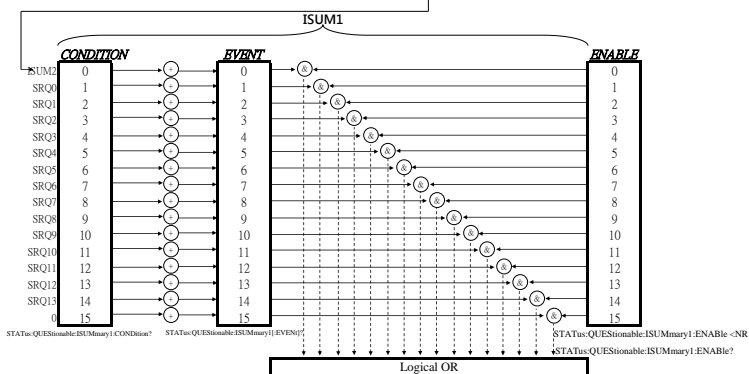
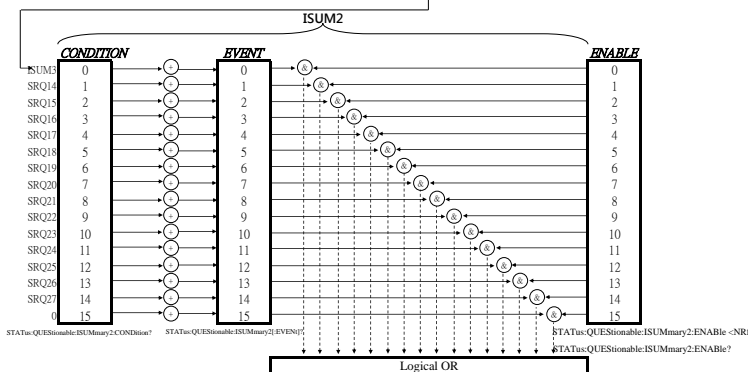
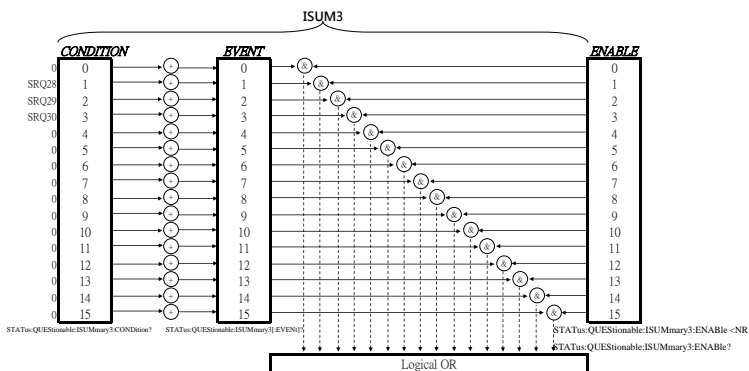

To Instrument Summary in Questionable Condition register (bit 14)

Operation Status Register Group

Overview

The Operation Status Register Group indicates the operating status of the power supply.

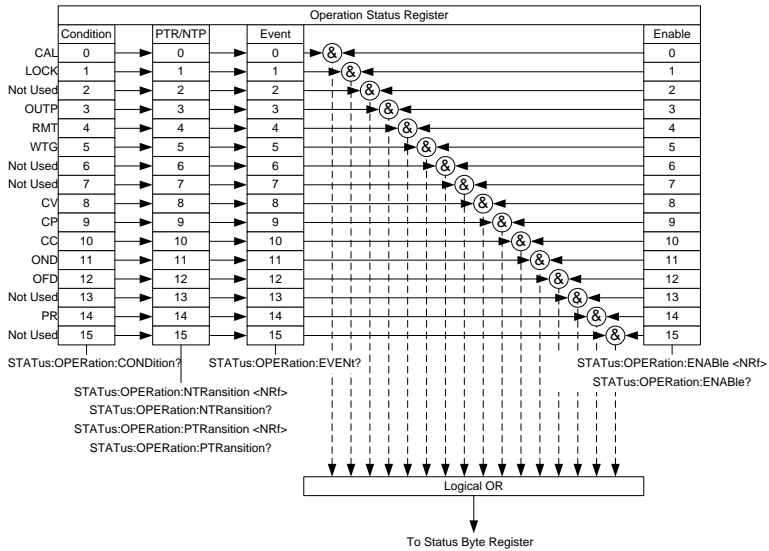

Bit Summary

Event	Bit #	Bit Weight
CAL (Calibration mode) Indicates if the PSU is in calibration mode.	0	1
LOCK (Lock State) Indicates if the PSU is in lock mode.	1	2
OUTP (Output State) Indicates the output status of PSU.	3	8
RMT (Output State) Indicates if the PSU is in remote mode.	4	16

WTG (Waiting for trigger)	5	32
Indicates if the PSU is waiting for a trigger.		
CV (Constant voltage mode)	8	256
Indicates if the PSU is in CV mode.		
CP (Constant power mode)	9	512
Indicates if the PSU is in CP mode.		
CC (Constant current mode)	10	1024
Indicates if the PSU is in CC mode.		
OND (Output ON Delay)	11	2048
Indicates if Output ON delay time is active		
OFD (Output OFF Delay)	12	4096
Indicates if Output OFF delay time is active		
PR (Program Running)	14	16384
Indicates if a Test is running		

Condition Register The Operation Status Condition Register indicates the operating status of the power supply. If a bit is set in the Condition register, it indicates that the event is true. Reading the condition register does not change the state of the condition register.

PTR/NTR Filters The PTR/NTR (Positive/Negative transition) register determines the type of transition conditions that will set the corresponding bit in the Event Registers. Use the Positive transition filter to view events that change from false to positive, and use the negative transition filter to view events that change from positive to negative.

	Positive Transition	0→1
	Negative Transition	1→0

Event Register	The PTR/NTR Register will dictate the type of transition conditions will set the corresponding bits in the Event Register. If the Event Register is read, it will be cleared to 0.
----------------	--

Enable Register	The Enable register determines which registered Events in the Event Register will be used to set the OPER bit in the Status Byte Register.
-----------------	--

Standard Event Status Register Group

Overview

The Standard Event Status Register Group indicates if any errors have occurred. The bits of the Event register are set by the error event queue.

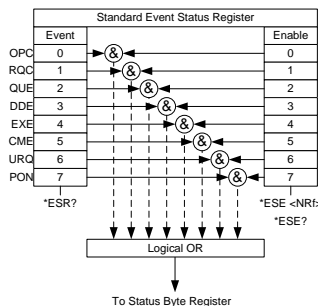

Bit Summary

Event	Bit #	Bit Weight
OPC (Operation complete)	0	1
The OCP bit is set when all selected pending operations are complete. This bit is set in response to the *OPC command.		
RQC (Request control)	1	2
QUE (Query Error)	2	4
The Query Error bit is set in response to an error reading the Output Queue. This can be caused by trying to read the Output Queue when there is no data present.		
DDE (Device Dependent Error)	3	8
Device specific error.		

	EXE (Execution Error)	4	16
	The EXE bit indicates an execution error due to one of the following: illegal command parameter, parameter out of range, invalid parameter, the command didn't execute due to an overriding operation condition.		
	CME (Command Error)	5	32
	The CME bit is set when a syntax error has occurred. The CME bit can also be set when a <GET> command is received within a program message.		
	URQ (User Request)	6	64
	PON (Power On)	7	128
	Indicates the power is turned on.		
Event Register	Any bits set in the event register indicate that an error has occurred. Reading the Event register will reset the register to 0.		
Enable Register	The Enable register determines which Events in the Event Register will be used to set the ESB bit in the Status Byte Register.		

Status Byte Register & Service Request Enable Register

Overview

The Status Byte register consolidates the status events of all the status registers. The Status Byte register can be read with the *STB? query and can be cleared with the *CLS command.

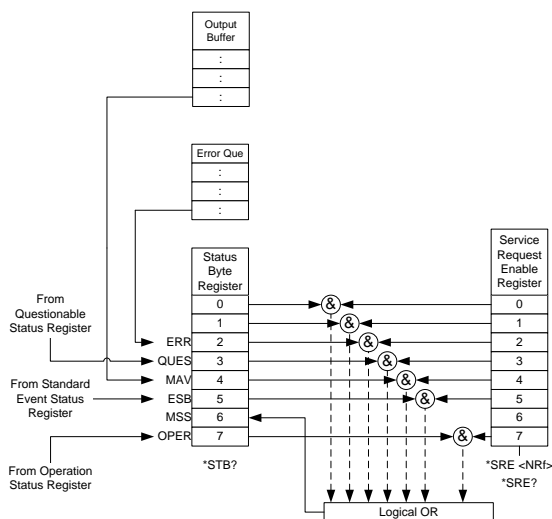

Bit Summary	Event	Bit #	Bit Weight
	ERR (Error Event/Queue)	2	4
	If data is present in the Error queue, the ERR bit will be set.		
	QUES (Questionable Status Register)	3	8
	The summary bit for the Questionable Status Register group.		
	MAV (Message Available)	4	16
	This is set when there is data in the Output Queue waiting to be read.		

	(ESB) Event Summary Bit. The ESB is the summary bit for the Standard Event Status Register group.	5	32
	MSS Bit The MSS Bit is the summary of the Status Byte Register and Service Request register (bits 1-5, 7). This will be set to 1.	6	64
	OPER (Operation Status Register) Group. OPER bit is the summary bit for the Operation Status Register Group.	7	128
Status Byte Register	Any bits set in the Status byte register acts as a summary register for all the three other status registers and indicates if there is a service request, an error in the Error Queue or data in the Output Queue. Reading the Status Byte register will reset the register to 0.		
Service Request Enable Register	The Service Request Enable Register controls which bits in the Status Byte Register are able to generate service requests.		

Error List

Command Errors

Overview An <error/event number> in the range [-199 , -100] indicates that an IEEE 488.2 syntax error has been detected by the instrument's parser. The occurrence of any error in this class shall cause the command error bit (bit 5) in the event status register (IEEE 488.2, section 11.5.1) to be set. One of the following events has occurred:

- An IEEE 488.2 syntax error has been detected by the parser. That is, a controller-to-device message was received which is in violation of the IEEE 488.2 standard. Possible violations include a data element which violates the device listening formats or whose type is unacceptable to the device.
- An unrecognized header was received. Unrecognized headers include incorrect device-specific headers and incorrect or unimplemented IEEE 488.2 common commands.

Events that generate command errors shall not generate execution errors, device-specific errors, or query errors; see the other error definitions in this chapter.

Error Code	Description
-100 Command Error	This is the generic syntax error for devices that cannot detect more specific errors. This code indicates only that a Command Error as defined in IEEE 488.2,11.5.1.1.4 has occurred.
-102 Syntax error	An unrecognized command or data type was encountered; for example, a string was received when the device does not accept strings.
-103 Invalid separator	The parser was expecting a separator and encountered an illegal character; for example, the semicolon was omitted after a program message unit, MEAS:VOLT:DC?:MEASCURR:DC?
-104 Data type error	The parser recognized a data element different than one allowed; for example, numeric or string data was expected but block data was encountered.
-108 Parameter not allowed	More parameters were received than expected for the header; for example, the KLOCK command only accepts one parameter, so receiving SYSTem:KLOCK 1,0 is not allowed.
-109 Missing parameter	Fewer parameters were received than required for the header; for example, the KLOCK command requires one parameter, so receiving KLOCK is not allowed.
-111 Header separator error	A character which is not a legal header separator was encountered while parsing the header; for example, no white space followed the header, thus *SRE2 is an error.

- 112 Program mnemonic too long The header contains more than twelve characters (see IEEE 488.2, 7.6.1.4.1).
- 113 Undefined header The header is syntactically correct, but it is undefined for this specific device; for example, *XYZ is not defined for any device.
- 114 Header suffix out of range The value of a numeric suffix attached to a program mnemonic, see Syntax and Style section 6.2.5.2, makes the header invalid.
- 115 Unexpected number of parameters The number of parameters received does not correspond to the number of parameters expected. This is typically due to an inconsistency with the number of instruments in the selected group.
- 120 Numeric data error This error, as well as errors -121 through -129, are generated when parsing a data element which appears to be numeric, including the nondecimal numeric types. This particular error message should be used if the device cannot detect a more specific error.
- 121 Invalid character in number An invalid character for the data type being parsed was encountered; for example, an alpha in a decimal numeric or a "9" in octal data.
- 128 Numeric data not allowed A legal numeric data element was received, but the device does not accept one in this position for the header.
- 131 Invalid suffix The suffix does not follow the syntax described in IEEE 488.2, 7.7.3.2, or the suffix is inappropriate for this device.

-
- | | |
|----------------------------------|---|
| -141 Invalid character data | Either the character data element contains an invalid character or the particular element received is not valid for the header. |
| -148 Character data not allowed | A legal character data element was encountered where prohibited by the device. |
| -151 Invalid string data | A string data element was expected, but was invalid for some reason (see IEEE 488.2, 7.7.5.2); for example, an END message was received before the terminal quote character. |
| -158 String data not allowed | A string data element was encountered but was not allowed by the device at this point in parsing. |
| -160 Block data error | This error, as well as errors -161 through -169, are generated when parsing a block data element. This particular error message should be used if the device cannot detect a more specific error. |
| -161 Invalid block data | A block data element was expected, but was invalid for some reason (see IEEE 488.2, 7.7.6.2); for example, an END message was received before the length was satisfied. |
| -168 Block data not allowed | A legal block data element was encountered but was not allowed by the device at this point in parsing. |
| -178 Expression data not allowed | A legal expression data was encountered but was not allowed by the device at this point in parsing. |

Execution Errors

Overview An <error/event number> in the range [-299 , -200] indicates that an error has been detected by the instrument's execution control block. The occurrence of any error in this class shall cause the execution error bit (bit 4) in the event status register (IEEE 488.2, section 11.5.1) to be set. One of the following events has occurred:

- A <PROGRAM DATA> element following a header was evaluated by the device as outside of its legal input range or is otherwise inconsistent with the device's capabilities.
- A valid program message could not be properly executed due to some device condition.

Execution errors shall be reported by the device after rounding and expression evaluation operations have taken place. Rounding a numeric data element, for example, shall not be reported as an execution error. Events that generate execution errors shall not generate Command Errors, device-specific errors, or Query Errors; see the other error definitions in this section.

Error Code	Description
-200 Execution error	This is the generic syntax error for devices that cannot detect more specific errors. This code indicates only that an Execution Error as defined in IEEE 488.2, 11.5.1.1.5 has occurred.

-201 Invalid while in local Indicates that a command is not executable while the device is in local due to a hard local control (see IEEE 488.2, 5.6.1.5); for example, a device with a rotary switch receives a message which would change the switches state, but the device is in local so the message cannot be executed.

-203 Command protected Indicates that a legal password-protected program command or query could not be executed because the command was disabled.

-211 Trigger ignored Indicates that a GET, *TRG, or triggering signal was received and recognized by the device but was ignored because of device timing considerations; for example, the device was not ready to respond. Note: a DT0 device always



A DT0 device always ignores GET and treats *TRG as a Command Error.

-213 Init ignored Indicates that a request for a measurement initiation was ignored as another measurement was already in progress.

-220 Parameter error Indicates that a program data element related error occurred. This error message should be used when the device cannot detect the more specific errors described for errors -221 through -229.

-221 Settings conflict Indicates that a legal program data element was parsed but could not be executed due to the current device state (see IEEE 488.2, 6.4.5.3 and 11.5.1.1.5.).

-222 Data out of range Indicates that a legal program data element was parsed but could not be executed because the interpreted value was outside the legal range as defined by the device (see IEEE 488.2, 11.5.1.1.5.).

-224 Illegal parameter value Used where exact value, from a list of possibles, was expected.

Device Specific Errors

Overview An <error/event number> in the range [-399 , -300] or [1 , 32767] indicates that the instrument has detected an error which is not a command error, a query error, or an execution error; some device operations did not properly complete, possibly due to an abnormal hardware or firmware condition. These codes are also used for self-test response errors. The occurrence of any error in this class should cause the device-specific error bit (bit 3) in the event status register (IEEE 488.2, section 11.5.1) to be set. The meaning of positive error codes is device-dependent and may be enumerated or bit mapped; the <error message>string for positive error codes is not defined by SCPI and available to the device designer.



Note

The string is not optional; if the designer does not wish to implement a string for a particular error, the null string should be sent (for example, 42, ""). The occurrence of any error in this class should cause the device-specific error bit (bit 3) in the event status register (IEEE 488.2, section 11.5.1) to be set. Events that generate device-specific errors shall not generate command errors, execution errors, or query errors; see the other error definitions in this section.

Error Code	Description
-310 System error	Indicates that some error, termed "system error" by the device, has occurred. This code is device-dependent.

-320 Storage fault Indicates that the firmware detected a fault when using data storage. This error is not an indication of physical damage or failure of any mass storage element.

Query Errors

Overview An <error/event number> in the range [-499 , -400] indicates that the output queue control of the instrument has detected a problem with the message exchange protocol described in IEEE 488.2, chapter 6. The occurrence of any error in this class shall cause the query error bit (bit 2) in the event status register (IEEE 488.2, section 11.5.1) to be set. These errors correspond to message exchange protocol errors described in IEEE 488.2, section 6.5. One of the following is true:

- An attempt is being made to read data from the output queue when no output is either present or pending;
- Data in the output queue has been lost.

Events that generate query errors shall not generate command errors, execution errors, or device-specific errors; see the other error definitions in this section.

Error Code	Description
-400 Query error	This is the generic query error for devices that cannot detect more specific errors. This code indicates only that a Query Error as defined in IEEE 488.2, 11.5.1.1.7 and 6.3 has occurred.

A PPENDIX

PSU Factory Default Settings	162
PSU Preset Default Settings	165
Error Messages & Messages	166
LED ASCII Table Character Set.....	167

PSU Factory Default Settings

The following default settings are the factory configuration settings for the power supply (Function settings/Test settings).

Initial Settings	Default Setting	
Output	Off	
LOCK	0 (Disabled)	
Voltage	0V	
Current	0A	
OVP	1.1 X Vrate	
OCP	1.1 X Irate	
Normal Function Settings	Setting	Default Setting
Output ON delay time	F-01	0.00s
Output OFF delay time	F-02	0.00s
V-I mode slew rate select	F-03	0 = CV high speed priority
Internal resistance setting	F-08	0.000Ω
Bleeder circuit control	F-09	1 = ON
Buzzer ON/OFF control	F-10	1 = ON
OCP Delay Time	F-12	0.1 (seconds)
Current Setting Limit	F-13	0 = OFF
Voltage Setting Limit	F-14	0 = OFF
Display Memory parameter when recalling	F-15	0 = OFF
Auto parallel Control	F-16	0 = OFF
Measurement Average Setting	F-17	0 = Low
Alarm Recovery and Output Status	F-18	0 = Safe Mode
Lock Mode	F-19	0:Lock Panel, Allow Output OFF
USB / GPIB setting	Setting	Default Setting
Setup Rear USB Speed	F-22	2 = Auto detect
GPIB address	F-23	8
GPIB Enable/Disable	F-24	1 = Enable
SCPI Emulation	F-26	0 = GW Instek
LAN setting	Setting	Default Setting
LAN	F-36	1 = Enable
DHCP	F-37	1 = Enable

Socket Server Enable/Disable	F-57	1 = Enable
Web Server Enable/Disable	F-59	1 = Enable
Web Password Enable/Disable	F-60	1 = Enable
UART setting	Setting	Default Setting
UART Mode	F-70	1 = Enable
UART Baudrate	F-71	7 = 115200
UART Data Bits	F-72	1 = 8 bits
UART Parity	F-73	0 = None
UART Stop Bit	F-74	0 = 1 bit
UART Transmission Control Protocol	F-75	0 = SCPI
UART Address	F-76	30
UART Multi-Drop control	F-77	0 = Disable
Power On Configuration setting	Setting	Default Setting
CV Control	F-90	0 = Panel control (local)
CC Control	F-91	0 = Panel control (local)
Output Status when Power ON	F-92	0 = Safe Mode
Master/Slave	F-93	0 = Independent
External Out Logic	F-94	0 = High ON
Monitor Voltage Select	F-96	0 = 5V
Control Range	F-97	0 = 5V[5kΩ]
External Output Control Function	F-98	0 = OFF

Trigger Input and Output Configuration Settings	Setting	Default Setting
Trigger Input Pulse Width	F100	0 = trigger controlled by trigger level.
Trigger Input Action	F102	0 = None
Output State When Receiving Trigger	F103	0 = OFF
Apply Voltage Setting on Trigger	F104	0 = 0V
Apply Current Setting on Trigger	F105	0 = 0A
Recall memory number	F106	1 = M1
Trigger Output Pulse Width	F120	0ms
Trigger Output Level	F121	0 = LOW
Trigger Source	F122	0 = None

PSU Preset Default Settings

The USB / GPIB / LAN / UART settings and Power On Configuration settings maintain user settings, and other settings are the same as the factory default settings.

For details on how to return to the preset default settings, refer to the *RST or :SYST:PRES remote command.

Error Messages & Messages

The following error messages or messages may appear on the PSU screen during operation.

Error Messages	Description
OHP	Master & slave board over temperature protection in PSU
OHP1	Master board over temperature protection in PSU
OHP2	Slave board over temperature protection in PSU
ALM SENS	Sense Alarm
HW OVP	Hardware over voltage protection
AC	AC fail
OVP	Over voltage protection
OCP	Over current protection
FAN FAIL	Fan failure
SHUT DOWN	Force shutdown
Err 001	USB mass storage is not present
Err 002	No (such) file in USB mass storage
Err 003	Empty memory location
Err 004	File access error
Err 007	Slave occurs Off-line (Multi-drop mode)

Normal Messages	Description
MSG 001	External control of output. Output off (F-94=0, High=on)
MSG 002	External control of output. Output off (F-94=1, Low=on)

Communication Interface Messages	
Interface Messages	Description
USB ON	Rear USB port connected to PC
USB OFF	Rear USB port disconnected from PC
MS ON	Mass storage plugged into front USB port
MS OFF	Mass storage removed from front USB port

LED ASCII Table Character Set

Use the following table to read the LCD display messages.

0	1	2	3	4	5	6	7	8	9	A	B	C	D
0	1	2	3	4	5	6	7	8	9	A	b	C	d
E	F	G	H	I	J	K	L	M	N	O	P	Q	R
E	F	G	H	I	J	K	L	M	N	O	P	Q	R
S	T	U	V	W	X	Y	Z	()	+	-	,	
S	T	U	V	W	X	Y	Z	()	+	-	,	

INDEX

Accessories	11
Caution symbol	4
Cleaning the instrument.....	6
Configuration	
normal function settings	
operation	22
power on configuration operation	24
table.....	26
Display diagram	17
Display format	167
Disposal instructions.....	6
EN61010	
measurement category	5
pollution degree	6
Environment	
safety instruction.....	6
Error messages.....	166
Ethernet	
interface.....	59
sockets	62
web server.....	59
Factory default settings	162
Front panel diagram	14
Ground	
symbol	4
LED conversion	167
List of features	10
Messages.....	166
Model differences.....	9
Optional accessories.....	11
Package contents.....	11
Power on/off	
safety instruction	5
Preset default settings	165
Rear panel diagram.....	19
Remote control.....	33
Command list.....	71
Command syntax.....	68
Error list	152
Ethernet configuration	59
Ethernet function check	60
GPIB configuration.....	37
GPIB function check	38
interface configuration.....	35
local bus configuration.....	47, 51
multi-unit configuration	47, 51
multi-unit function check	55
sockets configuration	62
sockets function check.....	63
Status registers	139
UART configuration.....	42
UART function check.....	46, 56, 57
USB configuration.....	35
USB function check.....	36
Service operation	
about disassembly	5
Socket server function check	63
UK power cord.....	7
Warning symbol	4
Web server function check	60