

Multi-Range DC Power Supply

PSB-1000 Series

USER MANUAL

GW INSTEK PART NO. 82SB-18000E01



ISO-9001 CERTIFIED MANUFACTURER

GW INSTEK

This manual contains proprietary information, which is protected by copyright. All rights are reserved. No part of this manual may be photocopied, reproduced or translated to another language without prior written consent of Good Will company.

The information in this manual was correct at the time of printing. However, Good Will continues to improve products and reserves the rights to change specification, equipment, and maintenance procedures at any time without notice.

Good Will Instrument Co., Ltd.
No. 7-1, Jhongsing Rd., Tucheng Dist., New Taipei City 236, Taiwan.

Table of Contents

| | |
|--------------------------------------|------------|
| SAFETY INSTRUCTIONS | 5 |
| GETTING STARTED | 9 |
| PSB-1000 Series Overview | 11 |
| Appearance | 15 |
| Theory of Operation | 29 |
| OPERATION | 41 |
| Set Up | 43 |
| Basic Operation | 65 |
| Advanced Settings | 77 |
| Power On Configuration | 86 |
| Parallel/Series Operation | 98 |
| File Operations | 118 |
| Sequence Function | 127 |
| Trigger Input & Output | 138 |
| EXTERNAL CONTROL | 143 |
| Analog Control | 144 |
| Remote Monitoring | 161 |
| COMMUNICATION INTERFACE | 166 |
| Interface Configuration | 167 |
| FAQ | 187 |
| APPENDIX | 188 |
| PSB-1000 Default Settings | 188 |
| PSB-1000 Specifications | 190 |
| PSB-1000 Dimensions | 200 |
| Declaration of Conformity | 201 |

INDEX.....202

S SAFETY INSTRUCTIONS

This chapter contains important safety instructions that you must follow during operation and storage. Read the following before any operation to ensure your safety and to keep the instrument in the best possible condition.

Safety Symbols

These safety symbols may appear in this manual or on the instrument.



WARNING

Warning: Identifies conditions or practices that could result in injury or loss of life.



CAUTION

Caution: Identifies conditions or practices that could result in damage to the PSB-1000 or to other properties.



DANGER High Voltage



Attention Refer to the Manual



Protective Conductor Terminal



Earth (ground) Terminal



Do not dispose electronic equipment as unsorted municipal waste. Please use a separate collection facility or contact the supplier from which this instrument was purchased.

Safety Guidelines

General Guideline



CAUTION

- Do not place any heavy object on the PSB-1000.
- Avoid severe impact or rough handling that leads to damaging the PSB-1000.
- Do not discharge static electricity to the PSB-1000.
- Use only mating connectors, not bare wires, for the terminals.
- Do not block the cooling fan opening.
- Do not disassemble the PSB-1000 unless you are qualified.

(Measurement categories) EN 61010-1:2010 specifies the measurement categories and their requirements as follows. The PSB-1000 doesn't fall under category II, III or IV.

- Measurement category IV is for measurement performed at the source of low-voltage installation.
- Measurement category III is for measurement performed in the building installation.
- Measurement category II is for measurement performed on the circuits directly connected to the low voltage installation.
- 0 is for measurements performed on circuits not directly connected to Mains.

Power Supply



WARNING

- AC Input voltage range: 100Vac to 240Vac
 - Frequency: 47Hz-63Hz
 - To avoid electrical shock connect the protective grounding conductor of the AC power cord to an earth ground.
-

- Cleaning the PSB-1000
- Disconnect the power cord before cleaning.
 - Use a soft cloth dampened in a solution of mild detergent and water. Do not spray any liquid.
 - Do not use chemicals containing harsh material such as benzene, toluene, xylene, and acetone.

- Operation Environment
- Location: Indoor, no direct sunlight, dust free, almost non-conductive pollution (Note below)
 - Relative Humidity: 20%- 85%, no condensation
 - Altitude: Maximum 2000m
 - Temperature: 0°C to 40°C

(Pollution Degree) EN 61010-1:2010 specifies the pollution degrees and their requirements as follows. The PSB-1000 falls under degree 2.

Pollution refers to “addition of foreign matter, solid, liquid, or gaseous (ionized gases), that may produce a reduction of dielectric strength or surface resistivity”.

- Pollution degree 1: No pollution or only dry, non-conductive pollution occurs. The pollution has no influence.
- Pollution degree 2: Normally only non-conductive pollution occurs. Occasionally, however, a temporary conductivity caused by condensation must be expected.
- Pollution degree 3: Conductive pollution occurs, or dry, non-conductive pollution occurs which becomes conductive due to condensation which is expected. In such conditions, equipment is normally protected against exposure to direct sunlight, precipitation, and full wind pressure, but neither temperature nor humidity is controlled.

- Storage environment
- Location: Indoor
 - Temperature: -25°C to 70°C
 - Relative Humidity: ≤90%, no condensation

Disposal



Do not dispose this instrument as unsorted municipal waste. Please use a separate collection facility or contact the supplier from which this instrument was purchased. Please make sure discarded electrical waste is properly recycled to reduce environmental impact.

Power cord for the United Kingdom

When using the instrument in the United Kingdom, make sure the power cord meets the following safety instructions.

NOTE: This lead/appliance must only be wired by competent persons



WARNING: THIS APPLIANCE MUST BE EARTHED

IMPORTANT: The wires in this lead are coloured in accordance with the following code:

| | |
|----------------|--------------|
| Green/ Yellow: | Earth |
| Blue: | Neutral |
| Brown: | Live (Phase) |



As the colours of the wires in main leads may not correspond with the coloured marking identified in your plug/appliance, proceed as follows:

The wire which is coloured Green & Yellow must be connected to the Earth terminal marked with either the letter E, the earth symbol \oplus or coloured Green/Green & Yellow.

The wire which is coloured Blue must be connected to the terminal which is marked with the letter N or coloured Blue or Black.

The wire which is coloured Brown must be connected to the terminal marked with the letter L or P or coloured Brown or Red.

If in doubt, consult the instructions provided with the equipment or contact the supplier.

This cable/appliance should be protected by a suitably rated and approved HBC mains fuse: refer to the rating information on the equipment and/or user instructions for details. As a guide, a cable of 0.75mm² should be protected by a 3A or 5A fuse. Larger conductors would normally require 13A types, depending on the connection method used.

Any exposed wiring from a cable, plug or connection that is engaged in a live socket is extremely hazardous. If a cable or plug is deemed hazardous, turn off the mains power and remove the cable, any fuses and fuse assemblies. All hazardous wiring must be immediately destroyed and replaced in accordance to the above standard.

G E T T I N G S T A R T E D

This chapter describes the power source in a nutshell, including its main features and front / rear panel introduction.



| | |
|---------------------------------------|-----------|
| PSB-1000 Series Overview | 11 |
| Series lineup..... | 11 |
| Main Features..... | 12 |
| Accessories..... | 13 |
| Appearance | 15 |
| Front Panel..... | 15 |
| Rear Panel (PSB-1800L/M)..... | 18 |
| Rear Panel (PSB-1400L/M)..... | 18 |
| Status Bar Icons | 21 |
| Menu Reference | 23 |
| Theory of Operation | 29 |
| Operating Area Description..... | 29 |
| CC and CV Mode | 30 |
| Slew Rate..... | 32 |
| Bleeder Control..... | 32 |
| Internal Resistance..... | 33 |

| | |
|---------------------|----|
| Alarms | 34 |
| Considerations..... | 36 |
| Grounding | 39 |

PSB-1000 Series Overview

Series lineup

The PSB-1000 Series consists of 4 models: PSB-1400L, PSB-1400M, PSB-1800L, and PSB-1800M. Note that throughout the user manual, the term “PSB-1000” refers to all the models in the PSB-1000 Series lineup, unless stated otherwise.



| Model name | Output Voltage | Output Current | Output Power |
|------------|----------------|----------------|--------------|
| PSB-1400L | 40 | 40 | 400 |
| PSB-1400M | 160 | 10 | 400 |
| PSB-1800L | 40 | 80 | 800 |
| PSB-1800M | 160 | 20 | 800 |

Main Features

| | |
|-------------|---|
| Performance | <ul style="list-style-type: none">• Maximum output voltage of 160V• Maximum output current of 80A |
| Features | <ul style="list-style-type: none">• OVP, OCP and OTP protection• Low AC input protection• Sequence function• Large 3.5 inch LCD panel• 100V - 240V power inlet• Multi-range output power• Bleeder circuit ON/OFF setting• CV, CC priority start function• Internal resistance setting function• Parallel master/slave operation with active current sharing• Remote sensing to compensate for voltage drop in load leads• Analog output programming and monitoring |
| Interface | <ul style="list-style-type: none">• Ethernet port• USB host• USB CDC• GPIB (optional)• External Control I/O |

Accessories

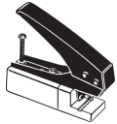
| Standard Accessories | Part number | Description |
|----------------------|-------------|--|
| | CD ROM | User manual, programming manual |
| | | Power cord |
| | PSW-009 | Output terminal cover |
| | GTL-240 | Type A - B USB Cable |
| | PSB-106 | Basic Accessory Kit: M4 terminal screws and washers x2, M8 terminal bolts, nuts and washers x2, Analog control protection dummy x1, analog control lock level x2, short bar x1. |

| Optional Accessories | Part number | Description |
|----------------------|-------------|---|
| | PSW-001 | Analog remote control connector kit: Socket x 1pc Pins x 10pcs Protection cover x 1 set Chassis connection wire x 1 |
| | PSW-002 | Simple IDC tool  |
| | PSW-003 | Contact removal tool  |





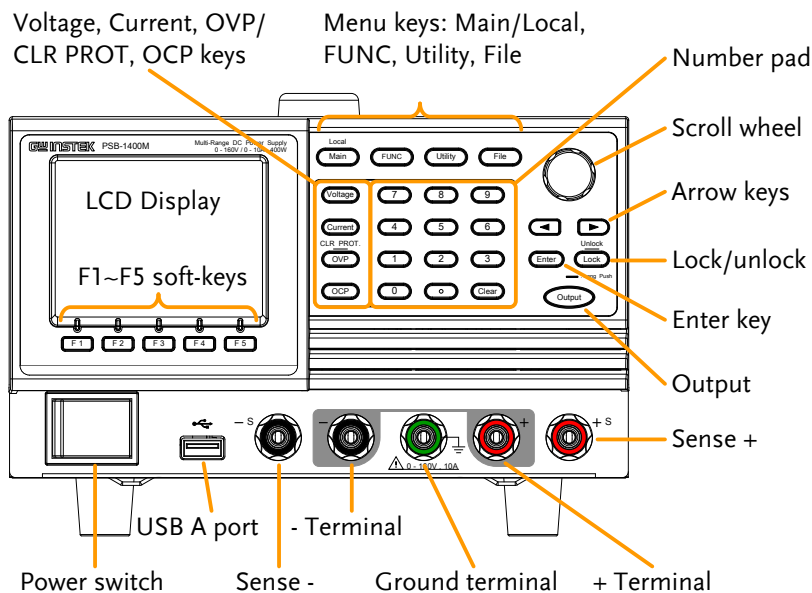

| | | |
|----------|--------------|---|
| | PSB-101 | Cable for 2 units of PSB-1000 units in parallel mode connection |
| | PSB-102 | Cable for 3 units of PSB-1000 units in parallel mode connection |
| | PSB-103 | Cable for 4 units of PSB-1000 units in parallel mode connection |
| | PSB-104 | Cable for 2 units of PSB-1000 units in series mode connection |
| | PSB-105 | GPIB card |
| | GRA-418-J | Rack-mount adapter(JIS) |
| | GRA-418-E | Rack-mount adapter(EIA) |
| | GTL-123 | Test leads: 1x red, 1x black |
| Download | Name | Description |
| | gw_psb1k.inf | USB driver |



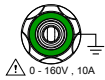

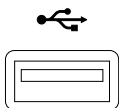
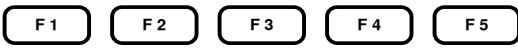

Appearance

Front Panel

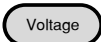
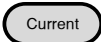

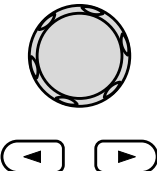
| Item | Description |
|------------------------------|---------------------------|
| Power Switch | Turns on the mains power. |
| Front Panel Output Terminals | |
| | Positive sense terminal |
| | Positive terminal |

| | | |
|----------------------|---|---|
| |  | <p>Ground terminal</p> |
| |  | <p>Negative terminal</p> |
| |  | <p>Negative sense terminal</p> |
| <p>USB A Port</p> |  | <p>The USB port is used for data transfer, loading test scripts etc.</p> |
| <p>LCD Screen</p> | | <p>Displays the voltage/current settings, measurement readings and menu systems.</p> |
| <p>Function Keys</p> |  | <p>Assigned to the soft-keys displayed on the bottom of the screen.</p> |
| <p>Main Key</p> |  | <p>Returns operation to the main operation screen.</p> |
| <p>Local Key</p> | | <p>Pressing the Main/Local key will also return the unit to local mode from remote control mode.</p> |
| <p>FUNC Key</p> |  | <p>Enters the Function menu. The function menu contains Power On Configuration settings, Memory settings, Voltage trigger settings and the Sequence menu.</p> |
| <p>Utility Key</p> |  | <p>Enters the Utility menu. The utility menu contains a number of system settings.</p> |
| <p>File Key</p> |  | <p>Pressing the file key allows you to copy, rename and delete files.</p> |

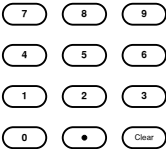
| | | |
|---------------------------|---|--|
| Voltage |  | Sets the constant voltage level. |
| Current |  | Sets the constant current level. |
| OVP |  | Sets the over voltage protection level. |
| CLR PROT | (Long press) | Holding the OVP key will clear any tripped protection functions. |
| OCP |  | Sets the over current protection level. |
| Scroll Wheel & Arrow Keys |  | Both the scroll wheel and arrow keys are used to navigate menu items, pages or for incrementing/decrementing parameter values. |
| Enter |  | Used to confirm settings and menu items. |
| Lock Key/ Unlock Key |  | Locks the front panel keys to prevent accidentally changing panel settings. Note: The output can still be turned off when the key lock in active. |
| Unlock Key | (Long press) | Disables the key lock. |
| Output Key |  | Turns the output on or off. |
| Clear Key |  | Clears entries that are made in the number entry dialogs. |
| Number Pad |  | Used to enter values. |

Rear Panel (PSB-1800L/M)

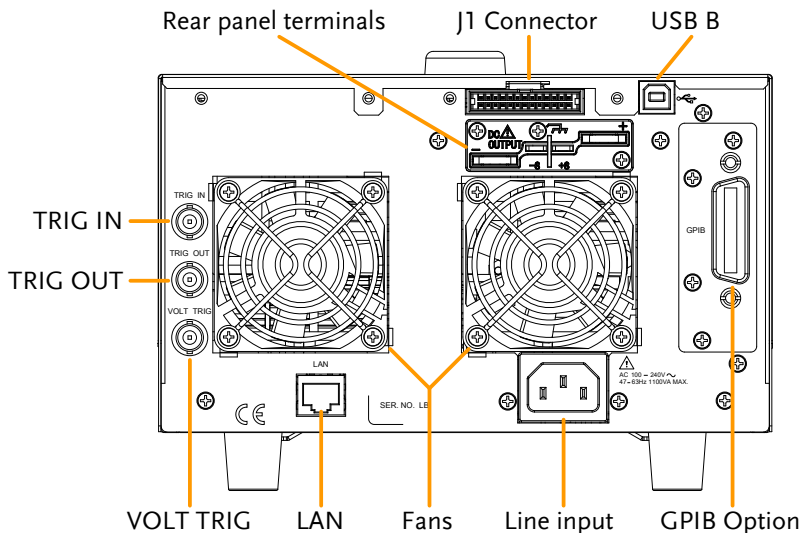

Rear Panel (PSB-1400L/M)

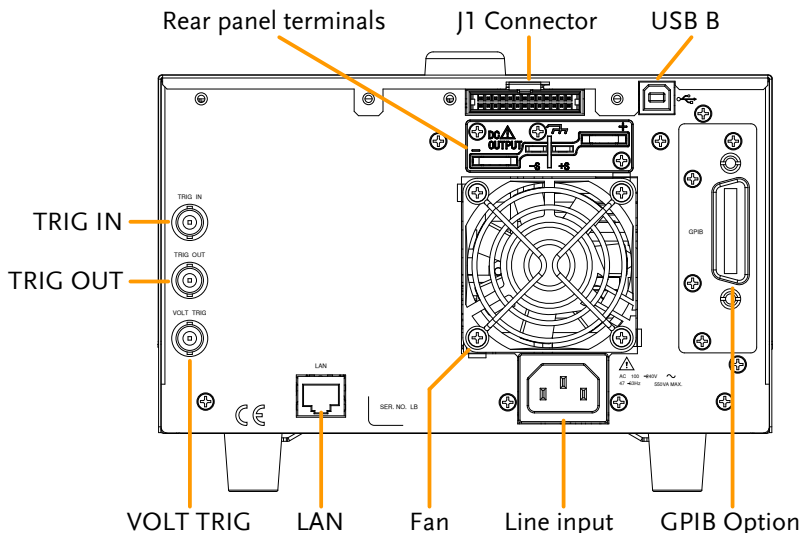

Line Voltage
Input

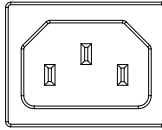

Voltage Input: 100 - 240 VAC
Line frequency: 47 - 63Hz (1100VA
MAX)

Rear panel
terminals

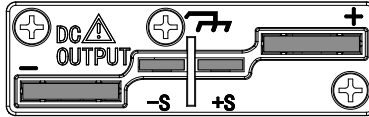

The rear panel terminals contain the positive and negative output terminals, the voltage sense terminals and the ground terminal.

J1 Connector



The J1 Connector is used for external voltage, current control or for parallel/series control.

TRIG IN



Used to receive a signal from an external device.

Apply either a negative-going or a positive-going pulse to the trigger input pin.

TRIG OUT



Used to send a signal to an external device.

The polarity of the trigger output can also be configured.

VOLT TRIG



Outputs a signal according to the Voltage Trigger settings in the Function menu.

The polarity of the voltage trigger can also be configured.

LAN

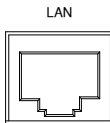

The Ethernet port is used for remote control and digital monitoring from a PC.

USB-B

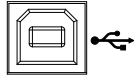

The USB-B port is used for remote control.

GPIB Option

Optional GPIB communication card (PSB-105).







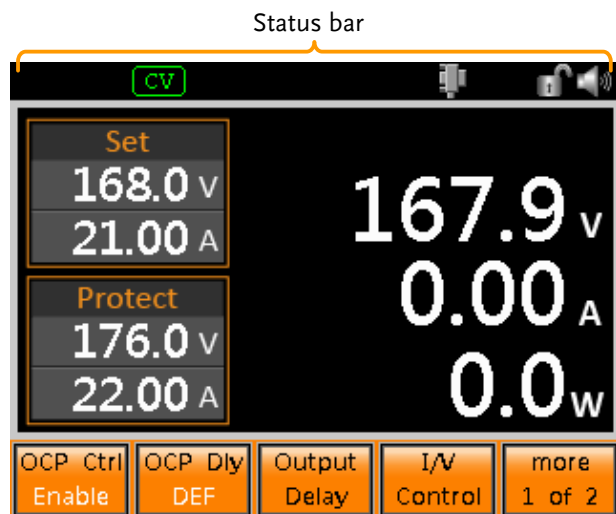





FAN

Temperature controlled fan.

Status Bar Icons



| | | | |
|------------|--|------------|--|
| OFF | Indicates if the output is OFF. | OVP | An alarm icon will appear on the status bar when one of the protection functions is tripped. |
| CV | Indicates that the output is in CV mode. | OCP | |
| CC | Indicates that the output is in CC mode. | OTP | |
| ON | Indicates that the output is operating at 105% of rated power (constant power mode). | RS | (Remote sense fail) Indicates a problem with the remote sense connection. |
| RMT | Indicates that the unit is in remote mode. | PF | (Power fail) Indicates that the external shutdown pin was tripped. |
| | | ALM | Indicates that the instrument has hardware errors. |

| | |
|---|---|
|  Speaker enabled. |  Indicates that the GPIB option is installed and enabled. |
|  Speaker disabled. |  Indicates that the GPIB option is installed and disabled. |
|  Indicates that the panel lock is active. |  Indicates that the instrument is connected with a PC. |
|  Indicates that the panel keys are unlocked. |  Indicates that a USB flash drive is inserted in the front panel USB port. |
|  Indicates that a USB flash drive is inserted in the front panel USB port, but there is an access error. Please re-insert. |  Indicates that the instrument is connected to a LAN. |
|  Indicates that the instrument is connected to a LAN, however, there are configuration errors. Please re-configure the LAN settings. |  Indicates that the PSB-1000 is in LAN remote mode. |
|  Indicates that the PSB-1000 is in LAN remote mode, but there are connection errors. Please re-configure the LAN settings. | |

Menu Reference

| Level | | | | Function/Operation | |
|-------|--------------|-------------|-----------------|---|---|
| 1st | 2nd | 3rd | 4 th | Description | |
| Main | OCP Ctrl | | | Enables/Disables OCP | |
| | OCP Dly | | | Sets OCP delay time | |
| | Output Delay | On Delay | | Sets the Output On delay time | |
| | | Off Delay | | Sets the Output Off delay time. | |
| | I/V Control | CVHS | | | Sets the CV slew rate to the maximum (High Speed) |
| | | CCHS | | | Sets the CC slew rate to the maximum (High Speed) |
| | | CVLS | | | Sets the CV slew rate |
| | | CCLS | | | Sets the CC slew rate |
| | | Exit | | | Exits the I/V control menu. |
| | | more 1 of 2 | INT-R | | |
| | Bleeder | | | Turns the bleeder resistor on or off (of auto). | |
| | Average | | | Sets the average level for the smoothing function (Low, Middle, High) | |
| | More 2 of 2 | | | Returns to the previous page. | |

| | | | | |
|--------------------|-----------------------------|---|------------|--|
| FUNC | View Power On Config. | Modify | CV Control | Sets CV control mode |
| | | | CC Control | Sets CC control mode |
| | | | PON Run | Sets the Power On output settings (Turns the output on or executes a sequence at start up) |
| | | | Track | Sets the tracking mode for multiple units |
| | | | Ext-Out | Sets the Ext-Out line active state |
| | | | Breaker | Sets the breaker resistor |
| | | | Sense | Sets/disables local sense |
| | | | Exit | Exits from the View Power On Config. settings |
| View Memory | M1 | Shows the M1 settings | | |
| | M2 | Shows the M2 settings | | |
| | M3 | Shows the M3 settings | | |
| | Exit | Exits the View Memory menu. | | |
| Voltage Trigger | Vtrig Control | Enable/Disable voltage trigger control | | |
| | Vt1 | Sets the leading edge Vtrig level | | |
| | Vt2 | Sets the trailing edge Vtrig level | | |
| | Polarity | Sets the Vtrig polarity as positive or negative | | |

| | | | |
|-----------------|-------------|------------------------------------|--|
| FUNC (cont.) | TRIG IN | POS | Positive edge |
| | | NEG | Negative edge |
| | | Exit | Exits from the FUNC menu. |
| | TRIG OUT | POS | Positive edge |
| | | NEG | Negative edge |
| | | Exit | Exits from the FUNC menu. |
| Sequence | Load | | Loads the selected sequence |
| | | Exit | Exits the sequence menu |
| | more 1 of 2 | Copy to USB | Copies the selected sequence to USB. |
| | | Copy to SEQX | Copies the selected sequence to another sequence |
| | | Move to SEQX | Move the selected sequence to another sequence |
| | | Clear | Clears the selected sequence from the memory |
| more 2 of 2 | | Returns to the previous menu level | |

| | | | |
|-----------|--------------------|----------|--|
| Utility | System Information | | Shows the serial number and software version |
| | Interface | LAN | MAC Address |
| | | | Host Name |
| | | | LAN Control |
| | | | DHCP |
| | | Rear USB | |
| | | GPIB | |
| Error Log | | LAN Log | |
| | | USB Log | |
| | | GPIB Log | |
| | | Clear | |
| | | Exit | |
| | Speaker | | |
| Lock | | Mode0 | |
| | | Mode1 | |

| | | | |
|--------------------|-----------------|------------|--|
| Utility (cont.) | Color | Brightness | Sets the brightness level |
| | | Contrast | Sets the contrast level |
| | | Default | Default brightness/contrast settings |
| | | Exit | Exits to the previous menu |
| | Factory Setting | Restore | Restore the factory settings |
| | | Exit | Exits to the previous menu |
| | Calibration | | Not applicable to end-users. |
| File | Copy to USB | | Copy the selected file to USB |
| | Copy to Mx | | Copy the selected file to memory location M0~9. |
| | Save | | Saves the current settings to the selected memory setting. |
| | Recall | | Recalls the selected memory setting. |
| | View Memory | | Goes to the View Memory menu. |
| | Copy to memory | | Copies the selected file on the USB drive to memory. |
| | Delete | | Deletes the selected file on the USB drive. |
| | Rename | | Renames the selected file on the USB drive. |

| | |
|---------|----------------------------------|
| Voltage | Sets the voltage output settings |
| Current | Sets the current output settings |
| OVP | Sets the OVP settings |
| OCP | Sets the OCP settings |

Theory of Operation

The theory of operation section describes the basic principles of operation, protection modes and important considerations that must be taken into account before use.

Operating Area Description

Background

The PSB-1000 power supplies are regulated DC power supplies with a high voltage and current output. These operate in CC or CV mode within a wide operating range limited only by the voltage, current or power output.

The operating area of each power supply is determined by the rated output power as well as the voltage and current rating.

Below is a comparison of the operating areas of each power supply.

PSB-1000 Series Output Operating Area

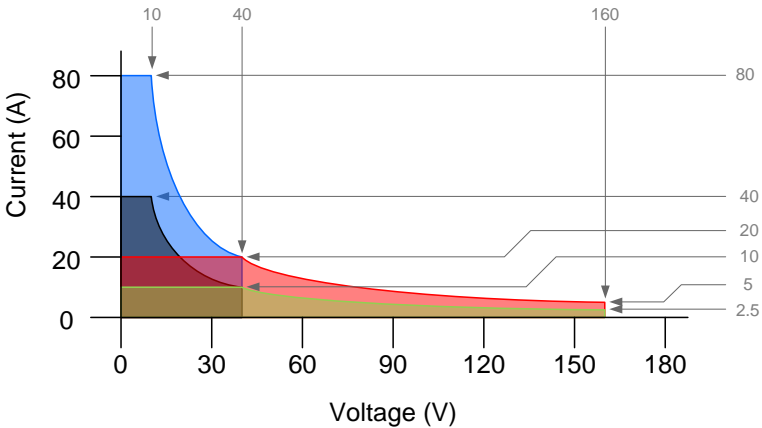

— PSB-1400L — PSB-1800L — PSB-1800M — PSB-1400M

CC and CV Mode

CC and CV mode Description

When the power supply is operating in constant current mode (CC) a constant current will be supplied to the load. When in constant current mode the voltage output can vary, whilst the current remains constant. When the load resistance increases to the point where the set current limit (I_{SET}) can no longer be sustained the power supply switches to CV mode. The point where the power supply switches modes is the crossover point.

When the power supply is operating in CV mode, a constant voltage will be supplied to the load, whilst the current will vary as the load varies. At the point that the load resistance is too low to maintain a constant voltage, the power supply will switch to CC mode and maintain the set current limit.

The conditions that determine whether the power supply operates in CC or CV mode depends on the set current (I_{SET}), the set voltage (V_{SET}), the load resistance (R_L) and the critical resistance (R_C). The critical resistance is determined by V_{SET}/I_{SET} . The power supply will operate in CV mode when the load resistance is greater than the critical resistance. This means that the voltage output will be equal to the V_{SET} voltage but the current will be less than I_{SET} . If the load resistance is reduced to the point that the current output reaches the I_{SET} level, the power supply switches to CC mode.

Conversely the power supply will operate in CC mode when the load resistance is less than the critical resistance. In CC mode the current output is equal to I_{SET} and the voltage output is less than V_{SET} .

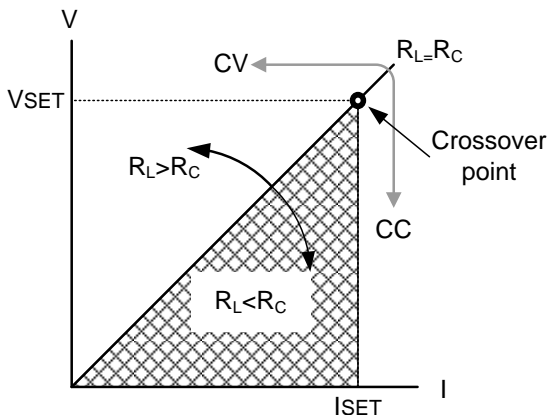

 **Note**

For loads that generate a transient surge voltage, V_{SET} must be set so that the surge voltage does not reach the voltage limit.

For loads in which transient peak current flows, I_{SET} must be set so that the peak value does not reach the current limit.

Slew Rate

Theory

The PSB-1000 has selectable slew rates for CC and CV mode (see page 81 for slew rate control). This gives the PSB-1000 power supply the ability to limit the current/voltage draw of the power supply. Slew rate settings are divided into High Speed and Low Speed. High Speed mode will use the fastest slew rate for the instrument. Low Speed mode allows for user-adjustable slew rates for CC or CV mode. The rising and falling slew rate can be set independently.

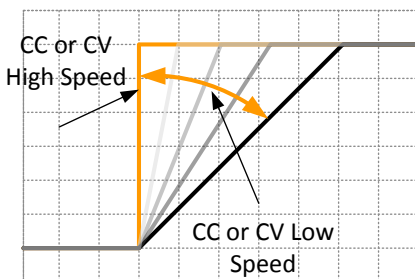

Bleeder Control

Background

The PSB-1000 DC power supplies employ a bleed resistor in parallel with the output terminals.

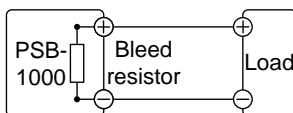

Bleed resistors are designed to dissipate the power from the power supply filter capacitors when power is turned off and the load is

disconnected. Without a bleed resistor, power may remain charged on the filter capacitors for some time and be potentially hazardous.

In addition, bleed resistors also allow for smoother voltage regulation of the power supply as the bleed resistor acts as a minimum voltage load.

The bleed resistance can be turned on or off from the Main setting screen. See page 84 for details.



Note

By default the bleed resistance is on. For battery charging applications, be sure to turn the bleed resistance off as the bleed resistor can discharge the connected battery when the unit is off.

Internal Resistance

Background

On the PSB-1000 the internal resistance of the power supply can be user-defined in software (see page 83). When the internal resistance is set it can be seen as a resistance in series with the positive output terminal. This allows the power supply to simulate power sources that have internal resistances such as lead acid batteries.

By default the internal resistance is 0Ω .

Internal
Resistance Range

| Unit Model | Internal Resistance Range |
|------------|---------------------------|
| PSB-1400L | 0.000~1.000 Ω |
| PSB-1400M | 0.00~16.00 Ω |
| PSB-1800L | 0.000~0.500 Ω |
| PSB-1800M | 0.000~8.000 Ω |

Alarms

The PSB-1000 power supplies have a number of protection features. When one of the protection alarms are tripped, an alarm message will appear on the display the corresponding alarm icon (OCP, OVP etc) will appear in the status bar. When an alarm has been tripped the output will be automatically turned off or the power supply will turn off, depending on the type of alarm and on the Breaker Control settings (page 95). For details on how to clear an alarm or to set the protection modes, please see pages 72, 69 & 71.

| | |
|-------------|--|
| OVP | Over voltage protection (OVP) prevents a high voltage from damaging the load. This alarm can be set by the user. |
| OCP | Over current protection prevents high current from damaging the load. This alarm can be set by the user. |
| OTP | Over temperature protection is a hardware protection function. |
| AC-FAIL | AC Fail. This alarm function is activated when a low AC input is detected. This protection function will turn the output off. |
| Power Limit | This alarm is tripped when over the power limit. This protection function will limit the power to 105% of the rated power. |
| Shutdown | Force Shutdown is not activated as a result of the PSB-1000 series detecting an error. It is a function that is used to turn the output off through the application of a signal from the rear-panel analog programming connector when an abnormal condition occurs. See page 163 for details on alarm monitoring using the analog programming connector. |

Alarm output

Alarms are output via the analog programming connector. The alarm output is an isolated open-collector photo coupler output. See page 163 for details on alarm monitoring using the analog programming connector.

Considerations

The following situations should be taken into consideration when using the power supply.

| | |
|----------------|--|
| Inrush current | When the power supply switch is first turned on, an inrush current is generated. Ensure there is enough power available for the power supply when first turned on, especially if a number of units are turned on at the same time. |
|----------------|--|

| | |
|------------------------|--|
| Pulsed or Peaked loads | When the load has current peaks or is pulsed, it is possible for the maximum current to exceed the mean current value. The PSB-1000 power supply ammeter only indicates mean current values, which means for pulsed current loads, the actual current can exceed the indicated value. For pulsed loads, the current limit must be increased, or a power supply with a greater capacity must be chosen. As shown below, a pulsed load may exceed the current limit and the indicated current on the power supply ammeter. |
|------------------------|--|

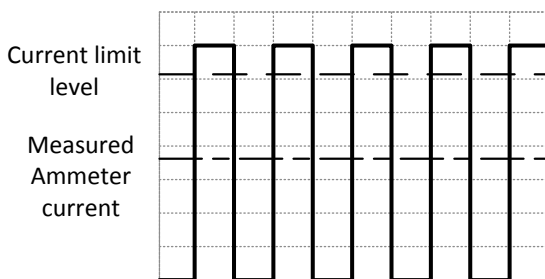

Reverse Current:
Regenerative load

When the power supply is connected to a regenerative load such as a transformer or inverter, reverse current will feed back to the power supply. The PSB-1000 power supply cannot absorb reverse current. For loads that create reverse current, connect a resistor in parallel to the power supply to bypass the reverse current. This description only applies when the bleed resistance is off.

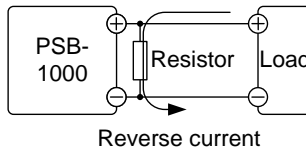

 Note

The current output will decrease by the amount of current absorbed by the resistor.

Ensure the resistor used can withstand the power capacity of the power supply/load.

Reverse Current:
Accumulative energy.

When the power supply is connected to a load such as a battery, reverse current may flow back to the power supply if the bleed resistance is on. To prevent damage to the power supply under this condition, use a reverse-current-protection diode in series between the power supply and load. If the bleed resistor is turned off or set to auto, there is no need to add a diode.

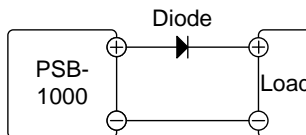

**CAUTION**

Ensure the reverse withstand voltage of the diode is able to withstand 2 times the rated output voltage of the power supply and the forward current capacity can withstand 3 to 10 times the rated output current of the power supply.

Ensure the diode is able to withstand the heat generated in the following scenarios.

When the diode is used to limit reverse voltage, remote sensing cannot be used.

Grounding

The output terminals of the PSB-1000 power supplies are isolated with respect to the protective grounding terminal. The insulation capacity of the load, the load cables and other connected devices must be taken into consideration when connected to the protective ground or when floating.

Floating

As the output terminals are floating, the load and all load cables must have an insulation capacity that is greater than the isolation voltage of the power supply.

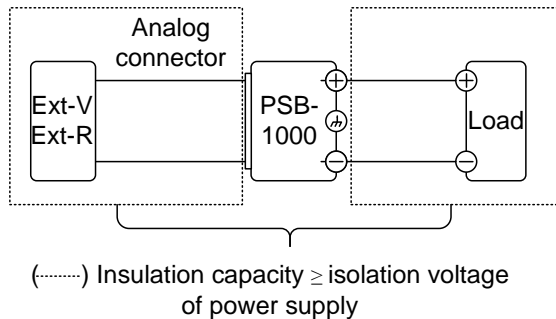

WARNING

If the insulation capacity of the load and load cables are not greater than the isolation voltage of the power supply, electric shock may occur.

Grounded output terminal

If the positive or negative terminal is connected to the protective ground terminal, the insulation capacity needed for the load and load cables is greatly reduced. The insulation capacity only needs to be greater than the maximum output voltage of the power supply with respect to ground.

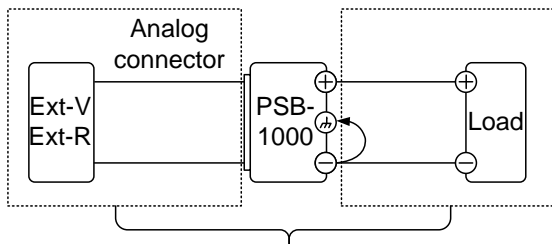

(-----) Insulation capacity \geq voltage of power supply with respect to ground



CAUTION

If using external voltage control, do not ground the external voltage terminal as this will create a short circuit.

O PERATION

| | |
|---|-----------|
| Set Up | 43 |
| Power Up..... | 43 |
| Wire Gauge Considerations..... | 44 |
| Output Terminals | 45 |
| Remote Sense | 48 |
| Using the Output Terminal Cover Rear Panel..... | 49 |
| Installing Hardware Options | 50 |
| Using the Rack Mount Kit..... | 52 |
| How to Use the Instrument | 53 |
| Reset to Factory Settings | 58 |
| System Information | 59 |
| Speaker Sound..... | 60 |
| LCD Configuration | 61 |
| USB Driver Installation | 62 |
| | |
| Basic Operation | 65 |
| Setting the Output Voltage Level..... | 65 |
| Setting the Output Current Level..... | 67 |
| Setting the OVP Level | 69 |
| Setting the OCP Level..... | 71 |
| Alarm Clear..... | 72 |
| Panel Lock | 74 |
| Turning the Output On | 76 |
| | |
| Advanced Settings | 77 |
| Enable OCP Control..... | 77 |
| OCP Delay..... | 78 |
| Output Delay..... | 79 |
| Slew Rate Control | 81 |
| Internal Resistance..... | 83 |
| Bleeder Resistor Settings..... | 84 |
| Average Settings..... | 85 |

| | |
|---|------------|
| Power On Configuration | 86 |
| CV Control Settings | 87 |
| CC Control Settings..... | 89 |
| Power on Run Settings..... | 91 |
| Tracking Control..... | 93 |
| External Control of Output (Ext-Out)..... | 94 |
| Breaker Control..... | 95 |
| Sense Control | 96 |
| | |
| Parallel/Series Operation | 98 |
| Master-Slave Parallel Overview..... | 99 |
| Parallel Connection..... | 102 |
| Parallel Operation..... | 106 |
| Master-Slave Series Overview | 109 |
| Series Connection | 112 |
| Series Operation..... | 115 |
| | |
| File Operations | 118 |
| View Internal Memory Settings | 118 |
| Save/Recall Internal Memory Settings..... | 119 |
| Copy Internal Memory File | 120 |
| Copy USB File to Internal Memory | 122 |
| Delete Files on USB Flash Drive..... | 123 |
| Rename Files on the USB Flash Drive | 125 |
| | |
| Sequence Function | 127 |
| Sequence File Format..... | 128 |
| Copy Sequence from a USB Flash Disk to Internal Memory..... | 128 |
| Load and Run a Sequence from a USB Flash Disk..... | 130 |
| Copy, Move, Clear Sequences in Internal Memory..... | 132 |
| Load and Run Sequence from Internal Memory..... | 135 |
| | |
| Trigger Input & Output..... | 138 |
| TRIG IN BNC..... | 138 |
| TRIG OUT BNC | 139 |
| Voltage Trigger..... | 141 |

Set Up

Power Up

Steps

1. Connect the power cord to the rear panel socket.

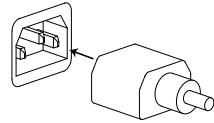

2. Press the POWER key. The splash screen will appear momentarily before the continuous mode screen appears with the settings loaded.

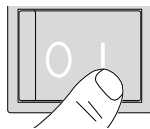

CAUTION

The power supply takes around 10 seconds to fully turn on and around half that time to shutdown.

Do not turn the power on and off quickly.

Wire Gauge Considerations

Background Before connecting the output terminals to a load, the wire gauge of the cables should be considered.

It is essential that the current capacity of the load cables is adequate. The rating of the cables must equal or exceed the maximum current rated output of the instrument.

| Recommended wire gauge | Wire Gauge | Nominal Cross Section | Maximum Current |
|------------------------|------------|-----------------------|-----------------|
| | 20 | 0.5 | 9 |
| | 18 | 0.75 | 11 |
| | 18 | 1 | 13 |
| | 16 | 1.5 | 18 |
| | 14 | 2.5 | 24 |
| | 12 | 4 | 34 |
| | 10 | 6 | 45 |
| | 8 | 10 | 64 |
| | 6 | 16 | 88 |
| | 4 | 25 | 120 |
| | 2 | 32 | 145 |
| | 1 | 50 | 190 |
| | 0 | 70 | 240 |
| | 0 | 95 | 290 |
| | 0 | 120 | 340 |

The maximum temperature rise can only be 60 degrees above the ambient temperature. The ambient temperature must be less than 30 deg.

Output Terminals

Background

Before connecting the output terminals to the load, first consider whether voltage sense will be used, the gauge of the cable wiring and the withstand voltage of the cables and load.

The output terminals can be connected to load cables using M4 sized screws or M8 sized bolts.

WARNING

Dangerous voltages. Ensure that the power to the instrument is disabled before handling the power supply output terminals. Failing to do so may lead to electric shock.

Steps

1. Turn the power switch off.

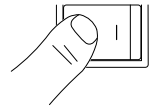

2. Remove the output terminal cover. → Page 49
3. If necessary, connect the ground terminal to either the positive or negative terminal. (See page 39 for grounding considerations)

For the front panel use the shorting bar that is attached to the ground terminal.

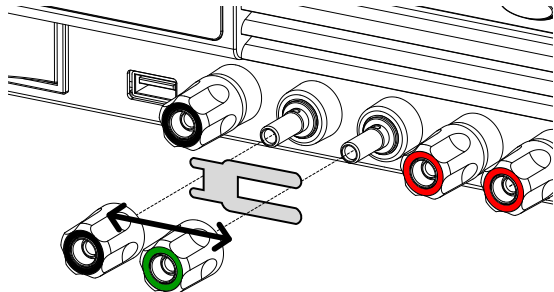

For the rear panel use a ground cable.

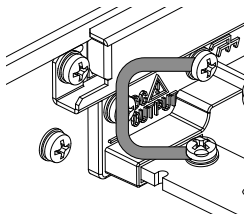

4. Choose a suitable wire gauge for the load cables. → Page 44
5. Choose a suitable crimp for the terminals.
6. Connect the positive load cable to the positive output terminal and the negative cable to the negative output terminal.
7. Configure the unit to local or voltage sense and connect sense cables if using remote sense. → Page 47
8. Reattach the output terminal cover. → Page 49

Front panel connection with voltage sense wiring

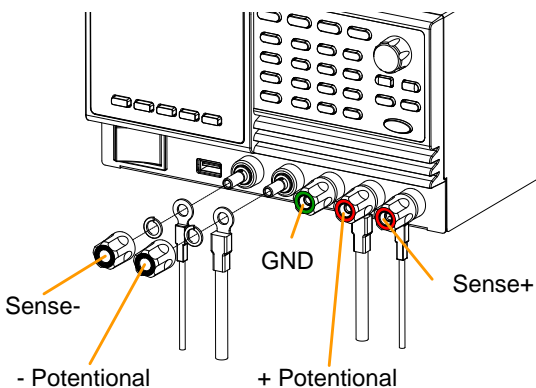

Rear panel
connection with
voltage sense
wiring

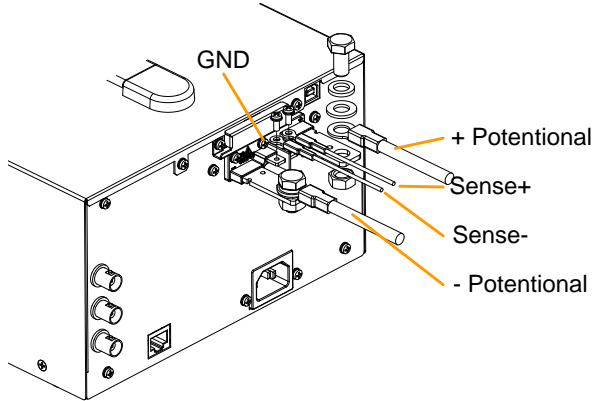

The front panel terminals are limited to the following output currents:

PSB-1400L: 30A
PSB-1400M: 10A
PSB-1800L: 30A
PSB-1800M: 20A

Remote Sense

Remote sense is used to compensate for the voltage drop seen across load cables due to the resistance inherent in the load cables. The remote sense terminals are connected to the load terminals to determine the voltage drop across the load cables.

Remote sense can compensate up to 0.6 volts. Load cables should be chosen with a voltage drop less than the compensation voltage.

Remote sense can also be used when the multiple power supplies are operated in parallel and series. See page 104 and 114 respectively for details.



WARNING

Ensure the output is off before connecting any sense cables. Use sense cables with a voltage rating exceeding the isolation voltage of the power supply. Never connect sensing cables when the output is on. Electric shock or damage to the power supply could result.

Single Load

1. Connect the Sense+ terminal to the positive potential of the load. Connect the Sense- terminal to the negative potential of the load.

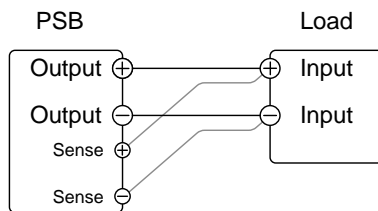

2. When using voltage sense, disable the local sense in the Power ON Configuration menu. → Page 96
3. Operate the instrument as normal. → Page 65 See the Basic Operation chapter for details.

Using the Output Terminal Cover Rear Panel



WARNING

Dangerous voltages. Ensure that the power to the instrument is disabled before handling the power supply output terminals. Failing to do so may lead to electric shock.

Steps

1. Remove the screw holding the top cover to the bottom cover.
2. Line-up the bottom cover with the notches in the output terminals.
3. Place the top terminal cover over the bottom cover.

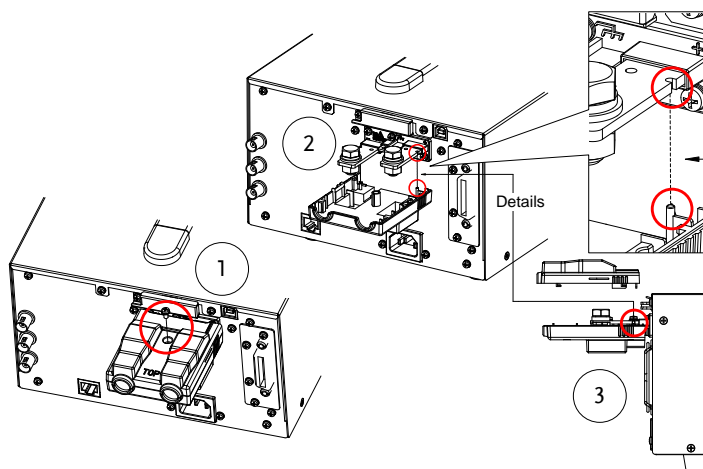

4. Use your thumb to slide the terminal covers shut, as shown in the diagram below.
5. When the top and bottom covers are flush, re-insert the screw that was removed in step 1.

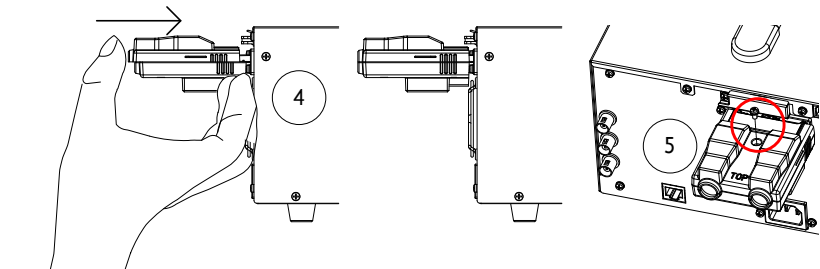

Removal Reverse the procedure to remove the terminal covers.

Installing Hardware Options

Background An optional GPIB interface can be installed into the option slot located on the rear panel.

Options PSB-105 GPIB Interface card

 **CAUTION** Ensure the power is off before installing any of the optional modules. Failing to do so may damage the unit.

Installation 1. Turn off the power switch.

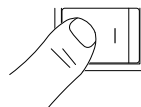

2. Unscrew the two screws holding the options panel plate.

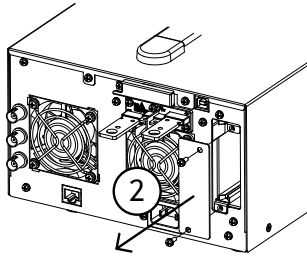

3. Slide the module PCB onto the rails on the inside of the module slot.
4. Secure the module with the screws that were removed from step 2.

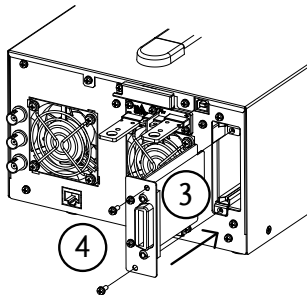

5. The module will be recognized upon startup.

Using the Rack Mount Kit

Background

The PSB-1000 series has an optional Rack Mount Kit (GW Instek part number: GRA-418-J(JIS) or GRA-418-E(EIA)). The GRA-418 has a 3U rack height(EIA). Please see your distributor for further rack mount details.

Rack mount illustration

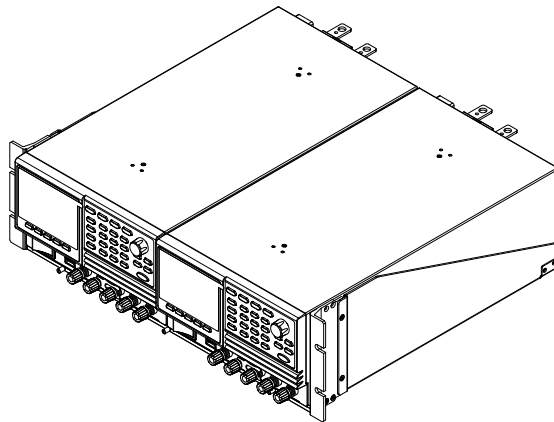

EIA shown.

How to Use the Instrument

Background

The PSB-1000 power supplies generally use the scroll wheel, arrow keys, Enter keys and soft-menu function keys to edit numerical values or to select menu options.

The following section will explain some of these concepts in detail.

Soft menu keys

1. The F1 ~ F5 function keys at the bottom of the display correspond directly to soft-menu keys above. The soft-menu keys have a number of different functions, depending on the use-case. They can be used as quick-action keys, option keys or as submenus.

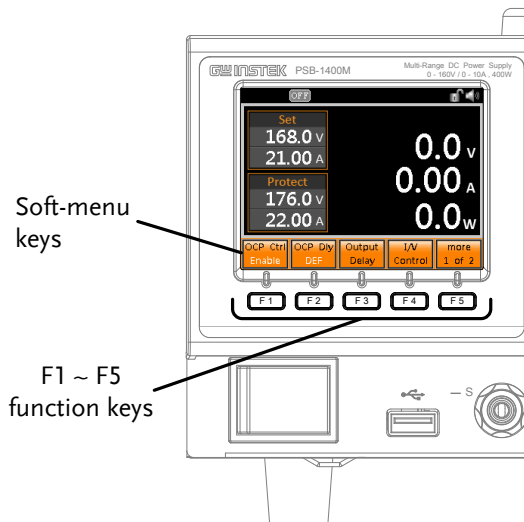

Menu Keys

Pressing a Menu key will enter the corresponding menu for that key.

Selecting Menu Items

- Turn the scroll wheel to select parameters in menus and lists. The selected parameter will be highlighted in orange. The scroll wheel is also used to increment/decrement setting values.

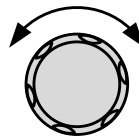

- Press the Enter key to edit the parameter or to enter the selected menu.



Example

Selected menu item

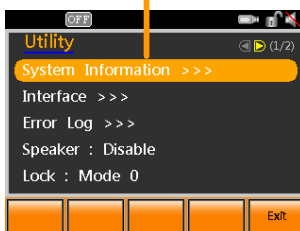

The following is an example of the Function menu that appears when the FUNC key is pressed.

Navigating Menus one page at a time

For menus with more than 1 page of items, pressing the directional keys will allow you to jump to the next menu page.



Using the Keypad to edit parameter values

When editing a value the keypad can be used to directly enter the desired value.

- 4. Type the value of the parameter using the keypad.

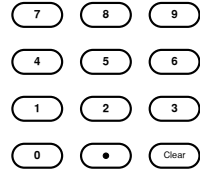

- 5. Press the Enter key to confirm the edit.



Example

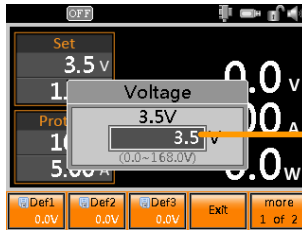

Parameter

Using the Arrow Keys and Scroll wheel to edit parameter values

For some values, the scroll wheel and arrow keys can be used.

- 1. Use the arrow keys to move to the digit of the desired power (shown in blue).
- 2. Turn the scroll wheel to edit the value by the resolution of the selected digit.

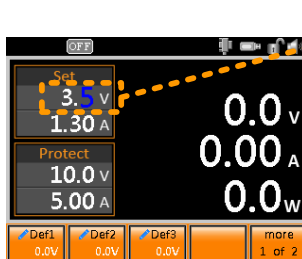
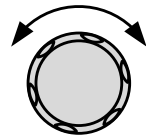

Cursor

3. Repeat the steps above for all the relevant digits.
4. Press the Enter key to confirm the edit.



Using the onscreen keyboard

The onscreen keyboard is used for creating filenames, renaming files, and so on. The screenshot below is an example of the onscreen keyboard.

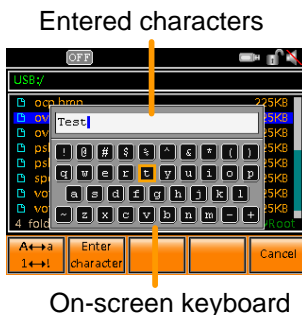

1. Use the scroll wheel to move the cursor to the desired character on the keyboard.
2. Press *Enter character* [F2] or the right arrow key to enter the desired character into the text entry area.
3. Use the *A ↔ a 1 ↔ !* [F1] key to toggle the keyboard to lower case characters and other non-alphanumeric characters.

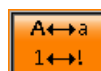
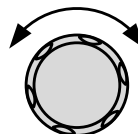

4. Use the left arrow key to delete the character to the left of the cursor.





5. Press Enter to finish using the keyboard.



Reset to Factory Settings

Background The factory default settings can be restored from the Utility menu. See page 188 for the list of factory settings.

- Steps**
1. Press the *Utility* key. The Utility menu will appear on the display. 
 2. Use the scroll wheel to go to *Factory Setting* and press *Enter*.
 3. Press *Restore*[F4] to restore the factory settings. 
 4. Press *OK*[4] to confirm. 



 **Note**

The factory settings can be viewed by using the scroll wheel or the arrow keys.

System Information

Background The Utility>System Information setting displays the serial number and software version number.

- Steps**
1. Press the *Utility* key. The Utility menu will appear on the display. 
 2. Use the scroll wheel to go to *System Information* and press *Enter*.
 3. The system information should now be listed on the display.

Example

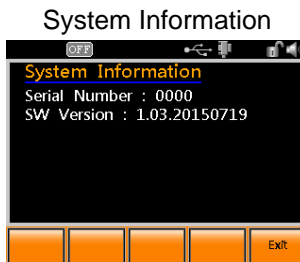

Speaker Sound

Background The Utility>Speaker setting enables or disables sounds for both key-presses and alarms. By default sound is disabled.

Steps

1. Press the *Utility* key. The Utility menu will appear on the display. 

2. Use the scroll wheel to go to *Speaker*.

3. Press *Disable[F1]* to turn the speaker sound off. 

The  icon will appear in the icon bar.

4. Press *Enable[F2]* to turn the speaker sound on. 

The  icon will appear in the icon bar.

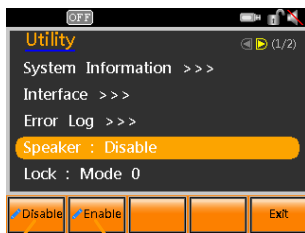

Speaker settings

Disable Enable

LCD Configuration

Background The Color setting in the Utility menu sets the brightness and contrast level of the LCD display.

Steps 1. Press the *Utility* key. The Utility settings will appear on the display. 

2. Use the scroll wheel to go to *Color* and press *Enter*.

3. Set the brightness and contrast.

Use the arrow keys to select Contrast or Brightness.



Use the scroll wheel to set the level.

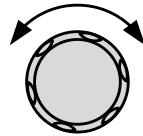

Contrast 1 ~ 100 (Default=20)

Brightness 1 ~ 100 (Default=50)

Default Settings 4. Press *Default*[F1] to set all the LCD settings to the default levels.

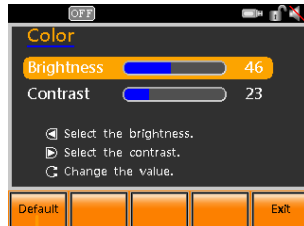

LCD settings

Default settings

USB Driver Installation

Background If the USB Type B interface is to be used for remote control, the USB driver needs to be installed.

 **Note** The USB driver, GW_PSB1k, is located on the CD Rom that accompanied this user manual. Alternatively the driver can be downloaded from the GW Instek website.

For information on the USB interface, see page 167.

Steps

1. Connect the rear panel USB-B port on the PSB-1000 to the PC using a USB Type A to B cable.

2. Go the Windows Device Manager.

For Windows 7:

Start > Control Panel > Hardware and Sound > Device Manager

3. The PSB-1000 will be located under *Other Devices* in the hardware tree. Right-click *PSB-1XXX* and choose *Update Driver Software*.

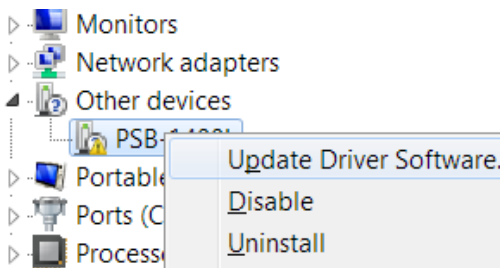

4. From the hardware wizard choose *Browse my computer driver software*.

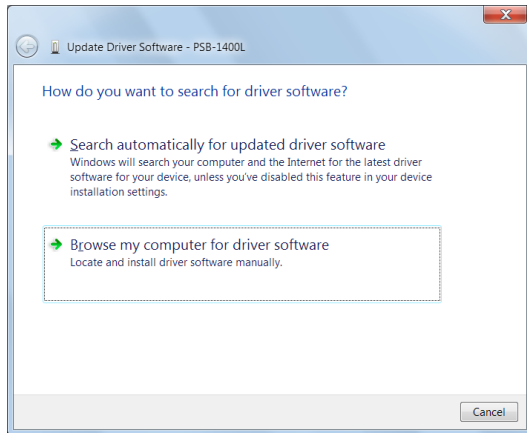

5. Set the file path to the location of the USB driver, click Next and finish the driver installation.

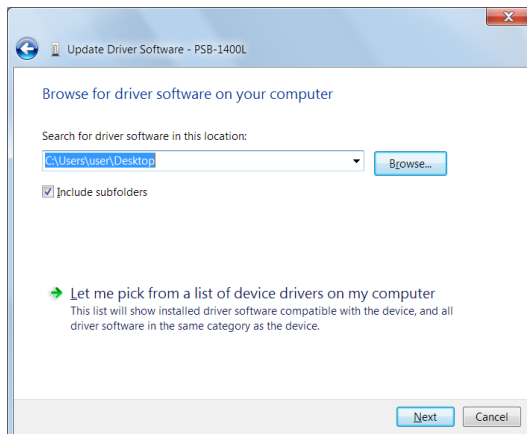

6. The PSB-1000 will now be located in the *Ports* node of the hardware tree in the Windows Device Manager if the driver installation was successful.

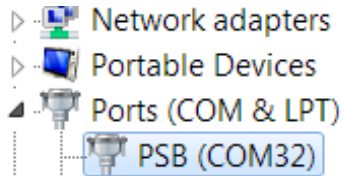

Basic Operation

This section describes the basic operations required to operate the power supply.

- Setting the Output Voltage Level → from page 65
- Setting the Current Level → from page 67
- Setting the OVP Level → from page 69
- Setting the OCP Level → from page 71
- Clearing the Protection Alarms → from page 72.
- Panel Lock → from page 74.
- Turning the Output On → from page 76.

Before operating the power supply, please see the Getting Started chapter, page 9.

Setting the Output Voltage Level

| | |
|------------|---|
| Background | The voltage setting sets the voltage level of the power supply. |
|------------|---|

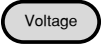
- | | | | | | | | |
|-----------|---|-------|---------------------------|-----------|--------------------------|--|----------------------------------|
| Steps | <ol style="list-style-type: none"> 1. Press the Voltage key. The V Set parameter will be editable.  2. Set the voltage with the scroll wheel/keypad or with the F1 ~ F5 soft-keys. <table border="0" style="margin-left: 20px;"> <tr> <td style="border-top: 1px solid black;">Range</td> <td>0 volts ~ 105% full range</td> </tr> <tr> <td style="border-top: 1px solid black;">Soft-keys</td> <td>1 of 2: DEF1, DEF2, DEF3</td> </tr> <tr> <td></td> <td>2 of 2: Step ↗, Step ↘, MAX, MIN</td> </tr> </table> 3. Press <i>Enter</i> to confirm the voltage setting. | Range | 0 volts ~ 105% full range | Soft-keys | 1 of 2: DEF1, DEF2, DEF3 | | 2 of 2: Step ↗, Step ↘, MAX, MIN |
| Range | 0 volts ~ 105% full range | | | | | | |
| Soft-keys | 1 of 2: DEF1, DEF2, DEF3 | | | | | | |
| | 2 of 2: Step ↗, Step ↘, MAX, MIN | | | | | | |
-

Save Preset Settings

The DEF1, DEF2 & DEF3 preset settings are user defined settings. By default they are set to 0 volts.

The Step↗ & Step↘ preset settings increase or decrease the voltage setting by the set amount.

4. Press the Voltage key. The V Set parameter will be editable. 
5. Set the voltage with the keypad. Do not use the scroll wheel.

Range 0 volts ~ 105% full range

6. Press F1 ~ F5 to save the corresponding soft-key to the voltage value set above.

Soft-keys 1 of 2: DEF1, DEF2, DEF3
 2 of 2: Step↗, Step↘

7. Press *F4 Exit* or *Enter* to confirm and exit the preset setting.



Note

Trying to set the voltage outside of the voltage range will result in an Over Range error message being displayed on the screen.

The voltage level can be set when the output is on.

Example

Voltage setting

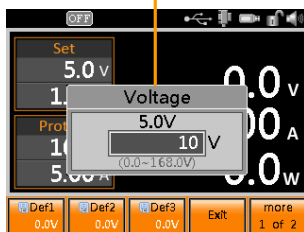

F1 F2 F3 F4 F5
Preset voltage settings

Setting the Output Current Level

Background The current setting sets the current level of the power supply.

- Steps**
1. Press the Current key. The A Set parameter will be editable. Current
 2. Set the current with the scroll wheel/keypad or with the F1 ~ F5 soft-keys.

Range 0 amps ~ 105% full range

Soft-keys 1 of 2: DEF1, DEF2, DEF3

2 of 2: Step ↗, Step ↘, MAX, MIN

3. Press *Enter* to confirm the current setting.
-

Save Preset Settings The DEF1, DEF2 & DEF3 preset settings are user defined settings. By default they are set to 0 amps.

The Step ↗ & Step ↘ preset settings increase or decrease the current setting by the set amount.

4. Press the Current key. The V Set parameter will be editable.

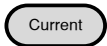

5. Set the current with the keypad. Do not use the scroll wheel.

Range 0 amps ~ 105% full range

6. Press F1 ~ F5 to save the corresponding soft-key to the current value set above.

Soft-keys 1 of 2: DEF1, DEF2, DEF3
 2 of 2: Step ↗, Step ↘

7. Press *F4 Exit* or *Enter* to exit and confirm the preset setting.
-



Note

Trying to set the current outside of the current range will result in an Over Range error message being displayed on the screen.

The current level can be set when the output is on.

Example

Current setting

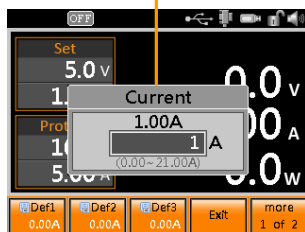

F1 F2 F3 F4 F5
 Preset current settings

Setting the OVP Level

Background The over voltage protection (OVP) protects the unit from overvoltage. When the voltage level crosses the OVP threshold, the output is automatically turned off.

Steps 1. Press the OVP key. The V Protect parameter will be editable. 

2. Set the OVP threshold level with the scroll wheel/keypad or with the F1 ~ F5 soft-keys.

Range 4 ~ 44V (1400L)
 5 ~ 176V (1400M)
 4 ~ 44V (1800L)
 5 ~ 176V (1800M)

Soft-keys DEF1, DEF2, DEF3, MAX, MIN

3. Press *Enter* to confirm the OVP setting.

Save Preset Settings The DEF1, DEF2 & DEF3 preset settings are user defined settings. By default they are set to lowest settable level.

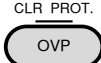
4. Press the OVP key. The V Protect parameter will be editable. 

5. Set the OVP threshold level with the keypad. Do not use the scroll wheel.

Range 4 ~ 44V (1400L)
 5 ~ 176V (1400M)
 4 ~ 44V (1800L)
 5 ~ 176V (1800M)

6. Press F1 ~ F3 to save the corresponding soft-key to the OVP threshold value set above.

Soft-keys DEF1, DEF2, DEF3

7. Press F5 *Exit* to confirm and exit the preset setting.



Note

Trying to set the OVP threshold level outside of the OVP range will result in an Over Range error message being displayed on the screen.

The OVP threshold level can be set when the output is on.

Example

OVP setting

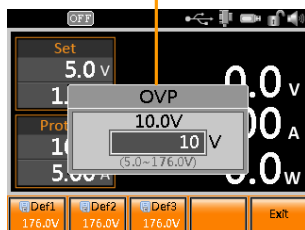

F1 F2 F3 F4 F5
Preset OVP settings

Setting the OCP Level

Background The over current protection (OCP) protects the unit from overcurrent. When the current level crosses the OCP threshold level, the output is automatically turned off.

Steps 1. Press the OCP key. The A Protect parameter will be editable. 

2. Set the OCP level with the scroll wheel/keypad or with the F1 ~ F5 soft-keys.

| | |
|-------|-----------------|
| Range | 4 ~ 44A (1400L) |
| | 1 ~ 11A (1400M) |
| | 5 ~ 88A (1800L) |
| | 2 ~ 22A (1800M) |

Soft-keys DEF1, DEF2, DEF3, MAX, MIN

3. Press *Enter* to confirm the OCP setting.

Save Preset Settings The DEF1, DEF2 & DEF3 preset settings are user defined settings. By default they are set to the lowest settable level.

4. Press the OCP key. The A Protect parameter will be editable. 

5. Set the OCP threshold level with the keypad. Do not use the scroll wheel.

| | |
|-------|-----------------|
| Range | 4 ~ 44A (1400L) |
| | 1 ~ 11A (1400M) |
| | 5 ~ 88A (1800L) |
| | 2 ~ 22A (1800M) |

6. Press F1 ~ F3 to save the corresponding soft-key to the OCP threshold value set above.

Soft-keys DEF1, DEF2, DEF3

7. Press *F5 Exit* to confirm and exit the preset setting.



Note

Trying to set the OCP threshold level outside of the OCP range will result in an Over Range error message being displayed on the screen.

The OCP threshold level can be set when the output is on.

Example

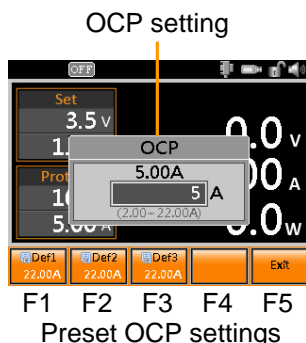

Alarm Clear

Background

The CLR_PROT (Clear Protection) function will clear any protection alarms.

Applicable Alarms

OVP, OCP, OTP, AC-Fail, Power Limit



Note

Note that an alarm can only be cleared if the FUNC>View POC>Breaker setting is set to "Disable". See page 95 for details.

Steps

1. Press and hold the *OVP* key to clear any alarms.

CLR PROT.



Example

Protection indicator

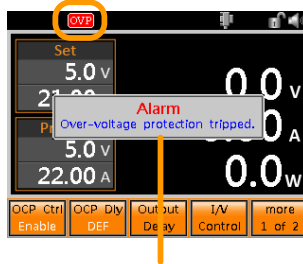

Alarm message

Panel Lock

The panel lock feature prevents settings from being changed accidentally. When activated, all keys and knobs except the Lock/Unlock key and the Output key will be disabled.

The panel lock has two modes: Mode 0 and Mode 1. Mode 0 only allows the Output key to turn the load off when the panel lock is active. Mode 1 allows the Output key to turn the load on or off when the panel lock is active.

Activate the panel lock 1. Press the Lock key to activate the panel lock. The Lock key will turn green.



The padlock icon at the top of the display will become "locked" when the panel keys are locked.



Disable the panel lock 2. Hold the Lock key for ~3 seconds to disable the panel lock.

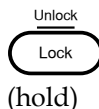

The Lock key light will turn off and the padlock icon will "open".



Set the lock mode 3. Press the Utility key. The Utility menu will appear on the display.

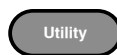

4. Use the scroll wheel to go to Lock.

5. Press Mode0[F1] to set the panel lock to Mode0.



6. Press Mode1[F2] to set the panel to lock to Mode1.



Example

Message Lock icon

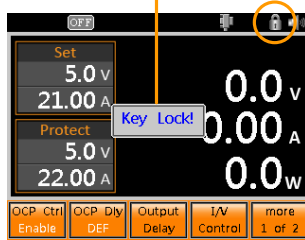

A message will show “Key lock!” if trying to use the front panel keys when the key lock is on.

Turning the Output On

When the output is turned on, the DUT can be connected to either the rear panel output or the front panel output.



Warning

Both of these outputs are electrically linked. Only one DUT should be connected to any one of the outputs at a time. Using both outputs at the same time is not supported. Using the front and rear outputs at the same time could cause dangerous operating conditions. See page 44 for details about using the output terminals or sockets.

Turn Output On

Press the *Output* key. The Output key will turn green and CC or CV will be displayed in the status bar to indicate that the output is on.

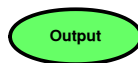

Turn Output Off

Press the *Output* key. The Output key light will go out and OFF will be displayed in the status bar to indicate that the output is off.

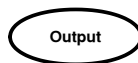

Advanced Settings

- Enable OCP Control → from page 77
- OCP Delay → from page 78
- Output Delay → from page 79
- Slew Rate Control → from page 81
- Internal Resistance → from page 83
- Bleeder Resistor Settings → from page 84
- Average Settings → from page 85

Enable OCP Control

Background The over current protection can be turned enabled or disabled from the Main menu screen.

Steps

1. Press the Main key.



2. Press OCP Ctrl[F1] to enable or disable OCP control.



Example

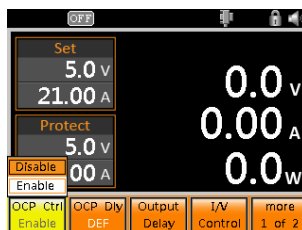

OCP Control

OCP Delay



Background

Sets the OCP delay time. This parameter will delay the amount of time it takes to trigger the over current protection. This function can be useful to prevent current overshoot from triggering OCP.

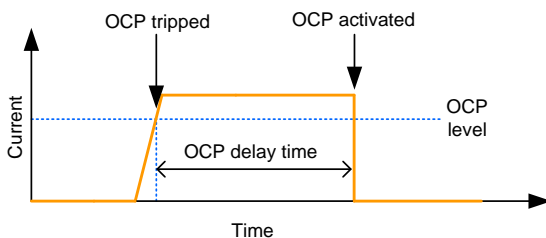
Example



Steps

1. Press the Main key. 
2. Press OCP Dly[F2] to edit the OCP delay time. 
3. Key in the delay time using the keypad and press *Enter*.

Range 0.1 ~ 2.0s, 0:Auto

Example

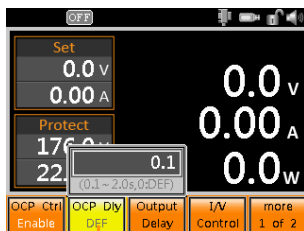

OCP Delay settings

Output Delay

Background

A delay time can be configured to delay turning the output on or to delay turning the output off.

After a delay time is set, a timer on the display will count down the delay time each time the output is turned on or off, depending on the setting.

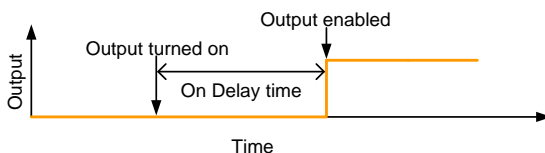

Output On Delay Example

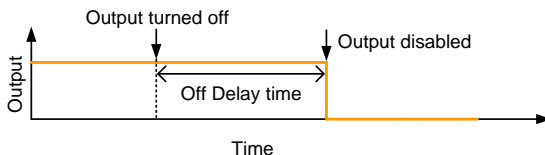

Output Off Delay Example



Steps

1. Press the Main key. 
2. Press Output Delay[F3]. 
3. Use the scroll wheel to select *On Delay* or *Off Delay* and press *Enter*.
4. Use the keypad to enter the delay time and press *Enter*.

On Delay 0.00 ~ 100.00 seconds

Off Delay 0.00 ~ 100.00 seconds

Example

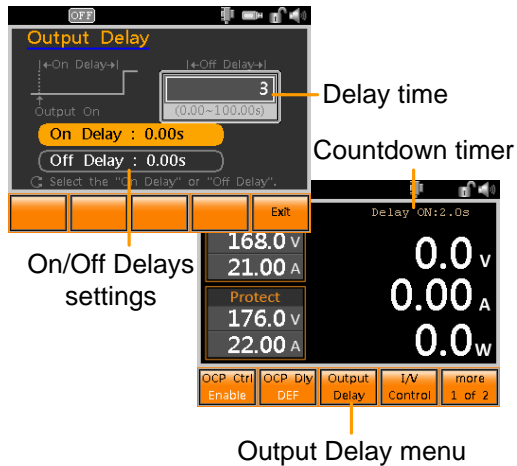

Slew Rate Control

Background The I/V Control menu controls the current and voltage slew rate settings.

Parameter Settings

CVHS CV high speed. Highest speed voltage slew rate.

CVLS CV low speed. User defined voltage slew rate.

CCHS CC high speed. Highest speed current slew rate.

CCLS CC low speed. User defined current slew rate.

Steps

1. Press the Main key.



2. Press I/V Control[F4].



3. Use the scroll wheel to highlight I/V Mode.

4. Use the function keys to select the appropriate mode.



Ex.

I/V Mode CVHS, CCHS, CVLS, CCLS

5. To set the CVLS or CCLS slew rate, use the scroll wheel to go VSR↗, VSR↘, ISR↗ or ISR↘ and the press Enter. A solid blue checkbox indicates which settings correspond to the CVLS or CCLS mode.

Use the number pad to key in the slew rate or press Min[F1] or Max[F2].

| | |
|-----------|-----------------------------|
| VSR | 0.01 ~ (rating voltage x 2) |
| ISR | 0.01 ~ (rating current x 2) |
| Soft-keys | Min[F1], Max[F2] |

Example

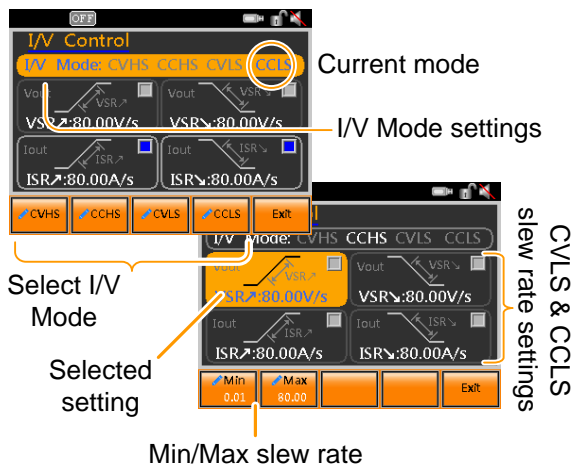

Internal Resistance

Background When the internal resistance is set, it is seen as a resistance in series with the positive terminal. This allows the power supply to simulate power sources that have internal resistances, such as lead acid batteries.

By default the internal resistance is set to 0Ω.

Steps

1. Press the Main key.



2. Press *more 1 of 2*[F5] > *INT-R*[F1].



3. Use the number pad to key in the internal resistance.

The new internal resistance setting will be shown on the INT-R soft-key.

| | | |
|-------|-----------|-----------------|
| INT-R | PSB-1400L | 0.000Ω ~ 1.000Ω |
| | PSB-1400M | 0.00Ω ~ 16.00Ω |
| | PSB-1800L | 0.000Ω ~ 0.500Ω |
| | PSB-1800M | 0.000Ω ~ 8.000Ω |

Example

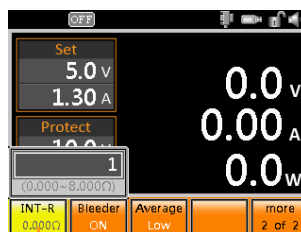





Internal resistance settings

Bleeder Resistor Settings

Background The PSB-1000 power supplies employ a bleed resistor in parallel with the output terminals.

Bleeder Settings Bleeder OFF, ON, Auto

 **Note** By default the bleed resistance is on. For battery charging applications, be sure to turn the bleed resistance off as the bleed resistor can discharge the connected battery when the unit is off.

- Steps**
1. Press the Main key. 
 2. Press *more 1 of 2*[F5] > *Bleeder*[F2].  > 
 3. Press *Bleeder*[F2] repeatedly to cycle through the bleeder settings.

The new bleeder setting will be shown on the Bleeder soft-key.

Bleeder OFF, ON, Auto

Example

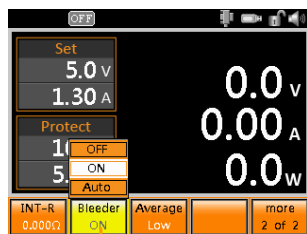

Bleeder settings

Average Settings

Background The average settings are used to set the level of smoothing for the voltage and current readback measurements. A higher average setting reduces the measurement speed, a lower setting has a faster measurement speed.

Average Settings Average Low, Middle, High

Steps

1. Press the Main key.



2. Press *more 1 of 2*[F5] > *Average*[F3].



3. Press *Average*[F3] repeatedly to cycle through the settings.

The new *Average* setting will be shown on the *Average* soft-key.

Average Low, Middle, High

Example

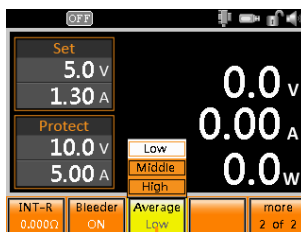

Average settings

Power On Configuration

Power ON Configuration controls a number of advanced settings that can be activated at power up. At each startup a splash screen will be shown on the screen to inform you of the Power ON Configuration settings.

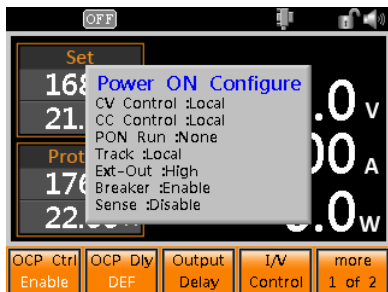

- CV Control Settings → from page 87
- CC Control Settings → from page 89
- Power on Run Settings → from page 91
- Tracking Control → from page 93
- External Control of Output (Ext-Out) → from page 94
- Breaker Control → from page 95
- Sense Control → from page 96

CV Control Settings

Parameter Settings The CV Control setting sets the CV control mode to local or external voltage/resistance control.

Local control allows you to use the front panel keys to control the constant voltage level.

External Voltage control allows an external voltage of 0 ~ 10V to control the constant voltage level. The external voltage is applied to pins 3 & 16 on the rear panel Analog Programming connector on the rear panel. See page 147 for usage details.

External Resistance control allows a resistance of 0Ω to 10kΩ(Ext-R↗) or 10kΩ to 0Ω(Ext-R↘) to control the constant voltage level. The external resistance is applied to the 5 & 6 pins of the rear panel Analog Programming connector. See page 150 for usage details.

- Steps**
1. Press the *FUNC* key. 
 2. Use the scroll wheel to go to *Power on Config* and press *Enter*.
 3. Go to the *CV Control* setting using the scroll wheel and press *Modify[F1]*.
 4. Use the F1 ~ F4 soft-keys to select the CV control mode.

| | |
|------|------------------------------|
| Mode | Local, Ext-V, Ext-R↗, Ext-R↘ |
|------|------------------------------|

5. Press *Enter* to save the settings.
6. The next time the unit is turned on the new CV Control settings will be activated. This will be displayed on the screen at startup.

Example



CV Control

Modify CV Control mode

CC Control Settings

Parameter Settings Sets the constant current (CC) control mode between local and external voltage/resistance control.

Local control allows you to use the front panel keys to control the constant current level.

External Voltage control allows an external voltage of 0 ~ 10V to control the constant current level. The external voltage is applied to pins 4 & 16 on the rear panel Analog Programming connector on the rear panel. See page 147 for usage details.

External Resistance control allows a resistance of 0Ω to 10kΩ(Ext-R↗) or 10kΩ to 0Ω(Ext-R↘) to control the constant current level. The external resistance is applied to the 7 & 8 pins of the rear panel Analog Programming connector. See page 150 for usage details.

-
- Steps**
1. Press the *FUNC* key. 
 2. Use the scroll wheel to go to *Power on Config* and press *Enter*.
 3. Go to the *CC Control* setting using the scroll wheel and press *Modify[F1]*.
 4. Use the F1 ~ F4 soft-keys to select the CC control mode.

| | |
|------|------------------------------|
| Mode | Local, Ext-V, Ext-R↗, Ext-R↘ |
|------|------------------------------|

5. Press *Enter* to save the settings.
6. The next time the unit is turned on the new CC Control settings will be activated. This will be displayed on the screen at startup.

Example



CC Control

Modify CC Control mode

Power on Run Settings

| | |
|--------------------|---|
| Parameter Settings | The PON Run settings set the run state of the unit when the power is turned on. The unit can be configured to automatically turn the output on with the last used settings or it can be configured to run a pre-saved sequence program. By default the PON Run setting is disabled (set to None). |
|--------------------|---|

- | | | | |
|---------|---|---------|----------------------------|
| Steps | <ol style="list-style-type: none">1. Press the <i>FUNC</i> key. 2. Use the scroll wheel to go to <i>Power on Config</i> and press <i>Enter</i>.3. Go to the <i>PON Run</i> setting using the scroll wheel and press <i>Modify[F1]</i>.4. Use the F1 ~ F3 soft-keys to select the PON Run setting. <hr/><table><tr><td>PON Run</td><td>None, Output ON, SEQ0~SEQ9</td></tr></table><hr/>5. Press <i>Enter</i> to save the settings.6. The next time the unit is turned on the new PON Run settings will be activated. This will be displayed on the screen at startup. | PON Run | None, Output ON, SEQ0~SEQ9 |
| PON Run | None, Output ON, SEQ0~SEQ9 | | |

Example



PON Run setting

Modify PON Run setting

Tracking Control

Tracking control is used to control the voltage and current of slave units when using multiple PSB-1000 units in series or parallel. When using multiple units in parallel or serial special control ribbon cables are required. Please see 98 for details.

| | | |
|--------------------|---------|---|
| Parameter Settings | Local | Local control. Tracking is off. |
| | S/Slave | Series tracking. Sets the unit as a slave for series tracking. |
| | P/Slave | Parallel tracking. Sets the unit as slave for parallel tracking. |
| | P2~P4/M | Parallel tracking. Sets the unit as a master for the designated number of parallel slave units. |

- Steps
1. Press the *FUNC* key. 
 2. Use the scroll wheel to go to *Power on Config* and press *Enter*.
 3. Go to the *Track* setting using the scroll wheel and press *Modify[F1]*.
 4. Use the F1 ~ F4 soft-keys to select the *Track* setting.

*Press the F4 soft-key to cycle through the P2~P4/M settings.

| | |
|-------|--|
| Track | Local, S/Slave, P/Slave, P2/M, P3/M, P4/M. |
|-------|--|
 5. Press *Enter* to save the settings.

Example

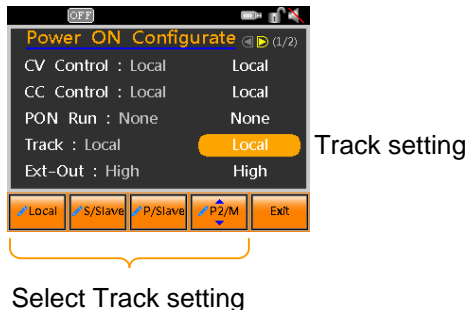

External Control of Output (Ext-Out)

The output can be turned on or off externally using a switch. The Analog Programming connector can be set to turn the output on from a high or low signal. The voltage across pins 18 and 19 are internally pulled to +5V with 10kΩ pull-up resistor. A short (closed switch) produces a low signal. When EXT-Out = High, the output is turned on when the pins 18 and 19 are open. When EXT-Out = Low, the output is turned on when pins 18 and 19 are shorted. Please see 138 for details.

| | | |
|--------------------|------|--|
| Parameter Settings | High | Open switch (high signal) turns the output on. |
| | Low | Closed switch (low signal) turns the output off. |

- Steps
1. Press the *FUNC* key. 
 2. Use the scroll wheel to go to *Power on Config* and press *Enter*.
 3. Go to the *Ext-Out* setting using the scroll wheel and press *Modify[F1]*.
 4. Use the F1 ~ F2 soft-keys to select the Ext-Out setting.

Ext-Out High, Low.

5. Press *Enter* to save the settings.

Example



Ext-Out setting

Modify Ext-Out setting

Breaker Control

The Breaker setting determines the behavior of the unit when the one of the protection functions have been tripped; When Breaker is set to Enable the PSB-1000 will shut down, and when Breaker is set to Disable, the output will be turned off.

Applicable protection functions: OCP, OVP, OTP and Shutdown.

| | | |
|--------------------|---------|---|
| Parameter Settings | Enable | Turns the PSB-1000 off when OCP, OVP, OTP or shutdown is tripped. |
| | Disable | Turns the output off when OCP, OVP, OTP or shutdown is tripped. |

Steps

1. Press the *FUNC* key.



2. Use the scroll wheel to go to *Power on Config* and press *Enter*.

3. Go to the *Breaker* setting using the scroll wheel and press *Modify*[F1]. (On page 2/2)
4. Use the F1 ~ F2 soft-keys to select the *Breaker* setting.

| | |
|----------------|------------------|
| <i>Breaker</i> | Disable, Enable. |
|----------------|------------------|

5. Press *Enter* to save the settings.

Example



Sense Control

Sense control turns local sense on or off for the front or rear panel terminals. Traditionally local sense is manually configured on the terminals. On the PSB-1000, local sense is internal wired when enabled.

| | | |
|--------------------|---------|---|
| Parameter Settings | Disable | Disables local sense on the unit. |
| | Rear | Enables local sense on the rear panel terminals. |
| | Front | Enables local sense on the front panel terminals. |

- Steps
1. Press the *FUNC* key.



2. Use the scroll wheel to go to *Power on Config* and press *Enter*.
3. Go to the *Sense* setting using the scroll wheel and press *Modify[F1]*. (On page 2/2)
4. Use the F1 ~ F3 soft-keys to select the Sense setting.

Sense Disable, Rear, Front.

5. Press *Enter* to save the settings.

Example



Sense setting

Modify Sense setting

Parallel/Series Operation

This section describes the basic operations required to operate the power supply in series or parallel. Operating the PSB-1000 in parallel increases the total current output of the power supply units. When used in series, the total output voltage of the power supplies can be increased.

When the units are used in parallel or in series, a number of precautions and limitations apply. Please read the following sections before operating the power supplies in parallel or series.

- Master-slave parallel overview → from page 99
- Parallel connection → from page 102
- Parallel operation → from page 106
- Master-slave series overview → from page 109
- Series connection → from page 112
- Series operation → from page 115

Master-Slave Parallel Overview

Background

When connecting the PSB-1000 power supplies in parallel, up to 4 units can be used in parallel and all units must be of the same model with similar output settings.

To use the power supplies in parallel, units must be used in a “master-slave” configuration. In the master-slave configuration a “master” power supply controls any other connected “slave” power supplies. In order for the master unit to control the slave units, the master unit must use the Analog Programming connector on the rear panel to control the slave units.

When using the Analog Programming connector, the connector must be wired correctly between the master and each of the slave units. For the complete connector pin assignment, see page 144, or alternatively, the PSB-101, PSB-102 and the PSB-103 cables can be used to connect a master to unit to 1, 2 or 3 slave units, respectively.

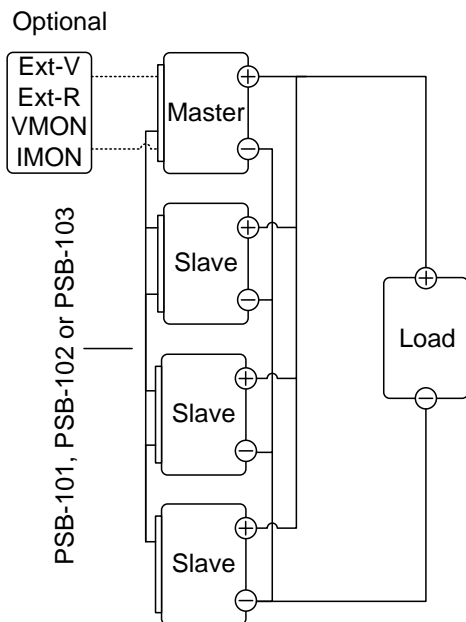

Limitations

Display

- Only the master unit will display the voltage and current.

OVP/ OCP

- Slave units follow the settings of the master when OVP/OCP is tripped on the master unit.

Remote monitoring

- Voltage monitoring (VMON) and current monitoring (IMON) are only supported on the master unit.
- The IMON current represents the total current of the all the parallelized units.

External Voltage and Resistance Control

- Voltage/Resistance controlled remote control can only be used with the master unit.
- The full scale current (in parallel) is equivalent to the maximum external voltage or resistance.

Internal Resistance

- For 2 units in parallel, the internal resistance is actually half of the setting value.
- For 3 units in parallel, the internal resistance is actually a third of the setting value.
- For 4 units in parallel, the internal resistance is actually a fourth of the setting value.
- See page 83 to set the internal resistance settings.

Bleeder Control

- The Master unit is used to control the bleeder settings. The bleeder resistors in all the slave units are always turned off when in parallel mode. See page 84 to set the bleeder resistor settings.

| Output Voltage/ Output Current | Model | Number of parallel units: | | | |
|-----------------------------------|-----------|---------------------------|---------|---------|---------|
| | | 1 unit | 2 units | 3 units | 4 units |
| | PSB-1400L | 40V | 40V | 40V | 40V |
| | | 40A | 80A | 120A | 160A |
| | PSB-1400M | 160V | 160V | 160V | 160V |
| | | 10A | 20A | 30A | 40A |
| | PSB-1800L | 40V | 40V | 40V | 40V |
| | | 80A | 160A | 240A | 320A |
| | PSB-1800M | 160V | 160V | 160V | 160V |
| | | 20A | 40A | 60A | 80A |

Parallel Connection

Analog Programming Connector Connection

To operate the power supplies in parallel with the analog programming connectors, connect the analog programming connectors on the master and slave units as shown in the diagram below:

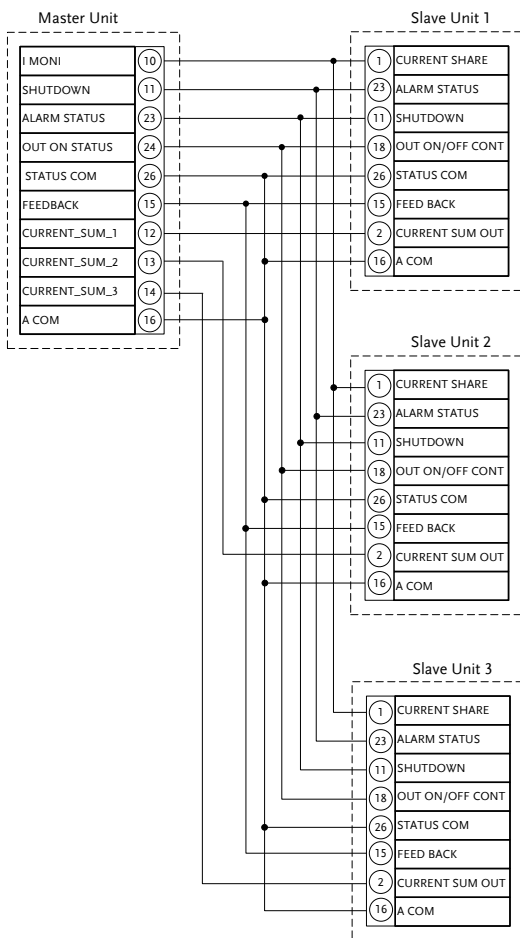

Alternatively, preconfigured cables can be used:

PSB-101: 1 master with 1 slave

PSB-102: 1 master with 2 slaves

PSB-103: 1 master with 3 slaves

Parallel Output Connection

If grounding the positive or negative terminals to the reference ground, be sure to ground the appropriate terminal on each unit (either positive or negative).

Example with negative terminal connected to ground

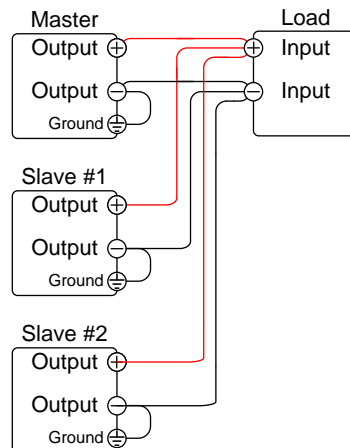

Parallel Sense Connections

For remote sense connections, connect the S+ terminals to the positive potential of the load. Connect the S- terminals to the negative potential of the load.

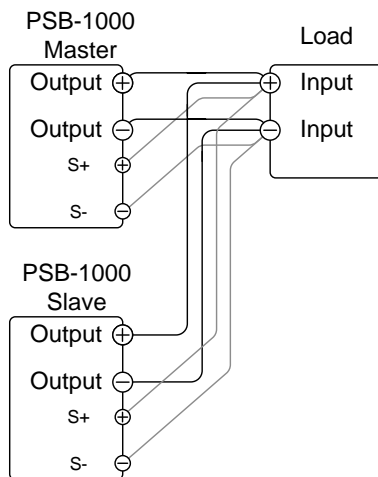

Steps

1. Ensure the power is off on all power supplies.
2. Choose the master and the slave unit(s).
3. Connect the analog programming connectors for the master and slave units as shown above.
4. Remove the Output Terminal → Page 45 covers.
5. Connect the master and slave unit in parallel as shown above.
6. If using remote sense, connect the master and slave sense cables as shown above.
7. Reattach the terminal covers. → Page 49



Note

Ensure the load cables have sufficient → Page 44
current capacity.

The load wires and remote sense wires should use
twisted-paired wiring of the shortest possible
length.

Parallel Operation

Master-Slave Configuration Before using the power supplies in parallel, the master and slave units need to be configured.

- Steps**
1. Configure the OVP and OCP settings for the master unit. → From Page 69
 2. Enter the Power ON Configuration settings and set the Tracking configuration for the master and each connected slave. → Page 93

| Unit | Tracking Setting |
|----------------------------|------------------|
| Master Unit with 1 slave: | P2/M |
| Master Unit with 2 slaves: | P3/M |
| Master Unit with 3 slaves: | P4/M |
| Any Slave Units: | P/Slave |

3. If using voltage sense, disable local sense in the Power ON Configuration settings. → Page 96
 4. Cycle the power on the units (reset the power).
-



Note

Set Tracking to Local to return the units to local (independent) operation.

Only the Master OVP, OCP and UVL settings are used for protection. Slave protection levels are disregarded.

OTP works independently for each unit.

Master-Slave Operation Only operate the power supplies in parallel if the units are configured correctly.

- Steps 1. Turn on the master and slave units. The slave unit(s) will show a blank display.

Master unit

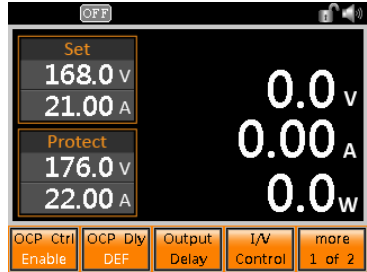

Slave units

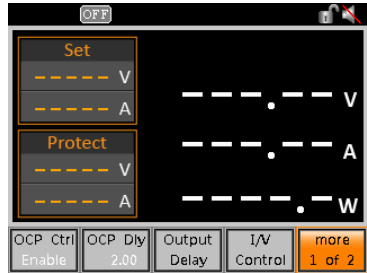

2. Operation of all units is controlled via the master unit. Operation of the master unit is the same as for a single unit. See the Basic Operation chapter. → Page 65

3. Press the Output key to begin. The output key will turn green.

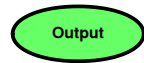

 Caution

Only operate the power supplies in parallel if using units of the same model number.

 Note

The panel controls are disabled on slave units, including the output key. On slave units, only the FUNC, Utility and File key can be used.



Ensure that the insulation capacity of the wiring is sufficient when connected in parallel. See page 39 for insulation capacity and grounding details.

Master-Slave Series Overview

Background

When connecting PSB-1000 power supplies in series, up to 2 units can be used in series and all units must be of the same model. When operated in series, the power supplies can be used to increase the voltage output or setup the power supplies to output both positive and negative polarities. Series operation only requires configuration of the slave, the master unit remains in local mode.

In order for the master unit to control the slave units, the master unit must use the Analog Programming connector on the rear panel to control the slave unit.

When using the Analog Programming connector, the connector must be wired correctly between the master and the slave unit. For the complete connector pin assignment, see page 144, or alternatively, you can use the PSB-104 cable which is pre-configured for series use.

When the units are used in series, a number of precautions and limitations apply. Please read this overview before operating the power supplies in series.

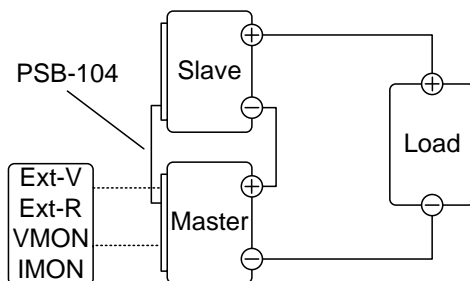

Limitations

Display

- Master and slave units both display the voltage. The total voltage is the sum of the units.
- Only the master unit displays the current.

OVP/OCP

- The master unit can shut down the slave unit when OVP/OCP is tripped on the master unit (if the slave connector is wired for shut down on alarm).
- OVP and OCP level is determined by the master OVP and OCP level. The OVP and OCP level on the slave unit is ignored.

Remote monitoring

- Voltage monitoring (VMON) and current monitoring (IMON) are only supported on the master unit.
- The VMON voltage represents the total voltage of the all the serialized units.

External Voltage and Resistance Control

- Voltage/Resistance controlled remote control can only be used with the master unit.
- The full scale voltage (in series) is equivalent to the maximum external voltage or resistance.

Slew Rate

- The actual slew rate is double that of the setting slew rate. I.e., A slew rate setting of 80.00V/s is actually 160V/s when in series.

Internal Resistance

- The internal resistance is actually twice that of the setting value.

Bleeder Control

- The Master unit is used to control the bleeder settings. The bleeder resistor is always turned on for the slave unit in series mode.

| | Model | 1 unit | 2 units |
|-----------------------------------|-----------|--------|---------|
| Output Voltage/ Output Current | PSB-1400L | 40V | 80V |
| | | 40A | 40A |
| | PSB-1400M | 160V | 320V |
| | | 10A | 10A |
| | PSB-1800L | 40V | 80V |
| | | 80A | 80A |
| | PSB-1800M | 160V | 320V |
| | | 20A | 20A |

Series Connection

Analog Programming Connector Connection

To operate the power supplies in series with the analog programming connectors, connect the analog programming connectors on the master and slave unit as shown in the diagram below:

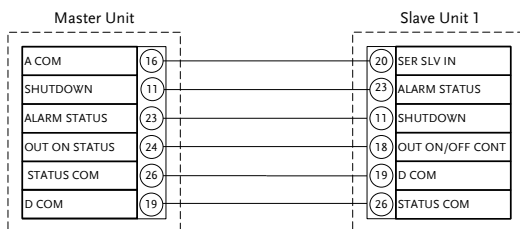

Alternatively, the PSB-104 preconfigured cable can be used.

Series Connection to increase Voltage Output

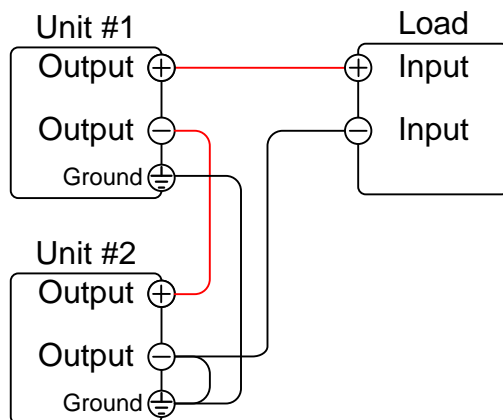

Series Connection
to Output
Positive and
Negative Polarity

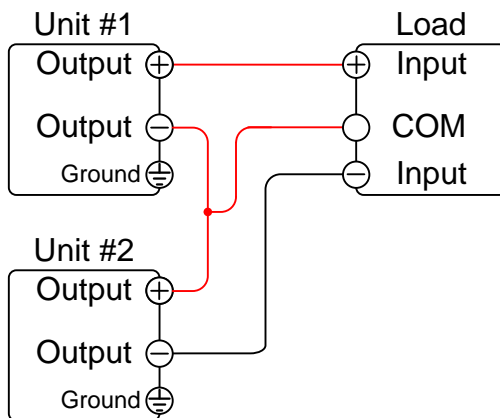

Note: The output reference ground (COMMON) can be grounded at the power supply side instead of the load, depending on the requirements. Local sensing should be used in this configuration.

 Caution

When connecting the units in series, diodes should be connected across each output to prevent reverse voltage.

Series Sense Connection

For remote sense connections, connect the sense terminals as shown below:

- a. Connect the Master S+ terminal to the positive potential of the load.
- b. Connect the Master S- terminal to the positive output terminal of the slave unit.
- c. Connect the slave S+ terminal to the positive terminal of the slave unit.
- d. Connect the slave S- terminal to negative terminal of the load.

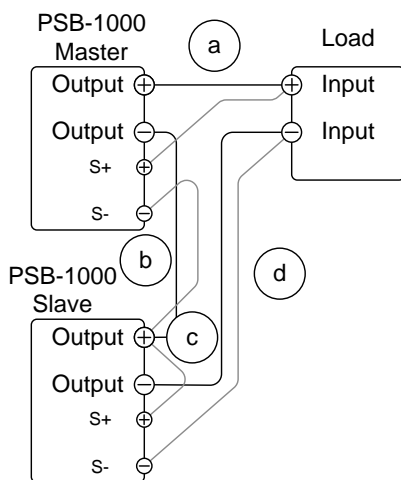

- Steps
1. Ensure the power is off on both power supplies.
 2. Connect the master and slave unit in series as shown above to either increase the voltage output or to create a positive and negative output. Remember that how the units are grounded depends on the configuration of the series connection.
 3. Reattach the terminal cover. → Page 49

 **Note** Ensure load cables have sufficient current capacity. → Page 44

Series Operation

Series Configuration Before using the power supplies in series, the master and slave units need to be configured.

1. Configure the OVP and OCP settings for the master unit. → From Page 69
2. Enter the Power ON Configuration settings and set the Tracking configuration for the master and each connected slave. → Page 93

| Unit | Tracking Setting |
|---------------------------|------------------|
| Master Unit with 1 slave: | Local |
| Slave Unit: | S/Slave |

3. If using voltage sense, disable local sense in the Power ON Configuration settings. → Page 96

4. Cycle the power on the units (reset the power).



Note

Set Tracking to Local to return the slave units to local (independent) operation.

Master-Slave Operation

Only operate the power supplies in series if the units are configured correctly.

Steps

5. Turn on the master and slave units. Turn on both units. When connected in series, each unit will show the voltage of their own unit.

The V Set, A Set, OVP and OCP settings will only be shown on the master unit.

Master unit

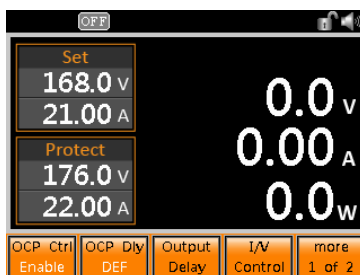

Slave units

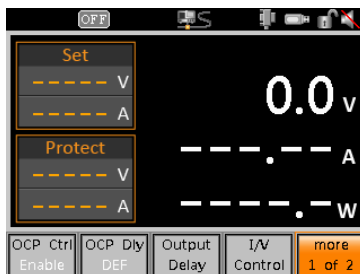

6. Operation of both units is controlled → Page 65 by the master unit. Operation of the master unit is the same as for a single unit. Please see the basic operation chapter for details.

7. Press the Output key to begin.
The output key will turn green.



Only operate the power supplies in series if using units of the same model number.

Only a maximum of 2 units can be used in series.



Ensure that the insulation capacity of the wiring is sufficient when connected in series. See page 39 for insulation capacity and grounding details.

File Operations

View Internal Memory Settings

Internal memory can store up to 3 different setups. The configuration settings in these setups can be viewed from the **FUNC>View Memory** menu.

Overview M1 ~ M3 Memory slot numbers M1 ~ M3.

Steps

1. Press the *FUNC* key. 
2. Use the scroll wheel to go to *View Memory* and press *Enter*.
3. Use the F1, F2 or F3 soft-keys to select a memory slot number, M1, M2 or M3.
 - The soft-key will be highlighted yellow when selected.

Memory Slot M1, M2, M3

4. The scroll wheel can be used to see what settings are currently saved to the selected memory slot.
5. Press *Exit* to return to the Function menu.

Example

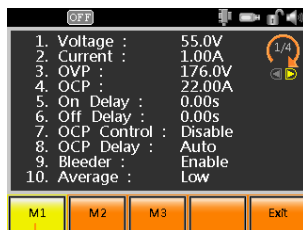

Currently selected memory settings

Selected memory no.

Save/Recall Internal Memory Settings

Settings can be saved or recalled from 3 different internal memory slots.

Steps

1. Press the *File* key.



2. The file system will appear.
3. If a USB stick is inserted in the drive, you will need to go to the internal memory first. Select *Memory* with the scroll wheel and press Enter.

Select
Memory



4. Use the scroll wheel to select *M1*, *M2* or *M3* in the file system.

| Memory Slot | M1, M2, M3 |
|-------------|------------|
| | |

5. To save to the selected memory number, press *Save*[F3].
6. To recall the current settings to the selected memory number press *Recall*[F4].
 - A message will appear if the save/recall was successful.

Example

Selected
memory
number

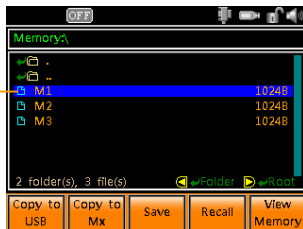

Save, Recall



NOTE

The contents of the internal memory settings can be viewed by pressing *View Memory*[F5]. See page 118 for details.

Copy Internal Memory File

Internal memory settings can be copied to another internal memory slot or to a USB disk drive.

Steps

1. Press the *File* key. File
2. The file system will appear.
3. If a USB stick is inserted in the drive, you will need to go to the internal memory first. Select *Memory* with the scroll wheel and press Enter.

Select
Memory



- Use the scroll wheel to select *M1*, *M2* or *M3* in the file system.

| | |
|-------------|------------|
| Memory Slot | M1, M2, M3 |
|-------------|------------|

- To copy to an another internal memory slot, press *Copy to Mx[F2]*.

Key in the destination memory slot with the number pad. (Press *Copy to Mx* again to cancel).

- To copy to a USB flash drive, press *Copy to USB[F1]*.
 - The selected memory file will be saved as *mX.mem* to the root directory of the USB flash drive, where X is 1, 2 or 3.

Example

Selected
memory
number

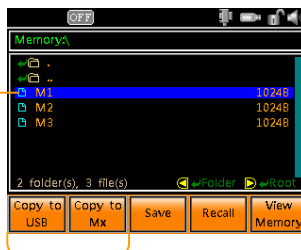

Copy to USB, Copy to Mx



The contents of the internal memory settings can be viewed by pressing *View Memory[F5]*. See page 118 for details.

Copy USB File to Internal Memory

Files that have been previously saved to a USB flash drive (mX.mem) can be copied to an internal memory slot.

Steps

1. Insert a USB flash drive with the setting file that you want to copy to the internal memory into the front panel USB port.

The USB flash drive icon  will appear in the status bar.

2. Press the *File* key.



3. The file system appears.
4. Select USB with the scroll wheel and press Enter.

Select USB



5. Use the scroll wheel to select the memory file that you want to copy to internal memory.

File format mX.mem

6. Press *Copy to Memory*[F1].

7. Key in the memory number when prompted and press Enter.

- A message will appear if successful.

Memory no.: 1 ~ 3

Example

Selected memory file



Copy to Memory

Delete Files on USB Flash Drive

Files on a USB flash disk can be deleted.

Steps

1. Insert a USB flash drive with the file that you want to delete into the front panel USB port.

The USB flash drive icon  will appear in the status bar.

2. Press the *File* key.



3. The file system appears.

4. Select USB with the scroll wheel and press Enter.

Select USB

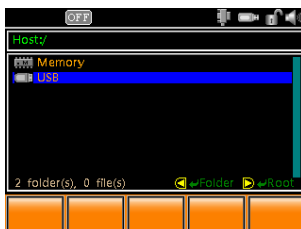

5. Use the scroll wheel to select the file that you want to delete in the file system.
 - Only files on the USB flash drive can be deleted. You cannot delete files in the internal memory.
6. To delete the selected file, press *Delete* [F2].
 - A message will appear if successful.

Example

Selected memory file



Delete

Rename Files on the USB Flash Drive

Files on a USB flash disk can be renamed using an on-screen keyboard.

Steps

1. Insert a USB flash drive with the file that you want to rename into the front panel USB port.

The USB flash drive icon  will appear in the status bar.

2. Press the *File* key.



3. The file system appears.
4. Select USB with the scroll wheel and press Enter.
5. Use the scroll wheel to select the file that you want to rename in the file system.
 - Only files on the USB flash drive can be renamed. You cannot rename files in the internal memory.
6. To rename the selected file, press *Rename* [F3].

Selected memory file



Rename

7. An on-screen keyboard appears.
 - Use the scroll wheel to move the keyboard cursor.
 - Press *A↔a 1↔!*[F1] to toggle the key board from upper case and numerals to lower case and symbols.
 - Press *Enter Character*[F2] or the right arrow key to enter in the chosen character.
 - Press the left arrow key to delete a character.

8. Press Enter to finish editing the file name.

Example

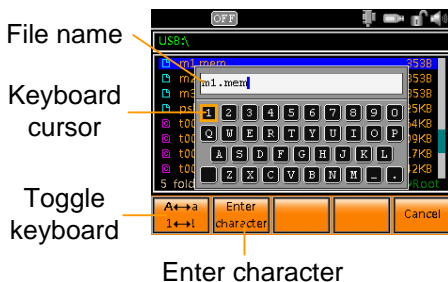

To cancel renaming the file while the keyboard is displayed, press *Cancel*[F5].

Sequence Function

The Sequence function is able to load a number of sequences from USB memory and load them into 10 sequence slots (sequence 0 ~ 9). The sequences can be moved to different slots, deleted and saved back to USB.

The creation of sequences by the end-user is not supported. Please see your distributor for more details about sequences and how GW Instek can create customized test sequences for your needs.

The following section describes how to load, run and save sequences.



Note

To create sequences please see your distributor.

- Sequence File Format → from page 128
- Copy Sequence from a USB Flash Disk to Internal Memory → from page 128
- Load and Run a Sequence from a USB Flash Disk → from page 130
- Copy, Move, Clear Sequences in Internal Memory → from page 132
- Load and Run Sequence from Internal Memory → from page 135

Sequence File Format

Background The sequence files are saved in *.csv file format.

Each file is saved as tXXX.csv, where XXX is the save file number 001~010.

Copy Sequence from a USB Flash Disk to Internal Memory

Overview A sequence can be copied from a USB flash disk to a selected sequence in internal memory.

- Ensure the sequence is placed in the root directory or a directory with a directory name of 8 or less characters.

Steps

1. Insert a USB flash drive into the front panel USB-A slot. Ensure the flash drive contains a sequence file.



2. The USB icon will appear in the status bar when the USB flash drive is detected.



3. Press the *File* key.



- Use the scroll wheel to go to *USB* and press *Enter*.

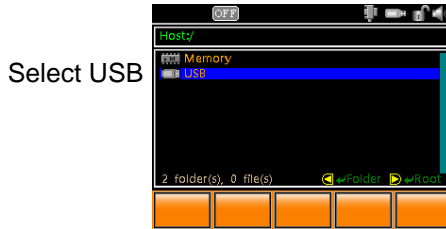

- Press more 1 of 2[F5].



- Use the scroll wheel to highlight the sequence that you want to copy to internal memory.

- Press the *Copy to SeqX[F1]* soft-key.



- Key in the sequence number that you want the sequence copied to and then press *Enter*.

Sequence No.: 0 ~ 9

Example



Selected sequence

Sequence files

Destination sequence

Load and Run a Sequence from a USB Flash Disk

Overview A sequence can be loaded directly from a USB flash drive instead of from internal memory. After a sequence is loaded it can be run.

- Ensure the sequence is placed in the root directory or a directory with a directory name of 8 or less characters.

Steps

1. Insert a USB flash drive into the front panel USB-A slot. Ensure the flash drive contains a sequence file.



2. The USB icon will appear in the status bar when the USB flash drive is detected.



3. Press the *File* key.



4. Use the scroll wheel to go to *USB* and press *Enter*.

Select USB

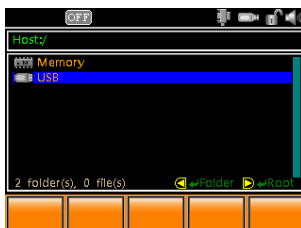

5. Press more 1 of 2[F5].



6. Use the scroll wheel to highlight the sequence that you want to run (load).

7. Press the *Load to SEQ*[F2] soft-key.



- The selected sequence will load and the unit will be ready to run the sequence.
- A “Ready...” message will appear on the display indicating that the sequence is ready to be run.

Sequence Screen

Run status

Sequence step number

Ready message

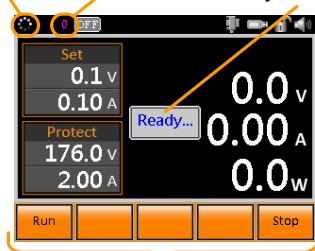

Run, Restart, Stop soft-keys



Note

An error message will appear on the display if there was an error loading the sequence from USB memory.

8. Press *Run*[F1].



The run status icon becomes a play icon: 

9. The sequence will start and go through each step in order until the sequence has finished unless the sequence is stopped before it has finished. The currently active step is shown at the top of the status bar.

Restart Sequence 10. When a sequence has already started, or has finished (assuming it doesn't have an infinite number of run cycles) then the sequence can be restarted by pressing Restart[F2].



Stop Sequence 11. To stop a sequence at any time, press Stop[F5].



Copy, Move, Clear Sequences in Internal Memory

Overview Sequences that are stored in internal memory can be copied to USB, copied to another memory number, moved to another memory number or deleted from internal memory.

Operations Copy to USB The Copy to USB function saves a sequence from the internal memory to the root directory of the USB flash drive.

- Files will be saved as tXXX.csv where XXX is the memory number 001~ 010 from which the sequence was exported from.
- Files of the same name on the USB flash drive will be written over.

Copy to SeqX Copies the selected sequence to a destination sequence memory number.

Move to SeqX Moves the selected sequence to a destination sequence memory number.

- The source sequence will be cleared (deleted).

Clear Deletes the selected sequence from memory.

Steps

1. Insert a USB flash drive into the front panel USB-A slot.



2. The USB icon will appear in the status bar when the USB flash drive is detected.



3. Press the *FUNC* key.



4. Use the scroll wheel to go to *Sequence* and press *Enter*.

A list of sequences that have been previously loaded to the internal memory will be shown on the screen.

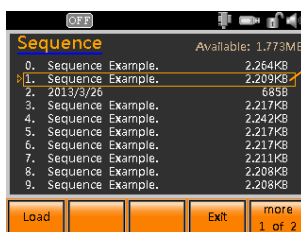

Selected sequence

Sequence 0 ~ 9

5. Use the scroll wheel to highlight the sequence that you want to copy, move or clear.

6. Press more 1 of 2[F5].

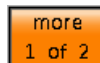

7. Select the operation that you wish to perform:

Copy to USB:

Press the *Copy to USB*[F1] soft-key to copy the selected sequence to the root directory of the USB drive.



- The file format: t00X.csv
Where X is 0 ~ 9.

Copy to SeqX:

Press *Copy to SeqX*[F2] and then key in the sequence destination with the number pad. Press *Enter* to confirm the operation.

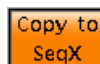

Sequence No.: 0 ~ 9

Move to SeqX:

Press *Move to SeqX*[F3] and then key in the sequence destination with the number pad. Press *Enter* to confirm the operation.



Sequence No.: 0 ~ 9

Clear:

Press *Clear*[F4] and then key in the sequence destination with the number pad. Press *Enter* to confirm the operation.



Load and Run Sequence from Internal Memory

Overview Any sequence in internal memory can be run.

Sequence Load Screen Overview The sequence menu will list in order: sequence number, sequence name and file size.

Sequence no. Title name File size

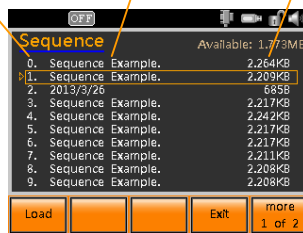

Steps

1. Press the *FUNC* key.



2. Use the scroll wheel to go to *Sequence* press *Enter*.

A list of sequences that have been previously loaded to the internal memory will be shown on the screen.

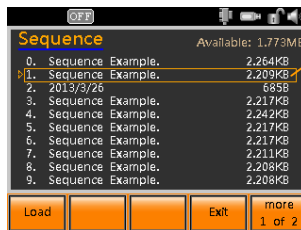

3. Use the scroll wheel to highlight the sequence that you want to load.

4. Press Load[F1] to load the selected sequence.



The selected sequence will load and the unit will be ready to run the sequence.

A “Ready...” message will appear on the display indicating that the sequence is ready to be run.

Sequence Screen

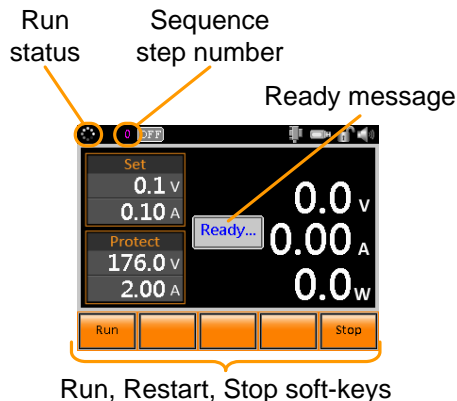

5. Press Run[F1].



The run status icon becomes a play icon:



6. The sequence will start and go through each step in order until the sequence has finished unless the sequence is stopped before it has finished. The currently active step is shown at the top of the status bar.

Restart Sequence 7. When a sequence has already started, or has finished (assuming it doesn't have an infinite number of run cycles) then the sequence can be restarted by pressing *Restart*[F2].



Stop Sequence 8. To stop a sequence at any time, press *Stop*[F5].



Trigger Input & Output

The PSB-1000 has a trigger input, trigger output and voltage trigger output BNC terminal. The following section describes how to configure these terminals.

- TRIG IN BNC → from page 138
- TRIG OUT BNC → from page 139
- Voltage Trigger → from page 141

TRIG IN BNC

Background By default a positive pulse can be applied to the TRIG IN terminal to turn the output on. This can be configured to a negative signal.

| | | |
|---------------------------|-----|------------------------------|
| Parameter Settings | POS | Positive pulse signal (1ms). |
| | NEG | Negative pulse signal (1ms). |

TRIG IN BNC

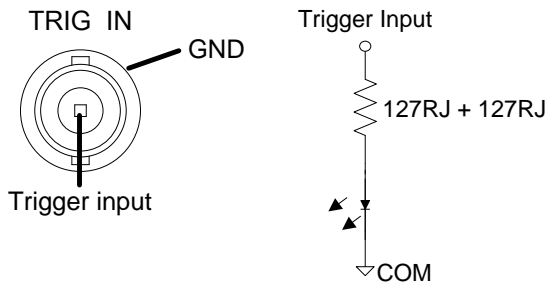

Steps 1. Press the *FUNC* key.



2. Use the scroll wheel to go to *TRIG IN*.

- Use the F1 & F2 soft-keys to set the voltage trigger to positive or negative pulse.

TRIG IN POS, NEG

- Press *Exit* to exit from the Function menu.

Example

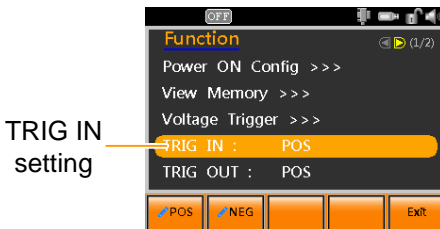

TRIG OUT BNC

Background

The TRIG OUT BNC outputs a 1ms pulse, pulled up to 5V, when the output is turned on. The pulse can be configured to be a negative or positive going pulse.

Pin 24 (OUTPUT ON STATUS) will also follow the negative or positive setting that is chosen below.

Parameter Settings

POS Positive signal.

NEG Negative signal.

TRIG OUT BNC

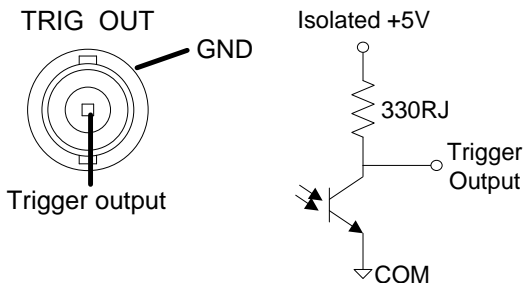

Steps

1. Press the *FUNC* key. FUNC

2. Use the scroll wheel to go to *TRIG OUT*.

3. Use the F1 & F2 soft-keys to set the pulse polarity to positive or negative when the output is turned on.

TRIG OUT POS, NEG

4. Press *Exit* to exit from the Function menu.

Example

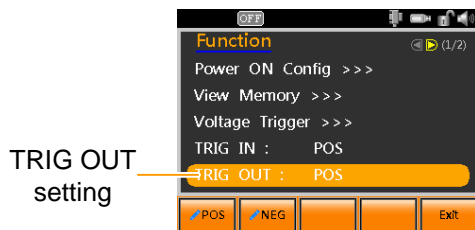

Voltage Trigger

Configures and enables/disables the voltage trigger output. The voltage trigger will output a trigger signal (positive or negative polarity) that tracks the voltage output when pre-defined thresholds (Vt1, Vt2) have been reached.

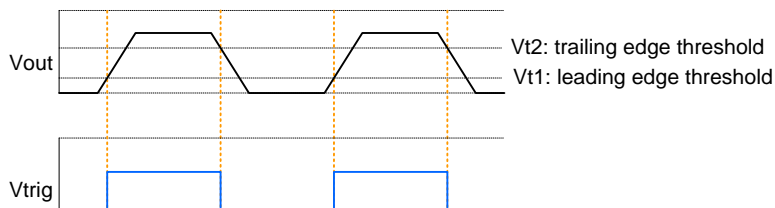

| | | |
|--------------------|---------------|---|
| Parameter Settings | Vtrig Control | Enable/Disable: Turns Voltage control on or off. |
| | Vt1 | Sets the voltage threshold level of the leading edge of the Vtrig output pulse. |
| | Vt2 | Sets the voltage threshold level for the trailing edge of the Vtrig output pulse. |
| | Tref | POS/NEG: Sets the polarity of the Vtrig output pulse. |

VOLT TRIG BNC

VOLT TRIG



The VOLT TRIG port on the rear panel outputs a 0 ~ 5V signal that is internally pulled high by a 1kΩ resistor.

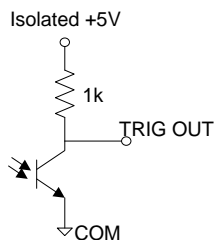

Steps

5. Press the *FUNC* key.



6. Use the scroll wheel to go to *Voltage Trigger* and press *Enter*.

7. Go to the *Vtrig Control* setting using the scroll wheel.

8. Use the F1 & F2 soft-keys to enable or disable the voltage trigger.

Vtrig Control Enable, Disable

9. Go to the *Vt1* or *Vt2* settings using the scroll wheel.

10. Key in the desired the threshold levels with the number pad or use the F1 & F2 soft-keys to set to the minimum or maximum level.

Vt1, Vt2 0 ~ 105% rated voltage, Min, Max

11. Go to the *Tref* settings using the scroll wheel.

12. Use the F1 & F2 soft-keys to set to the polarity to positive or negative.

Tref POS, NEG

13. Press *Exit* to return to the Function menu.

Example

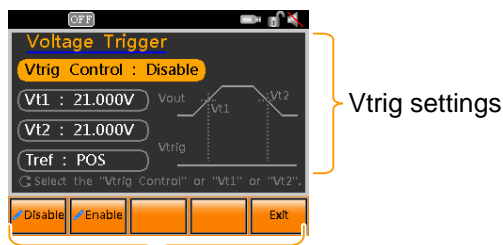

Select Vtrig settings

E XTERNAL CONTROL

The rear panel has an analog programming connector, a TRIG IN BNC terminal, a TRIG OUT BNC terminal and a VOLT TRIG BNC terminal. The Analog Programming Terminal is used for external voltage, current and resistance control of current and voltage output. The trigger BNC terminals are used for trigger input and output signals.

| | |
|---|------------|
| Analog Control | 144 |
| Analog Programming Connector Overview | 144 |
| External Voltage Control of Voltage Output | 147 |
| External Voltage Control of Current Output | 149 |
| External Resistance Control of Voltage Output..... | 150 |
| External Resistance Control of Current Output | 152 |
| External Control of Output | 155 |
| External Control of Shutdown | 157 |
| External Alarm Clear..... | 159 |
| | |
| Remote Monitoring | 161 |
| External Voltage and Current Monitoring | 161 |
| External Operation and Status Monitoring..... | 163 |

Analog Control

Analog Programming Connector Overview

Overview The Analog Programming connector is a standard 26 pin MIL connector (OMRON XG4 IDC plug). The connector is used for all analog remote control. The pins used determine what remote control mode is used.

Pin Assignment

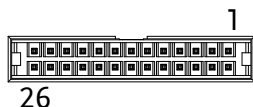

| Pin name | Pin number | Description |
|--------------------|------------|---|
| CURRENT SHARE | 1 | Used when operating 2 or more units in parallel. |
| CURRENT SUM OUT | 2 | Current sum output signal when used in parallel mode. |
| EXT-V CV CONT | 3 | External voltage control of the voltage output. A voltage of 0~10V is used to control the full scale voltage output (0%~100%) of the instrument. |
| EXT-V CC CONT | 4 | External voltage control of the current output. A voltage of 0~10V is used to control the full scale current output (0%~100%) of the instrument. |
| EXT-R CV CONT PIN1 | 5 | External resistance control of the voltage output. A resistance of 0kΩ ~ 10kΩ is used to control the full scale voltage output (0%~100%) of the instrument. |
| EXT-R CV CONT PIN2 | 6 | External resistance control of the voltage output. A resistance of 0kΩ ~ 10kΩ is used to control the full scale voltage output (0%~100%) of the instrument. |

| | | |
|-----------------------|----|--|
| EXT-R CC CONT PIN1 | 7 | External resistance control of the current output. A resistance of $0k\Omega \sim 10k\Omega$ is used to control the full scale current output (0%~100%) of the instrument. |
| EXT-R CC CONT PIN2 | 8 | External resistance control of the current output. A resistance of $0k\Omega \sim 10k\Omega$ is used to control the full scale current output (0%~100%) of the instrument. |
| V MON | 9 | Voltage Monitor Output. Outputs the full scale voltage (0~100%) as a voltage (0V~10V). |
| I MON | 10 | Current Monitor Output. Outputs the full scale current (0~100%) as a voltage (0V~10V). |
| SHUTDOWN | 11 | The shut down signal will turn off the output or power when a low TTL signal is applied. The shutdown signal is pulled up to 5V with a $10k\Omega$ pull-up resistor. |
| CURRENT_SUM_ 1 | 12 | Master unit current sum input signal from first slave CURRENT SUM OUTPUT. Used in parallel mode only. |
| CURRENT_SUM_ 2 | 13 | Master unit current sum input signal from first slave CURRENT SUM OUTPUT. Used in parallel mode only. |
| CURRENT_SUM_ 3 | 14 | Master unit current sum input signal from first slave CURRENT SUM OUTPUT. Used in parallel mode only. |
| FEEDBACK | 15 | Parallel control signal during master-slave parallel operation. |
| A COM | 16 | Analog signal common. Connected to the sense-terminal when remote sense is used. Connected to the negative output terminal when remote sense is not used. |
| ALARM CLEAR | 17 | Alarm clear terminal. Alarms are cleared when a low TTL level signal is applied to this terminal. |

| | | |
|---------------------|----|---|
| OUT ON/OFF CONT | 18 | Turns the output on/off when (default setting) a low TTL signal is applied. Internally, the circuit is pulled up to +5V with 10k Ω resistance. |
| D COM | 19 | Connected to the (-S) sense- terminal when remote sense is used. Connected to the negative output terminal when remote sense is not used. |
| SER SLV IN | 20 | Series slave input during master-slave series operation. |
| CV STATUS | 21 | Turns on when CV mode is active. (photo coupled open collector output) |
| CC STATUS | 22 | Turns on when CC mode is active. (photo coupled open collector output) |
| ALARM STATUS | 23 | Turns on when any of the protection modes are tripped (OVP, OCP) or if a shutdown signal is input. (photo coupled open collector output) |
| OUTPUT ON STATUS | 24 | Turns on when the output has been turned on. (photo coupled open collector output) |
| POWER OFF STATUS | 25 | Turns on when the power switch is turned off. |
| STATUS COM | 26 | Common for status signals 21, 22, 23, 24 and 25. |

Open collector output: 30V max, 8mA max.

The common line for the status pins is floating (isolated voltage of 60 V or less). It is isolated from the control circuit.

External Voltage Control of Voltage Output

Background An external voltage of 0~10V is used to control the full scale voltage output (0%~100%) of the instrument.

Output voltage = full scale voltage x (external voltage/10)

Connection When connecting the external voltage source to the Analog Programming connector, use shielded or twisted paired wiring.

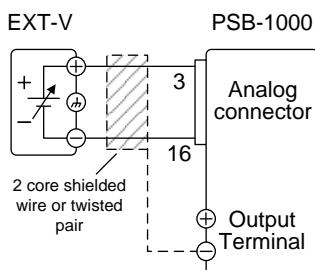

- Pin3 → EXT-V (+)
- Pin16 → EXT-V (-)
- Wire shield → negative (-) output terminal

- Panel operation**
1. Connect the external voltage according to the connection diagrams above.
 2. Set the CV Control Settings to EXT- Page 87 V.
 - Be sure to cycle the power after the power on configuration has been set.
 3. Press the Output key. The voltage can now be controlled with the external voltage.

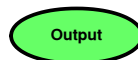

**Note**

The input impedance for external voltage control is 10k Ω .

Use a stable voltage supply for the external voltage control.

**Note**

CV and CC slew rate settings are disabled when using external voltage control. See the slew rate settings on page 81.

**CAUTION**

Ensure no more than 10.5V is input into the external voltage input.

Ensure the voltage polarity is correct when connecting the external voltage.

External Voltage Control of Current Output

Background

A voltage of 0~10V is used to control the full scale current output (0%~100%) of the instrument.

Output current = full scale current x (external voltage/10)

Connection

When connecting the external voltage source to the connector, use shielded or twisted paired wiring.

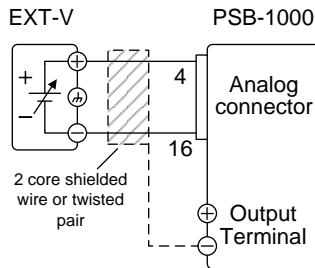

- Pin4 → EXT-V (+)
- Pin16 → EXT-V (-)
- Wire shield → negative (-) output terminal

Steps

1. Connect the external voltage according to the connection diagrams above.
2. Set the CC Control Settings to EXT- Page 89 V.
 - Be sure to cycle the power after the power on configuration has been set.
3. Press the Output key. The current can now be controlled with the external voltage.

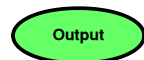



Note

The input impedance for external voltage control is 10k Ω .

Use a stable voltage supply for the external voltage control.



Note

CV and CC slew rate settings are disabled when using external voltage control. See the slew rate settings on page 81.



CAUTION

Ensure no more than 10.5V is input into the external voltage input.

Ensure the voltage polarity is correct when connecting the external voltage.

External Resistance Control of Voltage Output

Background

A resistance of 0k Ω ~ 10k Ω is used to control the full scale voltage output (0%~100%) of the instrument.

The output voltage (0 to full scale) can be controlled with the external resistance rising (0k Ω ~10k Ω) or falling (10k Ω ~0k Ω).

Rising:

For 0k Ω ~10k Ω : Output voltage = full scale voltage \times (external resistance/10)

Falling:

For 10k Ω ~0k Ω : Output voltage = full scale voltage \times ([10-external resistance]/10)



Note

The falling resistance configuration is recommended for safety reasons. In the event that the cables become accidentally disconnected (high Ω), the voltage output will drop to zero. Under similar circumstances using the rising resistance configuration, an unexpectedly high voltage would be output.

If switches are used to switch between fixed resistances, use switches that avoid creating open circuits. Use short-circuit or continuous resistance switches.

Connection

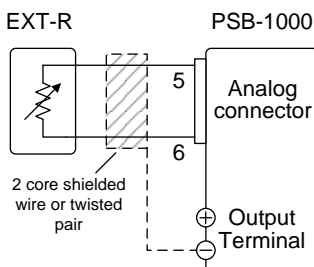

- Pin5 → EXT-R
- Pin6 → EXT-R
- Wire shield → negative (-) output terminal

Steps

1. Connect the external resistance according to the connection diagrams above.
2. Set the CV Control Settings to Ext- → Page 87 R↗, Ext-R↘ (rising or falling R).
 - Be sure to cycle the power after the power on configuration has been set.
3. Press the Output key. The voltage can now be controlled with the external resistance.

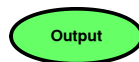



Ensure the resistor(s) and cables used exceed the isolation voltage of the power supply. For example: insulation tubes with a withstand voltage higher than the power supply can be used.

When choosing an external resistor ensure the resistor can withstand a high degree of heat.



CV and CC slew rate settings are disabled when using external resistance control. See the slew rate settings on page 81.

External Resistance Control of Current Output

Background

A resistance of $0\text{k}\Omega \sim 10\text{k}\Omega$ is used to control the full scale current output (0%~100%) of the instrument.

The output current (0 to full scale) can be controlled with the external resistance rising ($0\text{k}\Omega \sim 10\text{k}\Omega$) or falling ($0\text{k}\Omega \sim 0\text{k}\Omega$).

Rising:

For $0\text{k}\Omega \sim 10\text{k}\Omega$: Output current = full scale current \times (external resistance/10)

Falling:

For $10\text{k}\Omega \sim 0\text{k}\Omega$: Output current = full scale current \times ([10-external resistance]/10)



Note

The falling resistance configuration is recommended for safety reasons. In the event that the cables become accidentally disconnected, the current output will drop to zero (high Ω). Under similar circumstances using the rising configuration, an unexpectedly high current would be output.

If switches are used to switch between fixed resistances, use switches that avoid creating open circuits. Use short-circuit or continuous resistance switches.

Connection

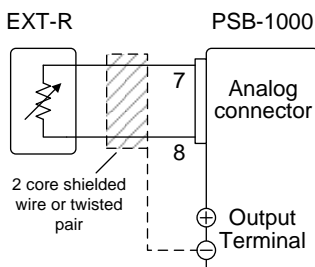

- Pin7 → EXT-R
- Pin8 → EXT-R
- Wire shield → negative (-) output terminal

Steps

1. Connect the external resistance according to the connection diagrams above.
2. Set the CC Control Settings to Ext- → Page 89 R↗, Ext-R↘ (rising or falling R).
 - Be sure to cycle the power after the power on configuration has been set.
3. Press the Output key. The current can now be controlled with the external resistance.

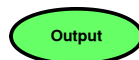

**Note**

Ensure the resistor(s) and cables used exceed the isolation voltage of the power supply. For example: insulation tubes with a withstand voltage higher than the power supply can be used.

When choosing an external resistor ensure the resistor can withstand a high degree of heat.

**Note**

CV and CC slew rate settings are disabled when using external resistance control. See the slew rate settings on page 81.

External Control of Output

Background

The output can be turned on or off externally using a switch. The analog programming connector can be set to turn the output on from a high or low signal. The voltage across pins 18 and 19 are internally pulled up to +5V with 10kΩ pull-up resistor. A short (closed switch) produces a low signal.

When Ext-Out = High, the output is turned on when the pins 18-19 are open.

When Ext-Out = Low, the output is turned on when pins 18-19 are shorted.

Connection

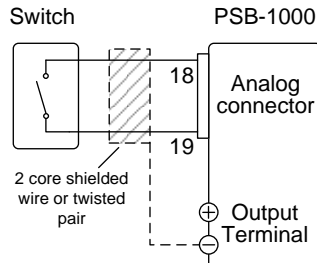

- Pin18 → Switch
- Pin19 → Switch
- Wire shield → negative (-) output terminal

Steps

1. Connect the external switch according to the connection diagrams above.
2. Set the Ext-Out setting to High → Page 94 (open switch = output on) or Low (closed switch = output on).
 - Be sure to cycle the power after the power on configuration has been set.

3. The switch is now ready to set the output on or off.



Note

When using a switch over long distances, please use a switch relay to extend the line from the coil side of the relay.

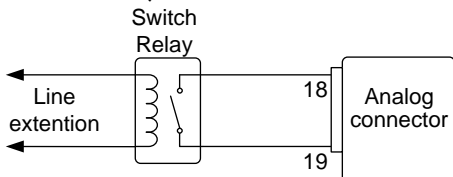

If a single switch control is to be used for multiple units, please isolate each instrument. This can be achieved by using a relay.



Warning

Ensure the cables used and the switch exceed the isolation voltage of the power supply. For example: insulation tubes with a withstand voltage higher than the power supply can be used.



Note

Output On/Off Delay settings are disabled when the output is set to external control. See page 79 for details.

External Control of Shutdown

Background The output of the power supplies can be configured to shut down via an external switch. The voltage across pins 11 and 16 are internally pulled to +5V with 10k Ω pull-up resistor. The output is turned off when a low TTL level signal is applied.

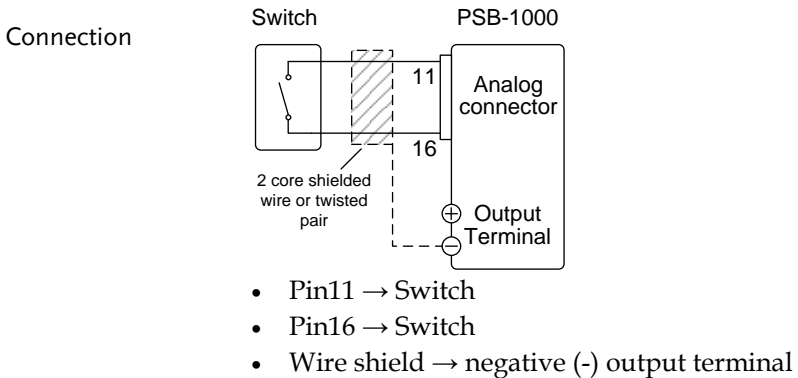

- Steps**
1. Connect the external switch according to the connection diagrams above.
 2. The switch will now shut down the power supply when shorted.
-



Note

When using a switch over long distances, please use a switch relay to extend the line from the coil side of the relay.

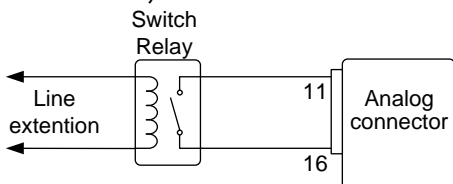

If a single switch control is to be used for multiple units, please isolate each instrument. This can be achieved by using a relay.



Warning

Ensure the cables and switch used exceed the isolation voltage of the power supply. For example: insulation tubes with a withstand voltage higher than the power supply can be used.

External Alarm Clear

Background Alarms (OCP, OVP, OTP) can be cleared by an external switch. The voltage is internally pulled to +5V with 10kΩ pull-up resistor. The output is turned off when a low TTL level signal is applied across pins 17 and 19.

Connection

Switch PSB-1000

17 19

Analog connector

Output Terminal

2 core shielded wire or twisted pair

- Pin17 → Switch
- Pin19 → Switch
- Wire shield → negative (-) output terminal

- Steps**
1. Connect the external switch according to the connection diagrams above.
 2. The switch can now be used to clear a alarms.

 **Note**

When using a switch over long distances, please use a switch relay to extend the line from the coil side of the relay.

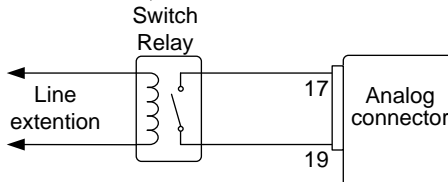

If a single switch control is to be used for multiple units, please isolate each instrument. This can be achieved by using a relay.

**Warning**

Ensure the cables and switch used exceed the isolation voltage of the power supply. For example: insulation tubes with a withstand voltage higher than the power supply can be used.

Remote Monitoring

The PSB-1000 power supplies have remote monitoring support for current and voltage output. They also support monitoring of operation status and alarm status.

- External monitoring of output voltage and current → from page 161
- External monitoring of operation mode and alarm status → from page 163

External Voltage and Current Monitoring

Background

The Analog Programming connector is used to monitor the current (IMON) or voltage (VMON) output.

An output of 0~10V represents the voltage or current output of 0~ rated current/voltage output.

- $IMON = (\text{current output} / \text{full scale}) \times 10$
- $VMON = (\text{voltage output} / \text{full scale}) \times 10$

VMON Connection

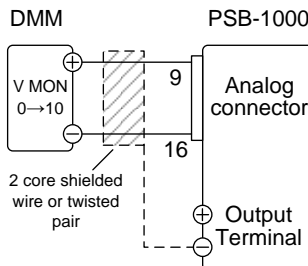

- Pin9 → Pos (+)
- Pin16 → Neg (-)

IMON Connection

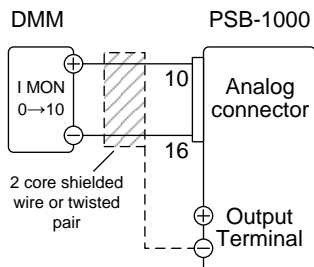

- Pin10 → Pos (+)
- Pin16 → Neg (-)



Note

Maximum current is 5mA. Ensure the sensing circuit has an input impedance greater than 1MΩ.

The monitor outputs are strictly DC and should not be used to monitor analog components such as transient voltage response or ripple etc.

Steps

1. Connect the external switch according to the connection diagrams above.
2. An external DMM can now be used to monitor the voltage or current output.



CAUTION

Ensure IMON(pin 10) and VMON(pin 9) are not shorted together. This may cause damage to the unit.

External Operation and Status Monitoring

Background

The analog control connector can also be used to monitor the status operation and alarm status of the instrument.

The pins are isolated from the power supply internal circuitry by photo couplers. Status COM (Pin 26) is a photo coupler emitter outputs, whilst pins 21~25 are photo coupler collector outputs.

A maximum of 30V and 8mA can be applied to each pin. The Status Com pin is floating with an isolation voltage of 60V.

| Name and Pin | Description |
|------------------|--|
| STATUS COM 26 | Common (photo coupler emitter) for status signals 21 ~ 25. |
| CV STATUS 21 | Low when CV mode is active. |
| CC STATUS 22 | Low when CC mode is active. |
| ALM STATUS 23 | Low when any of the protection modes are tripped (OVP, OCP, OTP, AC-FAIL, Power Limit and Shutdown). Active low. |
| OUT ON STATUS 24 | Low when the output is on. |
| PWR ON STATUS 25 | Active low. |

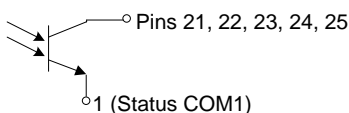

Timing diagrams Below are 4 example timing diagrams covering a number of scenarios. Note that pins 21~25 are all active low.

CV MODE:
Output turned on The diagram below shows the timing diagram when the output is turned on when the PSB-1000 is set to CV mode.

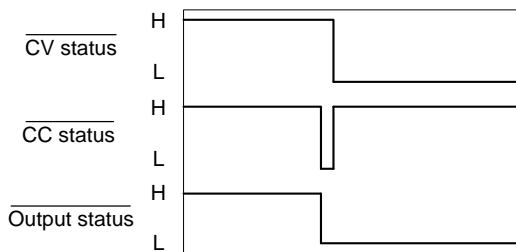

CV MODE:
Output turned off The diagram below shows the output status lines when the output is turned off in CV mode.

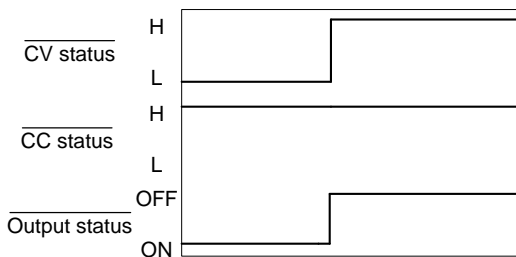

CC MODE:
Output turned on

The diagram below shows the timing diagram when the output is turned on when the PSB-1000 is set to CC mode.

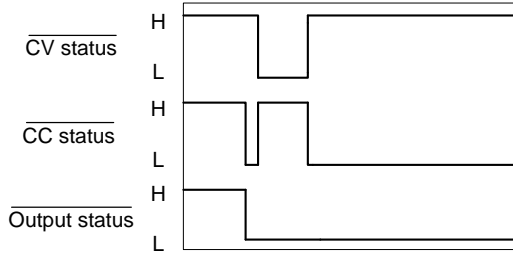

CC MODE:
Output turned off

The diagram below shows the output status lines when the output is turned off in CC mode.

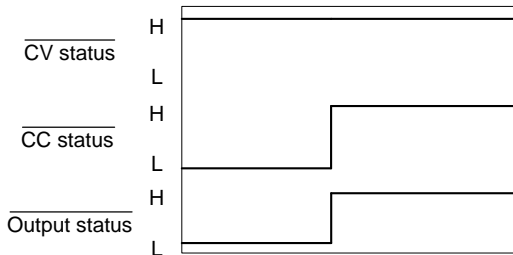

C

COMMUNICATION

INTERFACE

This chapter describes basic configuration of IEEE488.2 based remote control. For a command list, refer to the programming manual, downloadable from GW Instek website, www.gwinstek.com



Note



If the instrument is remotely controlled via the USB/LAN/GPIB interface, the remote panel lock is automatically enabled. Press the Main/Local key on the front panel to return to local control.

| | |
|--|------------|
| Interface Configuration | 167 |
| USB Remote Interface | 167 |
| USB Remote Control Function Check | 169 |
| Using Realterm to Establish a Remote Connection..... | 170 |
| Configure GPIB Interface - Optional..... | 173 |
| GPIB Function Check | 175 |
| Configure Ethernet Connection | 178 |
| Web Server Remote Control Function Check..... | 180 |

Interface Configuration

USB Remote Interface

| | | |
|-------------------|-------------------------|---|
| USB configuration | PC side connector | Type A, host |
| | PSB-1000 side connector | Rear panel Type B, slave |
| | USB Class | CDC (communications device class) |
| Settings | Disable | Disables the rear panel USB port |
| | Auto | Sets the rear panel USB port to auto. This will automatically set the port to full or high speed. |
| | Full | Manually sets the port to full speed. |

- Steps
1. Connect the Type A-Type B USB cable from the PC to the rear panel USB B port. 
 2. Press the *Utility* key. The Utility menu will appear on the display. 
 3. Go to the *Interface >>>* setting using the scroll wheel and press *Enter*.
 4. Use the scroll wheel to go to the *Rear USB* setting and use the soft-keys to set the USB interface.
-
- | | |
|----------|----------------------|
| Rear USB | Disable, Auto, Full. |
|----------|----------------------|

- When the USB port is connected to the PC the USB icon will appear at the top of the display to show the connection status.

Connection status

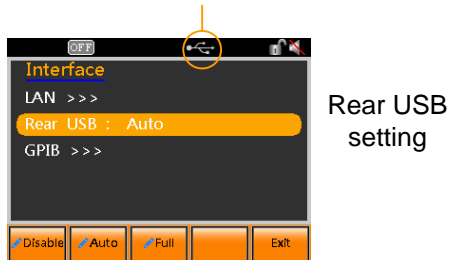

Exit

- Press *Exit*[F5] to exit from the rear panel USB settings.

USB Remote Control Function Check

Functionality
check

Invoke a terminal application such as Realterm.

For USB communication the PSB-1000 emulates a COM port. The UART settings for the USB connection can be seen in the Windows Device Manager.

To check the COM settings in Windows, see the Device Manager. For example, in Win7 go to the Control panel → Hardware and Sound → Device Manager.



Note

If you are not familiar with using a terminal application to send/receive remote commands from via a USB connection, please see page 170 for more information.

Run this query command via the terminal after the instrument has been configured for USB remote control (page 167):

*IDN?

This should return the manufacturer, model number, software version and serial number:

```
GW_INSTEK,PSB-1400L,TWXXXXXXXXXX,  
X.XX.XXXXXXXXX
```

Manufacturer: GWINSTEK

Model number : PSB-1400L

Serial number : TWXXXXXXXXXX

Software version : X.XX.XXXXXXXXX



Note

For further details, please see the programming manual, available on the GW Instek web site @ www.gwinstek.com.

Using Realterm to Establish a Remote Connection

Background

Realterm is a terminal program that can be used to communicate with a device attached to the serial port of a PC or via an emulated serial port via USB.

The following instructions apply to version 2.0.0.70. Even though Realterm is used as an example to establish a remote connection, any terminal program can be used that has similar functionality.



Note

Realterm can be downloaded on Sourceforge.net free of charge.

For more information please see <http://realterm.sourceforge.net/>

Operation

1. Download Realterm and install according to the instructions on the Realterm website.
2. Connect the PSB-1000 via USB (page 167).
3. Go to the Windows device manager and find the COM port number for the connection. For example, go to the Start menu > Control Panel > Hardware and Sound > Device Manager.

Double click the *Ports* icon to reveal the connected serial port devices and the COM port for the each connected device.

When using USB, the baud rate, stop bit and parity settings can be viewed by right-clicking the connected device and selecting the *Properties* option.

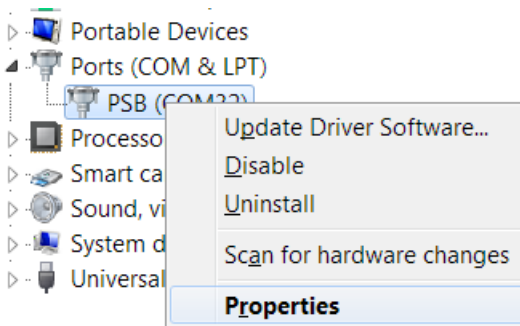

4. Start Realterm on the PC as an administrator.
Click:
Start menu>All Programs>RealTerm>realterm

Tip: to run as an administrator, you can right click the Realterm icon in the Windows Start menu and select the *Run as Administrator* option.

5. After Realterm has started, click on the *Port* tab.

Enter the *Baud*, *Parity*, *Data bits*, *Stop bits* and *Port* number configuration for the connection as shown in the Device Manager.

The *Hardware Flow Control*, *Software Flow Control* options can be left at the default settings.

Press *Open* to connect to the PSB-1000.

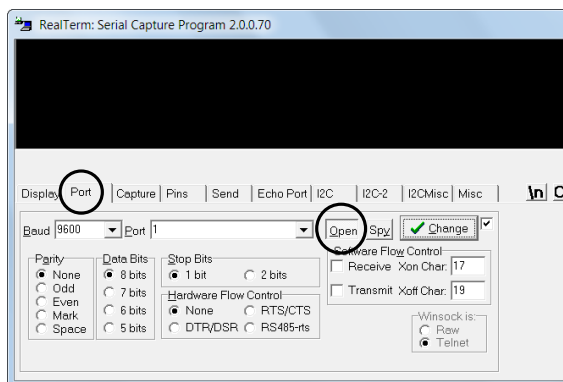

6. Click on the *Send* tab.

In the *EOL* configuration, check on the *+LF* check boxes.

Enter the query:

**idn?*

Click on *Send ASCII*.

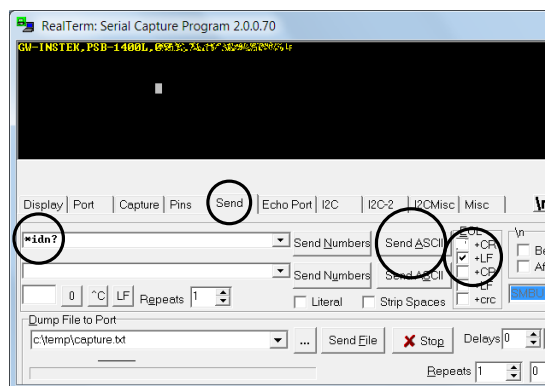

7. The terminal display will return the following:

```
GW_INSTEK,PSB-1400L,TWXXXXXXXXXXXXX,
X.XX.XXXXXXXXXX
```

(manufacturer, model, serial number, software version)

8. If Realterm fails to connect to the PSB-1000, please check all the cables and settings and try again.

Configure GPIB Interface - Optional

To use GPIB, the optional PSB-105 GPIB interface card must first be installed.





Note

The GPIB interface card (PSB-105) must first be installed before the GPIB interface can be used for remote control. Please see page 50 for installation details.

GPIB
Configuration

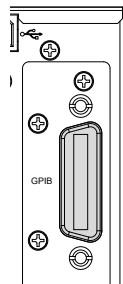
1. Connect a GPIB cable from the PC to the GPIB on the interface card.



2. Press the *Utility* key. The Utility menu will appear on the display. 
3. Go to the *Interface >>>* setting using the scroll wheel and press *Enter*.
4. Use the scroll wheel to go to the *GPIB* setting and press *Enter*.
5. Go to the *GPIB Control* setting and select *Enable*.

GPIB Control Disable, Enable.

6. Go to the GPIB Address, key in the address using the keypad and then press *Enter*.

GPIB Address 0 ~ 30

7. Press the *[F4] Save* soft-key to save the GPIB settings.
8. The GPIB icon will appear in the status bar to indicate that the GPIB connection is enabled.

Connection status

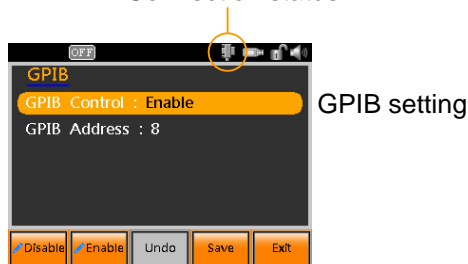

Exit

9. Press *Exit[F5]* to exit from the GPIB settings.

GPIB constraints

- Maximum 15 devices altogether, 20m cable length, 2m between each device
- Unique address assigned to each device
- At least 2/3 of the devices turned On
- No loop or parallel connection

GPIB Function Check

Functionality check

Please use the National Instruments Measurement & Automation Controller software to confirm GPIB/LAN functionality.

See the National Instrument website, <http://www.ni.com> for details.



Note

For further details, please see the programming manual, available on the GW Instek web site @ www.gwinstek.com.

Operation

1. Start the NI Measurement and Automation Explorer (MAX) program. Using Windows, press:



Start>All Programs>NI MAX



2. From the Configuration panel access;
My System>Devices and Interfaces>GPIB0

3. Press the *Scan for Instruments* button.
4. In the *Connected Instruments* panel the PSB-1000 should be detected as *Instrument 0* with the address the same as that configured on the PSB-1000.
5. Double click the *Instrument 0* icon.

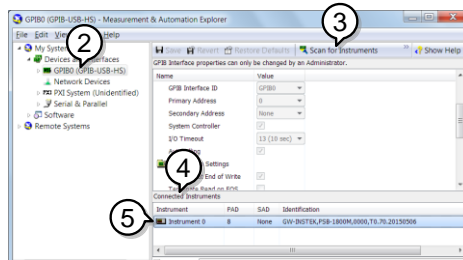

6. Click on *Visa Properties*.
7. Click on *Open Visa Test Panel*.

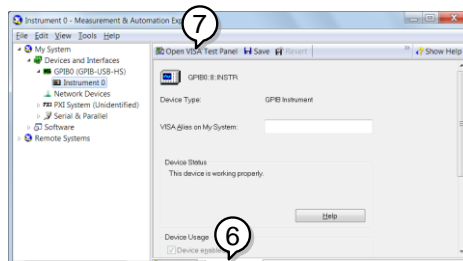

8. Click on the *Input/Output* icon.
9. Under the *Basic I/O* tab, ensure **IDN?* is written in the *Select or Enter Command* text box.
10. Click on the *Query* button to send the **IDN?* query to the instrument.

- The instrument identification string will be returned to the buffer area:

*GW_INSTEK,PSB-1400L,TWXXXXXXXXXX,
X.XX.XXXXXXXXXX*

(manufacturer, model, serial number, software version)

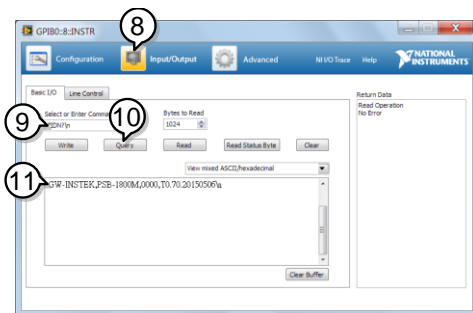

- The function check is complete.



Configure Ethernet Connection

The Ethernet interface can be configured for a number of different applications. Ethernet can be configured for basic remote control or monitoring using a web server or it can be configured as a socket server.

The PSB-1000 supports both DHCP connections so the instrument can be automatically connected to an existing network or alternatively, network settings can be manually configured.

| | | |
|---------------------|----------------------------|--------------------------|
| Ethernet Parameters | MAC Address (display only) | Host Name (display only) |
| | LAN Control | DHCP |
| | IP Address | Subnet Mask |
| | Gateway | DNS Server |
| | Socket Control | Socket port (fixed:2268) |
| | Web Control | Password Control |
| | Web Password | |

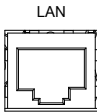
Ethernet Configuration

1. Connect a LAN cable from the PC to the Ethernet port on the rear panel. 
2. Press the *Utility* key. The Utility menu will appear on the display. 
3. Go to the *Interface >>>* setting using the scroll wheel and press *Enter*.
4. Use the scroll wheel to go to the *LAN* setting and press *Enter*.
5. If the LAN cable is installed correctly, a LAN icon will appear in the status bar.

- To automatically have the network assign an IP address, set DHCP to ON. Otherwise set DHCP to OFF to manually set the Ethernet settings.

| | |
|------|---------|
| DHCP | ON, OFF |
|------|---------|

- If DHCP was set to OFF, configure the remaining LAN parameters.

LAN Control

IP Address

Subnet Mask

Gateway

DNS Server

Socket control

Socket port (fixed:2268)

Web control

Password control

Web password

Connection status

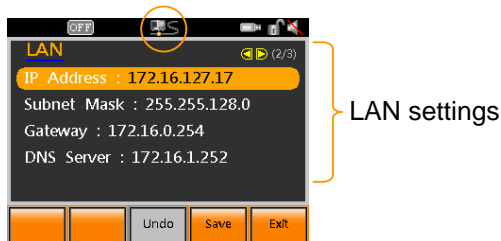

Exit

- Press *Exit*[F5] to exit from the LAN settings.

Web Server Remote Control Function Check

Functionality check

Enter the IP address of the power supply (for example: `http://XXX.XXX.XXX.XXX`) in a web browser after the instrument has been configured for LAN (page 178).

The web interface allows you to:

- View the system and information and the network configuration.
- View the analog control pinout.
- View the dimensions of the unit.
- View the operating area

Example:



[Visit Our Site](#)

[Support](#) | [Contact us](#)

Welcome Page

Thanks For Your Using.

Network Configuration

Use the left menu to select the features you need.

External Control

More How-to
Please refer to user manual.

Dimensions

Operating Area

PSB-1000 Series

Web Control Pages



System Information

| | |
|-------------------|---------------------|
| Manufacturer: | GW-INSTEK |
| Serial Number: | 0000 |
| Description: | GW-INSTEK.PSB-1800M |
| Firmware Version: | 0.90.20150630 |
| Hostname: | P-0000 |
| IP Address: | 172.16.22.177 |
| Subnet Mask: | 255.255.128.0 |
| Gateway: | 172.16.0.254 |
| DNS: | 172.16.1.252 |
| MAC Address: | 02:80:AD:13:05:11 |
| DHCP State: | ON |

Copyright 2015 © Good Will Instrument Co., Ltd All Rights Reserved.

Socket Server Function Check

Background To test the socket server functionality, National Instruments Measurement and Automation Explorer can be used. This program is available on the NI website, www.ni.com, via a search for the VISA Run-time Engine page, or “downloads” at the following URL, <http://www.ni.com/visa/>

Requirements Firmware: V1.12
Operating System: Windows XP, 7, 8, 8.1

Functionality check 1. Start the NI Measurement and Automation Explorer (MAX) program. Using Windows, press:

Start>All Programs>NI MAX



2. From the Configuration panel access;

My System>Devices and Interfaces>Network Devices

3. Press *Add New Network Device>Visa TCP/IP Resource...*

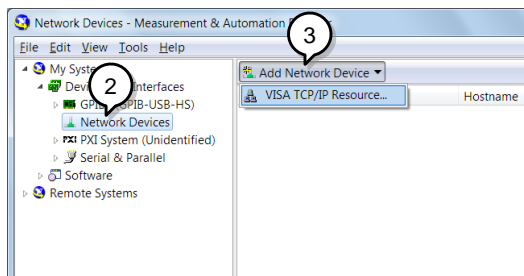

4. Select *Manual Entry of Raw Socket* from the popup window.

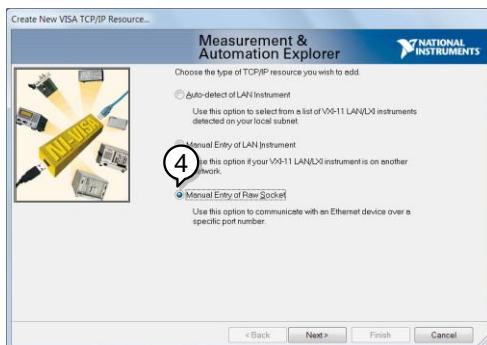

5. Enter the IP address and the port number of the PSB-1000. The port number is fixed at 2268.
6. Double click the Validate button and press *Next*.

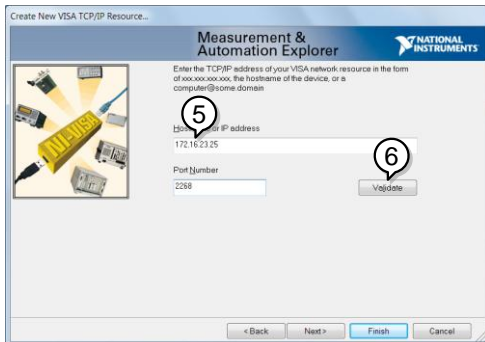

7. Next configure the Alias (name) of the PSB-1000 connection. In this example the Alias is: PSB
8. Click finish.

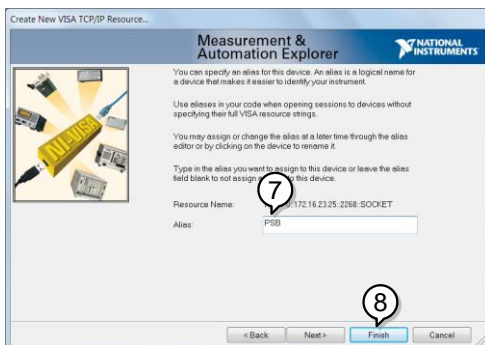

9. The IP address of the power supply will now appear under Network Devices in the configuration panel. Select this icon now.
10. Press *Open VISA Test Panel*.

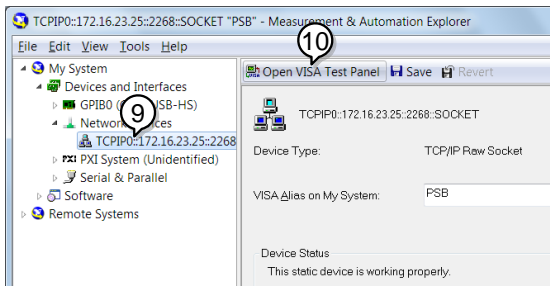

11. Click the *Configuration* Icon. Under the *IO Settings* tab check *Enable Termination Character*. The termination character should be set as *Line Feed - \n*.

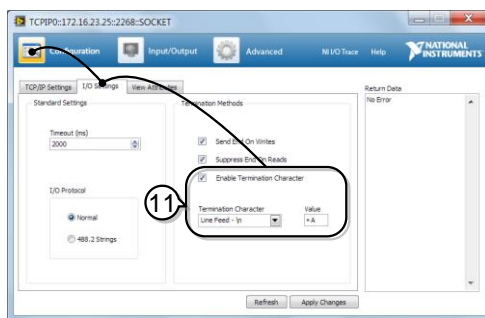

12. Click the *Input/Output* icon. Under the *Basic I/O* tab, make sure **IDN?\n* is entered in the *Select or Enter Command* drop box.
13. Click *Query*.

The PSB-1000 will return the machine identification string into the buffer area:
**GWINSTEK,PSB-1800M,
 XXXX,TX.XX.XXXXXXXXXX**

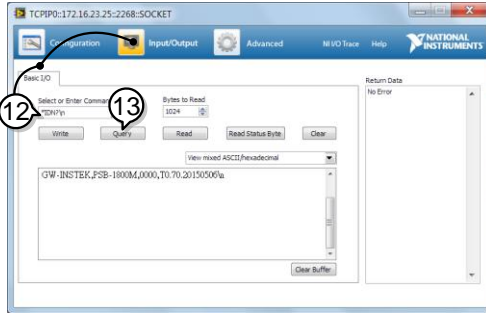

For further details, please see the programming manual, available on the GW Instek web site @ www.gwinstek.com.

Error Log

The Error Log function logs the error messages from the LAN, GPIB and USB remote control and displays them on the screen.

Steps

1. Press the *Utility* key. The Utility menu will appear on the display. 
2. Go to the *Error Log >>>* setting using the scroll wheel and press *Enter*.

3. Use the F1 ~ F3 soft-keys to error log source.

| Log source | LAN, USB, GPIB |
|------------|----------------|
|------------|----------------|

4. To clear the selected log from the screen, press [F4] Clear.

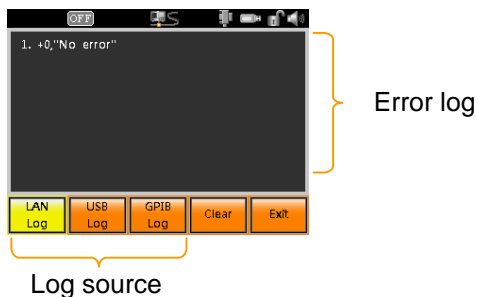

Exit

5. Press *Exit*[F5] to exit from the Error Log screen.

F AQ

- The accuracy does not match the specification.

The accuracy does not match the specification.

Make sure the device is powered On for at least 30 minutes, within +18°C~+28°C. This is necessary to stabilize the unit to match the specification.

For more information, contact your local dealer or GWInstek at www.gwinstek.com / marketing@goodwill.com.tw.

APPENDIX

PSB-1000 Default Settings

The following default settings are the factory configuration settings for the power supply.

For details on how to return to the factory default settings, see page 58.

| Function | |
|-------------|-------------|
| CV Control | Local |
| CC Control | Local |
| Breaker | Enable |
| Ext-Out | High |
| PON Run | None |
| Track | Local |
| Sense | Disable |
| Speaker | Enable |
| Lock Ctrl | OFF |
| Output | OFF |
| Voltage | 0.00V |
| Current | 0.00A |
| OVP | 105% Rating |
| OCP | 105% Rating |
| Bleeder | Enable |
| INT-R | 0.000Ω |
| Average | Low |
| Lock | Mode 0 |
| On Delays | 0.00s |
| Off Delays | 0.00s |
| OCP Control | Enable |
| OCP Delays | Auto |
| I/V Mode | CVHS |

| | |
|---------|-------------|
| VSR ↗ | Maximum |
| VSR ↘ | Maximum |
| ISR ↗ | Maximum |
| ISR ↘ | Maximum |
| Vdef1 | 0.00V |
| Vdef2 | 0.00V |
| Vdef3 | 0.00V |
| Vsetp ↗ | 0.00V |
| Vsetp ↘ | 0.00V |
| OVPdef1 | 105% Rating |
| OVPdef2 | 105% Rating |
| OVPdef3 | 105% Rating |

PSB-1000 Specifications

The specifications apply when the PSB-1000 is powered on for at least 30 minutes.

PSB-1000 400W Models

| Output | PSB-1400L | PSB-1400M |
|---|---|-----------------|
| Rated output voltage (*1) | 40V | 160V |
| Rated output current (*2) | 40A | 10A |
| Rated output power | 400W | 400W |
| Power ratio | 4 | 4 |
| Constant Voltage Mode | PSB-1400L | PSB-1400M |
| Line regulation (*3) | 23mV | 83mV |
| Load regulation (*4) | 25mV | 85mV |
| Ripple and noise (*5) | 60mVp-p (*6) | 60mVp-p (*6) |
| | 7mVr.m.s. (*7) | 12mVr.m.s. (*7) |
| Temperature coefficient | 100ppm/°C of rated output voltage, after a 30 minute warm-up. | |
| Remote sense compensation voltage (single wire) | 0.6V | 0.6V |
| Rise time (*8) | | |
| Rated load | 50ms | 100ms |
| No load | 50ms | 100ms |
| Fall time (*9) | | |
| Rated load | 50ms | 150ms |
| No load | 500ms | 1200ms |
| Transient response time (*10) | 1ms | 1ms |
| Constant Current Mode | PSB-1400L | PSB-1400M |
| Line regulation (*3) | 45mA | 15mA |
| Load regulation (*11) | 45mA | 15mA |
| Ripple and noise (*7) | 80mA | 20mA |
| Temperature coefficient | 200ppm/°C of rated output current, after a 30 minute warm-up. | |

| Protection Function | PSB-1400L | PSB-1400M |
|---|--|--|
| Overvoltage protection (OVP) | | |
| Setting Range | 4 - 44V | 5 - 176V |
| Setting Accuracy ± (2% of rated output voltage) | 0.8V | 3.2V |
| Over current protection (OCP) | | |
| Setting Range | 4 - 44A | 1 - 11A |
| Setting Accuracy ± (2% of rated output current) | 0.8A | 0.2A |
| Over temperature protection (OTP) | Operation: Turns the output off. | |
| Low AC input protection (AC-FAIL) | Operation: Turn the output off. | |
| Power limit | Operation: Over power limit. Value (fixed): Approx. 105% of rated output power | |
| Analog Programming and Monitoring | | |
| | PSB-1400L | PSB-1400M |
| External voltage control output voltage | 400mV ±1% of Vo _{rated} | 1600mV ±1% of Vo _{rated} |
| External voltage control output current | 400mA ±1% of Io _{rated} | 100mA ±1% of Io _{rated} |
| External resistor control output voltage | 600mV ±1.5% of Vo _{rated} | 2400mV ±1.5% of Vo _{rated} |
| External resistor control output current | 600mA ±1.5% of Io _{rated} | 150mA ±1.5% of Io _{rated} |
| Output voltage monitor | 100mV ±1% | 100mV ±1% |
| Output current monitor | 100mA ±1% | 100mA ±1% |
| Shutdown control | Turns the output off with a LOW (0V to 0.5V) or short-circuit. | |
| Output on/off control | Possible logic selections: Turn the output on using a LOW (0V to 0.5V) or short-circuit, turn the output off using a HIGH (4.5V to 5V) or open-circuit. Turn the output on using a HIGH (4.5V to 5V) or open-circuit, turn the output off using a LOW (0V to 0.5V) or short-circuit. | |
| Alarm clear control | Clear alarms with a LOW (0V to 0.5V) or short-circuit. | |
| CV/CC/ALM/PWR ON/OUT ON indicator | Photocoupler open collector output; Maximum voltage 30V, maximum sink current 8mA. | |

| Front Panel | PSB-1400L | PSB-1400M |
|----------------------|--|--------------|
| Display accuracy | | |
| Voltage | 0.1% + 20mV | 0.1% + 100mV |
| Current | 0.1% + 20mA | 0.1% + 10mA |
| Indications and Icon | OFF, CV, CC, Lock, Buzzer | |
| Buttons | Main(Local), FUNC, Utility, File, Voltage, Current, OVP(CLR PROT), OCP, Numeric Keypad, Exit, Arrows Key, Enter, Lock(<u>Unlock</u>), F1, F2, F3, F4, F5, Output | |
| Rotary knob | Turn the knob to the right to increase the value. Turn the knob to the left to decrease the value. | |
| USB port | Type A USB connector | |
| Binding Post | RED: Positive output, Positive sensing. BLACK: Negative output, Negative sensing. GREEN: Earth ground | |

| Programming and Measurement (USB, LAN, GPIB) | | |
|--|-------------|-------------|
| | PSB-1400L | PSB-1400M |
| Output voltage programming accuracy | 0.1% + 10mv | 0.1% + 50mV |
| Output current programming accuracy | 0.1% + 20mA | 0.1% + 10mA |
| Output voltage programming resolution | 1mV | 3mV |
| Output current programming resolution | 1mA | 1mA |
| Output voltage measurement accuracy | 0.1% + 10mV | 0.1% + 50mV |
| Output current measurement accuracy | 0.1% + 20mA | 0.1% + 10mA |
| Output voltage measurement resolution | 1mV | 3mV |
| Output current measurement resolution | 1mA | 1mA |
| Series and Parallel Capability | | |
| Parallel number | 4 units | 4 units |
| Series number | 2 units | 2 units |

| Input Characteristics | PSB-1400L | PSB-1400M |
|-----------------------|--|----------------|
| Nominal input rating | 100Vac to 240Vac, 50Hz to 60Hz, single phase | |
| Input voltage range | 85Vac ~ 265Vac | |
| Input frequency range | 47Hz ~ 63Hz | |
| Maximum input current | | |
| 100Vac | 5.5A | 5.5A |
| 200Vac | 2.75A | 2.75A |
| Inrush current | Less than 25A. | Less than 25A. |
| Maximum input power | 550VA | 550VA |
| Power factor | | |
| 100Vac | | 0.99 |
| 200Vac | | 0.98 |
| Efficiency | | |
| 100Vac | 77% | 80% |
| 200Vac | 79% | 82% |
| Hold-up time | 20ms or greater | |

Interface Capabilities

| | |
|------|--|
| USB | TypeA: Host, TypeB: Slave, Speed: 1.1/2.0, USB Class: CDC(Communications Device Class) |
| LAN | MAC Address, DNS IP Address, User Password, Gateway IP Address, Instrument IP Address, Subnet Mask |
| GPIB | Optional: PSB-105 (GPIB Card) |

Signal Input/Output

| | |
|-----------------|---|
| Trigger Input | Pulse input for resuming the sequence function, BNC connector. Photocoupler input, driver voltage: 5V, DC resistance: approx.250Ω, active with 10mA source, pulse width: 1ms. |
| Trigger Output | Pulse output at the start of sequence step execution, BNC connector. Open collector output, pulled up to +5V with approx. 330Ω, maximum sink current: 8mA, pulse width: 1ms. |
| Voltage Trigger | Pulse output, BNC connector. Open collector output, pulled up to +5V with approx. 330Ω, maximum sink current: 8mA. |

Environmental Conditions

| | |
|-----------------------|---------------------------------|
| Operating temperature | 0°C to 40°C |
| Storage temperature | -25°C to 70°C |
| Operating humidity | 20% to 85% RH; No condensation |
| Storage humidity | 90% RH or less; No condensation |
| Altitude | Maximum 2000m |

| General Specifications | PSB-1400L | PSB-1400M |
|------------------------------------|--|---------------|
| Weight (main unit only) | Approx. 5.2kg | Approx. 6.8kg |
| Dimensions (WxHxD) mm ³ | 214x124x350 | |
| Cooling | Forced air cooling by internal fan. | |
| EMC | Complies with the European EMC directive 2014/30/EU for Class A test and measurement products. | |
| Safety | Complies with the European Low Voltage Directive 2014/35/EU and carries the CE-marking. | |
| Withstand voltage | Between input and chassis: No abnormalities at 1500 Vac for 1 minute. | |
| | Between input and output: No abnormalities at 3000 Vac for 1 minute. | |
| | Between output and chassis: No abnormalities at 500 Vdc for 1 minute. | |
| Insulation Resistance | Between input and chassis: 500 Vdc, 100MΩ or more. | |
| | Between input and output: 500 Vdc, 100MΩ or more. | |
| | Between output and chassis: 500 Vdc, 100MΩ or more. | |

Notes:

- *1: Minimum voltage is guaranteed to maximum 0.1% of the rated output voltage.
- *2: Minimum current is guaranteed to maximum 0.2% of the rated output current.
- *3: At 85 ~ 132Vac or 170 ~ 265Vac, constant load.
- *4: From No-load to Full-load, constant input voltage. Measured at the sensing point in Remote Sense.
- *5: Measure with JEITA RC-9131B (1:1) probe
- *6: Measurement frequency bandwidth is 10Hz to 20MHz.
- *7: Measurement frequency bandwidth is 5Hz to 1MHz.
- *8: From 10% to 90% of rated output voltage, with rated resistive load.
- *9: From 90% to 10% of rated output voltage, with rated resistive load.
- *10: Time for output voltage to recover within 0.1% + 10mV of its rated output for a load change from 50 to 100% of its rated output current.
- *11: For load voltage change, equal to the unit voltage rating, constant input voltage.

PSB-1000 800W Models

| Output | PSB-1800L | PSB-1800M |
|---|---|-----------------|
| Rated output voltage (*1) | 40V | 160V |
| Rated output current (*2) | 80A | 20A |
| Rated output power | 800W | 800W |
| Power ratio | 4 | 4 |
| Constant Voltage Mode | PSB-1800L | PSB-1800M |
| Line regulation (*3) | 23mV | 83mV |
| Load regulation (*4) | 25mV | 85mV |
| Ripple and noise (*5) | 80mVp-p (*6) | 80mVp-p (*6) |
| | 11mVr.m.s. (*7) | 15mVr.m.s. (*7) |
| Temperature coefficient | 100ppm/°C of rated output voltage, after a 30 minute warm-up. | |
| Remote sense compensation voltage (single wire) | 0.6V | 0.6V |
| Rise time (*8) | | |
| Rated load | 50ms | 100ms |
| No load | 50ms | 100ms |
| Fall time (*9) | | |
| Rated load | 50ms | 150ms |
| No load | 500ms | 1200ms |
| Transient response time (*10) | 1ms | 1ms |
| Constant Current Mode | PSB-1800L | PSB-1800M |
| Line regulation (*3) | 85mA | 25mA |
| Load regulation (*11) | 85mA | 25mA |
| Ripple and noise (*7) | 160mA | 40mA |
| Temperature coefficient | 200ppm/°C of rated output current, after a 30 minute warm-up. | |

| Protection Function | PSB-1800L | PSB-1800M |
|--|---|-----------|
| Overvoltage protection (OVP) | | |
| Setting Range | 4 - 44V | 5 - 176V |
| Setting Accuracy ± (2% of rated output voltage) | 0.8V | 3.2V |
| Over current protection (OCP) | | |
| Setting Range | 5 - 88A | 2 - 22A |
| Setting Accuracy ± (2% of rated output current) | 1.6A | 0.4A |
| Over temperature protection (OTP) | Operation: Turns the output off. | |
| Low AC input protection (AC-FAIL) | Operation: Turn the output off. | |
| Power limit | Operation: Over power limit. Value (fixed): Approx. 105% of rated output power | |

| Analog Programming and Monitoring | | |
|--|--|-------------------------------------|
| | PSB-1800L | PSB-1800M |
| External voltage control output voltage | 400mV ±1% of Vo _{rated} | 1600mV ±1% of Vo _{rated} |
| External voltage control output current | 800mA ±1% of Io _{rated} | 200mA ±1% of Io _{rated} |
| External resistor control output voltage | 600mV ±1.5% of Vo _{rated} | 2400mV ±1.5% of Vo _{rated} |
| External resistor control output current | 1200mA ±1.5% of Io _{rated} | 300mA ±1.5% of Io _{rated} |
| Output voltage monitor | 100mV ±1% | 100mV ±1% |
| Output current monitor | 100mA ±1% | 100mA ±1% |
| Shutdown control | Turns the output off with a LOW (0V to 0.5V) or short-circuit. | |
| Output on/off control | Possible logic selections: Turn the output on using a LOW (0V to 0.5V) or short-circuit, turn the output off using a HIGH (4.5V to 5V) or open-circuit. Turn the output on using a HIGH (4.5V to 5V) or open-circuit, turn the output off using a LOW (0V to 0.5V) or short-circuit. | |
| Alarm clear control | Clear alarms with a LOW (0V to 0.5V) or short-circuit. | |
| CV/CC/ALM/PWR ON/OUT ON indicator | Photocoupler open collector output; Maximum voltage 30V, maximum sink current 8mA. | |

| Front Panel | PSB-1800L | PSB-1800M |
|--|---|--------------|
| Display accuracy | | |
| Voltage | 0.1% + 20mV | 0.1% + 100mV |
| Current | 0.1% + 40mA | 0.1% + 20mA |
| Indications and Icon | OFF, CV, CC, Lock, Buzzer | |
| Buttons | Main(Local), FUNC, Utility, File, Voltage, Current, OVP(CLR PROT), OCP, Numeric Keypad, Exit, Arrows Key, Enter, Lock(Unlock), F1, F2, F3, F4, F5, Output | |
| Rotary knob | Turn the knob to the right to increase the value. Turn the knob to the left to decrease the value. | |
| USB port | Type A USB connector | |
| Binding Post | RED: Positive output, Positive sensing. BLACK: Negative output, Negative sensing. GREEN: Earth ground | |
| Programming and Measurement (USB, LAN, GPIB) | | |
| | PSB-1800L | PSB-1800M |
| Output voltage programming accuracy | 0.1% + 10mv | 0.1% + 50mV |
| Output current programming accuracy | 0.1% + 40mA | 0.1% + 20mA |
| Output voltage programming resolution | 1mV | 3mV |
| Output current programming resolution | 2mA | 1mA |
| Output voltage measurement accuracy | 0.1% + 10mV | 0.1% + 50mV |
| Output current measurement accuracy | 0.1% + 40mA | 0.1% + 20mA |
| Output voltage measurement resolution | 1mV | 3mV |
| Output current measurement resolution | 2mA | 1mA |
| Series and Parallel Capability | | |
| | PSB-1800L | PSB-1800M |
| Parallel number | 4 units | 4 units |
| Series number | 2 units | 2 units |

| Input Characteristics | PSB-1800L | PSB-1800M |
|-----------------------|--|----------------|
| Nominal input rating | 100Vac to 240Vac, 50Hz to 60Hz, single phase | |
| Input voltage range | 85Vac ~ 265Vac | |
| Input frequency range | 47Hz ~ 63Hz | |
| Maximum input current | | |
| 100Vac | 11A | 11A |
| 200Vac | 5.5A | 5.5A |
| Inrush current | Less than 50A. | Less than 50A. |
| Maximum input power | 1100VA | 1100VA |
| Power factor | | |
| 100Vac | | 0.99 |
| 200Vac | | 0.98 |
| Efficiency | | |
| 100Vac | 77% | 80% |
| 200Vac | 79% | 82% |
| Hold-up time | 20ms or greater | |

Interface Capabilities

| | |
|------|--|
| USB | TypeA: Host, TypeB: Slave, Speed: 1.1/2.0, USB Class: CDC(Communications Device Class) |
| LAN | MAC Address, DNS IP Address, User Password, Gateway IP Address, Instrument IP Address, Subnet Mask |
| GPIB | Optional: PSB-105 (GPIB Card) |

Signal Input/Output

| | |
|-----------------|--|
| Trigger Input | Pulse input for resuming the sequence function, BNC connector. Photocoupler input, driver voltage: 5V, DC resistance: approx.250Ω, active with 10mA source, pulse width: 50us. |
| Trigger Output | Pulse output at the start of sequence step execution, BNC connector. Open collector output, pulled up to +5V with approx. 330Ω, maximum sink current: 8mA, pulse width: 50us. |
| Voltage Trigger | Pulse output, BNC connector. Open collector output, pulled up to +5V with approx. 330Ω, maximum sink current: 8mA, pulse width: 50us. |

Environmental Conditions

| | |
|-----------------------|---------------------------------|
| Operating temperature | 0°C to 40°C |
| Storage temperature | -25°C to 70°C |
| Operating humidity | 20% to 85% RH; No condensation |
| Storage humidity | 90% RH or less; No condensation |
| Altitude | Maximum 2000m |

| General Specifications | PSB-1800L | PSB-1800M |
|------------------------------------|--|---------------|
| Weight (main unit only) | Approx. 5.2kg | Approx. 6.8kg |
| Dimensions (WxHxD) mm ³ | 214×124×350 | |
| Cooling | Forced air cooling by internal fan. | |
| EMC | Complies with the European EMC directive 2014/30/EU for Class A test and measurement products. | |
| Safety | Complies with the European Low Voltage Directive 2014/35/EU and carries the CE-marking. | |
| Withstand voltage | Between input and chassis: No abnormalities at 1500 Vac for 1 minute. | |
| | Between input and output: No abnormalities at 3000 Vac for 1 minute. | |
| | Between output and chassis: No abnormalities at 500 Vdc for 1 minute. | |
| Insulation Resistance | Between input and chassis: 500 Vdc, 100MΩ or more. | |
| | Between input and output: 500 Vdc, 100MΩ or more. | |
| | Between output and chassis: 500 Vdc, 100MΩ or more. | |

Notes:

- *1: Minimum voltage is guaranteed to maximum 0.1% of the rated output voltage.
- *2: Minimum current is guaranteed to maximum 0.2% of the rated output current.
- *3: At 85 ~ 132Vac or 170 ~ 265Vac, constant load.
- *4: From No-load to Full-load, constant input voltage. Measured at the sensing point in Remote Sense.
- *5: Measure with JEITA RC-9131B (1:1) probe
- *6: Measurement frequency bandwidth is 10Hz to 20MHz.
- *7: Measurement frequency bandwidth is 5Hz to 1MHz.
- *8: From 10% to 90% of rated output voltage, with rated resistive load.
- *9: From 90% to 10% of rated output voltage, with rated resistive load.
- *10: Time for output voltage to recover within 0.1% + 10mV of its rated output for a load change from 50 to 100% of its rated output current.
- *11: For load voltage change, equal to the unit voltage rating, constant input voltage.

PSB-1000 Dimensions

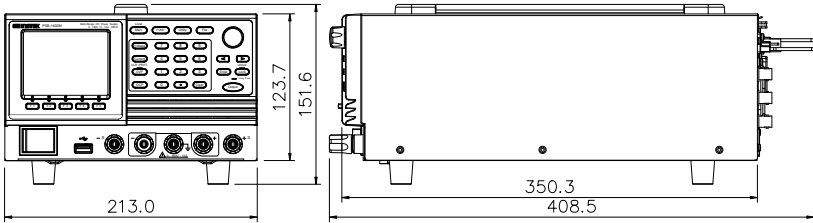
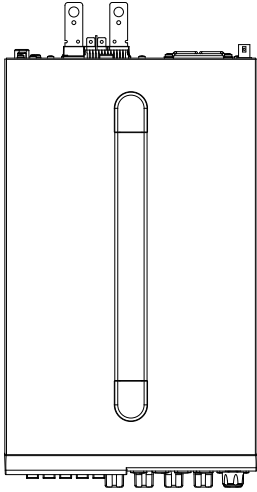

Scale = mm

Declaration of Conformity

We

GOOD WILL INSTRUMENT CO., LTD.

declare that the below mentioned product

Type of Product: Multi-Range DC Power Supply

Model Number: PSB-1400L, PSB-1400M, PSB-1800L, PSB-1800M

are herewith confirmed to comply with the requirements set out in the Council Directive on the Approximation of the Law of Member States relating to Electromagnetic Compatibility (2014/30/EU), Low Voltage Directive (2014/35/EU), WEEE (2012/19/EU) and RoHS (2011/65/EU). For the evaluation regarding the Electromagnetic Compatibility and Low Voltage Directive, the following standards were applied:

| © EMC | |
|---|--|
| EN 61326-1: | Electrical equipment for measurement, control and |
| EN 61326-2-1: | laboratory use -- EMC requirements (2013) |
| Conducted & Radiated Emission EN 55011: 2009+A1:2010 Class A | Electrical Fast Transients EN 61000-4-4: 2012 |
| Current Harmonics EN 61000-3-2: 2014 | Surge Immunity EN 61000-4-5: 2006 |
| Voltage Fluctuations EN 61000-3-3: 2013 | Conducted Susceptibility EN 61000-4-6: 2014 |
| Electrostatic Discharge EN 61000-4-2: 2009 | Power Frequency Magnetic Field EN 61000-4-8: 2010 |
| Radiated Immunity EN 61000-4-3: 2006+A1:2008+A2:2010 | Voltage Dip/ Interruption EN 61000-4-11: 2004 |
| Low Voltage Equipment Directive 2014/35/EU | |
| Safety Requirements | EN 61010-1: 2010 / EN 61010-2-030: 2010 |

GOODWILL INSTRUMENT CO., LTD.

No. 7-1, Jhongsing Road, Tucheng District, New Taipei City 236, Taiwan

Tel: [+886-2-2268-0389](tel:+886-2-2268-0389)

Fax: [+886-2-2268-0639](tel:+886-2-2268-0639)

Web: <http://www.gwinstek.com>

Email: marketing@goodwill.com.tw

GOODWILL INSTRUMENT (SUZHOU) CO., LTD.

No. 521, Zhujiang Road, Snd, Suzhou Jiansu 215011, China

Tel: [+86-512-6661-7177](tel:+86-512-6661-7177)

Fax: [+86-512-6661-7277](tel:+86-512-6661-7277)

Web: <http://www.instek.com.cn>

Email: marketing@instek.com.cn

GOODWILL INSTRUMENT EURO B.V.

De Run 5427A, 5504DG Veldhoven, The Netherlands

Tel: [+31-\(0\)40-2557790](tel:+31-(0)40-2557790)

Fax: [+31-\(0\)40-2541194](tel:+31-(0)40-2541194)

Email: sales@gw-instek.eu

INDEX

| | | | |
|----------------------------------|-----|---------------------------------|-----|
| Accessories | 13 | reset..... | 58 |
| Alarm | | Front panel diagram..... | 15 |
| description | 34 | Ground | |
| Alarm clear..... | 72 | symbol..... | 5 |
| Analog control | | Grounding | 39 |
| alarm clear | 159 | I/V Control..... | 81 |
| analog programming connector | | Internal resistance..... | 83 |
| pin assignment..... | 144 | description..... | 33 |
| output control | 155 | LCD configuration..... | 61 |
| overview | 143 | List of features..... | 12 |
| remote monitoring | 161 | Load connection..... | 45 |
| resistance control - current | | Marketing | |
| output..... | 152 | contact | 187 |
| resistance control - voltage | | Measurement average setting .. | 85 |
| output..... | 150 | Memory settings | |
| shutdown control | 157 | copy | 120 |
| status monitoring | 163 | copy to internal memory..... | 122 |
| voltage control - current output | 149 | delete USB file..... | 123 |
| voltage control - voltage output | 147 | recall | 119 |
| Bleeder control | | rename USB file | 125 |
| description | 32 | save | 119 |
| Bleeder resistance | 84 | view | 118 |
| Caution symbol..... | 5 | Model differences | 11 |
| CC and CV mode | | OCP | 71 |
| description | 30 | delay | 78 |
| Cleaning the instrument..... | 7 | enable | 77 |
| clear alarm..... | 72 | Operating area description..... | 29 |
| Conventions | 53 | Operation considerations | 36 |
| Current output level | 67 | floating output | 39 |
| Current slew rate..... | 81 | inrush current | 36 |
| Declaration of conformity | 201 | pulsed loads | 36 |
| Default settings..... | 188 | reverse current..... | 37 |
| Disposal instructions..... | 7 | Option installation..... | 50 |
| EN61010 | | Output current protection level | 71 |
| measurement category | 6 | Output delay | 79 |
| pollution degree..... | 7 | Output on | 76 |
| Environment | | Output voltage protection level | 69 |
| safety instruction..... | 7 | OVP | 69 |
| Ethernet | | Parallel mode | |
| interface..... | 178 | connection..... | 102 |
| Factory settings..... | 188 | | |

| | | | |
|---------------------------------|-----|---------------------------------|-----|
| operation..... | 106 | Serial number | 59 |
| overview | 99 | Series mode | |
| Parallel operation..... | 98 | connection..... | 112 |
| Power On | | Operation..... | 115 |
| Breaker | 95 | overview | 109 |
| CC Control..... | 89 | Series operation..... | 98 |
| CV Control..... | 87 | Service operation | |
| Ext-Out..... | 94 | about disassembly..... | 6 |
| PON Run..... | 91 | contact | 187 |
| Sense | 96 | Slew rate | |
| Tracking Control | 93 | description..... | 32 |
| Power on/off | | Socket server function check .. | 181 |
| safety instruction | 6 | Sound..... | 60 |
| Power up..... | 43 | Speaker | 60 |
| Rack mount | | sound..... | 60 |
| description..... | 52 | Specifications | 190 |
| Remote control | 166 | System version | |
| Ethernet..... | 178 | view | 59 |
| GPIB..... | 173 | Terminal cover | 49 |
| LAN | 178 | TRIG IN BNC | |
| USB | 167 | pin assignment..... | 138 |
| Remote control function check | | TRIG OUT BNC | |
| GPIB..... | 175 | pin assignment..... | 139 |
| Realterm..... | 170 | Trigger | |
| RS-232..... | 169 | trigger in | 138 |
| USB | 169 | trigger out..... | 139 |
| Remote sense | | voltage trigger..... | 141 |
| operation..... | 48 | UK power cord..... | 8 |
| Sequence | 127 | USB driver installation | 62 |
| clear..... | 132 | VOLT TRIG BNC | |
| copy | 132 | pin assignment..... | 141 |
| delete | 132 | Voltage output level | 65 |
| load | 128 | Voltage slew rate..... | 81 |
| load from internal memory | 135 | Warning symbol..... | 5 |
| load from USB..... | 130 | Web server function check..... | 180 |
| move | 132 | Wire gauge chart..... | 44 |
| overview | 128 | | |
| run from internal memory | 135 | | |
| run from USB | 130 | | |