

GDM-452 Operating Manual



Modern Digital Multimeters

I . Introduction

The GDM-452 is a 20000-count handheld digital multimeter with remarkably stable and reliable operation. It is mainly supported with a dual integral A/D converter based on CMOS technology and also offers overload protection for all ranges. This model can measure DC&AC voltage, DC&AC current, resistance, capacitance, diode, frequency and continuity.

II . Safety Information









The GDM-452 is designed and manufactured in compliance with: IEC61010-1, CAT II 600V overvoltage standards.

⚠ Warnings

Use the meter as specified in the manual, otherwise the protection offered by the multimeter may be impaired.

- Do not use the multimeter with back cover opened, it may cause electric shock.
- Set to a proper range for your measurement.
- Check the test leads for any damaged insulation or broken wires.
- Insert red and black test leads into proper input terminals and ensure good contact between them.
- Do not input signal beyond the rated values of the multimeter, otherwise it may cause electric shock or damage to the multimeter.
- Prohibit switching the range during the voltage or current measurement, for it may cause damage to the multimeter.
- Please use replacement parts with the same model or similar electrical specifications.
- To avoid electric shock, Do not apply any voltage above 600V between COM and grounding.
- Please take caution when working voltage goes above 60VDC or 30VAC RMS.
- To ensure the accuracy, please replace the batteries as soon as  appears.
- Shut off the power timely after the measurements complete. Take out the batteries if not used for a long time.
- Do not use the multimeter in places exposed to high temperature, high moisture. The performance of the multimeter may be compromised if moisture-affected.
- To prevent damage to the multimeter or personal injury, do not alter internal wiring randomly.
- Clean the multimeter casing with slightly dampened soft cloth and mild agent. Do not use any abrasives and corrosives.

International Electrical Symbols

	Low Battery Indication		Grounding
	Warning		DC
	AC		Double Insulated
	Buzzer		Diode
	Conforms to European Union Standards		

III . Product Features

- 30 ranges for function selection;
- Over-range display: "1";
- Display count: 19999;
- Fast-acting fuse protection for current ranges: 200mA and 10A;
- Full-range overload protection;
- Auto power off;
- Temperature range:
Operating: 0°C ~ 40°C (32°F ~ 104°F);
Storage: -10°C ~ 50°C (14°F ~ 122°F);
- Altitude: ≤ 2,000m;
- Low Battery Indication: "" displays;
- Dimensions: 186×91×39mm;
- Weight: About 300g (not including test leads).

IV . Technical Specifications

Accuracy: ± (a % of reading + b digits); Warranty period is 1 year;
Ambient temperature: 23°C ± 5°C
Relative humidity: <75%

DC Voltage

Range	Resolution	Accuracy
200mV	10 μV	±(0.05%rdg+3digits)
2V	100 μV	±(0.1%rdg+3digits)
20V	1mV	
200V	10mV	
600V	100mV	±(0.15%rdg+5digits)

⚠ Input impedance: 10MΩ for all ranges;

Overload protection: 600V DC or AC RMS value for 200mV range and 600Vrms or 850V p-p peak value for other ranges;

AC Voltage

Range	Resolution	Accuracy
200mV	10 μV	±(0.8%rdg+10digits)
2V	100 μV	±(0.5%rdg+10digits)
20V	1mV	±(0.6%rdg+10digits)
200V	10mV	
600V	100mV	±(0.8%rdg+15digits)

⚠ Input impedance: 10MΩ for all ranges;

AC voltage frequency range: 40Hz-400Hz;

Overload protection: 600V DC or AC RMS value for 200mV range and 600Vrms or 850V p-p peak value for other ranges;

Display: Effective average value

DC Current

Range	Resolution	Accuracy
2mA	0.1 μA	±(0.5%rdg+5digits)
20mA	1 μA	
200mA	10 μA	±(0.8%rdg+5digits)
10A	1mA	±(2%rdg+10digits)

⚠ Overload protection:

μA, mA input: 200 mA / 600V Φ 5 x 20 mm

A input end: 10A/600V Φ 6 x 25 mm

Maximum input current: 10A (For current over 5A, measuring time shall not exceed 15 seconds)

Measured voltage drop: 200mV for full range

AC Current

Range	Resolution	Accuracy
2mA	0.1 μA	±(0.8%rdg+10digits)
20mA	1 μA	
200mA	10 μA	±(1.2%rdg+10digits)
10A	1mA	±(2.5%rdg+10digits)

⚠ Overload protection:

μA, mA input: 200 mA / 600V Φ 5 x 20 mm

A input end: 10A/600V Φ 6 x 25 mm

Maximum input current: 10A (For current over 5A, measuring time shall not exceed 15 seconds)

Measured voltage drop: 200mV for full range

AC current frequency range: 40-400Hz;

Display: True RMS value; (Waveform coefficient is not more than 5.)

Resistance

Range	Resolution	Accuracy
200Ω	0.01Ω	±(0.5%rdg+10digits)
2kΩ	0.1Ω	±(0.3%rdg+3digits)
20kΩ	1Ω	±(0.3%rdg+1digits)
200kΩ	10Ω	
2MΩ	100Ω	
20MΩ	1kΩ	±(0.5%rdg+1digits)

⚠ Overload protection:

600V DC or AC RMS for all ranges;

Open circuit voltage: About 3V (for 200Ω range);

Note: please short-circuit the test leads when using 200Ω range to measure, and subtract this shorted value from all subsequent measured values so as to obtain accurate reading.

Capacitance

Range	Resolution	Accuracy
20nF	1pF	±(4.0%rdg+20digits)
200nF	10pF	
2 μF	100pF	
20 μF	1nF	

Testing signal is about 400Hz 40mVrms.

⚠ Overload protection:

μA, mA to V terminal input: 200 mA / 600V Φ 5 x 20 mm



Frequency

Range	Resolution	Accuracy
20kHz	1Hz	±(1.5%rdg+5digits)

Input sensitivity: ≤200mVrms; The maximum input amplitude ≤30Vrms;

Overload protection: 600Vrms;



Diode and Continuity

Range	Instructions	Testing conditions
	Display approximate value of forward voltage drop for diode	Positive DC current is about 1mA and reverse DC voltage is about 2.8V.
	If resistance ≤ 30Ω, the buzzer sounds; Display approximate kΩ value.	Open circuit voltage is about 3.0V.

⚠ Overload protection: 600V DC or AC effective value;

V. Making Measurements

Notice before operation:

- (1) Power on the Multimeter and inspect 9V battery. Replace the battery if "  " displays. If not, proceed into next step.
- (2) Pay attention to rated voltage or current value next to "  " near input terminals, any input that go beyond the rating may damage the Multimeter.
- (3) Function switch shall be placed in required range before test;
- (4) Instrument introduction
 - ① LCD display
 - ② POWER button
 - ③ HOLD button
 - ④ Function switch
 - ⑤ Input jack

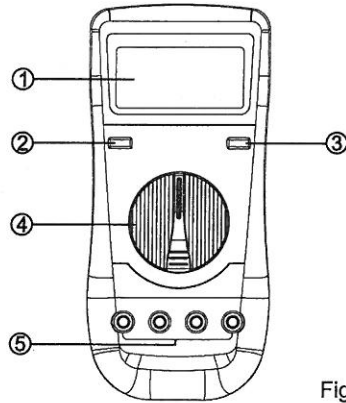



Figure 1

Measuring DC Voltage

1. Insert test leads into input jacks (Red to V and black to COM).
2. Set the function switch to V  range; Connect test leads to the wire under test in parallel, and the positive polarity of the test end will indicate.

Notice

1. Set to the maximum range and reduce it gradually if the measured voltage is unknown.
2. If "1" displays on LCD, it indicates over-range, please select a higher range for your measurement.
3. "  " indicates not to input voltage higher than 600V, which may cause damage to the Multimeter or personal injury although the reading may be obtained.
4. Extreme care should be taken to avoid electric shock when measuring high voltage.

Measuring AC Voltage

1. Insert black test lead into COM jack and insert red one into V jack;
2. Place function switch at V  range scope and then connect test leads to measurement wires in parallel.

Notice

1. Please refer to "Notice" for DC voltage.
2. "  " refers to input voltage being not more than 600V. The higher voltage is possible, but it may cause damage to internal wires and electric shock.

Measuring DC Current

1. Insert black test lead into COM jack and insert red one into mA jack if measured current is not more than 200mA. Insert the red test lead into 10A jack if measured current is between 200mA and 10A.
2. Place function switch at A  range and then connect testing leads to measurement loop in series. It will display current and polarity of red test lead at the same time.

Notice

1. Set to the maximum range and reduce it gradually if the measured current is unknown.
2. If "1" displays on LCD, it indicates over-range, please select a higher range for your measurement.
3. "  " indicates the maximum input current. mA input is protected by 200mA/600V fuse; 10A/600V fuse is used to protect 10A range.

Measuring AC Current

1. Insert black test lead into COM jack and insert red one into mA jack if measured current is not more than 200mA. insert red test lead into 10A jack if measured current is between 200mA and 10A.
2. Place function switch at A  range and connect testing leads to measurement loop in series.

Notice

1. Please refer to "Notice" for DC current measurement.

Measuring Resistance

1. Insert black test lead into COM jack and insert red one into Ω jack.
2. Place function switch at Ω range and connect testing leads to measurement loop in series.

Notice

1. Over-range of "1" will be displayed if measured resistance exceeds the maximum value of selected range. It is necessary to select higher range and reading cannot be stable until several seconds for resistance of more than 1M Ω . It is normal for high-resistance reading.
2. Instrument displays "1" if there is no input for open circuit, etc.
3. Be sure to power off measured wires and discharge capacitance load when inspecting wire impedance.

Measuring Capacitance

1. Connect the tested capacitor directly to the capacitance jacks.
2. The floating reading exists every time you switch to another capacitance range and reset to zero before connecting to a tested capacitor, which however will have no impact on the accuracy.

Notice

1. Discharge the tested capacitor before measurement, although the capacitance ranges are protected internally, it may also cause damage to the multimeter.
2. Reading stabilizing period is required when measuring large capacitance;
3. Unit: 1pF=10⁻⁶ μ F, 1nF=10⁻³ μ F.

Measuring Frequency

1. Insert red test leads into HZ jack and insert black one into COM jack;
2. Place function switch at kHz range and connect test leads to frequency signal in series. Frequency value can be read from display directly.

Note:

The accuracy cannot be ensured if input signal voltage is higher than 30Vrms, and please take extreme care.

Testing Diodes and Continuity

1. Insert black test lead into COM jack and insert red one into V Ω jack (with "+" polarity for red probe). place function switch at "  " gear and connect test leads to measured diode. Reading is approximate positive drop for diode.
2. Connect test leads to 2 ends of measurement wires; Embedded buzzer rings if resistance between 2 ends is less than 30 Ω .

Data Hold

1. Press HOLD button to realize such function;
2. Whether the test leads are disconnected or not will not influence Data Hold function.

Auto Power Off

1. The Multimeter is designed with automatic power-off circuit to power off after instrument operates for about 15 minutes and enter into sleeping status;
2. Press POWER button twice to wake up the Multimeter from the sleep mode.

VI. Maintenance

 This kind of Multimeter belongs to precise electronic instruments. Please do not alter wires randomly and pay attention to following items:

1. Do not access to voltage which is higher than 600V DC or 600Vrms AC.
2. Do not access to voltage signals when function switch is in position of "current ranges", " Ω " and "  " .
3. Please do not use this meter before installing battery or tightening rear cover;
4. Battery or fuse cannot be replaced until removing test leads and power off.

VII. Replacing the Battery

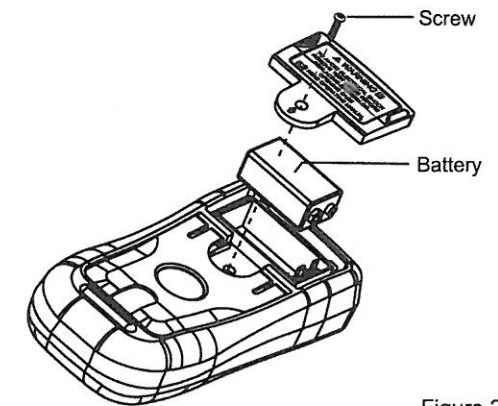

Figure 2

VIII. Accessories

1. User's Manual ----- 1 pc
2. Test Leads ----- 1 pair

This manual contains proprietary information, which is protected by copyright. All rights are reserved. No part of this manual may be photocopied, reproduced or translated to another language without prior written consent of Good Will company. The information in this manual was correct at the time of printing. However, Good Will continues to improve products and reserves the rights to change specification, equipment, and maintenance procedures at any time without notice.